

The **NASA** Journal

VOLUME XLII NUMBER 7

JULY 2002

Radio Exterior de España



América

English

UTC	KHz.
00:00-01:59	15385
05:00-05:59	6055

Français

UTC	KHz.
23:00-23:59	15385

Sefardi

UTC	KHz.	
01:15-01:45	11795	Martes
04:15-04:45	9650	Martes

Oriente (Próximo y Medio)

Árabe عربي

UTC	KHz.	
17:00-18:59	21610	
19:00-20:59	17560	الاثنين - الجمعة
20:00-21:59	17560	السبت - الأحد

Français

UTC	KHz.	
19:00-19:59	7150	Lundi-Vendredi
19:00-19:59	17560	Samedi-Dimanche

Sefardi

UTC	KHz.	
18:25-18:55	17770	Lunes

Quality Equipment From Universal Radio

GRUNDIG

eTRAVELLER VII

Surf the radio waves with the Grundig eTraveller VII. Both the perfect travel radio and everyday companion, this palm-sized radio is information headquarters. Measuring only 2.5 x 4.5 x 1 inches, its sleek, smooth design fits into your pocket briefcase or purse and at only 5.3 ounces, it will never weigh you down. At home or traveling you can enjoy not only local AM and FM stations, but international shortwave broadcasts as well. With superior dual conversion superheterodyne circuitry, you will be able to hear stations from around the world. Shortwave coverage is 2-10.4 and 11-30 MHz. And you won't have to guess at the frequency. The informative liquid crystal display (LCD) shows you everything. Manual tuning is precise and fast or automatic scanning may be selected. Plus you can store up to 30 of your favorite stations in memories (10 AM, 10 FM, 10 SW) for instant recall. The included earphones provide full, rich stereo sound when listening to FM-stereo. The built-in Ferrite bar antenna provides good AM band reception from 530 to 1710 kHz (with 9 or 10 kHz steps). The built-in 24-hour clock-timer will wake you to your favorite station, just like a full-sized clock radio. There is even a sleep timer function settable for 60, 50, 40, 30, 20 or 10 minutes. The eTraveller VII comes with: two AA cells, carry pouch and Grundig Shortwave Listening Guide, 2.7x4.5x1 inches 5.3 oz. One year limited mfg. warranty. Makes a cool gift!

eTraveller VII Order #0077 \$99.95



GRUNDIG

FR-200



Be prepared and aware with the Grundig FR200 emergency radio. This affordable analog portable receives AM, FM and shortwave in two bands: 3.2-7.8 and 9.2-22 MHz. The FR200 operates from a wind-up generator, 4.5VDC or 3 AA cells. The generator charges the supplied, replaceable NiCad cells. Two turns per second for 90 seconds will provide 40 to 60 minutes of operation. A concentric Fine Tune knob provides smooth, precise tuning. With carry handle and camo canvas carry case. There is also a built-in bright emergency light. Has nice audio. 6.75x5.75x2.75 inches. #2200 \$39.95

POP COMM Sale!

"POPULAR COMMUNICATIONS" YEAR SETS

Get all 12 back-issues at a special price.

1992 Year Set	Order #3259	\$42.95	\$9.98
1993 Year Set	Order #3260	\$42.95	\$9.98
1994 Year Set	Order #2896	\$42.95	\$9.98
1995 Year Set	Order #3161	\$42.95	\$9.98
1996 Year Set	Order #4138	\$42.95	\$9.98
1997 Year Set	Order #3306	\$42.95	\$9.98
1998 Year Set	Order #2560	\$42.95	\$9.98
1999 Year Set	Order #4136	\$42.95	\$9.98
2000 Year Set	Order #3055	\$42.95	\$9.98
2001 Year Set	Order #4362	\$42.95	\$9.98

www.RFfun.com

www.universal-radio.com

- Informative On-line Catalog
- Used Equipment Listing

- Specials and Close Outs
- Cats and other cool stuff.

Kchibo

KK-E200

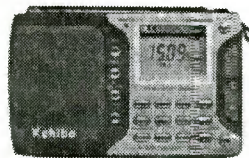

The Kchibo KK-E200 digital radio tunes AM from 520 to 1620 kHz (in 9 or 10 kHz steps), FM reception is from 87.5-108 MHz (stereo to ear-phone jack). Shortwave reception is from 2.3-7.3 and 9.5-26.5 MHz. Thirteen individual shortwave bands are selectable via the Meter Band function. The backlit LCD lets you view the frequency when tuning at night. You can tune this radio four ways: Up/Down manual tuning (5 kHz steps on SW), automatic search tuning, direct keypad frequency entry and 24 memories. You can store 6 AM stations, 6 FM stations and 6 stations each on SW1 and SW2 bands. There is also a 24 hour digital clock with 10-90 minute sleep function and auto-tun off. The left side of the radio features a Local-DX sensitivity switch. The right side has a dial lock button. The radio works well with its telescopic antenna, but there is an external antenna jack. Requires three AA cells (not supplied) or 5 VDC 250 mA (center -). Only 6x3.5x1.25 inches 12 oz. (150x90x35mm 280 lg.) The Kchibo KK-E200 includes: AC wall adapter, wrist strap, vinyl carry case, stereo ear buds and wire type antenna. Ninety Day limited warranty.

KK-E200 Order #0202 \$64.95

KENWOOD

SP-31

The Kenwood SP-31 is a high quality speaker with audio filtration that may be used with virtually any communications receiver or transceiver. The SP-31 features a 4 inch (10 cm) speaker in a metal enclosure. The switch in the upper right corner can select from two audio input sources. The three switches on the lower right activate two high (HIGH 1, HIGH 2) and one low (LOW) cut audio filters. This allows you to tailor the frequency response of the speaker system. This speaker also has a standard 1/4 inch headphone jack on the front panel and a Line Output Jack on the back panel (to feed a recorder, RTTY unit, etc.). These convenient output jacks are post filtration. The input posts are spring terminals. An audio cable to 3.5mm plug is provided. The front may be elevated by adjusting the front feet. 7.2x4.7x12.3" (180x120x310mm).

SP-31 Order #0694 \$99.95

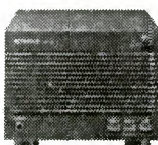

PAR

ELECTRONICS

BCST-HPF BCST-LPF

The Par BCST-HPF is designed to help shortwave listeners cope with interference from AM stations. This 7 pole elliptic high pass filter passes 1.8 to 200 MHz and notches out 0-1.7 MHz. The housing has an SO-239 jack for input and output and also has a toggle type bypass switch.

BCST-HPF Order #4426 \$48.95



The Par BCST-LPF is designed to help long wave DXers cope with interference from nearby AM stations above 540 kHz. Stop band is 540 kHz to 300 MHz. The housing has an SO-239 jack for input and output and has a bypass switch.

BCST-LPF Order #1143 \$48.95

TEN-TEC

RX-340



The Ten-Tec RX-340 is the ultimate receiver under \$4000. Visit our online catalog for complete information.

universal radio inc.

Quality Communications Equipment Since 1942

Universal Radio, Inc.
6830 Americana Pkwy.
Reynoldsburg, OH 43068
800 431-3939 **Orders & Prices**
614 866-4267 **Information**
614 866-2339 **FAX**
cx@universal-radio.com
www.universal-radio.com

Prices and specs are subject to change. Prices shown are after mfg's. coupons. Returns are subject to a 15% restock fee.



The 2002 Universal Radio Catalog covers everything for the shortwave, amateur and scanner enthusiasts. With informative photos and informative descriptions. **Free!**

1 800 431-3939

www.universal-radio.com

U.S.A. orders under \$100 ship for \$4.95. Under \$500 ship for \$9.95. Except Alaska, Hawaii and Puerto Rico.

NASWA Notes

Richard A. D'Angelo • 2216 Burkey Drive • Wyomissing, PA 19610 • rdangelo3@aol.com

Thanks to our ever-alert member **Dale Park** in Hawaii, we have information about three great radio related convention opportunities for the summer months. Full details are contained in the Calendar of Events but let me summarize them here. First, the **Worldwide TV-FM DX Association Convention** will be held at the Hampton Inn on Garth Brooks Blvd., Yukon, OK, just outside Oklahoma City on 26-28 July 2002. Second, the **International Radio Club of America (medium wave) Convention** will be held on 16-18 August 2002 at the Towne and Country Suites, 14800 Interurban Avenue South, Tukwila, WA, just outside Seattle. Finally, the **National Radio Club (medium wave) annual Convention** will be held at the Hampton Inn, 1933 Roschman Avenue, Lima, Ohio over Labor Day Weekend, 30 August through 2 September 2002. These are great opportunities to meet and greet other radio hobbyists and have some fun.

Also, from **Harold Sellers** comes word that the Ontario DX Association will hold RadioFest 2002 on September 20, 21, 22, 2002 at the Monte Carlo Inn—Oakville, 374 South Service Road E., Oakville, Ontario, L6J 2X6, CANADA. Friday begins with a wine and cheese reception in the evening. Saturday features a silent auction, displays, club items on sale, guest speakers, panel discussions and the draw for Raffle 2002. Sunday will conclude with a tour (TBA). These ODXA events are always special, so it is time to think about being in Canada for the equinox. Check out the Calendar of Events for further information.

Don't forget to order the latest edition of the **Danish Shortwave Club International's ("DSWCI") Domestic Broadcasting Survey 4 (DBS-4)**, edited by DSWCI Chairman **Anker Petersen**, in PDF-format, or—upon request—in Microsoft Works database. *DBS-4* covers all

active stations broadcasting to a domestic audience or relaying such broadcasts to compatriot's abroad in the shortwave spectrum of 2200-30000 kHz. Active Clandestine stations are also included with schedules and identifications. The treasurer, DSWCI, c/o Bent Nielsen, Egekrogen 14, DK 3500 Vaerloese, Denmark, sells it for US \$5.00, £5, £3, DKK 40 or 7 IRC per issue. A review of *DBS-4* will appear in the *Shortwave Center*.

I am beginning to get some of the growth problems with the NASWA electronic *Flashsheet* straightened out as members change e-mail addresses and neglect to forward correct information to me. The number of bounced e-mails has been significantly reduced. If you signed up for the *Flashsheet* but have not seen it lately you need to contact me immediately to straighten out the distribution list. If you still have not jumped on board the *Flashsheet* bandwagon, you can get the latest hot DX news and information from the club's electronic flash sheet newsletter edited by **Sheryl Paszkiewicz**, spasz@dataplusnet.com (note new e-mail address) or P.O. Box 716 Manitowoc, WI 54221-0152 for non-electronic submissions. The electronic newsletter supplements the monthly *Journal* for the timely dissemination of DX loggings and breaking news. It is only available to members. Deadlines are posted in the *NASWA Flashsheet*. If you are a current member of the club and want to receive the electronic *NASWA Flashsheet* just drop **Rich D'Angelo** (rdangelo3@aol.com) a note with your e-mail address.

Don't let the heat of the summer stop you from reporting your shortwave listening to our editors. Naturally, they love to hear from the membership on a year round basis but the summer months can be a little slow without your continued support. Please support each of our columns on a regular basis.

OUR MOTTO IS - "UNITY AND FRIENDSHIP"

It wouldn't hurt to see a few new faces in the pages of the *Journal* from time-to-time, hi! Remember, the information contained in the *Journal* is only as useful and relevant as the contributions our editors receive from you, our active members. Thanks for all the fine support over the years and we hope to see continued growth in the number of members participating through the submission of contributions to the editors. It's your *Journal*.

Just a quick reminder that all communications about subscriptions, bulletin delivery issues, etc. should be directed to **Bill Oliver** at the club's Levittown address or to his new electronic address exclusively for club related business, naswa@worldnet.att.net. The regular postal address is the familiar 45 Wildflower Road, Levittown, PA 19057.

That's it for this month. Enjoy this month's edition of the *Journal*; it's another good one. **SW**

Musings

This column provides a forum where members can express comments, ideas, and thoughts about NASWA or the SW radio hobby. Please feel free to comment on anything presented this month (or previous months). Opinions expressed here are solely those of the submitters. Please submit all Musings to Richard A. D'Angelo, 2216 Burkey Dr., Wyomissing, PA 19610 or via email: rdangelo3@aol.com.

Sheryl Paszkiewicz spasz@dataplusnet.com, P.O. Box 716 Manitowoc, WI 54221-0152

It's time to write that musing I've been promising Rich. Once again, thank you all for the support you've given the tropical bands column over the years. Without you, it would not exist. Please continue to support Dan Ferguson. We certainly couldn't have anyone more qualified as some of you know his employer is the Voice of America.

Unfortunately new logs have been pretty much non-existent here. I did hear Wales Radio, which doesn't count as Wales because of a relay. Also heard Radio Free Asia via Tinian, but I don't think they will put the site on the card.

The R-8500 is still a fantastic receiver. I have to say this is the first receiver I've used with which I feel comfortable tuning in single sideband. It really can dig up a signal on 60 meters that was not detectable in AM. I am checking for Radio Enga a lot. Also would love to hear RRI Tanjungkarang or Palangkaraya but no luck. However, new stations continue to pop up, and one must focus on those when they are available. I just don't have the spark I had in the 80s to chase QSLs though.

If any of you remember, from past DX articles, etc, there is an area of what is now Russia called Tuva. Well they are known for "throat singing," some of which you may have heard on Voice of Russia at times. There was a movie on the Sundance Channel called *Genghis Blues*, in which a group of "Tuva fans" got together and traveled there and lived among the people for awhile. The main character from the US was Paul Pena, and he is shown tuning into then Radio Moscow on a shortwave receiver. He is also co-composer of *Jet Airliner* by Steve Miller! It was pretty interesting.

Oh, one more thing. I have been forwarding logs to Dan Ferguson in case you have sent some to me since the changeover. Once again, if you have email capability, please feel free to email Rich with your email address so you can receive the electronic *Flash Sheet*. Logs go to me but notices to sign up go to Rich, i.e. I edit, he distributes. Thanks!

Sheryl

Scott R Barbour Jr. srbjrswl@yahoo.com

Greetings from NH. I am writing in response to John Beattie's letter in the May *NASWA Journal*. I have noticed not just a lack of logs submitted from a particular part of the US; but a lack of contributions from NASWA members in general. I have been a member for a short time; Oct 2001; and have seen the same 15 to 20 names in the "Contributor's Page", during that time; while also seeing 15 to 20 new members per month during that same span. Surely someone is listening to their radio. Under the "FRENEX: 25 years ago..." heading I see that upwards of 80 to 100 members would submit logs to the journal per month! By no means is this letter intended to berate or belittle anyone; but to encourage members who are thinking of contributing to the *Journal* to do so.

I enjoy SWL and DXing and like to share with other members what I am hearing here in NH; and also what other members are hearing from their QTH. I have used the "Loggings" section on more than one occasion to identify a frequency I was unsure of. I also wish to encourage John and other members thinking of QSLing to do so. With the invaluable help of Mr. Barto I have already amassed a nice collection of QSL cards and letters from around the world. Believe me, once you receive your first QSL card you will be hooked! Also think about the fact that all the hard work has been done for us in the form of guides such as *WRTH*; *PPWBR*; *WOR* and the *NASWA Journal*; to name a few. All we have to do is tune in! This is truly a great hobby.

Sincerely, Scott

Lou Rossetti <BobbiLou16@aol.com>

What a great find last month.

I meant to send you a note a few weeks ago regarding the *English Schedules* prepared by Mark J. Fine. What a great job of compiling the large list. The inclusion in the journal was very welcome. I use another magazine or two for time, frequency and stations broadcasting from different parts of the world. This listing is so very accurate compared with the "others" I thought I would let you know. I have checked out the Eastern and Western European stations listed as well as Australia. Each time, frequency and transmitting area is "right on."

Thanks for including it the *Journal*.

Lou

FRENEX: Twenty Five Years Ago (July 1977)

The Japanese Association of DXers was offering a seventeen page *Russian Reporting Guide* written in English with Russian phrases and key words for 3 IRCs surface and 4 IRCs airmail. The NASWA decal was offered for \$1.25 each. Last call was put out for members interested in purchasing the third edition of *DXing According to NASWA* for just \$3.00 postpaid. In Jerry Lineback's *Shortwave Center*, Al Sizer wrote about QSL Rejection and the problems hobbyists had dealing with Omar M. Omar of Radio Zanzibar and Roger Petersen wrote about how he achieved the World Wide DXer award. In a *Special Feature*, John Tuchscherer wrote about Which Shortwave Stations Verify Reports. Bill Oliver's *QSL Report* carried a card from Charles Hoffman issued by Glenn Hauser celebrating his 10th anniversary of preparing the *North American DX Report* over Radio Nederland's *DX Jukebox* program. Awards Chairman Dan Henderson announced five new awards: Tropical Band DXer, Senior Tropical Band DXer, Senior Ecclesiastic DXer, Senior Papua New Guinea DXer and Master Papua New Guinea DXer.

Calendar Of Events

- Jul 19 Meeting. Philadelphia Area NASWA Chapter.** Kulpsville Holiday Inn, Kulpsville, PA at 7:30 PM. For more information contact Dan Cashin at 610-446-7831 or Internet: dcsckp@aol.com.
- Jul 19 Meeting. Boston Area NASWA Chapter.** No meetings of the Boston Area DXers have been scheduled while they are looking for a new meeting site. In the meantime, inquiries about the BADXers may be sent to Paul Graveline at 978-470-1971 or Internet: ctreditor@aol.com. The URL for the BADX guys is <http://www.anarc.org/naswa/badx/>
- Jul 26-28 Convention. The Radio Amateurs of Canada** are having a national convention in Vernon, British Columbia, Canada on 26, 27, and 28 July 2002 with Arnie Coro (of Radio Habana) as the keynote speaker. The website is www.rac2002.org. Further information is available from Bill Crowther at bill_crowther@telus.net or by postal mail RAC2002 National Convention, c/o O.C.A.R.C., P.O. Box 282 Station A, Kelowna, BC Canada V1Y7N5. Single non-RAC member is \$35 whereas a single RAC member is \$30. Additional family members are \$10 for each family member attending. Registered convention attendees entitles admission to all seminars, the RAC Forum, General Meeting and entrance to the Flea Market.
- Jul 26-28 Convention. The Worldwide TV-FM DX Association Convention** will be held at the Hampton Inn on Garth Brooks Blvd., Yukon, OK, just outside Oklahoma City on 26-28 July 2002. Registration is \$15. Room rates are \$55 per night plus tax. For more information contact John Zondlo at 4009 Driftwood Circle, Yukon OK 73099, or phone (405) 354-1530 or e-mail jpzondlo@aol.com. Download the registration form at <http://members.cox.net/fmdxweb/wtfda2002.html>.
- Jul/Aug'02 Contest. The Vacation BCL Contest** will run from 1 July 2002 through 31 August 2002. Participants are to log as many African countries as possible on the shortwave bands. The sponsor, Klingenfuss, will offer a *2002 Shortwave Frequency Guide* and a CD Rom for the winners. Full information is available from <http://swlcontest.homestead.com/>.
- Aug 9 Meeting. The Cincinnati/Dayton Monitoring Exchange (MONIX)** meet at the Lebanon Citizens National Bank on U.S. Route 42 in Mason at 7:00 PM. For more information contact Mark Meece at 513-743-8089 or e-mail at [<radiuscan@siscom.net>](mailto:radiuscan@siscom.net). For additional information about MONIX, check out their web site at [<http://www.siscom.net/~mmeece/monix.html>](http://www.siscom.net/~mmeece/monix.html)
- Aug 16-18 Convention. The International Radio Club of America** (medium wave) Convention will be held on 16-18 August 2002 at the Towne and Country Suites, 14800 Interurban Avenue South, Tukwila, WA, just outside Seattle. Registration is \$30. Room rates are \$69 (single) and \$83 (double or triple) per night plus tax. For more information contact Phil Bytheway at 9705 Mary Avenue NW, Seattle WA 98117-2334 or e-mail phil_tekno@yahoo.com.
- Aug 16-18 Convention. The European DX Council Conference** will be held from 16-18 August 2002 in the town of Pori, located on the west coast of Finland. Additional information about the conference will be made available through e-mail and newsgroups or can be obtained directly from Risto Vahakainu, chairman [<risto.vahakainu@helsinki.fi>](mailto:risto.vahakainu@helsinki.fi).
- Aug 24 Convention. The BeNeLux Shortwave DX Meeting** will take place in the Belgium/Netherlands border area which lays between Breda (NL) and Turnhout (B) on Saturday, 24 August 2002. There will be a barbecue, drinks, fun and laughter. The organizers plan for lots of shortwave listeners and pirate station operators to be in attendance. You can get more info by e-mail: [<summermeeting@hotmail.com>](mailto:summermeeting@hotmail.com),

telephone: 00 31 (0) 6-10531057, or by postal mail: Borderhunter Ostra Porten 29 44254 Ytterby, Sweden. Check <http://www.alfalima.net/baarle.htm> for updated information.

Aug 30–Sep 2 Convention. The **National Radio Club (medium wave) annual Convention** will be held at the Hampton Inn, 1933 Roschman Avenue, Lima, Ohio over Labor Day Weekend, 30 August through 2 September 2002. Registration is \$40 plus \$20 for a spouse or friend. Room rates are \$69 per night plus tax. For more information contact Fred Vobbe at 706 Mackenzie Drive, Lima OH 45805-1835, or phone (419) 228-6223 or e-mail fredv@nrcdxas.org. Download the registration form at <http://www.nrcdxas.org/convention/02nrcon>.

Sep 20–22 Convention. The Ontario DX Association will hold **RadioFest 2002** on September 20, 21, 22, 2002 at the Monte Carlo Inn—Oakville, 374 South Service Road E., Oakville, Ontario, L6J 2X6, CANADA (Tel: (905) 849-9500, Fax: (905) 849-6405, e-mail: reservation@montecarloinns.com, website: www.montecarloinns.com/oak.htm). Friday begins with a wine and cheese reception in the evening. Saturday features a silent auction, displays, club items on sale, guest speakers, panel discussions and the draw for Raffle 2002. Sunday will conclude with a tour (TBA). Registration is \$10.00 Cdn or \$7.00 US, which includes the Friday Wine & Cheese reception and the Sunday Tour. For more information, contact Harold Sellers at 905-853-3518 / Fax 905-853-3169 / email: listeningin@rogers.com or Brian Smith at am740@rogers.com or by mail at: Ontario DX Association, Box 161, Willowdale Stn. A, Toronto, Ontario, Canada M2N 5S8. Check the ODXA web site (www.odxa.on.ca) for updates.

Mar 7–8, 2003 Convention. The **16th Annual Winter SWL Festival**, sponsored by NASWA, will be held at the *Best Western—The Inn at Towamencin* (Kulpsville to the rest of us), located at Exit 31 on the Northeast Extension of the Pennsylvania Turnpike, on 7th and 8th March 2003. Richard Cuff and John Figliozzi co-chair the organizational committee. It's never too early to begin planning. See you there!

Apr–May, 2003 Radio Holiday Tour. **David and Jocelyne Ricquish** lead a **radio holiday tour of the great cities of Latin America** in April/May 2003. Plans include visits to many radio stations and meetings with local radio enthusiasts. The tour is designed for DXers, shortwave listeners and radio enthusiasts and all those that enjoy the music and culture of Latin America. The full itinerary and booking conditions can be found at the New Zealand Radio DX League website (<http://radiodx.com/spdxr/dxtour/htm>) or can be obtained from Latin American Radio Tour, P. O. Box 14339, Wellington, New Zealand (e-mail: ragusa@paradise.net.nz).

Members are invited to submit items to be included in this calendar to Rich D'Angelo (Internet: rdangelo3@aol.com) or Ralph Brandi (Internet: ralph@brandi.org).

Contribute!

Send your loggings and QSL information off to our Distributing Editor, **Bob Montgomery** (Address: P O Box 1458, Levittown, PA 19058). He will forward them to the appropriate editor. Remember, Bob also distributes QSL report information and totals for the **Scoreboard** column. He can also be reached through the Internet at: RMonty3@worldnet.att.net.

NASWA

Visit our club home page on the World Wide Web at <http://www.anarc.org/naswa/>

Easy Listening

Richard D. Cuff • 42 North 37th Street • Allentown, PA 18104 • rdcuff@mochamail.com

Is Finnish in English Finished?

As of this writing, YLE's English Language Service, **Radio Finland**, will soon be leaving the shortwave ranks. The decision was recently made to cut English, French, and German shortwave broadcasts, leaving Finnish and Swedish languages as a service to expatriate Finns. If I read this right, YLE is funded by license fee payers for both its domestic and international services, and as a result, YLE's international broadcasts should primarily benefit license fee payers—Finnish travelers and those of Finnish extraction living abroad. YLE's English, French and German services will run through the end of October, according to **Radio Netherlands' Media Network** newsdesk. What hasn't been said yet is if any of YLE's English Language services airing on local FM and medium wave frequencies will continue.

In some ways I am not surprised by this, as YLE representatives participating at the Winter SWL Fest have stated that Radio Finland is a service targeting Finns and those of Finnish extraction—a more narrow focus than the cultural outreach mission stated by broadcasters such as the BBC World Service and the VOA. Still, if English language programming disappears altogether, it will be a loss. I have long enjoyed the perspectives offered by Radio Finland; I remember a series of history broadcasts looking back at the events of World War II as Finns saw them to be particularly interesting.

Happy Anniversary, BBC!

One year ago the **BBC World Service** told us they were switching off their North American shortwave frequencies, yet most people have successfully managed to figure out

how to receive them on frequencies targeting other nearby regions—particularly the Caribbean and Central America.

In the months since last July, the BBC has become more helpful in stating that shortwave reception is still possible in North America with a list of suggested frequencies, reflecting a much less heavy-handed approach to the reprioritization than they were at this time last year.

Does anyone bandscan anymore?

The creation of focused e-mail discussion groups like the swprograms group, and the development of daily or weekly e-mailed program highlights, has helped inform shortwave listeners of interesting upcoming program topics. When you consider this trend, along with the widespread usage of direct-entry digitally tuned radios, I'd bet people don't spend as much time browsing the shortwave bands as they used to. I would wager most people use frequency memories, or simply remember the frequencies of their favorite broadcasters and tune directly on those broadcasts.

This is one reason I try to include some variety in the *Easy Listening* column, in order for you to consider sampling broadcasts you might otherwise miss.

Unfortunately that will have to wait for another month; unexpected commitments require the July column to be sharply abbreviated in comparison to normal.

I'll be back in August with a lot more detail...promise!

73 DE Richard



Shortwave Center

Jerry Lineback • 506 South Lawrence Avenue • Scranton, KS 66537 • jalinebk@satelephone.com

Where Is Your Shortwave Activism? (or July 12, one year later)

By Maryanne Kehoe

I won't ever forget where I was the afternoon of July 12th, 2001 at 12:22 PM. I was sitting in a huge auditorium that was packed to the gills with over 500 (it was estimated) of the world's most stellar journalists and reporters part of a week-long circus called the 112th IOC Session in Moscow, Russia. And it was a love of shortwave radio that brought me there, solely through 1 year of hard work, sweat and more tears than I care to remember.

Do you remember that scene in "Up Close and Personal" where Robert Redford sees Michelle Pfeiffer with her head in the toilet, puking up a storm before her first broadcast and realizing she has hit the big time? That was me the previous Friday afternoon, after I had picked up my credentials, with my head stuck in a toilet, not due to sickness but to sheer nerves, wondering if I bit off more than I could chew while at the same time wondering what the heck I was doing there.

Then I recalled the words of my pageant interview coach, Don, who said "you belong there and you can do it." I had never before challenged myself on such an international level, and god knows there were people back home who did their damndest to try to make me fail. I took a deep breath and remembered that I was above all that, that I worked hard for the past year to get to this point and my support team back home was cheering for me.

And I probably wouldn't have been there if it wasn't for that fateful day in September, 2000 when I was *really* sick. I went to get the paper, and as usual, looked at the

Sports section first. (Yes, I know, that is a bad habit, one should look at the front page first, but, hey, it is a habit I have had since I was a kid.) I saw something that made me "really" angry—as a SWL and as a human being.

And I "stayed" angry for the next year.

The small one paragraph item was there: "Beijing to Bid for 2008 Olympic Games." I still don't know to this day why I reacted the way I did. I certainly didn't know anyone over there on a personal level. I had never traveled in that area. The closest I ever got to China was having a South Korean roommate in the late 1970s.

But for the next month or so, it still kept gnawing at me. I could hear the words tossed around in my mind "this is wrong." I started talking about it to non-radio friends for the next month, until one of them, totally fed up, said: "OK, what are you going to do about it?"

Huh? Run that by me again.

She brought up my pageant community service, volunteerism (especially at the 1996 Olympics) and my sense of fairness, in addition to my commitment to a hobby that has been so good to me over the past 28 years.

"You love this hobby and you have many broadcasters as friends. What would happen if you got a call in the middle of the night saying one of your friends lost his life, all for doing his job in 2008?" Now those were them fightin' words (as we say here in the south) but she had given me something to think about.

What if...what if...what if...should I... shouldn't I...certainly no one in the pageant world ever had a platform like this before. At the time I had a competition coming up and I needed a platform I could believe in, and that would inspire others and make others think.

First I had to make a phone call.

A lot of you knew Gigi Lytle. She was one of the closest SWL friends I had. She was someone I could talk to about anything and everything (and boy, did I tell her *everything!*). She also was very-pro Mainland, but that wasn't something that got in the way of our friendship.

I decided to call her up and tell her of the idea I had (fully expecting to get cussed out.) Surprise...we talked and at the end of the conversation, we wished each other luck (she was pushing for the Beijing bid) and whoever emerged victorious would get a congratulatory phone call. Unfortunately, I never got to make the call, because she passed away 6 weeks later.

It was a lot of tough work and it got tougher in December when my assistant quit, citing that he "couldn't take the possible media attention" that might happen. I told him that "never was going to happen" but he wished me luck as "you are a lot tougher than I am and I just can't do it."

Great. This sure is starting out fantastic. No one to help me. What a nice present to get 2 weeks before Christmas. What *else* can go wrong?!?!?

I was soon to find out....

Weird things start to happen when *others* know you are on to something. Don told me that I had to "have a tough skin"—fortunately, for me that isn't a problem. I think there is a saying that goes something like "Life Is Tough-You Have To Be Tougher" or something like that.

People start to treat you differently. You start to get the anonymous emails, of which I can't repeat verbatim some of the stuff

that was said. One email said "HOW DARE YOU???"—and that was one of the more tamer ones. But throughout the spring (with a short break to go to Winterfest—god knows I needed it), things were going fine, and I was so busy, I honestly didn't have time to think about some of the negativity being thrown my way.

April flew by. So did May. Here it is June, 4 weeks to go! Got the tickets, FAX letter from IOC comes in to get the visas. Anna, my friend in NYC who works at the agency that handles my Russian travel says visas approved and are on the way. Apartment looks like a war zone. Now it is close to 100 hours a week, reading, research, research, research. Letter comes from my pageant director Lori vouching for my title and competition status (I needed that to pick up my accreditation badge once I get to Moscow.) 4-3-2-1 week to go!!

I had to take a day off (or was it 2?) the last week, everything is done, except a few minor things, and looking at the empty suitcase thrown in the corner. I had planned the last week to be pretty much relaxing and packing suitcases, leaving instructions with my neighbor if there was an emergency, plus talking to relatives, who wished me luck and trying to catch up on lost sleep.

An email had come in several days before from someone I knew. It broke my heart. It was also a threat that said that person "had friends that can prevent you from getting on that plane Tuesday night for Russia." What made it really bad was it was from a fellow Dixer.

What the ****?!?!?!?

At that point, all hell broke loose. I asked a respected friend for his opinion and the first thing he did was to sit me down and explain the facts. Pure jealousy, he thought. "Put yourself in that person's place" he said. "They are going to love you over there in Moscow and this is a natural reaction to someone who has the green-eyed monster sitting around!" I still wasn't so sure, but my friend's words were a bit of a reassurance.

Another friend of mine (who had previous experience with the IOC in these things) emailed me and said "you're going to do great—don't worry about the detractors, just go over there and get the job done and give the pageant a great article!"

I didn't sleep too well the night before. In between the phone ringing (which I ended up having to take off the hook and let the answering service pick up), I think I finally fell asleep around 3 AM (with the alarm set to go off at 7 AM in the morning.)

Riiiiinnnggggriinnnggggg!!! 7 AM. Time to rock and roll!!!

It's amazing with my lead foot that I haven't had a speeding ticket, but I had to watch it when I caught myself doing almost 50 on the way to the hotel to park my car. Whew...suitcases out, gave my regular bellhop a tip (the only person that works there that I trust w/my stuff), and haul butt from the parking garage. No rest for the wicked—more reading (I have my IOC Evaluation Commission Report plus Don's pageant interview manual to read for the flight over.)

Oh lord, a bunch of high school kids are on this flight to Paris. Last time I encountered a bunch of teens was when they stopped up one of the toilets on the way to Germany and caused general mayhem. But-surprise!-they were well behaved. Miracles.

I settled in my seat and started to panic. Dear god, please let this door shut, and the plane taxi out. OK, take a deep breath—you're going to be OK. Voila! Door shuts, and after a short taxi, here we go!! I love the takeoff of a 747—such a glide, so smooth, and you don't feel much turbulence.

Sometimes I think overseas flights are an endurance contest. You versus them. 9 hours later, we land in Paris and after a short wait, I board another flight to Moscow.

3½ more hours and I am finally there. I don't do jet lag too well and it takes me about 3 days to recover and catch up on lost sleep,

not easy when dear friends start ringing the phone off the hook (at all hours!)—but we are all a closely-knit group, so I don't mind at all.

The calm before the storm!

The mayhem doesn't start for another 3 days so Friday, I go to pick up my accreditation badge over at the Moscow World Trade Center. Not too much is going on, meet an IOC official who saw me rubbing my already sore feet and strikes up a conversation. Gosh, I sure do feel welcome here and I try not to feel too intimidated. I tell him it was a tough go to make it over there, and I think they like stories like that. I said I "didn't have a cast of thousands or a zillion-dollar budget like some people coming here" and I think it is the little guy that tries to succeed against all odds that is the crux of what the Olympics and Olympic-related activity is all about.

I try to get my bearings in the Mezh Hotel. Everything is *so* over the top, from the giant gold Olympic rings suspended from the ceiling in the lobby, to the flags and banners. Gosh, they sure don't go halfway on these things. At that point, I am on sensory overload, as I haven't even seen anything like it, even in the IBC during 1996. I am starving and decide to take a time out and have lunch in the cafe—not too many Olympic people are around yet, but you are immediately aware of the security presence already. Guards (armed!) patrolling the hallways, checking out *everything* and looking at everything (and everyone!)

I'd never thought that being in the shortwave community and being an achievement queen would take me *here!*

What a week...never in my wildest dreams did I think I would ever experience something like *this*. One of the things you first learn is to watch where you are walking, as there are thick cables laid down everywhere and even though the techs do their best to use the thick electrical tape to tape them down, after several days (and people tripping over them) things come loose.

Not too much happened the first 2 days, mostly people just getting to know each other and we didn't see much of the delegations (in fact, someone came up to me and said if I had seen anything—we were all on the same chase for the same people, but they were hiding on us.) It was really a casual atmosphere, trying to find out who was who and where they were going to be, before they gave us the slip (which they were pretty good at!)

It was Wednesday that all of us started to realise that things were getting serious. There was a ring of police officers (some armed with machine guns!) along the whole perimeter of the hotel and Trade Center. There was officially a 250-foot "security zone" in all directions from the hotel and mid-week, streets along 3 sides of the hotel were blocked off, except for the main drag along the Moskova River. It kind of creeped me out for a bit as I don't recall this heavy a security presence in Atlanta (or I was so busy, I just didn't notice.)

• I made friends for life. On Tuesday, I was able to talk to 2 of the Canadian delegation, including John Bitove, the head of the Canadian bid team. He was so cool, full of confidence and radiated warmth to everyone he came in contact with, plus a great sense of humor! When I asked him initially about the Toronto mayor's comments ("I don't want to be at an IOC meeting in Africa in a pot of boiling water with a bunch of natives dancing around me"), he said to me that they have moved on and that they were ready for the rest of the week and the upcoming decision. Some of the Danish reporters were really fun to hang with, and one guy from the Denver Post was my "eyes and ears" in the other media work room across town. Daniel Ikoyune (Canadian track and field athlete) was so much fun to talk to, every day he would wear these colorful African clothes and just radiated warmth and energy to everyone he came in contact with. But it was several of the Toronto folks that were so kind to give me some of their time for me to discuss issues with them (and one day it was in a chair, since I wailed that my feet hurt so bad from

all the walking.) I told them my story and I feel like I had been adopted. Talk about closer than close. An acknowledgement at breakfast, a friendly smile while we were off running in different directions, a "hi, how ya doin' this morning?", or just a nodding approval when I walked into a room somewhere and they were there. They were so kind to give me of their time.

I can't say enough kind things about Francine. On some days when I didn't think I was going to make it, it was she with the kind words that kept me going. Even with all the stuff she had to do as part of the Canadian delegation, she still found time to give encouragement, advice, and telling me that I could do it. She was a firecracker, always "on" and always out there.

Wednesday was a 15 hour day and I was about near collapse—Thursday was looming ahead and I needed to rest as it was going to be a very busy day as press conferences were scheduled most of the day and at that point, it was a competition between the reporters as to who could get the info first and scoop each other out.

It's showtime!

A bit of a late start, I missed Osaka's press conference and about 10 minutes of Paris'. You really had to feel for the French...they knew that they were underdogs, they were trying so hard. you couldn't help but empathise for them.

Ah Toronto...John, Marnie, Francine and their crew giving an upbeat presentation, and John mentioning about how "our security forces will respect the rights of the individual" while glancing in my direction and catching Marnie and Francine's grins in my direction and me giving them the thumbs up! I noticed John was a bit nervous at the beginning and as I am a big believer in the powers of persuasion, I silently told myself "John, calm down, you're doing fine, we're a friendly crowd, just keep doing what you're doing and everything will be ok." And at the end it was, with them getting a rousing round of applause.

We had a bit of a break, around 15 minutes before the next folks.

Yes, them.

7 of the most evil people I ever saw in my life. And unbeknownst to me, they were about to pull a funny one with 3 of their Xinhua photographers, but I caught their bluff. Thinking they could embarrass me in front of a packed house of the world's most prominent journalists. Funny how I *never* gave the Mainland delegation the time of day, but yet, somehow they felt threatened by *me* and tried a desperate last-minute attempt to embarrass me (which didn't work.)

I could already feel the tension soar 1000 percent. I looked around trying to get my bearings. The guy from Deutsche Welle TV sat 2 seats from me. I don't remember who sat on the aisle seat. I was on the third row, to the left bank of seats, right in Wang Wei's eyesight.

They came in, slapping each other on the back thinking that they were going to sail thru this press conference and that we were a friendly bunch to them.

Things got started about 15 minutes late and at about 11:30, we were off to the races!

Most of the Asian media asked quite general questions and 30 minutes into things, not really much of anything earth-shattering. Questions about budget, transportation, pollution, airport access (huh?) then a question from a reporter in a small-town Seattle newspaper got the party started. I don't recall what she asked but I do remember the tone of the folks on the stage started to get a bit nervous.

Then the guy from DW TV asked his question if there "were plans to suspend the death penalty during the Olympic time period." They glared at him (lovely) and said that "law and order would be respected and besides, I do believe that other countries, such as the United States, won't suspend their executions."

Then it was my turn. *OK, Maryanne, this is it. One chance to nail it. Remember what Don told you. This is the whole crux of your platform. You can't ask for a rewind. This is IT!!!!*

I could feel the electricity in the air as I arose to ask my question. As I had it written down (and practiced the night before, as I don't think I could recite it from memory), the pool photographers ran up to my seat and started snapping. Including 3 very aggressive Asian photogs, which I later found out had a special mission in mind. The guy from Reuters Television was *climbing over seats* to try to film me.

"I have read the IOC Evaluation Commission Report and in the section on Beijing, it states that there will be no restrictions on media reporting and movement of journalists up to and including the Olympic Games. In that light, can you tell me: does this mean if Beijing is awarded the Games, that I, or any journalist here would be allowed to report on any story, for example, if we wanted to do stories on the Falun Gong, the pro-democracy activists, or the Reeducation Through Labor camps, that we would be able to do so, without fear of intimidation, harassment, or arrest?"

I handed back the microphone to the hostess and had my pen in hand ready to make notes, giving each one of them a steely eyed glaze. I could hear the quiet murmur in the background after I sat down and there was about a 10 second pause from the Beijing folks. Wang Wei looked like he wanted to get out of there and whispered something to the lady sitting next to him, She shook her head in a "no" position and then he asked something of the man sitting next to him.

Clearly I had nailed it in more ways than one.

Whew, done. I am sure Wang Wei never wants to see me again. Why yes, of *course*, there would be no problem, we have guaranteed that in our bid documents, no problem, all are welcome.

I am going to hold you to that. And later, as I found out, the VP of the Asia Desk of Human Rights Watch also said the same thing from his office in the Far East. I also informally heard from a friend of a friend that someone reporter's live link in Beijing went down as I was asking my question but mysteriously came back up after I finished.

There were a few more questions and at 12:45 it was all over. They couldn't get out of there fast enough, and they just hustled to get off the stage (thinking I was going to nail them on something else.)

Poor Istanbul, they had their conference after Beijing and they didn't even get a proper introduction and about 3/4 of the reporters left. Out of respect, I stayed for their whole presentation, I just felt for them, I think they knew they didn't stand a chance.

Back to the media work room to do some more typing and research, and when I walked in, there was a quiet murmur of recognition and respect. I smiled and nodded and got back to work. Due to the 9 hour time difference between Moscow and the USA, I didn't see too much on the news sites except for a few articles here and there. Nothing earth shattering. At 7PM, I left for the evening and went back to where I was staying.

I went outside to look for my regular driver and didn't see him in the taxi area. So I took another one of the "authorized" taxis that were allowed inside the security perimeter area of the hotel.

The ride back would give me a chance to review notes, and jot down things for the following day as the bid announcement would be made at about 5:30 PM. My driver spoke English and was very polite. He kept looking at his rear view mirror but I didn't pay it too much heed as that is what I do when I am back home, driving Atlanta's "mean streets."

I noticed the expression on his face changed suddenly. He asked me to "secure everything in the back seat as we are going to go very very fast." I quickly put everything away,

wrapped the handle of my purse around my ankle, and then....

WHOMP!!

It was a car chase that would have made 007 proud...cars scrambling to get out of the way and we were approaching a speed of almost 100 MPH.

*What the h***?*

I was hanging on to the seat for dear life... well, if we wipe out, at least I have ID so the US Embassy knows where to contact my relatives and next of kin. I screamed, "what the heck is going on?" "Don't worry, I am an ex-race car driver, and I know what I am doing!!" Gosh I hope so, because we both will be dead if you lose control.

After we got on one of the side streets, he explained to me that he saw someone trailing us right after we left the MezH Hotel and they had been following us for sometime and he decided for both our safety to make a run for it. He then asked me if I had an exciting day "in there"—in more ways than one, ha.

I never found out who was trailing us. I am sure it was related somehow to the press conference and someone was trying to intimidate me and "send a message."

Well, I am tougher than that. Got home, plopped down on the couch and instantly wondered what the hell I just did. I have a feeling this isn't going to be a good day.

Slip and almost fall on the floor when I get out of bed. Hot water goes in the shower. Almost slipped in the bathtub. And it was Friday the 13th (of July)

I don't like the sound of this, but trot on old girl.

We watched on the large jumbo screen what was going on directly upstairs from us. 5 presentations. Osaka, Paris, Toronto, Beijing and Istanbul. All of the delegations came down to the media area, except for the Chinese.

This time, my loud mouth stood me in good stead. As soon as the Toronto folks came down the stairs, I yelled out: "Hey John, how are you feeling?!" He later took me aside and asked me if I saw Beijing's presentation and he said it "was a very powerful one." Uhh ohhh.

It was 1PM and I was starving so I went to the cafe and got a plate of my "comfort food", the delicious egg pasta that was served in the hotel. Then back to the computers and I then saw the worldwide screaming headlines that resulted from the press conference the day before. CNN/SI, BBC Online (was their lead story on their news section on the front page) and the regular CNN news site back home. For starters.

The last hour was pure torture. It seemed that everywhere I went I had "eyes" following me figuratively. I ran into my friend from the Denver Post earlier in the day when I made a quick trip over to the other media center across town and his first question was how "did you maintain your poise with all those photographers on your case?" Ah easy. Someone else tapped me on the shoulder and said "good job!" I asked John what happened in his area and he said "the whole place ground to a halt after you asked your question" and he overheard another reporter say to his buddy "she nailed them, fair and square."

He also said that I "blew away every reporter in that room and it was obvious that you did your research. "Gosh, I sure wish I could have called Barb, Joop or Gigi at that moment. That's right, I can't—they're dead. But I had people back home pulling for me, no matter what the end result.

Talk about a zoo. And choking on the smoke—there is no such thing in Russia as a non-smoking area. I parked myself on a seat with a good view of the screen as voting opened. To this day, I still didn't understand the complicated explanation that they gave, if I didn't understand it, how the heck could the people actually voting understand???? John, Marnie and Francine must be going ape crazy about now.

End of round 1. Osaka and Istanbul, you are the weakest links according to the IOC, Goodbye.

End of round 2. My heart is racing as Samaranch steps to the podium and announces the "Games of the XXIX Olympiad in 2008 are awarded to the city of...Beijing."

At that point, the assembled Asian media almost rioted. Someone used my *shoulder* to climb over my chair. I sat there, in shock, wondering what the hell had happened, tears running down my cheeks. Totally dazed.

Oh crap, here comes a reporter (the last thing I wanted to see) from the Times of London, seeking a comment from me. I stammered something about it being morally wrong and what about the safety of reporters covering the Games in 2008?

Later on, the Canadians came down. The first person down the stairs is Daniel Ikonyue. He sees the look on my face of shock and my red eyes from crying and just walks toward me and we both just stand there giving each other a hug and me bawling my eyes out. He's telling me that everything is going to be OK, everything is all right. No one did anything wrong. We held each other for the longest time.

Here comes Marnie. She's in bad shape. I see Francine and give her a big hug. She tries to cheer me up and says "hey, it's not that bad" (but I know it is.) Later on, John comes down, and saw me and gave me a bear hug, as he walked away from reporters trying to get a comment from him. Later on, he takes me aside privately and tells me what he won't tell anyone else, that the Toronto mayor's comments "were the one single factor that hurt us."

The next day, the high drama was just a memory and I see John in the hotel and shout out "Yo, John, what about 2012?!" With a wink of his eye, he says "check with me in about 6 months!"

THE END

Epilogue

I was asked when I got back to the States: was it worth it, all the grief, the hassle, the expense. I said a resounding yes, because if you care *any* iota about this hobby as I do, it's hard to sit on the sidelines and say "that's not MY job!" Besides, someone else probably would have done what I did (and not done it right or only did it halfway.)

I can think of two recent examples of activism: the folks with the RCI Action Committee and also the fine effort by Ralph Brandi and his savebbc.org people. I'm not saying in this hobby it should be "us versus them" but in this era of declining budgets, we on the other side can be the voice for those employed by those broadcasters who for whatever reasons can't speak for themselves due to employee/radio station policy or government restrictions on their activities.

When I first started out, I honestly had *no idea* of where this would end up. In fact, a friend of mine said "you can't do this, this is too dangerous, you don't know what you are getting yourself into." Maybe that person was right, but on the other hand, also congratulated me on a job well done when it was all over. I saw it as a challenge, a way to test myself.

There isn't a magic formula to successful activism, but I think the one thing that stands out is **do your research**. You must know all the issues involved, on "both sides of the fence" and to be able to intelligently discuss those issues when called upon.

You *will* face opposition—the degree of it I can't predict (in my case, someone tried to sic the *feds* on me!). Be prepared for the possibility of things getting ugly, but at all

times conduct yourself with professionalism, even though some people will act in a less than professional manner in an effort to undermine you.

Have a *close* support system. I had a support system back home but the 3 people closest to me are 6 feet under—sometimes I wish I had someone to call just to shoot the breeze and let off steam when things got really hairy.

Don't expect everyone to support you. Believe me, they won't. I just had to graciously accept that and *move on*. In other words: lead, follow or get out of the way!

Don't let anybody try to intimidate you once there. You never know what might be around the corner or what dirty tricks might be thrown your way. This is tough. *You* have to be tougher.

If the door is shut—open it yourself. Don't wait for someone else to grant permission—do it yourself. And don't worry about what others might think. You are going to be too busy to worry about that.

Lastly, above all, look at it as a learning experience. I was able to meet people I would have never been able to if I wasn't there (such as the Deputy Mayor of Osaka, Japan, the President of the Mizuno Corp. and international track and field star Donovan Bailey, among others.) I am still seeing benefits 1 year later. When the VP of the IOC who is also the President of the World Anti-Doping Agency responded to my email about 2 months ago, I realized at that point that my efforts went to some of the highest levels of world sport and communications.

And that's a pretty good feeling to have! 

A New Receiver for DRM Digital Transmissions

You've been reading articles here and elsewhere over the last 5 years designed to prepare you for the day when digital short-wave radio becomes the norm. As the operational date for the DRM system moves out, we sit here wondering if it ever will become an operational reality. I am happy to report that some progress seems to be happening. Not only are numerous test transmissions and demonstrations in progress, but now there is a first sign that a prototype DRM receiver is available to folks like you and me who want to be on the leading edge of this new technology.

In response to popular demand, the folks of the DRM (Digital Radio Mondiale) consortium have been working on a way for SWLs and hams to participate in the DRM test transmissions currently under way by several major SW broadcasters.

The new DRM approach uses a simple concept designed to take advantage of the equipment many of us already have. The approach takes the IF output signal from a receiver, down converts the signal to a center frequency of 12 kHz, and applies the 12 kHz signal to the input of your computer's sound card that is programmed to reconstruct the original audio.

The sound card then processes the digital signal to reconstruct the original audio signal using special software. As an adjunct feature, the software makes an audio file of the processed signal that you can send as an e-mail attachment to the DRM test evaluation group.

Will My Old Boatanchor Receiver Work?

The receiver must have an IF bandwidth which is at least as wide as the transmitted signal. That means many modern receivers will not work because they have IF filters that are narrower than the transmitted signal bandwidth.

The receiver should also have an IF output connector. Initially I thought some of the better boatanchors might be usable. The Collins R-388/51J3 and R-390/390A come to mind among the boat anchors. In order of preference I would select the R-390 first, the R-388/51J3 second and the R-390A third. "Why?" you ask. All three receivers are capable of reception with bandwidths of 10 kHz or more.

The answer to the question, "Which would be best?" lies in the effect of mechanical filters on digital signals. The DRM signals are transmitted on a number of separate carriers within the 10 kHz channel bandwidth. Each carrier is modulated as a separate bit stream that is combined into one stream by the receiver processor. That's how they get the steep sides on the transmitted spectral energy. So the separate signals must traverse the IF filters at the same speed. If the delay across the filter band pass exceeds a limit defined by the data rate, the bits could become impossible to combine in the proper order or could suffer distortion causing the discrete bits to smear into one another. Mechanical filters have notoriously bad delay differences at the band edges compared to the center of the channel. So mechanical filters should be avoided if possible. The only reason the

R-390A makes the list at all is that it has a 16 kHz wide mechanical filter that can be selected. Using this filter, the signal will occupy only the center $\frac{2}{3}$ of the filter bandwidth minimizing the effect of delay distortion at the edges.

Neither the R-390 nor the R-388/51J3 have mechanical filters. Neither does the more modern Watkins-Johnson HF-1000 which also has a wideband IF output. The HF-1000 offers the additional advantage of extreme frequency stability which will aid the processor to do its job.

The frequency stability of the receiver must be sufficient to permit SSB transmissions to be demodulated. The issue of frequency stability causes me to reject many inexpensive receivers that have adequately wide bandwidth like my little S-38C with 20 kHz wide IF bandwidth that I must retune every 15 minutes or so to track AM analog broadcasters across the dial. As we will soon see there are other issues that make the boatanchor a poor choice. Try tuning your boat anchor from a computer interface some time and maybe you will see the problem. But never fear. A DRM consortium member has come to the rescue.

Fraunhofer To The Rescue

The Fraunhofer Institute is a member of the DRM consortium. Fraunhofer recently announced the availability of a software-implemented radio that you and I can use to listen to the DRM test broadcasts. Fraunhofer is selling this radio as a complete system, ready to plug-and-play. The system consists of three parts:

- An AOR-7030 receiver, modified for wide bandwidth.
- A downconverter designed to shift the center of the IF frequency of the receiver down to 12 kHz.
- A computer and software package that accepts the 12 kHz IF input from the downconverter into the line input of the

sound card and demodulates the encoded signal. The software also has many bells and whistles designed to help evaluate the signal quality and send the data to the DRM test evaluation team.

The Fraunhofer Institute has not made public their pricing for this package. If you are seriously interested in finding out more information, like when can you get one, and how many month's pay it will set you back, you should contact the Fraunhofer Institute directly. Their web site is:

<http://www.iis.fhg.de/dab/products/drmreceiver/index.html>

They have a nice operating manual covering their software that you can download from this page. The manual is 46 pages long and covers all the bells and whistles complete with color pictures of the various screen displays you will see on the laptop computer. The manual is in Adobe Acrobat format, and occupies 1,267 KB on your hard drive. The manual is copyrighted by Fraunhofer.

If you would rather try to roll your own system using their proprietary software, here are the salient specifications for their system's hardware:

Receiver

- Bandwidths of 4.5, 5.0, 9.0, 10, 18, and 20 kHz. The bandwidth is automatically selected by the PC to match the bandwidth of the spectrum for the DRM transmission mode being used for a particular test.
- RS-232 serial control interface to PC. (Forget your boatanchors.)
- 12 kHz IF output of >5 dBm. The spectrum is inverted from the 455 kHz IF output by using a mixer injection frequency of 467 kHz. In other words frequencies above 455 kHz in the IF will be below 12 kHz in the downconverted output. I do not know if the software is sensitive to the spectrum polarity and the book is silent on this feature.

Computer

- 500 MHz or better Pentium PC
- 48 kHz soundcard with USB interface.
- Windows 95, 98, NT, ME, or 2000 operating system.

A simplified block diagram of the Fraunhofer receiver hardware is shown in Figure 1.

with developments in the DRM world, the Media Network site is a good place to start. Check it out at:

http://www.rnw.nl/realradio/html/drm_technical.html

In addition the DRM consortium also has a very good web site that can provide lot of additional information. It is at:

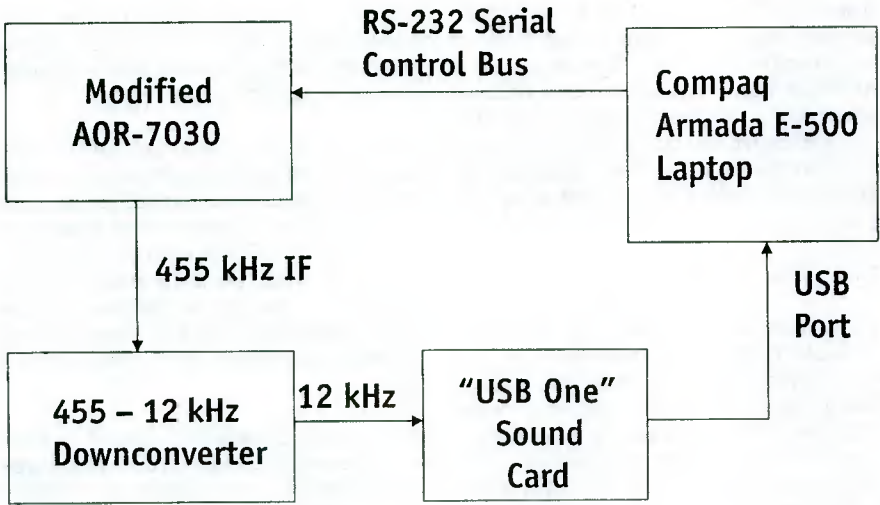

Figure 1. The Fraunhofer receiver uses modified off-the-shelf hardware and proprietary software to demodulate and evaluate DRM test transmissions.

If you actually decide to buy one of these systems, please let Alan Johnson know how it worked for you so he can share your experience with other NASWA members via his Equipment Review column here in the Journal.

I want to thank Andy Sennitt who "mothers" the Media Network web site for providing the first information I saw regarding this receiver. If you would like to keep up

<http://www.drm.org/>

Fraunhofer has also started an e-mail reflector to permit easy dissemination of news related to their work. If you would like to automatically receive these releases, just send an e-mail to:

majordomo@iis.fhg.de
Subject: No Subject
Body: subscribe fhg-swr

That's it for this month. Until next time, stay tuned. 

Adrian Peterson's Diary

Dr. Adrian M. Peterson • Box 29235 • Indianapolis, IN 46229

Big Radio Anniversary in Australia— the Formation of the ABC

It was just 70 years ago that a dozen mediumwave stations located in ten cities in six states throughout the Commonwealth of Australia were formulated into a national network of government radio stations. That event occurred on July 1, 1932, and today they are celebrating their fabulous 70th anniversary with a whole host of special programs.

This is how it all began.

The first permanent radio station in Australia made its inaugural broadcast in Sydney on November 13, 1923 under the callsign 2SB. At the time, station 2SB was owned and operated by a small commercial company, "Broadcasters Sydney Limited." Their original callsign, 2SB, was derived from the initial letters of their ownership, Sydney Broadcasters, with the digit "2" indicating the state of New South Wales.

In anticipation of the inauguration of this new commercial radio station, test broadcasts were conducted from the station location on the rooftop of a newspaper company, "Smith's Weekly & Daily Guardian" in Philip Street, Sydney. The first test broadcasts were made from an amateur radio transmitter running just 10 watts under the callsign 2HP. A few days later, when the commercial transmitter was ready for action, low powered test broadcasts were conducted from this unit.

This first new radio station in Australia commenced a regular broadcast service with a flourish, and the inaugural live broadcast included local Sydney musical talent, both vocal and instrumental. One month later an official inaugural ceremony was broadcast,

and this included a speech by the Postmaster General of Australia, under whose jurisdiction were all matters associated with wireless broadcasting.

Some three months after the initial commencement of programming over station 2SB, the callsign was changed to 2BL, and this new callsign was also taken from their ownership name, Broadcasters Limited. This new callsign was taken in order to avoid confusion on the part of listeners because of the similarity in sound between 2SB and another mediumwave station now on the air, 2FC.

Radio station 2FC was inaugurated as Australia's second wireless station about three weeks after the inauguration of the first station 2SB. Likewise, temporary accommodation was secured for this station on the top of another large building in downtown Sydney, the departmental store of Farmer & Company.

Soon afterwards, a large transmitter facility with tall antennas was installed at Wiltoughby, overlooking the beautiful Sydney Harbour. This location was in use for only three years before an even more suitable location was secured at the AWA transmitting facility at Pennant Hills, an outer suburb of Sydney.

As time went by, the interests of both stations, 2BL and 2FC, became intertwined, until they were amalgamated into one large broadcasting company with studios and offices in Market Street, Sydney. At first the ownership was under the New South Wales Broadcasting Company, and then the Australian Broadcasting Company.

Finally the Commonwealth Government took over and these two "A" class radio stations became the headquarters operation for the Australian Broadcasting Commission. Station 2BL is still 2BL, though in 1971 the callsign of station 2FC was changed to 2RN, standing for "Radio National."

Both of these pioneer radio broadcasting stations in Australia were involved also in shortwave broadcasting. The very first shortwave broadcasts in eastern Australia were made from station 2BL in February 1926 using the amateur transmitter 2YG, owned by Roy Allsop, the station engineer.

These shortwave relays originating from station 2BL were on the air spasmodically for a period of three years, and they were then transferred to the sister station 2FC. At this stage, the regular mediumwave transmitter at Pennant Hills was re-tuned at night to a shortwave channel for this special shortwave programming.

As time went by, further changes took place and these shortwave broadcasts were taken over by AWA under the callsign VK2ME. At the commencement of the European Conflict in 1939, this shortwave service from Pennant Hills was taken over by the ABC as "Australia Calling," the forerunner for Radio Australia, and the experimental callsign VK2ME was regularized into VLO.

Both 2BL and 2FC issued QSL cards in the early days, and today these items are quite historic. One of these early QSL cards shows also the shortwave channel for 2FC as 28.5 metres, corresponding to 10675 kHz.

These two original commercial stations in Sydney became the headquarter stations for the Australian Broadcasting Commission on July 1, 1932, which is the big anniversary that the ABC in Australia is currently celebrating. At the time of the formation of the ABC, 12 mediumwave stations were incorporated into the new government radio network. These stations were located in all six state capitals, though Darwin in the Northern Territory had no radio station of its own at the time.

In addition to the capital city stations, a further four relay stations in country areas were also absorbed into the ABC network, and these were: 2NC, Newcastle, New South Wales; 2CO, Corowa, in the border area between NSW and Victoria; 4RK, Rockhampton, Queensland; and 5CK, Crystal Brook, in South Australia.

In addition to the 12 mediumwave stations, the PMG department also operated an experimental shortwave station at Lyndhurst under the callsign VK3LR. This transmitter took its programming as a relay from the two "A" class mediumwave stations in Melbourne, 3LO and 3AR.

The callsign 3LR was a combination of the callsigns of the two mediumwave stations. The experimental callsign VK3LR was regularized just prior to the commencement of the war as the more familiar VLR, though this station was closed a decade or two back.

A few days ago I phoned the ABC in Australia for additional information regarding their 70th anniversary celebrations, and the receptionist girl at the switchboard gave the identification simply as "702." This, of course, is the frequency for their mediumwave station 2BL. Today the ABC operates a nationwide network numbering more than 500 AM, FM and shortwave stations throughout Australia.

One of the major 70th anniversary events is a historic broadcast with program input from the twelve original mediumwave stations in the ten cities in the six states.

Another significant event that will occur on July 1 is the launching of the ABC's seventh radio network. This new network will be an Internet-only radio service featuring contemporary Australian music for the age bracket ranging from 30-50 years.

We here at Adventist World Radio, and our DX program "Wavescan", honor the Australian Broadcasting Corporation on its auspicious 70th anniversary. 

Listener's Notebook

Al Quaglieri • P.O. Box 888 • Albany, NY 12201-0888 • FAX: (518) 453-0864 • al@alcue.com

AFGHANISTAN RADIO AFGHANISTAN RESUMES NATIONWIDE BROADCASTING Text of report by Iranian radio from Mashhad on 2 June

Radio Afghanistan started broadcasting to all parts of the country on Saturday [1 June], after a decade's suspension [as received: Radio Afghanistan has been broadcasting since November 2001 with a limited range; prior to October 2001 Radio Voice of Shari'ah (Taleban radio) was broadcasting from Kabul].

Due to damage to technical facilities and the lack of the necessary technology, Radio Afghanistan has been broadcasting programs only to the country's capital, Kabul, since the beginning the 70s of AH [1991-1992, as received].

The radio is broadcasting programs only five hours a day now—from 0630 to 0830 [0200-0400 UTC] in the morning and from 1830 to 2130 [1400-1700 UTC] in the evening.

A Kabul radio official said on Saturday evening: "From now on people around Afghanistan can listen to Radio Afghanistan on shortwave at 15240 kHz [as received; presumably means 1524 kHz] in the morning and on 18940 kHz at night."

The USA, Japan, Germany and some international organizations have presented technical equipment and a new 500-W [sic] transmitter to develop Radio Afghanistan's broadcasting capacity. Despite this, Radio Afghanistan is still working with worn-out equipment and needs new equipment and financial and technical support. It is also facing a shortage of writers, producers and artists, most of whom have left the country. Source: Voice of the Islamic Republic of Iran, Mashhad, in Dari 0330 UTC 2 Jun 02 (via BBCM via DXLD)

I wouldn't be so sure '15240' was supposed to be 1524. Check 0200-0400 for another external relay back on 15240, this one perhaps not Norway; Abu Dhabi was mentioned in previous plans. And, sure hope all Afghan radios cover the 18 MHz band... (DX Listening Digest/Hauser-OK)

RADIO KABUL GOES FORTH ON AIRWAVES

From <http://www.edinburghnews.com> By BRIAN FERGUSON

AN Edinburgh-based broadcaster has helped a new radio station in the heart of war-torn Afghanistan get on the airwaves.

Equipment formerly used by Radio Forth is now

being used for broadcasts from the heart of the Afghan capital Kabul.

Good Morning Afghanistan is a humanitarian station set up to broadcast updates on news, international aid efforts and vital messages of help to remote locations.

The station, set up by former Edinburgh journalist Charles Fletcher, is set to broadcast on the FM wavelength throughout Kabul after a new facility was built on the site of a former station bombed during the recent conflicts.

Mr Fletcher had asked his former colleagues at Forth to help out by donating some equipment and by chance his phone call coincided with a refurbishment of the stations studios in Forth Street.

Good Morning Afghanistan, which broadcasts using the old transmitter linked up to a 20-foot bamboo pole, was launched by the Baltic Media Centre, an aid agency based in Denmark.

The company, which Mr Fletcher heads up, broadcasts around two hours of information every day from Kabul on nationwide radio and has also been involved in the training of young journalists there.

Among the pieces of equipment donated from Radio Forth were jingle machines, cartridges, record decks, tape machines, portable cassette machines and radio tuners.

Sandy Wilkie, managing director of Radio Forth, said: "Wed been contacted by a former employee of ours, Charles Fletcher, who now works for an agency that works to re-establish humanitarian radio stations in war-torn countries."

"He wanted to find out whether we had any equipment to spare and we were able to donate some parts. Charles has used them to relaunch a free local station in Afghanistan, broadcasting information on international help and aid to innocent people throughout the country."

Mr Fletcher said: "Weve carried out surveys among our listeners which have found that people here see us as more reliable than the BBC, which really is quite astonishing."

Douglas Paterson, chief engineer at Forth, added: "With the installation of the new studios, I knew that there was some broadcasting equipment that we weren't using and that was going to be thrown out eventually."

"When we heard that we had what Charles required to set up an FM transmission in Afghanistan, we donated the pieces of equipment as soon as we could."

Around 21 Afghans work on Good Morning Afghanistan, which has strict editorial independence.

Managing editor Barry Salaam said: "Were just about ready to start broadcasting live from Kabul on FM throughout the city and will also shortly be able to broadcast on AM throughout the country."

"We've had a lot of donations of equipment and the stuff we had sent across from Radio Forth has been very helpful."

The European Commission provided around 250,000 worth of funding to enable Good Morning Afghanistan to get off the ground.

All that was found on the site of the former radio station following recent heavy bombing just before the fall of the Taliban regime was a piano.

The Radio Kabul studios had previously used solely male broadcasters and only transmitted prayers and propaganda (via Mike Terry, June 2, BDXC-UK/DX Listening Digest/Hauser-OK)

AFGHANISTAN/NORWAY 18940 *Radio Afghanistan* 1357-1445+. Afghan music to 1400, then a couple minutes of Qu'ran, followed by long speech w/mentions of "Afghanistan," "Taliban," "Hamas," "Hormuz," etc. Tuned out at 1445. Problems with the audio breaking up on the speech, but there had been no such problem with the pre-1400 music. VG signal, via Kvitsoy, I guess. (Wilkins June 15/Cumbre/Fleming-NJ) As of June 7, the Afghanistan transmission from Kvitsoy is half an hour earlier, at 1330-1630 UT, which means that the transmission of R. Denmark at 1330 to the Far East on 17525 is CANCELLED, while the previously cancelled one at 1630 on 13800 kHz to Russia, Middle East and South Asia is re-installed. (Erik Koie, R. Denmark, June 7/ DX Listening Digest/Hauser-OK)

AFGHANISTAN [non] New schedule for *Radio Afghanistan* in Pashto/Dari:

0100-0557 15240 DHA
1230-1727 18940 KVI

(Ivo and Angel! Observer, Bulgaria, June 18/DX Listening Digest/Hauser-OK)

BOLIVIA 4716.74 *Radio Yura*, 0047-0109*, Pgm of EG and LA Pops w/W annrc host occasionally. Sounded like the same W that was noted when the stn first came on SW!!! ID at 0103 "...de Radio Yura, la voz de..." Signal went off in mid-song at 0109. Kind of weak but clear. (Valko 16 June/Cumbre/Fleming-NJ)CHILE 6010, R. Parinacota, Putre-Arica, June 1st, 2310-2335, Spanish, international pop songs, time announcements, ID.

6010, June 2, 2330, *Radio Parinacota*, Putre,

relay of Radio Cooperativa with football, football and more football. It was Sunday after all. Games was all local, just a few references World Cup, where Chile is not playing this time. At 0100 a px of spiritual songs well heard until Radio Canada International signed on at 0128. (Johan Berglund, with LW and K9AY, Trollhattan, Sweden, June 3, hard-core-dx/DX Listening Digest/Hauser-OK)

Websites: Official telecommunications agency list of stations at <http://www.sittel.gov.bo/> Sitios del Internet: No hay sitios generales que destacan las radios bolivianas (Catholic Radio in the Americas June 7/DX Listening Digest/Hauser-OK)

Beni: CP--- *Radio La Palabra* 4731 kHz (1,000 wats). Vicariato Apostolico de Beni, Parroquia de Santa Ana. Tel.: (591 46) 20 246, fax (591 411) 9020. P. Yosy Arketa, director.

La Paz: CP63, *Radio San Gabriel* 620am (20,000 vatios) y 6085 khz onda corta (5,000 vatios). Arquidiocesis de La Paz. Avda. Gral. Lanza 2001, Apartado 4792, La Paz. (tel. (591 2) 370 421, fax 391 244. Hermano Jos Canut Saura, FSC, director. 0450-2200 horas [LOCAL TIME presumed])

La Paz: CP29, *Radio Fides* 760 (50,000 vatios) y CP72 en 4845 khz (5,000 vatios), CP12 en 6155 khz (10,000 wats), y CP-- 9625 khz (15,000 vatios) onda corta; y Fides FM 101.5 FM. Fides 2001. Calle Janaro Sanjins No. 799, La Paz. Apartado 9143, La Paz. Padre Eduardo Prez Inhane SJ, director. Telfonos: (591-2) 379030, fax 314332. Founded February 2, 1939. Website: <http://www.fides2001.com/nosotros-fides2001.html>

Riberalta: CP114, *Radio San Miguel*, 6055 khz onda corta y FM Centenario 92.5 FM. El Vicariato de Pando. Apartado 102, Riberalta. El Vicariato: Apartado 9, Riberalta. Telefono: (591) 852-843, fax 852-8146.

Beni [sic]: CP114, *Radio San Miguel*, 4925 kHz (1,000 wats). Vicariato Apostolico de Pando. Calle Bernardino Ochoa N. 58 Rivalta, Beni, Bolivia. CP 102, Riberalta, Beni. Tel.: (591 852) 8363, o 2747; fax 8268. Gerin Pardo Molina, director.

Riberalta: *Radio San Miguel* 3310 kHz (1,000 wats). Vicariato Apostolico de Beni. Calle Rafael Pea No. 58, Riberalta, Beni. Casilla 102. Tel: (591 46) 20 246, fax (591 411) 9020. Felix Rada, director. [It would appear that all three above are same station, tho the last two were reddened as new entries --gh]

San Borja: *Radio Eco San Borja*, 4702 khz. El Vicariato de Beni. Av. Selim Majuli (Correo Central). Gonzalo Espinosa Cortez, director. 7am- 11pm

San Ignacio de Velasco: CP126, *Radio Juan XXI-II* 840 (3,000 vatios) y CP90 6055 khz onda corta (3,000 vatios), y 100.0 FM. Diocesis de San Ignacio de Velasco, Apartado 82, San Ignacio de Velasco. Tel.: (591 962) 2188. Padre Elas Cortezon R., dtr.

Santa Ana del Yacuma: CP-- **Radio La Palabra**, 4730 khz (700 watts). Plaza Fr. Martin Baltasar de Espinosa, Parroquia de Santa Ana, Santa Ana del Yacuma, Beni. Yos Arketa, director.

Santa Cruz: CP 30, **Radio Santa Cruz** 970am (10,000 vatios), y Stereo 92.1 FM, y CP32, 6135 khz onda corta. Los Padres Jesuitas, Calle Mario Flores, esq. Guenda 20, Apartado 672, Santa Cruz. Padre Francisco Flores, SJ, dtr. Telefono: +591(3) 531817, fax 532257.

Siglo Veinte: CP50, **Radio Pio XII** 710am (10,000 vatios), 97.9 FM, y 5948 khz y 5955 khz onda corta. Apartado 434, Oruro. Padre Roberto Durette OMI, dtr. Telefono: +591-52-53163. Fundada 1967, FM May 14, 2000.

Sucre: CP54, **Radio Loyola** 1300am (2,500 vatios), y CP41 en 5995 khz onda corta (1,000 vatios). Fides 2001. Apartado 40, o Calle Ayacucho 161, Sucre. Telefono: +591(64)53677, 54570; fax 42555. Señor Gonzalo Ibez Ferrufino, director. 0600-2200 horas. Se puede or en el Internet. Fundada el 31 de julio 1950.

Tarija: CP204, **Radio Tarija** 640am "La Voz del Campesino" (10,000 vatios) y CP229 6080 khz onda corta (silent) y 98.7 FM. El Obispado de Tarija, Apartado 1003, Calle Bolivar esq. Espaja, Tarija. 0500-0945 y 1200-2140 horas. El Obispado: Calle Gen. Bernardo Trigo 0761, o Apartado 1192. Telefono: (591) 66-3425 o 5042. Marcos Van Der Valk, director. (Catholic Radio in the Americas, June 7, SW listings only excerpted by gh for DXLD; in these and subsequent entries there may be some inactive stations included; reproduced here more or less as given/DX Listening Digest/Hauser-OK)

BRAZIL Websites: The Paulist DX Club has a site that lists loggings of Brazilian AM and FM stations at <http://www.dxc.com.br> and there is a complete list of AM and shortwave stations at <http://www.dxc.com.br/download/projetoradiobrasil.pdf> complete with addresses at the club's website. The national government telecommunications regulatory agency, ANATEL, once had a detailed list of AM and FM stations, but the last time I checked it was not working.

Amazonas Coari: ZYH289 **Radio Educacao Rural**, 1250am (1,000 watts por los dias, 250 watts noches), y ZYF272, 5035 khz onda corta (5,000 watts). Praa Sao Sebastiao 137, Coari AM 69460-000. 0900-0400 horas [suspect UT in this case gh]. Jos C. Martins Cabra I., dtr. (en la diocese de Coari)

Manaus: ZYH286, **Radio Rio Mar** 1290am (10,000 watts por los das, 250 watts por las noches) y onda corta ZYE246, 6160 khz (10,000 watts) y ZYE245, 9695 khz (7,500 watts) Arzobispado de Manaus, Rua Jose Clemente 500, Manaus 69010-070. 0900-0100 hrs. Martin J. Laumann, dtr. Fundada 1954, purchased by Archdiocese in 1962. (en la arzodiocese de Manaus)

Bahia Fiera de Santana: ZYH451 **Radio Sociedade de Fiera de Santana** 970am (10,000 watts dias, 5,000 watts noches), ZYF390 on 4865 khz shortwave, & Radio Princesa 96.9 FM. Obispado de Feira de Sanana. Frei Hermenegildo 300, Capuchinhos, CP 1525, 44052-240 Feira de Santana, BA. Telefonos: (55 075) 625-5119, fax 625-1210. Frei Rutivalder Alves de Brito, director.

Ceara Crato: ZYH600 **Radio Educadora** 1020am (5,000 watts dias, 1,000 watts noches) y ZYF533 3255 khz onda corta (1,000 watts). Rua Coronel Antnio Luiz 1068, Bairro do Pimenta, 63100-000 Crato. 0900-1400 & 1900-0200 hrs. Padre Goncalo Farias Filho, dtr. (en Diocese de Crato)

Minas Gerais Governador Valadares: ZYL254 **Radio Por um Mundo Melhor** 850am (10,000 watts day, 500 watts night), 97.7 FM, y ZYG202 on 4855 kHz (1,000 watts) shortwave. Avenida Brasil 2770, 35020-070 Governador Valadares, MG. Odilon Lagares de Aguilar, director. (in the Diocese of Governador Valdares).

Para Belm: ZYI532 **Radio Clube Paranaense** 690am (20,000 watts dias, 5,000 watts noches), y ZYG362 on 4885 khz (5,000 watts). C.P. 533, 66017-970 Belem PA. Snhr. Eddy Piauua Preena, dtr. (En la arzodiocese de Belem.)

Santarem: ZYI354 **Radio Rural** 710am (10,000 watts day, 5,000 watts night) & ZYG363 on 4765 kHz (10,000 watts). Av. Sao Sebastiao 622-A, 68005-090 Santarem, Para. Tel.: +55 (83) 522-2439. Silvana Maria Santos, director. (in the Diocese of Santarem).

Parana Londrina: ZYJ260 **Radio Alvorada de Londrina** 970am (5,000 watts por los dias, 1,000 watts por las noches), y ZYD649 en 4865 khz (5,000 watts). Edificio Julio Fuganti, Rua Senador Souza Naves 9, 9er piso, Salas 903-911, 86010-170 Londrina PR. Telefonos: (43) 336-0606, fax 321-4745. Senhor Paulo Lauro C. de Oliveira, director. 0400-1200 horas.

Pernambuco Petrolina: ZYI780 **Emisora Rural a Voz do So Francisco** 730am (10,000 watts) y ZYG525 4945 khz onda corta (1,000 watts). Fundao Emissora Rural a Voz do So Francisco, Praca Maria Auxiliadora 205, 5630-000 Petrolina PE. Telefonos: (081) 862-1522. Dom Frei Paulo Cardoso, director. 0800-0100 horas [UT or local?]. (en la diocese de Petrolina)

Piaui Teresina: ZYI891 **Radio Pioneira de Teresina** 1150am (10,000 watts dias, 5,000 watts noches) y ZYG595 onda corta 5015 khz (1,000 watts). Fundacao Dom Avelar Brando Vilela, Rua 24 de Janeiro, 150 Centro, Teresina. Tel.: 0 xx 86 221-8121, fax 221-8122. Luis Soares de Melo, director. Director de radio: Padre Tony Batista.

Rondinia Guajara Mirim: ZYJ670 **Radio Educadora** 1260am (1,000 watts dias, 250 watts noches) & ZYG792 on 3375 kHz (5,000 watts). Fundacao Dom

Rey, Praca Mario Corria 90, o C.P. 51, Guajara-Mirim, RO. Telefono (069) 541-6333. Padre Izidoro Jose Moro, director. (en la diocese de Guajar Mirim)

Porto Velho: ZYG671 **Radio Caiari** 1430am (1,000 watts) & ZYG790 on 4785 khz (10,000 watts). Av. Carlos Gomes 932, 78900-030 Porto Velho. Carlos A. Diniz Martins, director. (in the Arzobispado de Porto Velho).

Sao Paulo Aparecida: ZYK542 **Radio Aparecida** 820am (10,000 watts por los dias, 500 watts noches) y FM 90.9; y onda corta ZYG853 en 5035 khz (10,000 watts), ZYE954 6135 (25,000 watts) y 9630 khz (10,000 watts), y ZYE954, 11855 khz (1,000 watts); Basílica de Nossa Senhora de Aparecida. Av. Getúlio Vargas 185, Aparecida 12570-000. 0700-0300. Telefonos: +55(12)565-1133 fax 565-1138. Padre Antonio Cesar Moreira Miguel, dtr. E-mail: radioaparecida@redemptor.com.br; website <http://www.radioaparecida.com.br> (En la arzodiocese de Aparecida)

Cachoeira Paulista: ZYK513 **Radio Canao Nova** 1020am (10,000 watts por los dias, 250 watts por las noches), ZYG868 on 4825 khz (10,000 watts), ZYE971 on 6105 khz (10,000 watts), y ZYE971 on 9675 khz (10,000 watts). Difunde sobre el Internet. C.P. 57, 12630-070 Cachoeira Paulista, SP. Wellington Silva, Jardim, director. 24 hras. Website: <http://www.cancaonova.org.br> E-mail: radio@cancaonova.org.br (En la diocese de Cachoeira do Sur) Fundada el 25 de mayo 1980 (Catholic Radio in the Americas June 7, SW only excerpted by gh/DX Listening Digest/Hauser-OK)

CANADA I received a letter from Scott Snailham yesterday in reply to my letter addressed to him stating that he no longer works for CHNS/CHFX/CHNX having left in April 2000. Scott was the last prime veri-signer at the station until that time.

He states: "Unfortunately, to my knowledge, **CHNX** is no more, as of at least this year, if not before. The transmitter was scrapped, and the whole thing was a victim of the bottom line mentality that exists in commercial radio today. If it doesn't generate revenue, then it's a waste, and thus not worth doing. A shame really, as it existed since 1930 in one form or another..." (his letter goes on).

He also states that the station CHNS/FX is again without an engineer (overworked and underpaid being the reason for the previous engineer leaving). An end of an era, folks with the demise of CHNX (an all too frequent occurrence for my liking in the radio operations world, I'm afraid, with radio staffing/economics and with shortwave stations disappearing...hmm) RIP CHNX. I last heard it in May 2001. (Ian B.[axter?], ARDXC via DXLD) I think that's about when they went off after one last gasp (gh/DX Listening Digest/Hauser-OK)

CHILE *Voz Cristiana*, Santiago, plans a reduction in on-air hours from Jun 16. As of that date, the schedule becomes: 6070 2200-1200, 9635 1200-2000, 11745 2100-1100, 11935 1100-1300, 15375 0000-1400, 17680 1400-0000, 21550 1300-1400. (11690 will be deleted completely) (EDXP June 18/ DX Listening Digest/Hauser-OK)

CLANDESTINE—AFRICA 7309.97, **Radio Voice of the People**, *0330-0338, OC on at 0329, brief mic feedback-like noise, 0330 pleasant instru. mx w/M anncr giving ID "This is Radio V.O. the People. Good morning World. In todays talks..." and ment of rights, Zimbabwe, and Africa. Immediately into W host w/interview of M but it was difficult to get the topic due to heavy accent and horrible 7305 slop QRM. Signal was fairly strong though. (Valko June 15) WHRI appears to still be off 7315 as of Jun 21. It also seems that VoP has a lot more English in their transmissions now. (Johnson/Cumbre/Fleming-NJ)

12125, **Voice of Biafra International**, 1916-2000, Speech by M w/ment of Nigeria. Into pleasant Afro mx. What sounded like an ID at 1929 but couldn't be certain. Long live impassioned speech by M 1929-1945 w/ments of "people of Nigeria..." "We have free..." and military. 1945 M anncr briefly, into more easy Afro mx. ID at 1952 w/ment of broadcast, and deep-voiced M w/speech. 1957 ID and addr by W, followed by final ID by M as "This has been the V.O. Biafra Int. coming to you from Washington D.C. transmitting on...Thank you for listening to our pgm...our next broadcast, good-night." Then instru. Afro mx. At 2000 there was an ID for R. Canada Int. then ID/satellite info by M, and beam/freqs/ID by W. This signal wasn't quite strong enough to copy pgm content. (Valko 15 June/Cumbre/Fleming-NJ)

CLANDESTINE—ASIA 5101 **Voice of Jammu and Kashmir Freedom** on 10 Jun. The program was already in progress when check in at 1330. Various mentions of Gen Musharraf and Pakistan.

At 1400 UTC, English was right on schedule. Today, there is a commentary alleging that India has sabotaged the peace initiative by sending in spy planes and that sort of thing. According to them, Pakistan was party doing the right thing. The commentary also says that the Kashmir problem can only be solved through negotiations between Indian, Pakistani and Kashmiri parties. Only heard the word Kashmir 2x in the whole commentary. Vernacular follows at 1408 after a brief song. On the whole, the broadcast was much better heard on this occasion than half a year or 18 months ago. I can hear clearly almost all the content of the English broadcast although the hum is still there. Rather than shut this down, I believe they have increased their power output significantly. (Lam-SNG/Cumbre/Johnson)

New schedule for **Voice of Khmer Krom Radio** in Vietnamese via VLD 1400-1500 Tue NF 15660, ex 1400-1500 Fri on 15690. (Ivanov & Datzinov Observer Jun 18/Cumbre/Fleming-NJ)

CLANDESTINE—MIDEAST Voice of Mezopotamia in Kurdish, from CIS site:

0400-1200 Kurdish 15675 TAC
1200-1600 Kurdish 11530 KCH

(Observer Jun 21/Cumbre/Fleming-NJ)

9154.7 **Voice of Ashur** heard at tune in 1830 during an Assyrian* folk song followed shortly by an Arabic ID by male voice 'Izaat Ashur min al-Watan'. I heard some other vernacular IDs by a female voice apparently in Assyrian languages. They broadcast news in Arabic at 1840 with commentaries hostile to the current Iraqi regime, no trace of them after 1857. S7 with intense utility interference and frequent fading. *The name "Assyria is the chronicle of Arbela (modern Arbil), they are not by any means affiliated to the northern Iraq Kurdish community and in fact they are historical enemies. (Fathi Jun 18/Cumbre/Fleming-NJ)

COLOMBIA 6064.55, "**Sistema Radial de Alcarabanga**" (Venezuela?). June 7 2002—0120 UT. The station was heard for the first time Thursday evening June 6 2020 local time here in Quito and closed down at 0245 UT with out ceremony. Checked the frequency this morning and the started around 1100 UT.

The program seems to have two variants. One is purchased (?) religious program. I have heard "Voz Cristiana"-programs and religious programs produced in SF de Bogot—at least they gave Bogot-addresses: "A.A. 95300, Bogot" and "...calle 44 #3-79, Bogot" and telephone numbers: "3 31 38 07 and 3 4? 14 19, Bogot." The other variant is nonstop Venezuelan "llanero" music, which can last for

more than a full hour, only interrupted by some short, religious phrases from the male DJ.

I have been listening for almost 5 hours and only heard an ID at two occasions, when interrupting the "llanero"-music giving ID as: "Estn en sintonia de Sistema Radial de Alcarabanga 1530am" There is nothing matching on 1530 kHz. The second time I only heard sole words sounding like: "...estudios en "Banaminda"(?) transmite...de "...tumble"(?) La Voz de...."

The above info was sent to SWB as a "BM preview" June 7. Thanks go to our members Kenneth Olofsson/KO and Bjrn Fransson/BEFF who both sent e-mail regarding this station. Kenneth has it as an unID with, as he believes, Colombian music and suggests "Colmundo Radio," which is listed on the frequency. BEFF has it as an uncertain "carrier" next to Family Radio and also mentions "Colmundo Radio."

(Bjorn Malm, Ecuador, SW Bulletin June 16, translated from Swedish by editor Thomas Nilsson/DX Listening Digest/Hauser-OK)

Bogota: HJKU **Emisora Kennedy** 1430am (12,000 watts) y HJKW 4775 khz (1,000 watts). Colegio Mayor de San Bartolome, Parroquia La Macarena. Calle 385 #75-31, Ciudad Kennedy 72875, Santa Fe de Bogota. Tel: (91) 2-730703. Seor Jos Vicente Echeverri, director. La onda corta es inactiva.

Buenaventura: HJJA **Radio Buenaventura** 1240am (3,000 w) y HJAM 4835 khz onda corta (1,000 w). Apartado Aereo 383, Buenaventura. 0530-2400 horas [local time UT-5 presumably]. Padre Antonio Bayter Abud, dtr.

Florencia: HJVK **Armonias del Caqueta** 970 (30,000 w) y HJRI 4915 khz onda corta (3,000 w). El Obispado de Florencia, Carretera 14 #12-129, Piso 2a, o Apartado 285, Florencia. 0500-2200 horas. Padre Alvaro Serna A., dtr.

Tumaco: HJKG **Radio Mira** 1190am (10,000 watts) y HJOW 6015 khz (1,000 watts). A.A. 165, Tumaco. Gabriel Osornio, director. 0600-2300 [local time] (Catholic Radio in the Americas, June 7, SW items only excerpted by gh/DX Listening Digest/Hauser-OK)

CONGO—DEMOCRATIC REPUBLIC 7435.0, Lubumbashi, Jun 2, 0600-0700 with a soccer match relay, 1445-1500 with local religious songs and soccer results, and 2100-2200 with a repeat of a soccer match. It would seem that soccer is of more than just a passing interest in Lubumbashi! (Korinek-RSA/Cumbre/Johnson)

9550, **Radio Okapi** not noted for the past two weeks or so (Vashek Korinek, RSA, Jun 4, DSWCI DX Window/DX Listening Digest/Hauser-OK)

GEORGIA 4540 and 4875, **Radio Khara**. This station should not be confused with the Foreign Service of the Georgian R broadcasting in Azerbaijani at 1500-1530 on 4540 from Dusheti. (van Delft) Maarten's rare photo of the Dusheti transmitting station 40 kilometres north of Tbilisi will be shown in the next SWN (DSWCI/DX Listening Digest/Hauser-OK)

9490, **Abkhaz Radio**, Sokhumi: R Sweden [via Canada! gh] blocks 9490 more or less 0200-0600 or later throughout Georgia. This should also present rather unpleasant reception conditions in Abkhazia proper. Despite this QRM, I once noted Abkhazian programming being opened at 0615. During local afternoon (0800-1300) nothing much is heard on 9490. In the evening (1300-1800) R Rossii relays come in very well, but during my many checks I did not hear any locally produced programmes in Abkhazian (Maarten van Delft, Georgia, DSWCI DX Window June 5/DX Listening Digest/Hauser-OK)

GERMANY Updated A-02 schedule for Deutsche Telekom (DTK) as of June 5

Radio Vilnius:

0000-0030 Lithuanian 9855 JUL
0030-0100 English 9855 JUL

Radio Free Europe/Radio Liberty/Radio Free Afghanistan:

0100-0300 Arabic 12030 JUL
0300-0400 Arabic 11910 JUL
0300-0400 Pashto 13790 WER
0400-0500 Dari 13790 WER
0400-0600 Arabic 12030 JUL
0700-0730 Pashto 15345 WER
0730-0800 Dari 15345 WER
0900-1000 Dari 15220 WER
1000-1100 Pashto 15220 WER
1200-1300 Pashto 17740 WER
1300-1400 Dari 15535 WER
1600-1700 Armenian 9620 JUL
1600-1700 Arabic 9825 JUL
1700-1800 Arabic 9575 JUL
1800-1900 Arabic 9705 JUL
1930-2000 Dari 15190 WER
1800-2000 Farsi 9885 JUL
2200-2230 Pashto 11990 WER
2230-2300 Dari 11990 WER

Hrvatska Radio/Voice of Croatia:

0100-0300 Croatian 9925 JUL
0300-0500 Croatian 9925 JUL
0500-0700 Croatian 9470 JUL
0700-0900 Croatian 13820 JUL
2300-0100 Croatian 9925 JUL

United Methodist Church/Radio Africa International:

0400-0600 French 11645 JUL 13810 JUL
1700-1900 English 13820 JUL 15265 JUL

Voice of Hope/High Adventure Ministries:

0400-0600 English 15715 JUL
0700-0800 English 5975 JUL
0700-0900 Arabic 21590 JUL
0900-1000 English 21590 JUL
1330-1430 Vietnamese 15775 JUL
1330-1430 English 17550 JUL
1430-1530 Hindi 17550 JUL
1500-1600 English 15715 JUL
1530-1630 Persian 17550 JUL
1600-1700 Amharic 13810 JUL
1600-1700 Persian 15715 JUL
1700-1800 English 9495 BIB
1700-1800 Arabic 15715 JUL
1800-1900 Russian 9495 BIB
1800-2100 English 15715 JUL
2000-2100 English 6175 JUL

Radio Nederland Wereldomroep:

0600-0655 English 13820 JUL
1030-1225 English 6045 JUL 9860 WER

Swiss Radio International:

0600-0800 Fr/Ge/It/En 15445 JUL 17685 JUL
1630-1815 It/Ar/En/Fr 15220 JUL 17735 JUL
1830-2130 It/Ar/En/Ge/ Fr 15220 JUL 17580 JUL

Deutsche Welle:

0600-1555 English 6140 JUL
1555-1900 English 6140 WER

WYFR/Family Radio:

1600-1800 English 13855 JUL
1700-1900 Russian 9695 JUL
1800-1900 French 15775 JUL
1900-2000 Arabic 9495 JUL
1900-2000 French 13855 JUL
1900-2100 English 15775 JUL
2000-2200 English 13855 JUL

IBRA Radio:

1645-1715 Pashto/Dari 13590 WER
1900-1930 Hausa 13710 NAU
2230-2330 Arabic 9405 JUL

Democratic Voice of Burma:

2330-0030 Burmese 9490 JUL

Universelles Leben:

0100-0130 English 9435 JUL
1600-1630 French 15670 JUL
1630-1700 German 6015 JUL
1800-1830 English 15750 JUL

RTBF:

0300-0500 French 9495 JUL
0430-0500 French 9495 JUL
0500-0715 French 17580 JUL
0500-0805 French 17580 JUL
0500-1000 French 17580 JUL
1000-1205 French 21565 JUL
1000-1115 French 21565 JUL
1100-1115 French 21565 JUL
1500-1715 French 17570 JUL
1600-1715 French 17570 JUL

AWR/Adventist World Radio:

0400-0500 Bulgarian 9570 JUL
0600-0700 Arabic 11610 JUL
0700-0730 French 11610 JUL
0900-1000 Italian 11880 JUL
1600-1700 Romanian 15360 JUL
1700-1800 Bulgarian 15235 JUL
1900-2000 Arabic 15485 JUL
2000-2030 French 15485 JUL

VRT/Radio Vlaanderen International:

0500-0655 Dutch 13685 JUL
0700-0725 English 5985 JUL
1730-1755 English 13710 JUL
1800-1855 Dutch 13710 JUL
1800-1955 Dutch 5910 JUL

TWR/Trans World Radio:

0645-0750	English	6045 JUL 15545*JUL
0645-0820	English	6045 JUL 15545*JUL
0655-0820	English	6045 JUL 15545*JUL
1230-1245	Croat/ Slovenian	9490 JUL
1600-1645	Romanian	7135 WER 9660 NAU

Voice of Democratic Path of Ethiopian Unity:

0700-0800	Amharic	21550 JUL
1830-1930	Amharic	15565 JUL

Remnants Hope Ministry:

0800-0900	English	13810 JUL
1200-1300	English	6110 JUL

Radio Rainbow:

0800-0900	Amharic	6180 JUL 15410*JUL
1900-2000	Amharic	15565 JUL

WSHB/Christian Science Monitor:

0900-1000	German	5985 JUL
-----------	--------	----------

Evangeliumsradio Hamburg:

0900-1000	German	6045 JUL 15545*JUL
1730-1800	German	6015 JUL

Brother Stair/TOM:

1200-1300	English	5975 JUL
1300-1400	English	13810 JUL
1500-1555	English	6015 JUL
1555-1800	English	6015 JUL

Voice of Democratic Eritrea:

1400-1500	Tigrina	5925 JUL
1700-1800	Tigrina	15670 JUL

Tigrean International Solidarity for Justice and Democracy:

1600-1630	Tigrina	15530 JUL
-----------	---------	-----------

Voice of Ethiopian Salvation:

1600-1700	Amharic	15530 JUL
-----------	---------	-----------

Radio Huriyo:

1630-1700	Somali	15530 JUL
-----------	--------	-----------

Voice of Oromo Liberation:

1700-1730	Oromo	15670 JUL
1730-1800	Amharic	15670 JUL

FEBC:

1800-1830	Tagalog	11895 WER
-----------	---------	-----------

Radio Reveil Paroles de Vie:

1830-1900	French	15750 JUL
-----------	--------	-----------

* test frequency BIB = Biblis; JUL = Juelich; NAU = Nauen; WER = Wertachtal 73 from (Ivo and Angel! Observer, Bulgaria, June 7 via DXLD)

GREECE New schedule for Radiofonikos Stathmos Makedonias in Greek:

1100-1300	11595
1300-2300	9935

(Ivo and Angel! Observer, Bulgaria, June 11/DX Listening Digest/Hauser-OK)

GREENLAND KNR [Kalaallit Nunaata Radioa] is back on short wave. The daily news programs are carried on 3812 kHz (usb) with 100 W at 1130-1230 and 1800-2000 local time in Nuuk (1330-1430 and 2000-2200 UTC when DST is observed, and 1430-1530 and 2100-2300 when standard time is in use). The transmissions are unofficial but are quite regularly heard—especially during Summer. Transmitter site is Tasilaq on the Eastcoast of Greenland, and reports indicate that the transmissions can be monitored on the Westcoast of Greenland. "Real" short wave transmissions may start again in Greenland. For some ten years the authorities have been considering closing down the current five 5-10 kW medium wave transmitters. Indications are that very few listen to the medium wave transmitters as all inhabited areas are now covered with FM transmissions and because audio quality is poor on most of the transmitters—in Greenland they utilize the same very narrow bandwidth of 4.5 kHz as in Denmark. Besides, electricity is very expensive in Greenland. Calculations and considerations have been made to replace these five medium wave transmitters with one short wave transmitter on the island of Cook—not far away from Nuuk. That would be a more efficient way to serve the fishermen who are -more or less—the only ones still listening to AM. Cook Island was also the site of the old short wave transmitters of KNR using 3999, 5980 and 9575 kHz several years ago. When—or if—a new official short wave station in Greenland is to be taken into use again a frequency in the 3-5 MHz spectrum is likely. 73 (Stig Hartvig Nielsen, Denmark, June 6/DX Listening Digest/Hauser-OK)

INDONESIA 3266.4 RRI Gorontalo. 1250 local pops, SCI, Jakarta news relay then signed off with closing announcement. Fair signal. (Yamada Jun 15/Jembatan DX)

3325 **RRI Palangkaraya** Jun 2 1355-1405 Indonesian, Talk. 1400 ID and IS. 1401 ID. Local news. (Hashimoto-JPN/Japan Premium/Iwata-JPN)

3976.1 **RRI Pontianak.** At 1432 ID as "Radio Republik Indonesia Pontianak" then female talk, music and telephone conversations. Fair. (Yamada Jun 11/Cumbre/Fleming-NJ)

4753.5 **RRI Makassar.** Best signal of all Indonesian local stations except RRI Jakarta. At 1200 Relay news entitled "Dinamika Indonesia" from Jakarta. ID by female at 1229 as "Radio Republik Indonesia Makassar" then followed to "Berita Keluarga." From 1238 Nice Indonesian pops. (Jun 4, 2002, Juichi Yamada, JAPAN/Jembatan DX)

6071.2 **RRI Jayapura** May 30 1042-1055* Indonesian, Talk and pops music. ID at 1054. 1055 s/off. (Hashimoto-JPN/Japan Premium/Iwata-JPN)

9742 *RRI Sorong*, 0711 May 30, in the clear with talk in BI, female host and phoned in reports. Id 0713 then a commercial and into Indonesian version of C&W songs. Fair signal (Paul Ormandy, New Zealand/DX Listening Digest/Hauser-OK)

IRAN Summer A-02 schedule for *VOIROI / IRIB* Tehran:

0000-0527	Persian	15084
0030-0127	Bengali	6005 9570 9890
0030-0127	English	9610 11970
0030-0127	Spanish	9515 9655 13755
0100-0227	Tajik	7180
0130-0227	Arabic	9705
0130-0227	Kazakh	11935 13770
0130-0227	Spanish	9560 9655 9810 13755
0130-0227	Urdu	9525 11880 13640
0230-0257	Hindi	15165 17635
0230-0257	Uzbek	7180
0230-0327	Pashto	7130 9605 11765
0230-0327	Spanish	13730
0230-0627	Arabic	9790 11935
0230-1627	Arabic	15125 15150
0300-0327	Armenian	11860
0300-0327	Russian	9875 11830 13665 13770
0300-0627	Dari	9580
0330-0427	Arabic*	9610 11870
0330-0427	Swahili	15260 17570
0330-0527	Arabic**	7120 7245 9685
0330-0527	Azeri	13710
0430-0557	Turkish	15260 15365
0530-0627	Bosnian	17680
0530-0627	Spanish	17590 17785
0600-0657	Hausa	17600 21810
0630-0727	Albanian	15235 17680
0630-0727	French	17590 17780 21645
0630-0727	Italian	15084 17825
0700-1457	Arabic	13770
0730-0827	German	15084 17590
0830-1157	Dari	11880
0830-1157	Persian	15084
0930-0957	Armenian	11700 15260
0930-1227	Arabic	17560
1100-1227	English	15215 15585 15600 21470 21730
1130-1227	Swahili	17780 21755
1200-1257	Chinese	17530 17785 21460 21490
1200-1257	Italian	15084 15235
1200-1457	Dari	7295
1230-1327	Malay	15200 17555 17635
1230-1327	Pashto	9630 9790 11870 13785
1230-1627	Arabic	13820
1300-1327	Japanese	15235 15555
1300-1357	Kazakh	11665 13755 15330
1300-2357	Persian	15084
1330-1457	Urdu	9665 11695 13605 13785
1400-1457	Russian	12030 15200 15290
1430-1457	Azeri	6200
1430-1527	Bengali	9520 9810 12000 15395
1430-1527	Pashto	7270

1500-1527	Hindi	9630 9720 11710 15245
1500-1557	Uzbek	5955
1500-1657	Azeri	6200
1500-2127	Arabic	9860
1530-1627	English	7245 9635 11775
1530-1627	Russian	9830 11675 11730 12020 12095 13790
1530-1727	Urdu	7270
1600-1727	Tajik	5955
1600-1727	Turkish	7165 9550
1630-1727	Armenian	7230 9780
1630-1727	Pashto	6015 7195 9725
1630-1827	Arabic	9705
1630-1927	Arabic	6025 11740 11840
1730-1827	Bosnian	7295 9615
1730-1827	German	11855 15084
1730-1827	Russian	6140 7115 7205 7305
1730-1827	Swahili	9655 11995
1730-1927	Arabic	6200
1730-2227	Arabic	11905
1830-1927	Albanian	9545 9570
1830-1927	Arabic	9705
1830-1927	French	11765 11860 11880 15084
1830-1927	Hausa	11930 15435
1930-1957	Italian	7295 13650
1930-2027	Arabic*	6025 6200 9705 9860 11740 11840
1930-2027	English	9800 11670 11750 11855
1930-2027	Russian	6045 7125 7175
2030-0127	Arabic	6200 9705
2030-0227	Arabic	7295
2030-2127	Albanian	9535 15084
2030-2127	Arabic	6025 11740 11840
2030-2127	Spanish	9750 11765
2100-2127	Japanese	11885 13635
2130-0127	Arabic	11710
2130-0227	Arabic	11740
2130-2227	Bosnian	9810 15084
2130-2227	English	9570 13665
2330-0027	Chinese	11750 15490 15570
2330-0027	French	9560 11970

* Voice of Islamic Palestinian Revolution

** Voice of Islamic Revolution of Iraq (R BUL Observer, Ivo Ivanov and Angel Datzinov, Apr 19, with updates from R. BUL Observer dated Apr 30 and May 31, all via Wolfgang Bueschel/BC-DX via Alan Roe/DX Listening Digest/Hauser-OK)

KOREA—NORTH Voice of Korea to Eu noted on NF 15245v as follows: 1300-1356 English 1400-1456 French 1500-1556 English 1600-1656 French 1700-1756 Korean 1800-1856 Spanish 1900-1956 English 2000-2056 French 2100-2156 English 2200-2256 Spanish 2300-2356 Korean// freq for all txions 13760 (IBRA via JUL/Observer, Bulgaria, May 21 via DX Listening Digest/Hauser-OK)

NEW ZEALAND 7145 *Radio Ferrymead*, Christchurch, 0532, this station is licenced to broadcast on 1413kHz yet was observed on SW with

40's & 50's music in parallel to their official channel. The signal was not strong and suffered fading. Given that Christchurch is 150 miles north of here, it must be a low powered operation though I think it would make it across the Tasman. There is a history of illegal re-broadcasts from Christchurch. I rang Radio Ferrymead and they knew nothing of this. (Ormandy June 2/Cumbre/Fleming-NJ)

OMAN 13725 (ex 15140)1520 *Radio Sultanate of Oman* talk in Arabic. (Chakroboroty Jun 16/Cumbre/Fleming-NJ)

PERU 4678.86 *Radio Paz Peru Internacional*, Chiclayo, la provincia de Chiclayo, el departamento de Lambayeque. June 12 0155 UTC. Ought to be a new station, at least on SW—but as usual you have to be careful with “new station” as it is absolutely impossible for me to know everything. Probably been on air for only a few days. Got ID pretty fast but QTH took some more days. Says a SW frequency but I can't get it. ID often as: “Radio Paz Peru Internacional para todo el Peru y el mundo.” Sometimes various IDs: “Radio Paz Peru,” “Radio Paz Internacional” or only “Radio Paz.” Says email-address as radio-paz@terra.com.pe. The street address given a few times together with education on distance by radio and ads for clothes, include the number “47” and “Chiclayo.” The audio quality is not the best. The program consists of Peruvian music, both secular and Christian. Transmitting schedule seems to be 2300-0300 UTC. (Cumbre/Fleming-NJ)

5122.07 *Radio Santa Rosa*, unknown QTH. May 28—2335 UTC. New Peruvian radio station. Sometimes mentions “estamos en calidad de prueba” which roughly translated means “test transmission.” Probably started 3-4 days earlier but the very weak signal did not even force me to try getting an ID. Neutral popular music from LA and very frequent “Radio Santa Rosa”-IDs. Varies some 1/100-parts in frequency and announces 5120 kHz. I have noted close downs both at 0000 and 0100 UTC. There are so many “Santa Rosa” in Per but if I am going for the geographic name I heard, several “Cajamarca” and “San Ignacio,” with lots of questionmarks, my wild guess of the QTH will be: “Santa Rosa, la provincia de Jan, el departamento de Cajamarca.” To chase the correct QTH you can listen for the following places: Info from “Ventanaper:” Provincia de Jan, cuya capital es Jan. Sus distritos son: Bellavista, Colasay, Chontal, Jan, Huabal, Las Pirias, Pomahuaca, Pucar, Sallique, San Felipe, San Jos de Alto, Santa Rosa; con una poblacin total de 168,138 hab. (Bjorn Malm in Quito via Shortwave Bulletin, translated by SWB editor Thomas Nilsson)

5940.12 *Radio Bethel*, Arequipa (Per). May 23 2002—0025 UTC. Nonstop religious music and “Radio Bethel”-IDs. This station was earlier on 5950.10 and 5949.59 kHz acc. to my notes. Listed as “Radio Arequipa” but I have always noted the name of the

station as “Radio Bethel.” (Bjorn Malm in Quito via Shortwave Bulletin, translated by SWB editor Thomas Nilsson)

5940.2 *Radio Bethel*, 0447, fair signal suffering some QRM from WWCR 5935kHz and best in USB. Gospel music back-back till 0453 then id and SW frequency given. More gospel music till 0459 then lengthy religious message and a further id. Music continued until a long recorded religious message followed by national Anthem, closing at 0508. (Ormandy May 31st)

5940 *Radio Arequipa* Bethel 0009 heard a male announcer in SP with long dialogue. Next was a fanfare and probable stn ID (the word radio was definitely heard, but couldn't make out rest of ID. Then a religious song with “hallelujah” mentioned many times. The music fanfare and probable ID were given every song or two. At 0039 heard a ticking clock then time check. On other days, I have heard a sermon in the 0040 time period until WWCR signs on at 0055 or 0056. Stn was heard quite well tonight despite summer static and even past 0056 under Gene Scott. (Sgrulletta May 31)

5996.63 *Radio Melodia*, Arequipa May 31 2002—1100 UTC. New frequency, previously on 5940.06 kHz. ID with a short song-ID: “Melodiiiiia.” Bethel.” (Bjorn Malm in Quito via Shortwave Bulletin, translated by SWB editor Thomas Nilsson)

Arequipa (Callalli-Cayoma): OAW6A *Radio San Antonio* 3375 khz (1,000 watts) y OAW6B on 3375 khz. Parroquia de San Antonio de Padua, Asociacin Promotodra San Francisco Solano, Apartado Postal 1817, Arequipa. Hermano Rolando del Carpio Montalvo, director. Plaza Principal s/n, Callalli, Depto. Arequipa, Per. ID “Es Radio San Antonio...que transmite desde la ciudad de Callalli para todos los oyentes, es una emisora Catlica a servicio de la comunidad” 5am-9 a.m. and 5pm-9pm, Monday through Saturday. E-mail: rsan_antonio14@hotmail.com

Chachapoyas: OBX9K *Radio Horizonte* 5020 khz onda corta (1,500 w) y 99.9 FM. El Obispado de Chachapoyas. Jr. Ayacucho 1008 o Apartado 69, Chachapoyas. Telefonos: 51 (74) 75793, fax 757004. Soledad Snchez C., dtra.; Maria Dolores Gutierrez Atienza, ing.

Huamachuco: OAX2U *Radio Los Andes* 1030am (3,000 w) y OAZ2A 5030 kHz (5,000 w) onda corta. El Prelato de Huamachuco. Casa Prelaticio, Paisaje Mons. Damian Nicolau 101, Huamachuco. Mons. Sebastian Ramis Torrens, dtr.

Huancavelica: OAX5M *Radio Virgen de Carmen* 1580am (500 w) & OAX5M-FM 105.3 FM & OAX5X 4886 (800 w). El Obispado de Huancavelica. Virrey Toledo 468 o Apartado 92. Padre Samuel Moran Cardenas, dtr. Tel.: (51-64) 75-2989

Huanuco: OBX3I *Radio Luz y Sonido* 150Gm (1,000 watts), y OAW3A on 3235 khz (1,000 watts) y 105.7 FM. la diocese de Hunuco. Jr. Dos de Mayo 1286, Of. 205, Galerías de la Catedral. Telefonos: (064) 51-8500, fax 51-1985. E-mail: luz.sonido@hys.com.pe Senor Carlos Ortega Obregón, director. 0500-2100; Quechua 0500-0700 y 1800-2100. Website.

Jan: OAX2E *Radio Marañon* 580am (10,000 watts) y 96.1 FM (250 watts) y OCX2E on 4835 khz (1,000 watts). Ap. 50, Jaen, via Chiclayo. Francisco de Orellana 343, Jaen, Cajamarca. Senor Francisco Muguiron Ibarra, director. Telefonos: fax +51 44 731147 or 732168. Fax +51 44 732580. E-mail: correo@radiomaranon.org.pe 0500-2200, los sabados 0500-2100, los domingos 0600-1300 [probably local]. (en la diocese de Cajamarca).

Lima: OBX4I *Radio Santa Rosa* 1500am (10,000 w por los días, 5,000 w por las noches) y OCY4H 6045 khz onda corta (5,000 w). Apartado 4451, Lima 1, Peru. Padre Sokolich A., dtr. 24 hrs. Hay programas tambien en ingles y quechua.

Puerto Maldonado: OBX7J *Radio Madre de Dios* 1230am (1,000 watts) y 92.5 FM, y OAX7I on 4950 khz (5,000 watts). Calle Daniel Alcides Carrion, o Apartado 37, Puerto Maldonado. Telefonos: +51 (84) 511050. Senor Rufino Lobos Alonso, director. 0530-2100. En Quechua y otros lenguajes de los ndios.

Puno: OBX7B *Radio Onda Azul* 640am (10,000 watts) & OBX7C 4800 khz (1,000 watts) onda corta, & 95.7 FM. Cas. 210. Padre Jose Loits M., dtr. In Quechua and Aymara languages. 0400-2300. Tel.: +51 (54) 351562, fax 352233.

Quillabamba: OAX7M *Radio Quillabamba* 1210am (1,000 watts) y OAX7Q on 5025 khz (5,000 watts). Ap. 76, Quillabamba. Padre Francisco Panera, director; Seor Luis Verde L., ingeniero. 0500-2200; Quechua 0800-0930 y 1600-2000. (in la diocese de Cusco)

Rodriguez de Mendoza: OBX1M *Radio San Nicolas* 5470 khz onda corta (500 w) y 1390am (500 w-- cerrada) y OBX1M-FM 98.5 FM. Jr. Amazonas 114. Juan J. Grande, dtr.

Santa Cruz: *Radio La Inmaculada* 5305 khz onda corta (1,000 w); Parroquia de la Inmaculada Concepcion, Frente al Parque Central. Padre Jorge Carrasco, dtr. 1500-2130 horas.

Sicuaní: OAX7R *Radio Sicuaní* 1365am (1,000 watts), 91.1 FM (8 watts), y OAX7T on 4835 khz (1,000 watts). La Prelatura de Sicuaní. Jr 2 de Mayo 206, Sicuaní, Canchis, Departamento de Cusco; o Casilla 45, Sicuaní. Senor Mario Ochoa Vargas, director. 0430-2200; Quechua 0430-0600 y 1800-2200.

Sondor: *Radio San Francisco Solano* 4750 khz onda corta (1,000 w) y 89.1 FM. "La Voz de la Parroquia de San Miguel de Sondor y Sondorillo." Calle San Miguel 207, Sondor. Fundada en 1995.

Tarapoto: OAX9R *Radio San Martín* 4810 khz onda corta (3,000 w cerrada) y FM 97.5. Jr. Progreso 225. Fernando Tofu Arevalo, dtr.

Villa Atalaya: OAW8A *Radio San Antonio*. [no further info here] (Catholic Radio in the Americas June 7, SW only excerpted by gh/DX Listening Digest/Hauser-OK)

PHILIPPINES *Radio Veritas Asia* effective June 16:

0000-0025	Karen	11725
0000-0025	Sinhala	11820
0000-0025	Zomi-chin	11705
0030-0055	Bengali	11995
0030-0055	Hindi	11705
0030-0055	Tamil	11935
0100-0125	Telugu	15530
0100-0125	Urdu	15335
0100-0125	Urdu	17845
0100-0155	Russian	17830
0130-0225	Vietnamese	15530
1000-1025	Hmong	9555
1000-1155	Mandarin	9520
1030-1125	Vietnamese	11850
1130-1155	Burmese	9615
1200-1225	Indonesian	9505
1200-1225	Karen	9615
1230-1255	Kachin	9615
1300-1325	Vietnamese	7265
1330-1355	Hindi	9590
1330-1355	Sinhala	9520
1400-1425	Bengali	9540
1400-1425	Tamil	9520
1430-1455	Telugu	9535
1430-1455	Urdu	9670
1500-1525	Filipino	15360
1500-1555	Russian	11795
1525-1555	Filipino	15360
2100-2255	Mandarin	6190
2230-2255	Filipino	15240
2300-2325	Cantonese	11705
2300-2325	Indonesian	11820
2300-2325	Indonesian	9505
2330-2355	Burmese	11725
2330-2355	Kachin	11705
2330-2355	Vietnamese	9670

(Ivo and Angel! Observer, Bulgaria, June 11/DX Listening Digest/Hauser-OK)

QATAR A-02 schedule for *Radio Qatar* QRC in Arabic: 0245-2130 only on single NF 17755.2, ex 9570.2 (Ivo and Angel! Observer, Bulgaria, June 11/DX Listening Digest/Hauser-OK)

UNITED KINGDOM Here's a consolidated schedule for *BBC World Service* in English:

0000-0100	5970 5975 6195 7105 9410 9825 11835 11955 12095 15245 15280 15310 15360 17790
0100-0200	5975 6195 9410 9825 11835 11955 12095 15245 15280 15310 15360 17790
0200-0300	5975 6195 9410 9770 9825 11835 11955 12095 15245 15280 15310 15360 17790
0300-0400	5975 6005 6190 6195 7120 7160 9410 9770 11730 11835 12035 12095 15280 15310 15360 15420 15575 17635 17790 21660 21830
0400-0500	5975 6005 6190 6195 7120 7160 9410 11730 11835 12035 12095 15280 15310 15420 15575 17635 17640 17790 21660 21830
0500-0600	5975 6005 6190 6195 7120 7160 9410 11765 11835 11940 11955 12095 15280 15310 15360 15420 15565 15575 17640 17760 17790 17885 21660
0600-0700	6005 6190 7160 9410 11765 11940 11955 12095 15310 15360 15420 15485 15565 15575 17640 17760 17790 17885 21660
0700-0800	6005 6190 7160 11760 11765 11940 11955 12095 15310 15360 15400 15485 15565 15575 17640 17760 17790 17830 17885 21660 21830
0800-0900	6190 11760 11940 11955 12095 15310 15360 15400 15485 15565 15575 17640 17760 17830 17885 21470 21660
0900-1000	6190 6195 9605 9740 11760 11940 11945 12095 15190 15310 15360 15400 15485 15565 15575 17640 17760 17790 17830 17885 21470 21660
1000-1100	6190 6195 9605 9740 11760 11940 11945 12095 15190 15310 15360 15400 15485 15565 15575 17640 17760 17790 17830 17885 21470 21660
1100-1200	6190 6195 9740 11760 11940 12095 15190 15310 15360 15485 15565 15575 17640 17700 17760 17830 17885 21470
1200-1300	6190 6195 9740 11760 11940 12095 15190 15310 15485 15565 15575 17640 17700 17760 17830 17885 21470
1300-1400	6190 6195 9740 11760 11940 12095 15190 15310 15420 15485 15565 15575 17640 17700 17760 17830 17885 21470

1400-1500	6190 6195 9740 11940 12095 15190 15310 15420 15485 15565 15575 17640 17700 17830 17885 21470 21660
1500-1600	5975 6190 6195 9740 11940 12095 15190 15310 15400 15485 15565 15575 17700 17830 21470 21660
1600-1700	5975 6190 6195 7160 9410 9510 9740 11940 12095 15190 15310 15400 15420 15485 15565 17700 17830 21470 21660
1700-1800	5975 6005 6190 6195 7160 9410 9510 9630 9740 11940 12095 15400 15420 15485 15565 17830 21470 21660
1800-1900	5975 6005 6190 6195 9410 9510 9630 9740 12095 15400 15420 15485 15565 17830 21470
1900-2000	6005 6190 6195 9410 9510 9630 9740 12095 15400 15420 17830 21470
2000-2100	6005 6190 6195 9410 9630 11835 12095 15400 17830
2100-2200	5965 5975 6005 6190 6195 9410 9630 9740 11835 11945 12095 15400 17830
2200-2300	5965 5975 6005 6190 6195 7105 9660 11685 11835 12095 15400
2300-2400	5965 5975 6195 7105 9580 11685 11835 11945 11955 12095 15280 15400

(via Mike Terry/DX Listening Digest/Hauser-OK)

UZBEKISTAN Following stations are relayed via Tashkent for A02:

5945	1430-1530	<i>Democratic Voice of Burma</i>
9430	2300-0030	<i>TWR</i>
9865	1330-1445	<i>BBC</i>
9865	1500-1530	<i>BBC</i>
12065	1330-1425	<i>RNW</i>
12065	1450-1620	<i>Vatican Radio</i>
12075	1430-1625	<i>RNW</i>
13745	0100-0130	<i>BBC</i>
15235	1400-1430	<i>Radio Free Vietnam (Mo-Fr)</i>
15675	0400-1200	<i>Voice of Mesopotamia</i>
17690	1200-1230	<i>Radio Vlaanderen International</i>
21520*	1215-1300	<i>Voice of Tibet</i>
21650*	1435-1520	<i>Voice of Tibet</i>
21780	0800-0830	<i>BBC</i>

* Voice of Tibet frequencies are often changed to avoid jamming. Monitored alternatives: 21560, 21570, 21585. (Nikolai Rudnev—Russia) (Nikolai Rudnev—Russia) 

Pirate Radio Report

Chris Lobdell • P.O. Box 146 • Stoneham, MA 02180-0146 • clobdell@attbi.com

Hi and welcome to the July Edition of The Pirate Radio Report. I want to welcome contributions from our new reporter Joe Wood of Gray, TN. Pirate radio activity has been way down recently. This and the high static levels have made listening tough. Don't give up though as I expect activity will continue through the summer.

Pirate Radio Popularity Poll!

Don't forget to send in your vote for the best and worst pirates that operated during 2001. I will tabulate the votes in time for the August issue of the *Pirate Radio Report*. Send in your votes today.

Pirate CDs Still Available.

In case you were wondering, my two pirate CD collections in the MP3 format are still available.. Remember these are in MP3 format. You must have a CD player or drive that can play this type of format to use these CDs.

1. **Radio Azteca**-Programs 1 thru 25. Listen to Bram Stoker from his humble beginnings in 1992 until 1998 in this compilation. A must for the dedicated pirate fan.

2. **K2000**-The Complete Collection.

This CD contains all eight known programs produced by Bob Rock and crew.

Also included are a few comedy bits that were never aired. K2000 set the standard for comedy and satire in the SWL-pirate DX community in the 1990s.

Each CD is now priced at \$7.00 postpaid in the USA. Send cash our postal money order to the Stoneham post office box address. Outside the USA, write for pricing.

Now, on to this month's logs. Many thanks go to contributors Rich D'Angelo-PA, newcomer Joe Wood-TN and pirate DXpert George Zeller in Ohio.

Alfa Lima International. The Dutch Pirate station was noted on 15069.7 kHz on June 2nd from 0045-0054 sign off with a long talk in English by Alfred, thanking listeners for tuning in and signing off. [D'Angelo-PA]

Captain Morgan. Logged on May 30th at 0219 past 0226 UTC on 6950 kHz in the AM mode. Music by Sheryl Crow, Jimi Hendrix and The Eagles. Strong and clear signal. [Wood-TN]

Ground Zero Radio. This station was logged on May 26th at 0349 UTC past 0412 UTC on 6950 kHz USB. Good signal with several bits about Civil Defense precautions in the 1960s, bomb shelters, etc. Audio clips from the movie Dr. Strangelove. The use the P.O. Box 109, Blue Ridge Summit, PA 17214 maildrop. [Wood-TN]

Psycho Radio. 6955 kHz USB on May 22nd from 0401-0430 sign off. Announcer said "If It Blows Up, We Fix It". I think he was referring to the transmitter! Male announcer talked about a defunct email address but didn't give any contact info. [Wood-TN]

Radio Bingo. Noted on 6954.8 kHz on June 3rd from 0042-0114+. Bingo songs, bingo card rules, featuring a cameo appearance by Sal Amoniac Also included Jimmy The Weasel singing his Top 20 Pirate Hit "God Damn You". [Zeller-OH].

WHYP-The James Brownyard Memorial Station. This has to be the most active pirate this year. Heard on May 22nd at 0234-0244 on 6950 AM with Captain Ganja's Top 10 List signing off with "Bozo Rules". [Wood-TN] Also noted on May 31st at 0159 UTC until 0303 sign off with the "Who Wants To Be A Pirate Radio Operator" parody. Croquet Tournament [not to be confused with the chicken croquettes at the Kulpville Kitchen] on 6950 AM mode. [Wood-TN] Also on June 1st from 0111-0151* on 6950.8 kHz. A WBZP interview with Jay "Bozo" Smilkstein. [Zeller-OH]

Happy Pirate DX!



QSL Report

Sam Barto • 47 Prospect Place • Bristol, CT 06010

Scandinavian Weekend Radio

Vera, Finland
 Name: John L. Sgrulletta
 Date: 6th April 2002
 Time: 05.26 - 05.57 UTC
 Freq: 1720 kHz
 SINPO: 22212
 QSL No: 265.
 Signed: *Frcin*

hmmmm...
 Sounds too free
 to be legal...



Thanks for your reception report
 and keep on listening

Ptr. Reyes Baltazar Quispe, Director. Finally verified Bolivia after years of trying. (Brouillette-IL)...good going...Sam.

BONAIRE: Radio Vlaanderen International 13700 and 15565 f/d "Brugge 2002 Buildings" cd. in 19 ds. for 1 IRC. (Brouillette-IL). Deutsche Welle 11985 cd. in 3 wks. w/ pocket guide. (Field-MI).

BOTSWANA: Voice of America 11835 ltr. w/ VOA/IBB newsltr. direct from

the site in 96 ds. for 1 IRC. v/s Gabriel Tjitjo, Assistant Transmitter Plant Supervisor. (Barbour)

BRASIL: Radio Trans Mundial 11735 f/d "Antenna Dish" cd.

w/ schedule, ltr. and bookmarker in 581 ds. for a PT rpt., tape and \$2.00. (Willshaw-NC).

BURKINA FASO: Radiodiffusion Television du Burkina 5030 nice p/d form

ltr. w/ station seal in 36 ds. for a FR rpt. and \$1.00. v/s Tahere Ouedraogo, Chef de Service des Programmes. Quite happy w/ this QSL. (Brouillette-IL).

CANADA: China Radio International 9790 cd. in 6 wks. w/ station pennant personal note and sticker. (Field-MI). Radio Canada International 9515 and 17820 via Sackville f/d "Fessenden/Marconi" cd. w/ schedule, sticker and



TUNE INTO WHP RADIO 1620 AM

via Sgrulletta

IN ST. CROIX U.S. VIRGIN ISLANDS

10,000 WATTS OF POWER IN THE CARIBBEAN

Certificado de Sintonía

Radio Cusco

PERU

Estimado Sr. John Sgrulletta:

Muchas gracias por su informe de recepción. Tenemos el gusto de confirmar su control de nuestra emisión en 6193.7 kHz. de fecha 28-03-2002 a las 04.33-04.55 horas de PERU con 7 kW. vatios de potencia.

ECO MUSICAL F.M.
 RADIO CUSCO S.A.

[Signature]
 Lic. 7 de 1981 del Poder Judicial
 GERENTE
 firma

RADIO CUSCO S.A.

[Signature]
 sello oficial

plastic pennant in 26 ds. v/s Bill Westenhauser. (Barbour-NH) **Radio Korea International** 9560 and 9650 via Sackville beautiful cd. featuring the "World Cup" in 2 mo. Also rcvd report forms & schedule. (Field-MI).

CANADA (Pirate):

Happy Hanukkah Radio 6925 f/d "Hanukkah Highlights" sheet w/ part of a Manischewitz Grape Matzo Box in 155 ds. for \$1.00. My rpt. was sent to the Merlin drop. Rcvd. personal note signed by P. Judah who said they were the only Jewish pirate that they knew of. (Wilkins-CHINA, PEOPLES REPUBLIC OF: **China National Radio** 15550 and MO).

Date	Time Heure UTC	kHz
21 May		15200, 17630,

2001	1453-1443	17820
------	-----------	-------

Program details / Résumé de l'émission

15200: Vienna relay (Austria)

17630: Hörby relay (Sweden)

17820: Westachtal relay (Germany)

Name / Nom

Marle Alexander Humenyk

Address / Adresse

26 Crestridge Heights Road

Weston, ON M4P 1A4

CANADA

Radio Canada International
P.O. Box 6000/C.P. 6000
Montréal, Canada
H3C 3A8

On December 17th, 1991, Guglielmo Marconi received the first transatlantic radio signal at Signal Hill, in St. John's, Newfoundland. Just a year before, on December 23rd, 1990, the Canadian inventor **Reginald Fessenden** became the first person to transmit the human voice via radio. This QSL card commemorates these important achievements in the history of radio.

Radio PANZENU

Radio con calidad

1.010 KC

MONTERIA-COLOMBIA

Michael at Postfach 196, 65409 Russelheim, Germany in 1 yr. after a * f/up rpt. (Field-MI). **Afghani Air Space / Commando Solo** 8700 (USB) n/d e-mail w/ plane and eagle graphics in 11 wks. v/s Lt. Edward E. Shank, Chief of Public Relations. (Sgrulletta-NY)... My old Radio Discovery 1035 kHz. QSL from the Haiti intervention was signed by Col. Rambo. Hi. * ... Sam. **Falun Dafa Radio** 9945 my rpt. was sent to the GA addr. was returned by the * USPO. (Field-MI). **De-jen Radio** 12120 via **Samara** p/d blue "Tower and Logo" cd. in 3 mos via the Transmitter Documentation Project.

NOTES: Fred Willshaw says its been quite a while since his last report to the QSL Column. Fred hope to get his rig up and running this summer with the main goal getting the DX Centurian Award. Only 6 more countries to go. **Wendel Craighead** sent a thank you e-mail to Tony Leo and Charlene John for the Radio Saint Helena QSL. His initial report was returned by the St. Helena P.O. marked unknown. I mailed the report again. Apparently the P.O. was returning mail to ZHH. Charlene got the situation corrected.

17565 f/d "CNR Building" cd. in 19 ds for 2 IRCs. (Barbour-NH).

CLANDESTINE: Radio Kurdistan / Voice of

* **the People of Kurdistan** 4130 f/d prepared cd. w/ standard f/d ltr. in 15 mos. Station listed **Sulaimani** as the transmitter site. Report was sent to the P.U.K. address in Berlin. This was for a taped rpt., SASE and ms. (all were used). v/s Dara Gafari. (Sgrulletta-NY). **Voice of Democratic Eritrea** 15365 ltr. from Seyoum O.

High Adventure Ministries

GLOBAL BROADCASTING NETWORK

via Humenyk

Voice of Hope MI/SOLE EAST

Frequency 15.715

Date of reception April-22-01

Time of reception various (UTC)

Thank you for reception report. For information about the frequencies on our net please visit us at our website listed below

CFRX-CFRB QSL

Thank you for sending us your reception report which we are pleased to confirm.

via Barbour
CFRX SHORTWAVE

6.070 MHz 48 metre band
Carrying CFRB's programs 24 hrs/day
1,000 watts - omni-directional antenna

CFRB AM 1010

1010 kHz mediumwave
50,000 watts - directional antenna

DATE: Dec 21-2001

TIME: 12:14 → 12:42 a.m.

Signed: *Heather Conway*
Ontario DX Association

Official QSL Manager:
Ontario DX Association
P.O. Box 181, Station A
Wilketta, Ontario, Canada M2W 5S8
Tel: (416) 291-1234
Fax: (416) 291-1234
E-mail: info@ontario-dx.com
Web: www.ontario-dx.com

Station Address:
CFRB Radio
2 St. Clair Ave. West
Toronto, Ontario, Canada M4V 1L8
Main Switchboard (416) 804-5711
CFRB Access Line (416) 872-CFRB
CFRB Newsline (416) 804-8717
CFRB Talk Shows (416) 872-1018
Toll Free 1-800-561-CFRB
Fax (416) 323-8830

v/s Ludo Maes. (Craighead-KS).
CUBA: Radio Habana Cuba 9820 f/d
"Club DX" cd. w/ schedule and
report forms and a personal ltr.
in 135 ds. for \$1.00. v/s Lourdes
Lopez, Head of the Correspondence
Dept. (Barbour-NH).

CYPRUS: Cyprus Broadcasting Corporation
7205 and 9760 f/d "CYBC
Logo/Building" cd. in 22 ds. for
1 IRC. (Barbour-NH). **British
Broadcasting Corporation** 9410
via Merlin f/d ltr. in 8 ds. for
1 IRC. v/s Michelle Franks, Internal
Communications (Barbour).

ECUADOR: HCJB 11755 and 11960 f/d
and religious materials in 18 ds. for 1
IRC. (Barbour-NH). **Electronic DX Press** 9745 via HCJB cd. in 1 mo.
v/s Bob Padula. (Field-MI).

EUROPEAN RUSSIA: Radio Vaticana 6205 via Irkutsk f/d cd. in 77 ds. (Glo-

* tzbach-NM)...my boo boo...should be Asiatic Russia...Sam. **RWM** 9996
Russian State Time and Frequency Service f/d cd. in 728 ds. (Glotz-

EURO PIRATE: European Music Radio 9290.5 (Holland) f/d cd. bach-NM).

* w/ station history and generic thank you ltr. in 38 ds. for \$2.00.

* Addr: P.O. Box 2702 not 2727. (Sgrulletta-NY). **Scandinavian Weekend
Radio** 11720 (Finland) f/d cd. w/ postcard, travel brochure, poster
and a T shirt offer in 15 ds. for \$2.00. Also rcvd.
7 stickers. (Sgrulletta-NY).

NOTES: Jerry Klinck says the QSL picking are sparse.
Hope it picks up a bit...Sam. **John Sgrulletta** sent
in some very nice illustrations for the Column.
They will appear in a later issue...Sam. **Paul Brouillette**
recently verified 2 new countries including
Bolivia and Burkina Faso. He was amazed at the prompt
reply...Sam.

FRANCE: Radio France International 25820 no QSL but

I did rcvd. "RFI Logo" pen
and a bandana in 94 ds. for a
correct answer to their "Club
9516" Contest regarding the
2002 Winter Olympics. (Barbour).

FRENCH GUIANA: China Radio International
9730 f/d cd. in 6 wks.
(Field-MI).

GERMANY (East): Deutsche Welle 21590 via Nauen
f/d cd. in 1 mo. (Field-MI).

GERMANY (West): Croatia Radio 9925 via DTK Julich
f/d "Station Drawing" cd. w/ ltr. and schedule
in 648 ds. v/s Dane Pavlic. (Willshaw-NC). cd. w/
schedule in 3 mo. (Field-MI).

Deutsche Welle 21840 via Wertachtal f/d cd.

in 2 mo. (Field-MI). **Swiss Radio International**
13790 via DTK Julich f/d cd. in
1 mo. (Field-MI). **High Adventures Mini-**

stries 15715 via DTK Julich ltr. w/
religious materials in 67 ds. for 1
IRC. (Barbour-NH). **WYFR** 13855 via DTK
Julich f/d cd. w/ site, calendar and
schedule in 1 mo. (Field-MI). f/d cd.
w/ schedule and stickers in 110 ds.
for 1 IRC. The QSL was mailed from
Oakland, CA but my rpt. was sent to
DTK. (Barbour-NH).

GREECE: Voice of Greece 12110 cd. in 1 mo.
w/ tourist info. and report form. (Field).



**RADIO
PRAGUE**

via Barbour



RADIO VATICANA





via PLAY DX

To: MR. ANKER

We are glad to confirm your SWL report

On: 2nd MARCH

At: 05:25 GMT

FREQ: 3903 kHz

Keflavik

LJ1400KHZ

H5fm

With Best Regards,

Big Sam

GUATEMALA: Radio Verdad

4052.5 f/d "Man on Antenna" cd. w/ pennant and station info. in 21 ds. for \$2.00. Also rcvd. a personal ltr. from v/s Dr. Edgar Amilcar Madrid, Manager. (Barbour-NH).

HONDURAS: Radio Litoral

4832 rcvd. 2nd QSL for my April 2001 rpt. (Brouillette).

IRAN: Voice of the Islamic Republic of

Iran 9890 f/d "Khaju

Bridge" cd. w/ personal ltr. and 6 books/magazines in 81 ds. for 2 IRCs. (Barbour-NH).

JAVA: Voice of Indonesia 9525 cd. w/ postcards and personal notes in

NOTES: Richard Lawrenson of 28 Carl Drive, Tiverton, RI 02878 would like any assistance in obtaining a QSL from Radio Saint Helena. It seems that his reports haven't gotten to the station....Sam.

656 ds. (Glotzbach-NM). 15150 f/d "Mount Kalimantan" cd. in 26 mos. (Sgrulletta-NY).

MALAGASY REPUBLIC: Voice of Hope 12060 via

Radio Nederlands f/d cd. in 3 wks. (Lawrenson-RI). Deutsche Welle 17800 f/d cd. in 26 ds. (Glotzbach-NM).

MEXICO: XEOI Radio Mil 6010 f/d "Globe" cd. w/ ltr., sticker and a calendar in 503 ds. for a SP rpt., tape and \$2.00. v/s Hector Garcia Bojorge. (Willshaw-NC). XERMX Radio Mexico International 9705

RDP Internacional

Radio Portugal

f/d "RMI Verificacion de Sintonia" cd. w/ ltr., schedule pennant and a music CD in 498 ds. for a SP rpt., tape and \$2.00. v/s Ana Cristina del Razo Esqueda. (Willshaw).

NORWAY: Radio Denmark p/d cd.

w/ schedule in 52 ds. for a DN rpt. and 3 ms. (McGuire).

PERU: Radio Santa Rosa 6045 f/d

cd. in 5 wks. for a taped rpt. and ms(not used). v/s

Juan Sokolich A., Op. Director. (Sgrulletta-NY). Radio

Cusco 6193.7 f/d prepared cd. (George Maroti's design) via

Carlos Gamarra Moscoso of

Radio La Hora for a taped rpt., ms.(used) and \$2.00.

in 3 wks. v/s Lic. Yoklin Siu Olivera, Gerente. (Sgrulletta-NY). Radio del Pacifico

9674.8 ltr. in EG w/ 2 calendars and an audio tape

in 419 ds. The QSL arrived via Charlotte, NC. (Glotzbach-NM).

PHILIPPINES: Radio Veritas Asia

9505 f/d "Year of the Family" cd. w/ newsltr. and report forms in 34 ds. for 2

IRCs. v/s Cleofe R. Labindao, Audience Relations Officer. (Barbour-NH).

PORTUGAL: Radio Portugal 21830

尊敬的 GEORGE L. GLOTZBACH 先生:

您好!

您和您的朋友在百忙之中给我们寄来的关于 6937kHz 收听信息反馈资料已经收到, 感谢您为此关心中国云南人民广播电台民族语言广播, 盼望继续得到你们的关注并欢迎宝贵意见。

为便于您和您的朋友收听我台的民族语言广播, 我们除给您简要介绍一下我台民族语言广播的基本情况:

云南是中国最边远的边疆民族省份之一, 在这里共同生活着 26 种民族。云南人民广播电台民族语言广播开播于 1955 年, 现办有稳定傣语、西双版纳傣语、傣语、景颇语、佤语等五种少数民族语言广播。使用频率为中波 1242kHz, 短波 6937kHz 以及卫星传送等。播出时段为北京时间每天早上 7:00 时—11:00 时。下午 14:30 时—16:35 时(卫星传送)。晚上 19:00 时—23:00 时(每天播出顺序见附表)。各语言节目主要由新闻、专题、文艺节目三部分组成。主要报道国内外消息, 各民族多姿多彩的传统文化艺术, 别具一格的民风民俗以及令人神往的民族旅游资源, 特色鲜明的民族音乐、舞蹈、节庆活动等。

再次感谢您的来信

祝福您和您的朋友好运

中国 云南人民广播电台民族语言频率

王成才

2002年3月25日

地址: 中国 云南省昆明市人民西路 182 号

邮政编码: 650031

EUROPEAN MUSIC RADIO

QSL

BROADCASTING-
FROM: EUROPE
TO: EUROPE

To JOHN SGARULLETTA ADDRESS: E.M.R.
P.O. BOX 2727,
6049 ZG,
HEKTEN
NETHERLANDS
C.M.T. 04-49 to 05-36
DATE 30th MARCH 2002
BAND 31 METERS
ANTENNA DIPOLE
TX POWER 100 WATTS UK

E.M.R.
P.O. BOX 2727,
6049 ZG,
HEKTEN
NETHERLANDS



BEST WISHES TO YOU
FROM US

FFFR

GOOD LISTENING

cd. in 2 mo. w/ personal ltr. and a tourist magazine. v/s Isabel Saraiva. (Field-MI).

ROMANIA: Radio Romania International 11940 cd. in 6 wks. w/ schedule. (Field-MI).

SAIPAN: KFBS Far East Broadcasting Company 11580 f/d "Island Photo" cd. w/ schedule and station history in 62

ds. for 1 IRC. v/s Beverly Brubaker, QSL Dept. (Barbour-NH).

SAINT HELENA: ZD7RSD Radio Saint Helena 11092.5 f/d red, blue and black on white "Logo" cd. in 31 mo. The QSL was 364 ds. on route. (Craighead-KS). p/d "Coat of Arms/Logo" cd. in 942 ds. for their last transmission in October 99 for \$1.00. v/s Tony Leo. (Brouillette-IL).

SEYCHELLES: BBC WS 11730 via Merlin Communications p/d ltr. in 58 ds. for \$1.00. v/s Barrie Elding, Resident Engineer. Addr: Merlin Communications International, Indian Ocean Relay Station, P.O. Box 448, Victoria, Mahe. (Brouillette).

SLOVAKIA: Radio Slovakia International 5930 f/d "1735 Bratislava" cd. in 129 ds. for 1 IRC. (Barbour).

SPAIN: China Radio International 9690 f/d cd. in 6 wks. (Field-MI).

SRI LANKA: Sri Lanka Broadcasting Corporation 15425 via Ekala p/d ltr. w/ schedule and info. sheet. Very impressive

letterhead. It took 5 wks. (Lawrenson-RI).

SWITZERLAND: Swiss Radio International 9885 via Sottens f/d "Swiss Scenes" cd. w/ site in 39 ds. for 1 IRC. (Brouillette-IL).

TAIWAN: Adventist

* World Radio 15490 via Pao-chung f/d cd. w/ site in 3 mos. (Craighead-KS).

US VIRGIN ISLAND

* WDHP 1620 rcvd. in 1 wk. 2 mos. later I rcvd. f/d prepared cd. w/ bumper sticker for SASE(used) (Brouillette-IL)

VATICAN: Radio Vaticana 9605 f/d "Antenna" cd. in 56 ds. for 1 IRC.

Not enough reports to justify another page - however, there are some very good ones.

See you all next month.

TARJETA DE VERIFICACION

Sr. JOHN L. SGARULLETTA

Confirmamos su recepción de fecha 15 / 02 / 2002 de nuestra Emisora, RADIO "Santa Rosa", en la frecuencia de 6045 KHz ONDA CORTA; en la banda de 49 Mts la que está correcta y conforme a la programación de ese día.

Lima, Perú 03 / 04 / 2002

P. Juan Sokolich A., O.P.
P. Juan Sokolich A., O.P.
DIRECTOR



<http://peru.op.010/Radio-Santa-Rosa/default.htm>

Net Notes

Tom Sundstrom • P.O. Box 2275 • Vincentown, NJ 08088-2275 • Fax: 609-859-3226 • trs@trsc.com
<http://www.trsc.com>

From Bob Coomler, W6RJC:

"I'm a NAWSA member and probably one of their greatest lurkers. We both had our pictures published by Hank Bennett in Popular Electronics several semesters back to illustrate how long and low my profile really is!

"I just found this site which may be of interest to you (if you haven't seen it) and NAWSA members.

<http://antenna.be>

"It is devoted to shortwave broadcast antennas and, though not a huge site, does give rather good non-technical descriptions along with illustrations/photographs of the main flavors of broadcast antennas. I'm sure many folks have never seen most of these."

Thanks for the info, Bob. In the process of cleaning up the desk I filed the copy of Hank Bennett's article; I think it was in late 1960. It will turn up. I have been burning the candles in this hobby for more than 50 years now.

Propagation

Another comprehensive all-in-one "Real Time Space Weather" page has appeared on the Web. It is a compilation of images from Spaceweather, the CCD cameras aboard SOHO and various observatories around the earth. A large image or page is displayed upon clicking on a thumbnail image or link. I don't know who assembled this page, but it appears to be someone associated with a Web source provider in Minnesota, USA; the page loads quite quickly. Check it out at <http://www.visi.com/~brainiac/solar/>.

Internet Broadcasting

The Mauritius Broadcasting Corporation audio links at <http://mbc.intnet.mu/> seem to be destroyed.

There are interesting games played by the VOA. It appears that VOA News-Now is blocked to USA domains, but the hip-hop VOA MusicMix music is not. If the music is your style — it is commercial-free — dial up <http://www.voamusicmix.net/> and have a listen.

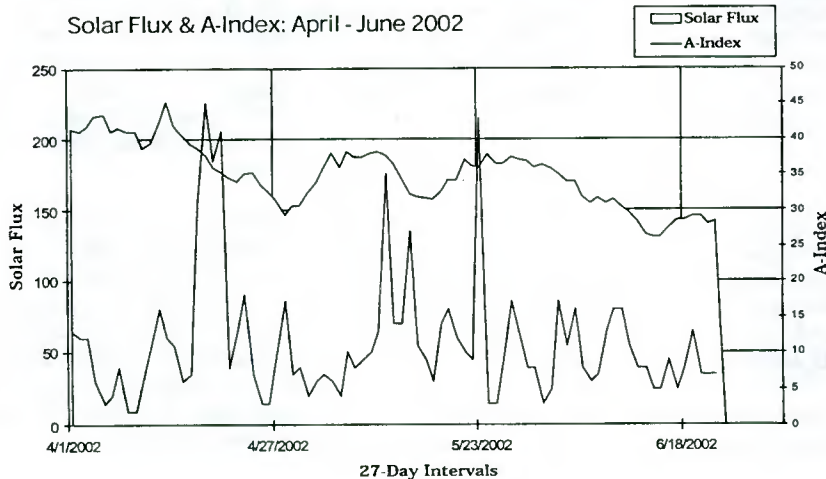

Country List Committee Report

Don Jensen • 5204 70th Street • Kenosha, WI 53142 • dnjkenosha@acronet.net

Recently, the NASWA Country List Committee received an email from a Greek DXer who offered several observations:

"I noticed that the European section does not include the following two countries SLOVENIA and the FORMER YUGOSLAV REPUBLIC OF MACEDONIA (F.Y.R.O.M.), both independent states since 1991," he wrote.

"I also would like to mention that the inclusion of GREECE-RHODES (Dodecanese Islands) in the Asian section instead of the European is not correct to my opinion. By geographical terms, all the Aegean Islands are part of Europe. Even by political terms, the Dodecanese Islands were under Italian sovereignty from 1923 (Treaty of Lausanne) to 1947 and are part of Greece since the 1947 (Treaty of Paris)."

The CLC thanks this listener for his comments. We always appreciate hearing from NASWA members and other list users. We take these communications seriously and consider them carefully, as we did in this case.

Our Greek friend, whose name, unfortunately, we do not know, noted that two countries in Europe do not appear in the list, that is, Slovenia and Macedonia, known officially (and a bit ridiculously) by the cumbersome name Former Yugoslav Republic of Macedonia.

Except for one fact, both probably already would have been included in the list, for they both seem have suitable political and geographical characteristics to qualify as radio countries. The one factor that disqualifies them, however, is a lack of shortwave broadcasting activity and SW transmitting facilities within their borders.

A basic rule of the CLC is that to be listed among the radio countries, an entity must

have or have had actual SW stations and broadcast transmissions. The committee consulted with Ludo Maes, a widely recognized authority on SW transmitter locations, and he confirms that no such facilities exist or existed in Slovenia and Macedonia.

Obviously, should that situation change in the future, should either or both Slovenia and Macedonia begin broadcasting on SW, the CLC will take another look at the situation and give favorable consideration to adding them to the Country List.

Our email correspondent also suggested that the island of Rhodes, Greek territory not far off the Turkish coast, should be numbered among Europe's countries, rather than Asia's, where it has long been in the NASWA list. For the benefit of newer DXers, years ago the Voice of America began broadcasting from Rhodes, first from an anchored ship-board station within territorial waters and later from shore-based transmitters.

The CLC notes that the Rhodes situation is a much closer call. It recognizes that Rhodes has strong political and cultural ties with Greece, and Greece surely is a European country. It also recognizes that geographically, the island is much closer to Turkey (Asia) than Greece (Europe). It is irrelevant to the committee that collectively the Aegean islands are geographically considered to be European, since we are only concerned with one particular island of this grouping, Rhodes.

Arguably, many years ago, the committee might have opted to assign Rhodes to the European, rather than the Asian section of the list. It did not, for the same reason that it did not assign the Falkland Islands, with cultural and political ties to Great Britain, to Europe, but rather listed it among South American countries to which it is more closely linked geographically.

The key question is whether there is good reason now to change the Rhodes decision made years ago.

The committee noted that to change Rhodes from Asia to Europe in the list might alter individual country counting records and previously issued awards. The majority of the committee members felt that there would be no good purpose served by now changing one arbitrary decision for another. As one committee member phrased it, such a move now would seem to be "a solution looking for a problem."

I should stress that in retaining the status quo; the committee should not be seen as taking sides in a longstanding political rivalry between Greece and Turkey. No political motivation should be read into the committee's decision.

The CLC is always happy to hear from those with comments and questions about the NASWA Country List.

Don Jensen, CLC Chairman



Contributors' Page

Bob Montgomery • P.O. Box 1458 • Levittown, PA 19058 • RMonty3@worldnet.att.net

DEADLINE FOR CONTRIBUTIONS IS THE 10th OF THE MONTH

The following members sent in contributions:

Brian ALEXANDER, Mechanicsburg, PA	NRD-545 AOR AR-7030 100' LW
Sean BARBOUR, NH	ATS 818, RS antenna system
Jerry BERG, Lexington, MA	R8A 165' LW
Ralph BRANDI, Tinton Falls, NJ	AOR7030, R8, 250' longwire
Paul BROUILLETTE, Geneva, IL	Drake R8, ICF2010, 60' long wire
Rich D'ANGELO, Wyomissing, PA	Drake R8B, Lowe HF-150, DX Sloper
Jerry LINEBACK, Scranton, KS	Icom 746 beverage antennas
William McGUIRE, Cheverly, MD	DX-380
Bob MONTGOMERY, Levittown, PA	NRD535D, R390A, RX-320, HF150, SE3, active antenna
Ed NEWBURY, Kimball, NE	WJ-1000, R8, 60' sloper, 20' loop
Mike PACE, Tipton, IA	Drake SW2, MFJ1022
Stephen PONDER, Houston, TX	No equipment listed
Gerald WITHAM, Keaau, HI	R8, 185' split LW, ANC-4

Hope one and all had an excellent 4th. We could use a few more contributors. Shortwave works at the beach and some interesting programs are available. So send a couple loggings this way and have a super summer!

73

Bob Montgomery



Tropical Band Loggings

Dan Ferguson • 12053 Kahns Road • Manassas, VA 20112 • troplogs@zerobeat.org

- 2310 AUSTRALIA ABC 6/8 1108 faint music but low noise, //2325 & 2485, all poor. (Lineback-KS)
- 3205 BRAZIL Radio Ribeiro Preto 5/11 0035 choral singing with male vocalist speaking over top in Portuguese, church music, seeming commercials and church information with phone numbers, mention of Ribeiro Preto @ 0058, more talk. (Brandi-NJ)
- 3205 NEW GUINEA R.Saundau 6/7 0943 M in EE talk, poor; not hrd Jun 8. (Lineback-KS)
- 3220 ECUADOR HCJB 6/7 0942 M in SS talk, fair. Not hrd 6/8. (Lineback-KS)
- 3235 NEW BRITAIN R.West 6/7 0941 M in vern tlk, vy poor. Not hrd 6/8 (Lineback-KS)
- 3245 PAPUA R.Gulf 6/8 1045, M in Vern talk, poor. (Lineback-KS)
- 3260 NEW GUINEA R.Madang 6/8 1043 M in Vern, Vern pops; fair with limited audio range. (Lineback-KS)
- 3265 SULAWESI RRI Gorontalo 6/8 1044 M in Indo, poor. (Lineback-KS)
- 3270 NAMIBIA NBC (presumed) 5/2 0511-0525 EE news by YL, mentioned Congo, Liberia. Weak & noisy. (Barbour-NH)
- 3275 PAPUA R.Southern Highlands 6/8 1042 EE pops, F-G. (Lineback-KS)
- 3291 ECUADOR R.Centro 5/22 0813-0832 SS, mx, anmts, several IDs; F-P.(Barbour-NH)
- 3291 GUYANA V.Guyana 5/10 0310-0402 EE, EZL mx, ID 0329; W w/obituaries, and "messages" pgm; ID 0400 w/freqs, into BBC nx relay. F-P.(Barbour-NH)
- 3305 PAPUA R.Western 6/8 1041 M in Vern, Vern pops, poor. (Lineback-KS)
- 3310 BOLIVIA R.Mosoj Chaski 5/22 0034-0115 LA mx & talk, anmts, many IDs by YL; solid ID 0052; poor but improving.(Barbour-NH)
- 3315 ADMIRALTY IS R.Manus 6/7 0935 M in long EE talk, poor. (Lineback-KS)
- 3325 BOUGAINVILLE R.Bougainville 6/8 1109 M in Vern, Vern singing, Vern IDs mentioning Bougainville, into EE C&W, good. (Lineback-KS)
- 3325 GUATAMALA R.Maya 6/8 1040 SS ballads, good. (Lineback-KS)
- 3345 MOLUCCAS RRI Ternate 6/8 1040 Indo pops, poor. (Lineback-KS)
- 3350 COSTA RICA REE Cariari 5/19 SS talk, brief mx bridges at 0335; fair, better on file://6020. (Berg-MA)
- 3355 NEW GUINEA R.Simbu 6/7 0938 M in Vern talk, very poor. (Lineback-KS)
- 3366 GHANA Ghana BC Corp 4/30 2338 EE, Afro pops, R.Ghana ID 2345, African news, commentary, YL ID as "Radio 2", freqs weak & noisy. (Barbour)
- 3375 NEW GUINEA R.Western Highlands 6/8 1038 M in Vern, Vern pops, fair-poor. (Lineback-KS)
- 3905 NEW IRELAND RNI 6/8 1037 M in Vern, good. (Lineback-KS)
- 4753.3 SULAWESI RRI Makassar 6/8 1105 M&W in Indo, good. (Lineback-KS)
- 4789.1 IRIAN JAYA RRI Fak-Fak not hrd since May 8 (Lineback-KS)
- 4799.8 GUATEMALAR.BuenasNuevas/100211MinMayanrlgt1k.Quitegood.(Brouillette-IL)
- 4815 BRAZIL R.Dif Londrina 5/22 0200 PP, pop ballads, some folk mx, ads, ID's;. (Brouillette-IL)
- 4820 BOTSWANA R.Botswana 5/19 tone on at 0240, distinctive bovine IS at 0245, religious program 0300. Poor. (Berg-MA)
- 4830 VENEZUELA R.Tachira 5/19 religious prgmng arnd 0130, but classic YV mx from 0200, animated talk by man, finally got some ments of Tachira at 0220. LSB necessary due to Litoral-4832 which was much stronger (and which IDed twice for 4830 at 0230). (Berg-MA)
- 4845 MAURITANIA Radio Mauritanie 5/15 0049-0102* AA, AA mx & talk, NA at s/off; good.(Barbour-NH) 0054-0100* man with Koran recitations until another man with Arabic ID and apparent sign off announcement followed by instrumental music national anthem. Good signal 6/2. (D'Angelo-PA)

- 4874.6 **IRIAN JAYA RRI Sorong** 6/8 1104 M in Indo nx, poor. (Lineback-KS)
- 4875 **BRAZIL Radio Difusora** 5/27 0035-0408* man announcer with Portuguese talks hosting program of Big Band music. Apparent sign off at 0407 after ID. Poor. (D'Angelo-PA)
- 4890 **PAPUA National Radio** 6/8 1048 EE pops, good. (Lineback-KS)
- 4915(p) **BRAZIL R.Anhanguera** (p) 5/10 0227 PP, Icl nx incl phoned in correspondents reports, political tlks. Ments of São Paulo and Brazil. No solid ID, but tentative passing ments of "Anhanguera". (Brouillette-IL)
- 4976 **UGANDA Radio Uganda** 6/9 0354-0420 pop and rap music songs until male announcer with ID and news at 0415. Poor to fair. (D'Angelo-PA)
- 4976 **UGANDA R.Uganda** (p) 5/19 fairly good with light African mx 0325 overpowering whatever it was hetting on 4975. Very weak signal on 5026 as well, but Cuba too strong there. (Berg-MA)
- 4980 **VENEZUELA Ecos del Torbes** 5/22 0353-0357* SS s/off routine w/freq, time, ment "Venezuela de Nacional", NA(?)@s/off; fair.(Barbour-NH)
- 4985(p) **BRAZIL R.Brasil Central** (p) 5/10 0240 PP, older ballads w/ M DJ. Low modulation. (Brouillette-IL)
- 5009.8 **DOM REP R.Cristal Internacional** 5/19 0220-0240* Lively LA mx. SS anmts, IDs. S/off with NA. Very good. (Alexander PA)
- 5010 **DOM REP R.Cristal Int'l** 4/30 2325 SS talk, baseball scores, ID 2330; LA & EZL music. Fair-poor.(Barbour-NH)
- 5010(p) **HONDURAS HRMI 0240-0254** 5/19 presumed with continuous rel mx. Heard only during this 14 minute window. Audible after Dom Rep s/off at 0240. But covered by a strong Madagascar at 0254 s/on. (Alexander PA)
- 5010 **MADAGASCAR R.Madagascar** (p) 5/19 0315 religious choral singing, man talking in Malagasy-sounding lang.; pretty good signal for them, and Cristal/Pueblo-5009.8 already gone by this time. (Berg-MA)
- 5010.04 **MADAGASCAR RTM** 5/19 *0254-0335+ s/on with IS; anthem at 0258; short Vern anmt & into church service with lcl rel mx, Vern sermon. Rel recitations. Very good. (Alexander PA)
- 5019.9 **SOLOMON ISLANDS SIBC** 5/20 0949-1012 man reporting on Solomon Island Football Federation. Nice ID at 0958 by a man: "This is the National Service of the Solomon Islands Broadcasting Corporation, Radio Happy Isles coming to you from our studios in Honiara. Radio Happy Isles, keeping you informed of news from around the world." A man gave the news in English. Fair reception. (D'Angelo-PA)
- 5020 **SOLOMON IS SIBC** 6/8 1056 Vern pops, OM in Vern/EE, OM in EE w/religious talk, OM in Vern anmts, YL in EE w/ID and closing anmts, GSTQ to 1103 then switched to BBC WS in progress, good. (Lineback-KS)
- 5030 **BURKINA FASO R.Burkina** 5/7 2308-2400* FF talk, FF pop & reggae style music; M ID "R.Burkina", ment Ouagadougou; very clear.(Barbour-NH)
- 5050 **TANZANIA R.Tanzania** 5/19 tone to 0155, mx box IS, muffled opening anmt by lady, anthem 0158, 0200 brief talking by W&M, into African mx. Poor, and weakening throughout; almost gone by 0215, but better at 0330 check. (Berg-MA)
- 5637.22 **PERU R.Peru** 5/11 0150-0205* SS anmts. OA folk mx. Rustic OA mx. ID. Abrupt s/off. Poor. (Alexander PA)
- 5678 **PERU R.Ilucan** 5/11 0150-0206* SS talk. OA folk mx ID. Abrupt s/off. Fair. (Alexander PA)

So, the tropical bands remain interesting even as we enter the (Northern hemisphere) summer. Have a listen to the & let us know what you're hearing. Logs may be sent either to the distribution editor, or direct. If direct (to TropLogs@zerobeat.org), I can take them somewhat later than the normal cutoff date. ... Stop by the #swl area on the StarChat.net IRC network & say hello....

International Band Loggings

Wallace C. Treibel • 357 N.E. 149th Street • Seattle, WA 98155 • nwhikers@msn.com

- 59752 **COLOMBIA R Autentica** Villavicencio in SP 0800, ending long relig pgm, into pgm of local & relig mx mix, frequent ID's & TC's, QRM from R Marti xmtr s/on 0845 (Berg MA 5/13)
- 6025 **DOMINICAN REPUBLIC R Amanecer** in SP 0845, carrier to 0858, NA, opening ancmt but badly battered by splatter from R Marti (Delano relay) *0900 on 6030 (Berg MA 5/27)
- 60399 **BRAZIL R Clube Paranaense** Curitiba in PT 0150, lively ancw w/echo effect, ID 0200, faded in/out (Beattie CA 6/10) in PT 0900, quick ID 0906, g (Berg MA 6/9)
- 6070 **CANADA CFRX** Toronto in EG 0157, return fqy relaying MW CFRB, car dealer ads, ID as "News Talk Radio CFRB 1010", better signal now (Brouillette IL 5/10)
- 6080 **BRAZIL R Anhanguera** Goiania in PT 0850, surprised to hear this one holding up its own against HCJB on same fqy, animated talking, //11830 (Berg MA 6/9)
- 6085 **GERMANY Mitteldeutscher Rdf** Ismaning in GM 0341, "MDR Info", sports scores, nx re Jenein in Israel & Afghanistan, vg (Barbour NH 5/2)
- 6100 **LIBERIA R Liberia Int** Monrovia in EG 0640, continuous Christian mx, ID 070L, into another relig pgm, signal dropoff after 0700 - antenna change? (Brandi NJ 5/12, Montgomery PA 5/12)
- 61351 **BRAZIL R Aparecida** in PT 0925, decent level but hvy QRM from Santa Cruz 61348 (Berg MA 6/9) in PT 0202, jingle ads, ID, tlk, suddenly off 0213, f (D'Angelo PA 6/3)
- 61378 **SIERRA LEONE R UNAMSIL** in EG 0452, phone-in pgm, mx, TC, tlking about elections w/ID's at beginning of almost all calls (Brandi NJ 5/14) in EG 0638, ID as "Radio National", tlks abt Nigeria, interludes of mx during ancmts, weak signal w/ some fading (Montgomery PA 5/15)
- 6140 **CUBA R Rebelde** Havana in SP *1100, many tlks & ments of Rebelde, nx re Jimmy Carter's visit to Cuba, slightly better signal on //9600 (Berg MA 5/11)
- 6175 **CANADA V of Vietnam** relay in EG 0330, ID, national nx, rpt on aid to VT (McGuire MD 5/23)
- 6215nf **ARGENTINA R Balurate** Puerto Iguazu in SP 0127-0244+, long tlks, group vocals, relig mx, ads, jingles, sermon, low power SW outlet for AM & FM stns (D'Angelo PA, Alexander PA, Berg MA)
- 62352v **ALBANIA TWR Europe** relay in Slovak *0428, TWR IS at s/on & s/off 0445, relig mx, strong signal but slightly wobbly shifting fqy, better on //7380 (Alexander PA 5/27)
- 6265 **ZAMBIA R Zambia 1** Lusaka in FR/Vern 0355, Afro pop mx, ID toh w/drums & crowing rooster, mx w/drums & singing children, poor signal w/fades (Barbour NH 5/19)
- 6536 **PERU Rdf Huancabamba** in SP 0040-0212*, DJ taking calls & playing songs, ID, OA folk mx, s/off w/NA, crisp audio (Berg MA 5/12, Alexander PA 5/11)
- 67975 **PERU R Ondas del Rio Mayo** in SP 0135-0200*, SP pops/ballads, OA folk mx, ancmts, ID, s/off w/NA, weak signal from 1 kw xmtr, irregular sked (Alexander PA 5/19)
- 69567 **PERU Radio LV del Campesino** Huarmaca in SP 0235-0308*, rustic OA vocals hosted by DJ, abrupt s/off, p-f (D'Angelo PA 5/27) ED: listed xmtr 250 watts.
- 7180nf **GERMANY DX-Antwerp** relay via Juelich in EG/Flemish *0800, unique airing commemorating 20th anniversary of DX-Antwerp, Belgium, "2001" theme? & tlks, xmsn so weak could only make out a word here & there, gone by 0810, also hrd at whisper level on //9945 Lithuania relay (Berg MA 5/25)
- 7190nf **TUNISIA R Tunisia Int** Sfax in AR *0356-0440, pips at 0400, M/F ancw w/ nx, mx, strong signal but poor modulation, repl 7110 (Ponder TX 6/4) ED: Station QSL'd by E-mail immediately.
- 7205 **CYPRUS R Cyprus** in GK*2215-2245*, ID at s/on, drama?, GK mx, DJ tlk, hrd weekends only, //9760 (Barbour NH 5/5, Brandi NJ 6/9)
- 7210 **BENIN R Benin** Cotonou in FR 2223-2303*, drama, Afro pops, tlk over mx, trumpets at s/off, very weak audio, f (Barbour NH 5/13)
- 7235 **OMAN BBC** relay in Urdu 1735, nx, tlk by OM, BBC website, 2 remote rpts, f (Witham HI 5/21)
- 7240 **SWAZILAND TWR Africa** in SH *0258, chimes IS, ID's in EG/SH, ancmts, mx, "Amazing Grace" several tlks, clear reception w/some fades (Montgomery PA 5/15, Brandi NJ 6/8)
- 7255 **MOROCCO VOA** relay of Radio Sawa in EG/AR *0400, VOA ID & IS, into R Sawa pgm in AR, US and AR pop mx, nx in AR w/EG intros, several VOA //s including 5965 & 11570 (Greece) and 14 other overseas relays carrying MERN- Middle East Radio Network (Berg 5/17, D'Angelo 5/27)

- 7445usb **COSTA RICA RFPFI** in EG 0310, interview w/Margaret Kim, American humorist of Korean birth and her bout with alcoholism/drugs, ID, g (Witham HI 5/18)
- 9500 **SWAZILAND TWR Africa** in EG 0514, relig pgm, book offer, ID, South Africa QTH, signal ruined by splatter from VOA s/on 0530 on 9505 (UK relay), p (Barbour NH 5/15)
- 9500nf **SAUDI ARABIA BSKSA** in AR 2153, vocals, ID at toh, discussion pgm, returned to catch s/off at 2300, fair signal w/some adjacent channel splatter, //9870 (D'Angelo PA 5/15)
- 9560 **CANADA R Korea Int** relay in EG *0200, ID, rpt on N. Korean asylum seekers (McGuire MD 5/26)
- 9610 **IRAN VOIRI** Kamalabad in EG *0030, IS, NA, ID, fgy, sked, Koran readings, g (McGuire MD 5/7)
- 9705 **MEXICO R Mexico Int** in EG 0308, penpal pgm "World Wide Friends", mailbag, SP version of "Jail House Rock", ID, QTH, into SP pgmng 0331, f (Barbour NH)
- 9840 **VIETNAM V of Vietnam** Hanoi in EG *1000, s/on mx, ID, ancmts, nx, f, //12020 (D'Angelo 5/14)
- 9870 **AUSTRIA RAI** Moosbrun in SP 0030, waltz mx, ID, fgy, sked, national nx, g (McGuire MD 5/22)
- 9925 **GERMANY V of Croatia** relay via Juelich in EG 0443, nx, Croatian ex-communist booted at rally, Munitions found in Croatia, Croat Diabetes Society walk, g (Newbury NE 5/13)
- 9960 **NORWAY R Denmark** relay in DN 0330, IS, ID's in DN/EG, nx, QRM, //13800 (Witham HI)
- 9970 **BELGIUM RTBF** Brussels in FR *0257, open w/orch NA, ID, 5 pips, nx, mx featuring George Harrison's "All Those Years Ago", f (D'Angelo PA 5/15)
- 11655 **TURKEY V of Turkey** in EG *0300, pips, ID, fgy, sked, rpt on Middle East trouble (McGuire 5/14)
- 11710 **NO KOREA V of Korea** Kujang in EG 1528, nx, cmntry, lcl mx, ID, weak sig (Alexander PA 5/25)
- 11710 **ARGENTINA RAE** in EG 0230, SP guitar ballad, ID/nx in EG, abrupt off 0240, g (Beattie CA 5/14)
- 11740 **ROMANIA RRI** in EG *2300, nx, cmntry on NATO enlargement, preservation of historical buildings, and Euro film festival, f, //15105 (Barbour NH)
- 11765 **SOUTH AFRICA BBC** relay in EG 0512, rpt on poor econ condx in Kashmir, g (Newbury NE 5/30)
- 11787 **IRAQ RII** Baghdad in EG 0136, ID, TC, fgy, nx re oil production, AR mx, muddy audio, reception destroyed by D Welle s/on at 0157 (Barbour NH 5/22, McGuire MD 5/22)
- 11820 **NEW ZEALAND RNZI** in EG 0517, nx re drugs in NZ, dog poisoning, Virgin Blue Airlines finances ID, nice reception (Newbury NE 5/30)
- 11825 **VATICAN CITY V of Russia** relay in EG 0150, mx pgm, web QTH, ID, IS, cmntry on RS customs at Easter, nx on bombings in Russia, s/off at 0200 (McGuire MD 5/21, Pace IA 5/9)
- 11840 **RUSSIA R Rossii** via Sakhalin Islands in RS 1005, various RS talk features w/numerous ID's and mx between segments, f (D'Angelo PA 5/20)
- 11880 **SRI LANKA R Japan** relay in EG 0110, nx, ID, sports recap, tlk abt the 160 islands off Okinawa, DX mailbag, many //s in the 17 mhz band (Witham HI 5/19)
- 12000 **TURKEY V of Turkey** in EG *2200, IS, pips, fgy, sked, regional nx, ment Azerbaijan (McGuire 5/6)
- 12015 **MONGOLIA V of Mongolia** Ulan Bator in EG *0959, IS, ID, tlk re investigation on elections, into mailbag pgm at 1018, p-f (D'Angelo PA 5/20)
- 12040 **UKRAINE RUI** Simferopol in EG 0016, nx re entry into European Union, anniversary of Chernobyl accident, fair sig w/poor audio quality (Barbour NH 5/8)
- 13635 **AUSTRALIA Christian Voice Int** via Darwin in EG *1059, ID, nx headlines, relig promos, US pop mx, f (Barbour NH 5/7)
- 13645 **SWITZERLAND SRI** Sottens in IT 1830, ID, nx, rpt in EG w/IT translation, //15220 (Witham HI)
- 13685 **AUSTRALIA Christian Voice Int** via Darwin in EG 1021, review of movie "Scorpion King", many ID's, Queensland QTH for letters, relig mx/features (D'Angelo PA, Barbour NH)
- 13700 **IRAN VOIRI** Sirjan in FR 1840, nx, tlk over mx in background, Mideast mx, //13665 (Witham HI)
- 15039 **COSTA RICA RFPFI** in EG 0425, pgm "Counterspin", tlk abt Iraq and their use of chemical weapons, also re the effect of sanctions on Iraq, ID's, f (Witham HI 5/18)
- 151846v **EQUATORIAL GUINEA R Africa** in EG 2100-2304*, US produced relig pgming, ID at s/off with long NA, weak signal w/xmtr constantly varying approx +/- 50 hz (Alexander PA 5/24)
- 15215 **GUAM TWR** relay Agana in EG 0730, IS, ID, pgm: "Searching for Truth", tlk abt the Bible, much co-channel QRM from Beijing and Taipei, p (Witham HI 5/18)
- 15215 **SOUTH AFRICA Channel Africa** in EG *0600, 5 pips, nx of election in Sierra Leone, cmntry on the Israeli situation, ID 0604, tlks abt severe rains in Kenya & Madagascar causing livestock loss and death of humans, several features, sports nx, into PT language 0630 (Montgomery PA 5/16)
- 15235 **GERMANY AWR** relay via Juelich in BG 1715, tlk over inspirational mx, ID's in several languages, QTH, g (Witham HI 5/10)

- 15345 **ARGENTINA LRA1 R Nacional** relay via RAE Buenos Aires in SP 2330, lcl calendar of cultural events, tlk on National Anthem Day in Argentina, ID, nx, fair but crisp audio (Brouillette IL 5/11)
- 15385 **SPAIN REE Noblejas** in FR 2328, ID, tlk re social problems in Peru, exc (Brouillette IL 5/11)
- 15400 **UNITED ARAB EMIRATES R Dubai** in EG/AR 1625, Mideast mx, nx in EG 1630, into AR pgming 1635, heard under BBC Ascension Island relay, p (Witham HI 5/18)
- 15435 **IRAN VOIRI Sirjan** in Hausa 1850-1927*, phone call-ins, Mideast mx, p, //11930 (Witham HI 5/18)
- 15445 **GERMANY Swiss R Int** relay Juelich in EG 0740, "Take 2" pgm, rpt on the sale of Duke Ellington's Wrist watch for 2 million francs, pgm about Swiss vocalist and her mx, f (Witham HI 5/18)
- 15565 **NETHERLAND ANTILLES RVJ** Belgium relay via Bonaire in EG 2230, pips, ID, "Flanders Today" report on French election, g (McGuire MD 5/6)
- 15620 **CZECH REPUBLIC R Prague** in EG 0332, nx, ID, "Spotlight" pgm - a radio travelog to an ancient walled town in Slovakia and a visit to a castle where composer Martinu was born, f (Witham HI 5/16)
- 15785 **ISRAEL Galei Zahal** Jerusalem in HB *0257, lcl pops, tlks, g (Alexander PA 5/18) ED: only 10 kw
- 15820 **ARGENTINA R Continental** Buenos Aires in SP 0030-0145+, tlks, ancmts, SP ballads, ID's, phone tlk, vg, gone by 0200 recheck (Alexander PA 5/27)
- 17520 **PAKISTAN R Pakistan** Islamabad in EG 1000, 3 pips, ID, nx on disagreement between India and Pakistan over Kashmir, S-5 w/no fading, NA and s/off 1006 (Montgomery PA 5/20)
- 17600 **ISRAEL V of Israel** Tel Aviv in EG 0405, world & lcl nx, "Review of World Press" pgm, s-off in mid-sentence at 0415, f, //15640 (Witham HI 5/18)
- 17775 **UZBEKISTAN R Tashkent** in EG 1211, nx re winter clothing allowances, public health care, feature re "Costumes and Traditions", QTH, p (Barbour NH)
- 17800 **IRAN VOIRI Mashhad** in SH 0350, tlks, Mideast mx, several ments Iran, p, //17570 (Witham HI 5/18)
- 171852 **BRAZIL R Cultura** São Paulo in PT 2343-0001*, old Bras ballads, low-key DJ, lite instrum'ls and Jazz, ID and NA at s/off, p-g w/QRM, no better on //9615 (Brouillette IL 6/2, Alexander PA 5/18)
- 18940nf **NORWAY R Afghanistan** relay via Kvitsoy in lang? 1350, mostly tlk, some mx, no noticeable ID at 1400, much QSB but improving, finally got positive ID just before 1630 s/off (Berg MA 6/9)

Clandestine, Tentative, Presumed, or Unknown

- 59649 **BRAZIL(t) R Nova Visão(p)** in PT 0920, YL singing, checked listed //9530 but no help since it was buried under NHK's Guiana relay (Berg MA 6/9)
- 72103 **BENIN(p) RTVB** Cotonou(p) in FR 0558, drum IS, NA, weak w/muffled audio (Berg MA 5/25)
- 72601 **VANUATU(t) R Vanuatu** Port Vila(t) in FR 1002, techno mx, short tlks, ID? (Montgomery PA 6/7)
- 7310 **CLANDESTINE R Voice of the People** via Madagascar in EG *0329, opening w/mx followed by ID "This is Radio Voice of the People 7310 khz on shortwave", p (D'Angelo PA 5/15)
- 7460 **CLANDESTINE Western Sahara National Radio** via Algeria(p) in AR 2250-0002*, AR chants w/o mx, tentative ID at 0000, NA? before s/off, p (Barbour NH 5/9)
- 9550 **CONGO(p) R Okapi** Kinshasa(p) in FR? 2130-2200+, mostly continuous African vocals, jingles, poor with a lot of co-channel QRM & splatter (Alexander PA 5/11) in FR? 0344 w/old style Congolese mx Chic "Le Freak", mixing w/RHC Cuba, no ID heard (Brandt NJ 5/12)
- 11880 **SEYCHELLES FEBA Radio(t)** in EG/SH(p) 0350-0358*, pgm re anti-smoking campaign, website, tentative ID in SH, contact info, f-p (Barbour NH 5/31)
- 12125 **CLANDESTINE Jakada R Int** relay via Spain in EG *1856 to 1930 s/off, opening w/instrumental mx and ID, ancmts, phone interview, station began xmtng on 5/1 beamed to Africa w/aim of promoting peaceful co-existence, very poor signal w/heavy noise (D'Angelo PA 5/24, Barbour NH 5/3)
- 12125 **RUSSIA V of Biafra Int** via Armavir in EG *1857, ID, prayer, cmntry on Nigerian ownership rights, rapid signal deterioration w/sig gone by 1925, p (Barbour NH 5/11)
- 17510 **FRANCE R Seay-E Iran** via Issoudon relay in Farsi 1555, tlk, mx, ID 1600, nx, political cmntry, fone interview, f (Barbour NH 5/24)
- 17870 **AUSTRIA R Voice of Afghanistan** relay in Pashto/Dari *1330, AR mx, website, nx, talk, into Dari at 1400, ID as "Radio Sadaya" (?), f-p (Barbour NH 5/12)



FOR SALE: "WRTH '97, \$10, 2000 \$18, 2001 \$20. Perry Ferrell's Guides: RTTY Freqs. 2nd Edit. \$5; Confidential Freq. Lists, 5th edit. \$6; 6th edit. \$11; 7th edit. \$13. All items include shipping (overseas shipping extra). Cashiers check or money order only, please. Al Drehmann 389 Laurel Heights Lane, Tryon, NC 28782-6643. E-mail aldreh@alltel.net Phone 828 894-3398. No collect calls, please

Company Store

Bill Bergadano KA2EMZ • 32 Joysan Terrace • Freehold, NJ 07728 • ka2emz@cybercomm.net

All s/h charges for the following items are included unless otherwise noted.

Publications

Shortwave Listening Guidebook by Harry Helms. Covers equipment, antennas, propagation, station profiles, utilities, clandestines, QSL'ing, etc. 315 pages.	\$18.50 +2.00 s/h US/CA +3.00 s/h world
Underground Frequency Guide by Donald W. Schimmel. An in-depth look at illegal radio communications; pirate, spies and so much more! Lists hundreds of frequencies. A book no pirate or clanny fan should be without!	\$17.50 +2.00 s/h NAM +3.00 s/h world
Joe Carr's Loop Antenna Handbook Comprehensive but readable guide to understanding and building loops for LW, MW, SW and VHF. Non-technical, has many diagrams.	\$16.50 +1.25 s/h US/CA +2.00 s/h world
The Vacuum Tube Era Reviews the golden years of vacuum tube receivers, 1932-1981. If you feel real radios glow in the dark, this is for you! 141 pages.	\$15.00 +1.50 s/h worldwide
Shortwave Receivers, Past & Present by Fred Osterman. A comprehensive guide to over 770 shortwave, amateur and commercial communications receivers produced in the last 55 years! Over 800 photos. 473 pages.	\$21.00 +2.00 s/h US/CA +3.50 s/h world
Confidential Frequency List This book, which details frequencies, call signs and data for the non-broadcast stations on 2-30 MHz, has just been released (12th edition). Ships December 15th.	\$24.50 +4.00 s/h NAM +8.00 world
Inside the Mission Control Center by R.H. Nicholson. This is your personal tour of the former mission control center at the Johnson Space Center! A great book for the space or radio communications enthusiast!	\$7.00 +1.50 s/h NAM +2.00 world
NASWA Country List and Awards Program Booklet	\$3.00 PP US/CA \$5.50 elsewhere
QSL Signers by Al Quaglieri. The most comprehensive and up-to-date list of verification signers names, titles, and addresses available anywhere!	\$2.50 PP US/CA \$4.50 elsewhere

The NASWA Reprint List, The System, Spectrum Log and Propagation Predictor are no longer available.

Make checks payable in U.S. funds to "The NASWA Company Store."



North American Shortwave Association
45 Wildflower Road
Levittown, Pennsylvania, 19057

First Class Mail
U.S. Postage
PAID
Levittown, PA
Permit No. 319

FIRST CLASS MAIL

ISSN 0160-1989



The Journal of the
North American Shortwave Association

Executive Director: Richard A. D'Angelo, 2216
Burkey Dr., Wyomissing, PA 19610
Publisher/Business Manager: Bill Oliver, 45
Wildflower Road, Levittown, PA 19057
Executive Council: Jerry Berg, Ralph Brandi,
Bob Brown, Dr. Harold Cones, Rich D'Angelo,
Fred Kohlbrenner, Bill Oliver

EDITORIAL STAFF

Managing Editor: Dr. Harold Cones, 2 Whits
Court, Newport News, VA 23606
Desktop Publishing/Graphics: Ralph Brandi,
P.O. Box 491, Lincroft, NJ 07738
Easy Listening: Richard Cuff, 42 North 37th
Street, Allentown, PA 18104
Shortwave Center: Jerry Lineback, 506 S.
Lawrence Ave., Scranton, KS 66537
Technical Topics: Joe Buch, N2JB, P.O. Box
1552, Ocean View, DE 19970-1552
Equipment Reviews: Alan Johnson, N4LUS
2490 Sharon Way, Reno, NV 89509
Adrian Peterson's Diary: Dr. Adrian M.
Peterson, Box 29235, Indianapolis, IN 46229
NASWA Awards: Dr. Harold Cones, 2 Whits
Court, Newport News, VA 23606
Listener's Notebook: Al Quaglieri, P.O. Box
888, Albany, NY 12201-0888
Pirate Radio Report: Chris Lobdell, P.O. Box
146, Stoneham, MA 02180-0146
QSL Report: Sam Barto, 47 Prospect Place,
Bristol, CT 06010

Scoreboard: Fred S. Kohlbrenner, 214 West
Marshall Road, Lansdowne, PA 19050
Net Notes: Tom Sundstrom, W2XQ P.O. Box
2275, Vincentown, NJ 08088-2275
Distributing Editor: Bob Montgomery, P.O. Box
1458, Levittown, PA 19058
Tropical Band Loggings: Sheryl Paszkiewicz,
P.O. Box 152, Manitowoc, WI 54221-0152
International Band Loggings: Wallace C.
Treibel, 357 N.E. 149th St., Shoreline, WA 98155
English Schedules: Mark J. Fine, 11252
Cardinal Drive, Remington, VA 22724-2032
The Company Store: Bill Bergadano KA2EMZ,
32 Joysan Terrace, Freehold, NJ 07728

MEMBERSHIP FEES:

United States (First Class Mail)	\$26.00
Canada & Mexico (First Class Mail)	\$27.00
Overseas (ISAL Mail):	
<i>Central & South America and Europe</i>	\$30.00
<i>Asia, Africa and Pacific</i>	\$32.00
Overseas (Air Mail):	
<i>Central & South America and Europe</i>	\$36.00
<i>Asia, Africa and Pacific</i>	\$42.00

All remittances must be in U.S. funds and mailed to:

NASWA
45 Wildflower Road
Levittown, PA 19057
U.S.A.



NASWA: <http://www.anarc.org/naswa/>