

S. Gernsback's  
Radio Encyclopedia

1927

Radio Technology as It Was in the Old Days.

Reproduced Directly from Sidney Gernsback's  
Original Book.

Describes Early Radio's People, Circuits,  
Components and Techniques.

Ideal for Collectors, Restorers, Historians  
and Browsers.

McMAHON'S

PUBLISHED BY



VINTAGE RADIO



## THE VINTAGE RADIO SERIES

S. Gernsback's

### RADIO ENCYCLOPEDIA

—A time trip back to 1927—

Here is all that was known about radio in the mid-1920's, in handy capsule form. This book tells about the people, technology and hardware of those days. It's the real thing; a direct reproduction of the book published in 1927 by the Gernsback radio-technical dynasty.

You can enjoy S. Gernsback's Radio Encyclopedia in many ways:

- Browse through the early days of radio.
- Recapture the excitement of times when radio was a fascinating phenomenon.
- See the world of radio through the eyes of old-timers.
- Use it as an early-day reference.
- Use it as a collector's aid.

This book is a great addition to your library of collectibles, history and memorabilia. It's another member of the Vintage Radio series, in which we recapture the flavor, excitement and technology of the old days of radio.

We're sure you'll enjoy it.



Morgan McMahon has spent most of his life living in the future. He became a radio amateur back in the days when the local "ham" was considered the neighborhood nut. In World War II he worked with advanced electronic systems. He went into solid-state research after earning his master's degree at the University of California. He taught the first transistor course given in the West, at UCLA.

Mr. McMahon's career in industry has revolved around new business ventures and advanced technology. He helped start one semiconductor company. He then set up diode, transistor and integrated circuit operations for a major electronic manufacturer. He was Chief Scientist for the largest U.S. manufacturer of electronic parts. He is now a consultant.

Some years ago Mr. McMahon became interested in the history of electronics. To his surprise, the early days of this field were not at all well recorded. Harold Greenwood's book, the only available history of wireless and radio, had gone out of print. Mr. McMahon enlisted the willing help of historians, collectors, historical societies, technical publishers and old-line manufacturers to assemble Vintage Radio. His aim is to help preserve this piece of our heritage in an enjoyable way, in a series of readable books.

Other books in the Vintage Radio series are Vintage Radio (1887-1929), Radio Collector's Guide (1921-1932) and From Static to Snow (1930-1950).

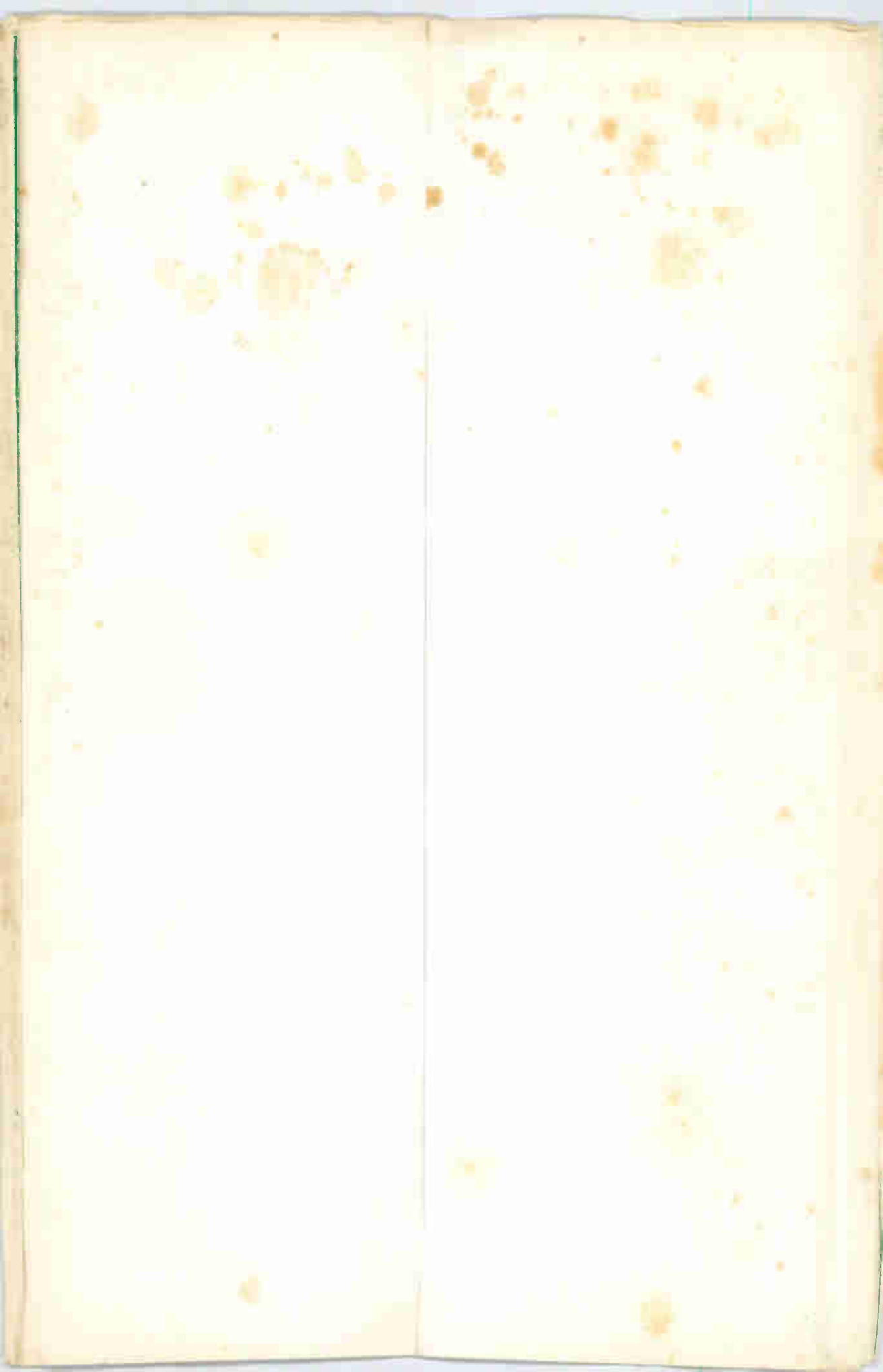

# S. Gernsback's Radio Encyclopedia 1927

Radio was the miracle of the age in the 1920's. In 1927 Sidney Gernsback wrote down all that was worth knowing about radio.

S. Gernsback's 1927 Radio Encyclopedia is now a priceless document, letting us see radio's past through the eyes of those who were living it. This book is history in the raw, as it was before the laws of evolution knocked out all those weird and wonderful old circuits.

If you're a nostalgia fan, you'll find many hours of enjoyment by poking around among people and things of another era. If you're a collector, this book helps you understand the "artifacts" you're after. If you're interested in radio history, this book is your time machine.

McMAHON'S

PUBLISHED BY



VINTAGE RADIO

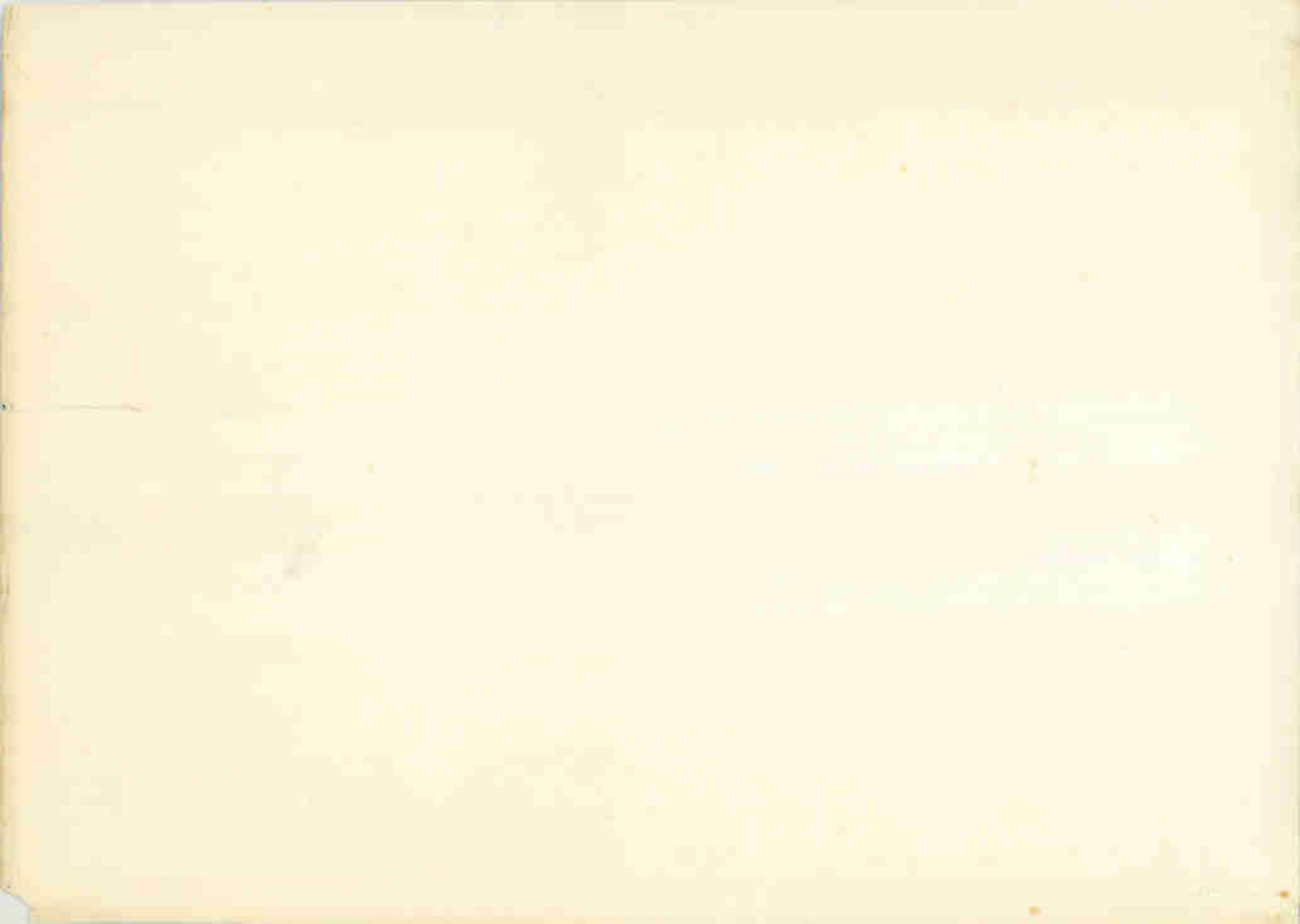

S. GERNSBACK'S  
1927  
RADIO ENCYCLOPEDIA

BY  
SIDNEY GERNSBACK



**Vintage Radio**

~ PUBLISHERS ~

## THIS BOOK

Sidney Gernsback's Radio Encyclopedia is the best available picture of radio's "state of the art" in the mid-1920's. It shows history and technology as seen through the eyes of people of those days, when radio was still weird and wonderful.

This book is another member of the Vintage Radio series, in which we capture the flavor, excitement and technology of the old days of radio, television and electronics. In this series we look at history by viewing the "artifacts" of earlier days; transmitters, receivers, old photos, old ads, old books, component parts and trivia. We tie it together with comments by eminent historians. Other books in the series are Vintage Radio (1887-1929), Radio Collector's Guide (1921-1932), and From Static To Snow (1930-1950).

---

We wish to thank Mrs. Gayle Rowland for bringing this book to our attention, and Mr. Paul Giganti for providing copies of the original for reproduction. Also we wish to thank Mr. M. Harvey Gernsback for his encouragement and his aid in tracking down reproduction rights.

---

Production by H. Juhl Graphic Art Services, Cerritos, California.

Printing by Griffin Printing and Lithography, Glendale, California.

---

Gernsback, Sidney  
S. Gernsback's 1927 Radio Encyclopedia.

1. Radio - Dictionaries. 2. Radio - Collector's and Collecting. I. Title.
- II. Title: 1927 Radio Encyclopedia.

621.384' 03

---

Originally published by Sidney Gernsback, 1927.  
Replica Reprint, 84% Scale.

Copyright © 1974 by Vintage Radio. All rights reserved.

Limited Printing: 2,000 copies Hard Cover, 2,000 copies Handbook.

Published by Vintage Radio, Box 2045, Palos Verdes Peninsula, California, 90274.

International Standard Book Number 0-914126-06-7 (Hard Cover) 0-914126-07-5 (Handbook)

Printed in U. S. A.



# A

**"A" BATTERY**—An appliance for furnishing electrical current to light the filaments of a vacuum tube, and cause emission of electrons (see *Theory of Vacuum Tube Operation*). This battery may be in any of several forms,

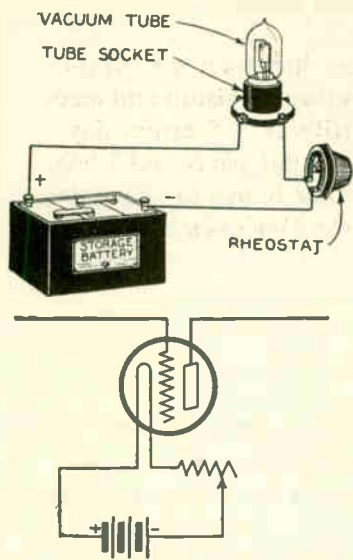

Fig. 1. Method of connecting the "A" battery to a vacuum tube in radio receiving circuits. The lower diagram shows the "A" battery as represented in schematic drawings

the two in popular use being the storage type (see *Storage Battery*), and the dry cell (see *Dry Cell*). Fig. 1 shows method of connecting the "A" Battery in a vacuum tube circuit.



Photos by courtesy of National Carbon Co., Inc.  
Fig. 2. A storage battery such as used for "A" battery current supply

In Fig. 2 a popular type of storage battery is shown. Batteries of this type come in many individual forms, the usual voltage being standardized at 6 volts. However, for use with certain tubes, 2 and 4 volt storage batteries are available. For general radio work, using the low-consumption tubes, the battery, as shown in Fig. 2, can hold a charge of from 60-80 ampere hours. (See *Storage Battery*.)

The other common form of "A" Battery is the dry cell, usually having a difference of potential (voltage) of 1.5 volts. Fig. 3 illustrates a popular type of dry cell. In connecting a number of cells for use with a vacuum tube,

the method of connecting will depend on the voltage rating of the particular tube. If the tube is rated at 1.5 volts, a single dry cell may be used as in Fig. 4, or several may be connected in parallel (*q.v.*) shown in Fig. 5, the total voltage however, being only the voltage of one cell. Three dry cells connected in series (*q.v.*) will give 4½ volts, Fig. 6. A connection for dry cells, known as *series-parallel* or *multiple* (*q.v.*), is shown in Fig. 7. This connection will also produce 4½ volts and at the same time increase the life of the cells. Four dry cells connected in series will give six volts for use with a standard six-volt tube, Fig. 8. Dry cells are only used with six-volt tubes where the tube has a current rating of ¼ ampere, and seldom more than one tube is used in this manner



Fig. 3. A dry cell "A" battery

due to the relatively high discharge and consequent short life of the battery.

A storage battery can be used for the "A" Battery current with a 4-volt

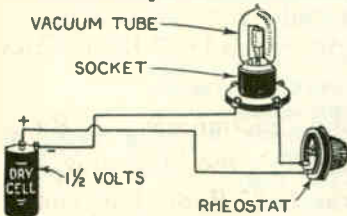

Fig. 4. This circuit shows how one dry cell is used as the "A" battery for types of tubes requiring 1½ volts filament current

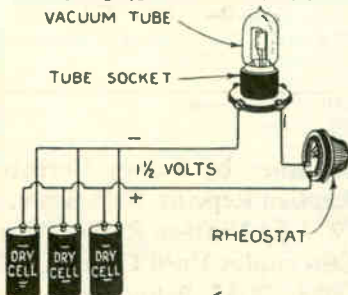

Fig. 5. Several dry cells may be connected in parallel for increased amperage or longer life of the "A" battery

tube if the connection is made as in Fig. 9. Here a standard 6-volt storage battery is tapped at the four volt terminal.

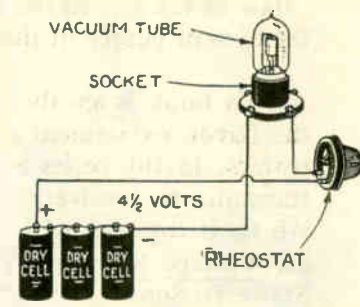

Fig. 6. Three dry cells connected in series give 4½ volts, serving as the "A" battery for the U.V.199 or C299 type of tube

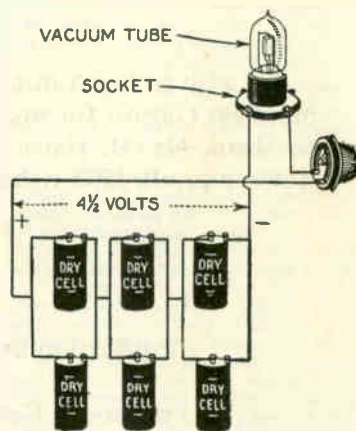

Fig. 7. A series-parallel connection of three dry cells for longer life of the "A" battery with 4½ volt tubes

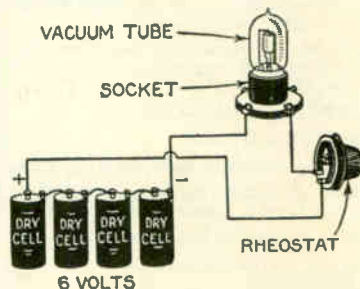

Fig. 8. Four dry cells connected in series give 6 volts for low consumption tubes

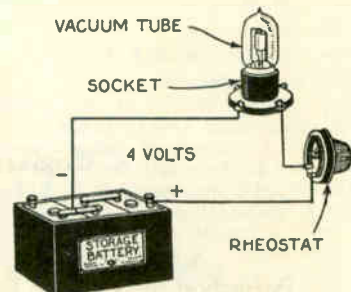

Fig. 9. Showing method of tapping at 4-volt terminal of a 6-volt storage battery for type U.V.199 or C299 tubes or other 4-volt tubes

Another connection for low voltage tubes can be made as illustrated in Fig. 10. Here only one cell of the storage battery is used. This cell can be used until exhausted when the other

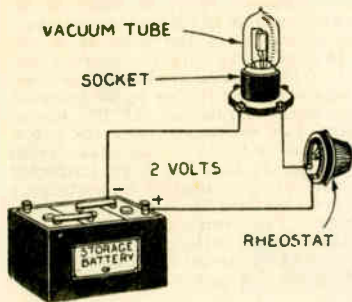

Fig. 10. How a single cell of a 6-volt storage battery may be employed to furnish "A" battery current for 1½ volt tubes

cells can be used in the same manner. When the three cells are exhausted, the storage battery may be charged by means of a *charger* (q.v.).

**ABAMPERE**—A unit of current used in special theoretical work. It has a value of 10 *amperes* (q.v.) and is not generally used in electrical work.

**ABBREVIATIONS, AMATEUR**—The transmitting amateurs of the United States use their own peculiar abbreviations in their inter-communication work. These are used to lessen the interference between transmitting stations as it permits conversation in a much quicker manner. The abbreviations generally used are listed below. Simplified spelling is always resorted to, words being spelled according to their sounds. Some such words are given, but others are so obvious that they are not listed. There are also the standard "Q" signals adopted by the International Radiotelegraphic Convention, to be found in official publications and given under the heading "Abbreviations, International Radiotelegraphic Convention."

**ACCW**—A transmitter using rectified alternating current as the plate supply.

**AFTRN** or **P.M.**—Afternoon.

**AMMTR**—Ammeter.

**ARRL**—American Radio Relay League.

**BCL**—Broadcast listener, one who does not have a transmitting station.

**BC STATION**—Broadcast Station.

**BFRE**—or **B4**—Before.

**BLO**—Blow.

**BOTTLE** or **V.T.**—Vacuum Tube.

**C**—See or Call.

**CGE**—Cage.

**CM**—City Manager of A. R. R. L.

**CTPSE**—Counterpoise.

**CUL**—See you later or call you later.

**CW**—Continuous wave transmitter.

**DCCW**—A transmitter using direct current as the supply for the plate.

**DM**—District Manager of A. R. R. L.

**DOPE**—Information, or in another sense, a varnish for coating inductance coils.

**DS**—District Superintendent of the A. R. R. L.

**DX**—Distance, receiving or transmitting.

**FB**—Fine Business.

**FONE**—Phone.

**GA**—Good afternoon.

**GLD**—Glad.

**GM**—Good morning.

**GN**—Good night.

**FRQ**—Frequency.

**HAM**—Being a term for the transmitting amateur.

**HI**—High or I am laughing—it's funny, according to use in sentence.

**HI LOS**—High loss.

**HR**—Here.

**HV**—Have.

**KCK BCK**—Kick back.

**KONGRATS**—Congratulations.

**KY**—Key.

**LW LOS**—Low loss.

**LW WVE**—Low waves.

**MGHT**—Might.

**MIKE**—Microphone.

**MSG**—Message.

**NITE**—Night.

**OM**—Old man.

**OP**—Operator.

**OPS**—Operators.

**ORS**—Official Radio Station.

**OT**—Oscillation transformer.

**OW**—Female operator.

**PEEP-PEEP**—Continuous wave transmitter.

**QCW**—Listen for my CW transmitter.

**QCW?**—Shall I listen to your CW transmitter?

**QRMER**—An operator who persists in interfering with other stations after being warned to stop.

**QSR**—I will relay the message.

**QSR?**—Will you relay the message?

**QSS**—You are fading.

**QSS?**—Is my signal fading?

**RDO**—Radio.

**RECVR**—Receiver.

**RELY**—Relay.

**ROCKCRUSHER**—Spark transmitter.

**SA**—Say.

**SIGS**—Signals.

**SPIKE**—Message file.

**SPK**—Speak.

**SUREFIRE**—Something positive in action.

**THG**—Thing.

**THT**—That.

**TLL**—Till.

**TM**—Traffic manager of A. R. R. L.

**TMR**—Tomorrow.

**TRAFFIC**—The handling of messages among the stations.

**U**—You.

**UNLIS**—Unlicensed.

**UR**—Your.

**VLTMR**—Voltmeter.

**WL**—Will.

**WRLS**—Wireless.

**WVL**—Wavelength.

**"X" LICENSE**—Experimental License.

**YL**—Young lady.

**"Z"**—Special license.

**73**—Best regards.

**ABBREVIATIONS — RADIO — ELECTRICAL**—A letter or group of letters of the alphabet arranged so that there is a definite electrical meaning when used in radio telegraphy or telephony. These abbreviations are the means by which technical writings are simplified, i.e., Alternating Current is simply A.C. when used in general telegraphy. As most of the latest radio text books use these abbreviations, the following are given to aid the reader in understanding the various abbreviations:

**A.C.**—Alternating Current.

**A.F.**—Audio Frequency.

**B.E.M.F.**—Back Electromotive Force.

**B. & S.**—Brown & Sharpe Wire Gauge.

**B.S.W.G.**—Birmingham Standard Wire Gauge.

**C.**—Capacity.

**C.G.S.**—Centimetre-gramme-second (q.v.).

**C.W.**—Continuous Waves.

**D.C.**—Direct Current.

**D.C.C.**—Double Cotton Covered (Wire).

**D.S.C.**—Double Silk Covered.

**E.**—Induced Pressure (See Abvolt).

**E.M.F.**—Electromotive Force.

**H.F.**—High Frequency.

**H.F.C.**—High Frequency Current.

**I.R.E.**—Institute of Radio Engineers.

**L.**—Inductance (in Formulae).

**L.F.**—Low Frequency.

**L.F.C.**—Low Frequency Current.

**M.A.**—Milliampere.

**Mfd.**—Microfarad.

**P.D.**—Potential Difference.

**R.**—Electrical Resistance.

**R.F.**—Radio Frequency.

**R.P.M.**—Revolutions per Minute.

**R.P.S.**—Revolutions per Second.

**S.G.**—Specific Gravity.

**S.H.M.**—Simple Harmonic Motion.

**S.S.C.**—Single Silk Covered.

**S.W.G.**—Standard Wire Gauge.

**W/L**—Wavelength.

**X's**—Atmospherics.

**ABBREVIATIONS, INTERNATIONAL RADIO TELEGRAPHIC CONVENTION**—All messages and conversations are not transmitted in regular form, various forms of abbreviations being widely used to increase the speed of transmission and to reduce cost. It also has the tendency to decrease the interference as messages are sent swiftly in half the time. In wireless telegraphy, abbreviations have been adopted as international, and today there are very few ships or shore stations that do not use at least part of them daily. Below we give the International Radiotelegraphic Abbreviations as adopted at the International Radiotelegraphic Convention. An example of the use of the abbreviations is as follows:

A station wishing to learn the name of a ship which is seen off the coast, sends in code the letters QRA?, which means, what is the name of your ship? The station or ship answers with the letters, QRA S.S. Lapland, thus in a few seconds the question had been answered.

Abbreviation	Question	Answer or Notice
CQ	-----	Signal of inquiry made by a station desiring to communicate.
TR	-----	Signal announcing the sending of particulars concerning a station on shipboard.
	-----	Signal indicating that a station is about to send a high power.
PBB	Do you wish to communicate by means of the International Signal Code? .....	I wish to communicate by means of the International Signal Code.
QRA	What ship or coast station is that? .....	This is .....
QRB	What is your distance? .....	My distance is .....
QRC	What is your true bearing? .....	My true bearing is .....
QRD	Where are you bound for? .....	I am bound for .....
QRF	Where are you bound from? .....	I am bound from .....
QRG	What line do you belong to? .....	I belong to the .....
QRH	What is your wave length in meters? .....	My wave length is .....
QRJ	How many words have you to send? .....	I have .....
QRK	How do you receive me? .....	I am receiving well.
QRL	Are you receiving badly? Shall I send 20 .....	I am receiving badly. Please send 20 .....
	for adjustment?	for adjustment.
QRM	Are you being interfered with? .....	I am being interfered with.
QRN	Are the atmospherics strong? .....	Atmospherics are very strong.
QRO	Shall I increase power? .....	Increase power.
QRP	Shall I decrease power? .....	Decrease power.
QRQ	Shall I send faster? .....	Send faster.
QRS	Shall I send slower? .....	Send slower.
QRT	Shall I stop sending? .....	Stop sending.
QRU	.....	I have nothing to transmit.
		I have nothing for you.
QRV	Are you ready? .....	I am ready. All right now.
QRW	Are you busy? .....	I am busy (or, I am busy with.... Please do not interfere).
QRX	Shall I stand by? .....	Stand by. I will call you when required.
QRY	When will be my turn? .....	Your turn will be No. ....
QRZ	Are my signals weak? .....	Your signals are weak.
QSA	Are my signals strong? .....	Your signals are strong.
QSB	Is my tone bad? .....	The tone is bad.
	Is my spark bad? .....	The spark is bad.
QSC	Is my spacing bad? .....	Your spacing is bad.

(When an abbreviation is followed by a mark of interrogation, it refers to the question indicated for that abbreviation)

**ABSCISSA**—A term in geometry adapted to radio use in making curves to show various values. The abscissae are the horizontal lines, and the ordinates are the vertical lines. In the diagram, the line AY is the axis of ordinates (q.v.) and the line AX the axis of abscissae. Fig. 2 shows a simple curve indicating the relation between voltage and current (amperes) in an arc (q.v.). The volts are given

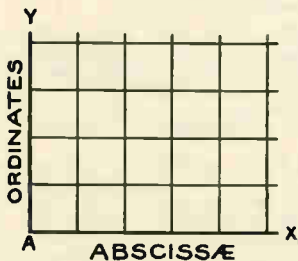

Fig. 1. Indicating axis of abscissae by the line A to X

as ordinates and the amperes are shown as abscissae.

The distance of any point from the axis of ordinates, measured on a line parallel to the other axis represents the value of the quantity and locates a point on the curve. Where abscissae

and ordinates are known, it is a simple matter to plot a series of points and then draw the curve through these points. (See curve.) Thus, in Figure 2, the curve shows the operation of the arc to be such that when the voltage is zero, the current is 20 amperes;

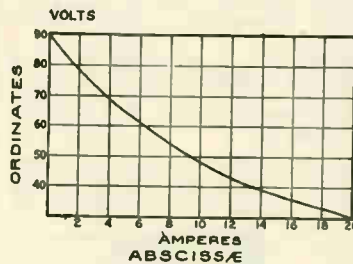

Fig. 2. A simple curve to illustrate the relation between volts and amperes

when the voltage is 60, the current is 6 amperes, etc.

**ABSORPTION, ELECTRIC**—(See Soaking-in.)

**ABSORPTION MODULATION**—In the production of modulated (see modulation) waves, used to transmit speech in radio, it is necessary first to produce undamped (q.v.) waves of high or radio frequency (q.v.). Then other

waves of low or audio frequency (q.v.) are superposed or run together with them. Now, if we insert a microphone (q.v.) in the aerial circuit (q.v.) of the transmitting station, providing that the resistance (q.v.) of that instrument is such as to reproduce accurately the vibrations of the voice or music, it is possible to vary the current output of the system producing the high frequency currents, so as to transmit the voice vibrations. If the microphone has resistance comparably low with the antenna or antenna resistance (q.v.), then the high frequency power output is handled (apportioned) equally between the aerial and microphone. The result is the production of fairly well modulated waves. There are, however, better methods of modulating the waves for which see Modulation.

**ABVOLT**—The CGS unit (q.v.) indicating the pressure or induced E.M.F. (electromotive force) (q.v.) set up between the ends of a wire one centimeter long, moving with a speed of one centimeter per second across the magnetic lines of force (flux lines) (q.v.) of a uniform magnetic field of unit intensity or flux density. An abvolt is therefore a very small unit and 100,000,000 (10<sup>8</sup>) are required to equal one volt. In all formulae for determining the output or E.M.F. that can be expected to be produced by a certain alternator (q.v.), the result is in abvolts, and the complete formula usually provides for obtaining the actual volts. This is done by dividing the result in abvolts by 100,000,000 or 10<sup>8</sup> as it is generally expressed. (See Alternator also ampere.)

A. C.—Abbreviation for Alternating Current. (See Alternating Current.)

**ACCELERATION**—The rate at which the speed of a body in motion increases within a certain period of time. If we assume a train running at a certain rate of speed when the brakes are applied, the speed will decrease, and if measured over a period of one second, there will be a definite amount of decrease or a rate of decrease. This is known as negative acceleration or deceleration. When the train is speeded up there will be a definite change (increase) in velocity. The rate of change of velocity per unit of time is the acceleration. (See Velocity also Frequency.)

**ACCEPTOR**—A supplementary combination of inductance (q.v.) and capacity (q.v.) tuned to the frequency of the desired signal and connected in series in the receiving antenna. Generally, a coil (q.v.) and condenser (q.v.) of a value to correspond with a certain given wavelength—thus literally to “accept” the desired signal. (See also Rejector.)

A series combination of inductance (q.v.) and capacity (q.v.) connected in series with a high-frequency C.M.F. When tuned to resonance with the impressed E.M.F., the impedance drops to a low value, limited by the resistance of the system

**ACCUMULATION OF ELECTRICITY**

—The process of storing electrical energy as (1)—a storage battery (q.v.) in which electric charges are placed to be later withdrawn and expended at will for various purposes, or (2)—the collection of energy by a condenser (q.v.) wherein the electrons (q.v.)

## Accumulator

or minute charges of electricity are stored up momentarily on the plates or electrodes of the *condenser* (q.v.) and then released into the circuit.

**ACCUMULATOR**—(See *Storage Battery*.)

**ACID**—An active chemical compound formed by combining hydrogen with various acid radicals. Acids are much used in radio, particularly in *storage batteries* (q.v.). The most commonly used acid in this connection is sulphuric acid—a compound or union of hydrogen, sulphur and oxygen in certain definite proportions as indicated by the chemical symbol  $H_2SO_4$ . (See *Flux, Soldering*.)

**ACIDIMETER** or **ACIDOMETER**—An instrument used to determine the *specific gravity* (q.v.) of an acid solution. It is similar to a hydrometer and used in the same manner. Much used for testing strength or purity of acids or solutions. Operates on the principle that the strength of an acid will be directly proportional to the quantity of carbonic acid gas which it will liberate from a carbonate of soda or potash. (See *Hydrometer*.)

**ACLINIC LINE**—An imaginary line on the earth's surface assumed as passing through points where there is no magnetic inclination or dip of the needle of a compass. (See *Agonic Line*.)

**ACOUSTICS**—The science of sound or the study of the cause and effect of vibrations which effect the hearing. Generally speaking, the production and transmission of sound.

**ACOUSTIC WAVE**—The term occasionally used to denote a *sound wave*.

**ACTINIC RAY**—A light ray or beam of invisible *radiant energy* (q.v.). Rays of light, generally considered as lying at the blue or extreme left of the *spectrum* (q.v.) and being of such short *wavelength* as to be invisible to the eye. These rays have the power to induce or bring about chemical action. The most powerful actinic rays are the violet (X Ray) and the *ultra-violet*.

**ACTIVE CONDUCTOR**—(See *Conductor*.)

**ACTIVE MATERIAL**—The spongy part of a plate of a storage battery. The part which changes in nature and appearance due to the flow of electric current and having the ability to redevelop the current by a secondary chemical change.

**ACTIVE PRESSURE**—The active *electromotive force* (q.v.) or the pressure which produces a current. The term is used to distinguish this pressure from one impressed on the circuit.

A component in phase with the current in an *alternating current* (q.v.)

**ACTIVE SPARK**—A spark produced from energy contained in a charged condenser, which produces active *oscillations* (q.v.).

Thus, the spark discharge from a coil without any method of storing energy will be "inactive." When a condenser is inserted in such manner as to allow it to store up energy and then discharge, the resultant spark will be "active."

Fig. 1 shows a simple spark coil circuit with the secondary discharging across a gap. This is an Inactive

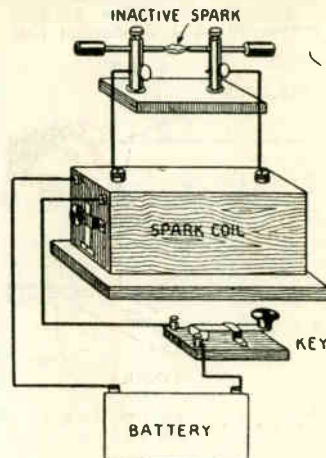

Fig. 1. Showing how an inactive spark is produced

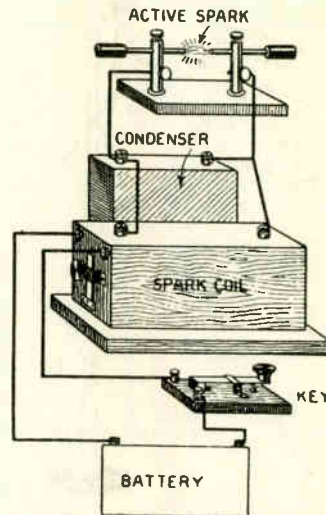

Fig. 2. The active spark is produced by means of a condenser in the circuit as shown

Spark. Fig. 2 represents the same coil with a condenser in the circuit to store up the energy before discharging across the *gap* (q.v.). This is an Active Spark.

**ADAPTER, AERIAL**—A device for utilizing an electric light line as an aerial for the reception of radio signals. Es-



Illustration by courtesy of Dubilier Condenser and Radio Corp.

entially, two or more fixed mica condensers of comparatively high capacity, in series with two metal legs attached rigidly to a standard plug for insertion in socket of electric light fixture. Terminals are provided for connection to receiving apparatus. The illustration shows one of the popular types of Aerial Adapters which consists of merely a condenser to prevent the voltage of the line from passing

directly to, or through, the instruments.

**ADAPTER, TUBE**—A device similar in form to a vacuum tube socket. Usually comprises a cylindrical form or shell of either metal or insulating material with legs identical with the tips or legs of a vacuum tube. A receptacle is allowed for the insertion of a tube, and the lead from each tip recess is so connected to a leg or tip at its base, as to permit the use of a

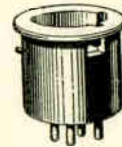

Illustration by courtesy of Patent Elec. Co., Inc.

non-standard base tube in a standard *socket* (q.v.). The illustration shows adapter for U.V. 199 or C-299 type of tube. When it is desired to employ a tube having a non-standard base in a set already equipped with standard sockets, without the necessity of changing the sockets, an adapter may be used. (See *Socket*.)

**ADHESION, ELECTRIC**—Affinity of one body for another due to dissimilar charges of electricity passing through or being carried by them. The electrical equivalent of magnetic attraction.

**ADJUSTABLE CONDENSER**—(See *Variable Condenser*.)

**ADJUSTABLE GRID LEAK**—A form of *grid leak* (q.v.) that can be easily

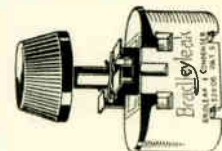

SYMBOL

Illustration by courtesy of Allen-Bradley Co.

adjusted over a wide range of values without removal from the circuit. The illustration shows one type of Adjustable Grid Leak.

**ADJUSTABLE RESISTANCE**—(See *Variable Resistance*.)

**ADMITTANCE**—The inverse of *impedance* (q.v.). In an *alternating current* (q.v.) the Admittance acts in the opposite manner to impedance. A circuit having low impedance is said to have relatively high Admittance.

**AERIAL**—A system of wires suspended in the air or in any form in which they may be insulated or kept free from surrounding objects, used for the purpose of receiving or transmitting impulses as in radio transmission and reception. The term Aerial is actually identical with *Antenna*, but due to the general English definition of *Antenna*, authorities are gradually coming to distinction between transmission and reception Aerial systems by referring to a receiving device of this nature as an *Antenna*, and when used to transmit, as an Aerial.

There are different types and forms of Aerials, varying mainly according to purpose and facilities. The stand-

ard and perhaps more commonly used receiving Aerial consists of a single wire as in Fig. 1 or several wires as in Fig. 2. The wire used is usually of copper, as this metal combines low resistance with economy, strength, and

Generally speaking, an Aerial should be as high above the ground as possible, of course within practical limits. From 25 to 100 feet is the most practical height to use. Where the Aerial is suspended at a substantial height

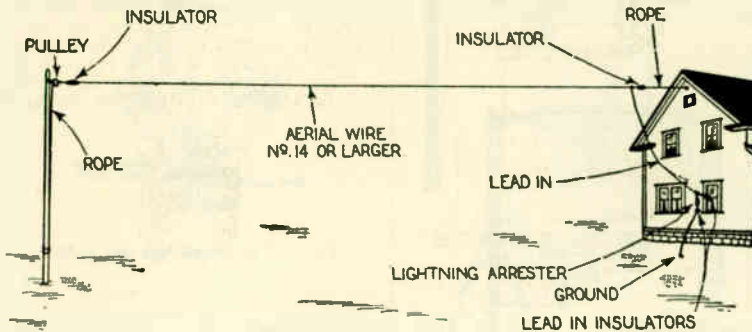

Fig. 1. A single wire aerial in the form of an inverted L. If a long wire is used, the lead-in may be connected in the center, forming a T type

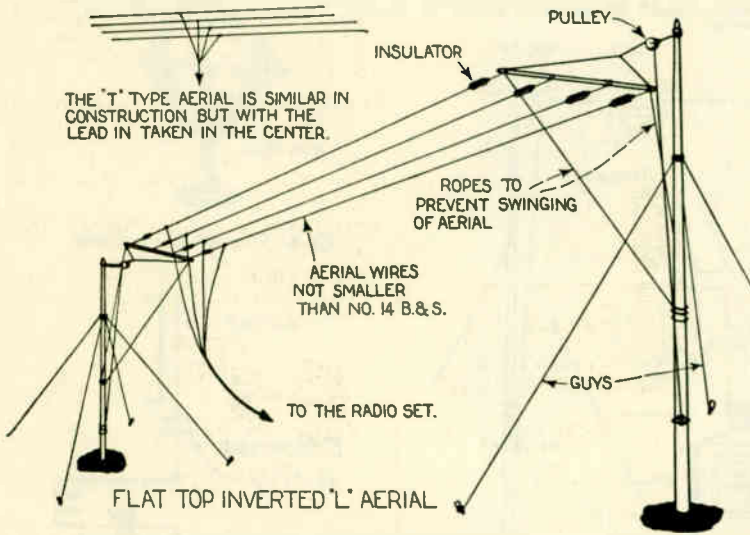

Fig. 2. Method of erecting a multi-wire aerial. This type of aerial may be made in either the inverted L or T form as shown

durability. The theory of the action of the waves either received by or transmitted from an Aerial system will be found under the heading "Electromagnetic Waves."

The exact type and extent of an Aerial will depend entirely on the available facilities and the particular purpose for which it is intended. These various forms will be taken up under their respective headings. In the receiving Aerials, Figs. 1 and 2, a certain definite wavelength (q.v.) is obtained by arranging a certain length to the wires of the Aerial system including the ground and lead-in. (See *Fundamental Wave-Length of Aerials*.) In the single wire Aerial, the lead-in is usually taken from the end nearest the receiving apparatus, but where a particularly long Aerial is to be used, it is customary to attach the lead-in to the centre of the suspended wire. The former is known as an inverted L type and the latter as a T type Aerial. These designations will apply as well where a number of wires are used as in Fig. 2.

the incoming waves will be less likely to be obstructed by surrounding trees or buildings, and in the case of transmission the same factor will apply, inasmuch as the waves may be obstructed in their transmission, if build-

ings or trees closely surround the Aerial.

The insulation of an Aerial is of particular importance, and especially so in the case of a transmitting Aerial. The reason for insulating an Aerial is to prevent the currents from escaping to the ground by way of trees, buildings, or the masts to which the Aerial is attached.

Fig. 3 shows a method of arranging an indoor Antenna system where it is not possible to use the out-door type. The construction may be essentially the same as the usual form of outdoor Aerial and can be arranged in a number of different ways. Very often a wire is merely suspended around two sides of a room and insulated from the moulding. One end will be connected as a lead-in to the receiving apparatus. In constructing an indoor Antenna, it is well to remember that the effective length of the Antenna is not much greater than the direct distance from the receiving set to the farthest point of the Antenna.

Fig. 4 shows a different type of Aerial known as the Cage type. The illustration shows an inverted L, and the T arrangement. Fig. 5 shows a Fan Aerial and Fig. 6 the umbrella type. The illustration, Fig. 7, shows one type of loop Aerial (q.v.) and Fig. 8 the same general type in somewhat different form. Owing to the fact that the theory of operation of a loop Aerial is somewhat different than the ordinary types, it will be described more fully under the heading "Loop Aerial." Fig. 9 illustrates a form of Aerial Adapter which is arranged to allow the electric light wires to be used as an Aerial. (See *Adapter Aerial*.) Fig. 10 shows an underground Aerial system designed by Dr. Rogers and which is not appreciably affected by atmospheric disturbances. (See *Strays*.) This form of Aerial, however, is generally impractical due to the difficulties in construction.

Aerials for transmitting may be of the same general types as receiving Antennas arranged outdoors, with the exception as explained previously, that heavy insulators must be used owing to the high voltage employed. Aerial for transmitting will depend for size on the wave-length desired.

Fig. 11 illustrates several types and arrangements of counterpoise (q.v.).

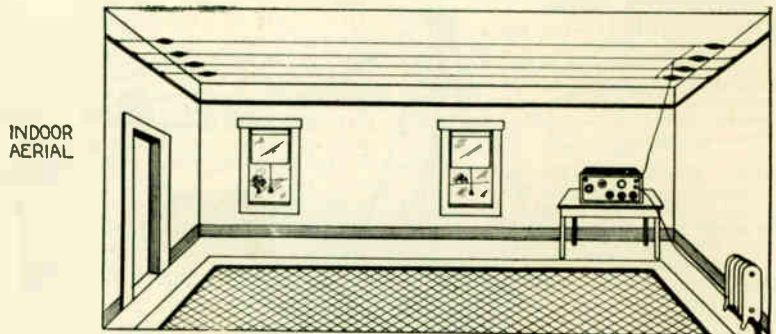

Fig. 3. Showing one method of installing an indoor aerial. While this illustrates a multi-wire type, a single wire run around the moulding of the room may give excellent results

In the case of the receiving Aerial a single wire may be from 75 to 150 feet in length, or if a number of wires are used, the over-all length may be considerably less. (See *Fundamental Wave-length*.)

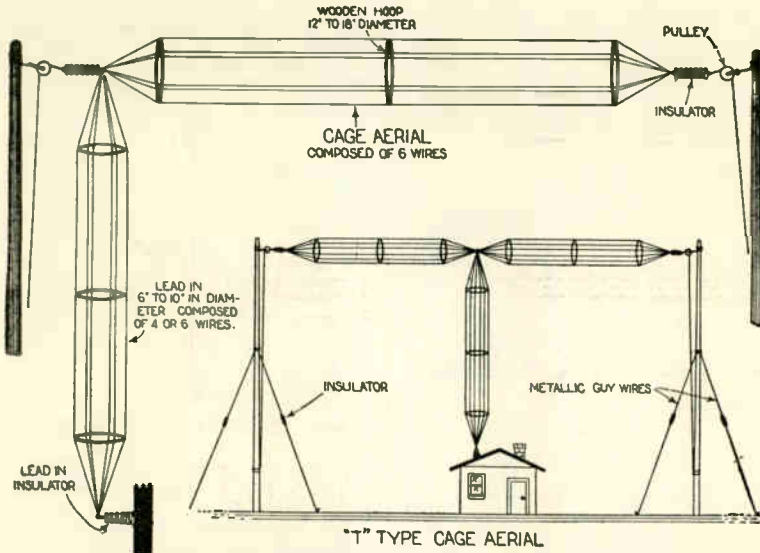

Fig. 4. Cage aeriels are usually employed for transmitting purposes. The inverted L and T types are erected as shown

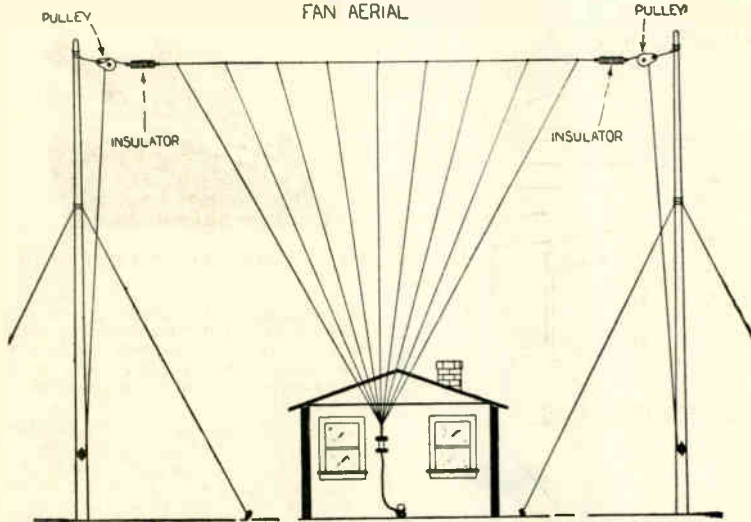

Fig. 5. The fan aerial has its wires spread apart at the farthest point, forming a fan

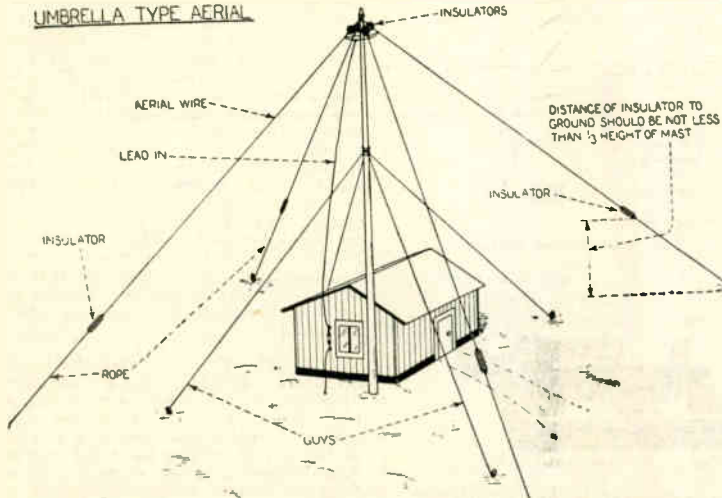

Fig. 6. The umbrella type of aerial derived its name from the arrangement of its wires in the form of an umbrella

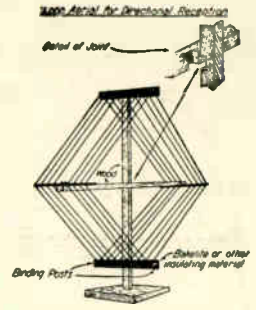

Fig. 7. The selenoid type loop aerial

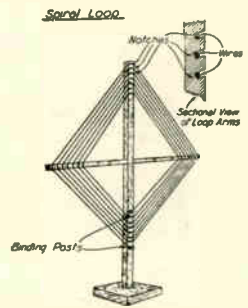
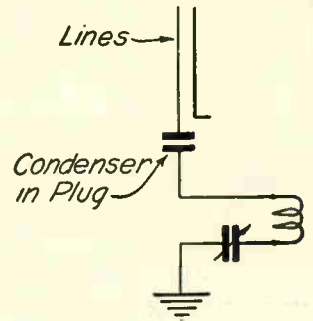

Fig. 8. The spiral type loop aerial



Light Line Aerials

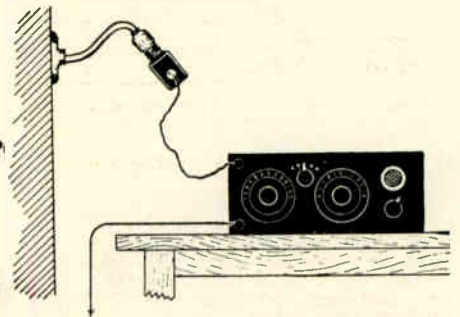

Fig. 9. Method of employing the electric light line as an aerial with an aerial adapter. Above is shown the diagram of the condenser in connection with the aerial circuit of a radio set

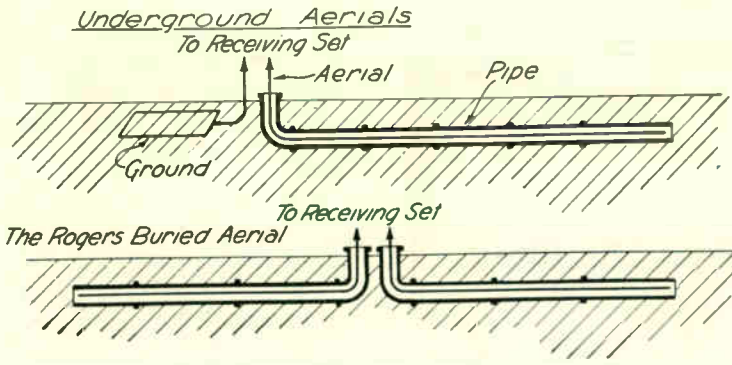
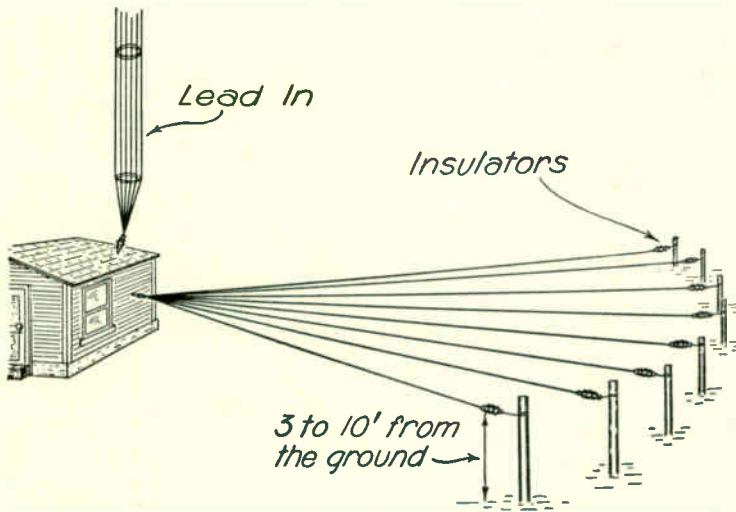

Fig. 10. Showing how wires are buried in the ground for aerials

Counterpoises



Various Shapes of Counterpoises

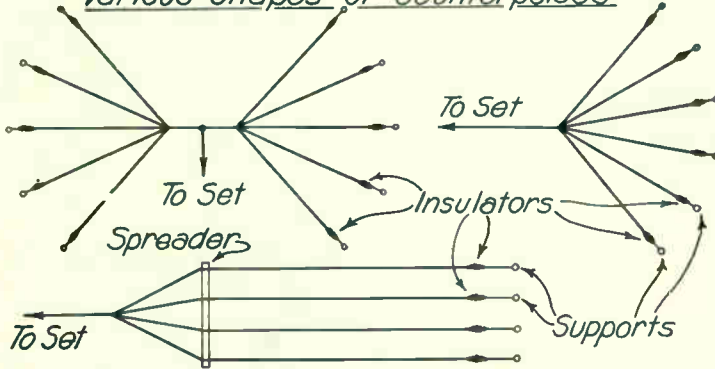

Fig. 11. Different methods of arranging counterpoises for either transmission or reception

**AERIAL CAPACITY**—(See *Capacity of Antenna*.)

**AERIAL CIRCUIT**—Consists of aerial and earth or ground, including all coils or inductances, condensers, etc., which may be connected with the aerial and earth and forming a direct path between those points.

**AERIAL SWITCH**—A device to transfer the aerial and ground connections

from the transmitting circuit to the receiving circuit or vice versa. Its

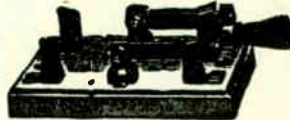

Fig. 1. A simple Aerial Switch

object is to separate the high tension current of the transmitter from the

low tension of the receiver. The switch is usually installed in a convenient position so that the operator may change from transmitting to receiving by one motion of the hands. A

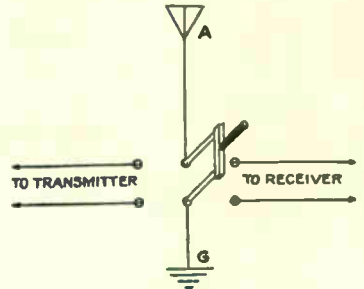

Fig. 2. Circuit for a simple Aerial Switch

simple form of aerial switch is illustrated in Fig. 1. The circuit for same is shown in Fig. 2. A more efficient circuit is the one shown in Fig. 3. This circuit requires another blade to control the primary current to the transformer. The latter circuit is most

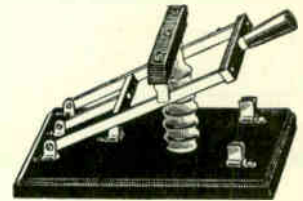

Fig. 4. An Aerial Switch with an extra blade

satisfactory as it entirely disconnects the current to the transformer, doing away with the possibility of dangerous shocks to the operator. The switch commonly used in such circuits is shown in Fig. 4.

The switches used in the various commercial wireless stations are of course more complicated. There is a need to control many circuits with the simplest possible method. In order to do this it was found more convenient to only change the aerial connections, and allow the ground connection to both the receiver and transmitter to remain permanently. This of course necessitates a small air gap in the aerial for the transmitter. This is called an *anchor gap (q.v.)*. This small appliance allows the transmitter to be connected continuously to the aerial as the high voltage from the transformer discharges across the small air gap, as provided for in the *anchor gap (q.v.)*. Fig. 5 shows the circuit when this type of aerial transfer is to be used. When the switch handle is pushed down it makes connections with the receiver, when it is raised, the transmitter is ready to be used as the primary current is connected also.

**AERIAL TUNING CONDENSER**—A condenser (*q.v.*), usually variable, connected in the aerial circuit (*q.v.*) for the purpose of adjusting the natural period of the receiving circuit to the period of the incoming waves (see *Wavelength*) or signals coming from the aerial. In the illustration is shown an Aerial Tuning Condenser.

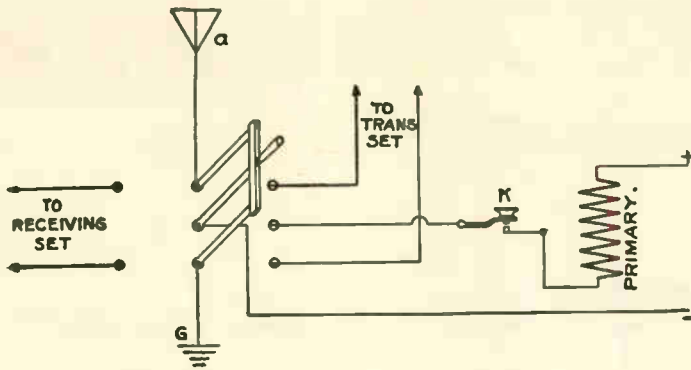

Fig. 3. Circuit for the Aerial Switch shown in Fig. 4 on page 7

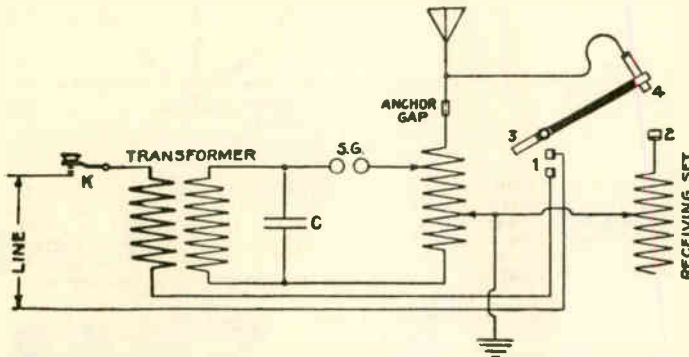
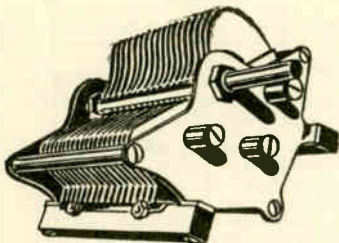

Fig. 5. An Aerial Switch employed in conjunction with an Anchor Gap as explained on page 7

Any *capacitive (q.v.)* means of establishing or varying the *oscillation constant (q.v.)* of the receiver.



A variable condenser such as commonly used for an Aerial Tuning Condenser (see page 7).

**AERIAL WIRE**—The wire forming the *aerial (q.v.)*. Copper is generally used for this purpose as it offers very little

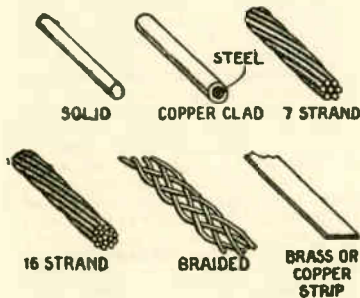

*resistance (q.v.)* to the feeble currents in receiving.

The illustrations show various types of wire as used for aerials. Among

them there are the solid copper wire, copper clad steel wire, stranded wire, braided wire and brass or copper strip.

**AERO-FERRIC INDUCTANCE**—The *inductance (q.v.)* of coils wherein the *magnetic circuit (q.v.)* is completed through both air and iron.

**AEROPLANE ANTENNA**—Receiving or transmitting *antenna (q.v.)* used on an aeroplane. The commonest form is a suspended wire shown as A in the illustration. The ground or coun-

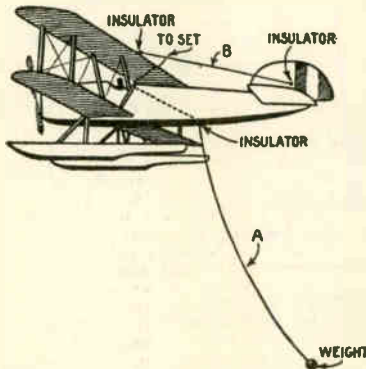

*terpoise (q.v.)* in this case may be another wire suspended on and insulated from the fuselage as indicated at B. When the plane is in flight, the hanging wire trails up and backward, depending on the speed of the plane and the size of the weight used. This type of antenna will be slightly *directional (q.v.)* in the direction the plane is traveling. If it is impractical to

use a trailing wire antenna for any reason, a loop or coil of wire may be used, the results of course being less satisfactory. The metal frame of the plane is often used as a *counterpoise (q.v.)*

**A. F.**—Abbreviation for *Audio-Frequency (q.v.)*

**AFTER-GLOW**—Fluorescent phenomena in a *vacuum tube* after current has been withdrawn.

**AGONIC LINES**—Lines imagined as passing through points on the earth's surface where the magnetic inclination or dip of a magnetic needle (compass) is zero. (See *Aclinic Lines.*)

**AGING, VACUUM TUBE**—Gradual diminishing of the brilliancy of a tube due to the deterioration of the *filament (q.v.)* and the coating or deposit on the bulb. A tube is said to be Aging when it gradually loses its power to emit *electrons (q.v.)*

**AIR CONDENSER**—*Condenser* utilizing air as the *dielectric*. The majority of variable condensers used in radio work employ the air dielectric, that is, the space between plates is merely an air gap. Most *fixed condensers (q.v.)* use some substance such as mica, or sheets of waxed paper as a dielectric.

**AIR CORE TRANSFORMER**—A *transformer* used in radio, having no metal core, the *lines of force* having their path through air. (See *Amplifier, Radio Frequency.*)

**ALBIZ, Count**—Managing Director of the *Compañia Nacional de Telegrafia sin Hiols* in 1910, of Scotch origin.

He was born in Madrid in 1858 and received a schooling at the Madrid University and London University College. He was a Tory member of Parliament.

**ALEXANDERSON, Ernst Fredrick Werner** (1878)—Radio engineer and inventor. Born at Upsala, Sweden, January 25th, 1878, he was educated at the High School and University of

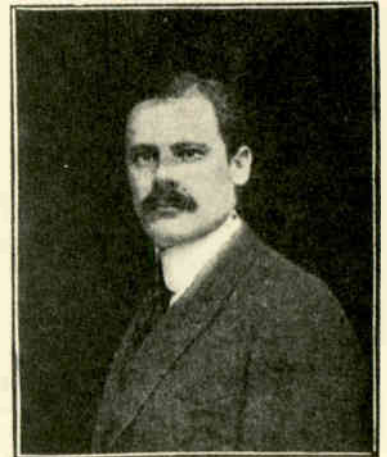

Photo by courtesy of General Elec. Co.

E. F. W. Alexanderson

Lund, Sweden, at the Royal Institute of Technology, Stockholm, and at Berlin. In 1902 he joined the General Electric Company, and has been for some years their consulting engineer. He holds the post of chief engineer to the Radio Corporation of America, and



is a member of the American Institute of Radio Engineers. Alexanderson has read many papers on electrical subjects before the chief technical societies of America.

Alexanderson is famous for his work on high-frequency alternators used in Radio telegraphy. The Alexanderson alternator is connected directly or inductively to the aerial and earth, and constitutes the simplest possible connection for producing continuous or undamped waves. It is a machine of great speed and many field poles, and frequencies as high as 200,000 cycles are obtained. For long distance work, employing very long wavelengths, this high-frequency alternator is largely used. Alexanderson is also responsible for the magnetic amplifier, patented in 1913, and has carried out successful experiments on duplex wireless telephony. In the Alexanderson microphone transmitter the modulation is mainly effected by variations in the tuning of the aerial circuit.

**ALEXANDERSON ALTERNATOR**—A type of high-frequency alternator (q.v.) which produces continuous oscillations (q.v.)

**ALLOY**—A compound of two or more metals. (See Woods Metal.)

**ALTERNATING CURRENT**—An electric current that does not flow steadily in one direction—as from positive to negative—but completely reverses its

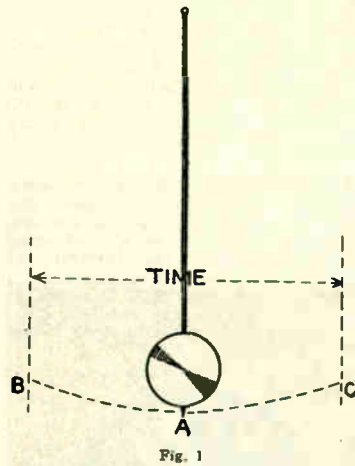

direction or polarity (q.v.) at certain definite intervals. In other words, the current flows first in one direction and then reverses and flows in the opposite direction—these changes being referred to as changes of phase (q.v.). An electric current is either direct (q.v.), alternating, or pulsating. The latter is an alternating current that has been rectified. (See Rectified Current.) Practically the only direct current that is employed or appears in a radio receiver is that supplied by the "A" and "B" Batteries (q.v.). In an alternating current, the change in direction or polarity takes place in a steady, even manner.

An understandable analogy for alternating current is its comparison with a pendulum. In Fig. 1 the pendulum is supposed to be the alternating current or impulse. Now when the bob is swung from its natural (neutral) position A, which may be con-

sidered as zero value of voltage or current, it will move to a maximum point, either B or C. If we assume B to be the positive side, then the bob

will move to B which will be the maximum positive amplitude (q.v.). It will then fall back to zero again, and with the power behind it, the momentum in this case, will rise on the other side to C, which is the maximum negative

usually rises toward that side until at 3 P. M. it has reached its maximum height. In the case of an alternating current, we may consider that at 3 P. M. the current has reached maximum value on the positive side or in

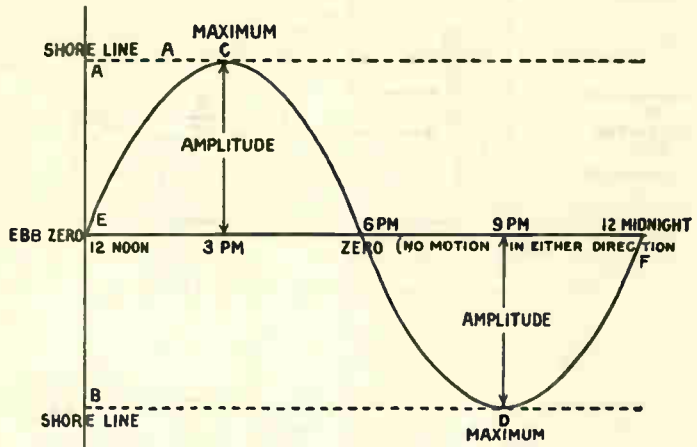

Fig. 2

will move to B which will be the maximum positive amplitude (q.v.). It will then fall back to zero again, and with the power behind it, the momentum in this case, will rise on the other side to C, which is the maximum negative

ALTERNATING CURRENT SINE WAVE

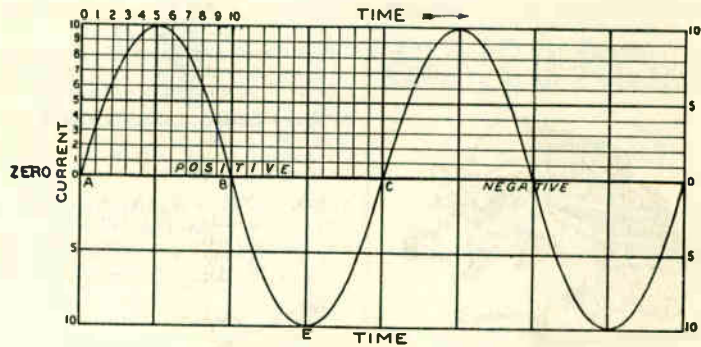

Fig. 3

amplitude. The bob will then fall back to A once more and will have undergone a complete change of direction and values; it will have gone through a cycle (q.v.). That is to say, it will have risen from zero A to positive maximum B, then back to A, rising on the other side to negative maximum C and back to A. Now the length of time required for this complete cycle (see Alternation), is known as the time period of vibration or phase change. If, for example, it required one-sixtieth of a second for this change to take place, then we say that the frequency (q.v.) is sixty cycles, because obviously, a change requiring one-sixtieth of a second will occur sixty times in one second.

The action of alternating currents may also be likened to that of ocean tides. In Fig. 2 the curved line represents the water in motion and is to be compared with current in motion in an alternating circuit. For the sake of clarity, we can assume that the tide rises and falls between two shore lines,

a positive direction. It then reverses and falls toward zero until at 6 P. M. it has reached the zero point. In the case of the current, it will have become zero. Motion again starts in the other direction and the tide rises once more, but in the opposite direction, toward shore line B. By 9 P. M. it will have reached maximum height in this direction, or in the case of the current it has reached maximum value or amplitude (q.v.) at D on the negative side. It then falls back again to zero, and at 12 midnight has come back to its original starting point, having gone through all stages of value or height from zero to maximum at one shore and then back to zero; then from there to maximum at the other shore and back to zero. The action of the alternating current then will have been to flow from zero to positive maximum, back to zero and reversing, from zero to maximum on the negative side, then back to zero. It will have completed one cycle. The time required for the tide to go

through these changes E to F is 12 hours and is known as the *time period* or *period* (q.v.). Therefore, the time required for a complete change in the case of alternating current will be referred to as the period. The number of times that these changes take place within a certain time limit is known as the *frequency* (q.v.)

The current value in Fig. 3 is assumed to be 10 amperes, and the current values at any moment are shown as *ordinates* (q.v.), (vertical) while the time is shown in the *Abscissas* (q.v.) (horizontals). If the above curve is to be assumed as representing the Sine wave of an Alternating current having a frequency of 60 cycles per second, the total time in the chart would be one-thirtieth of a second. Thus, Time A to C would be one-sixtieth second, the Time of one complete cycle. A B is a positive Alternation, D and E represent maximum current values in each direction.

If the above Sine Wave is to be used as an example of a high frequency oscillation as in radio, the Time of one cycle can be assumed as about 1

second. (See *Frequency*-1,000,000

*Oscillation - Sine - Phase - Characteristic of Alternating Current.*)

The frequency of an alternating current depends on the number of poles (field magnets) and the speed of rotation when the A.C. is generated by an alternator. (See *Alternator*.)

**ALTERNATING CURRENT, THEORY OF PRODUCTION OF**—Electric current in motion along a conductor always has a magnetic field (*magnetic flux*) surrounding it. If this current is passed near a number of turns of

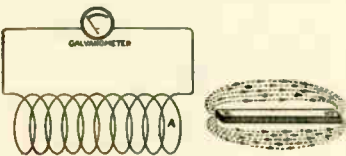

Fig. 1

wire, the lines of flux will link with the wire turns in the circuit. The number of flux lines through a coil will depend upon the current. A change of current will change the number of linkages. If two turns of wire are used, the circuit will link twice with the same magnetic flux. Thus, a change in the current or a change in the number of turns of wire will alter the linkages.

Now in the case of Fig. 1, the magnet being placed near the coil causes lines of force to pass through the coil.

Each turn of wire will link the flux lines. Now any change in these linkages between the flux lines and wire turns will produce an E.M.F. (*electro motive force*) in the circuit of the wire turns. This is called an "induced current" because it is induced by the change in linkages. In Fig. 1, we have a coil of wire in a circuit with some sensitive measuring instrument for minute currents, in this case a *galvanometer*. Near it we have a bar magnet. When this magnet is moved toward or within the coil, a current is induced in the circuit by reason of the change in linkages. This current is *always* in a direction to *oppose* the

change that causes it. (See *Lenz Law*.) "Whenever an induced current arises by reason of some change in the linkages, the magnetic field about the induced current is in such direction as to oppose the change." When the magnet is moved toward the coil, the change in linkages creates or induces a current that flows in the circuit in

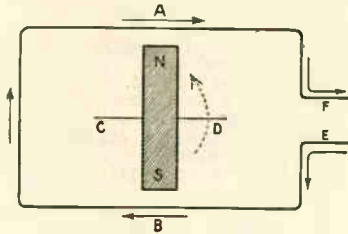

Fig. 2

such manner as to make A act as a North pole. As the North pole of the magnet is toward this point A, the similar poles will oppose each other according to the simple law of magnetic attraction and repulsion. Now if we attempt to withdraw the magnet, the change will alter the linkages again, this time creating an induced current that makes A act as a South pole, thus *attracting* the magnetic North pole and opposing in the op-

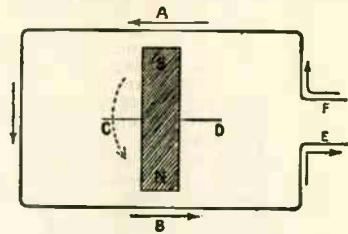

Fig. 3

posite manner, the change in linkages that have created the current.

We already know that if a conductor is moved across a magnetic field, an E.M.F. is induced in the conductor. The action is the same whether the

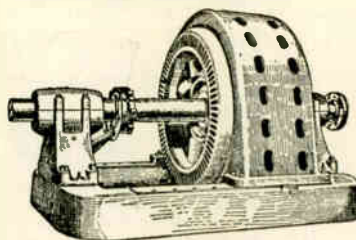

Fig. 4

conductor is moved across the magnetic field or vice versa. In Fig. 2, a magnet is shown in position on an axis—C D for rotation within the loop A B. As the magnet is rotated, the North pole passes across A, an E.M.F. is created toward F in the same direction. As the position of the magnet reverses in rotation and S passes A while N passes B, a current is induced in the *opposite* direction, both times in accordance with the law previously stated. Thus, if a meter is connected between the ends of the loop at E F and the magnet rotated, a current will

be registered. With each half turn of the magnet, this current will reverse its direction. Therefore, we have produced an alternating current that changes direction with each reversal of the position of the magnets. This is the simple AC generator or alternator. The illustration, Fig. 4, shows a standard type of low frequency alternator.

**ALTERNATION**—In an alternating current, is the rise from zero to maximum amplitude and back to zero on either side, i.e., *positive* or *negative* directions. Two alternations—one positive and one negative—make a complete cycle. (See *Alternating Current*.)

**ALTERNATOR**—A machine for the purpose of changing mechanical energy into electrical energy. Fig. 1 shows an alternator in its elementary or

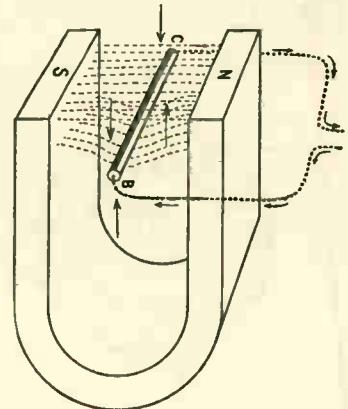

Fig. 1

simplest form—merely a conductor, B C moved across a magnetic flux (q.v.) (Note: For a complete explanation of the production of alternating currents, see "Alternating Current, Theory of Production of.") Here the conductor B C is moved to the right across the magnetic flux shown as dotted lines between N and

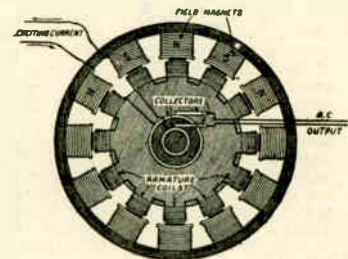

Fig. 2

S, the poles of the magnets. As the conductor moves across the flux lines of the magnet, an *electro-motive force* (q.v.) or *electric* current is set up or induced in the conductor, this force being in such a direction that the current produced will create a flux or magnetic field, in the same direction as the flux on the side of the conductor that comes first into contact with the flux lines N S on moving the conductor. In this case E.M.F. (*electromotive force*) is in the direction B to C in the conductor. In order to establish a circuit and utilize the current pro-

duced in this manner, it is only necessary to attach wires to both ends of the conductor as shown by the dotted loop. Now at this moment the conductor is being traversed by a current having a definite polarity, that is to say, it is flowing in one direction only. When the direction of the flux lines N S are reversed, as by reversal of the magnet, or the conductor is turned so that the other end comes into contact with the flux lines, then the direction of the current in the conductor will reverse and it will flow in the opposite direction. In other words, with every reversal of the position of the conductor in its relation to the magnetic flux N S, or the reversal of the direction of the flux lines, with respect to the conductor, the E.M.F. that is created will change its direction of flow. (See *Alternating Current*.)

In an alternator it has been shown that the result is approximately the same whether the magnet is rotated or the conductor is rotated through the magnetic flux. In either case the moving member is known as the *rotor*

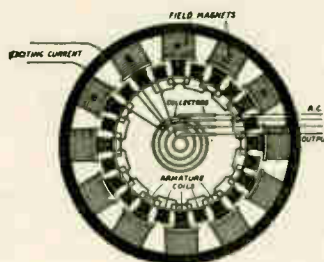

Fig. 3

(*q.v.*) and the stationary member is called the *stator* (*q.v.*). The magnets producing the flux lines may be stationary or they may revolve; in either case they are referred to as the "field" (*q.v.*).

It has been shown that with every change in the relative position of the field magnets and the armature (*q.v.*), irrespective of which member is the rotating one, a change of direction of the induced E.M.F. takes place. Then it is apparent that in order to increase the number of changes, that is, to increase the frequency (*q.v.*), it is only necessary to use (1) a greater number of field magnets, or (2) have the armature or conductor pass the magnets more frequently by means of greater speed in the rotating member, or by means of both. Now each of these changes is an alternation (see *Alternating current*) and two such changes will be a cycle (*q.v.*). Let us suppose that the moving member of a certain alternator has a rotary speed of 720 revolutions per minute and there are 10 poles or magnets. As frequency is figured by the changes per second, it will be necessary to reduce this number to the revolutions per second. Thus, there will be 12 revolutions per second. This figure multiplied by the number of poles (*q.v.*), which we assume as 10, indicates 120 alternations per second. As there are two alternations to each cycle (*q.v.*), the frequency in this case will be 60 cycles. The equation is as follows:

$$F = \frac{P}{2} \times \frac{N}{60}$$

where F is the frequency, P, the number of poles and N the speed of rotation per minute. The exact voltage or

E.M.F. obtained will depend on the number of poles and the speed of rotation, and also on the distribution of the field windings and total flux from all the poles or magnets. In designing alternators the effective E.M.F. (electromotive force) is expressed by the formula:

$$E = \frac{K P \phi N Z}{10^8}$$

E is the effective electromotive force of the alternator.

K represents the E.M.F. factor of the alternator. This factor depends upon certain characteristics of the poles and also the distribution of the windings on the armature.

P is the number of poles of the field magnets.

$\phi$  is the number of lines of magnetic flux that flow from one pole across the gap to the armature—known as the useful magnetic flux per pole; (see *Maxwells*).

N is the speed of rotation of the rotor in revolutions per second.

Z is the total number of conductors on the surface of the armature.

$10^8$  represents the number 100,000,000—the calculation given would be de-

termined in *abvolts* (*q.v.*),  $\frac{1}{100,000,000}$

volt and it is therefore necessary to reduce it to volts by division.

In the "revolving field" alternator, as explained above, the field magnets are rotated and the conductor remains stationary. The windings in which the E.M.F. is produced, are placed in slots in the inner surface of the stator, and the windings composing it being the *armature*.

In the alternators of the revolving armature type, the conductors or armatures are the rotating member and the field magnets remain stationary. Fig. 2 shows the revolving armature type of alternator in diagrammatic form. A small direct current generator (*q.v.*) may be used to excite or build up the field. That is to say, a

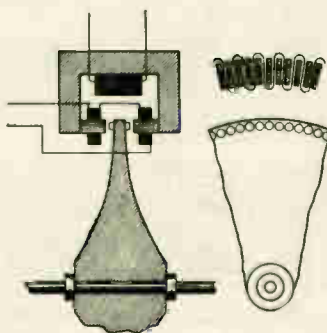

Fig. 4

current is sent through the field magnets (windings in this case) for the purpose of increasing or building up the flux density (*q.v.*). This is known as an "exciter" (*q.v.*). The exciter may be mounted directly on the end of the rotating shaft of the alternator, or mounted separately and connected to the alternator rotor shaft by means of a belt. This permits a heavy field to be built up by the electro-magnets used in place of the ordinary magnet shown in Fig. 1. If the machine is to be *single phase* (*q.v.*) there will be

two collector rings (*q.v.*), the two phase type will have four rings, and the three phase six rings. The illustration Fig. 2 shows the general design of a single phase alternator. In this case there will be of course only two rings to collect the E.M.F. set up by the machine. Fig. 3 illustrates the general scheme of armature winding for a two phase machine. Here there

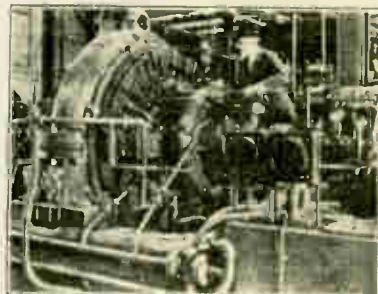

Fig. 5

are actually two separate E.M.F.'s set up by the separate windings and the ends of each of these windings are connected to collector rings as shown. In the three phase arrangement there may be three separate windings and six collector rings.

The use of the revolving armature type for comparatively small voltages is due, as mentioned previously, to the fact that they are easily constructed, and also the advantage that the exciter need not be an external source, but may be a separate winding with a commutator (*q.v.*) mounted on the main shaft. The revolving field type of course allows much greater space for the armature winding, inasmuch as the stationary member is not limited to any particular space, whereas the moving member must be arranged as small as possible to do away with mechanical troubles. Thus, the stationary armature can be wound and properly insulated for great voltages. For this reason the revolving field is generally used in high power work. Another point of importance is that where the armature revolves, the windings must be made very carefully as the centrifugal force due to rapid rotation of the members places a great strain on them.

One of the widely used forms of alternator for extremely high frequencies, is the Alexanderson, named after its originator, Ernst Alexanderson (*q.v.*), a noted engineer. This machine is of the inductor type. It is a well-known fact that magnetism is more readily established through iron than through air, and therefore when iron is placed in the air gap of a magnetic circuit, the lines of force or flux lines are greatly increased. Then when the iron is withdrawn, the flux lines fall to their original value. We have seen that as changes of flux take place throughout a magnetic circuit an electromotive force is induced in a coil or conductor (armature) surrounding the magnetic circuit. Now, if iron is periodically inserted into and withdrawn from the magnetic field, an alternating current will be set up in the coil surrounding the field. This principle is made use of in the inductor alternator and the field and armature thus remain stationary, contrary to the usual form of an alternator. Now if we arrange to have pieces of iron moved rapidly in the gap between field and armature, changes of flux will

take place. Obviously, it is easy in this manner to create many changes of flux within a certain time, and therefore the alternating current set up (E.M.F.) will have a high frequency as seen by the explanation of this phenomena given previously. These moving pieces are so arranged that they practically close the gap between field and armature with only enough clearance to prevent the rotating member striking the stationary members. This is briefly the principle of the Alexanderson alternator. Fig. 4 shows the general plan of an inductor alternator. On the right shows the scheme of winding in slots around the entire form, and as there are necessarily many windings in order to obtain the high frequency, they are generally single turns of wire, each turn having a separate slot. On the left is given a general idea of the arrangement of the rotor, which in this case, as explained previously, is neither field nor armature, but iron teeth arranged on the periphery of the moving disk. The field is increased or excited in the usual manner by means of a source of direct current. In the assembly, the relation of the moving disk to the field and armature is shown. Fig. 5 is a commercial type of Alexanderson Alternator having a frequency (q.v.) of 100,000 cycles used for high power radio transmission (q.v.).

**ALTERNATOR, SINGLE PHASE**—(See *Alternator*.)

**ALTERNATOR, POLYPHASE**—(See *Alternator*.)

**AMMETER OR AMPERE METER**—An instrument for measuring current in amperes in a circuit. Is connected in series with a circuit. Exists in a variety of forms. The operation of the most commonly used type depends upon the fact that the force a magnet exerts depends upon the number of *ampere turns* (q.v.). Therefore, the greater the current sent through its coils, the greater will be its attraction for a balanced armature. Fig. 1 shows a common form of ammeter.

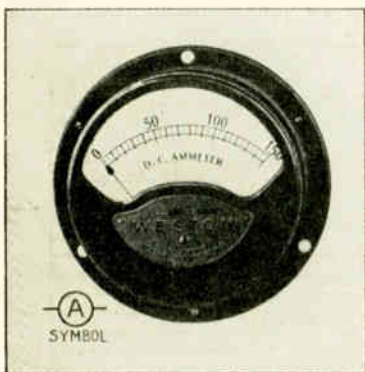

Photo by courtesy of Weston Elec. Inst. Co.

Fig. 1

**AMMETER, THERMAL** — Commonly known as "*Hotwire Meter*." Also called "*Aerial Ammeter*" and "*Radio Frequency Ammeter*." Operates on the principle of thermal expansion, i.e., the tendency of a wire to expand with heat of current passing through it. Is used to measure current in amperes at extremely high voltages as in

radio transmission. Figure 2 shows a Thermal Ammeter which is generally employed in radio work.

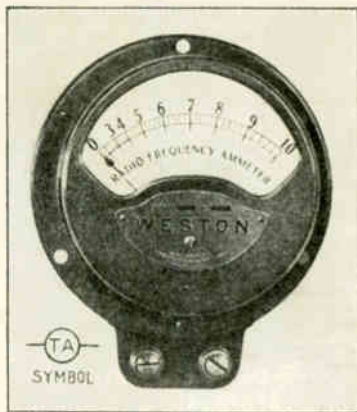

Photo by courtesy of Weston Elec. Inst. Co.

Fig. 2

**AMP.**—Abbreviation for *Ampere*.

**AMPERE**—The practical unit of the rate of flow of electricity. It is the unit current, or the rate of flow when one *coulomb* (q.v.) flows each second. The value or strength of electric current is almost invariably given in amperes. This unit is used to express the flow of a definite quantity of electricity in a second. If, for example, ten coulombs pass a given point in a circuit in one second, then we say that the current in that circuit is ten amperes. (See *Coulomb*, *Milli-ampere*, *Micro-ampere*.)

**AMPERE, Andre Marie**—A distinguished French physicist, born 1775, died 1836. Noted for his researches in the field of *electro-dynamics*.

**AMPERE-HOUR**—Commercial unit of quantity. Is that quantity which flows in one hour through a circuit carrying a current of one *ampere*. It is equal to 3,600 coulombs.

**AMPERE, INTERNATIONAL**—Symbol *a*—is defined as the unvarying electric current which deposits silver at the rate of 0.00111800 gram per second from a specified solution of nitrate of silver in water.

**AMPERE'S RULE FOR DEFLECTION OF NEEDLE**—"If one swims with the current and looks at the plus (+) or *north seeking pole* of a magnetic needle it will be deflected to the left, while the negative (−) or *south seeking pole* will be urged to the right."

**AMPERE'S THEORY OF MAGNETISM**—The theory advanced by *Ampere* that an *electric current continually circulates around each molecule of a magnetic substance and that the process of magnetization is one of arranging these currents in such manner that they all take the same direction*.

**AMPERE TURNS**—Expressed by the product of number of turns of, and the number of amperes flowing through, the coils of an electro-magnet. Thus, one ampere turn would be one ampere flowing through one turn. The ampere turn is very frequently used as a unit of *magneto-motive force* (q.v.) due to the ease with which it can be obtained.

**AMPERE VOLT OR VOLT AMPERE**—

The expression sometimes used to denote *watts* (q.v.). For example 1 volt ampere will be one watt, as watts are equal to the product of the volts and amperes in D.C. circuits. (See *Efficiency*, also *Watts*.)

**AMPLIFICATION CONSTANT**—The factor expressing the maximum voltage *amplification* (q.v.) that it is possible to obtain with a given vacuum tube. Thus, if a certain tube will permit amplification of eight times the original voltage, the amplification constant is said to be 8. (See *Vacuum Tube*.)

**AMPLIFICATION FACTOR**—The ratio of the change of instantaneous voltage, between filament and plate of a *vacuum tube* to a small change of instantaneous voltage between filament and grid for a given constant plate current:

$$\mu = \frac{\delta V_p}{\delta V_g}$$

The ratio of power (radio signals), voltage or current output of an amplifying device to the power, voltage or current delivered to the input terminals. Generally speaking the degree of increase in amplitude or volume by insertion of an amplifying device in the circuit. (See *Amplification Voltage*.)

**AMPLIFICATION, VOLTAGE**—In a *vacuum tube* the ratio of the voltage apparent between the terminals of an impedance in series with the *plate*, to the voltage impressed on the *grid*. (See *Amplifier*.)

**AMPLIFIER**—One of the most important features of the *vacuum tube* (q.v.) is its ability under certain conditions to amplify or increase the intensity of electric currents. Such tubes are generally referred to as *amplifier tubes* and an amplifier is understood to be one or more such tubes with the necessary associated circuits to accomplish amplification.

*X*—In the accompanying diagram a circuit of a typical one stage *audio frequency* (q.v.) amplifier is shown in conjunction with the *detector circuit* (q.v.). In this case the *radio frequency signals* (q.v.) are impressed at the points A-B from the aerial and ground circuit. The resulting signals at points C-D are audio frequency or voice frequency because they have undergone a change or *rectification* (q.v.). Now, if we consider only the solid lines, the circuit will be an ordinary detector circuit and the signals at C-D can be heard by merely connecting the phones at that point in place of the primary of the transformer—P-B. However, by sending these currents through the transformer and impressing them on the second tube it is possible to obtain signals at points E-F of much greater volume and yet having the same general characteristics or sound. The signals or currents will have undergone amplification—the effect of the amplified tube on a local source of power increase the amplitude, but the form or nature of the signals or waves will be the same. (This statement is not entirely true as amplification is generally accomplished only at the expense of some slight changes in the nature of the waves). They will, however, sound about the same in the phones at E-F as they will when the phones are placed at C-D, the volume at E-F being greater due to the am-

plification. (See *Distortion*). Now it must not be assumed that an amplifier in itself actually has the ability to increase power without some assistance. It is no more possible to obtain something for nothing in electricity than it is in mechanics. What actually takes place is that the am-

plification. (See *Distortion*). Now it must not be assumed that an amplifier in itself actually has the ability to increase power without some assistance. It is no more possible to obtain something for nothing in electricity than it is in mechanics. What actually takes place is that the am-

plification. (See *Distortion*). Now it must not be assumed that an amplifier in itself actually has the ability to increase power without some assistance. It is no more possible to obtain something for nothing in electricity than it is in mechanics. What actually takes place is that the am-

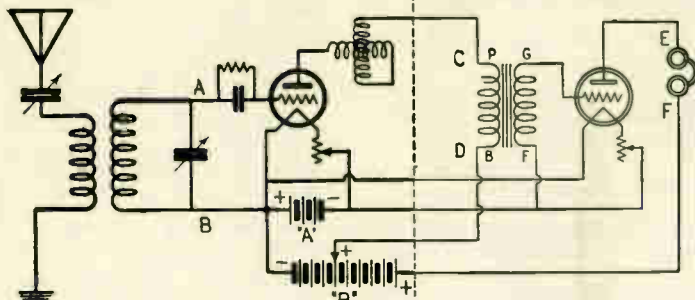

A single stage radio frequency amplifier as used in conjunction with a tuner and detector Showing the method of amplifying rectified signals at audio frequency

plifier tube and associated circuits control local power—in this case the voltage of "B" battery—in such a manner as to boost or amplify the power of the signals without materially changing their nature. Therefore, an amplifier may be considered as a device which modifies the effect of a local source of power in accordance with the variations of input power, and produces an increased output power or a means of stepping-up or increasing the amplitude or volume of a signal or series of signals. (See *Amplifier Action or Vacuum Tube*.) (See *Amplifier, Audio Frequency, Amplifier Radio Frequency, also Transformer*.)

**AMPLIFIER ACTION OF VACUUM TUBE**—The tendency of a vacuum tube to increase the power or voltage of incoming signals under proper conditions. In the illustration is shown a simple vacuum tube circuit. The incoming signals are impressed on the tube at points A and B. Now it has been noted that small changes of voltage at the grid (q.v.) will produce much greater changes at the plate (q.v.). (See *Vacuum Tube, Theory of Operation*.) In other words, the constant changes in value of the incoming signals that are impressed at A-B will produce comparatively larger changes in the current at the plate and therefore larger changes of voltage in the output circuit at C-D. These changes will of course manifest themselves in the form of signals in the phones placed at C-D. Now if these voltages are impressed on a resistance (q.v.) of suitable value—such as the primary of an amplifying transformer—they can be sent to another tube and again amplified. (See *Amplifier, Audio Frequency*.) In other words the amplifying action of a vacuum tube means the ability of that tube to use input power—the power of the signals delivered to the tube—to control a local source of power such as the "B" battery voltage used on the plate of the tube, and deliver increased power. The signals to be increased or amplified in this manner may be *Radio Frequency* (q.v.) or *Audio Frequency* (q.v.), each instance requiring a different type of amplifier (q.v.). The radio frequency signals are amplified by means of a tube and suitable apparatus (transformer or resistance) before they have been changed to

change in the nature of the signals or wave form (q.v.)

**AMPLIFIER, INTERMEDIATE FREQUENCY**—An arrangement of a radio frequency amplifier to increase the

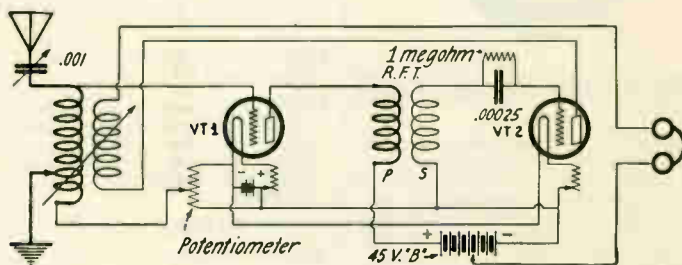

A single stage radio frequency amplifier as used in conjunction with a tuner and detector

strength of signals at the intermediate frequency (q.v.) as used in a Super-Heterodyne receiver. This is usually a radio frequency amplifier using

preceding it, there is said to be *damping* (q.v.), the degree of this damping or diminishing in amplitude being referred to as *decrement* (q.v.). Thus,

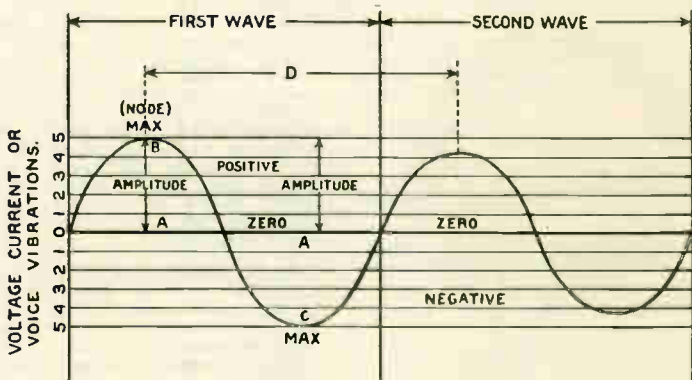

Line wave showing two cycles of an alternating current, indicating the amplitude and damping

*transformer coupling* (q.v.) the transformers being designed to cover extremely high wave-lengths. (See *Super-Heterodyne, also Transformer*.)

**AMPLIFIER, RADIO FREQUENCY**—An amplifier used to increase the volume of the incoming signals at radio frequency (q.v.) before they have been

if we assume that in Fig. 1 the current or amplitude of the first wave is 10 amperes, and the next wave has an amplitude of only 5 amperes, then the damping or decrement is 50 per cent, because the amplitude has decreased that much. Similarly, if the first wave amplitude were 10, and the second were 9 amperes, then the decrease

## Analogy

or decrement would be 10 per cent. In a damped wave the decrement or progressive decrease in amplitude must not exceed a value whose logarithm is 0.2. If it exceeds this value, it is said to be highly damped. The degree of damping is governed by government statutes. (See *Decrement and Alternating Current*.)

**ANALOGY**—"Resemblance of properties or relations; similarity without identity"—Webster. Analogies are much used in radio work for giving simple examples of difficult subjects. The most frequent analogy is the comparison of radio waves to water waves.

**ANALYSIS-ELECTRIC**—(See *Electrolysis*.)

**ANCHOR GAP**—A small spark gap in aerial circuit used to automatically disconnect the transmitter when the receiver is being used, see illustration. The powerful transmission spark jumps the gap instead of passing through the instruments. The device

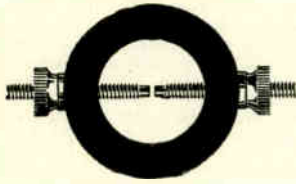

is principally employed to protect the delicate instruments of the receiving set.

**ANGLE OF LEAD OR LAG**—In a circuit traversed by alternating currents, the degree by which the current falls behind or advances ahead of, the voltage in the circuit, due to the presence and effect of *self-inductance* or *capacity*. When a coil of wire is traversed by alternating currents the self-inductance of that coil tends to make the current lag behind the applied E.M.F. (*electro-motive force*). When a condenser is inserted in the circuit carrying alternating currents, the *capacity* tends to accelerate the current and makes it precede the applied E.M.F.

X—The tangent of the Angle of Lag will be the ratio of the *inductive reactance* (*q.v.*) to the resistance of the circuit, therefore: Where  $\theta$  is the

$$\text{Phase Angle, } \tan \theta = \frac{\text{Reactance}}{\text{Resistance}} = \frac{2 \pi F L}{R}$$

The tangent of the angle

of lead will be the ratio of the capacitive reactance to the resistance of the circuit. As:

$$\text{Where } \theta \text{ is the phase angle } \tan \theta = \frac{1}{\text{Resistance}} = \frac{1}{2 \pi F C} \div R$$

These simple relations are true only when there is inductance or capacity in the circuit, and not both.

**ANGLE, PHASE**—The degree of difference in *phase* between two different currents or the angle of *lead* or *lag* in a circuit wherein the applied E.M.F. (*Electromotive Force*) does not reach maximum amplitude at the same instant as the current. (See *Angle of Lag*.) Thus, when the applied E.M.F.

and the current reach *negative* and *positive* amplitudes simultaneously, there is no phase difference, hence no Phase Angle. If for instance, one current reaches a negative or positive maximum before or after the other current, the two currents are said to be "out of phase."

X—In the illustration it will be

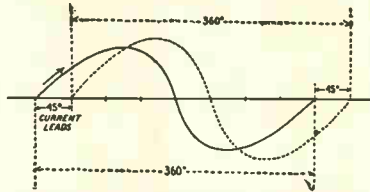

Illustrating the angle of lead. The solid line marked with an arrow indicates the current phase, the dotted line representing the voltage.

noted that the current reaches maximum value ahead of the pressure. The angle of "lead" in this case is 45°. Therefore the angle of lead is the *Phase difference* or a 45° lead with respect to the voltage.

**ANGULAR VELOCITY**—Referring to a periodic alternating current, represents  $2 \pi$  times the frequency in cycles per second, the result being given in radians per second. Thus,  $V = 2 \pi \times F$ . (See *Simple Harmonic Vibration*.)

**ANION**—The electro component. (See *Electrolysis*.)

**ANODE**—A *positive* electrode. In a vacuum tube the plate is sometimes termed the Anode, the opposite being *cathode* or *negative* element. (See *Dry Cells, Storage Battery and Electrolysis*.)

**ANODE BATTERY**—See *Plate Battery*.

**ANODE CIRCUIT**—See *Plate Circuit*.

**ANODE CONTROL**—See *Plate Control and Modulation*.

**ANTENNA, COIL**—See *Loop Aerial*.

**ANODE CURRENT**—See *Plate Current*.

**ANTENNA**—See *Aerial*.

**ANTENNA RESISTANCE**—Is usually considered as the total *effective resistance* of an antenna and the associated circuits to impulses at any particular wavelength. It, therefore, includes resistance of any sort, such as *radiation resistance* (*q.v.*), *ground resistance* (*q.v.*), etc. It is often referred to as the total loss, but this is not actually true, inasmuch as the power transmitted is in reality included in this figure known as *Antenna Resistance*.

Is regarded as an effective resistance which is equal numerically to the ratio of average power dissipated in the total antenna circuit, to the square of the effective current at the point of current maximum. In computations is held to include radiation resistance, ground resistance, *radio frequency resistance* of conductors in antenna system, and the equivalent resistance arising from *eddy currents, corona, dielectric loss, leaking insulators*, etc.

**ANTI-CAPACITY SWITCH**—See *Switch*.

**ANTINODES**—Points of greatest amplitude in a train of waves or oscillations halfway between the Nodes or points at rest. Also called "loops."

**ANTI-RESONANCE**—See *Parallel Resonance*.

**APERIODIC**—Untuned. Without *periodicity*. Attaining repose without vibrations. (See *Periodic*.)

**APERIODIC CIRCUIT**—Untuned. A circuit that has no natural *oscillating period* (*q.v.*) of its own. If a circuit has *capacity* (a condenser) and *inductance* (a coil) it has a *definite period*. If the circuit has capacity but no inductance, or inductance but no capacity, it is said to be *Aperiodic*. A current that has no period is also said to be *Aperiodic*.

The term aperiodic is generally applied to a circuit upon which are impressed R.F. oscillations differing considerably in frequency or period from the natural frequency or period of the circuit. The oscillations are said to be "forced."

X—Without *periodicity*—attaining repose without vibrations. A circuit in which an impressed *potential* will produce current that gradually diminishes in *amplitude* without reversing direction of flow. A *non-resonant* circuit.

**APPLETON, Edward Victor**—Born at Bradford, England, in 1892, and educated at St. John's College, Cambridge, where he took first-class honors in natural science. Appleton for some years made a special study of the thermionic valve (Vacuum Tube) on which he has become one of the leading authorities in Great Britain. He has been engaged in research work on valves at the Cavendish Laboratory, Cambridge, and has contributed articles on the subject to a number of scientific journals. He is a member of the Thermionic Valve Sub-committee of the Radio Research Board of England.

**ARC CHARACTERISTIC** is the curve showing the relation between *P.D.* (*q.v.*) at the terminals of an arc (usually taken as *abscissae*) (*q.v.*) and the current through it (*ordinates*) (*q.v.*). When voltage and current are increased or decreased slowly while making the measurements, the curve is called the *static characteristic*, and is the same with rising or falling current; when the voltage and current are varied very rapidly, the curve is called the *dynamic characteristic*, and the rising voltage curve is different from the falling one.

The static characteristic has a *negative gradient* or slope, hence an arc is said to have a *negative* or *falling* characteristic. The dynamic characteristic is a curve enclosing an area whereas the static characteristic is purely linear.

**ARC GENERATOR**—A machine producing a powerful electric discharge in a gap separating two *electrodes*, the continued passage of current being due mainly to the heat produced at either one or both electrodes. It generates sustained or *undamped oscillations* (*q.v.*) and is used for radio transmission of considerable power. The *positive* electrode is usually copper and is water-cooled—the *negative* electrode being of carbon.

**ARC-GENERATOR SYSTEM**—A system involving the use of the arc for the production of *continuous* or *undamped oscillations*.

**ARC OSCILLATOR**—See *Oscillator*

**ARC SPARK**—A spark in which there is a slight arcing due to some current from the transformer leaking across a gap which is too small. Such a spark gives very poor production of *active sparks*. Is generally due to insufficient *capacity* in the circuit and arises from *volatilization* of the metallic electrodes forming the spark gap.

**ARC TRANSMITTER**—See *Arc Generator*.

**ARCO, Graf George Von**—Born at Grassgorschutz, Schlesien, Germany, he was educated at Berlin University and the Technical High School, Charlottenburg.



Graf George Von Arco.

Assistant to Professor Slaby, 1898, he was part inventor of the Slaby-Arco system of wireless telegraphy. He was appointed manager of the Gesellschaft für Drahtlose Telegraphie, 1903, and first carried out a practical radio telephony demonstration over a distance of twenty-one miles in 1906. At the International Radiotelegraph Congress held at London in 1912 he exhibited a *high-frequency alternator* with static frequency step-up transformers, as now used in the high-power station of Nauen, Germany. Arco has written a large number of papers on radio, including quenched spark signalling, high-frequency alternators, the Telefunken singing spark system, long distance radio transmission, as well as being the author of a considerable number of patents, including a vacuum tube receiver circuit for high-frequency amplification patented in collaboration with Meissner in 1914.

**ARGON**—Chemical Symbol A. Atomic weight 39.9. A gaseous element, a component of the atmosphere.

Pure Argon Gas is used commercially in certain types of transmitting tubes to prolong the life of the filament. Disintegration of a filament is often rapid under stress of the heavy currents used for transmission. This tendency to deteriorate is lessened by the use within the tube of pure Argon Gas.

**ARMATURE**—The part of a *dynamo* machine in which the *electromotive force* is created due to *electromagnetic induction*. The term is also used to denote the piece of soft iron placed across the poles of a *horseshoe magnet* to prevent loss of magnetism.

In electrical machines it is commonly used to refer to the moving part (revolving armature type—see *Alterna-*

*tor*), and may be divided into two broad classes as: revolving or stationary. With regard to the core construction they are broadly classified as (a) Ring,

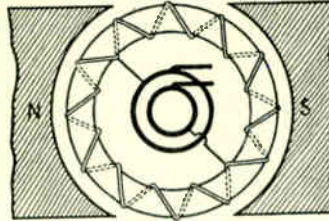

Fig. 1. Ring Type Armature.

(b) Disc and (c) Drum. Fig. 1 shows the arrangement of an armature of the Ring type; the Disc type is illustrated

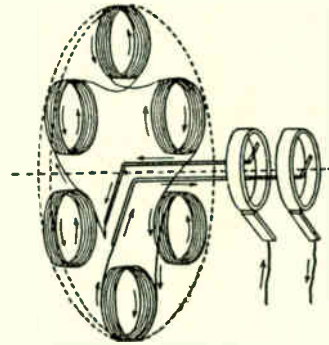

Fig. 2. Disc Type Armature.

in Fig. 2, and Fig. 3 shows the Drum type which is almost universally used; Fig. 4 shows a complete armature ready for assembly in a modern alternator.

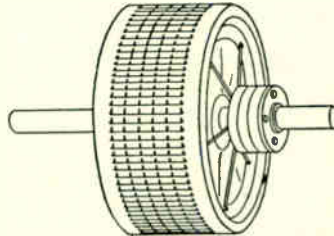

Fig. 3. Drum Type Armature.

X—The drum armature is almost exclusively used in modern generating machines. The ring type has the inherent disadvantage in that the copper inside the ring is magnetically inactive.

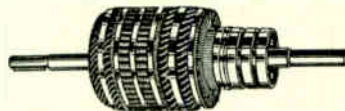

Fig. 4. A Complete Armature

The Disk type was an electrical improvement on the original Gramme Ring form, but they were impractical due to mechanical difficulties.

**ARMATURE OF A DYNAMO**—The part of a generator of electric current in which the E.M.F. (*Electromotive force*) to be utilized is produced by the relative motion of lines of *magnetic*

*force* and conductors. The conductors are sometimes called "inductors" and the iron part the "Core." (See *Armature*.)

**ARMOR**—In electrical usage, a shield or protective covering for wire or cable. Usually a lead or aluminum wrapping in convolute form.

**ARMSTRONG, Edwin H.**—Born in the United States of America, December 18th, 1890. He was educated at Columbia University, where he specialized in radio engineering. He served under Professor M. Pupin at Columbia University in the Hartley Research Laboratory, and is a director of the American Institute of Radio Engineers, the medal of which he has been awarded. Armstrong began experiments with wireless at the age of fifteen, and in 1913, while he was still a student at Columbia, he discovered the now famous feed-back or *regenerative circuit*, which was the cause of litigation, spreading over a number of years in the United States of America, before his patents were upheld. In March, 1915, he described the circuits employed by him with the *Pliotron* or three-element vacuum tube. Armstrong was the first to reveal that, with a certain value of feed-back coupling between the plate and grid circuit, a vacuum tube would become a high-frequency generator. His patent was dated January 31st, 1913. His fame became world-wide when he announced his discovery of the *super-regenerative circuit*, one of the most widely discussed and important developments in Radio. His paper on "Some Recent Developments of Regenerative Circuits," dealing with the super-regenerative circuits, was read before the Institute of Radio Engineers in New York on June 7th, 1922.

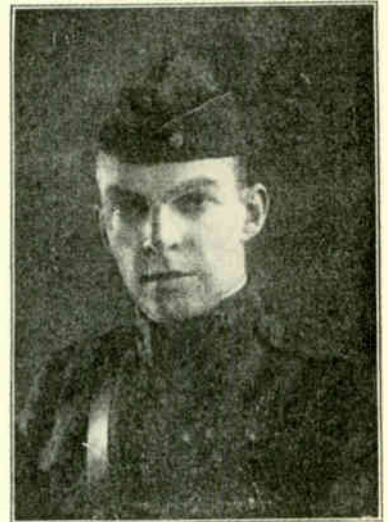

Edwin H. Armstrong.

The originator of the *super-regenerative circuit* has a number of other important patents to his credit, some of which will undoubtedly have far-reaching effects. In conjunction with Professor Pupin he invented a method for the elimination of *jamming*, especially that due to strays.

**ARMSTRONG CIRCUITS**—The various circuits devised by E. H. Armstrong, an American engineer. The more important of these are the *Regenerative*,

**Super Regenerative and Super Heterodyne.** The principle of regeneration is one that has revolutionized the art of radio reception and broadcasting. The vast majority of present day receivers use regeneration in one form or another. Basically, regeneration is the

complicated one. (See *Regeneration, Super Regeneration and Super Heterodyne.*)

**ARRESTER**—A device used for by-passing heavy electrical discharges in the atmosphere in the vicinity of the antenna when they strike the antenna.

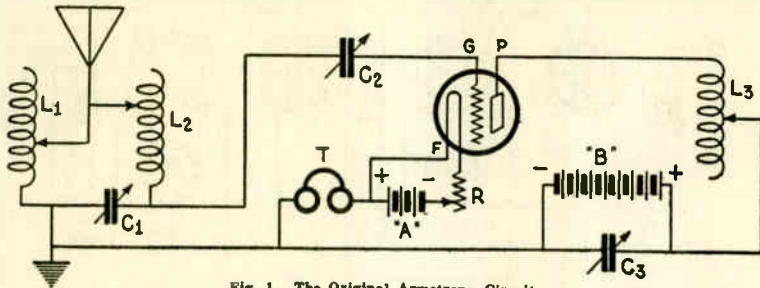

Fig. 1. The Original Armstrong Circuit.

process of returning a certain portion of the unrectified or radio frequency (q.v.) current from the plate circuit of the detector tube to the grid circuit. This has the effect of reducing the resistance of the grid circuit and thus permitting more ready passage of the weak impulses. The result is not only to greatly increase the sensitivity of the detector to weak signals, but actually to step up or amplify the volume of the received signals. In Fig. 1, coils L1 and L2 are the aerial tuning units in conjunction with the variable condenser, C1; C2 and C3 are variable condensers of low capacity; L3 is the plate control for regenerative action;

It ordinarily consists of a small gap between two metallic points connected in series with the antenna and ground in order to protect the apparatus and property against danger. (See *Lightning Arrester.*)

**A. R. R. L.**—Abbreviation for American Radio Relay League.

**ARTIFICIAL ANTENNA**—See *Mute Antenna.*

**ARTIFICIAL MAGNET**—A magnet produced by magnetizing a piece of steel that previously had no magnetic attraction. May be produced by rubbing a *natural magnet* or another artificial

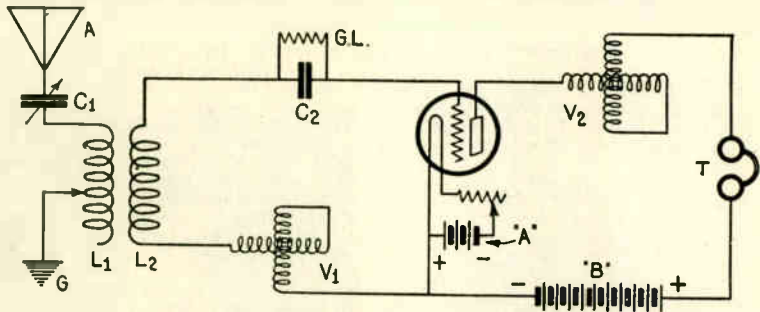

Fig. 2. The Armstrong 3-Circuit Regenerative Receiver.

T is the telephone receiver, G, P and F are respectively the grid, plate and filament elements of the tube; R the filament rheostat, and A and B the batteries for filament and plate. In the illustration Fig. 2, C1 is the aerial tuning condenser, L1 the primary coil of a standard vario coupler; V1 the grid variometer and V2 the plate or regeneration variometer. L2 is the secondary of the vario coupler, and the balance of the elements are as in Fig. 1, GL being the customary grid leak and condenser. Regenerative receivers have come into some disfavor owing to their tendency to radiate annoying signals into the antenna, and also the howling within the set when not properly adjusted. While regeneration in some form or other is used in the majority of receivers, it is not widely used now in its original state. (See *Neurodyne, Tuned Radio Frequency, etc.*)

magnet across a piece of hard steel in the same direction a number of times. (See *Electro-magnet.*)

**ASSUMED DIRECTION OF CURRENT FLOW**—The direction which an electric current is assumed to take in its flow. Current is generally considered as leaving the *positive* terminal of its source, flowing through the circuits external to the source, and thence to the *negative* terminal of the source. The direction of flow within the source itself is from the negative to the positive terminal. (See *Theory of Current Flow.*)

**ASTATIC COILS**—Coils wound in such a manner that, when connected together, they neutralize each other's effect and produce no external *magnetic field*. They are used in the measurement of inductance.

**ASYMMETRIC CONDUCTOR**—One that permits the flow of greater current in one direction than in another. Non-symmetrical as to conductivity.

**ASYMMETRICAL EFFECT**—The lack of symmetry in the directional effect in a loop or frame aerial due to lack

of symmetry in construction. (See *Loop Aerial.*)

**ASYNCHRONOUS**—A term used in referring to AC (Alternating Current) motors or generators and also to *dischargers* used in radio transmission. As applied to alternating current machines it is signified that the speed of rotation of the machine does not have any definite relation to the frequency of the currents produced—thus, out of *synchronism*. (See *Synchronism.*)

An asynchronous radio circuit is one which is not tuned to, or in syntony with, the frequency of the oscillations impressed on it. (See *Aperiodic.*)

**ASYNCHRONOUS ROTARY DISCHARGE**—A spark discharge produced at electrodes of a rotary discharger (q.v.) for transmitting radio signals, in which the spark rate or number of sparks per second has no relation to the frequency of the alternating current. (See *Spark Discharge.*)

**ASYNCHRONOUS SPARK GAP**—See *Spark Gap.*

**ATMOSPHERIC ABSORPTION**—The portion of the total reduction of radiated power due to atmospheric conductivity, reflection and refraction. The amount of energy loss in radio transmission due to atmospheric factors. This applies only to *electromagnetic waves* (q.v.) in motion in the ether and should not be confused with the reception losses due to atmospheric disturbances.

**ATMOSPHERICS**—See *X's, Strays, Static.*

**ATTENUATION**—of the electric or magnetic intensity or of the average energy density in electric waves refers to the reduction in strength with increase of distance traversed due to absorption or equivalent losses, as distinguished from the reduction in strength due to geometrical divergence. In free space, the geometrical divergence of waves from a small source involves a diminution of the average energy density in accordance with the inverse square law; plane waves (e.g., along wires) suffer no reduction by divergence, but undergo attenuation due to resistance and other line faults. (See *Attenuation, Geometrical Divergence.*)

**ATTENUATION, GEOMETRICAL DIVERGENCE**—The gradual decrease in strength of electromagnetic waves (radio signals) as the distance which they have traversed increases. The effect on the waves as they travel through the air is essentially the same as in the case of light waves. Now if a beam of light is viewed one mile from its source it will have a certain intensity, but if it is viewed again from a distance of two miles the intensity will be much less. In the case of radio waves, the intensity is said to decrease as the square of the increased distance traveled; that is to say, if they have a certain power at a distance of five miles from the transmitter, the same waves at twice the distance or ten miles will be found to have a strength only one-quarter as great. Similarly, if the waves travel fifteen miles or three times the distance, the signal strength will be only one-ninth that of the same waves at a distance of five miles from the transmitter.

**AUDIBILITY**—The measure of strength of received radio signals as heard in a



telephone receiver connected to the radio receiving apparatus. A radio telegraph signal which is at all audible can be read, i.e., the dots and dashes distinguished from one another; radio broadcast programs heard with at least some degree of clarity.

**AUDIBILITY (Radio Telegraph)**—A measure of the ratio of the telephone current producing a signal in a telephone receiver to that producing a barely audible signal. (A barely audible signal is one which just permits the differentiation of the dot and dash elements of the letters sent in code.) In the simple shunted telephone method of measuring signals the audibility is defined as:

$$K = \frac{s + t}{s}$$

where *s* and *t* are the impedances of shunt and telephone respectively.

**AUDIBILITY FACTOR**—A measure of signal strength obtained by observing the resistance to be placed in shunt with the telephones of a receiving station to reduce the signals to unit audibility. Approximately, the audibility factor is proportional to the power absorbed from the signal waves by the receiving apparatus. Unit audibility is the strength of signal at which dots and dashes can just be discriminated.

**AUDIBILITY METER**—A device for comparison of the strength of received signals, either from different stations

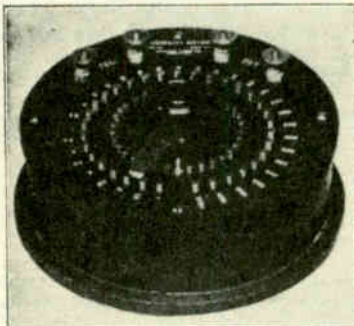

Photo by courtesy of General Radio Co.  
An Audibility Meter.

or with different circuits by means of a variable resistance shunted (placed) across the phones. This resistance is decreased until the signals are just audible in the phones. Now, if another station is tuned in, or the circuit changed in some manner, the signals may either be entirely inaudible or they may be much louder, this giving an idea of the comparative strength without actual measurement. A popular type of Audibility Meter is shown in the above illustration.

For measurements with an audibility meter, the following shunt formula is used:

$$K = \frac{s + t}{s}$$

Where *s* is the impedance of the shunt resistance and *t* the impedance of the phones, then *K* is the audibility constant. In general practice a series resistance is devised to compensate for the reduction in resistance of the shunt circuit, this keeping the impedance of the plate circuit constant.

**AUDIO AMPLIFIER**—An amplifier used to increase the volume of signals of audio frequency (*q. v.*). Audio amplifiers are connected in the circuit of the

detector in place of the phones (input) as shown in Fig. 1. This is the standard two stage audio amplifier. The separate stages each consist of a vacuum tube, a transformer, socket for

Noted for the fact that he is head of the U. S. Naval Telegraphic Laboratory, Washington, D. C., and for his work in measuring high frequency currents.

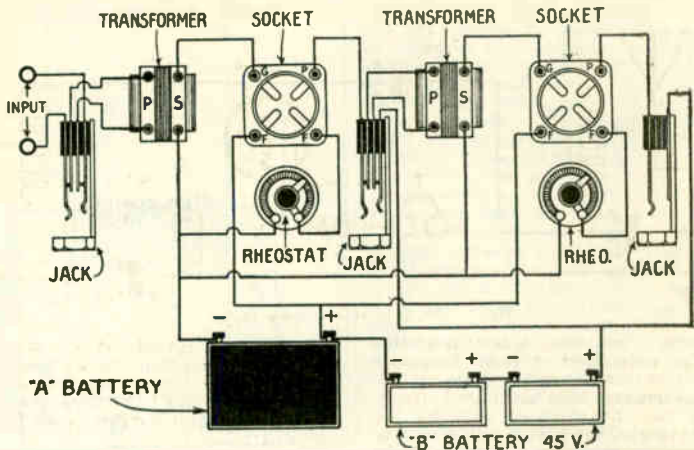

Fig. 1. A standard two stage Audio Amplifier employing phone jacks for detector, first stage, and second stage Audio Amplifiers.

the tube and a control rheostat. If desired one rheostat may be used for both amplifier tubes as the filament current (*q. v.*) can be the same if the tubes are of a similar design. This is known as "transformer coupled amplification." Another much used method is known as "resistance coupled amplification."

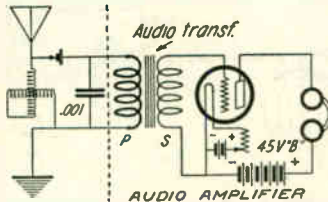

Fig. 2. A one stage Audio Amplifier connected to a crystal receiving set.

Fig. 2 shows one stage of audio frequency amplification connected to a crystal receiving set. There are numerous variations of audio amplification. (See *Push-Pull Amplification*, also *Resistance Coupled Amplifier*, and *Power Amplifier*.)

**AUDIO FREQUENCY**—A frequency corresponding to normally audible sound waves, i.e., between 40 and 10,000 per second. The limits of audibility are given variously from 16 to 20,000 cycles, but for ordinary usage may be taken as from 40 to 10,000 cycles per second. In audio frequency amplification as used in conjunction with the tuning and detector apparatus of the radio receiving set, the volume of the received sound is amplified or increased over that of the originally rectified sound waves. (See *Radio Frequency*; also *Amplifier*.)

**AUDION**—The name given by Dr. L. De Forest to a vacuum tube detector which possesses a glowing cathode and has a steady E. M. F. (*Electromotive force*) permanently applied between anode and hot cathode and two cold anodes. (See *Vacuum Tube*.)

**AUSTIN**, Louis Winslow, Ph.D.—Born in Orwell, October 30th, 1867. Graduated at Middlebury College and studied at Clarke University and the Universities of Strasburg and Berlin.

**AUTO-COHERER**—A coherer having automatic action to release the particles that cohere when circuit is established. Now obsolete. (See *Coherer*.)

**AUTODYNE RECEPTION**—See *Self-Heterodyne Reception*.

**AUTO INDUCTIVE COUPLING**—See *Coupling*.

**AUTOMATIC INTERRUPTER**—A vibrating electro-mechanical device to make and break an electric circuit by using the energy passing through it. The most common example is that of a spark coil. An interrupter may be used for several purposes. In the case of a spark coil it is used to produce sparks for transmission of signals. In another form it may appear in a mechanical battery charger, in this instance being used to interrupt the alternating current and permit passage of the current in one direction only. A buzzer uses a type of interrupter—a vibrating device producing a buzzing sound having a pitch dependent on the rapidity with which the vibrations take place.

**AUTOMATIC TRANSMITTER**—An apparatus for operating a sending key mechanically. (See *Wheatstone Transmitter*.)

**AUTOPLEX**—A type of radio receiver employing one vacuum tube, operating

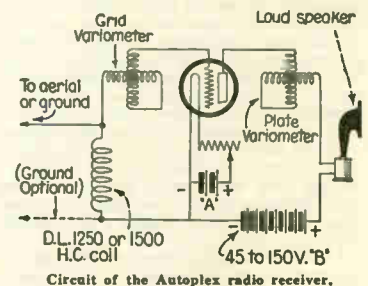

Circuit of the Autoplex radio receiver.

along the lines of the *Super-regenerative* principle and designed to operate a Loud-speaker. The circuit comprises two standard variometers, a 1500 turn duo-lateral coil, and the usual vacuum

## Auto-Receiver

tube, socket, batteries, etc. It is extremely critical in operation, but if carefully assembled will give excellent volume under good conditions. Illustration shows the circuit diagram of the Autoplex receiver.

**AUTO-RECEIVER**—A device for the automatic reception and recording of radio signals. It is essential in the reception of signals transmitted by an Automatic transmitter (see *Wheatstone Transmitter*) as the speed is too high to permit reception by ear. There are three general classes of automatic receiver: a *resonance intensifier* in conjunction with an inking arrangement; a *phonographic recorder* and a recorder using *photographic means*. In the latter method, a powerful beam of light is projected on to a mirror which is arranged to respond to the signals in approximately the same manner as a mirror *galvanometer*. In the phonographic type, the signals are reproduced on a drum. (See *Resonance Intensifier*, *Photographic Recorder*, also *Phonographic Recorder*.)

**AUTO TRANSFORMER**—A device for changing voltage in a circuit carrying alternating currents. A form of *transformer* having but one winding, any part of which may be used as the *primary* and any part as the *secondary*. In Fig. 1 the two windings P and S are continuous, although different sizes of wire may be used according to the purpose for which intended. In this case the voltage taken from the secondary D E will be less than the voltage impressed at A B, because the secondary has fewer turns of wire than the primary. Now in Fig. 2, this conditions is reversed, and as the primary has only a few turns of wire and the secondary has a com-

paratively large number, the voltage obtained from D E will be greater than that impressed at A B. The voltage ratio is approximately proportional to

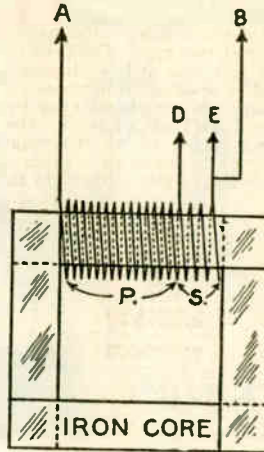

Fig. 1.

the ratio of wire turns. Thus, if the primary has 100 turns of wire and a pressure of 100 volts is placed at A B, then the voltage at D E would be within certain limits about equal to the number of turns of the secondary. In other words, if the number of turns on the secondary is one-third the number of turns on the primary, then the voltage at D E will be approximately one-third that impressed at A B. The main advantage of the autotransformer is that a saving is accomplished by having the primary and

secondary windings combined. The chief disadvantage is that where extremely high voltages are used there is always danger of the two windings be-

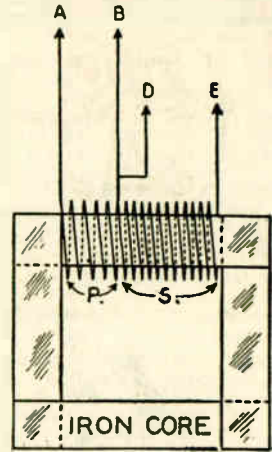

Fig. 2.

coming crossed or shorted. (See *Short*.) For this reason they are used mainly for comparatively low voltages. One of the most common forms is the step-down type, known as a "bell-ringing transformer." These are used to cut down the voltage of an electric light line to suitable value for use with small toys or bells. If the transformer is used to increase the voltage, it is known as a "step-up" transformer. (See *Transformer—Radio, Audio*.)

**AUTO TRANSFORMER COUPLING**—See *Coupling*.

## B

**B**—Abbreviation for Baumé, the scale used in a *hydrometer* (q.v.)

**B. A. AMPERE**—The standard ampere fixed by the British Association for the Advancement of Science.

**BACK COUPLING**—See *Reactance Coils*.

**BACK ELECTRO-MOTIVE FORCE**—An *Electromotive force* (E.M.F.) which opposes the original electromotive force. The more common term is "Counter E. M. F." In many arrangements of electrical circuits there will be an electromotive force set up in such manner as to oppose the impressed voltage or force. This will be true in the case of a *choke coil* in which any variation in the pressure or electromotive force applied to the coil will result, under proper conditions, in the production of a back or counter-electromotive force that will oppose the change in the original force. This phenomena is frequently found in electrical circuits; at times introduced for a purpose and at others self-introduced, and therefore demanding consideration in design of apparatus. The rotation of the *armature* of a motor creates a counter E. M. F. opposed to the impressed E. M. F. and upon which the driving power of the motor depends. When an external E. M. F. is impressed on a circuit in which there exists a local E. M. F., the flow of the current through that por-

tion of the circuit containing the local E. M. F. will result in an increase or decrease of energy depending on whether the local E. M. F. is opposed to, or in the same direction as, the external E. M. F. (See *Counter Electromotive force*.)

**BACK OSCILLATION**—When the *condenser* of a transmitting circuit of the spark type discharges across the *spark gap* some of the *high frequency* current may flow back through the secondary of the transformer instead of taking its normal path across the gap. This back flow is usually referred to as *Back oscillation* or *kick back*, and is apt to break down (see *Breaking Down of Insulation*) the insulation of the transformer if not prevented or controlled. Back oscillation is retarded ordinarily by means of coils of wire having a certain arbitrary *inductance* value. When the high frequency discharge from the condenser has any tendency to break through, the *reactance* of these coils becomes so great that they act in effect as *insulators*. As the capacity and inductance of these coils might create an *oscillatory circuit* of the same *natural period* as the primary oscillator, they are shunted with non-inductive carbon resistances. These coils are termed "choke" coils.

**BAKELITE**—An insulating material having widespread use in radio. It

possesses great strength and has a high *dielectric* (insulating) value together with the ability to withstand high temperatures. This material is furnished in many forms and under a variety of trade names, being considered one of the best of the insulating compounds.

Chemically known as *Oxybenzyl-methylenglycol anhydride*. It is produced by the union under heat and pressure of phenol and formaldehyde together with a small percentage of some alkaline agent. Is heat resisting up to about 500 degrees Fahrenheit—disintegration setting in somewhere above that point.

**BALANCED CIRCUIT**—An electric circuit arranged in such manner with relation to adjacent or neighboring circuits as to do away with the effect of *mutual induction* (q.v.).

**BALANCED DETECTORS**—A term applied to an arrangement of opposed *rectifying detectors* for reducing the effects of strong *strays* in receiving apparatus. The detectors must be balanced for violent *electro-motive forces*, but not balanced for the moderate E. M. F.'s due to the signals. Actually, a method of eliminating stray impulses in reception.

**BALANCED METALLIC CIRCUIT**—A circuit through conductors (wire or any metal) in which the total resist-

ance is the same on each side of the circuit. (See *Circuit*.)

#### BALANCED ROTARY CONDENSER—

A variable condenser having some arrangement for keeping the plates accurately balanced in rotation at all

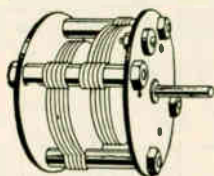

Fig. 1. A "Balanced-Plate" type Rotary Condenser.

points. Fig. 1 shows a form known as the "balanced plate" type. In this case the plates are so arranged that half the movable plates are on one side and half on the other side of the shaft.

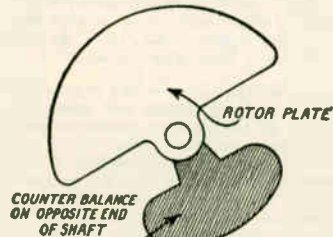
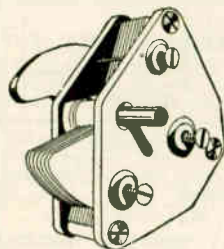

Fig. 2. A Counter-Balanced Rotary Condenser and illustration showing how the counter balance is attached to shaft.

This maintains the balance of the part. Fig. 2 shows another method known as "counter-balanced." The weight of the balance is the same as that of the movable plates and its position on the other side of the shaft serves to maintain balance. The idea is to prevent the plates slipping due to lack of balance and thus keep the setting at the desired point after adjustment.

**BALANCING—**Any method of eliminating interference by reducing the amplification of the undesired signals while permitting full amplification of the desired signals. (See *Interference Eliminator*.)

**BALANCING AERIAL—**An aerial system designed to permit reception of signals from distant points without interference from a powerful nearby transmitter. The system involves the use of two aerials, one for balancing, the other for receiving. The receiving aerial is tuned to the wavelength of the desired signals, while the balancing aerial is tuned to the wavelength of the nearby station (the interfering signals).

In operation the receiving circuit is coupled to each aerial *electro-magnetically*, and is acted on by both series of oscillations (distant and nearby waves). By careful adjustment of coupling and phase relation of the induced currents, the interfering wave may be balanced out in effect and the desired oscillations received.

**BALDWIN RECEIVER—**Perhaps the most sensitive type of telephone receiver thus far developed. It employs what is known as a "balanced armature," the signals being produced by the vibrations of a *diaphragm* which is not acted on directly by the magnets. The illustration shows the general plan of a receiver of this type. The *armature* (A) is of soft iron and is pivoted between two U-shaped soft iron pieces (M1, M2) mounted on the ring-shaped horseshoe magnet (M) as indicated. The armature is acted on by the magnets in response to incoming signals and the movement of this element in turn acts

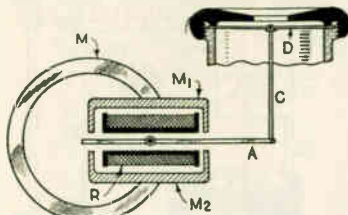

Principle plan of the Baldwin Receiver unit.

on the mica diaphragm (D) by means of a fine brass wire (C). The usual windings (R) are placed between the two pole pieces, the armature being mounted in a central slot. These receivers are much used both for headphones and for loud-speaker units. In the latter case the mica diaphragm is generally made heavier to handle the more powerful vibrations due to the amplification of the signals.

When no fluctuating impulses (signals) flow through the windings (R), there is no *magnetic stress* on the armature (A), because this member is suspended centrally between the pieces (M1) and (M2), the magnetic attraction of which are equal. Now when a fluctuating impulse flows through the windings (R) it produces a magnetic flux which combines with the flux of the permanent magnet (M) and the total flux is distributed asymmetrically or unevenly on both sides of the armature. The result is a rocking vibratory movement to this member which is in turn communicated by the juncture wire (C) to the diaphragm (D), producing the audible signals. (For a comparison of this action with the conventional telephone receiver action, see *Telephone Receiver*.)

**BALKITE BATTERY CHARGER—**An electrolytic battery charger which makes use of a sulphuric acid solution and tantalum as the valve metal. Used for charging *storage batteries* from *alternating current*. See illustration.



Photo by courtesy of Fansteel Products Co.

A Balkite Battery Charger.

*Note:* The name Balkite is derived from the name of the man who perfected the process of extraction of tantalum from its ores.

**BALLAST TUBE—**An automatic means of regulating the *filament current* of vacuum tubes. The device is enclosed in a glass tube and is arranged to permit passage of a certain fixed amount of current. The ballast element is a wire whose *resistance* changes with the current through it, due to the change of resistance with the temperature of the wire. When the *electromotive force* increases beyond normal, the increased current raises the temperature and hence the resistance, so that the current is held to the normal value.

**B. and S.—**Abbreviation for Brown and Sharpe Gauge (*q.v.*).

**BAND OF FREQUENCIES—**A continuous range of frequencies extending between two frequencies. (See *Band of Wavelengths*; also *Band Pass Filter*.)

**BAND PASS FILTER—**A filter arrangement designed to permit passage of all frequencies extending between two definite frequencies but excluding all other frequencies. (See *Band of Frequencies*.)

**BAND OF WAVE-LENGTHS—**A continuous range of *wave-lengths* extending between two definite wave-lengths. For example, the usual broadcast band of wave-lengths is approximately 250 meters to 550 meters.

**BANKED BATTERY—**A battery that has its cells connected in parallel.

**BANK WINDING—**A form of winding for coils in which the turns are staggered so that two or more layers may be used without having large distributed capacity losses. The illustration shows method of bank winding for two layers. Note that in this form the *electrostatic capacity* between any two turns is only that between adjacent



Method of bank winding wire on a coil form.

turns, representing only a small part of the total winding, whereas on the usual form of winding the adjacent turns would represent a good portion of the total *inductance* and hence the effect of distributed capacity would then be much greater. (See *Distributed Capacity*.)

**BARRETER—**A receiving instrument consisting essentially of a small mass of conducting material that is heated by the passage of an *oscillatory current*, and arranged so that the consequent alteration of electrical *conductivity* affects an indicating instrument, such as a telephone receiver or *galvanometer*.

**BASKET COIL—**Variometers—couplers, etc. (See *Basket Wound*.)

**BASKET WOUND—**A method of winding coils, such as variometers or variocouplers. The winding is a lattice-work of wires in skeleton form, the object being to save weight and eliminate large losses such as occur in the

## Battery

types using a great deal of solid insulating material. The illustration

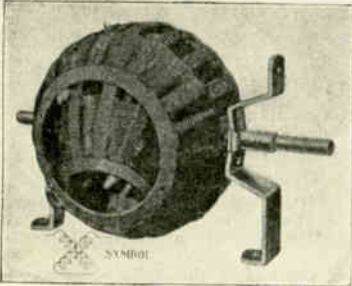

Photo by courtesy of Amer. Radio & Research Corp.  
A Basket Wound Variometer.

shows a popular form of basket variometer.

**BATTERY**—In the electrical field, a group of *primary or storage cells, dynamos, or condensers* grouped together to form a single unit. The term is often used incorrectly to refer to a single cell—as “dry battery,” the correct name for which is “dry cell.” Thus a group of condensers joined together as one unit is termed a battery, also a number of dynamos arranged as a single unit for the production of electrical energy. (See *Dry Cell, also Battery of Alternators, Storage Battery, “A,” “B” Battery, etc.*)

**“B” BATTERY**—An appliance for obtaining electricity of sufficient voltage to supply the plate of a *vacuum tube*. There are two types of “B” batteries, viz., the *dry cell* type and the

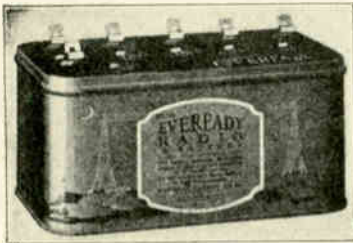

Photo by courtesy of National Carbon Co., Inc.  
Fig. 1-A. A popular type of “B” Battery of 22½ volts.

storage types. In order to obtain the high voltage required for vacuum tube plates, many small cells are connected in series. The usual method is to connect them together and seal in a square

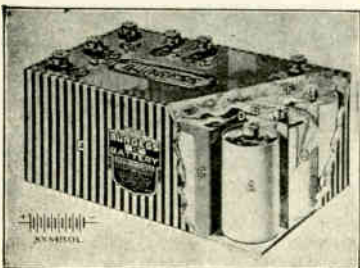

Photo by courtesy of Burgess Battery Co.  
Fig. 1-B. A “B” Battery showing the contents of small cells.

package. Often taps are brought out so that various voltages may be obtained for *critical vacuum tubes*. The most popular voltages which dry cell

“B” batteries give are 22½ and 45 volts. The storage “B” battery is similar to the ordinary storage battery with the exception that the cells are much smaller, but contain more cells in series. These can be charged in the same manner as the “A” or *storage battery*. In Fig. 1, we have a popular type of “B” battery. This is tapped in order that different voltages may be obtained.

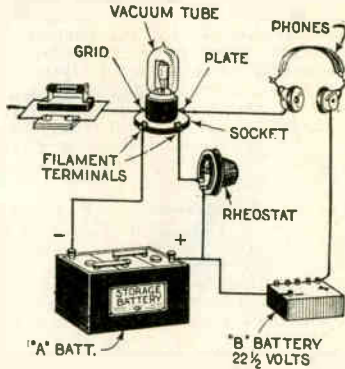

Fig. 2. Manner of connecting a “B” Battery in the circuit of a vacuum tube detector.

The manner of connecting up the “B” batteries in radio receiving is shown in Fig. 2. Here one battery of

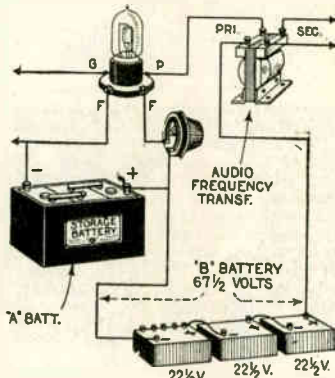

Fig. 3. “B” Battery of 67½ volts connected in an amplifier circuit.

22½ volts is used. In Fig. 3, three batteries are connected in series so that 67½ volts are obtained.

A common “B” battery may be used for the detector tube and the amplifier as shown in Fig. 4.

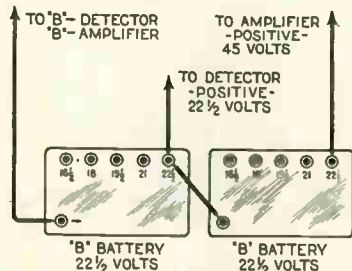

Fig. 4. How a common “B” Battery may be used both for detector and amplifier.

If separate batteries for each tube are desired, the circuit should be connected as in Fig. 5. This lengthens the

life of the “B” battery as the drain on the battery is much less, i.e., only

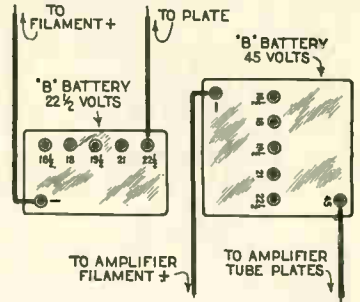

Fig. 5. Method of employing separate “B” Batteries for the detector and amplifier.

one vacuum tube is operated on each battery.

**BATTERY OF ALTERNATORS** — In ordinary electrical work such as house lighting, several *alternators* for the production of alternating current may be used together as one source of power. Also in high-power radio transmission, several *high-frequency alternators* may be used together to produce added power. (See *High-Frequency Alternator.*)

**BATTERY TESTING INSTRUMENTS** — The various devices used for determining the condition of batteries used as radio apparatus. (See *Ammeter, Voltmeter, also Hydrometer.*)

**BEAT FREQUENCY**—The *frequency* or number of vibrations per second of a series of *oscillations* representing the difference between two other series having different frequencies. It is numerically equal to the difference between the original two series of oscillations. Thus, if we have a series of oscillations having a frequency of 100,000 cycles per second, and combine it with another series having a frequency of 90,000 or 110,000 cycles, the *beat frequency* will be 10,000 cycles or the difference between the other two frequencies.

X. The frequency of recurrence per second of either maxima of addition or minima of opposition of two superposed periodic phenomena having the same nature but of different frequencies. The time measure of vibration of a beat or heterodyne. (See *Heterodyne, also Beats.*)

**BEATS**—When two sets of *oscillations* of different frequencies occur in the same system, the difference in the frequency or rapidity of vibration causes a new set of oscillations having a frequency equal to the difference between the original two sets. This may be accidental as in the case of certain types of receivers such as the *regenerative* type, in which case the beat oscillations are undesired and cause interference or disturbances in the set. Then again a beat frequency may be purposely introduced as in the case of the *Super-Heterodyne receiver*. Here we have the natural incoming oscillations from the antenna combined with a series of oscillations produced locally in the system. The result is a new set of oscillations where the incoming series and the locally produced series are not of the same frequency. (For more complete explanation see *Super-Heterodyne Receiver.*)

X. Where two *periodic phenomena* are *super-posed* or run together and

the frequencies differ, the gradual change in *phase difference* produces a condition wherein the *amplitudes* are in opposition at one instant and in concurrence at a later instant with the various intermediate stages during the interval. (See *Heterodyne*, also *Beat Frequency*.)

**BEG OHM**—A resistance of one billion ohms. (See *Megohm*.)

**BELIN, EDOUARD**—French scientist, the inventor of what is considered the first practical system of radio transmission of photographs. The device



Brown photo.

Edouard Belin.

can be used for sending photos by cable or telephone lines as well as radio. (See *Transmission of Photographs by Radio*.)

**BELL, Alexander Graham (1847-1922)**—Scottish scientist. Born in Edinburgh, March 3rd, 1847, he was educated at the High School and University and graduated as a doctor of medicine. In



Alexander Graham Bell.

1870 he went to Canada, and in 1872 became professor of vocal physiology in the University of Boston. In 1876 he exhibited his apparatus for the transmission of sound, afterwards developed into the telephone.

Bell was experimenting with an electric invention by means of which he hoped to make speech visible to the deaf. A delicate metal reed was caused to vibrate by spoken speech and to transmit an electric current to the opposite end of a wire, where the vibrations of the first reed were reproduced in a second reed by a magnet. He found that it was possible to transmit not merely vibrations of the original reed, but to reproduce the sound itself in the vibrations of the second reed. In 1878 he invented the photophone, to enable sound to be transmitted by variations on a beam of light, and later a phonograph. Bell was the author of many scientific papers, was awarded the Albert Medal of the Royal Society of Arts in 1902 and the Hughes Medal of the Royal Society in 1918. He died Aug. 2nd, 1922.

**BELLINI, Dr. Ettore**—Born in Foligno, Italy, April 13th, 1876. Educated at the University of Naples. Noted as Electrical Engineer to the Royal Italian Navy, and chief of the Naval Electrical Laboratory at Venice. Joint inventor with Captain Tosi of the "Radiogoniometer" (*q. v.*), a device for finding the direction of transmitted radio signals.

**BELLINI-TOSI AERIAL**—See *Goniometer*.

**BELLINI-TOSI DIRECTION FINDER**—See *Goniometer*.

**BEZEL**—In mechanics, generally a groove and flange made to receive a beveled edge. In its adaptation to radio some liberty was taken with its real meaning. Its significance in this



BEZEL

A Bezel on the panel of a radio receiving set.

sense is a small metal ring having a wire mesh or glass center. It is fitted into a circular hole in the panel of a radio receiver and used as a peep hole to enable the operator to know at all times the conditions of the tubes, whether or not they are properly lighted.

**BILLI CONDENSER**—A variable condenser of low capacity, consisting of two brass tubes, one of which is arranged to slide in and out of the other for the purpose of varying the capacity. Such condensers were much used before the days of broadcasting, in conjunction with any circuit using a crystal and battery for detector. This type of condenser has long been obsolete in the United States.

**BINDING POST**—A screw and nut arrangement used on electrical units and radio apparatus to make convenient connections from an external source to the desired point within the apparatus. Binding posts are provided, for instance, to make handy connections from batteries to the set and from the aerial and ground leads. The illustration shows a popular type of binding post.

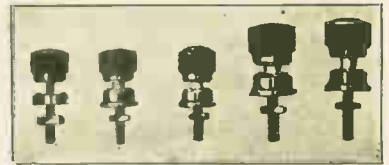

Photo by courtesy of The H. H. Eby Mfg. Co.

A group of Binding Posts as used on electrical and radio apparatus.

**BI-POLAR**—Having two poles. Usually a dynamo or motor whose armature rotates between a field magnet having only two poles. The most modern types are of the Multi-polar variety. (See *Bi-polar Magnetic Field*.)

**BI-POLAR ARMATURE WINDING**—An armature wound in a manner to permit its use with a dynamo having a bi-polar magnetic field.

**BI-POLAR MAGNETIC FIELD**—The magnetic field (*q. v.*) created between

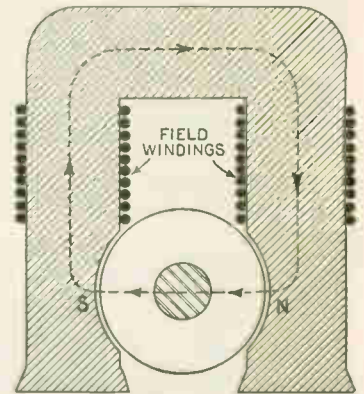

A Bi-Polar Magnet of a dynamo.

two magnetic poles. The illustration shows a common form of bi-polar magnet for a dynamo. Bi-polar magnetic fields are now used as a rule only for direct current machines of low power, such as those under 5 Kilowatts. (See *Dynamo*, also *Generator*.)

**BI-TELEPHONE RECEIVER**—A headset with two receivers or phones as generally used in radio. In the early days of radio transmission it was the custom to use only one phone.

**BLONDEL, Andree**—French electrical expert. Born at Chaumont, France, in 1863, he graduated at Paris University, and studied electric waves, on which subject he early contributed a number of papers to various scientific journals. In 1893 he invented the *oscillograph*, an instrument somewhat similar to a mirror *galvanometer*, for showing curves of *oscillating* or *alternating currents*. This invention opened up a fresh field in the study of alternating currents. In the same year Blondel explained for the first time mathematically the effect of inertia in the shunting of *alternators*. He is responsible for a system of acoustically syntonic wireless telegraphy, and for directed waves produced by a double aerial. In 1902 he patented a method for producing electric oscillations for wireless telephony, and has written many papers on microphonic control for transmitters, wireless telephony, the singing arc, etc.

**BLONDLOT, Professor Prosper Rene**—French wireless expert. Born at Nancy, France, in 1849, studied at

## Blower Motor

Paris, and became professor at the faculty of sciences, Nancy, and afterwards Honorary Professor and Correspondent of the Institute of France. Professor Blondlot is famous for his studies of electro-magnetic waves, particularly with regard to their speed, and the laws of propagation of wireless waves in various media.

**BLOWER MOTOR**—A motordriven fan used to deliver a high pressure blast at the spark gap to prevent arcing. (See *Spark Gap*, also *Spark Discharger*.)

**BLOWOUT**—See *Magnetic Blowout*.

**BLUE GLOW**—A condition within a vacuum tube when the vacuum has become poor. After continued use a tube will often hold a small percentage of gas, which causes a blue glow when current is passed through it. A tube in this condition is a poor detector or amplifier and should be replaced. The condition should not be confused with the glow often caused by an excessive voltage. In this latter case decreasing the voltage to the normal value will generally permit the tube to be operated efficiently. The blue glow in this case is due to ionization of the residual gas by the excessively high potential impressed across the elements of the tube.

**BOARD OF TRADE UNIT**—B.O.T. 1,000 Watt Hours. One and a third Horse Power.

**BODY CAPACITY**—The effect of the human body when tuning a radio receiving set. The hand when placed on or near the controls very often throws the receiver out of balance with the incoming signals. In the case of very sharp tuning this effect is more in evidence and is likely to cause howls due to self-oscillation. The howling is due to the production of an audible beat frequency in the system, caused by the combination of the local oscillations with the incoming signal oscillations. The remedy may be to shield the panel with metal foil or in some cases to merely alter the direction of the leads from the tuning condenser. The experienced operator seldom pays much attention to the phenomena, as a little practice enables the listener-in to compensate for the effect. To make this more clear, if, when tuning the set, the withdrawal of the hand from the dial detunes the set or throws it out of balance, it is due to the fact that the hand has acted as a certain amount of capacity in the circuit, and naturally its withdrawal is equivalent to a change in the condenser setting. A simple system is to turn the control beyond the point of maximum volume, then when the hand is withdrawn the capacity will drop to its proper value. This can be mastered very readily. If the tuning condenser is connected across the secondary, i.e., one side to the grid, and the other to the grid return, the stator plates of the condenser should be connected to the grid of the tube. If metal foil or thin copper sheeting is used for shielding it should be connected to the ground post of the set.

The tendency of the human body to insert an arbitrary capacity in the circuit. The phenomena is especially noted where maximum volume is obtained only by very critical control close to the oscillating point, in which case the circuit may be thrown out of resonance.

**BOLITHO CIRCUIT**—A super-regenerative circuit patented in England in 1919 by Captain J. B. Bolitho. The circuit was originally intended to operate a relay device. The circuit has been adapted to use as an amplifier for radio reception.

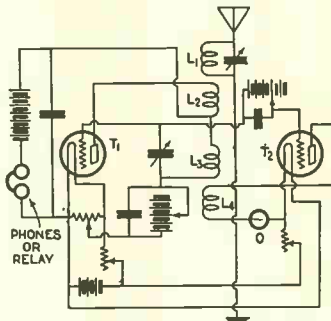

Diagram of the Bolitho Circuit.

In the illustration the phones may be replaced by a loud speaker or relay. In operation, T1 is held at a point just below that where oscillation sets in by means of T2 which is excited by an oscillator O in the plate circuit and coupled by means of coil L4 to the tuned grid circuit through L2 and L3, the coupling, as explained, being so arranged that the tube is always just below the oscillating point. A reaction coil L4 is placed in the plate circuit of T2 in such manner as to oppose the magnetic linkage between coils L2 and L3. The frequency of the generator O is lower than that of the received signals. As indicated, the grids of both tubes T1 and T2 are joined together and the tube T2 maintains the circuit in a receptive condition when tube T1 is tuned just below the oscillating point.

The oscillator O makes the plate of T2 alternately positive and negative with the following effect: When the plate of T2 is negatively charged there is no current in coil L4, this coil therefore not affecting coils L2 and L3, and permitting tube T1 to build up self oscillation. When the plate is made positive by the action of the oscillator, current flows through coil L4, and as it is coupled in opposition to coils L2 and L3 it neutralizes the coupling between L2 and L3 and prevents transfer of energy between the grid and plate circuits of the tube T1. This tends to stop the self oscillation and makes the circuit receptive to the energy (signal) produced by outside signals in the aerial coil L1. The frequency, of course, is determined by the frequency of the oscillator O. The system is especially adapted to the reception of continuous wave signals. (See *Super-regenerative circuit*, also *Feed-back and Regenerative circuits*.)

**BOLOMETER**—Type of Wheatstone Bridge having an easily heated resistance, such as a very fine wire in one arm. (See *Wheatstone Bridge*.)

**BOOSTER**—An expression signifying a small dynamo used in conjunction with main dynamo to temporarily raise, when necessary, its normal pressure. It is generally driven by a motor supplied with energy from the main generator and thus becomes in effect a continuous current transformer. Frequently used for charging accumulators of a generating plant. The term "Boost" is also used to denote increase

or a stepping-up of any electrical quantity. (See *Amplification*.)

**BORNITE**—A crystal rectifier much used in radio reception. It is a natural sulphide of iron and copper, having a metallic blue lustre. This mineral is used in combination with zincite or copper pyrites as a crystal detector. Such combinations are generally known as "crystal to crystal" detectors to distinguish them from the ordinary variety using one mineral and a wire contact.

**BORON**—A non-metallic chemical element used in radio as one of the electrodes for the T. Y. K. Arc. Chemical symbol B, atomic weight 11.0, specific gravity 2.6.

**B. O. T.**—The customary abbreviation for Board of Trade Unit. The unit represents 1,000 watt hours. (See *Board of Trade Unit*.)

**BOX AERIAL**—A term occasionally applied to loop aerials. (See *Loop aerial*, also *Frame Aerial*.)

**BRADFIELD INSULATOR**—A particular form of Lead-in Insulator, consisting of an ebonite tube provided with zinc cone and ebonite spark discs, for breaking up continuous streams of rain running down outside which might cause the aerial to become grounded. The whole is held in position, half way through roof of operating room, by means of a stuffing box. The aerial is led in by means of a conducting rod through center of tube. (See *Petticoat insulator*.)

**BRANLY COHERER**—Early form of Marconi Coherer. (See *Coherer*.)

**BRANLY, EDOUARD**—French radio expert. Born at Amiens, France, Oct. 23rd, 1844. He was educated at Paris and afterwards became Fellow of the University, doctor of physical science, and doctor of medicine. Branly early made a study of electro-magnetic waves, and in 1890 and 1891 patented methods of operating a local relay circuit from a distance by means of wireless waves. In 1900 he was awarded the Grand Prix by the International Jury of Superior Precept Instruction for his exhibition of radio-conductors.

In 1890 Branly published an account of his very extensive series of observations on the electrical conductivity



Edouard Branly.

of loosely packed metal filings, and he made the extremely important observation that an electric spark at a dis-

tance had the power of suddenly changing the electric conductivity of loose masses of powdered conductors. To Branley is due the *coherer* named after him.

**BRAUN, FERDINAND**—Professor at the University of Strasburg, and one of the leading world authorities on Radio transmission. As early as 1899 Braun was granted a patent for *closed oscillating systems with an inductively coupled antenna*. The system was claimed by Braun to possess a much greater efficiency than the directly coupled systems. The Braun transmitting set, as manufactured by Siemens and Halske, consisted of a large coil worked into an *electrolytic interrupter*, a set of *Leyden jars*, enclosed *spark gap*, *oscillation transformer* wound with insulated wire placed in oil, and for the receiving set the standard type of *coherer relay* and Morse register. In 1899 Braun established communication between Cuxhaven and Heligoland, using aerial wires 90 feet high, and the inductive coupled aerial connection for transmitting. In 1903 Braun joined with Slaby, von Arco, and Siemens to form the Telefunken system of transmission. Professor Braun was awarded the Nobel prize with Marconi in 1909, for his work in wireless. Braun has devised a method of directional wireless which depends upon the interference of *electric waves* travelling in the same direction but different in *phase*. Three simple vertical wire aeriels are set up in positions corresponding to the angular points of an equilateral triangle, and *oscillations* are created in these which differ from one another in phase. In 1897 Professor Braun published a description of his cathode ray tube, and afterwards pointed out, in 1902, how such a tube could be used to trace the forms of alternating current waves.

**BRITISH STANDARD WIRE GAUGE**—The standard wire gauge of Great Britain. The table shows the various diameters in thousandths of an inch (mils.).

WIRE GAUGES IN MILS.	
GAUGE	New British Standard
0 000 000	500
000 000	464
00 000	432
0 000	400
000	372
00	378
0	324
1	300
2	276
3	252
4	232
5	212
6	192
7	178
8	160
9	144
10	128
11	116
12	104
13	92
14	80
15	72
16	64
17	56
18	48
19	40
20	36
21	32
22	28
23	24
24	22
25	20
26	18
27	16.4
28	14.8
29	13.6
30	12.4

GAUGE	New British Standard
31	11.6
32	10.8
33	10.0
34	9.2
35	8.4
36	7.6
37	6.8
38	6.0
39	5.2
40	4.8

**BREAK or BREAKER**—See *Circuit Breaker*.

**BREAKDOWN POTENTIAL or BREAKDOWN VOLTAGE**—The voltage necessary to *break down* or *puncture* a *dielectric*. The ability of any *insulating material* to resist breakdown is an important matter. An insulator or dielectric material is usually given a certain rating or point above which it is likely to fracture. Thus, a condenser may have a breakdown rating of 500 volts. That is to say that voltages up to 500 and slightly over may be handled with safety, but any large increase above that figure may result in puncture of the material by the

**BRIDGES**—See *Capacity Bridge*, also *Wheatstone Bridge*.

**BRIDGING**—A term occasionally used for *shunt* (q.v.) connections. Thus, a grid condenser is generally shunted or bridged by a *grid leak*.

**BROADCAST**—Transmission of music, news and other matters of general interest and entertainment by means of *radio telephony*. (See *Broadcasting, General Treatise on Methods*.)

**BROADCASTING, GENERAL TREATISE ON METHODS**—The application of radio telephony to the transmission through the ether of musical programs, speech or any form of news or entertainment, in such manner that it can be readily received by anyone possessing a radio receiver sufficiently sensitive and capable of being tuned to resonance with the particular waves being sent out. While broadcasting in its present world-wide scope is a comparatively new enterprise, it has actually been used to a more or less degree since the practical development of the wireless telephone. As near as records can be determined, the first

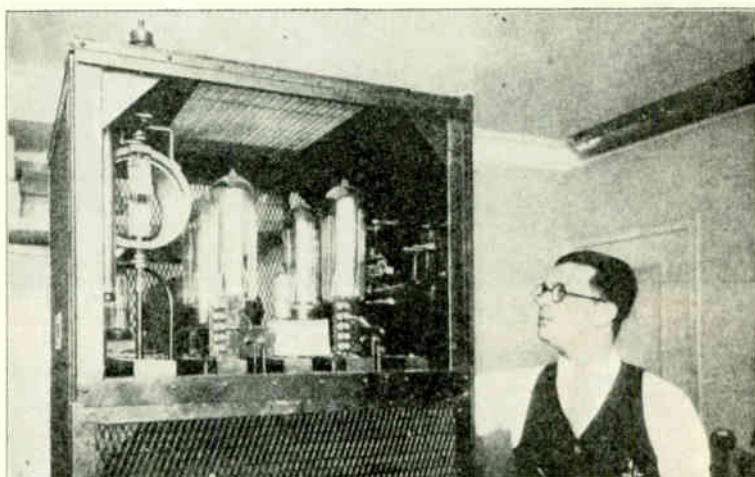

Fig. 1. A bank of 250-watt transmitting tubes in a Radio Broadcast Station. Note the small receiving tube for comparison of size.

excessive potential or voltage. The relation between dielectric strength and breakdown voltage is shown in the following formula:

$$V = cd \%$$

Where *d* is the thickness of dielectric in millimeters  
*V* the potential difference in volts  
*c*—a constant representing the potential difference required to cause a dielectric breakdown of a sample of the material 1 mm. thick. (See *Dielectric Strength*.)

**BREAKING DOWN OF DIELECTRIC**—

In a *condenser*, the gradual weakening of the *dielectric* or insulating sheets which eventually causes them to permit direct passage of the current. For example, if a force of 1000 volts is applied for a considerable period to a condenser that has been designed for a maximum of 500 volts, the insulating material between the plates would probably be punctured by the current. (See *Break-down Potential*.)

**BREAKING DOWN OF INSULATION**

—The same effect as referred to under *Breaking Down of Dielectric*. The insulation weakens and permits the ready passage of electric currents. (See *Break-down Potential*.)

actual broadcasting was done in 1912. It was, however, not until after the world war that it began to develop into an industry of prominence. Now it occupies a place of very definite importance in everyday life; carrying news and entertainment into the remote corners of the earth, far removed from telephone or telegraph communication.

The fundamental principles of broadcasting are essentially those of radio transmission, with the addition of means of combining the speech or music vibrations with the regular radio waves. First we have to consider the radio waves of high-frequency—alternating current that changes in direction many thousands of times each second. These high frequency waves are known as the carrier waves. The frequency of these waves varies according to the length of the waves (wavelength), in the case of American broadcasting stations, being between 250 and 550 meters in most cases, which means a frequency range of approximately 550,000 to 1,200,000 cycles.

Now by means of a microphone, a device similar in principle to the mouthpiece of an ordinary telephone,

but designed to handle large currents, the air pressure waves, i.e., speech or music, are converted into variations of electric current. By use of suitable amplifying apparatus, the strength of the electric waves radiated from the antenna is varied to correspond electrically to the acoustic or sound variations due to the speech or music being impressed on the microphone. The speech or music waves are low frequency waves, generally ranging between 100 and 4000 per second. Thus, while the carrier wave oscillations are of high frequency, the variations in it are low frequency, corresponding to the ordinary speech or music vibrations.



Fig. 2. Studio of a modern Radio Broadcast Station.

The process of varying the radiated wave in accordance with the sound waves is known as *modulation*. This adjustment is of the utmost importance, as defects here result in distorted or improperly modulated sound waves and the reproduction cannot be perfect. The reception of broadcast programs is essentially the same as that of ordinary radio signals, with the exception that care must be used at the receiving end to preserve the form of the original vibrations. When dot and dash signals are received, the tone is of comparatively little importance, whereas with voice or music it is essential that the tone quality be retained.

In broadcasting the high frequency oscillations are produced by means of a tube or group of tubes, practically identical with those used for reception, but designed to handle large currents and voltages. The majority of American stations use vacuum tubes of 250 watts power rating, one or more of them being used to obtain the total power required. These tubes are shown in the illustration, Fig. 1.

When a program is being broadcast, the action is somewhat as follows: The artists are disposed before the microphone with due regard to the effect of certain instruments. That is to say, one type of instrument may be placed near the microphone, while another must be placed farther away, owing to the differences in tone and volume. This is done to prevent any one tone or range of tones from predominating. These speech or music currents are converted into electrical variations by the microphone and then increased many times in power or amplitude by means of a

speech amplifier system, comprising vacuum tubes and the necessary associated circuits.

These amplified currents are applied to the grid of a control tube or bank of tubes and result in large variations in the plate current of the tubes. (See *Theory of Vacuum Tube*.) The control tubes are supplied with filament current from storage batteries or special low voltage D. C. generators, and the high voltage applied to the plates of the tubes is furnished by generators. This power will vary in most cases from about 1,000 to 5,000 volts. In some broadcasting stations, the power is obtained through high voltage direct current generators, while in others, the

cordance with the variations of the speech or music being transmitted. The action of the transmitter and the effect of the modulation must be carefully observed at all times during the transmission of programs. (See *Harmonic Suppressor*, also *Oscillograph*.) Fig. 2 shows the studio of a modern broadcasting station. It is interesting

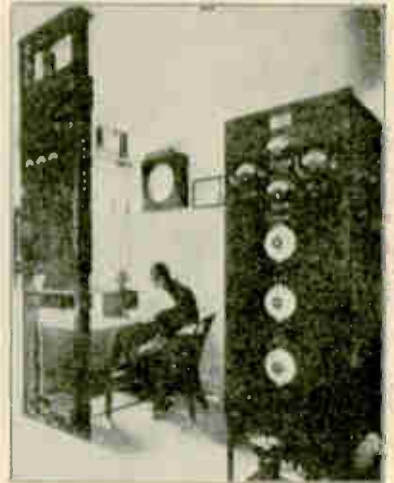

Fig. 3. Main control panels of a Radio Broadcast Station.

to note that these studios are very carefully arranged and the walls cushioned to prevent troublesome acoustic effects. There must be no reverberation—echoes—or the transmitted program would be distorted by the additional or repeated tones. Fig. 3 shows the main control panels. Fig. 4 illustrates the power generating system of a typical broadcasting station.

The radio waves generated and radiated from the broadcasting station travel away from the antenna at tremendous speed—that of light waves, or about 186,000 miles per second. These waves radiate off into space in

alternating current supply is stepped up or transformed through high voltage transformers and then rectified by means of special vacuum tubes.

The high frequency waves are applied to the antenna system tuned circuits and carefully modulated in ac-

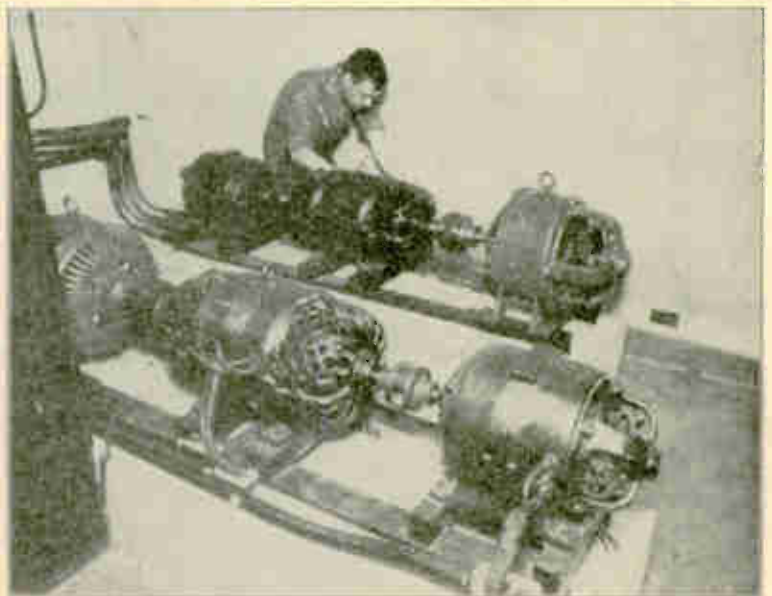

Photos by courtesy of Station W2NY (New York)

Fig. 4. A section of the generator room with power plant in a Radio Broadcast Station.



much the same manner as light waves, but a certain portion apparently follow the curvature of the earth. When these waves impinge on a receiving aerial they follow the path of least resistance, and being then in the nature of electrical impulses, they follow the aerial and lead-in wire to the receiving set, and thence to the ground. The receiver is arranged in such fashion that it corresponds electrically to the antenna circuit of the transmitting station. That is to say, the receiver is placed in resonance with the particular signals desired. The usual system of detecting, either with a simple crystal or by means of vacuum tubes, may be followed by special amplification which will make the signals audible on a loud speaker. In many cases the signals are amplified in their original form (radio frequency amplification), then rectified by the detector and further increased in volume at audio frequency. (See *Modulation, Speech Amplifier, Electromagnetic Waves, etc.*)

**BROAD TUNING**—A term used to designate the lack of *selectivity* in reception or in transmission, the use of several *waves* rather than a sharp, pure wave. If a receiving set is of such a nature that it is difficult or impossible to receive the desired signals without hearing any other, the set is said to be "broadly tuned." (See *Tuning, also Selective Tuning.*)

**BROKEN CIRCUIT**—See *Open Circuit.*

**BROWN AMPLIFYING RELAY**—An arrangement whereby the comparatively weak signals received by a *crystal detector*, usually of the *carborundum type*, may be amplified or increased in intensity, either to allow a recording machine to be used or merely to make the signals more readily audible in the ear phones. The device consists essentially of an arrangement for controlling and stepping up the vibrations in conjunction with a small *battery* or *dry cell*.

One example of such a relay is shown in the illustration. In this case the soft iron cores *cc* are magnetized by the *permanent magnets mm*, the poles of which are marked *n* and *s*. *R1* is a fine wire winding such as is ordinarily used in ear phones and *R2* is a larger winding placed over the main magnets *mm*. Directly above the

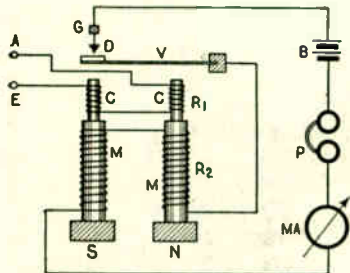

The Brown Amplifying Relay Circuit.

soft core *cc* with the windings *R1* is placed a steel vibrating tongue *V* having a contact *D* which touches lightly contact *G*. Contact *G* is of a special alloy of osmium and iridium and the contact *D* is a carbon button, which in contact with *G* forms a *microphone*. The winding *R2* is joined with the telephone *P* and the battery *B*, all in series with the microphonic contact. When current (signal current) enters

the leads *A—E* through the windings *R1* the result is a change of *flux* in the core of the magnet which vibrates the tongue *V*. This in turn varies the current of the battery *B* and causes correspondingly greater sounds in the ear phones *P*. Several of these relays may be connected together to permit a much greater *amplification* of the original signals.

**BROWN & SHARPE GAUGE**—The American wire gauge adopted as standard for wires for electrical purposes. Commonly known as *B. & S.* The various sizes run from 40 to 0000, 40 having a diameter of .00314 inch, and 0000 being .46 inches in diameter. We refer to wire having a diameter of .00314 inch as being 40 *B. & S.* gauge. (See page 26 for table.)

**BROWN, Sidney George**—Born in Chicago, U. S. A., in 1873, of English parents, he was educated at Harrogate and London University. An early study was made by him of the subject of submarine telegraphy. During these investigations he invented the magnifying relay for cables. Another important invention was the cable drum relay. In the year 1898 he invented the magnetic shunt. Since that time many of his activities have been directed to the solution of problems in telephone and wireless telegraphy.

In particular the radio experimenter will know the telephone receivers bearing his name and the important developments of the *microphone relay*. In the field of land telegraphy and telephony, his activities have resulted in the invention of such items as the carbon telephone relay system, which is largely used on land trunk lines for the transmission and reception of telephony.

He is a Fellow of the Royal Society and Vice-President of the Radio Society of Great Britain. His writings on technical subjects are extensive, and numerous valuable patents have been taken out by him, including the vacuum tube *oscillation generator* in 1916 and ionic electric relays in 1918.

**BRUSH**—A device for collecting current from the *commutator (q.v.)* of a *dynamo* or supplying current to the commutator of a motor. Brushes are made in a great variety of forms, the most

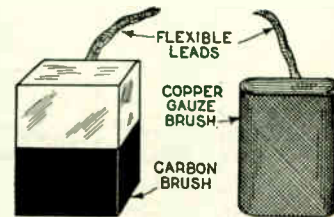

Two different types of Brushes. At the left is shown a carbon brush, and at the right a copper gauze brush.

common being carbon blocks or brass or copper gauze. The illustration shows two different types.

**BRUSH ANGLE**—The angle formed by a brush in its contact with the *commutator*. The angle is usually 45°. If the brushes do not bed properly, sparking is apt to occur.

**BRUSH DISCHARGE**—A faintly luminous discharge which takes place on the surface of *conductors* charged to *high potential*, due to *ionization*. This effect can be noted at times on the *antenna* of a powerful transmitting station. (See *Corona.*)

**BRUSH HOLDER**—Metal clamp capable of adjustment which holds the *brush* in position on the *commutator* of a *dynamo* or motor. (See *Brush.*)

**BRUSH LOSS**—The loss in *watts* or power due to the friction of the brushes against the *commutator*. This loss is at a minimum when the brushes make perfect contact at the proper angle.

**BRUSH PRESSURE**—A term used to designate the pressure with which the brushes bear on the *commutator* of a *dynamo* machine and also referring to the voltage or *electrical pressure* delivered at the brushes.

**B. S. G.**—Abbreviation for British Standard Gauge of Wire, commonly known as *B. S.* (See *British Standard Wire Gauge.*)

**B. T. U.**—Abbreviation for "British Thermal Unit," being the commonly used heat unit. The amount of heat required to raise the temperature of a pound of water one degree Fahrenheit at ordinary atmospheric pressure.

**BUCHER, Elmer E.**—Born Akron, Ohio, Nov. 11, 1885. Educated at high school and private tutors. An American pioneer, Experimental Engineer with Deforest Wireless Telegraph Company in 1903; constructed several high power stations in Middle West and Gulf Coast and later for United Wireless, which absorbed the Deforest Company. Organized training school for United Wireless and instituted first radio schools for Y. M. C. A. in New York City. Supervised commercial operations and conducted research work for United Wireless; later instructing engineer Marconi Wireless Tel. Co. Technical Editor "Wireless Age" 1913 to 1917. Appointed Commercial Engineer for newly formed Radio Corporation of America in 1920, and since 1922 has been in charge of general sales for that corporation. Author of numerous standard works on radio, including "Practical Wireless Telegraphy," "Wireless Experimenters' Manual," "Vacuum Tubes in Wireless Communication," and many others. Holds numerous U. S. patents on radio systems and devices.

**BUCKLED DIAPHRAGM**—Warping of the *diaphragm* of a phone as used in radio. Excessive voltages if applied direct to the head-phones will often bend the diaphragms. Any such defect may seriously impair the operation of the part and when it is noted that a diaphragm is bent or warped through rough usage or the application of too great voltages, it is best to replace it immediately.

**BUCKLING OF PLATES**—During discharge of a *storage battery* the plates gradually expand, owing to the fact that lead sulphate has about twice the volume of the same quantity of lead peroxide. Should this expansion or discharge take place too quickly, the plates will bend or buckle. (See *Storage Battery.*)

**BUNSEN BURNER**—A form of gas burner frequently used in radio construction for heating the soldering iron where electricity is not available. By special arrangement of the parts, the gas is combined with the proper amount of air before it reaches the burning part. This is done by driving the gas through a tube with small holes drilled to allow the air to be sucked in. This method promotes complete combustion and gives a non-luminous flame that heats the soldering iron without

**THE BROWN & SHARPE (B. & S.) COPPER WIRE GAUGE**—Below is a comprehensive copper wire table, which is the standard one in use in the United States. The resistance and cross-sectional areas of various sizes of conductors are given, so that considerable calculating can be done with the data at hand. A mil means 1-1000 (one thousandth) of an inch. Hence a wire with a diameter of 9 thousandths of an inch could also be

stated as having a diameter of 9 mils. The area of cross-section of the wire in circular mils is found by squaring the diameter in mils; thus the 9 mil conductor would have 9 times 9, or 81 circular mils area. This is the end area of the wire, of course, and is used in all electrical figuring. If the resistance per 1,000 feet of a certain size wire is, say, 50 ohms, then 500 feet of the same size wire would have a proportionately less amount

of resistance, or 1/2 of 50 ohms, that is, 25 ohms. The resistance per foot is found by dividing the resistance in ohms per 1,000 feet by 1,000. This wire table is for bare copper wire. Conductors, according to the B. & S. standard gauge, halve their sectional area in circular mils (Cir. Mils) for every 3 gauge sizes smaller wire; and double their sectional area in Cir. Mils for every 3 gauge sizes increase.

Gauge Number.	SIZE		WEIGHT AND LENGTH.			RESISTANCE.			Carrying Capacity, 2,000 Amperes p. sq. in. section. Amperes.
	Diameter in Mils.	Square of Diameter or circular Mils.	Grains per Foot.	Pounds per 1000 Feet.	Feet per Pound.	Ohms per 10000 Feet.	Feet per Ohm.	Ohms per Pound.	
0000	460.000	211600.0	4477.2	639.60	1.564	.051	19929.7	.0000785	430
000	409.640	167804.9	3550.5	507.22	1.971	.063	15804.9	.000125	262
00	364.800	133079.0	2815.8	402.25	2.486	.080	12534.2	.000198	208
0	324.950	105592.5	2236.2	319.17	3.133	.101	9945.3	.000815	165
1	289.300	83694.49	1770.9	252.98	3.952	.127	7882.8	.000501	130
2	257.630	66373.22	1404.4	200.63	4.994	.160	6251.4	.000799	103
3	229.420	52633.53	1113.6	159.09	6.285	.202	4957.3	.001268	81
4	204.310	41742.57	883.2	126.17	7.925	.254	3931.6	.002016	65
5	181.940	33102.16	700.4	100.05	9.995	.321	3117.8	.003206	52
6	162.020	26250.48	555.4	79.34	12.604	.404	2472.4	.005098	41
7	144.280	20816.72	440.4	62.92	15.893	.509	1960.6	.008106	32
8	128.490	16509.68	349.3	49.90	20.040	.643	1555.0	.01289	26
9	114.430	13094.22	277.1	39.58	25.265	.811	1233.3	.02048	20
10	101.390	10381.57	219.7	31.38	31.867	1.023	977.8	.03259	16
11	90.742	8234.11	174.2	24.89	40.176	1.289	775.5	.05181	13
12	80.808	6529.93	138.2	19.74	50.659	1.626	615.02	.08237	10.2
13	71.961	5178.39	109.6	15.65	63.898	2.048	488.25	.13087	8.1
14	64.084	4106.75	86.87	12.41	80.580	2.585	386.80	.20830	6.4
15	57.068	3256.76	68.88	9.84	101.626	3.177	306.74	.33133	5.1
16	50.820	2582.67	54.67	7.81	128.041	4.582	243.25	.52638	4.0
17	45.257	2048.19	43.33	6.19	161.551	5.183	192.91	.83744	3.2
18	40.303	1624.33	34.37	4.91	203.666	6.536	152.99	1.3312	2.5
19	35.390	1252.45	26.50	3.786	264.136	8.477	117.96	2.2392	1.96
20	31.961	1021.51	21.60	3.086	324.045	10.394	96.21	3.3438	1.60
21	28.462	810.09	17.14	2.448	408.497	13.106	76.30	5.3539	1.28
22	25.347	642.47	13.59	1.942	514.933	16.525	60.51	8.5099	1.08
23	22.571	509.45	10.77	1.539	649.773	20.842	47.98	13.334	.80
24	20.100	404.01	8.55	1.221	819.001	26.284	38.05	21.524	.63
25	17.900	320.41	6.77	.967	1044.126	33.135	30.18	34.298	.50
26	15.940	254.08	5.38	.768	1302.083	41.789	23.93	54.410	.40
27	14.195	201.49	4.26	.608	1644.737	52.687	18.98	86.657	.31
28	12.641	159.79	3.39	.484	2066.116	66.445	15.05	137.283	.25
29	11.257	126.72	2.69	.384	2604.167	83.752	11.94	218.104	.20
30	10.025	100.50	2.11	.302	3311.258	105.641	9.466	349.805	.16
31	8.928	79.71	1.67	.239	4184.100	133.191	7.508	557.286	.13
32	7.950	63.20	1.33	.190	5263.158	168.011	5.952	884.267	.098
33	7.080	50.13	1.06	.151	6622.517	211.820	4.721	1402.78	.078
34	6.304	39.74	.847	.121	8264.463	267.165	3.743	2207.98	.062
35	5.614	31.52	.658	.094	10638.30	336.81	2.969	3583.12	.049
36	5.000	25.00	.525	.075	13333.33	424.65	2.355	5661.71	.039
37	4.453	19.83	.420	.060	16666.66	535.33	1.868	8922.20	.031
38	3.965	15.72	.315	.045	22222.22	675.22	1.481	15000.5	.025
39	3.531	12.47	.266	.038	26315.79	851.789	1.174	22415.5	.020
40	3.144	9.88	.210	.030	33333.33	1074.11	.931	35803.8	.015

depositing soot as in the case of an ordinary luminous flame.

**BURSTYN, Dr. W.**—Born in Austria, 1877. Educated at Vienna University. Noted as: Developer of the *quenched spark system* in radio transmission, upon which he worked in conjunction with Baron Lepel in 1907 to 1912.

**BUS BAR**—A single bar, usually copper, which serves as a common connector for a number of pieces of apparatus. Also referred to as Omnibus Bar.

**BUS BAR WIRE**—Square copper wire, usually tinned, much used in making radio connections. This wire is generally furnished in lengths of two or two and a half feet and is particularly efficient for radio work, as it offers a low resistance connection, makes a neat appearance, and is suitable for soldering at joints.

**BUSHING**—Pieces of insulating material, usually fibre or rubber composition, used to *insulate* parts of radio apparatus or in mounting machine screws or shafts of *condensers* and other devices. The term is also applied to brass or other metal bearings through which the shaft of a piece of apparatus is run.

**BUTT JOINT**—A method joining two lengths of wire together by placing them end to end or at right angles and

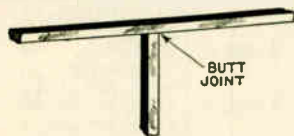

Showing how a Butt Joint is made.

soldering the joint. The illustration shows a common butt joint.

**BUZZER**—An electric call signal device that makes a buzzing noise caused by the rapid vibrations of a contact

breaker in a circuit using a small battery or cell. (See *Testing Circuit*.)

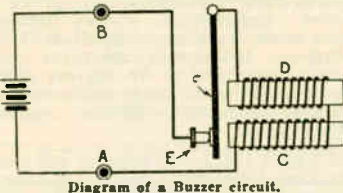
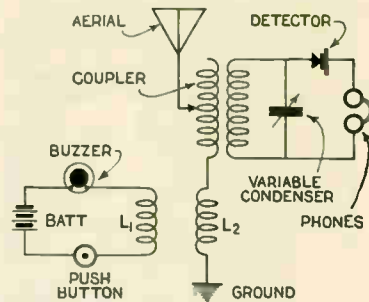

Diagram of a Buzzer circuit.

As the current flows from the posts A B the *electro-magnets* C and D are energized and draw down the vibrator spring F. This breaks the contact between E and F and as the current no longer flows the magnets release the spring F, which returns to its normal position and establishes the circuit once more. This making and breaking of the circuit takes place so rapidly that the vibrator makes a buzzing or humming sound, the speed with which it vibrates determining the pitch of the note. (See *Frequency*, also *vibration*.)

**BUZZER EXCITER**—A method of using a *buzzer* to produce local signals in a crystal receiving circuit to permit sensitive adjustment of the *detector*. The illustration shows a common method of producing signals to test the receiving set in this manner. In this case a small coil having a few turns of wire is placed in the buzzer circuit as indicated and a similar one is placed in the ground lead of the receiving set. When the button is depressed the buzzer is set in vibration and a transfer of energy takes place between L1 and L2. This causes an *oscillating* impulse (q.v.) to flow through the receiver circuit. The detector can then be adjusted to the most sensitive point at which it can be left until outside signals are heard. Another but less efficient method of exciting the circuit is to connect a short length of wire from the contact point of the buzzer to the

ground connection of the receiving set. The former system is much more practical and furnishes better test signals.



Buzzer Exciter.

Coil L1 being placed in *inductive* relation to coil L2, which is in the antenna circuit, undergoes a change of flux when the buzzer is excited. This sets up a *difference of potential* across coil L2 which charges the antenna ground system and produces oscillation at a definite frequency according to the adjustment. Now if the secondary circuit is tuned to resonance with the primary circuit, the signals will be audible in the phones when the detector is properly adjusted. Also called *Buzzer Wave Generator*.

**BUZZER MODULATION**—See *Modulation*.

**BUZZER PRACTICE SET**—A combination of a *buzzer* and signalling key arranged on a baseboard used for the purpose of practicing signalling.

**B. W. G.**—The abbreviation for Birmingham Wire Gauge—a system of gauging wire used in England. (See *B & S Gauge*, also *British Standard Wire Gauge*.)

**BY-PASS CONDENSER** — See *Condenser*, also *Filter*.

## C

**C**—The chemical symbol for carbon. When printed in *italics*, it is also the symbol for *coulomb* in electrical practice. It is the international symbol for *capacity*.

**CABLE**—A number of wires stranded together, used to carry electrical currents, heavily insulated and often covered by a sheath or outer coating of lead, rubber, gutta percha, or braided silk or cotton. The term is used very often in a broad sense to signify any heavy wire or strand of wires that may be insulated more thoroughly than is ordinarily the case. (See *Conductor*, *Stranded Wire*, etc.)

**CADMIUM**—A chemical metallic element somewhat resembling zinc. In color, white with a bluish tinge. It is useful in fusible alloys because of its property for uniting readily with other metals, having a low melting point. Its electrical conductivity is about 25% of that of silver. It is very useful in the construction of a crystal detector, the molten metal holding the crystal firmly and as it melts at a low temperature the heat will not affect the sensitivity of the crystal. Cadmium is also used in making cells, notably the *Weston Cell*. (See *Weston Cell*.)

**CAGE ANTENNA**—An aerial having a number of wires arranged in cylindrical

form, suspended either vertically or as a horizontal top. So named because of its resemblance to a cage. (See *Aerial*.)

**CALCULATION OF CAPACITY**—The mathematical or comparative determination of *capacity*. There are various formulas in use for calculating capacity under various conditions, such as for capacity of various types of condensers, or the capacity of a circuit. Rough approximations of capacity of condensers might be obtained by direct comparison with a known value. Other formulas are used for the calculation of antenna capacity. For determining the capacity of flat condensers, such as fixed condensers used for transmitting or receiving circuits, the following formula is generally used:

$$C = 0.0885 \frac{S}{r} K$$

In this case, C is the capacity in micro-micro farads; to obtain result in the usual units of micro-farads, divide the result by one million. S is the surface area of one plate in square centimeters; r is the thickness of the dielectric in centimeters and K a constant depending on the material between the plates of the condenser. (See *Dielectric Constants*.)

**CAL-ELECTRICITY** — Electricity produced in the secondary of a transformer due to changes in temperature of the core. This current is in addition to the current normally induced in the secondary. (See *Transformer*, *Core*, also *Core Losses*.)

**CALIBRATION** — A process whereby instruments such as *galvanometers*

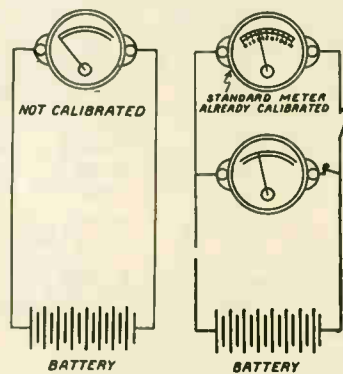

Fig. 1. Fig. 2. Calibrating a Meter

ammeters, wavemeters, etc., are made to indicate certain values. Before such

instruments can be made use of, it is necessary to mark the dials in such a manner that the indicator showing on the dial or scale will have a definite meaning in terms of electrical values. Thus, a voltmeter before calibration is shown in Fig. 1. When it is placed across a battery, the pointer will move to some position on the white space, but without indicating any definite value. Now by testing with another meter which is already marked or calibrated in volts, we find, for example, that when the pointer is at the middle point in its swing, it indicates 10 volts. Similarly various other positions are found to indicate more or less voltage by comparison with the standard. This is shown in Fig. 2. It will be understood that one of the small switches must be open at all times. The reading of the calibrated meter is taken with the other meter out of the circuit (switch open), then the reading is marked on the other meter at the point indicated with the calibrated meter out of the circuit. Such a method would, of course, be inefficient and it is shown only to give a rough idea of the purpose and meaning of calibration. Another example of calibration is in the case of a dial on a receiver. Fig. 3 shows the usual form of dial used in tuning a receiving set. The dial is marked off to scale, from 1 to 100, the numbers having no particular significance. Now if we find that when the tuning dial is set at 20 it is adjusted for a wavelength of 260 meters, we can put that figure in place of the 20. The same procedure can be followed throughout the entire range of the dial, and when thus marked in terms of a definite quantity—wavelength in meters in this case—the dial is said to be calibrated.

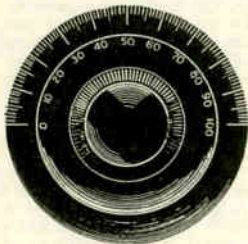

Fig. 3.

A dial as used on radio receiving sets may be calibrated according to different wavelengths.

The actual method to be followed out in calibrating will depend on the equipment available and the accuracy desired. If a standard of comparison is available, it saves a great deal of work. Thus, a voltmeter can easily be calibrated by means of a standard meter, already calibrated, and a source of steady voltage controlled by a rheostat. An ammeter can be calibrated in the same manner by using a standard ammeter, and a wavemeter can be calibrated from another wavemeter of known values.

Calibration may be done in such a manner that the readings require mathematical solution to determine their value in terms of actual volts, amperes, meters and so on, or it may be absolute, in which case the readings are directly in terms of the quantity and require no solution. (See *Voltmeter Calibration, Wavemeter Calibration, also Rough Calibration.*)

**CALIDO**—An alloy containing nickel and chromium with a small percentage of iron. The melting point is very

high, about 1550 degrees centigrade. Calido wire is much used as a *resistance*, particularly for heating devices. The chief characteristics are as follows: maximum working temperature 1100 degrees centigrade; microhms per cubic centimeter at 20 degrees centigrade, 100; temperature coefficient per degree centigrade, 0.00034; specific gravity, 8.2.

**CALLAND CELL**—A primary cell used in French telegraph work. It is a form of gravity cell having a negative electrode of copper and a positive electrode of amalgamated zinc, the electrolyte being zinc sulphate. Crystals of copper sulphate are used as a depolarizer. (See *Gravity Battery.*)

**CALORIE**—The unit of heat in the C. G. S. (Centimeter-Gram-Second) (q.v.) system. It is equivalent to the amount of heat necessary to raise the temperature of one gram of water from 0° to 1° centigrade. (See *Thermal, also C. G. S.*)

**CALORIMETER**—In electrical practice, an instrument used to measure the heat generated in a conductor carrying an electric current.

**CAMBRIC, VARNISHED**—Varnished muslin used as an insulating material. Also known as Empire Cloth. (See *Spaghetti.*)

**CANAL RAYS**—When an electric discharge takes place between the *anode* and a perforated *cathode* in a vacuum tube, fine pencils of light are seen to pass through the perforations in the cathode. These rays are called *canal rays*, and consist of positively charged particles. They produce phosphorescence on the wall of the tube.

Canal rays travel at a lesser velocity and in the opposite direction to the cathode rays. This fact and also the fact that the rays are deflected by powerful electric or magnetic fields in the opposite direction to cathode rays, is taken as proof that they consist of positively charged particles. (See *Cathode Rays.*)

**CAPACITANCE**—A term very often used as synonymous with *capacity*. Due to the fact that capacity may refer to the current carrying ability of a conductor and also to electrostatic capacity, it has been suggested that capacitance be used to refer only to *electrostatic capacity* of a body or device. Capacity would then refer to *current carrying ability*. (See *Capacity, also Electrostatic.*)

**CAPACITATIVE REACTANCE**—That part of the *reactance* of a circuit carrying alternating current which is due to the *capacity* in the circuit. (See *Reactance also Impedance.*)

**CAPACITATIVE COUPLING**—See *Coupling.*

**CAPACITY**—Generally speaking, the quantity of electricity in any form which a body is able to store or contain. The term is usually qualified to denote the particular case, such as *electrostatic capacity*, which is a measure of the ability of a condenser to store up energy in the form of electrostatic charges; also *current-carrying capacity* of a conductor, which is considered as the ability of a wire to carry a certain amount of electric current without overheating. The tendency in electrical literature is to use the term *capacitance* as applying to the electrostatic capacity of a condenser. Thus, a cer-

tain condenser may have a capacitance of 2 micro-farads. The unit of electrostatic capacity is the *farad*. This is understood as the capacity of a condenser that will store one *coulomb* of electricity under an electromotive force of one *volt*. When V is expressed in volts, C in farads, and Q in coulombs, C=Q/V.

**CAPACITY CIRCUIT**—An electrical circuit in which the *capacity* is very large compared with the *inductance*. The inductance may be considered negligible.

**CAPACITY CONVERSION FACTORS**

—In the calculation of *capacity*, as the capacity of a condenser, there are several different units. For instance, a *farad* is a large unit of capacity and is equal to one million *microfarads*, or conversely, a *microfarad* is equal to one millionth of a farad. In the same way a farad is equal to one billionth of an *abfarad*. The four units used in capacity measurement are the *farad, micro-farad, micromicrofarad, statfarad* and *abfarad*. The following table gives the conversion factors for these various units:

$$\begin{aligned}
 1 \text{ abfarad} &= \begin{cases} 10^9 \text{ farads} \\ 10^{15} \text{ mfd.} \\ 9 \times 10^{20} \text{ stfds.} \end{cases} \\
 1 \text{ farad} &= \begin{cases} 10^{-9} \text{ abfd.} \\ 10^6 \text{ mfd.} \\ 9 \times 10^{11} \text{ stfds.} \end{cases} \\
 1 \text{ mfd.} &= \begin{cases} 10^{-18} \text{ abfd.} \\ 10^{-6} \text{ farads} \\ 9 \times 10^5 \text{ stfds.} \end{cases} \\
 1 \text{ stfd.} &= \begin{cases} 1/9 \times 10^{-20} \text{ abfd.} \\ 1/9 \times 10^{-11} \text{ farad} \\ 1/9 \times 10^{-4} \text{ mfd.} \end{cases}
 \end{aligned}$$

1 mmfd. = 10<sup>-6</sup> mfd.

In the table above, farad is abbreviated Fd.; abfarad is shown as abfd.; microfarad is mfd., micromicrofarad is mmfd. and statfarad is stfd. In dealing with large figures containing many ciphers the amount is shown as 1,000,000 is 10<sup>7</sup>

and  $\frac{1}{1,000,000}$  is 10<sup>-6</sup>, etc. (See *Capacity, Farad, also Unit.*)

**CAPACITY EARTH or CAPACITY GROUND**

—A substitute for the usual ground connection where the wires or plates are buried beneath the ground or attached to a water or steam pipe. It is in effect a second aerial, and is placed either under the regular aerial or to one side. It is more used in radio transmission than in reception. (See *Counterpoise.*)

**CAPACITY ELECTROSTATIC**—See *Capacity also Electrostatic Capacity.*

**CAPACITY FREQUENCY FACTOR**

—The relation between the apparent capacity of a condenser and the *electrostatic capacity*. (See *Capacity, Condenser also Electrostatic.*)

**CAPACITY OF CONDENSERS IN PARALLEL**

—When several condensers are connected in parallel the resultant capacity is the sum of the individual capacities. It is written:

$$\text{Capacity} = C_1 + C_2 + C_3, \text{ etc.}$$

It will be evident that the resultant capacity of condensers connected in parallel is just the reverse of case for resistances, where the total resistance is less than that of the smallest individual resistance in the parallel connection. (See *Resistance Measurement also Capacity of Condenser in Series, also Condensers in Series and Condensers in Parallel.*)

**CAPACITY OF CONDENSERS IN SERIES**—When several condensers are connected in series with each other the resultant capacity is always less than the capacity of the smallest condenser in the group. The capacity of condensers in series is given as follows:

$$\text{Capacity} = \frac{1}{\frac{1}{C_1} + \frac{1}{C_2} + \frac{1}{C_3}, \text{ etc.}}$$

The resultant capacity is thus the reciprocal of the sum of the reciprocals of the several capacities. (See *Condenser, In Series.*)

**CAPACITY MEASUREMENT OF ANTENNA**—A simple method for the measurement of the capacity of an antenna as given by Austin follows: The illustrations show the general arrangement. The inductance L in Fig. A is a coil that will increase the wavelength (natural) of the antenna system 4 or 5 times; C is a calibrated variable con-

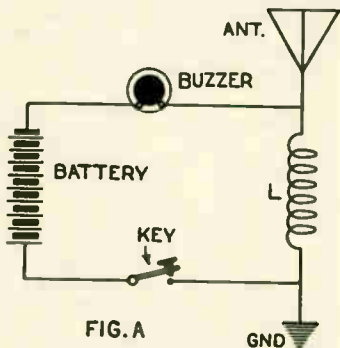

FIG. A

The first operation in the measurement of the antenna. The wavemeter is shown below.

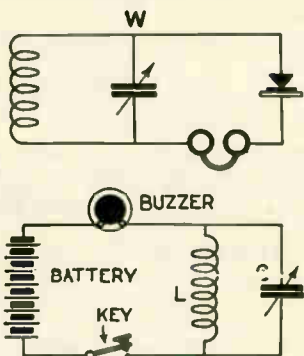

FIG. B

Circuit for the measurement of wavelength of coil and condenser.

denser and W a standard wavemeter. In operation the coil L is connected in the antenna circuit, the buzzer is used to excite the antenna circuit and the wavelength is measured by w. The coil L is then taken out of the antenna circuit and shunted by the condenser C. The condenser C is then varied until the wavelength of the combined coil L and condenser C is the same as that obtained before with the coil in the antenna circuit but without the variable condenser. The capacity of the condenser now will be approximately that of the antenna, ignoring the distributed inductance of the antenna system. Fig. A shows the first operation, the measurement of the antenna with the coil in the circuit, and Fig. B

shows the measurement of the wavelength of the coil and condenser. (See *Mutual Capacity, Wavemeter, Natural Wavelength, also Distributed Capacity.*)

**CAPACITY MUTUAL**—See *Mutual Capacity.*

**CAPACITY RESISTANCE**—The resistance to alternating currents offered by a body possessing electric capacity. (See *Capacity, also Resistance.*)

**CAPACITY SWITCH**—Any switch used in a circuit to introduce or cut out capacity (condenser).

**CAPACITY (UNIT OF)**—The unit of capacity is the farad. A condenser has a capacity of 1 farad when 1 coulomb is required to raise its potential from zero to 1 volt. Since the farad is very large, its millionth part, or the microfarad is generally used.

**CARBON**—A non-metallic chemical element used for many purposes in electricity and radio. It exists in three forms, two crystalline and one non-crystalline. The first two are diamond and graphite, the third charcoal. Carbon is used as an electrode in electric arcs, as one of the poles in certain types of primary cells, as a material in place of wire for various forms of resistance, and as brushes in motors and generators. (See *Diaphragm, Carbon.*)

**CARBON RHEOSTAT**—A rheostat or variable resistance using carbon in place of the customary wire. In its simplest form a carbon rheostat may be merely a piece of carbon having a sliding contact. This is shown in Fig. 1. Owing to the relatively high resist-

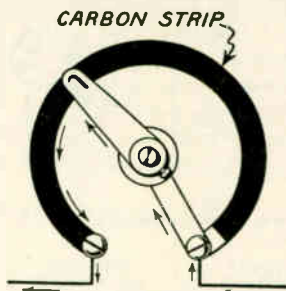

Fig. 1.—A carbon rheostat with a rotary sliding contact.

ance of carbon used in this manner, such a controlling resistance will generally be termed a *potentiometer* (q.v.) and used as such.

The most practical form of a carbon rheostat is known as a carbon pile rheostat. This type uses a number of flat pieces of carbon of relatively low

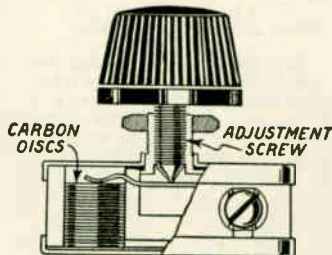

Fig. 2.—A carbon pressure type rheostat.

resistance placed together and arranged with a knob and screw in such manner that the pressure can be varied.

This change in pressure alters the resistance of the mass and allows control of the current for vacuum tubes. The same principle is used for very high resistances as well as for low values. The principle will be seen from the illustration Fig. 2.

**CARBORUNDUM**—An abrasive material, a product of the electric furnace, composed of silica and carbon. It is used in radio as a crystal rectifier, although the strides of radio have practically rendered it obsolete, many other better crystals being in use. The chief difficulty with its use as a rectifier or crystal detector was the fact that for efficient operation it required a cell or battery and potentiometer to regulate

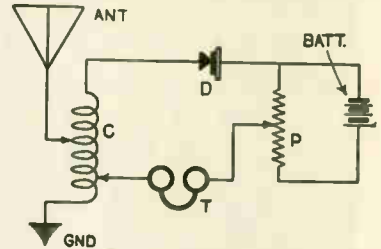

Diagram of a radio circuit employing a carborundum crystal detector.

the current flowing through it. The simple crystal circuit using a carborundum detector is shown in the illustration. C is a tuning coil, D the carborundum crystal and contact, P a potentiometer and T the head phones. (See *Rectifier, also Detector.*)

**CARDBOARD TUBING**—Tubing made of laminations of paper pasted together. They are used for home made coils of all descriptions, and while not as efficient as the composition tubing, can be used for many purposes without any great loss. As a general rule it is better to use some of the numerous compositions, such as bakelite or rubber compounds.

**CARPENTIER, JULES**—French radio expert. Born in Paris, in 1854, he joined the Ecole Polytechnique in 1871, and in 1876 was appointed principal stores engineer of the Lyons Railway Company, making a special study of electricity. For his work in electricity he obtained in 1881 the cross of Chevalier of the Legion of Honor. One of the early pioneers of radio in France, he founded the Compagnie Generale Radiotelegraphique, afterwards absorbed in the Compagnie Generale de Telegraphie sans Fil. Carpentier is a member of the Academie des Sciences, Commander of the Legion of Honor, and President of many scientific societies.

**CARRIER WAVE**—The *continuous wave* (q.v.) of radio frequency generally thought of as carrying the voice or music waves from the radio broadcasting station. Actually it is a radio wave of high frequency, which is altered in amplitude by the music or speech transmitted. In action, this continuous wave has another wave super-imposed on it. This other wave having wave form and amplitudes determined by the voice or other sounds being transmitted. The illustration shows the carrier wave, the waves representing speech or music and the combination of the two. This effect of varying the amplitude or strength of a continuous wave by means of some sort of program is known as *modulation* (q.v.) The wave representing the speech or music is imposed on the car-

rier wave resulting in the combined wave which reaches the listener and is translated by suitable apparatus into approximately the same sounds that are transmitted. (See *Modulation, Broadcasting, also Speech Vibrations.*)

**CARRYING CAPACITY**—See *Current Carrying Capacity.*

**CARTRIDGE FUSE**—A fuse in which the fuse wire is surrounded by some non-inflammable substance, enclosed in a cartridge-like tube and having brass lugs soldered to caps at ends. Used to prevent the hot wire from "flying" when fused. (See *Fuse.*)

**CASCADE**—A term applied to pieces of apparatus connected together in series, particularly vacuum tubes. In this case, the arrangement would be such that each vacuum tube would amplify the signal output of the preceding tube. The tubes will be so connected that the output of one is introduced as input to the next and so on the total result being greatly increased signal strength from the output of the last tube. This term may apply to either radio frequency or audio frequency amplification. (See *Amplifier, Radio Frequency, also Audio Frequency.*) A simple cascade arrangement is shown in the illustration. Fig. 1 is a circuit with two stages of cascade radio frequency amplification, and Fig. 2 a circuit using two stages of audio

**CATHODE RAY TUBE**—A vacuum tube having a high vacuum, that is from which practically all air has been exhausted, used in the production of

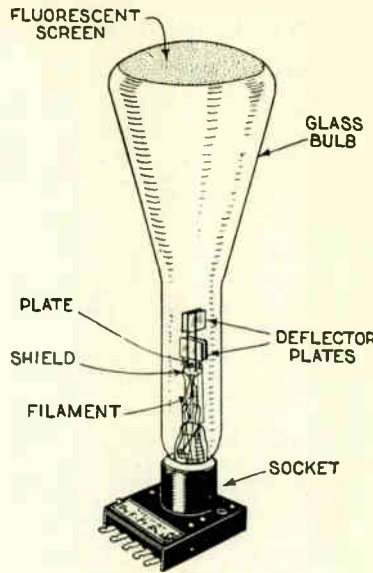

A cathode ray tube with socket.

measurement of hysteresis and dielectric loss in various materials, study of phenomena in arcs and sparks, together with numerous other associated effects. The development of this tube is one of the marvels of science, enabling the research engineer to virtually see the electric wave, and to study exhaustively, electric phenomena otherwise invisible.

The Western Electric modification of the Braun Cathode ray tube or oscillograph, is a three electrode glass tube about 30 centimeters (about twelve inches) long, in the form of a cylinder an inch and three-quarters wide, spreading out in conical shape, the tube being about three and a half inches wide at the top. The *cathode* is a filament coated with active oxides and arranged to emit the number of electrons required for the cathode rays, at a dull red heat. The *anode* or plate is a small platinum tube set very near the filament. Between the filament and the anodes is a small circular screen having a hole just a little smaller than the circular filament. A battery of several hundred volts is connected between the filament and plates with the positive terminal connected to the plate. The electrons emitted from the hot filament are controlled by this field in the same manner as in an ordinary vacuum tube. A small portion of these electrons pass completely through the tubular anode and constitute the *cathode rays*. These rays are passed between two pairs of deflecting plates set at right angles to each other, and fly against the large end of the tube. This end is covered with a fluorescent mixture which renders the rays visible. These rays are deflected in various ways. For example, if an alternating current is applied the visible spot on the screen will be drawn out into a line. (See *Electron, Vacuum Tube, also Wave Analysis.*)

**CATHODE RAYS**—The stream of electrons or electrical particles sent out from the *cathode* or filament of a vacuum tube. These rays are negatively charged. (See *Cathode, Electrons, Vacuum Tube also Oscillograph.*)

**CAT-WHISKER**—The fine wire used with certain crystal detectors to make contact with the crystal. Usually a springy metal such as phosphor bronze wire.

**"C" BATTERY**—One or more small

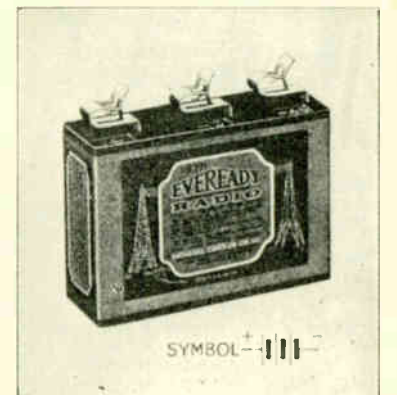

Fig. 1.—A 4½ volt "C" battery. This type of battery has a common positive terminal and is tapped at negative terminals for 3 and 4½ volts.

cells having a voltage generally between 2 and 10 volts, used in the grid

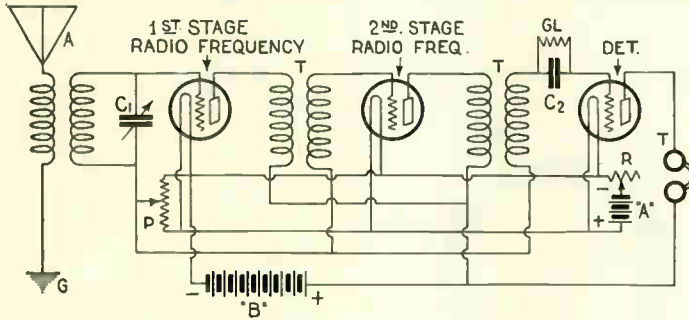

Fig. 1.—Circuit diagram showing two stages of cascade radio frequency amplification and detector.

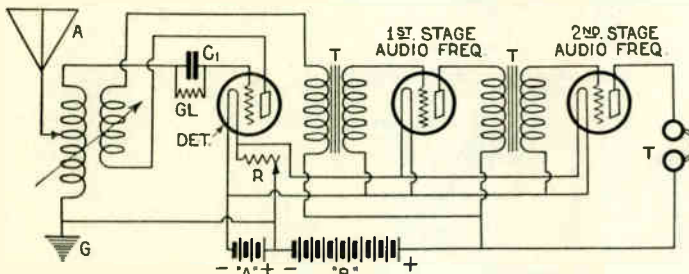

Fig. 2.—Diagram of detector and two stage cascade audio frequency amplifier.

frequency amplification with the usual detector tube in each case. A combination of both radio frequency and audio frequency stages of amplification might also be used, the term cascade amplification also applying here.

**CATHION** or **CATION**—The charged particles which appear at the cathode or move toward it through the electrolyte of an electrolytic cell. (See *Anode.*)

**CATHODE** or **KATHODE**—A *negative electrode*. The term is often applied to the filament of a vacuum tube to distinguish it from the anode or plate. (See *Cell, Electrolysis, also Anode.*)

cathode rays. These tubes in their modern form are used for many purposes in studying the nature and form of electric waves. The illustration shows one of the latest types of tube, known as the *Cathode Ray Oscillograph*. This tube is used for the following purposes: examination of the wave forms of various rectifiers, study of wave forms of different types of generators, study of vacuum tube characteristics, examination of the characteristics of X-ray and other types of tubes, examination of radio frequency waves modulated as in broadcasting,

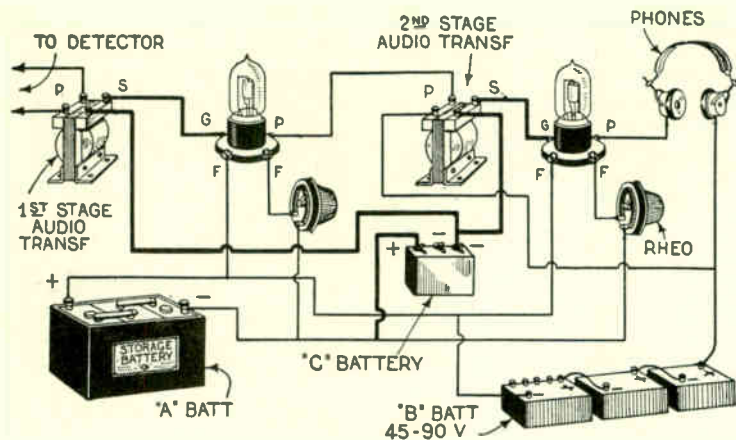
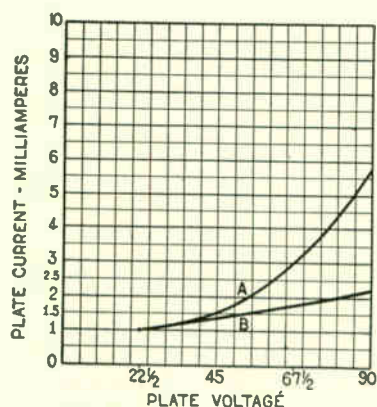

Fig. 2.—A diagram showing how the "C" battery is connected in the audio frequency amplifier.

circuit of an amplifier tube for the purpose of impressing a negative potential on the grid of the tube. The method of connecting it in the circuit is shown in Fig. 2. Fig. 1 shows a typical 4½ volt "C" battery. (See also *Grid Bias and "C" Battery Curve.*)

**"C" BATTERY CURVE**—In order to show the effect of a "C" battery on the consumption of current from the "B" battery in an audio amplifier, a curve (q.v.) may be drawn as in the illustration. In this case the test was made with a type UV 201A tube used as a one stage audio frequency amplifier in



Test conducted on UV201A tube using single stage audio amplifier with conventional circuit. Plate Voltage—Abscissae. Plate Current in milliamperes—ordinates. A—Consumption curve without "C" Battery. B—Consumption curve with "C" Battery. (Notes: 1.5 ma. at 45v plate rising to 5.75 ma. at 90v plate without "C". With "C" Battery consumption maximum is 2¼ ma. at 90v.)

a conventional circuit. It is readily apparent on referring to the lines A and B that when the "C" battery is in use the consumption of current by the plate is much less than without it.

**CELL**—A cell is one of the four chief sources of electric energy. In a cell the energy is created by an electrochemical process, using in its simple form two unlike metals immersed in a dilute acid or alkaline solution. In the illustration Fig. 1 the common form of electric cell is shown. C is a strip of carbon and Z a strip of zinc. These are placed in the jar in a conducting solution of sal ammoniac. If the exposed terminals from the carbon and

zinc strips are connected together by a piece of wire, current will flow from one side of the cell to the other through the wire. The current flows from the carbon or positive pole to the negative

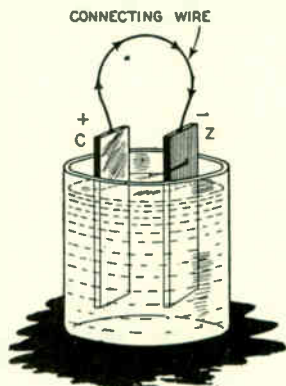

Fig. 1.—Common form of electric cell.

or zinc pole through the wire, completing the circuit through the solution from zinc to carbon. (See *Current, Direction of Flow.*) The cell described is known as a primary cell.

In Fig. 2 a simple storage cell or secondary cell is shown. In this case

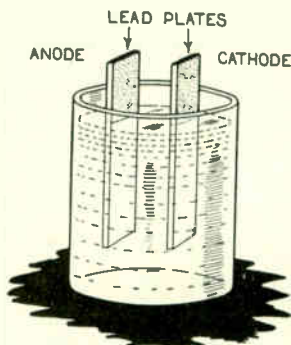

Fig. 2.—Storage or secondary cell.

there are two lead plates immersed in a dilute solution of sulphuric acid. A source of primary current (primary cell) may be connected to the secondary cell in the manner shown in Fig. 3 and after being connected for a certain length of time it will be found that the

energy of the primary cell has been transferred to the secondary cell and stored in it. This process of placing

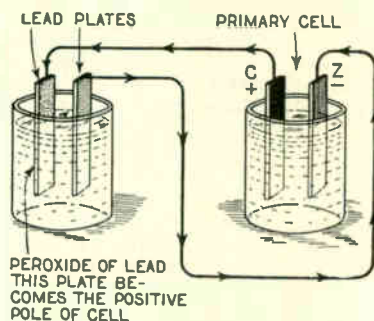

Fig. 3.—Primary cell connected to secondary or storage cell.

electric charges in a secondary cell is known as *charging*, and the current stored up in it is known as the *charge*. Now, if the wire is connected from one terminal to the other it will be found that electric energy can be withdrawn in a similar manner to that of the primary cell. A secondary cell may contain several plates and several of these cells may be connected together to form a storage battery. (See *Storage Battery, Current, Production of, also Anode and Cathode.*)

**CELL, SECONDARY**—When a primary cell is connected to a storage or secondary cell, the current from the primary cell flows into the secondary cell and in effect deposits energy in that cell. Then when the charging source (the primary cell) is withdrawn, the secondary cell can be used in practically the same manner as the primary cell. A wire connected from one terminal to the other will permit passage of current. The action of storing up energy in a storage cell is approximately as follows: When the charging current flows from plate to plate through the solution in the secondary or storage cell, the plate connected to the positive (+) pole (carbon or copper) of the primary cell, receives a brown coating of peroxide of lead. At the same time the other plate becomes spongy or porous. Now as one plate has received a coating while the other remains unchanged as far as its surface is concerned—it acts as a primary cell if the charging source is taken away and the two terminals connected. It now has all the essentials of an ordinary chemical cell. As long as the coating of peroxide of lead remains on the surface of one of the plates, the cell will be capable of delivering current.

When the coating has been worn off or eaten away the cell is said to be in a discharged condition. It will then be necessary to go through the same process of connecting a primary source to the terminals in order to again deposit peroxide of lead on one plate. It will therefore be evident that when the storage cell is charged, current is not actually stored in it, although in effect it has received potential energy. What has actually occurred is that the current supplied to the cell during the charging process has produced electrochemical changes, making the plates dissimilar and thus producing a difference of potential. (See *Current, Production of*). The voltage or electromotive force of primary cells varies from .06 to 1.5 volts according to the nature of the elements used and the

grade of the electrolyte (q.v.). Secondary or storage cells of the lead plate type produce from 2.1 to 2.6 volts. (For more complete explanation of the theory and action of a secondary cell, see *Storage Battery*. See also *Electro Motive Force, Current and Voltage*.)

**CELL, THEORY OF PRIMARY**—It

has been explained under the heading *Cell*, that a primary cell produces electrical energy by chemical action. More specifically the action of a simple cell is as follows: When the copper and zinc, or carbon and zinc placed in a cell are connected together by a conductor, (wire or other conducting object) the acid in the case of a sulphuric acid solution, attacks the surface of the zinc plate and forms a compound known as zinc sulphate. While this sulphate is being formed some of the hydrogen contained in the sulphuric acid is liberated in the form of bubbles which appear on the copper plate. Some of these bubbles escape into the surrounding air by rising to the surface of the solution, but others cling to the surface of the copper plate and gradually cover it with a film of hydrogen. It may be said here that the decomposition of the zinc plate in the acid solution furnishes the *electro-motive force* required to cause the flow of current between the plates, through the solution and through the conductor. Now, hydrogen is a non-conductor, and as the hydrogen gradually covers the copper plate, the surface of the plate in contact with the solution gradually decreases. The flow of current from zinc plate to copper plate in the solution is thus gradually diminished, until eventually we can imagine the copper plate as being entirely covered with hydrogen and no longer in contact with the solution. In addition to this insulating action of the Hydrogen, it tends to set up a current within the cell in the opposite direction to the normal flow of current produced by the chemical action. A cell in this condition is said to be "polarized," and various means have been used to cut down or eliminate the *polarization effect*. The purpose of these various means is to prevent the hydrogen bubbles clinging to the surface of the copper plate, thus allowing them to escape to the top of the solution and thence into the surrounding air. (See *Polarization, Current, Voltage, also Storage Cells*.)

**CENTIMETER**—A measure of length in the metric system. It is one hundredth part of a meter, or approximately .3937 inch. It is used as the unit of length in the Centimeter Gram Second System (q.v.).

**CENTIMETER GRAM SECOND** OR C. G. S.

A system of units of measure employed in practically every branch of engineering, particularly in electrical practice. It is a decimal system, the centimeter being the unit of length, the gram the unit of weight and the second the unit of time. All other units are derived from these three. When the magnitude of a quantity is spoken of, it refers to the relative magnitude of the quantity when compared with some other quantity of the same nature. The magnitude used as a standard of comparison is termed a unit. Thus, if the length of a body is measured in feet, as for example, ten feet, it means that the magnitude of the body is ten times unity or ten times one foot. Similarly a current of ten amperes, is a current of magnitude ten times as great as the unit quantity—one ampere. Now an ampere is the practical unit of rate of flow of electric current. The unit has a certain definite

value. (See Ampere.) The magnitude of any other similar quantity measured in amperes will mean a value equal to a certain number of units. In addition to the C. G. S. system of units, there is a practical system. This is commonly used for ordinary calculations. Under this system, the following are the main units: The *volt* is the practical unit of *electro-motive force*;—the force required to maintain a flow of current of one ampere through a resistance of one ohm. The unit of *current strength* or rate of flow of current is the *ampere*;—the strength of current maintained by a force of one volt through a resistance of one ohm. The unit of *resistance* is one ohm, and is the resistance of a conductor or circuit that will permit the passage of a current of one ampere under the force of one volt. The unit of *quantity* is the *coulomb*, which is the quantity of current flowing in a circuit when one ampere passes a given point during one second of time. The *watt* is the practical unit of *electrical power*, being the power of a current of one ampere flowing in a circuit under the pressure of one volt.

It will thus appear that the practical system is actually based on the C. G. S. system. Calculations of an involved nature necessarily make use of the C. G. S. system, and when multiples or sub-multiples are used they are expressed in Greek and Latin prefixes. For example, a million ohms is 10<sup>6</sup> ohms and is expressed as a *meg-ohm*. "Meg" being derived from *mega milian*. Similarly a millionth of an ampere is expressed as a *micro-ampere* or 10<sup>-6</sup> AMPERE. The various units under the C. G. S. and practical systems are taken up in detail under the respective headings, as *JOULE, ERG, DYNE* and so forth. (See also *Inductance (Unit of); Capacity (Unit of); Electrostatic Units and Electromagnetic Units*.)

**C. E. M. F.**—The abbreviation for *counter electromotive force* (q.v.).

**C. G. S. UNIT OF CURRENT**—The absolute electromagnetic unit of current. It is the current which when passed through a conductor bent into a circle of one centimeter radius will attract or repel a unit magnetic pole placed at its center, with a force of one dyne (q.v.).

**CERUSITE**—A kind of mineral used as a rectifier in some types of *crystal detectors*. It is a carbonate of lead having a whitish-grey color. This mineral is not as good a rectifier as some of the others, but has the advantage of more uniform sensitivity over practically its entire surface. (See *Crystal Detectors*.)

**CHALCOPYRITE**—A crystal used in a *pericon detector*, which is composed of zincite and chalcopyrite in contact with each other. It is a combination detector suitable for use where it is subject to jarring, since it has nearly uniform characteristics over its entire surface. It works without the aid of an electric battery.

**CHARACTERISTICS**—A term broadly applied in electricity to refer to any distinguishing feature in electrical apparatus. In radio usage the term is generally applied to *vacuum tubes*. The characteristic of a tube is understood as the relation between the potential (voltage) at the *grid* (q.v.) and the resulting current obtained from the *plate*. (q.v.) It may also occasionally refer to other features of a tube, such as its current requirements or amplifying quality as distinct from the ratio of *grid voltage to plate current*. (See

*Characteristic Curve, Vacuum Tube Characteristics; also Plate Current*.)

**CHARACTERISTIC CURVE**—A diagram showing graphically in the form of a curved line the relation of changing values. Thus, in the case of a *vacuum tube*, a change in the *grid voltage* produces certain changes in the *plate current* (q.v.) and these changes may be plotted as curves. The temperature of a wire carrying current increases with increase in the *current*

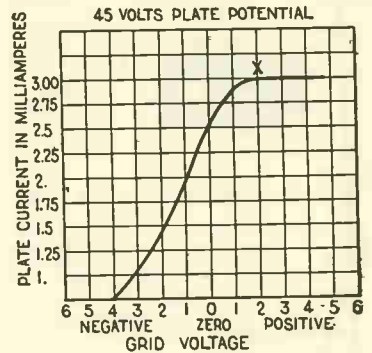

Characteristic chart of vacuum tube grid and plate voltage.

passing through it, and this increase may be shown by a curve. (See *Vacuum Tube Characteristics*.)

**CHARGE**—The presence of electricity in a body. Is usually defined as an excess or deficit of *electrons* (q.v.) on an insulated body. In the case of a *condenser* (q.v.) after it has accumulated electrical energy it is said to be in a charged condition, or to have an *electro-static charge*. The charge in a condenser is measured in *coulombs* (q.v.) A *storage battery* is said to contain a charge when it has been connected to a source of direct current for a length of time, and the hydrometer test shows the electrolyte at proper specific gravity.

**CHARGE, SPACE**—See *Vacuum Tubes, also Space Charge*.

**CHARGED BODY**—Any body that has accumulated electrical energy. (See *Charge*.)

**CHARGER, STORAGE BATTERY**—Any means of controlling the current delivered from a primary source for the purpose of charging *storage bat-*

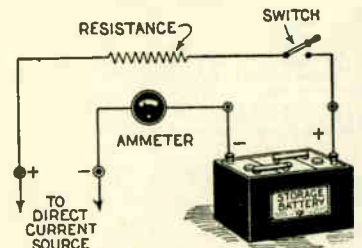

Charging storage battery from direct current source.

*teries* or other *secondary cells*. Chargers are made in many forms and are designed for either direct or alternating current. Direct current chargers consist of certain resistances, with the necessary meters and switches. A simple form of direct current charger is shown in the illustration. In constructing a direct current charger there are several important details that must be



taken into consideration. The plates of a storage battery require certain charging rates in amperes, depending on the size and number of the plates. That is to say, the manufacturer specifies that when charging, a certain number of amperes must be passed to the battery from the charging source for a definite number of hours. This figure may be decreased but not increased. As an example, some storage batteries will take a charge of five amperes without injury to the plates, which rate would be ruinous for other batteries. Now the question of obtaining the proper amount of charging current arises. The majority of house lighting systems have a voltage of from 110 to 125 volts. (Reference is now made only to direct current systems, alternating current chargers being taken up later on.) According to *Ohm's Law* (q.v.) the current flowing in a circuit is directly proportional to the voltage and inversely proportional to the resistance. Voltage is the product of resistance times the current, the resistance in ohms and the current in amperes. Therefore if we desire a current of five amperes from a source of 110 volts, it is necessary to have a resistance of a value in ohms which, when multiplied by the current in amperes,—five in this case—will produce 110. Conversely, we can divide the voltage—110 by the current—5 to obtain the correct resistance. This would indicate a resistance of 22 ohms. There is another factor which enters into the problem however, the back pressure, or Counter Electromotive Force exerted on the charging source by the battery. In the case of a six volt storage battery, this will be six volts. This must be subtracted from the voltage of the charging source to obtain the effective value. Thus, the effective value in this case would be 110 — 6 or 104 volts. Then as explained before, dividing the voltage by the current required, we find that it is 104 ÷ 5 or approximately 21 ohms. Then by placing a resistance of 21 ohms in the circuit, as shown in the illustration, and connecting the battery as indicated, a charge of five amperes can be applied to the battery. The same result can be obtained by placing an ordinary electric lamp in series in place of the resistance. (See *Lamp Bank*.) The internal resistance of the battery is very small compared to that of the line resistance, and can be ignored. A point to remember is that the voltage of the charging source must always be higher than that of the storage battery, because, as explained above, the back or counter electromotive force of the battery, must be subtracted from the voltage of the charging source to indicate the effective voltage. Thus, if the battery exerts a counter electromotive force of six volts and the charging source is only six volts the counter force would be equal to the charging force and there would be no charging current. When direct current is not available and alternating current is used to charge the battery, it will be necessary to change it to direct current. For this purpose it is essential that some form of rectifier be used. This rectifier may be of a chemical, mechanical or electrical type. These various forms will be taken up under their separate headings. (See *Rectifier, Bakkite, Tungar, Rectigon, Electrolytic Rectifier, Tube Rectifier*.)

**CHARGING**—The act of expending electrical energy to place a charge in or on a battery or body. The term is used generally to indicate the process

of impressing electrical energy on the storage battery elements for the purpose of making the battery a secondary source of electricity. (See *Charger, Chemical Rectifier* also *Tube Rectifier*.)

**CHARGING BOARD**—A term used synonymously with *charging panel* to denote an arrangement for controlling the current used for charging storage batteries. It generally consists of an insulated panel with various switches, fuses and resistances thereon to limit the amount of current delivered, and at the same time furnish a ready means of connecting and disconnecting the various circuits connected through it. The fuses act as safety devices and break the circuit when too great a current is delivered. (See *Fuse, Switch, Charger*.)

**CHEMICAL RECTIFIER**—Device for changing alternating current to direct current. (See *Electrolytic Rectifier*.)

**CHLORIDE BATTERY** A type of storage battery for heavy duty operation. The positive plate is made of lead with a number of holes pierced in it and each filled with a coil of pure lead. This coil is forced into the holes during manufacture and is said to enable the battery to withstand heavy discharge without damage to the plates. (See *Storage Battery*.)

**CHLORIDE CELL**—A cell (q.v.) which uses in most cases, a positive plate having lead as the active material, the negative plate being made of metallic zinc. A solution of chloride of zinc is used, from which the name is derived. (See *Chloride Battery*.)

**CHOKE OR CHOKING**—The action of a device in a circuit wherein it tends to choke, or hold back, certain forms of current or certain frequencies while permitting others to pass freely, or to oppose fluctuations in the strength of the current passing through it in the circuit.

**CHOKE COIL**—A coil of wire possessing considerable self-inductance and relatively little resistance. These coils are used in various ways and for a variety of purposes. When connected in a direct current circuit, and possess-

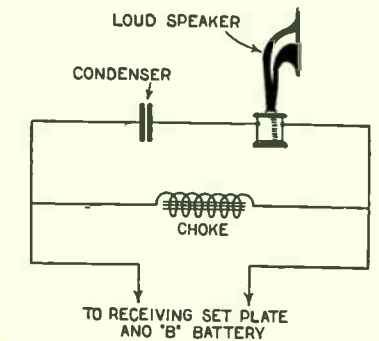

Method of using choke coil in connection with loud speaker.

ing the proper value, they have a tendency to prevent any fluctuations in the current and thus keep the current smooth. An example of its use is with a loudspeaker. A condenser will permit passage of high frequency (alternating) currents such as we find in radio reception, but will effectively block direct currents. On the other hand a choke coil will pass direct current without offering any appreciable resistance, but will retard the modulated currents (q.v.) It will be apparent then that by a proper combination

of the two (Choke Coil and Condenser) as in the illustration, the direct currents can be shunted around the loud speaker and thus prevent injury to it, while the necessary modulated currents are allowed to pass through without difficulty. Another use for the Choke is in a circuit carrying alternating currents. In this case the choke will limit the current in the circuit without loss, whereas an ordinary resistance, while it would limit the current, would dissipate a certain amount of energy. Chokes may be made with iron cores of the open or closed type, for low frequency currents, or may only have air for the core when used in high frequency circuits. The closed core type is the more common form. The formula most commonly used in determining the inductance of a choke coil in henries is as follows:

$$L = \frac{1.257 \times \mu \times A \times N^2 \times 10^{-9}}{l}$$

Where L is the inductance in henries.  $\mu$  is the permeability. (This varies from about 1000 to 2000 in most cases).

A is the effective area of iron cross section (square centimeters).

N is the number of turns of wire.

l is the length of iron path (in centimeters).

**CHOKE, HIGH FREQUENCY** — A choke coil of high self-inductance (q.v.) used in transmitting circuits to prevent puncture of the secondary

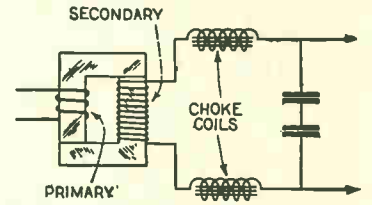

Position of choke coils in transmitting circuit.

windings of the transformer (q.v.). When the condensers in a transmitting circuit are charged or discharged, a back pressure is exerted on the windings of the transformer supplying the high voltage. The illustration shows the position of these choke coils in the transmitting circuit. (See *Back Oscillation*.)

**CHOPPER**—A device used in the aerial circuit of a continuous wave (q.v.) transmitter to break up the continuous trains of waves into separate groups and thus permit them to become audible. In the case of reception of or-

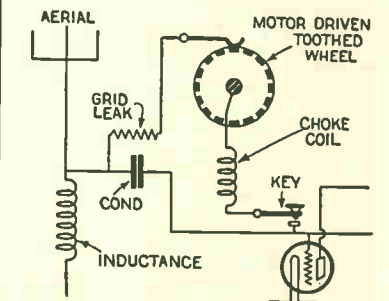

Showing how chopper is used to interrupt signal from continuous wave transmitter.

inary damped waves (q.v.) the head phone produces signals that have a frequency of vibration equal to the number of wave trains per second. When the transmitted waves are con-

tinuous there is obviously no interval, that is, there are no groups of waves and they are therefore inaudible in the usual receiving apparatus. The *chopper* is only necessary when *crystal detectors* are used for reception. (See *Ticker, Beat Reception and Continuous Wave Transmission.*)

**CIRCUIT**—The path followed by an electric current passing from its source through a wire conductor or series of such *conductors*, and back again to its starting point. A *closed circuit* is one that is continuous and will permit the passage of current. An *open circuit* is one that is not continuous and, being broken or open at some point, will not permit passage of the current. The term is used very commonly, and broadly covers any system for the conducting of electric current from its source, through some electrical instrument or appliance and back to the starting point.

**CIRCUIT BREAKER**—Generally speaking, any device for automatically breaking or opening a circuit and thus preventing flow of current through the circuit. More specifically, it may be a device similar to a *switch*, used to auto-

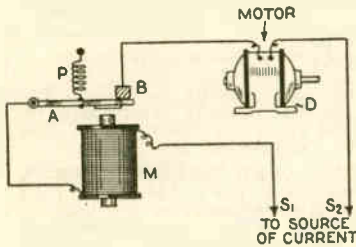

Fig. 1. Overload Circuit Breaker.

matically open the circuit when the current falls below a certain point, or rises above a certain fixed value. Thus an *overload circuit breaker* is an arrangement which will automatically open the circuit if the current becomes too great. This is shown in Fig. 1. It is a simple form and consists of an *electro magnet* which requires a certain force to operate it. When the current in the circuit reaches a certain point, the magnet operates, pulling down the bar "A" against the action of the spring "P," and thus breaking the circuit. As long as the current is not more than that fixed by the requirements of the circuit—the magnet being arranged in accordance with the particular requirements—the current flows, the breaker operating to open the circuit only when more than the desired current is introduced into the circuit. In the illustration we can consider "S1" and "S2" as the source of current, "M" as an electro-magnet in series with the motor "D," and "A-B"

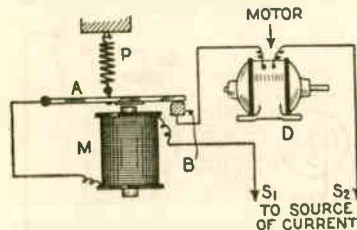

Fig. 2. Underload Circuit Breaker.

a switch, in which "A" has attached to it a piece of soft iron. Now if the current required for the motor is ten amperes, the magnet can be so designed

that it will not act on the bar "A" until 15 amperes flow through it. Thus, as long as the current is less than this, the circuit is continuous, but if the current is increased to 15 amperes, the magnet operates and attracts the bar "A," breaking its contact with "B" and thus opening the circuit. In Fig. 2 a simple *underload breaker* is shown. In this case the operation is the reverse of that of the *overload breaker*. Here the bar "A" is held down in contact with "B" by the magnet "M" thus keeping the circuit closed through the motor "D". Now assume that the motor requires ten amperes and the magnet requires the same amount to hold the bar "A" in place against "B". If then the current in the circuit falls below ten amperes, the magnet can no longer hold the bar "A" against the action of the spring "P" and it rises, breaking the contact between "A" and "B" and thus opening the circuit. These circuits are of course only assumed for the purpose of illustrating the theory of circuit breakers. Actually the system is generally much more elaborate. Circuit breakers are used for many purposes—chiefly to prevent any sudden increase or decrease of current in a circuit, and to control the flow of current for charging batteries. (See *Charger-Storage Battery.*)

**CIRCUIT, BROKEN**—A circuit that is not continuous, having been opened either purposely, or due to some defect in the circuit. The term is usually applied where the circuit is opened by the breaking of a wire, or through a faulty contact.

**CIRCUIT, OPEN**—A circuit which is open and through which current cannot flow, or a circuit which is normally open but which can be closed at will by

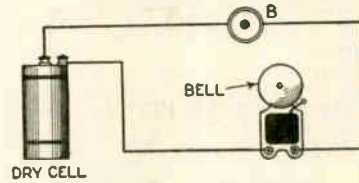

DRY CELL

Open circuit which can be closed by pressing button "B".

pressing a key or button. A common example of open circuit is in the case of an electric bell circuit. The illustration shows such a circuit. Normally it is open and current does not flow to the bell, but on pressing the button B, the circuit is closed and current passes to the bell. (See *Circuit*, also *Closed Circuit.*)

**CIRCUITS, PARALLEL** — Circuits starting at a common point and ending at a common point. The illustration

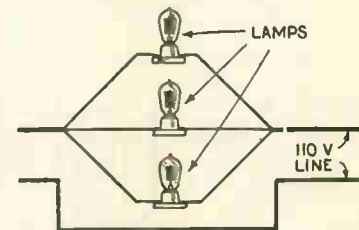

Three parallel circuits.

shows three *parallel circuits*. Actually each one is a part of the whole circuit. (See *Parallel Resistances.*)

**CIRCULAR MIL**—The cross-sectional area of conductors (wires) is usually designated in terms of circular mils. A circular mil is the area of a circle having a diameter of one thousandth of an inch. Thus a wire having a diameter of one quarter of an inch is said to have an area of 250 circular mils. (See *Square Mil.*)

**CLEAT**—A form of porcelain *insulator* used in house wiring. They are generally arranged in two parts, with corresponding grooves in which the wire is held, and are nailed or otherwise fastened to the wall. Cleats are about the cheapest form of insulator and where the voltages used are low, are quite as effective as the more elaborate types. Cleats are much used in radio work, both for insulating lead in wires coming from the aerial, and for insulating the aerial itself.

**CLERK-MAXWELL, JAMES**—Born at Edinburgh, Scotland, in 1831, and educated at Edinburgh and Cambridge University, he became Professor of Natural Philosophy at Aberdeen, 1856-69, and Professor of Physics and Astronomy at King's College, London, 1860-65. In 1871 he became the first



James Clerk-Maxwell.

holder of the new chair of experimental physics at Cambridge, where he died, November 15, 1879. Clerk-Maxwell was recognized in his later years as one of the greatest authorities on physics of his time, and his fame has been steadily increasing since his death. Radio owes Clerk-Maxwell a deep debt. Electricity was the chief study of his lifetime, and his first important paper on the theory of *electromagnetism* was communicated to the Royal Society in 1867. In 1873 he published his "Electricity and Magnetism," a work on the subject which has never been surpassed. In it he formulated his famous *electro-magnetic theory* of light and his theories on electric waves, which developed into the modern system of wireless telegraphy and telephony through the experiments of Hertz.

**CLIMAX**—A high resistance nickel steel alloy, used extensively in *rheostats* (q.v.). It is one of the cheapest and most practical alloys for low-temperature resistance wire. Its chief properties are as follows: Maximum working temperature 540 degrees centigrade, resistance in microhms per cubic centimeter at 20 degrees centi-

grade, 87.2; temperature coefficient per degree centigrade, .00054, and having a specific gravity of 8.14.

**CLIPS**—A clamp connector used for various purposes in radio receiving and transmitting circuits. (See *illustration*.) In a receiving set a clip may be used at the end of a flexible wire for the purpose of varying the connection to the various "B" battery taps; clips are very frequently used in



Type of clip in general use.

making the connections to the storage "A" battery, and for many other purposes about the receiving set. One of their principal uses in the transmitter is in connection with the leads to the oscillation transformer. Flexible leads with clips attached come from the other units of the transmitter and are clamped at will along the various turns of the oscillation transformer until the point giving the desired wave length or highest radiation reading is found.

**CLOCK WISE**—A term used to indicate that the rotating part of an electrical machine or instrument moves from left to right (when facing it), or as the

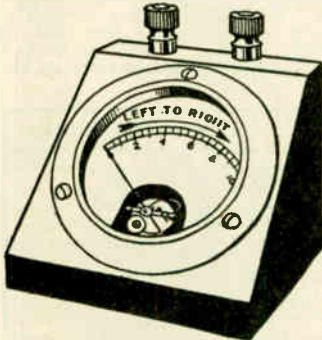

Indicator needle moves from left to right in clockwise motion.

hands of a clock. In the illustration the needle or pointer of the meter moves in a clock-wise direction. In an electrical measuring instrument this is always true where the zero point is at the left part of the dial. The opposite is known as *counter-clockwise*. When looking at the *armature* of a motor or generator, if the rotating part moves from left to right it is said to have a clock-wise motion.

**CLOSE COUPLING** The arrangement of two coils acting as *primary* and *secondary*, placed close together in such manner that the coupling or electrical relation between them is close. In the

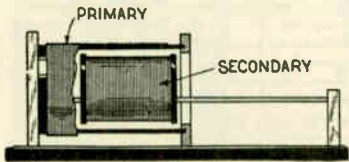

Loose coupler with secondary placed to produce close coupling.

illustration the secondary coil is shown entirely within the primary. In other words the transfer of energy will be large in this case as the coupling is

close. If the secondary is withdrawn a certain distance from the primary, the effect is referred to as loosening the coupling, and the coils are then said to be *loose coupled*, the transfer of energy from one to the other being considerably less than in the case of close or *tight coupling*. (See *Coupling*.)

**CLOSED CIRCUIT**—A circuit which permits the continuous flow of electricity. The illustration shows an or-

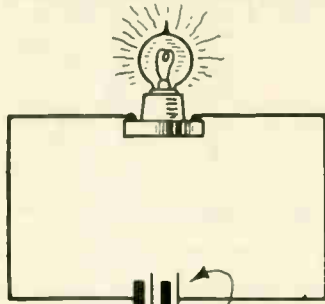

BATTERY

-1 A-

Circuit closed.

dinary dry cell connected in circuit with a small lamp. In Fig. 1A the circuit is closed and current is per-

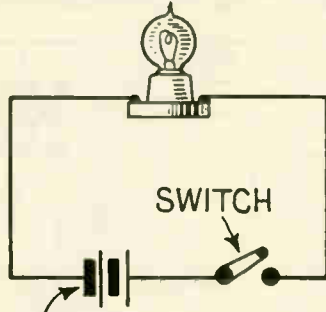

BATTERY

-1 B-

Circuit open by means of switch.

mitted to flow to the lamp. In Fig. 1B the circuit is open and no current can flow. A closed circuit is therefore an electrical circuit that is continuous. (See *Circuit*, also *Open Circuit*.)

**CLOSED CIRCUIT CELL**—A cell that can be used in a closed circuit for a

considerable length of time without the impairing effects of *polarization* (q.v.) An *open circuit* cell is one that can only be used intermittently, as for example, with an electric bell where the circuit is only closed for a brief period. If an open circuit cell is used in a circuit that remains closed for some time, polarization sets in and ruins the cell in a very short time. An open circuit cell might be used with the *test buzzer* (q.v.) because in this case the circuit is closed intermittently as the key is depressed. (See *Cell*.)

**CLOSED CORE**—A core (q.v.) used in *transformers*, *chokes*, etc., which is continuous, forming a *closed magnetic path*. The illustration shows the difference between a closed core and an open core. In the open core type, one end is the north pole, the other the south pole, whereas in the closed core,

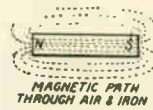

MAGNETIC PATH THROUGH AIR & IRON

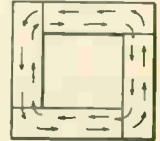

MAGNETIC PATH ENTIRELY THROUGH IRON

Open core above on left, closed on right.

there are obviously no poles. The closed core type is occasionally referred to as a *non-polar core*. (See *Core*, *Transformer*, also *Choke*.)

**CLOSED CORE TRANSFORMER**—A transformer (q.v.) having a *closed core*. In the illustration the magnetic path, or core, is continuous, being made of strips of uniform size. This form

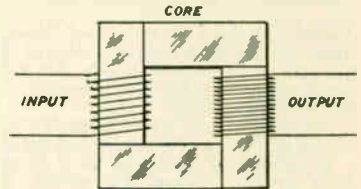

Closed core transformer.

of core is known as "*laminated*." An efficient transformer is generally made with a closed core. A transformer may be for a variety of purposes, such as *step-up*, *step-down*, *audio frequency* or *radio frequency*. (See *Transformer*.)

C. M.—Abbreviation for circular mil. (q.v.)

Cm.—The abbreviation for *centimeter*, the unit of length in the C. G. S. system (q.v.).

**COCKADAY CIRCUIT**—A popular radio receiving circuit devised by the American experimenter, Lawrence M.

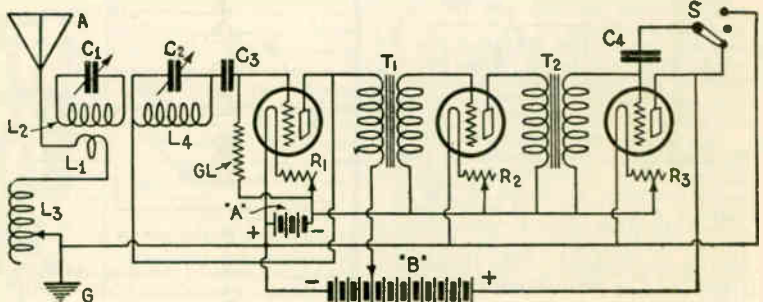

Fig. 1. Original 3 tube Cockaday Circuit.

Cockaday. It includes several radical features not found in the usual systems. Receivers using this circuit are generally made in three, four or five tube types. The chief value of this cir-

four windings, i.e. tapped primary, separate closed circuit coil, grid or secondary winding and a single turn looped around the closed circuit coil. (See *Cockaday Circuit*.)

after the establishment of that means of communication. In this system, which is also called the "American Morse Code," some of the characters are made up with so-called spaces

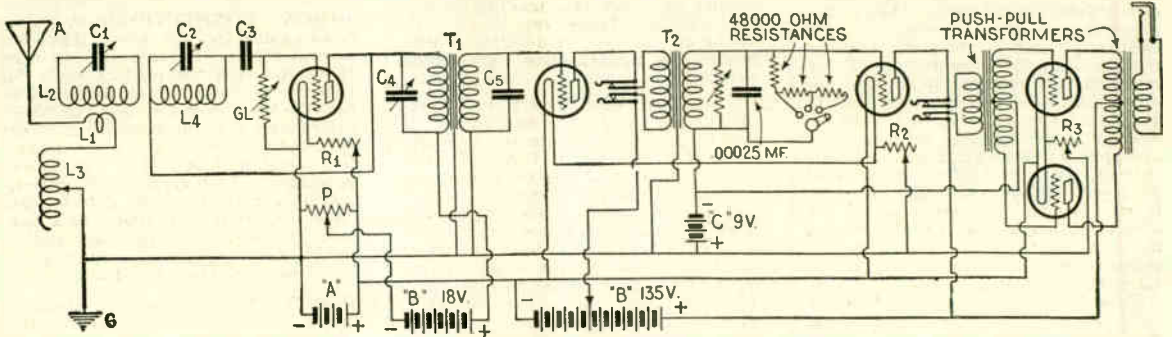

Fig. 2. Cockaday Circuit with push-pull amplifier.

cuit lies in its extreme selectivity. It is usually referred to as a four circuit receiver, owing to the addition of a sensitizing circuit to the regular three circuit regenerative system. The diagram for the three tube receiver is given in Fig. 1. Here the primary or aerial tuning circuit is seen to have a single turn of wire, L1, wound around another coil L2, which is shunted by a variable condenser C1, thus forming a separate closed, tunable circuit, coupled very loosely with the antenna circuit. The primary, or antenna circuit, has in addition to the single turn, a bank wound coil L3 connected in the ground side of the open circuit and tapped to permit coarse tuning. Thus, the primary is coupled inductively to the separate closed circuit, which in turn is inductively coupled to the grid or secondary circuit containing a coil L4 shunted by the condenser C2, allowing tuning.

The tone of the music is varied by means of the novel arrangement using a condenser C4 connected to a three point switch. When the switch is placed in the center position the condenser is eliminated from the circuit and the wiring is standard. With the switch on the top tap, the grid of the tube is connected to the ground, thus by-passing a portion of the oscillations and giving a smooth soft tone with a certain loss of volume. With the switch arm on the bottom tap, the grid of the last tube is connected to the plate circuit, thus producing a different note due to the added grid-plate capacity. Coil L2 in the grid circuit is tuned by means of C1, which is a variable condenser of .0005 mfd. capacity.

A peculiarity of the circuit is that the length of the antenna has no bearing on the tuning. This is due to the semi-apertic primary and the fact that the sensitizing or pick-up coil is only one turn of wire, the inductance of which, compared to the whole inductance of the aerial circuit, is so small that any change in the over-all inductance has little, if any, effect.

This circuit, while originally having three tubes, has been arranged in conjunction with a standard push-pull audio amplifier, as shown in Fig. 2, making a five tube set with great power and possessing the characteristic of the original circuit with increased amplification. (See *Push-pull, Cockaday Coil* also *Regenerative Receiver*.)

CODE—Telegraph codes consist of characters formed by combinations of dots, dashes and spaces which represent letters, numerals, and punctuation marks. These characters are sent out by the radio operator with the aid of electrical impulses, and by using suitable receiving apparatus the receiving operator hears the incoming signal and is thus able to interpret the various combinations of dots and dashes and reproduce the original message. The Morse Code of characters came into general use in wire telegraphy shortly

which are part of the group signal, and are necessary in distinguishing those characters. The International Morse code is a modified form of the American Morse code, and no spaces are used in the characters of the International Code. The International Morse Code is used all over the world for radio telegraphy, and for wire telegraphy in almost every country except the United States, Canada and parts of Australia. The American Morse, owing to the fact that there are fewer dashes in the characters, is about

LETTERS	MORSE	CONTINENTAL
A	• —	• —
B	— • • •	— • • •
C	• • • •	• • • •
D	• • • •	• • • •
E	•	•
F	• — • •	• • — •
G	— • • •	— • • •
H	• • • •	• • • •
I	• •	• •
J	• — • • •	• — • • •
K	— • • •	— • • •
L	— • • •	— • • •
M	— • • •	— • • •
N	• •	• •
O	— • • •	— • • •
P	• • • •	• • • •
Q	• • • •	• • • •
R	• • • •	• • • •
S	• • • •	• • • •
T	— •	— •
U	• • • •	• • • •
V	• • • •	• • • •
W	• • • •	• • • •
X	• • • •	• • • •
Y	• • • •	• • • •
Z	• • • •	• • • •
&	• • • •	• • • •
1	• • • •	• • • •
2	• • • •	• • • •
3	• • • •	• • • •
4	• • • •	• • • •
5	• • • •	• • • •
6	• • • •	• • • •
7	• • • •	• • • •
8	• • • •	• • • •
9	• • • •	• • • •
0	• • • •	• • • •
.	• • • •	• • • •
?	• • • •	• • • •
!	• • • •	• • • •
;	• • • •	• • • •
?	• • • •	• • • •

Morse and Continental Codes.

COCKADAY COIL—The coil used in the Cockaday circuits. It comprises

5% more rapid than the International Morse. The American Morse and International (Continental) Codes are given herewith.

**COEFFICIENT**—In algebra, a number or multiplier of a *symbol*. Thus in the expression  $5Y$ , the coefficient is 5. In electricity, and in its radio application, it is a number expressing the relation or ratio between quantities, one of the quantities generally being unity (1) as a basis or standard for the coefficients. For example, let us assume a copper wire is carrying an electric current, the resistance of the wire at 32 degrees Fahrenheit being one ohm. If we consider the resistance of the wire at 32 degrees to be unity, or one, then its resistance at any other temperature will be some number or coefficient times one.

To make this clearer, let us take the ratio of an inch to a foot. An inch is one-twelfth, or approximately .0833, of a foot. Any number of inches multiplied by this fraction will give another number in feet. Therefore we say that the coefficient, or multiplier, of an inch as compared to a foot is .0833. A coefficient is thus any number by which a quantity must be multiplied to give another quantity.

In radio the most common cases of coefficients are the following. The *coefficient of coupling* is the ratio between the *mutual inductance* (q.v.) (between the two coils, *primary* and *secondary*) and the square root of the product of the total *self-inductances* (q.v.) in the two circuits containing the coils. Similarly, the coefficient of amplification is the ratio of the effect produced with an *amplifier* (q.v.) to the effect produced without an amplifier. (See *Mutual Induction Coefficient*, also *Self-induction Coefficient*.)

**COHEN, LOUIS, Ph. D.**—Born in Russia, Dec. 16, 1876. Educated at Armour Institute of Technology, University of Chicago and Columbia University. Noted for his formulae and tables for the calculation of alternating current problems. He has written a book on the subject. Has evolved many formulas for the measurement of inductance and capacity. Has secured a number of patents on radio apparatus.

**COHERER**—A device formerly employed for detecting *radio waves*. In its original form it consisted of two metal rods separated by a narrow space in a glass tube and the gap between the rods filled with nickel and silver

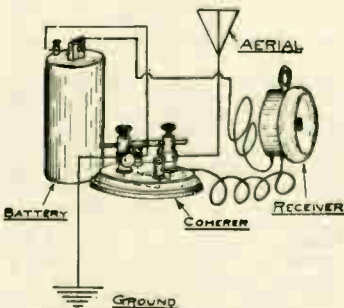

Coherer used in radio receiving circuit.

filings. It was found that when the *electromagnetic waves* or signals were passed through the coherer the particles of filings clung together and became *conductors*. Then by using some device such as the tapper hammer of

an electric bell to strike the glass tube, again separating the particles after each signal, it was possible to keep the coherer constantly in a state of change between a *conductive* and a *non-conductive* condition, thus making the signals audible. There were many variations of this type of *detector*, which, however, is now obsolete. (See *Marconi Coherer*.)

**COIL**—A term having very broad application in electricity and radio. It may be used to designate any arrangement of a number of turns of wire, usually copper, and used for almost any purpose in the production of electric and magnetic effects or phenomena. The most common significance of a "coil" in radio is in reference to a number of turns of insulated wire wound on various forms and used for *tuning* (q.v.). The term *inductance coil* is generally used, although actually, any coil of wire will have inductance. Coils come in countless numbers and variety for many purposes. A coil may be used not alone for tuning—that is to adjust a receiver or transmitter to resonance with incoming or outgoing signals; it may be used to connect two circuits, in which case it is known as a *coupling coil*; it may be used with a *core* (q.v.) of iron wire, or laminated pieces, as a *choke coil* (q.v.) or it may be used in connection with *high frequency* apparatus, such as used by physicians. Coils are generally referred to by individual names indicating their construction or use. (See *Inductance, Tuning Coil, Vario-coupler, Choke Coil, Honey Comb Coil, Pancake Coil, Spider Web Coil, Lorenz Coil, Duo Lateral Coils*.)

**COIL ANTENNA**—Or *Loop Aerial*. An antenna (aerial) constructed by winding the wire around a square form. The coil (or loop) antenna, because of its comparatively small size, is often mounted on a frame work which may be rotated. If one end of the coil is pointed toward the broadcasting station, the antenna (aerial) will pick up its signals with maximum intensity, but if the coil is rotated from that position the signals from that station grow weaker, until when the plane of the loop is at right angles with the intercepted signals no sound will be obtained. It is a part of the radio compass used at sea. (See *Loop-Aerial*.)

**COLLECTOR RINGS**—Insulated metal rings attached to the *armature* (q.v.) of an *alternator* (generator of alternating current) in such fashion that the alternating currents can be collected and communicated to the *brushes* without change, these rings are used to collect alternating current from that type of generator and brushes are used to collect direct current from a direct current generator.

**COLLODION**—A solution used by surgeons to cover slight abrasions or wounds, forming a protective coating similar to skin. It has been adapted to radio use as an insulating coating and is used as a binder on coils of various forms. It has been found more efficient than shellac for this purpose. A solution of pyroxylin or soluble gun-cotton in ether, with a certain amount of alcohol, depending on the purpose for which intended. When used as a coating for coils it serves as an insulator and also to hold the coils in place, but it should be sparingly applied.

**COMBINATION DETECTOR**—A detector composed of two different crystals in contact, instead of one crystal with a fine wire to search out the sensitive spots. Some combination detec-

tors are composed of silicon and antimony; zincite and bornite; lenzite and cerusite, and zincite and chalcopyrite. These detectors all function without a battery and are simple to operate.

**COMMON CONNECTIONS**—A term often applied to a connection that joins several points. For example, in most radio receivers the binding posts for battery connections are arranged so that the "B—" and the "A+" or "A—" are connected to the same point. That is to say the post is a common connection for these leads. The term is also applied to a battery, as a "B" battery, which is used for both *detector* and *amplifier*. It is then known as a common "B" battery. The other method would, of course, be to use separate batteries for the detector and amplifier.

**COMMUTATOR**—In general electrical use, a device for reversing the direction of electric currents in a circuit. A *commutator* as used with a *generator* usually consists of a number of pieces called *segments*, mounted on a circular form but carefully insulated from each other. The illustration shows a com-

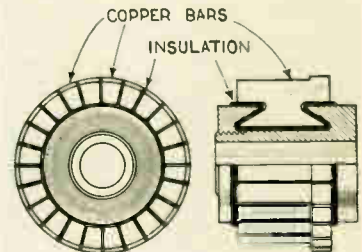

Front and side view of Commutator.

mon form. In the case of an ordinary motor, the commutator is employed to distribute the current to the windings and in a direct current generator it serves to furnish a direct current to the brushes although the current collected from the windings of the *armature* is alternating.

**COMPASS, RADIO**—See *Direction Finder, Goniometer*, also *Bellin-Tosi Direction Finder*.

**COMPONENT**—A part of the whole. In mechanics it is one of the parts of a stress or strain (mechanical force). In electricity, *component currents* are the several currents into which a single current may be assumed to be separated, so that if assumed to be acting together they would produce the equivalent effect of the actual current. Thus also, component *E. M. F.'s* (*electromotive forces*) are understood as the several components into which any electro motive force may be divided. *Impedance* (q.v.) is said to consist of two components, the actual resistance and the apparent resistance present in the opposition offered to the flow of current termed the *reactance* (q.v.) by a circuit. For instance, the total current in the plate circuit of a vacuum tube responding to high *frequency grid voltages* may be considered as made up of two components, viz., a steady or constant current and a high frequency component superimposed on it.

**COMPRESSED AIR CONDENSER**—A condenser which uses compressed air as the *dielectric* or insulating material between the plates. This type of condenser is used chiefly in transmitting circuits. (See *Condenser*.)

**COMPOUND MAGNETS**—A combination of several permanent magnets. (See *Magnets, Compound.*)

**COMPOUND WOUND**—A dynamo or motor field magnet wound with two field windings, one of which is connected in series, the other in parallel with the armature (q.v.).

**CONDENSER**—In electricity or radio practice a condenser consists of two or more conducting surfaces placed in relation to each other and separated by an insulating medium such as air, impregnated paper, mica, etc. The conducting surfaces are generally referred to as plates or electrodes (q.v.) and the insulating material is known as the dielectric (q.v.). Condensers are used in radio for a variety of purposes, their broad use being to allow tuning. In action, a condenser permits charges of electricity known as electrostatic charges (q.v.) to be stored up and released periodically, according to the frequency desired. They may also be used to exclude certain types of energy. (See *Condenser, By Pass, also Filter.*) The action of a condenser may be compared to that of a spring when placed under a mechanical strain. In the illustration Fig. 1A a flat spring S is shown in a normal position, NB. In 1B a weight W is placed on the surface of the spring. This weight will force the spring down from its normal position to one of the positions (a), (b), (c) or (d), according to the force exerted and the strength of the spring. If a heavier weight is then placed on the spring it will depress still further until we can imagine a point P in Fig. 1C at which the elasticity of the spring is used up and the opposition is such that it will no longer depress and comes to rest. When the weight is removed the spring will fly back into normal position, Fig. 1D, and in doing so will vibrate back and forth a number of times, thus producing, or rather, returning the energy that was stored in it during the moment of stress.

Considered as analogous to a condenser, in the above case the weight can be likened to the electrical charge applied to the condenser, the resistance of the spring may be considered somewhat similar to the capacity of the

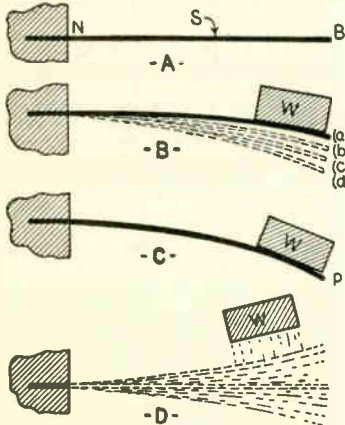

Spring analogy of a condenser.

condenser, or the power returned on release of the spring may be regarded as the electrical power released by the condenser when the charging force is removed. The capacity of the condenser then will be seen as the ability to store up energy placed in it.

In the case of the spring, if too great a force is exerted, it may break down or as would actually happen, the elasticity would be lost. The same applies in the case of a condenser. If the charging force is too great, it may exceed the dielectric strength of the condenser and result in puncturing the insulating material between the plates. (See *Breaking Down of Dielectric.*) The energy obtainable from a charged condenser will be equal to the charge placed in it providing there is no leakage or other loss. In a well-designed condenser the leakage will be so negligible that it need not be taken into consideration.

The relation between the charge in a condenser, the voltage applied and the capacity of the condenser is expressed as  $Q = C \times E$ , where Q is the quantity of the charge in coulombs, E the potential in volts and C the capacity in farads. (See *Capacity, Condenser, Variable; Condenser Fixed; Condenser Transmitting, also Condenser Curves.*)

**CONDENSER, AIR**—See *Air Condenser.*

**CONDENSER, ANTENNA**—See *Aerial Tuning Condenser.*

**CONDENSER, BY-PASS**—A condenser, usually of the fixed (q.v.) type arranged in a circuit in such manner that currents of a certain frequency will pass freely around any obstruct-

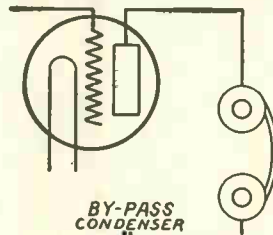

By-pass condenser across "B" battery.

ing object, as, for instance, a high resistance element necessary to the circuit. An example of the use of a condenser in this manner is shown in the case of a "B" battery where the battery has a high internal resistance. A fixed condenser is placed across the terminals of the battery without injury to it and offers a path of low resistance for the high frequency radio currents.

**CONDENSER CURVES**—Curves showing the relation of variations in wavelength, frequency, and capacity with

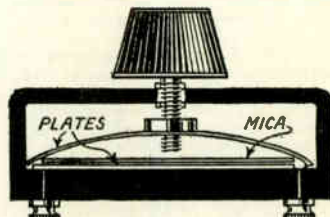

Fig. 1. Compression type condenser.

rotation of the dial of a variable condenser. Three types of condensers are shown here, the *compression*, Fig. 1, the *straight line capacity*, Fig. 2, and

the *square law*, Fig. 3. In Fig. 1A is shown the relation of capacity and wavelength changes when the dial of a sample compression condenser was rotated. The condenser was shunted

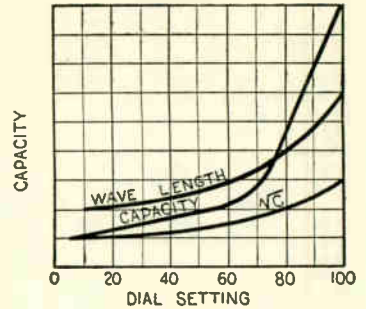

Fig. 1A. Curve for compression type condenser.

across a fixed coil. It will appear that the increase in capacity is gradual at the lower part of the range but increases very rapidly at the upper

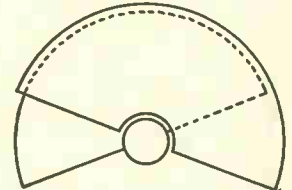

Fig. 2. Straight line condenser.

ranges. This is due mainly to the relation of the curvature of the upper plate to the lower plate as will be seen from the illustration, Fig. 1. These

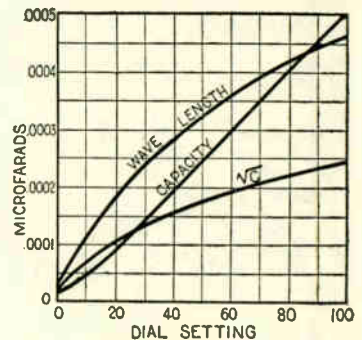

Fig. 2A. Curve for straight line condenser.

condensers are very satisfactory on about the lower two-thirds of their range, but through the remainder of their range a very slight adjustment of the knob causes an extremely large change in capacity, making them very difficult to handle near their maximum capacity. Fig. 2 shows the shape of the variable plates in the straight line capacity condenser and Fig. 2A illustrates the relation of wave-length and capacity changes with rotation of the dial. Here the capacity depends upon the overlapping area and is therefore proportional to the angle of rotation of the movable plates. The capacity curve appears as a practically straight line running diagonally across the chart. The wave-length, however, changes rapidly at the lower range and very gradually at the upper range as indicated by the wave-length curve. Fig.

3 shows the shape and disposition of rotor and stator plates of a condenser so designed as to read directly in wave-length from the settings of the dial.

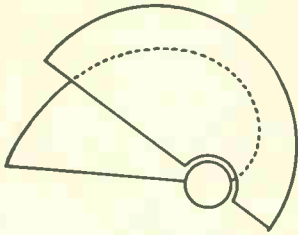

Fig. 3. Square law condenser.

This is known as a square law condenser, and the relational curves are shown in Fig. 3A. Here we find the wave-length curve a straight line and

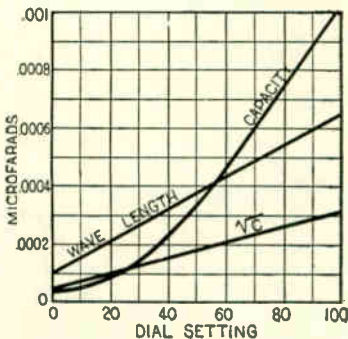

Fig. 3A. Curve for square law condenser.

directly proportional to the angle through which the dial is turned. The line indicating the square root of the capacity VC is a straight line, and as the wavelength is the product of the square root of the capacity multiplied by a constant (varying with the individual condenser) the wavelength curve must also be a straight line.

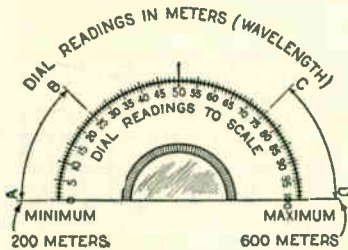
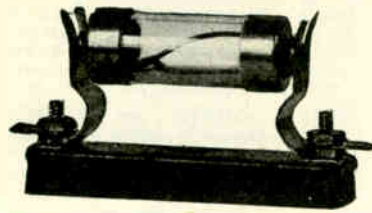

Fig. 3B. Showing effect of straight line condenser on dial reading.

Such condensers are much used in wave meters (q.v.). Condensers are also made so that the frequency curve is a nearly straight line, varying more or less directly as the angle of rotation of the plates. Fig. 3B illustrates the result when an ordinary straight line capacity condenser is arranged with a dial calibrated directly in meters. It appears that the readings are bunched at the lower range (A to B) and spread out at the upper ranges (C to D). The reason for this can readily be seen by glancing at the curve Fig. 2A.

**CONDENSER, FIXED**—A condenser which has a fixed or constant capacity, allowing no variation of the value. (See *Condenser*, also *Condenser, By-Pass*.)

**CONDENSER, GRID**—A condenser, generally of low capacity, of the fixed or variable type, used in series with the grid of the detector tube to prevent excessive charges from affecting the grid. These condensers generally have a capacity between .00025 and .0005



Grid leak and condenser.

micro farads. Due to the blocking action of these condensers, a high resistance, known as a *grid leak* (q.v.) is placed across the condenser or from the grid to filament, thus allowing the accumulated charges to leak off the grid of the tube in time for the grid to be free for the succeeding electric charge. The grid leak may be considered as a valve controlling the amount of energy that the detector can efficiently take care of without overload. (See *Grid Leak*.)

**CONDENSER, IN PARALLEL**—A condenser arranged in a circuit in such manner that the current is divided between it and the other condenser or coil with which it is connected. The

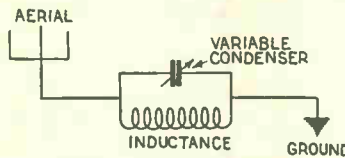

Coil and condenser in parallel.

illustration shows a *variable condenser* connected in parallel with a coil, both placed in series between aerial and ground and forming a tuned primary or aerial circuit. (See *Parallel Connections*.)

**CONDENSER, IN SERIES**—A condenser connected in a circuit with other condensers or coils in such manner as to form a continuous path, allowing the current to pass through each unit with-

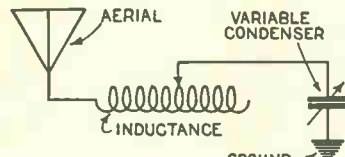

Coil and condenser in series.

out dividing. The illustration shows a condenser connected in series with a *tuning coil*, aerial and ground, thus forming a tuned primary or aerial circuit. (See *Condenser, in Parallel*, also *Series Connections*.)

**CONDENSER, MICA**—A condenser, usually of the fixed type, employing sheets of mica as the dielectric or insulating material between the plates. The condensers of small capacity used in receiving circuits are generally made with mica as a dielectric, but owing to its cost and thickness it is seldom used in low-power, high-capacity condensers. Mica is also used in con-

densers for high-power work such as transmitting, when the capacity is low. (See *Condenser*.)

**CONDENSER, PHONE**—A fixed condenser of comparatively low capacity used across the *telephone receivers* to allow a by-pass for a certain portion of the currents and thus prevent undue strain on the phones. (See *Condenser, By-Pass*.)

**CONDENSER, TRANSMITTING**—See *Condenser, Mica*.

**CONDENSER, VARIABLE**—Any condenser so arranged as to allow variation of its capacity. This may be accomplished in many ways, the usual method being to have the plates divided so that one series is movable with respect to the others, the capacity changing with the rotation of the variable plates. (See *Condenser*.)

**CONDUCTANCE**—Sometimes called the conductivity. The quality of a given conductor in virtue of which it facilitates the flow of an electric current. A *conductor* (q.v.) is a body having large *conductance* and an *insulator* (q.v.) is one having negligible conductance. *Conductance* is thus the opposite of *resistance*. The unit of conductance is the *mho*, the reciprocal of *ohm*. The symbol is obviously derived from *ohm*, reversed. It is the conductance of a column of mercury 106.3 cm. (centimeters) long, 1 square mm. (millimeter) in cross-sectional area and of a weight of 14.4521 grams.

**CONDUCTIVE COUPLING**—The association of one circuit with another by means of inductances (coils) mutual to both circuits.

**CONDUCTIVITY, SPECIFIC**—The reciprocal of *Specific Resistance*; being a standard of reference for comparing the conductances of different substances. (See *Specific Resistance, Conductance*.)

**CONDUCTOR**—Any substance that offers small *resistance* to the passage of electric currents may be termed a *conductor*. This term is the opposite of *insulator*, but there is actually no line of demarcation between the two, since any insulator will permit the passage of current when sufficiently high voltages are used. For all practical purposes, however, a conductor is considered as material that presents little difficulty to the passage of current. The most common conductor is copper, usually in the form of wire. An idea of the relative conductivity (power of carrying electric current possessed by various substances, pure copper being taken as standard) of various substances can be gained from the table following. The materials on the left are comparatively good conductors given in the order of their conductivity, while those on the right are poor conductors and generally used for resistances. (Note: A *resistance* is used to retard the flow of electricity without necessarily stopping it entirely, whereas an *insulator* is used to stop the passage of current.)

Silver	German Silver
Copper	Platinum Silver
Brass	Manganin
Gold	Mercury
Aluminum	Graphite or carbon
Zinc	
Platinum	
Iron	
Nickel	
Tin	

There are, of course, many other substances that can be classed as good conductors, or as poor conductors, but

the above are more generally known and used. It is a peculiar fact that while good conductors become less conductive as their temperature is raised, insulators lose a certain amount of their insulating properties as their temperature is raised. As too great current in a conductor will cause heat, and as explained above, cause lessening of conducting ability, it will be obvious that for the fullest efficiency a conductor will necessarily be arranged to carry the required current without undue heating. It is understood also that conductors in any part of a radio circuit should be carefully gauged as to size and the effective cross-section of the conductor determined, in order to offset the losses due to heating. It must not be assumed from the foregoing that the larger the wire the greater the efficiency—in fact a large wire is often less satisfactory than a small one in high frequency circuits.

When the conductor is to carry direct current the only consideration is to have the wire large enough to prevent heat losses and at the same time not be too bulky. Where the conductor is to carry high-frequency (q.v.) currents there are other factors to consider. High frequency currents are said to travel only on the outside of the wire (see *Skin Effect*) and therefore it is possible to use very fine wire for this purpose when the very low current values obtaining in reception are in question. A phenomenon that must be given attention, however, is that of *distributed capacity* (q.v.). (For more complete explanation of this subject see *Low-loss Coils*. See also *Bus bar*.)

**CONNECTING UP OR HOOKING UP**—These general terms are used in radio to refer to the process of wiring a receiver or any particular part of a receiver or other circuit.

**CONSTANT**—A quantity or magnitude, which does not vary, derived from actual experiment, which is included as a factor in most formulas for the purpose of bringing theoretical calculations into agreement with experience. Constants are much used in radio calculations. As an illustration, different dielectric or insulating materials used in a condenser have different constants which must be taken into consideration when calculating the capacity of the condenser. Thus, as a dielectric, air at ordinary pressure is taken as the standard, the constant being stated as 1. Flint glass has a high dielectric value, its constant being stated as 10.10, other materials varying according to their comparison with air as a standard. (See *Dielectric*.)

**CONSTANT CURRENT**—An unvarying current. The term "constant" is applied to voltage when it is steady and unchanging, to resistance when it is fixed and unvarying, or to almost any value that does not change.

**CONSUMPTION, CURRENT**—The term usually employed to denote the current required or consumed by any part of an electrical circuit or by the circuit itself. A resistance in a circuit consumes a certain amount of energy because it dissipates it as heat energy. A filament in the case of a vacuum tube, requires a certain amount of current to heat it to brilliancy. If the filament thus requires one-quarter of an ampere we say its current consumption is one-quarter ampere. (See *Plate Consumption*.)

**CONSUMPTION, PLATE**—The current required to energize the plate of a vacuum tube. (See *Plate Consumption*.)

**CONTACT BREAKER**—A contrivance for quickly and automatically making or breaking an electrical circuit normally existing between two contacts. (See *Circuit Breaker*.)

**CONTACT DETECTOR**—A form of crystal detector in which a small wire, or "catwhisker," as it is called, makes contact with the crystal in the detector and acts as a rectifier of the high frequency waves received from the broadcasting station. (See *Crystal Detector*—*Theory of Operation*.)

**CONTACT POINTS, or SWITCH POINTS**—Generally refers to a small flat-headed machine screw used as a contact point for a switch. The illustration shows the types mostly used.

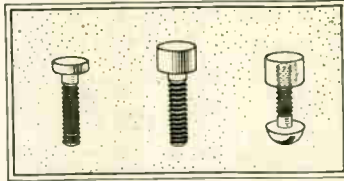

Various contact points.

Leads from various points of a tapped coil may be connected to the several contacts in order to permit variation of the inductance. A "contact point" may also mean any point in an electrical circuit at which contact is made to close the circuit.

**CONTACT RECTIFIER**—See *Contact Detector*.

**CONTACT RESISTANCE**—When two connecting surfaces in a circuit carrying electrical energy do not make absolute or perfect contact, a certain amount of resistance (q.v.) results. In any part of a radio circuit where two wires or conductors are joined to form a circuit, it is essential that they make a positive contact. The wires used for connections in a radio receiver are generally soldered or fastened tightly by nuts or bolts, or machine screws in order to form a good contact. If this is not done, energy may be wasted, due to the resistance at the point of contact.

**CONTINUOUS OSCILLATIONS**—Each oscillation or vibration being of the same amplitude as the preceding one. (See *Sine wave*.)

**C. W.**—Abbreviation for continuous wave (q.v.).

**CONTINUOUS DIRECT CURRENT**—A direct current which flows steadily without interruption or reversal. The current supplied from a battery for radio use is continuous direct current, while that portion of the high frequency alternating current which is rectified by a vacuum tube detector is called pulsating direct current, as there is an interval of time between the rectified half of each incoming wave, due to the other half not being rectified. (See *Current, Pulsating Direct, Pulsating Current*, also *Rectification*.)

**CONTINUOUS WAVES**—Also called *Undamped or Sustained waves* and usually referred to as *C. W. Electromagnetic waves*, the separate oscillations (each vibration) of which are of constant or unvarying amplitude. In Fig. A a series of oscillations (q.v.) are shown. It will appear that one oscillation or cycle is of the same amplitude as the preceding one—the amplitude (q.v.) being considered as the

height of the wave above the straight line representing time or its depth below that line. Each loop above the line or below it represents an alteration (q.v.) (the increase in current to maximum and back to minimum in either direction)—the loops above the line being considered as *positive alternations* and those below the line as *negative alternations*. Now it is evident from the sketch that each succeeding alternation has the same strength (amplitude) as that preceding it, and the same is true of the complete cycle, consisting of one alternation in each direction. Thus the waves are continu-

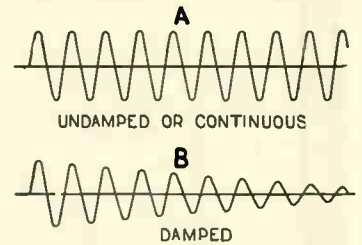

Series of undamped and damped waves.

ous, or constant, as far as amplitude is concerned. Now in Fig. B the amplitude is not constant—it decreases with each succeeding alternation and hence with each succeeding cycle (two alternations). After a comparatively few oscillations the current has decreased to zero, that is, the oscillations have died out completely. In this case the percentage of decrease in amplitude from one cycle to another is known as *decrement or damping*. Thus continuous waves may be considered as waves in which, with any train or group of oscillations, each succeeding oscillation has the same amplitude as that preceding it.

**CONTINUOUS WAVES—KEY MODULATED**—Continuous waves (q.v.) which have been broken into dots and dashes of the telegraphic code by means of a telegraphic key, these signals being made audible at the receiving end by the use of an oscillating receiver.

**CONTINUOUS WAVES—MODULATED AT AUDIO FREQUENCY**—The process of variation of the frequency (vibration) of waves radiated by a broadcasting station in accordance with the sound waves is known as modulation. Frequencies from 10,000 down to about 32 are audible to the human ear and are known as audio frequencies. Hence continuous waves which are modulated at audio frequencies are waves which have been modulated (varied) by having the voice or music impressed on the microphone at the broadcasting station, which in turn causes the strength of the radiated electric wave to vary so as to correspond electrically to the sound vibrations at the microphone.

**CONTINUOUS WAVE SIGNALS**—See *Continuous Waves*.

**CONTINUOUS WAVE TRANSMISSION**—System of radio telegraphy using waves as described under "Continuous Waves."

**CONVECTION CURRENTS**—When a hot and a cold body are separated by a fluid which is free to circulate, heat is transferred from the hot to the cold body by currents of the fluid itself flowing from one to the other; similarly, all parts of a fluid which is being heated quickly come to approximately



the same temperature. This transfer of heat by currents of the fluid itself is called "convection." In electricity "Convection Currents" are currents arising from the motion of charged particles thrown off in electrified streams, i.e., the flowing of charged air particles in streams from the pointed end of a highly electrified conductor, sometimes called "electric wind."

**CONVENTIONAL**—This term is much used in radio to denote a form established by custom. A conventional circuit for some particular purpose is understood as a circuit which has been generally used and which is generally considered as standard. Broadly, the most common form or use of anything. The conventional method of amplifying signals of audio frequency is by means of audio frequency transformers. Any other means is unconventional, although it may produce similar results.

**CONVERSION FACTORS**—A numerical factor which gives relation between the magnitude of a quantity expressed in terms of one system of units, and the same quantity expressed in terms of any other system of units. For example, the yard is regarded in the United States as 3600/3937 meter (a meter is approximately 39.37 inches). We say, therefore, that the conversion factor between the yard and the meter is 3600/3937 because any number of yards multiplied by this figure or factor will give the result in meters. (See *Capacity Conversion Factors*.)

**CONVERTER**—A term applied generally to any mechanical, electrical or electro-chemical device which will convert or change one form of energy to another. More specifically in electricity the term is used in reference to (1) a dynamotor designed with two armatures, mounted on one shaft, one being a motor armature driven by the original current, the other armature generates new current; this is also called a "motor-dynamo" and it can transform continuous (direct) current to higher or lower voltages, or, (2) a rotary electrical device used to change direct to alternating current or vice versa. (See *Rotary Converter*.)

**COORDINATES**—A thing of the same rank with another thing may be termed a coordinate. For example, lines by means of which the position of any point as of a curve may be defined with respect to certain fixed lines. In the illustration Fig. 1 lines known as axes

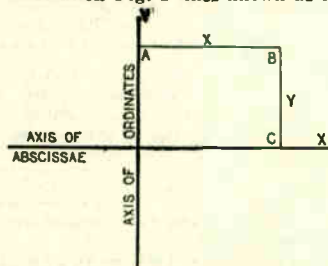

Fig. 1. Axis of coordinates.

of coordinates are shown. Such a system as this will be the basis for curves (q.v.) showing the relation between varying values. If we assume the horizontal line X as the axis of abscissas, all distances measured parallel to this line will be known as abscissas; distances measured parallel to the vertical line Y being referred to as ordinates. The line A-B is parallel to the axis of abscissas X and is therefore an abscissa. The line B-C is parallel to the axis of

ordinates and is referred to as an ordinate. Now if we place a number of lines parallel to each axis (ordinates and abscissas) and assign to each of them a certain value, such as amperes, to each abscissa, and volts to each ordinate, a line can be drawn through a

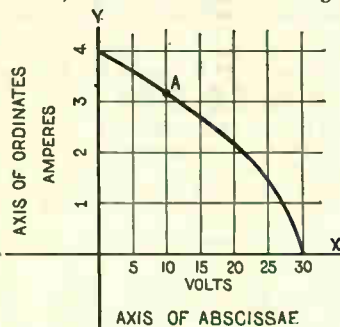

Fig. 2. Curve showing assumed value of current in amperes under assumed voltages.

number of points to represent the various values of each quantity as related to the other. Thus, in Fig. 2 we have a purely hypothetical curve representing the assumed value of current in amperes under assumed voltages. In the example, the curve at point A shows approximately three amperes under a pressure of ten volts. This imaginary curve is, of course, shown merely for the purpose of illustrating the meaning of coordinates, ordinates, abscissa, etc. (See *Abcissa, Characteristic curve, also Graph*.)

**COPPER PYRITES**—Sometimes referred to as *Chalcopyrite*. It is used in radio reception as one of the elements of a crystal rectifier (detector) generally in conjunction with zincite or tellurium.

**COPPER SULPHATE**—A salt of copper. Also known as blue vitriol or copperas. A copper sulphate solution is sometimes used as a preservative for wooden aerial masts. It is used in certain forms of primary cells (devices for transforming chemical action into electric current) and also produces sulphuric acid when subjected to electrolysis (q.v.).

**CORD, PHONE**—The cord or flexible wire used to connect a headset (phone) or loudspeaker to the terminals of a receiver. Phone cord is usually copper tinsel wrapped around a cotton cord, the whole covered by braided silk or cotton threads. It cannot be used to carry high currents, but is efficient for the comparatively low currents flowing through the phone circuit of a radio receiver. Some phone cords are also formed of a number of fine copper wires covered with a suitable insulating material.

**CORE**—The central portion of a piece of certain electrical apparatus. Thus the center of a coil will be the core, irrespective of its nature, whether air or iron. The core of a choke coil (q.v.) is usually made of a bundle of soft iron wires or strips of iron. The core of the closed type is called a laminated core, being made up of laminations or layers of the core metal. (See *Choke or Choking Transformer, Closed Core*.)

**CORE LOSSES**—The losses due to the stray currents (q.v.) set up in an iron core while under the stress (strain) of a magnetic field (q.v.). Also losses due to hysteresis and eddy-currents. (See *Magnetic flux, Eddy current, also Hysteresis*.)

**CORE TRANSFORMER (Iron)**—A transformer having the wire wound over an iron core, the iron forming a path for the magnetic lines of force, as distinguished from a transformer in which there is no iron core—called air core. (See *Transformer*.)

**CORONA**—The Latin word meaning crown, originally applied to the crown shaped lights occurring in the aurora borealis. In electrical parlance it refers to the luminous discharge which occurs along high tension transmission lines or the aerial wires of a high power radio transmitting station. (See *Brush Discharge; also Corona Loss*.)

**CORONA LOSS**—The energy loss due to corona discharge. (See *Corona; also Brush Discharge*.)

**CORRECTION FACTORS**—A formula for the measurement of certain values is generally made by using certain conditions or types of apparatus as a standard. For example a formula for calculating the inductance of a coil is made by using a particular type and shape of coil as the standard. Therefore the formula will be essentially correct for this type of coil, assuming that its shape and other characteristics are the same. If, however, the nature of the coil to be tested differs from that of the standard coil in some way not covered by the formula, a system of correction must be used to adjust the formula to the particular case. Thus, the formula for inductance of coils takes into consideration the size of the wire or the number of turns, the length of the coil, its diameter and so on. However, it does not take into consideration the ratio between the length of the coil and its diameter. For this purpose a correction factor (necessary consideration) is needed to correct the result of the formula to fit the individual occasion. This correction factor is generally referred to as a constant (q.v.), its value being determined generally from a chart prepared to cover various ratios of length to diameter.

**CORROSION**—Chemical action which causes destruction of the surface of a metal. In the case of iron it is generally rust, corrosion of copper being due to oxidation, or perhaps the action of stray currents causing electrolysis (q.v.). This effect is very often noted in the case of an aerial wire where the wire is necessarily exposed to the action of the atmosphere, rain, etc. The effect is particularly important and undesirable where the lead in wire is joined to the aerial.

If the two wires are not soldered securely or at all, corrosion may set in, which will produce in time a high resistance connection and waste the valuable energy of the incoming signals. This is the main point of danger in an aerial system and the best protection is to solder the joint carefully. As a matter of fact the remainder of the wire may corrode to a considerable extent without disastrous effect. In the case of copper, the wire very quickly corrodes when exposed. For this reason insulated wire is sometimes used for the aerial. As the current received by an aerial travels only on the outer surface of the wire (see *Skin Effect*), and a corroded surface is not a particularly efficient conductor, there seems to be some basis for the use of insulated wire for this purpose. Another instance of corrosion is in a soldered joint within a receiving set. All soldered joints should be carefully wiped to remove any trace of acid flux (q.v.), which may remain to produce a destroying

chemical effect on the wire and cause loss of energy. (See *Electrolysis*, also *High Resistance Joint*.)

**COULOMB**—The practical unit for electrical quantity. It is defined as the quantity of electricity delivered by a current of one *ampere* flowing for one second. Therefore a *coulomb* of electricity will pass each second in a circuit having one *ohm* of resistance and a pressure of one *volt*. It is also used to express the quantity of electricity which a condenser having one *farad* of capacity will absorb when placed under a pressure of one volt. (See *Capacity*, *Electro-static*, *Volt*, *Ampere Hour*, *Practical Units*, *CGS Units*.)

**COUNTER ELECTROMOTIVE FORCE**—Commonly known as *Counter E. M. F.* It is an opposing electromotive force which tends to resist or act against the original electromotive force. It may be introduced in a circuit to prevent any fluctuation of the original force. (See *Back Electromotive Force*, also *Choke Coil*.)

**COUNTERPOISE**—A *counterpoise* is generally a second aerial suspended either below the main aerial or to one side of it. It is used more often in transmitting stations in place of the usual ground connection, but is occasionally also used in reception where it is impossible to obtain an efficient ground. (See *Aerial*.)

**COUPLE, THERMO ELECTRIC**—See *Thermo-Couple*.

**COUPLED CIRCUITS**—The term generally used to refer to circuits that are joined by *coupling*. (q.v.) In the illustration the *primary circuit* (the aerial ground and tuning devices) is

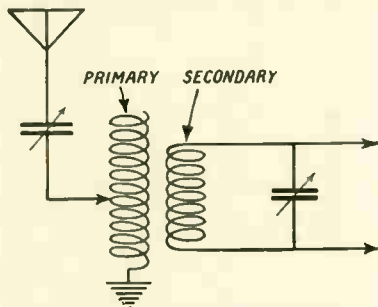

Circuit in which primary and secondary are joined by inductive coupling.

coupled or joined to the *secondary circuit* by *inductive coupling*. That is to say, the signals impressed on the *primary circuit* are transferred to the *secondary circuit* by means of *inductive coupling*; when the lines of magnetic force around the primary coil cut the secondary coil, a voltage is set up in this coil which causes a current to flow in the secondary circuit, and it is then said the coils are "inductively coupled", there being no connecting wires between them. Signals might be transferred to the secondary circuit by any of several means, but in each case the method of joining the two for the purpose of effecting a transfer of energy is referred to as "coupling the circuits." (See *Coupling*.)

**COUPLER**—See "Coupler—(Loose)" and "Coupler—(Vario)".

**COUPLER—(LOOSE)**—A tuner used in a radio receiver, consisting of a primary and secondary coil so constructed that the secondary coil slides on rods in and out of the primary coil. When

the secondary is entirely within the primary the coupling is said to be "tight," and as the secondary is withdrawn from the primary the coupling becomes "loose," depending upon the distance which the coils are separated.

**COUPLER—(VARIO)**—Form of tuner used in a radio receiver, having primary and secondary coils arranged in such a manner that the secondary rotates on a shaft within the primary. The degree of coupling is governed by the variation of the angle between the axes of the two coils.

**COUPLING**—The relation of one coil of wire carrying alternating currents to another in which energy is set up by the first coil. It is used to define the intimacy between the primary and secondary windings of various types of *oscillation transformers*, *couplers* and *tuning devices*. This transfer of energy may be produced in several ways, as by *inductive coupling*, *conductive coupling* or *electro-static coupling*. The more common method is to place the primary and secondary coils in close proximity and produce the energy in the secondary through induc-

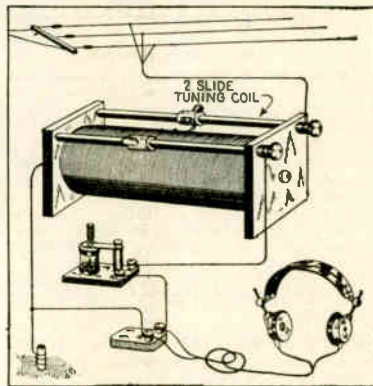

Fig. 1.—Two slide tuner divided into primary and secondary circuits by conductive coupling.

tion. The illustration Fig. 1 shows a simple two slide tuning coil which is divided into a primary and secondary by *conductive coupling*. Here the transfer of energy from the aerial and ground, or primary circuit, to the secondary circuit (detector and phones)

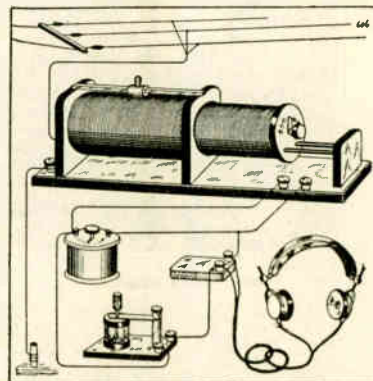

Fig. 2.—Circuit in which primary and secondary are inductively coupled by loose coupler.

is accomplished with little loss of energy as the circuit is through wire conductors. This is also known as *direct coupling*. Now in Fig. 2 a simple form of *loose-coupler* is shown. This device

is made in numerous forms, the principle of operation however, being the same in all cases. Here one coil, the secondary in this case, is made to fit into the larger coil which is the primary. The energy flowing in the primary coil induces or sets up a similar current in the secondary by reason of its proximity. The energy in the secondary, however, will not be as great as in the case of Fig. 1 where it is transferred directly through a wire conductor. The coupling shown in Fig. 2 will on the other hand, permit much closer adjustment to the desired signals.

The other method is known as *capacitive* or *electrostatic coupling*. This is shown in Fig. 3. Here the secondary coil is not in direct inductive relation to the primary, in fact it might well be almost any distance away were it not for the loss in efficiency due to long connections. The connection between the primary and secondary coils is by means of condensers. The transfer takes place through these and is determined by the setting of the condensers. It will appear that from a standpoint of maximum transfer of energy, the direct or *conductive coupling* system is best. The factor of tuning enters here however, and must be considered. In order to eliminate undesired signals the various systems of coupling are resorted to. It is known that *selectivity*—the ability to tune out undesired signals while receiving the desired signals—is often obtained only at the expense of a certain amount of energy or volume. It is a safe assumption therefore, that if there is any such thing as maximum efficiency in tuning apparatus, it must be a general term covering both selectivity and volume.

Coupling in its various forms is intended to refer not only to receiving circuits but to transmitting circuits as well. Its application in transmitting is covered under the heading *Spark transmission* (q.v.).

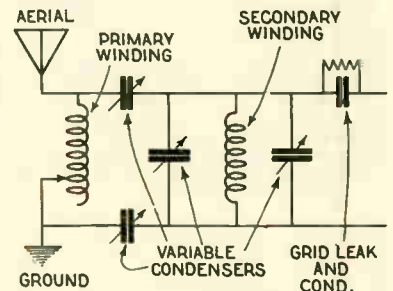

Fig. 3.—Electrostatic coupling between primary and secondary by means of variable condensers.

**COUPLING COEFFICIENT** — The closeness of coupling is specified by a quantity representing the ratio of the *mutual inductance* between two coils to the square root of the product of the two *self inductances*. In its practical sense coupling coefficient refers to the inductive relation of two coils. Coupling coefficient is defined as the ratio

$$\frac{X_m}{X_p X_s}$$

Where  $X_m$  is the mutual or common reactance  $X$  is the total inductive or capacitive reactance in the primary circuit and  $X_s$  the similar reactance in the secondary circuit. (See *Coupling*, *Mutual Inductance*.)

**COUPLING, DEGREE OF**—The extent of relationship between coupled circuits. In a great number of circuits the coupling is arranged so that it may be adjusted either close or loose, as the requirements of the reception may be. Variable coupling may be obtained either by varying the distance between the two coils of a *loose coupler*, or by changing the angle between the coils of a *variacoupler*. (See *Coupling*.)

**COUPLING TRANSFORMER—(OSCILLATION TRANSFORMER)**

—This is the "tuner" of the transmitting circuit. It consists of primary and secondary windings usually of flat strips of copper, or copper ribbon, instead of wire, in order to reduce losses due to *skin effect* (q.v.). The primary coil receives the energy in the form of alternating currents from the generating device; these currents set up lines of force which interlink with the windings of the secondary coil connected in series with the antenna system, and in this manner the energy of the oscillation (alternating) current is transferred to the radiating system (aerial and ground) and thence into space. The purpose of the oscillation transformer is to produce a sharp wave which is readily tuned at the receiving end and causes a minimum of interference. The greater the distance between the primary and secondary coils the more sharp the wave becomes.

A device serving the same purpose in a receiving set, i.e. to enable the receiver to separate sharply the received signals, is sometimes called a receiving transformer, although commonly known as a tuner, coupler, vario-coupler, etc.

**C. Q.**—Abbreviation of inquiry made in code by a radio telegraph station desiring to communicate with another station. (See *Abbreviations*.)

**C. Q. D.**—The original Distress Signal (q.v.) established in 1904 by the Marconi Company. The origin of this signal is said to have developed from the use by telegraphers on land lines sending the C. Q. call when they wished everyone on their circuit to listen to the message being transmitted.

The signal C. Q. D. is now obsolete, having been replaced by S. O. S. at the International Radio Telegraph Convention held at Berlin, Germany, in July, 1908.

**CRITICAL**—A term often used in reference to the tuning qualities of a radio set, and, less frequently, to indicate a *vacuum tube* that *oscillates* too freely. If a receiving set is not critical in adjustment it is said to tune broadly, that is to say, not sharp in tuning. A critical set has a very narrow margin of control in tuning—the particular signals being receivable within only a very few points on either side of their true wave setting on the tuning dials. If a set is difficult to tune it is termed "too critical". This means that it tunes too sharply and it is difficult to get proper results, due to the possibility of passing by signals unnoticed when turning the dials. Obviously there is a middle point wherein a set may be selective and yet not too difficult to tune. If a vacuum tube goes into *self-oscillation* (q.v.) too readily it is said to be critical. This effect is not desired in a tube except in rare instances. (See *Resonance*, *Tuning*, *Broad*, etc.)

**CRITICAL CURRENT**—The current required to bring about some particular effect in an electrical circuit. In radio use, a common example is the exact amount of current needed by the

filament of a vacuum tube to bring it close to the *oscillating point* (q.v.) without actually going into oscillation. (See *Critical*.)

**CRITICAL POINT OF CURVE**—The peak or point of maximum value in a curve showing the relation of any varying values. The illustration shows

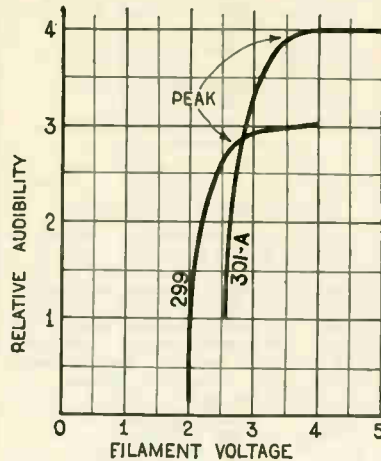

Illustration showing peaks or critical points of curve.

the curve indicating relation between voltage and signal strength in two types of vacuum tubes. The points marked "Peak" in each curve represent the critical points of the curves at which maximum audibility is obtained, any further increase in voltage not increasing the audibility. (See *Characteristic Curve*, also *Curve*.)

**CROOKES, SIR WILLIAM (1832-1919)**

—English chemist and physicist. Born in London June 17th, 1832, Crookes was educated at the Royal College of Chemistry and afterwards became as-



Sir William Crookes.

sistant in the meteorological department of the Radcliffe Observatory, Oxford. In 1855 he obtained a chemical post at Chester.

Crookes early began that series of brilliant researches which has left its mark on the scientific progress of the nineteenth century. In 1861 he isolated the new element *thallium*, during the investigation of the atomic weight of which he made the discovery of his *radiometer*. This led to his researches

on the phenomena of electric discharges through highly exhausted tubes, or *Crookes tubes*. The illustration shows such a tube. When a current is passed through it, cathode particles travel along it. His discoveries on these phenomena led directly to the development by Sir J. J. Thomson of the now generally accepted *electron theory*. (q.v.) In 1883 he began his study of the rare earths, and in 1892 he forecast Radio telegraphy on the strength of Lodge's and Hughes' experiments.

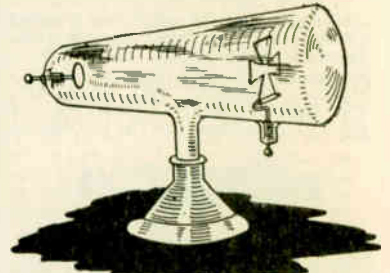

Crookes' tube.

Knighted in 1897, Crookes was awarded the Royal medal in 1875, the Davy medal in 1880, and the Copley medal of the Royal Society in 1904, and the O.M., in 1910. He died in London, April 4th, 1919.

**CRYSTAL**—A general radio term for a mineral used as a *detector* (q.v.) of radio signals. The Physicist F. Braun noted in 1874 that certain pairs of crystals when arranged so that only a small area of surface was in contact, offered high resistance to the passage of currents in one direction while permitting them to pass readily in the other. This was really the birth of the crystal detector, although radio was not then developed. There are a great many different minerals that will act as detectors for radio signals, some of which operate with a wire, or other metallic contact, others which require a combination of minerals, one in contact with the other. There are also numerous *synthetic crystals* such as *carborundum*. Then again some of the more common natural crystals are subjected to treatment by heat, or other means, to change their nature or to make them more sensitive.

The following crystals are most used in radio reception: *galena*, *silicon*, *molybdenum*, *carborundum*, *zincite*, *bornite*, *chalcopyrite*, and *cerusite*. All of these are taken up under their respective headings. (See *Crystal Detector*, also *Combination Detector*.)

**CRYSTAL DETECTOR**—A combination of a *crystal rectifier* with contact and supports, used to detect radio

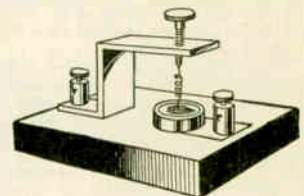

Fig. 1. Crystal detector using contact wire, or "cat-whisker."

*frequency oscillations*. Detectors of this nature are made in a great variety of styles, and use various kinds of crystals. In the more widespread form

## Crystal Detector, Theory of Operation

the crystal detector consists of a crystal with rectifying properties, held in a cup or spring grip and arranged with a contact wire as shown in the illustration Fig. 1. This may be

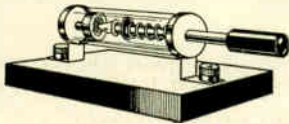

Fig. 2. Combination crystal detector.

elaborated upon by supplying a series of flat springs to obtain very fine adjustment of the contact. Fig. 2 shows a combination detector, using two crystals, in contact with each other. This form has several advantages over the wire or *cat-whisker* (as the contact



Fig. 3. Fixed crystal detector.

wire is called) type, chief among them the fact that it will withstand severe shocks without losing its adjustment. Fig. 3 illustrates a popular form of fixed crystal detector, in which the contact seldom requires adjustment. This type is of advantage providing it can be made sufficiently sensitive. (See *Carborundum, Vacuum Tube, also Crystal Receivers.*)

**CRYSTAL DETECTOR—THEORY OF OPERATION**—Theory of operation of a device used to detect radio waves, usually comprising a crystal in combination with a metallic contact, or, in some cases, two crystals arranged to rest against each other. In action this device serves to rectify the incoming signals, that is to say, it changes their nature from an alternating current to pulsating direct current. The incoming waves or signals consist of a series of alternations, the current flowing first in one direction, then reversing and flowing in the opposite direction along the circuit of the receiver. The changes of direction take place many times each second and would not be audible in the head phones in their original state. The crystal, as used in radio reception, has the peculiar property of furnishing a ready path for the flow of current in one direction while offering high resistance to its passage in the other. Now an *alternation* (q.v.) is a rise in current from minimum to maximum in one direction and back to minimum or zero, repeating the process in the other direction. Two of these alternations, one in a positive direction and the other in the negative direction constitute a *cycle*. (q.v.) If the crystal will permit the passage of current in one direction only, it is apparent that only half of each cycle can pass through; the other half of each cycle being lost or blocked out by the action of the crystal.

The illustration "A" gives a graphic representation of the *radio frequency oscillations* as they move over the aerial circuit. The curves above the line show the current in a positive direction while those below the line show it in the opposite or negative direction. If the signals or waves in this state were sent through a telephone receiver or head phone in a radio receiving set no sounds would be reproduced. Then again if the incoming oscillations were continuous, of unvarying strength, the rectified current would merely act on the diaphragm of

the phone and hold it in a certain position as long as the signal persisted. This of course would not create any audible or intelligible sounds. If, however, the incoming oscillations are in the forms of groups or trains of waves, in any one of which the successive oscillations were less than the previous

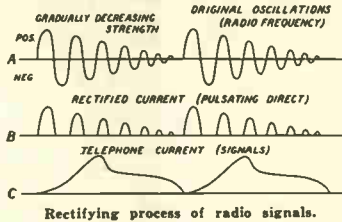

ones, the current would be rectified as shown in B and the result would be a series of pulses in the phone as indicated in C. These pulses would occur as often as the trains of oscillations occur (for more complete explanation of the difference between continuous and damped waves, see *Damped Waves, also Continuous Waves*). It will therefore appear that a *crystal detector* can only be used to receive *damped waves*. When the rectified portion of a damped wave train reaches the phones, the *diaphragm* is depressed and held until the train has died out, at which point the diaphragm is released until another train reaches it. This creates the audible signals and the number of trains occurring each second will determine the number of depressions of the diaphragm and hence the pitch of the audible signals. (See *Crystal Receiver, Crystal Detectors, also Tickler.*)

**CRYSTAL RECEIVERS**—A crystal receiver is the complete set of apparatus for receiving broadcast programs or *spark transmission* (signals), employing a crystal as the *detector* or *rectifier*. The set comprises a crystal detector, tuning device and phones, together with the usual aerial and ground ar-

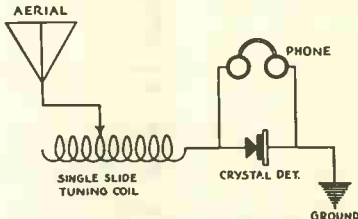

Fig. 1. Simple crystal set with single slide tuner.

angement. In its simplest form it may be merely a crystal detector, coil of wire and phones as in Fig. 1.

Fig. 2 shows a more efficient form, using a two slide tuning coil. This

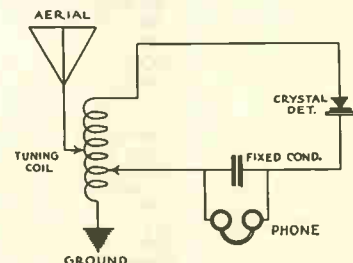

Fig. 2. Crystal receiver using double slide tuner.

method permits closer adjustment of the receiver to the particular signals desired. A still more efficient form is the *inductively coupled* type shown in Fig. 3. This method allows a very close adjustment and considerably reduces interference. The kind of detector to be used in any of the above types of receiver is immaterial as long as it is sufficiently sensitive. Such an

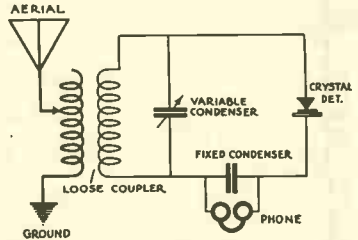

Fig. 3. Selective crystal receiver with loose coupler for tuning.

arrangement as shown in Fig. 3 is very inexpensive to construct and when used within ten to twenty miles of the broadcasting station gives excellent results. A very simple arrangement for

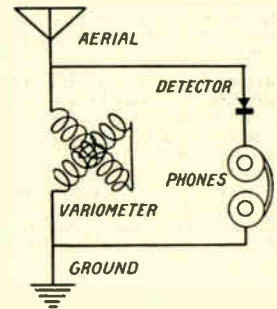

Fig. 4. A variometer is used as the tuning element in this crystal set.

use with a crystal detector is shown in Fig. 4. This circuit uses a standard *variometer* and eliminates the necessity for a *condenser*, thus having only one control in addition to the adjustment of the crystal.

**CRYSTAL RECTIFIER**—A device for changing an alternating current in a radio receiver into a pulsating direct current. This action is fully explained in "*Crystal Detectors (Theory of Operation)*."

**CURRENT**—A term used in electrical practise to signify the rate at which electricity flows from point to point in a circuit. The current in a circuit may be likened to the water flowing in a pipe. In this case the water would represent the electricity, the force or pressure represents the voltage, the pipe can be compared to the conductor or wire through which the electricity flows, and the current can be likened to the discharge from the pipe over a given period of time, that is the cubic feet of water per second. For practical purposes the unit of current is considered as the *Ampere*. This is the rate of flow of electricity when one *coulomb* (q.v.) passes a given point in the circuit each second. It will thus be apparent that while the ampere is often considered as the amount of current in a circuit, in reality it is the rate of flow of the electricity, the *coulomb* being the definite unit of quantity. Electric current is of course invisible. The only means of determin-

ing when there is current in a circuit is by observing its effect and it is always apparent by one or more of a number of effects. For example, if current is flowing in a wire or other conductor and a compass is placed near the conductor in such a position that the axis on which the needle revolves is parallel to the axis of the wire, the needle will be deflected. If the current reverses and flows in the opposite direction in the wire, the needle will be deflected in the opposite direction. The effect of current is also apparent by reason of the heat which it generates in passing through a wire conductor. If the wire is comparatively small and the current correspondingly large, the heat may be sufficient to be noticeable by placing the hand on the conductor. When the current is small, it can be detected by means of delicate instruments. This heating effect is made use of in various types of *ammeters*. The effect of current may also be noted in an incandescent lamp. In this case the current is made to flow through a fine wire inside a globe from which the air has been extracted, and the heat generated by the passing current causes the filament, or fine wire, to glow.

It is a well-known fact that heat causes expansion and this expansion of a fine wire is the principle on which one type of current measuring device operates.

Current is divided broadly into two divisions, *direct* and *alternating*. These two classes may again be separated into several further groups such as *high* and *low frequency alternating*, *continuous* and *pulsating*. Each phase or characteristic of current is taken up more in detail under its particular heading in this encyclopedia. (See *Current, Direction of Flow*, also *Current, Production of*.)

**CURRENT, ALTERNATING**—A current which does not flow steadily in one direction but changes its direction in the circuit periodically. (See *Alternating Current*.)

**CURRENT CARRYING CAPACITY OF WIRE**—The amount of current which a wire or other metallic conductor will carry without over-heating. Whenever current flows through a conductor, heat is generated. The amount of heat will be directly proportional to the resistance of the conductor and the square of the current in it. Now the resistance of a conductor depends on its cross-sectional area, length, and also its nature. It is therefore correct to state that the heating will depend on the amount of current flowing and the cross section and length of the wire. Obviously, a large wire will carry more current without over-heating, than will a small wire. Thus, it is necessary when choosing wire for a conductor to carry a certain amount of current, to select a wire of a cross section sufficient to carry the desired amount of current without undue heating.

The following formula for determining the current carrying capacity of various sizes and kinds of wire uses a certain factor T, which is the permissible rise in temperature above surrounding medium—such as air, earth or water. Where d is the diameter of the conductor in inches, T—the permissible temperature rise in degrees centigrade, N the resistance of conductor in ohms per mil-foot at final temperature, and I the current in amperes, then for solid conductors:

$$I = \frac{K \sqrt{Td^3}}{r} \text{ and for stranded conductors: } I = 0.85 K \sqrt{Td^3}$$

K is a *constant* (q.v.) depending upon the condition of the surface of the wire and upon the amount of heat convection due to air currents. Values of the constant K for air differ according to different authorities from 800 to 1000, the former referring to still air and the latter to open air.

Table of current carrying capacities follows:

Wires and Cables, Insulated: Carrying Capacities, in Amperes, allowed by The Regulations of The National Board of Fire Underwriters for Interior Copper Conductors.

(For Aluminum 84 Per Cent of These Currents is allowed.)

Single Conductor Cables or Each Conductor of Multiple Conductor Cables.

A. W. G.	Area in Circular Mills	Table A. Rubber Insulation	Table B Varnished cloth	Table C. other insulation
18	1,624	3	.....	5
16	2,583	6	.....	10
14	4,107	15	(18)	20
12	6,530	20	(25)	25
10	10,380	25	(30)	30
8	16,510	35	(40)	50
6	26,250	50	60	70
5	33,100	55	65	80
4	41,740	70	85	90
3	52,630	80	95	100
2	66,370	90	110	125
1	83,690	100	120	150
0	105,500	125	150	200
00	133,100	150	180	225
000	167,800	175	210	275
	200,000	200	240	300
0000	211,600	225	270	325
	250,000	250	300	350
	300,000	275	330	400
	400,000	325	390	500
	500,000	400	480	600
	600,000	450	540	680
	700,000	500	600	760
	800,000	550	660	840
	900,000	600	720	920
	1,000,000	650	780	1000
	1,100,000	690	830	1080
	1,200,000	730	880	1150
	1,300,000	770	920	1220
	1,400,000	810	970	1290
	1,500,000	850	1020	1360
	1,600,000	890	1070	1430
	1,700,000	930	1120	1490
	1,800,000	970	1160	1550
	1,900,000	1010	1210	1610
	2,000,000	1050	1260	1670

Varnished cloth smaller than No. 6 may be used by special permission only.

**CURRENT, CONVECTION**—See *Convection Current*.

**CURRENT, CRITICAL**—See *Critical Current*.

**CURRENT DENSITY**—The number of amperes passing through a wire conductor per square inch of area of the conductor. For example, if a conductor is a wire or bar of copper having a cross section of one square inch and ten amperes are passed through it, the current density will be ten amperes per square inch.

**CURRENT, DIRECT**—Current that flows steadily, and only in one direction. (See *Direct Current*.)

**CURRENT, DIRECTION OF FLOW (ASSUMED)**—In electrical practice the assumed direction of flow of current is often referred to. This refers to the fact that direct current is assumed to flow from the *positive* pole of a battery, or other source of electrical energy, to the *negative* pole and thence back through the battery from negative to positive. This assumed action is shown in the illustration Fig. 1, where the arrows indicate the assumed direction of flow. Now while the cur-

rent is stated as flowing from positive to negative outside the source, it is the generally accepted theory that the electron stream moves in the opposite direction, or from negative to positive. In other words, the current as we use

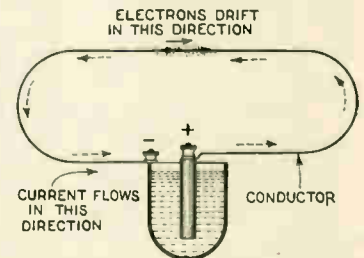

Fig. 2. Showing reverse action of current and electrons.

the term, flows backward along the path of electrons. (See *Electron Flow*.) This reverse action of current and electrons is shown by the illustration Fig. 2. This apparent anomaly

## Current, Eddy

can be likened to a salmon swimming up a rapid. The movement of electrons can be compared to that of the water in the rapids and while the fish actually swim against the stream, and the electric current flows against

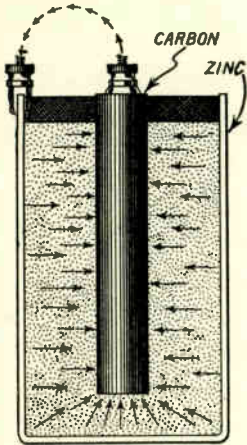

Fig. 1. Illustration showing the assumed direction of current flow in a dry battery.

the electron flow, the water and the electron stream nevertheless furnish the path of motion in each instance. The reason for the contradiction lies in the unfortunate arbitrary choice of positive and negative poles long before electrons were known. (See *Electron*.)

**CURRENT, EDDY**—See *Eddy Currents*.

**CURRENT, HIGH FREQUENCY**—A current that changes direction many times each second. In radio usage, currents having a frequency over ten thousand cycles per second are considered as *high frequency* or *radio frequency currents*. (See *Frequency*, *Radio Frequency* also *Low Frequency*.)

**CURRENT, HIGH TENSION**—Alternate term *High Pressure*. When the voltage, tension or pressure, in a circuit is comparatively low, the current is said to be a low pressure or *low tension current*. When the voltage is high, the current is said to be of high tension or pressure. Thus, as applied to radio usage, a dry cell or storage battery giving, respectively, one and a half and six volts for a certain type, are said to produce low tension or low pressure current. A "B" battery (q.v.) giving from 22½ to 45 volts (the usual value) furnishes *high tension* or *high pressure current*. While there is not a very great difference in voltage between a small "B" battery and an "A" type storage battery, the ratio of voltage to current in a "B" battery is far greater than in the ordinary case of the "A" battery and this must be taken into consideration. In general electrical practice the terms are not so arbitrary, and high tension currents might be taken as those above a pressure of several thousand volts.

**CURRENT, LOW FREQUENCY**—An alternating current that changes its direction of flow a comparatively few times per second. In commercial electrical work any frequency up to about 500 cycles per second is considered as low frequency current. In radio phraseology *audio frequency* (q.v.) currents are termed low frequency. For ordinary radio practice low frequency may be considered as any frequency below

about 10,000 cycles. (See *Oscillation* also *Oscillatory current*.)

**CURRENT, OSCILLATORY**—See *Oscillatory Current*.

**CURRENT, PRIMARY**—A current which flows directly from its source, such as a cell or generator. The current obtained from any source through a direct conductive circuit is termed a primary current. (See *Secondary Current*, also *Induced Current*.)

**CURRENT, NATURE OF ELECTRIC**

—As explained under the heading *Current*, electric current is manifest or understood by its effects. It may be apparent through the production of heat or light, by producing mechanical action such as required to operate a bell or move an electric motor, or, again, by producing chemical changes (See *Electrolysis*), and still further in its disastrous effects on the human body when the current has sufficient intensity. Without any actual or visible form of manifestation it can best be understood from the *electron* basis. It will be understood that an *electron* (q.v.) small as it is, contains a charge of electricity. When a sufficient number of electrons are in motion in a conductor (Note: current consists of electrons in motion) the current becomes large enough to be measured. As an instance of this fact a current of one ampere intensity (one coulomb per second) requires that about  $10^{19}$  electrons flow past a given point in the circuit each second. When the electrons are not progressing along a conductor, no current flows in the circuit. If no current is being carried by the conductor, the electrons may move about, but they do not progress along the conductor.

**CURRENT, PRODUCTION OF ELECTRIC**—An electric current is produced in a conductor by applying an *electro-motive force* (voltage) at points of the conductor or by maintaining a difference of *potential* (q.v.) between two points. In the first example we can assume a metal ring or closed coil of wire through which a magnet is pushed or perhaps in the core of which a magnet is being excited, or in the general sense any complete circuit through which the number of magnetic lines of force are being varied. In the second instance the difference of potential may be due to a *primary cell* (q.v.). Thus, the first case can be understood as referring to any mechanical means of producing current, such as *generators*. The other general method is by use of a *voltic cell*, that is, by chemical action. There are four important methods of producing an *electro-motive force*. The first is by friction, the apparatus used in this connection being termed a static machine; the second is by chemical action, as a primary or secondary cell; third, by mechanical motion, i.e., *dynamos* and *generators*, and fourth, by thermal action—known as a *thermo-junction* which is the wiring of two unlike metals in a conductivity circuit so that by heating one of the points of joining an electric current will be set up in the circuit. (See *Static Electricity*, *Generator*, *Thermo Couple*, also *Current* and *Electro-Motive Force*.)

**CURRENT, PULSATING DIRECT**—

When an alternating current is rectified by means of any device which permits current to pass only in one direction, the resultant current will move only in one direction, hence it is known as a *direct current* but unless both

negative and positive halves of the *cycle* (q.v.) are rectified or changed to direct current, the resultant current will appear as a series of pulses in one direction. The most common application of this is found in the case of a *crystal rectifier*, or *detector* as used for receiving radio signals or broadcasting.

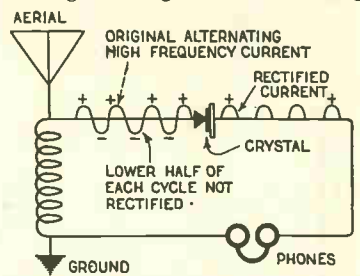

Diagram showing how crystal detector converts alternating high frequency current into pulsating direct current.

When the incoming waves, or high frequency *oscillations* (q.v.), are impressed on the detector, due to its peculiar properties they can only pass through it in one direction. In other words, granting that the incoming signal, or current, reverses its direction a great many times each second, it will be obvious that at any instant in the *cycle* (q.v.) current is moving in a certain definite direction, as from positive to negative, or vice versa, as stated, due to the peculiar properties of the detector the incoming signal current can only pass through the detector when the current is flowing in the correct direction. This means that only half of the *wave* (q.v.) is passed through and rectified. The result is a series of direct current surges through the balance of the circuit, each surge of current being followed by a space or time interval while the opposite half of the *cycle* or opposite *alternation* (q.v.) is blocked by the uni-directional nature of the crystal. These surges are then audible in the *head phones*, as they will actuate the *diaphragm* (q.v.) whereas a high frequency alternating current such as the original impulse from the broadcasting station would be inaudible. For a more complete explanation of this action see *Rectifying action of crystal detector*. (See also, *Rectifier*, *Full Wave Rectification* and *Rectifying Tube*.)

**CURRENT, SECONDARY**—A current produced by a *primary current* (q.v.) acting on a *secondary circuit* which does not receive its energy by direct connection with the primary source. The illustration shows both primary and secondary currents and the man-

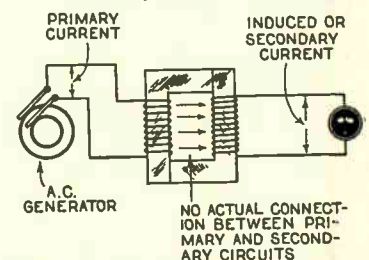

Illustration showing primary and secondary currents and method of production.

ner of production. It will be understood that the primary current in this case must be a varying current. (See *Induced Current*, also *Inductive Coupling*.)

**CURRENT, THEORY OF ELECTRIC**

—Under Electromotive force it will be explained that voltage or pressure is the result of a difference of potential (the power possessed by a charge of electricity for doing work) between two points in a conductor. Electric current will flow from the point of higher pressure or *voltage* to the point of lower pressure, the flow continuing as long as the difference is maintained. This action is the same as with water, which will always seek to move from a high point to a lower point. The flow of current is thus an effort to equalize the two *potentials*. (See *Current, Assumed Direction of Flow, also Pressure and Voltage.*)

**CURVE**—A straight or curved line showing the relation between various electrical phenomena or the characteristics (relation of changing values) of an electrical instrument. (See *Characteristic Curve, also Sine Wave.*)

**CURVE OF SINES**—A curved line representing the vibration of a body

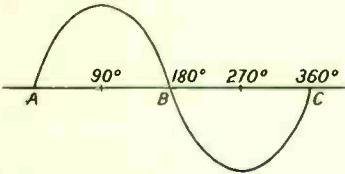

Sine curve.

that oscillates like a pendulum. The illustration shows a *curve of sines* which may be used to represent an alternating current. (See *Alternating Current, also Sine Wave and Simple Harmonic Vibration.*)

**CUT OUT**—An electrical device to interrupt the flow of current through any particular piece of apparatus or instrument, either automatically or by hand; a switch.

**CYCLE**—In electricity, a period of time during which certain changes take place in an *alternating current*, (q.v.) the same changes occurring again in each successive cycle. We can imagine an alternating current as travelling along a wire in the form of a wave, one half of the wave being in one direction and the other half being in the opposite direction. That is to say, the current flows from positive to negative for one half of the cycle and then in effect, flows from negative to positive the other half of the cycle.

**D**—The symbol of *electric displacement* (q.v.); also occasionally used as a symbol for diameter in electrical calculations.

**DAMPED OSCILLATIONS**—Electrical oscillations which die away, each succeeding oscillation in a group having lesser *amplitude* (q.v.) or strength than the preceding one. (See *Damped Waves.*)

**DAMPED WAVES**—Radio waves in the form of successive trains or groups, in each of which the amplitude or strength decreases with each successive wave. When electrical oscillations are caused by a single impulse, they do not continue indefinitely, but decrease in amplitude or die away. Thus, if oscillations are created in an antenna or other circuit by a discharge from a *condenser* (see spark discharge), each electric spark creates a train of oscillations which die away more or less

(It will be understood that actually current always flows in the same

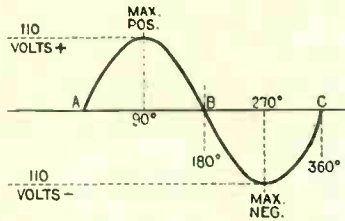

Curve showing action of 110 volts alternating current during one cycle.

direction, but the action of alternating current is due to a reversal of polarity at the source.) The difference between direct and alternating current is that, in the case of direct, the polarity always remains the same at the source and hence the direction of flow of the current is always in one direction, whereas with alternating current, the polarity changes twice each cycle due to changes at the source, and thus it flows in one direction for a certain fixed period, then reverses and flows in the opposite direction. In the illustration the current is shown as a *sine wave*. (q.v.) We assume that this represents an alternating current of 110 volts pressure such as in the average house lighting system. Now we consider the wave as a circle. The current flows in a positive direction toward its maximum value and at the 90 degrees it has reached the positive maximum. It then falls back to zero at 180 degrees and reverses, rising to maximum on the negative side, which it reaches at 270 degrees. It then falls back to zero at 360 degrees having completed a cycle or two alternations. The operation is repeated over and over a certain number of times each second. Thus, the rise and fall from A to B or 180 degrees is one *alternation*, the rise and fall from B to C is another alternation, the two alternations, one positive and one negative making a complete cycle. If sixty of these cycles occur each second we say that the frequency (q.v.) is sixty cycles. (See *Alternating Current, Phase, Sine Wave.*)

**CYMOMETER**—The name given a type of *wave-meter* designed by Dr. J. A. Fleming. It is used to measure the wave-length of oscillatory (vibrating) circuits. (See *Wave-Meter.*)

**D**

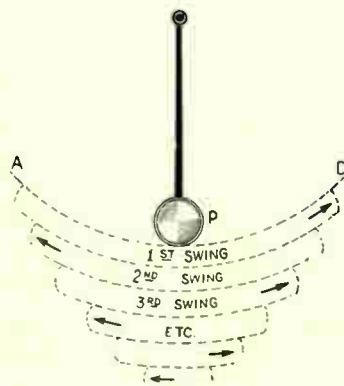

Fig. 1. Pendulum coming to rest after being given a momentary impulse.

**CYMOSCOPE**—A term used to designate any instrument which enables one to see the effect of electrical waves or to detect their presence. The original form was merely a loop of wire

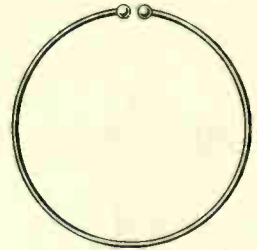

Fig. 1. Early type of cymoscope used to indicate resonance in a circuit.

not completely closed as shown in Fig. 1. When held close to a transmitter of short waves a small spark will pass between the ends of the loop providing the *wave-length* is properly adjusted. This was the form used by Hertz (the discoverer of electro-magnetic waves which form the basis of radio telegraphy and telephony) in his early experiments. The more modern form is shown in Fig. 2 where a small

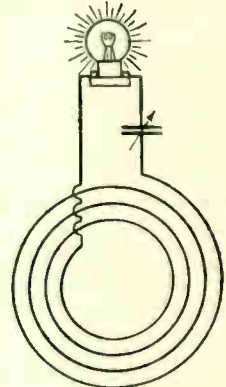

Fig. 2. More modern form of cymoscope.

lamp is made to light by holding the loop close to the transmitter. A complicated arrangement used to actually see the waves and study their form is called the *Oscillograph*. (See *Oscillograph, also Cathode Ray Tube.*)

gradually. Fig. 1 shows a pendulum which is given a momentary impulse. Now as this source of power is only momentary the pendulum will not

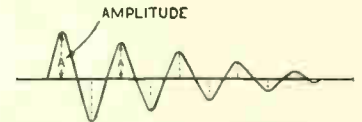

Fig. 2. Train of damped waves.

swing from A to D indefinitely. If the first swing under the impulse carries the pendulum the entire distance A to D, the next swing will cover a lesser arc and so on until the movement has died out altogether.

Now in Fig. 2, the graphic illustration of a train of *damped waves* shows that each crest is a little lower than the one preceding it and after a short period the waves have died out alto-

## Damping

gether. These curved lines may be considered as an illustration of the path taken by the pendulum in its motion as shown in Fig. 1. The decrease in amplitude of one crest over that preceding is known as the damping, and the neperian logarithm of the ratio of amplitude of any oscillation to the one preceding it is known as the *logarithmic decrement*.

If the impulse of force causing the oscillations is steady—not intermittent—the result will be a sustained series of oscillations that will continue at constant strength or amplitude until the exciting force is withdrawn. Thus, in the case of the pendulum, we can very easily keep exciting it by an evenly exerted force and so insure that the swings will continue without diminishing, as in the case of a momentary impulse. Oscillations or waves that have constant amplitude are known as *Continuous Waves, Undamped Waves or Sustained Waves*. (q.v.) (See also *Decrement, Logarithmic*; also *Naperian Base*.)

**DAMPING**—A progressive decrease in amplitude or strength. (See *Damped Waves, Damping in Instruments*.)

**DAMPING COILS**—*Short circuited* (q.v.) coils used in electrical apparatus for the purpose of causing damping (i. e., decrease in the intensity of electrical oscillations). The reaction of induced currents in the shorted coil creates the damping effect. (See *Damping*.)

**DAMPING DECREMENT**—See *Decrement, Logarithmic*.

**DAMPING FACTOR**—The product of the *logarithmic decrement* (q.v.) and the frequency (rate of alternation) of a damped alternating current. (See *Decrement, also Amplitude*.)

**DAMPING IN INSTRUMENTS**—The term damping is applied in a mechanical sense as in the case of the needle of a measuring instrument such as a *galvanometer*. (q.v.)

In a delicate instrument for measuring current the needle is controlled by the current through the instrument, and when this current is withdrawn the needle is brought back to the neutral position by a fine spring. Now, unless some precaution is taken the needle will have a tendency to swing or vibrate when measurement is being taken. Various devices are used to bring the needle quickly to rest without undue vibration. If the needle comes to rest almost immediately it is said to be a highly damped or *dead beat instrument*, because the oscillations or vibrations die out rapidly the same as in the case of damped waves.

There are two principal methods of damping instruments. When the instrument is of the moving coil type, the coil is generally wound on a light aluminum frame which is mounted between the poles of a permanent magnet. A soft iron core fills the gap between the two poles, allowing space for free movement of the coil. The result is that the metal frame carrying the coil moves through a very strong *magnetic field* and *Eddy currents* (q.v.) are set up in the frame and serve to damp its motion. The other common method is to have a light metallic vane carried by the pointer in its motion and moving in an air chamber to stop vibration. While damping is highly essential in a measuring instrument, too high a degree of damping is not advisable. If there is a very slight tendency on the part of the needle to vibrate, it permits the operator to de-

termine whether it is swinging freely. (See *Voltmeter, Wattmeter*.)

**DAMPING MEASUREMENT**—See *Decrement, Logarithmic*.

**DAMPING WAVES**—Term commonly used to denote the gradual decrease in amplitude of a train of oscillations as in radio transmission. If the oscillations persist at constant amplitude or strength, each oscillation being equal in amplitude to the one preceding, there is no damping. When the amplitude of each successive oscillation is less than that of the preceding one there is said to be damping and the oscillations will die out entirely, at a rate dependent on the degree of damping. If the oscillations die out very rapidly they are said to be highly damped; if they die out slowly the damping is said to be feeble.

**DANIELL'S CELL**—A two fluid *voltaic cell* containing a zinc plate immersed in dilute sulphuric acid, and a copper plate in a saturated solution of copper sulphate; the two solutions being separated by a porous cup. This cell has a constant voltage and shows only slight polarization. Was formerly much used in telegraph work.

**D'ARSONVAL GALVANOMETER**—A type of galvanometer in which a coil carrying the current to be measured is suspended in a *fixed magnetic field*. (See *Galvanometer*.)

**DASH**—The long stroke used in *Morse and Continental Code*. It is considered as equivalent in length to three dots. (See *Code*.)

**D. C. C.**—The customary abbreviation for double cotton covered wire.

**D. C.**—The abbreviation commonly used for *direct current*. (q.v.)

**"D" COIL**—Occasionally known as *Figure Eight coil*. A form of inductance, used particularly in tuned radio frequency circuits. The windings are in the shape of a figure eight, either in pancake form (flat wound) or wound on a slotted tube. Owing to the peculiar arrangement of the windings these coils have very little external field and thus can be used in radio frequency amplifiers without the usual oscillating due to conflicting fields. (See *Field, Inductance, Radio Frequency Coils*.)

**DEAD BEAT INSTRUMENT**—A measuring instrument arranged so that the needle comes quickly to rest with little or no vibration is said to be *dead beat* or highly damped. (See *Damping in Instruments*.)

**DEAD CELL**—A cell which has been discharged. (See *Cell*.)

**DEAD CRYSTAL**—A crystal used in a *crystal detector* (q.v.) that has lost its sensitivity. Very often a crystal becomes dirty or oily from contact with the fingers. In some cases they can be brought back to usefulness by cleaning with alcohol, or if the crystal is dead through causes other than dirt on its surface, it may be broken to present a new surface and thus find a new sensitive spot.

**DEAD END EFFECT**—The effect on a receiving circuit (oscillatory circuit) resulting from unused turns of wire in a coil. In the customary tuning coil or tapped coil a certain portion of the wire is not in use and this idle section, being in metallic connection with the main portion, but not actually in use, acts as a miniature oscillatory circuit. This tends to reduce the efficiency of the tuning unit as a whole. Dead end effect may be eliminated by using the entire coil at all times, doing the tuning solely by the variable condenser, or it may be reduced by the

use of a *dead end switch* (q.v.). (See *Tuning Coil*.)

**DEAD END SWITCH**—A switch used to cut out unwanted turns of wire in a coil in order to eliminate or reduce the *dead end effect* (q.v.). Such a switch is generally arranged so that

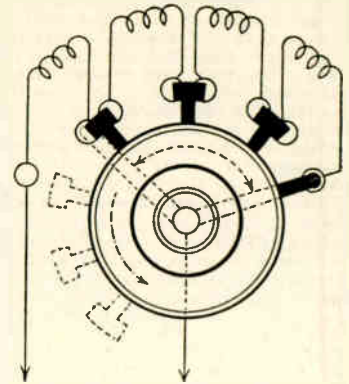

Dead end switch.

instead of taps being taken from various points on the coil, the winding is actually in sections and the switch blade connects into the circuit the desired number of sections.

**DEAD SPACE**—In the case of *beat heterodyne* reception if the two frequencies are brought together or the difference is very slight there will be no beat. This space where the two frequencies are identical, or very nearly so, is known as the *dead space*. (See *Beats, also Heterodyne*.) The beat resulting from the superposition of two waves differing in frequency is the difference or the sum of the two frequencies. For instance, if two waves are present in the same circuit, of 1,000 and 1,005 kilocycles respectively, the two beat frequencies will be 5 and 2,005 kilocycles. If, however, the two frequencies are made identical, the difference between the two will be zero, and the sum of the two will be twice the original frequency. In the one case, where we take the difference of the frequencies, the beat note is zero, or there is no beat note at all; in the other case, where we add the two frequencies, the resulting frequency is the *harmonic* (q.v.) of the original frequencies, which is the same as an octave in music. In the present instance, this note will not be heard at all as it is above the range of audibility.

**DECADENT WAVE**—A damped wave. A wave, or oscillation, in a train of *damped waves* (q.v.) which is of lesser amplitude or strength than the one preceding it. (See *Damped Waves, also Undamped Waves*.)

**DECAY OF CURRENT**—The gradual dying out of current in an *inductive circuit* (q.v.) after the *impressed potential* has been removed. The presence of inductance in a circuit causes the current to lag in time behind the voltage producing it. As a result, when a highly inductive circuit is broken by opening a switch or by other means, the current still tends to flow for a short interval, and the *induced voltage* in the circuit may become very high. This is the reason why a spark often occurs when the switch in a highly inductive circuit is opened. As a result the current decays gradually



after the impressed voltage is removed.

It will be noted that the *decrement* (q.v.) or the rate of decay of the oscillations directly affects the number of oscillations in the wave train that will be useful in transmitting signals. For instance, if a certain oscillation in the figure should represent the smallest voltage that will operate a detector, it is evident that all oscillations in the wave train that have smaller amplitudes will be useless. Consequently, the lower the decrement of the wave, the greater will be the number of oscillations before the amplitude becomes too small for useful purposes. This likewise means that a greater amount of the energy in the wave can be utilized.

**DECOHERER**—In the type of detector, now obsolete, known as the *coherer*, the incoming signals caused the particles of nickel and silver filings in the glass tube of the device to cohere or cling together. (See *Coherer*.) In order to place the coherer in its original state after each impulse, it was necessary to have some means of separating the particles. These were known as *decoherers* and were in many different forms, some as separate attachments, others as a part of the detector or coherer. (See *Detector*.)

**DECOMPOSITION, ELECTROLYTIC**—The decomposition of chemicals taking place in a cell due to the action of the electrolyte. (See *Cell*, also *Electrolytic*.)

**DECREMENT**—A term used to indicate the rate of decay or dying out of an electrical oscillation that is subject to *damping*. (q.v.) In the illustration is shown a series of damped waves. It will be noted that the distance from zero to the crest of wave (C-2) is less than the one preceding it (C-1). This distance represents the amplitude and the ratio of any amplitude to the one preceding it is constant, that is the decay or decrease in amplitude is constant. The *Naperian Logarithm* (q.v.) of the ratio of one wave to the one preceding it—is called the *logarithmic decrement*. The damping of a train of waves is an important consideration as it affects the tuning qualities to a great extent. This is covered by a U. S. Government Statute Concerning Transmitting Stations, decreeing that the logarithmic decrement per complete oscillation must not exceed 0.2, which

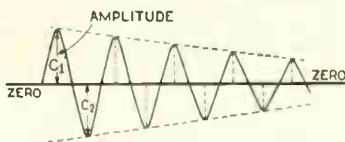

Damped waves gradually dying out.

means that for each single spark discharge from the transmitter there must be not less than 24 complete oscillations in the *antenna system*. (See *Oscillations*, *Damping*, *Naperian Logarithm*, *Sharp Wave*.)

**DECREMETER**—An instrument used to measure the *decrement* or degree of damping in an oscillatory current. Such meters are made in several different forms. Some types are direct reading in terms of the logarithmic decrement, while others require mathematical reduction from the readings of a dial. All decrementers operate on the basis of comparison of the resonance current in a tuned circuit with that in a circuit out of tune by a known or

unknown percentage. (See *Logarithmic Decrement*, also *Damping*.)

**DE FOREST, DR. LEE**—Electrical engineer; b. Council Bluffs, Ia., Aug. 26, 1873. Grad. Yale (Sheffield Scientific), Ph. B., 1896; Ph. D., 1899. Inventor De Forest system wireless telegraphy and founder Am. De Forest Wireless Telegraph Co.; system originally adopted largely by U. S. Govt.; demonstrated to the British, Danish, German,



Dr. Lee De Forest.

Russian and Indian Govts., first used by the U. S. Signal Corps in the war manoeuvres and inst. in Alaska. 1905 invented the Audion or three-electrode vacuum tube. 1906-09 was the pioneer

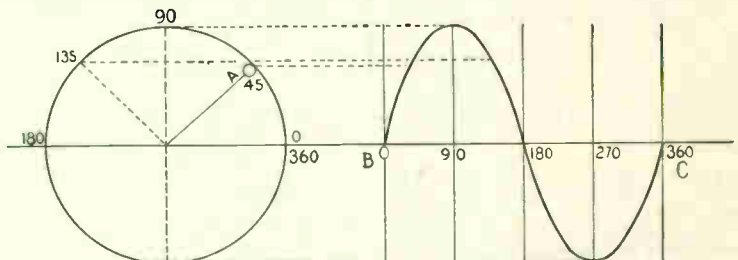

Curve representing current variation during one revolution of the armature of a generator.

in Radio Telephony. First to broadcast music and opera. 1908 equipped the 24 battleships and destroyers of Admiral Evans for their historic round-the-world cruise. 1913 incorporated De Forest Radio Tel. & Tel. Co., which developed the audion amplifier and oscillator for commercial purposes. These De Forest devices completely revolutionized the radio art and made possible the Bell Tel. Transcontinental System. He was the father of radio broadcasting and all radio broadcasting apparatus is built upon his audion inventions. Since 1919 he has devoted his attention to the phonofilm, photographing sound waves directly on motion picture film. Pres. of the De Forest Phonofilms, Inc.; Dir. of De Forest Phonofilms, Ltd., London. 1921, Awarded Cross of Legion of Honor by the French Govt. in appreciation rendered by audion to the Allies during the war. 1922 awarded Elliott Cresson

medal by Franklin Inst. 1922 awarded medal by Inst. of Radio Engineers. Fellow American Inst. of Elec. Engineers. Fellow Inst. of Radio Engineers. Mem. of N. Y. Elec. Society; mem. of Nat. Geog. Soc.

**DE FOREST COILS**—A type of coil named after *Lee De Forest* (q.v.). The wires are wound in a diamond shaped pattern in such manner that the turns of one layer cross the turns of the preceding layer at an angle, thus making the *distributed capacity* (q.v.) very small compared with the capacity of other types of coils. (See *Honeycomb Coils*.)

**DEGREES, ELECTRICAL**—In an alternating current curve each complete oscillation or cycle is shown as two loops, one above the line representing time, and the other below it, the entire cycle being considered as 360 *electrical degrees*. It is possible in this manner to show relations between current and voltage phases, amplitude at any point, etc. (See *Alternating Current*, also *Sine Wave*.)

The idea of electrical degrees comes originally from the *elementary electric generator*, with two slip-rings taking off the alternating current, and having only two poles. During one-half revolution of the armature turns, the current increases from zero to a maximum and then back to zero again. During the other half revolution the current increases in an opposite direction from a zero value to maximum and then back to zero again. The curve shown in the figure represents the current variation during the complete revolution, a cross-section of the rotating armature wire being shown at A. The angles indicated on the line BC are laid off to any convenient scale, and the intersection of the ordinates from these points with horizontals drawn from the circle as shown, give the points on the curve.

The same ideas hold when the generator has more than two poles: in this case a full 360 electrical degrees is taken to represent the armature motion from across two adjacent pairs of poles, so that a complete cycle of voltage or current is generated. In a four pole machine, therefore, a full revolution of the armature could be represented by  $2 \times 360$  or 720 electrical degrees. This corresponds to 2 complete cycles. Or, looking at it the other way, 360 electrical degrees would represent a half revolution of the armature wire.

**DEIONIZATION**—The action of returning a mass of gas that has become *ionized* (breaking up of the atoms of gas into positive and negative ions, being the elements to which and to whose motion, under the action of electric forces, is supposed to be due their electric conductivity) to its orig-

**Delta**

inal state. In the case of a spark gap (q.v.) the ionization creates a conductive path which remains after the actual spark has passed, thus preventing sharply defined oscillations. There are various methods of deionization, including cooling, absorption, air-blast or magnetic field, all tending to deionize or place the spark gap in its previous condition to prevent an arc from following the discharge. This action is also known as *quenching*. (See *Quenched Gap*.)

**DELTA**—The fourth letter in the Greek alphabet. The capital letter delta ( $\Delta$ ) is used as a symbol for delta connection of three phase alternating current generators or transformers. The small or lower case delta ( $\delta$ ) is used as a symbol for *Logarithmic decrement*. (See *Decrement*, also *Delta Connection*.)

**DELTA CONNECTION**— $\Delta$  In a three phase alternating current generator, where three coils are mounted symmetrically around a shaft rotating in a magnetic field, the connection or grouping of the windings is called

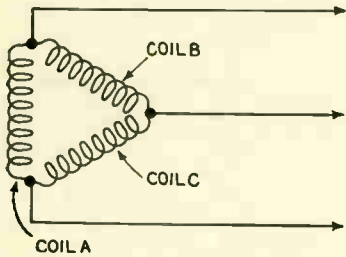

Delta grouping in a three phase system.

delta after the Greek letter which the grouping somewhat resembles. The illustration shows delta grouping in a three phase system. The sum of the instantaneous Electromotive Forces of the three coils is zero, or in other words the sum of the Electromotive Forces of any two coils is equal and opposite to that of the other coil, the line voltage thus being equal to the phase voltage. (See *Alternator*, *Polyphase*.)

**DEMAGNETIZATION**—The act of returning a body to an unmagnetized state or of reducing the degree of magnetization. In the case of phones used in radio reception the permanent magnets are often weakened or demagnetized by connecting them in the electron-tube circuits in the wrong way. (See *Magnetization*, also *Telephone Receiver*.)

**DENSITY, CURRENT**—See *Current Density*.

**DENSITY, FLUX**—See *Flux Density*.

**DENSITY OF ELECTROSTATIC CHARGE**—The electrostatic charge per unit area. (See *Electrostatic Charge*, also *Condenser*.)

**DEPOLARIZATION**—In an electric cell hydrogen bubbles form on the surface of the positive electrode and unless some arrangement is made to counteract this effect, the usefulness of the cell will soon be impaired due to the insulating action caused by this film of gas, known as *polarization*. Usually some means of oxidizing is employed to act upon the hydrogen as fast as it is produced on the positive electrode, thus preventing or reducing the effect of

polarization. (See *Cell*, also *Polarization*, and *Depolarizer*.)

**DEPOLARIZER**—The oxidizing agent or other means used in a cell to counteract the effect of polarization. Bichromate of potash or peroxide of manganese is commonly used for this purpose. (See *Dry Battery*, also *Polarization*.)

**DETECTOR**—A device for converting oscillating currents of high frequency (radio waves) into a form suitable for operating a telephone receiver or sensitive measuring instrument. It is often referred to as a *rectifier*, because it serves to change the incoming currents from alternating to pulsating direct currents. Detectors vary in type and efficiency, ranging from the now obsolete *coherer*, to the modern sensitive *regenerative vacuum tube*. The different types of detectors are taken up under their various headings. (See *Crystal Detector*, *Vacuum Tubes*, *Electrolytic Detector*.)

**DETECTOR CIRCUIT**—That part of the circuit in a radio receiver which contains the detector (q.v.). The detector circuit may be closely coupled to the balance of the receiving circuit by means of a tuning coil or it may be inductively coupled by using a variocoupler or loose coupler. (See *Coupling*.)

**DETECTOR, DAMPED WAVE**—Any special type of detector, such as a crystal, etc., used for reception of damped waves. (q.v.). (See *Tikker*, also *Heterodyne*, and *Vacuum Tube*.)

**DETECTOR, VACUUM TUBE**—The vacuum tube used as a detector of radio frequency (high frequency) oscillations. A vacuum tube may be used to change or rectify the high frequency alternating currents received at the aerial to pulsating direct currents (q.v.) capable of operating a telephone receiver or recording device. Formerly vacuum tubes were made for an

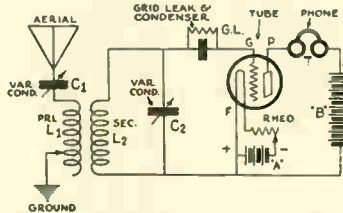

Fig 1. Non-regenerative vacuum tube circuit.

individual purpose, such as *radio frequency amplifier*, *audio frequency amplifier*, or *detector*, the amplifier tubes being highly exhausted and the detector tube having a low vacuum and requiring critical filament adjustment. Of late tubes have been developed to such an extent that no special tube is necessary for the detector circuit, all being adaptable for almost any purpose. Fig. 1 shows the ordinary circuit for a vacuum tube detector. This method is not much used now since the advent of regeneration, except where stages of radio frequency amplification are used ahead of the detector to amplify the incoming signals. In this case incoming signals are impressed on the grid "G" and the slight variations of potential at this point control comparatively large currents at the plate "P," actuating the telephone "T." (See *Vacuum Tube*, *Theory of Detector Action*.)

Used in this manner the tube is a considerable improvement over the crystal detector in point of sensitivity. However, by means of regeneration, the sensitivity may be increased many times. Fig. 2 shows a simple *regenerative circuit*. Here the unrectified currents passed through to the plate of the vacuum tube are fed back by means of the coil L2 and by being impressed again on the grid, further amplification can be attained. (For com-

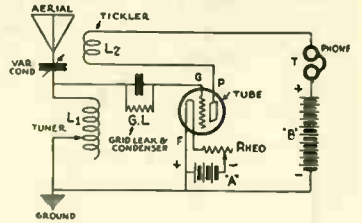

Fig. 2. Simple regenerative circuit.

plete explanation see *Regenerative*, *Theory of Operation of Vacuum Tube*, *Detector*, *Pulsating Direct Current*, also *Crystal Detector*.)

**DETUNING**—The opposite of tuning (q.v.) The process of varying the effective inductance or capacity or both, to throw the radio receiver out of resonance with the particular signals to which it is tuned. This may be done to decrease the volume of the signals or it may be employed to eliminate or reduce interference from some undesired signals. For example, a station operating with a wavelength of 400 meters might interfere with reception of a station operating on 360 meters, providing it has sufficient power, or the receiver is not particularly selective. If the radio receiver is detuned slightly below 360 meters, the desired signals will still come in, though at lesser volume, but the interfering signals will be lost entirely. Tuning is the act of producing resonance and detuning is the act of destroying resonance. In the case of a *heterodyne receiver* (q.v.) the heterodyne circuit is slightly detuned from the incoming oscillations, thus producing a difference in frequency or *beat frequency* (q.v.). (See *Resonance*, also *Dead-space*.)

**DIAGRAM**—A system of lines drawn to represent the circuit or connections for radio receivers or transmitters or associated apparatus, etc. Diagrams may be in any of several forms, the two common methods being known as *schematic* and *perspective*. In the

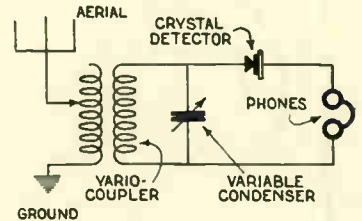

Fig. 1. Schematic diagram of a simple crystal receiver.

schematic form, symbols are generally used to represent the various pieces of apparatus, whereas in the perspective form, drawings of the apparatus are used. Fig. 1 illustrates a typical schematic diagram of a simple crystal receiver. Here the tuning coils, de-

lector, phones and so on, are shown in the form of symbols. Fig. 2 shows the same circuit in perspective form, with the tuning coil and other parts actually pictured. Diagrams may be used

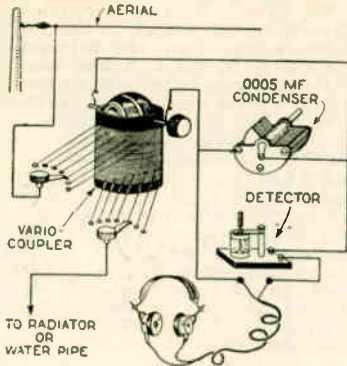
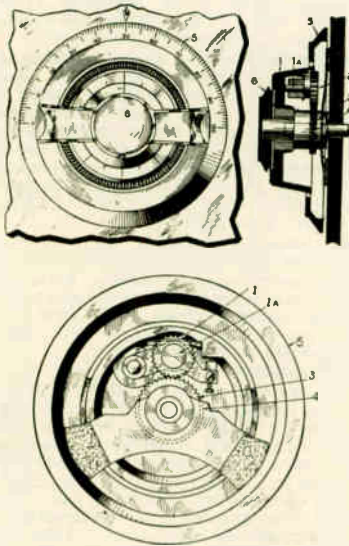

Fig. 2. Showing in perspective form the circuit given in Fig. 1.

to show connections for any electrical or radio circuits or for individual parts of instruments. (See *Hookup*.)

**DIAL**—Devices used to control the movement of condensers or other moving parts of radio apparatus. Most dials are made of a composition such as Bakelite or hard rubber; some are made of metal. The periphery is generally spaced off in numbers from 0 to 100 or 180, for purposes of keeping a record of the positions at which the various stations are received. Dials may be arranged to have the readings refer to definite values by means of calibration (q.v.). (See *Dial Vernier*, See *Log*.)

**DIAL, VERNIER**—A term incorrectly applied to a dial arranged with slow-



This dial utilizes the slip tooth principle. 5 is the main dial. 6 turns the slip gears (3) and (4), which cause 2 to turn. 2 is mounted on the shaft (1A) fastened to the condenser shaft. 1. 5 is the scale, fastened to the condenser shaft.

motion linkage in order to permit very fine adjustment. The illustrations show two types of vernier dials. Ver-

nier dials are generally used on *variable condensers* and occasionally on other instruments, where close adjustment is necessary. They are particu-

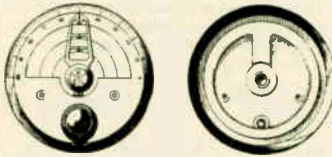

A simple vernier dial using a pinion and internal rack.

larly useful in the case of a *Super-Heterodyne receiver*, the oscillator control being critical, and the wavelength control as well, in certain cases. (See *Dial*, also *Critical*.)

**DIAMAGNETIC MATERIAL**—Substances not readily susceptible to *magnetism*. If a substance does not pass magnetic lines of force, but rather is repelled by a magnetic pole, it is said to be *diamagnetic*; its permeability, or ability to permit magnetism to pass through it, is considered negative or less than unity (air). Diamagnetic substances are apparently repelled from the poles of a magnet. If placed in a magnetic field they have a tendency to diminish the *magnetic induction* (q.v.). (See *Paramagnetic*, also *Permeability*.)

**DIAPHRAGM**—A thin disk, generally of soft iron used in *telephone receivers* and *microphones* (q.v.) to either produce or detect electrical pulsations by means of vibrations caused by an *electromagnet*. Variations in the current through the electromagnet cause corresponding vibrations in the diaphragm. While the common type of diaphragm is made of soft iron, there are numerous other materials used. Certain alloys have higher permeability, and therefore are more responsive to the attraction of the magnet. In one type of telephone receiver that is particularly sensitive, there are two diaphragms—one that is actuated directly by the electromagnet under the influence of a varying current and another of thin mica, coupled to it by a fine wire. Another type employs a small iron armature suspended on a pivot, and attached to a mica diaphragm by means of a delicate lever, at right angles to the armature. The vibrations of the armature in the magnetic field of the magnets are communicated to the diaphragm by means of this lever. (See *Baldwin Receiver*.) Another type is of metal with fine corrugations and still another is a mica or parchment disk with a piece of soft iron in the center. (See *Microphone*, *Telephone Receivers*.)

**DIAPHRAGM, CARBON**—A phone diaphragm in the form of a thin carbon disc. (See *Diaphragm*.)

**DIELECTRIC**—This term is rather broadly used in electrical work to indicate a non-conductor or *insulator*. A dielectric may be a solid, liquid or gas and is generally employed to separate two conducting surfaces. The most common instance of the application of a *dielectric* is in the case of a condenser. Here the plates are separated by a dielectric material, the nature of this material depending on the particular type and purpose of condenser. A *variable condenser* for receiving purposes generally employs air as the

### Dielectric Coefficient and Constant

dielectric. That is, the two sets of plates are kept from actual contact while one is being rotated, by an air space. In *fixed condensers* the dielectric is usually waxed paper, mica, glass, oil or compressed air, depending on the purpose for which the condenser is to be used and the dielectric strength necessary. While we refer to a dielectric as a non-conductor or insulator, there is actually no dividing line between conductors and insulators, practically any dielectric permitting passage of a certain amount of current under the proper conditions. If a substance is a very good insulator it is said to have good dielectric properties, while one that is a poor insulator and permits leakage of current is a correspondingly poor dielectric. (See *Insulator*, *Conductor*, *Resistance*, also *Dielectric Coefficient and Constant*.)

**DIELECTRIC ABSORPTION**—The tendency of the dielectric in a condenser to apparently absorb a certain amount of the power applied to it. When a condenser is charged by a direct current source such as a battery, the instantaneous charge is often followed by a small charge or flow of current that steadily decreases as it flows into the condenser. This additional charge is in effect absorbed by the dielectric of the condenser. The reverse effect is obtained when the condenser is discharged, the instantaneous discharge being followed by a steadily decreasing additional discharge. It will be apparent, then, that if the condenser is charged from an *alternating current* source, such as by *radio frequency currents*, the dielectric will show a tendency to withhold a certain part of the charge, and as the charging and discharging goes on rapidly due to the rapid reversals of the current (see *High Frequency Alternating Current*), the dielectric will continue to hold back this portion of the power as long as the charging and discharging process persists.

This loss, due to the absorption in the dielectric, must not be confused with the losses due to faulty dielectric materials, wherein a certain portion of the current is allowed to leak away by conductance through or on the surface of the insulator. *Dielectric absorption* is often referred to as *dielectric viscosity* or *hysteresis* because of its similarity to viscosity in liquids. Viscosity is the property possessed by liquids to resist deformation. The usual method of measuring viscosities is by measuring the time taken by a known volume of the liquid, at a known temperature, in flowing through an aperture of known form and dimensions under a known pressure. Thus tested, water will flow rapidly, while cylinder oil is very sluggish, and hence is said to possess great viscosity. (See *Condenser*, also *Dielectric*.)

**DIELECTRIC COEFFICIENT and CONSTANT**—The specific *inductive capacity* of a dielectric. Generally speaking, its properties to act as a *dielectric*. In the *Centimeter Gram Second system* (q.v.) the *inductive capacity* and the *dielectric constant* are numerically equal, the constant being the dielectric value of the material as compared with air at ordinary pressure taken as the standard (1). The table of constants for the more important dielectric materials follows.

It will be seen that glass, oils and mica have the highest values, for which reason they are widely used. (See *Specific Inductive Capacity*, *Dielectric*, also *C. G. S.*)

## Dielectric Constants

TABLE OF DIELECTRIC CONSTANTS

Dielectric	Constant
Air at ordinary Pressure (Taken as the Standard)	1.000
Manila Paper	1.50
Celluloid	1.555
Parraffine (clear)	1.68 to 2.32
Beeswax	1.86
Parraffine Wax	1.9936 to 2.32
Parraffined Paper	3.65
Hard Rubber (Ebonite)	2.05 to 3.15
India Rubber (pure)	2.22 to 2.50
Gutta Percha	2.46 to 4.20
Shellac	2.74 to 3.60
Olive Oil	3.00 to 3.16
Glass (Low Frequency value)	3.25 to 4.00
Glass (High Frequency value)	4.21
Mica (Pure Sheet)	4.00 to 8.00
Porcelain	4.38
Castor Oil	4.80
Flint Glass, very light	6.57
Flint Glass, light	6.85
Flint Glass, very dense	7.40
Flint Glass, double extra dense	10.10

**DIELECTRIC CONSTANTS**—See *Table of Constants* under "Dielectric Coefficient and Constants."

**DIELECTRIC HYSTERESIS**—When the electric field in a dielectric material is varied rapidly, as when the condenser is charged by high frequency currents, heat may be generated. This is due to dielectric hysteresis which is synonymous with dielectric absorption (q.v.)

**DIELECTRIC STRENGTH**—When an electric field is established in a dielectric, that is to say, a charge is applied to a condenser, and the field attains a certain intensity, the dielectric ceases to be an insulator and becomes, in effect, a conductor. This condition generally is accompanied by a puncturing of the dielectric material. When the charge applied to a condenser is too high the spark will burn through the dielectric and the condenser is then said to have broken down. In some cases the condenser may be permanently ruined by this action, and in others, the dielectric may be conductive at a certain voltage, while remaining effective as long as the voltage is held below the safety point. The particular voltage (critical voltage) or field intensity at which the breakdown of the dielectric occurs is called the dielectric strength of the material. (See *Dielectric*, also *Table of Dielectric Strength*.)

**DIFFERENCE FREQUENCY**—The frequency of oscillations produced by superposing oscillations of one frequency on oscillations of a different frequency. In Super-heterodyne receivers the action is based on the production of a difference or beat frequency. If the incoming oscillations from the antenna are combined with oscillations of a different frequency produced locally in the receiver, a new series of oscillations will be produced, these oscillations having a frequency numerically equal to the difference in frequency between the other two sets of oscillations. (See *Beat Frequency*, also *Super-Heterodyne*.)

**DIODE**—A thermionic vacuum tube having only two electrodes, namely filament and plate. The original vacuum tubes were known as *Fleming Valves* and contained a hot filament and cold plate but no grid as found in the three element vacuum tube now in general use. Several types of diode are still in use as detectors, their chief value lying in the fact that they require no careful adjustments as in the case of a crystal detector. (See *Triode*, *Vacuum Tube*, also *Fleming Valve*.)

**DIPLEX RECEPTION OR TRANSMISSION**—The simultaneous reception or transmission of two series of signals by or from a single operating station. The systems are so arranged that two messages may be sent or received at the same time without interfering with each other. (See *Duplex Signalling*.)

**DIRECT CONDUCTIVE CIRCUIT**—Any circuit having a direct conductive path and not depending on capacity or electromagnetic coupling. A metallic, conducting circuit.

**DIRECT COUPLING**—The coupling or relation between two or more coils or circuits, wherein the connection is metallic. In the illustration Fig. 1 is

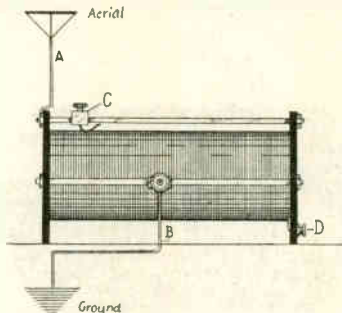

Fig. 1. Double slide tuner which affords direct coupling between the primary and secondary circuits.

shown a two slide tuning coil. In this case A-B is the primary or aerial circuit and C-D the secondary or detector circuit. The two circuits are joined together by metallic connection.

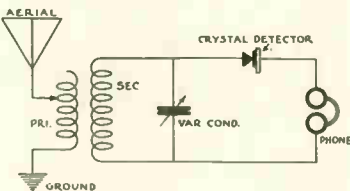

Fig. 2. Circuit in which primary and secondary are inductively coupled.

The illustration Fig. 2 shows essentially the same circuit, except that the primary and secondary are two separate coils. Here the two coils or circuits are joined by inductive coupling.

**DIRECT COUPLED**—Circuit in which primary and secondary circuits are metallically connected. Generally permits little selectivity. For this reason, inductive coupling is more generally used to permit close tuning or selectivity (q.v.). (See *Coupling*, *Inductive Coupling*.)

**DIRECT CURRENT**—See *Current*, *Direct*.

**DIRECT READING**—A term applied to various measuring or recording instruments which are so arranged as to show values directly without requiring mathematical reduction. *Voltmeters*, *Ammeters* and such instruments, used widely for showing the voltage, current, etc., of batteries or cells, are direct reading, showing the values directly in volts or amperes. A *decrementer* or *wavemeter* very often shows a reading that requires application of a formula to produce the desired quantity. (See *Calibration*.)

**DIRECTION FINDER**—See *Radio Compass*.

**DIRECTIONAL**—The effect of an aerial wherein waves are transmitted better, or entirely, in a certain direction, or received from a certain direction, depending upon the type and direction of aerial. (See *Transmitting Aerial*, also *Receiving Aerial*.)

**DIRECTIONAL EFFECT OF ANTENNA**—An effect of an antenna (aerial) for reception or transmission wherein signals from a certain direction are more readily received than from another direction, or in the case of transmission, the range being greater in a certain direction.

**DISCHARGE**—Generally speaking, a comparatively sudden passage of electricity. The term however, as applied to a storage battery will mean merely the effect of releasing the electrical charge stored up in it, in this case the discharge not being necessarily rapid. A condenser has the ability to hold charges of electrical energy and to release them suddenly when the proper

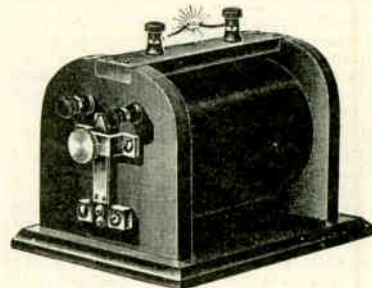

Discharge from a spark coil.

contact is made. The term "discharge" as applied to a transmitter indicates the passage, usually in the form of a spark or succession of sparks, of the electrical energy across a gap between electrodes. The illustration shows spark discharge from spark coil. (See *Spark Discharge*, *Storage Battery*, also *Discharger*.)

**DISCHARGER**—Any device allowing a path for an electrical discharge. The term may be considered roughly a synonym for *spark gap*. Usually two or more electrodes, either stationary or rotary, spaced a short distance apart to permit the released electrical energy to bridge the space and thus complete an oscillatory circuit. (See *Disc Discharger Rotary Gap*.)

**DISC DISCHARGER**—A form of discharger employing one or two rotating discs carrying the sparking surfaces. With the advent of modern undamped transmission methods, these dischargers are gradually passing out. (See *Synchronous Discharger*.)

**DISPLACEMENT CURRENT**—A current which flows for a short interval in an insulating material or dielectric when an electromotive force is impressed across it, or when the intensity of the electromotive force impressed across it is increased or decreased. This displacement current will flow only when the impressed electromotive force is altered in intensity. After the initial current due to the sudden change in the electromotive force being impressed across the material, the dielectric material or insulating material will remain in a state of strain as long as the charging force persists without further change in intensity, and no further displacement current will flow. (See *Current*, also *Dielectric*.)

**DISPLACEMENT, PHASE**—See *Phase Displacement*, also *Phase Angle*.

**DISRUPTIVE VOLTAGE**—The voltage sufficient to disrupt or break down a sample of dielectric material under given conditions. Known also as *breakdown potential*. For example, if a condenser will stand an impressed potential or voltage of 500 volts without injury, but will be punctured by a potential of 1000 volts minimum, the disruptive voltage is said to be 1000. (See *Break Down Potential*.)

**DISSOCIATION THEORY**—A theory advanced by Arrhenius in 1887, explaining *electrolytic conduction* by the assumption that a substance in solution is dissociated or separated into *positive and negative ions*, these ions carrying their respective charges in opposite directions. (See *Electrolytic Action*.)

**DISSONANCE**—“Discord; disagreement”—Webster. The antonym of *resonance*. A term broadly applied in radio to indicate lack of resonance, or coordination of signals or impulses. When an alternating current is superimposed on another alternating current of different frequency, the resulting lack of resonance—*disonance*—is known as a *beat*. (See *Distortion*.)

**DISTORTION**—Lack of purity or faithfulness in the reproduction of a vibration or series of vibrations. The most common application of the term in broadcast reception is in the case of reproduction by a loud-speaker. It will very often be found that music or speech is not perfectly reproduced, due to any of a variety of causes. Vacuum tubes may themselves cause distortion; too high potential applied to the plate of a tube may result in distortion; many transformers used in audio frequency amplifier circuits may distort notes of certain frequencies, or it may be due to *self-oscillation* or *regeneration* in the receiving set. This effect is also caused by inefficient transmitting (broadcasting) apparatus, or by lack of careful adjustment. The transformation of speech or music into electrical impulses and its subsequent transmission and reception are attended by many difficulties.

The control of wave form in broadcasting is known as *modulation*. (q.v.) If the transformation of speech or music into electrical impulses and its propagation into space is accomplished without materially changing or distorting the wave form from the original voice or music vibrations, the problem of accurate reproduction is entirely dependent on the receiving apparatus. Distortion may often be traced to the diaphragm of the loud-speaker, certain types being more efficient in this respect than others. (See *Loud-speakers*.) If the ordinary type of disc diaphragm is used, it may become bent and thus cause inequalities in the vibrations, producing distortion of the music or speech being reproduced. (See *Wave Form, Modulation*, also *Amplifier*.)

**DISTRESS SIGNAL**—At the International Radio Telegraph convention held at Berlin, Germany, in July, 1908, the call letters C Q D, established by the Marconi Co. in February, 1904, as the official distress call, were superseded by the letters S O S as the Marine distress signal.

S O S is the International distress call for ships and airships requiring assistance. The letters have no particular significance, being chosen mainly for their distinctive sound. In the

International Morse code, S O S is composed of three dots, three dashes and three dots, thus: . . . — — — . . . an unusual combination which permits easy recognition among other messages and calls. When distress signals are heard, the nearest government transmitting station generally sends out immediate notification to all broadcasting stations in the vicinity to suspend operations until the ship has been located and assistance rendered.

**DISTRIBUTED CAPACITY**—The condenser effect in a coil of wire. Any coil of wire possesses *inherent capacity* to a certain extent, depending on its particular shape, size, etc. In the case of a coil of wire wound on a cylindrical form as indicated in the illustration

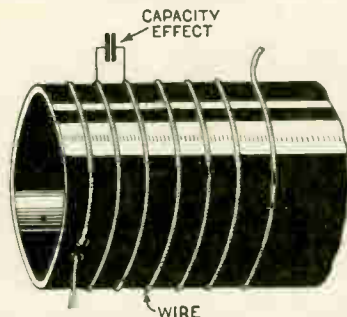

Fig. 1. Coil showing effect of distributed capacity between winding.

Fig. 1, the passage of current through the coil sets up a *local magnetic field*, but also an *electrostatic field*, the latter being in the form of lines of force perpendicular to the conductor. Thus in effect, each two adjacent turns of wire act as a miniature condenser (Fig. 2).

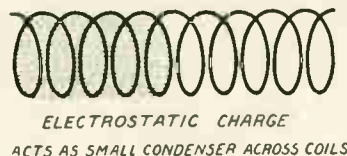

Fig. 2.

There are numerous methods and forms for winding coils in order to do away as much as possible with this effect. (See *Low-Loss Coils*.)

**DISTRIBUTED INDUCTANCE**—In a long cable or any great length of wire used for electrical purposes, additional inductance (wire) distributed throughout the entire length to compensate for the inherent capacity of the line. (See *Distributed Capacity*.)

**DOT**—The short signal in the International Morse Code. (See *Code*.)

**DOUBLE AMPLIFICATION CIRCUIT**—Also known as *dual amplification circuit*. The arrangement whereby a vacuum tube or several tubes may be made to do double duty, acting as both *radio frequency* and *audio frequency amplifiers*. (See *Reflex*.)

**DOUBLE COTTON COVERED WIRE**—Abbreviation D. C. C.—Cotton covered copper wire widely used in radio work for coils and all forms of inductances. The insulating covering is composed of two distinct layers of cotton, wound on in opposite directions to prevent loosening. Such wire is obtainable in a variety of sizes according to the standard gauges. (See *Wire Gauge*.)

**DOUBLE FREQUENCY OSCILLATIONS**—Sometimes referred to as a *double humped wave*. An irregular

wave resulting from two frequencies, generally due to too close coupling of the *oscillation transformer*. When the coupling between the open and closed *oscillatory circuits* is too tight, the *open circuit* very often oscillates at two frequencies, resulting in the radiation of an irregular or *impure wave*. The illustration Fig. 1 shows in graphic form, such an irregular wave. The two peaks of resonance explain the term *double humped wave*. Fig. 2 shows another curve illustrating two frequencies.

In this case however, the amplitude of the second wave is considerably less than that of the first or main wave. According to U. S. Government regulations, if the amplitude of the lesser wave is not more than 0.1 of the am-

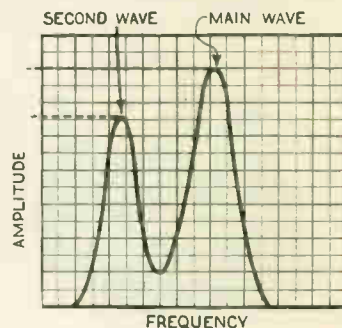

Fig. 1. Resonance curve showing second wave of interfering nature.

plitude of the main wave, it is said to be pure. In other words, where there are two frequencies, but the strength of one less than one tenth that of the

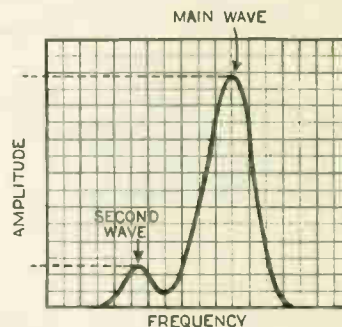

Fig. 2. Resonance curve showing second wave of negligible proportion.

other, it is considered negligible as it cannot be expected to cause any appreciable interference. (See *Resonance, Amplitude, Decrement*, etc.)

**DOUBLE GRID TUBE**—A vacuum tube having two distinct *grid* members in addition to the usual *filament* and *plate* elements. Such a tube is used in circuits where the customary “B” battery is not employed, the extra grid acting as a booster for the electron flow, the “A” battery furnishing a small positive potential to the plate. (See *Solodyne*, also *Theory of Vacuum Tubes*.)

**DOUBLE MODULATION**—Successive modulation of a *radio frequency alternating current* at two lower frequencies. The *intermediate frequency* is usually above *audio frequency* and the lowest frequency is customarily within *audio limits* or a combination of *audio frequencies*, as in the case of *radio*

## Double Pole Switch

telephony (broadcast). (See *Modulation*.)

**DOUBLE POLE SWITCH**—A switch used in electrical practice and in radio installations having two poles or connections, thus permitting both sides of a circuit to be opened or closed simultaneously.

**DOUBLE RANGE METERS**—Meters used for electrical measurements, arranged to read to two scales. As an example, the voltmeter shown has two scale readings, one in fine degrees for a maximum of 7.5 volts, the other a coarser scale to a maximum of 150 volts. Three binding post connectors are furnished, one being a common positive for both scales. A meter for almost any measurement might be made to have double range, although such instruments are generally confined to measurement of current in

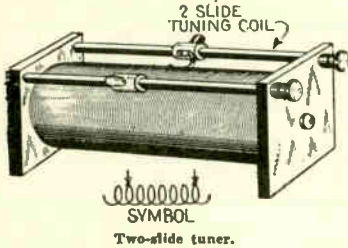

Photo by Courtesy of Weston Electrical Instrument Co.

Double range meter, one range to 7½ volts, higher range to 140 volts maximum.

amperes and pressure in volts—i. e., ammeters and voltmeters. (See *Meter*.)

**DOUBLE SLIDE TUNER**—A tuning coil provided with two sliding contacts, generally used in crystal receivers.



The illustration shows a common type of two slide tuner. (See *Coupling Crystal Receiver*, also *Tuning*.)

**DOUBLE THROW SWITCH**—A switch so arranged that a circuit or a certain instrument is connected in either of two different positions by throwing the

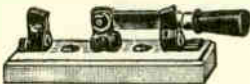

Double throw single pole switch.

switch lever. The illustration shows a single pole double throw switch. (See *Switch*.)

**DOWN LEAD**—More commonly known as *lead-in*. The wire running from the aerial to the receiving or transmitting apparatus, whereby the signal energy is either collected from, or fed to, the aerial. The illustration shows a typical down lead or lead-in for a receiving set. Obviously the chief difference between such a lead for receiving purposes and for connecting a transmitter to the antenna is the matter of insula-

tion. The comparatively feeble impulses received or collected by the aerial when receiving require only ordinary care, whereas the high volt-

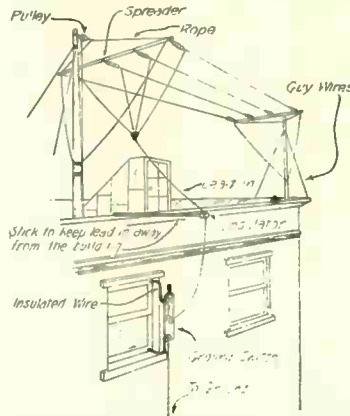

A typical 4-wire aerial showing lead in and method of installing lightning switch.

ages used in transmitting require careful insulation and much heavier apparatus all around. (For more complete details regarding insulation, etc., see *Aerial*.)

**DRIFT, AVERAGE ELECTRON**—The assumed rate of flow or drift of electrons under average or specific conditions. (See *Electronic Flow*. Also *Current, Assumed Direction of Flow*.)

**DRIVER**—A term broadly used to denote any system used to produce oscillations (vibrations) of a local nature. More specifically any means of producing oscillatory currents as used to test or make measurements in radio circuits. A buzzer connected inductively to a circuit to produce oscillations in that circuit for the purpose of making measurements of *capacity*, *wavelength*, etc. Another means might be a circuit involving a vacuum tube and the necessary apparatus to make it oscillate at a given or variable frequency. The term may be used to signify the tube circuit used to produce local oscillations in the case of a *super-heterodyne* (q.v.). Here the driver produces a series of oscillations of a frequency different from the incoming oscillations, the difference between the two being known as the *beat frequency*. (See *Heterodyne, Local Oscillations, Buzzer, Excitor*.)

**DRIVER CIRCUIT**—The circuit of the apparatus used to produce oscillations for purposes of test or measurement, or, in the case of a super-heterodyne, to produce a beat effect. (See *Driver*.)

**DRUM ARMATURE**—A form of armature winding in the approximate shape of a drum. (See *Armature*.)

**DRY BATTERY**—A battery or group of cells not employing a liquid electrolyte, the cell being filled with a mixture of carbon, manganese dioxide and sawdust (or other absorbent) saturated with a solution of sal ammoniac, these forming a paste, as distinguished from *Wet Battery*. (See *Battery*, also *Cell* and *B Battery*.)

**DRY CELL**—See *Dry Battery*.

**D. S. C.**—The abbreviation for "Double Silk Covered" as applied to copper wire having two distinct layers of silk, wound generally in opposite directions. This wire is furnished in standard sizes according to the various wire gauges. (See *Brown & Sharpe Gauge*.)

**DUAL AMPLIFICATION**—The process of obtaining both *radio frequency* and *audio frequency amplification* from the same tube instead of using two separate tubes. (See *Double Amplification Circuit*, also *Reflex*.)

**DUBILIER, WILLIAM**—President and technical director; born, New York, July 25, 1888. Educated New York Schools, Technical Inst. and Cooper Union; Chief Engineer of Continental Wireless Tel. & Tel. Co.; 1910 President of Com. Wireless Tel. Co.; at present Technical Director of Dubilier Condenser and Radio Corp. of New York, The Dubilier Condenser Company Ltd. of London, The Deutsche Dubilier Kondensator Gesellschaft in Berlin, La Protection Electrique Capart-Dubilier in Paris. Has obtained over three hundred patents and applications of electrical devices, which have been purchased or licensed by many companies. Member American Institute Electrical Engineers, Inst. of Radio Engineers, Honorary Member of Societe Academique D'Historie Internationale. Member of Royal Society of Arts.

**DUCON**—Trade name of a device which can be fitted to any electric light socket and made to serve in place of the usual outdoor aerial. This attachment consists essentially of two condensers, so arranged as to prevent the passage of any direct current or low frequency alternating current from the lighting main to the receiving set, but at the same time to permit passage of the incoming radio signals, the electric light line acting, therefore, as an aerial. (See *Adapter, Aerial*.)

**DUDELL SINGING ARC**—Also called *Musical arc*. An arc actuated by a source of direct current through a *resistance* and shunted by a *condenser* and *inductance* in series. An oscillat-

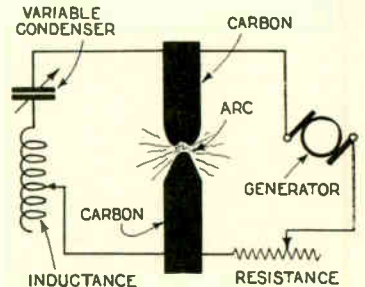

Schematic arrangement for operation of Duddell singing arc.

ing current is thus produced in the condenser circuit, the result being a singing note corresponding in pitch to the frequency of the oscillations in the condenser circuit. The schematic arrangement is shown by the illustration. (See *Arc Generator*.)

**DULL EMITTER**—The English term for vacuum tubes having *thoriated filaments* and operating with low current consumption. While the term is generally used to denote the tubes requiring only one or two dry cells to operate, it may apply as well to storage battery tubes where the current requirements are low. (See *Filament, Thoriated*.)

**DUOLATERAL COILS**—An alternate term for *honey-comb coils*; inductances wound in diamond-shaped layers to reduce the distributed capacity effect. (See *Honey-Comb Coils*.)

**DUPLEX SIGNALLING or DUPLEX TELEGRAPHY OR TELEPHONY**—The simultaneous transmission of signals or telephony in both directions between two stations. (See *Duplex Reception or Transmission*, also *Telephony*.)

**DUST CORE**—A form of core for certain types of transformers, employing iron filings or dust in place of the customary iron wire or laminations. Iron dust is used occasionally where simplicity of construction is desired, the assembly of such a core being obviously much easier than with wire or laminated types. (See *Core*.)

**DX**—The popular term for long distance; referring to the transmission to or reception from distant points of radio signals or broadcasting.

**DYNAMIC CHARACTERISTIC**—The curves obtained by impressing an alternating E. M. F. (electromotive force) on the grid of a vacuum tube, as distinguished from the curves obtained by application of a steady direct potential. When alternating potentials such as incoming signals are impressed on the grid of a tube, the curve resulting is apt to take an entirely different form from that of the curve showing *static characteristics* (q.v.). (See *Vacuum Tube characteristics*.)

**DYNAMIC CONDENSER**—A term occasionally applied to a *synchronous motor* used to improve power factor (in alternating current circuits, the ratio of the electric power in *watts* to the apparent power in *volt amperes* is known as the power factor). Used in this manner the motor has the effect of advancing the current phase in a manner similar to that of a condenser. (See *Angle of Lead or Lag*.)

**DYNAMIC ELECTRICITY**—A term sometimes used for electric currents to distinguish them from *static electricity* (q.v.).

**DYNAMO**—A machine for converting mechanical energy into electrical energy. Is also known as *generator*, but usually confined to machines for generating *direct current*. The action of a dynamo is based on the production of an *electromotive force* in a conductor moving in a magnetic field. Fundamentally a dynamo is a machine that generates alternating current, but instead of collecting this current by means of rings, which would cause alternating current to flow in the external circuit, a device known as an *armature* is employed in such a manner that the current collected by brushes and delivered to the external circuit is *direct*—that is, it flows more or less steadily in one direction. Thus the kind of current delivered for use depends on the method used to collect the currents generated. (For more complete explanation of the production of alternating current see *Alternating Current, Theory of Production*.) In the case of a dynamo, the essential parts are the *field magnets*, the *arma-*

*ture* and the *commutator*. Now in the case of an *alternator*, each end of the

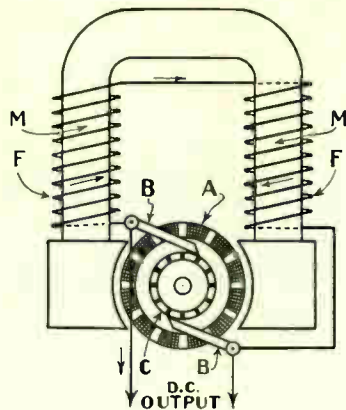

Shunt wound dynamo.

loop or armature is connected by a brush bearing against a collector ring and the end of each loop is always connected to the same brush. This results in an external current that changes its direction with each reversal of direction of the induced electromotive force. If the external current is to be direct it is necessary to have some means of collecting the current through one brush at the positive instant and the other at the negative instant. This is done by means of an armature, which is in effect a switching arrangement, so designed that it will reverse the connections of the external circuit at the instant of each reversal of current in the armature. The illustration shows a *shunt wound dynamo*. MM are the field magnets, BB the brushes, FF the field windings, A the armature and C the commutator. (See *Alternator, Armature, Generator*.)

**DYNAMOMETER**—A delicate and accurate instrument for the measurement of currents and voltages or both. Such instruments depend upon the action of a circuit carrying current upon another carrying the same current. Essentially it comprises two coils, one fixed and the other movable. This system of measurement is used in a *wattmeter*, where it is necessary to measure the instantaneous current and voltage, i.e., power. (See *Wattmeter*, also *Electro Dynamometer*.)

**DYNAMOTOR**—A direct current machine which acts either as a *motor* or *dynamo*. It has an armature with two separate windings and two separate commutators, one at each end of the armature. Either winding may be used as a motor and the other as the generator winding. Such a machine is used to convert high voltage direct current into low voltage direct current or vice versa, thus performing the same function with direct current as a

power transformer performs for alternating current. (See *Converter*.)

**DYNATRON**—A form of vacuum tube generally used for producing oscillations as in radio telephony, wherein the phenomena of "*secondary electron emission*" is used. In this form of tube the electrons traveling at high speed from the hot filament or cathode

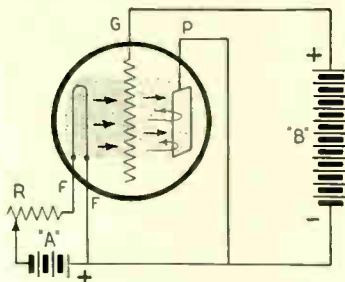

Showing how a standard vacuum tube can be connected to act as a dynatron.

are made to collide with a metallic surface. The collision of these electrons on the surface of the interposed element has the effect, under proper conditions, of jarring other electrons out of the metal. The secondary emission thus obtained depends upon the speed of the original electrons which collide with the metal surface. Normally, these secondary electrons will immediately re-enter the surface from which they were emitted, but if another electrode of higher potential is in the vicinity they will travel toward it in the same manner as the electrons are attracted to the plate of an ordinary three element tube. A standard tube can be connected as shown in the illustration to act as a dynatron. Here the filament F emits electrons, some of which pass through the grid G and collide with the plate P. This collision with the plate P may jar loose from the surface additional electrons, which normally would immediately re-enter P. However, as the grid G is held at a higher potential (higher positive voltage) than P, the electrons will be drawn toward it. A tube arranged in this manner may be used for practically any of the purposes of the standard tube, such as regenerative detector, detector of continuous waves or as a generator of high frequency oscillations, but it has not been shown to have any advantages in this respect, being used mainly as an *oscillator* (q.v.). (See *Electron Emission, Vacuum Tube*, etc.)

**DYNE**—The unit of force in the absolute or CGS system of units. It is defined as the force which, acting on a mass of one gram for one second, will impart to the mass a velocity of one centimeter per second. (See *CGS System*, also *Force*.)

## E

**E**—Common symbol for *Electromotive force* (q.v.).

**EAR CUSHION**—Pads or cushions of soft rubber used in conjunction with head-phones to prevent unpleasant pressure against the ears and also to exclude outside sounds when listening in.

**EARTH**—An alternate term for *ground*, where the earth or any metallic connection thereto is used as a return in transmission or reception of *electromagnetic waves*. (See *Ground*.)

**EARTH CURRENTS**—See *Ground Currents*.

**EARTH, DEAD**—See *Ground*.

**EARTH DETECTOR**—See *Ground Detector*.

**EBONITE**—See *Insulating Materials*.

**EBURIN**—An insulating compound used for *strain insulators* (q.v.). (See *Insulating Materials*.)

**EDDY CURRENT LOSS**—The portion

## Eddy Currents

of the total loss in electrical apparatus due to *Eddy Currents* (q.v.).

**EDDY CURRENTS**—Currents induced in the mass of a solid conductor due to the action of a varying magnetic field. The most common example of eddy currents will be found in the case of a dynamo or generator. Here the useful current generated in the armature is produced by the motion of the armature in the magnetic field. At the same time currents are generated in the iron core due to its motion in the magnetic field. As all currents generated in an electrical machine are produced at the expense of a certain amount of energy, and since the Eddy currents cannot be gathered or put to useful account in this case, they represent a loss. This loss usually is apparent in the form of heat. If the core is made up of solid metal it will be obvious that a good closed path is offered for eddy currents produced. Now if the core is composed of a number of sheets or laminations, insulated by thin layers of paper or by an insulating scale (see *Transformer Steel*) the path for the eddy currents is partially broken and the effect is reduced. Eddy currents are produced in the core of a transformer due to the same action—the variation of the magnetic field in which the core is located. In order to reduce the effect, laminated cores are employed as in the case of many generating machines. Eddy current loss is often given as the loss in watts per pound of core material at 10,000 gaussses (q.v.) and 60 cycles for a sheet 0.0141 inch or 0.0358 centimeter thick. While eddy currents are usually productive of losses they are put to useful account in certain types of instruments. For example, the eddy currents produced in the metal frame of a moving coil meter may be employed to damp or retard the free oscillations of the needle. (See *Damping of Instruments*.) Eddy currents are also used in a form of speed indicator where the reaction of eddy currents created in a moving disk are made to deflect a pivoted, spring controlled, magnetic needle. (See *Core Loss, Hysteresis, also Foucault Currents*.)

**EDDY CURRENT COEFFICIENT**—The coefficient or numerical multiplier, generally termed  $K_e$ , used in calculations of eddy current loss. Its numerical value depends upon the specific resistance (q.v.) of the iron used in the core of the machine in question, the character or wave shape of the induced voltage, the distribution of magnetic flux (q.v.) in the core material, the degree of insulation between sheets, where laminations are used, and upon the flux distribution (q.v.) due to the shape of the magnetic circuit. Its value will also vary according to the units used in the computation.

**EDDY CURRENT LOSS, FORMULA FOR CALCULATING**—A common formula for calculation of eddy current loss is the following:  $P_e = eV(xfB)^2$ . Here the loss is expressed in watts as  $P_e$ ,  $V$  is the volume of core metal in cubic centimeters,  $x$  the thickness of the sheets in centimeters,  $f$  the frequency in cycles per second,  $B$  the flux density (q.v.) in gaussses and  $e$  the eddy current coefficient.

**EDGE EFFECT**—The effect on the capacity of a condenser due to the curving of the lines of stress at the edge of the plates. This effect is not very pronounced where there is considerable

dielectric surface (insulating material) extending beyond the edge of the plates. (See *Distributed Capacity*.)

**EDISON BATTERY**—A number of Edison cells grouped together in one case to supply various currents and voltages as in radio. The illustration shows an Edison "B" battery, used to supply potential to the plates of

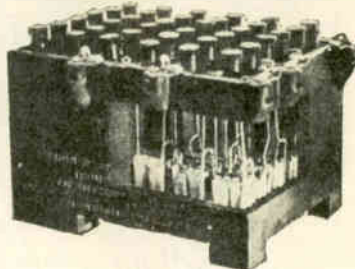

Photo by Courtesy of Edison Storage Battery Co.

Edison "B" battery with portion of case removed to show interior construction.

vacuum tubes. (See "A" Battery, "B" Battery, Plate, Filament, also Storage Battery.)

**EDISON CELL**—A storage cell employing electrodes of nicked steel and a solution of potassium hydrate for the electrolyte as distinguished from the usual type of storage cell using lead plates and dilute sulphuric acid as the electrolyte. The chief point of superiority of this type of cell is its comparative ruggedness, due partially to steel construction and also to freedom

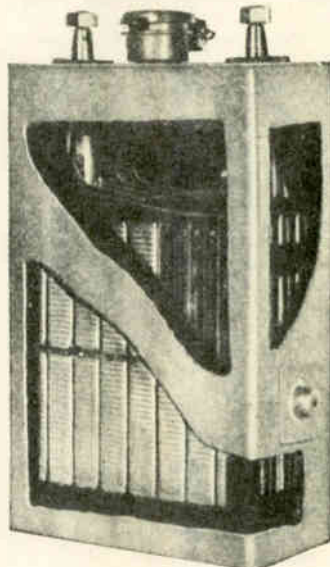

Photo by Courtesy of Edison Storage Battery Co.

Edison cell with part of case cut away to show how constructed.

from the usual ills of cells employing acids and lead plates. The positive electrode in the Edison cell is made by tamping nickel hydrate and alternate layers of pure flake nickel into perforated steel tubes under pressure. The negative electrode is made by pressing iron oxide into flat perforated steel pockets. A number of these pockets are forced into a steel grid to form the complete negative plate. (Note: The negative electrode connection on the outside of the cell is re-

ferred to as the positive pole because it is positive in its relation to the external circuit. Similarly the positive electrode connection will be known as the negative pole.) The potassium hydrate or hydroxide which takes the place of the acid solution used in the lead plate type of cell acts as a preservative of the steel elements. This naturally means greater life; in fact, it is not subject to the chemical deterioration of other cells. The illustration shows a cell with part of the sides cut away to show the interior construction. (See *Edison Battery*.)

**EDISON, THOMAS ALVA**—Born 1847.

An inventor famous for his experiments in applied electricity. He began life with newspaper work which he soon abandoned for telegraphy, making many original inventions in duplex systems of operation. After a varied experience in that line he came to New York in 1871, where his talents were recognized and he had opportunity to profitably develop his ideas. The duplex telegraph was made a success the following year, and two years later the quadruplex; and thereupon he began manufacturing on a large scale for the Western Union Telegraph Co. In 1876 he gave up his factory, and established his experimental station at Menlo Park, N. J., where for several years he worked upon the problem of the incandescent electric light, exhibiting a successful bamboo filament lamp in Paris in 1881. He invented the phonograph in 1878. He superintended the construction of the first incandescent lighting station in New York in 1882. Moving his laboratory to Orange, N. J., he established there a large plant for electrical experiment and invention and as a result of his labors there he has taken out 400 patents. Among his inventions may be further named: a type of dynamo, a microphone, the chemical electrical meter, an electric pen, the mimeo-



Thomas A. Edison

graph, the magnetic ore separator, dead beat galvanometer, the electric torpedo, a telephone transmitter, and a storage battery. His chief fame rests with his development of the telegraph, his invention of the incandescent lamp and the phonograph.



**EDISON EFFECT**—The blackening of the inner surface of an electric light bulb during use. Edison noticed that after the lamp had been burned for some time a coating of black formed on the inner surface and increased in density, becoming finally almost opaque. Edison's experiments, followed by those of Professor Fleming (q.v.) resulted in the development of the Fleming valve (q.v.), it having been determined that the black coating was due to the discharge of electrons from the hot filament. (See Vacuum Tube, Electron Emission, etc.)

**EFFICIENCY**—A very flexible term in electrical practice. Generally speaking, the ratio of useful output of any piece of apparatus to total input. Efficiency is customarily expressed in terms of percentage. Thus, broadly, a piece of apparatus may produce as useful output 80 per cent of the total input. (See Power Factor.)

**EFFECTIVE ELECTROMOTIVE FORCE**—The square root of the mean square of the full alternating current wave. Usually abbreviated R. M. S. (root—mean—square). The effective value of the E. M. F. (electromotive force) is thus taken as the square root of the mean of the squares of the instantaneous values over a complete period. (See Instantaneous Values.)

**EGG INSULATOR**—A name applied to a certain type of strain insulator due to its egg-like form. The illustration shows such an insulator. The two con-

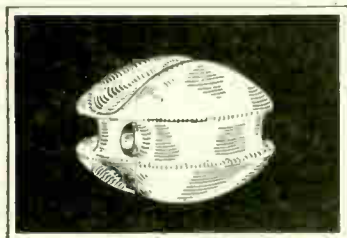

An egg insulator.

nections to the insulators are so arranged that the wires will still be looped together in the event that the insulator breaks. (See Insulator, also Insulation of Aerial.)

**ELASTICITY**—A property of matter which permits it to resist any change in shape or bulk and permits it after such a change to return to its original state. This property of materials by virtue of which they are enabled to return to their original state after the force causing the distortion has been removed is a very important one in all branches of engineering. Its chief application in radio is in the matter of aerials and aerial guy wires. While the average aerial installation does not represent any serious problems in stress, the large aerial systems of commercial stations must be carefully designed in this respect. For example, a guy wire of one material may have more elasticity than one of similar size in another material. The amount which the wire will stretch under a certain load may be determined by use of a table giving the elasticity of various metals. (See Electric Elasticity.)

**ELECTRIC ABSORPTION**—An effect in condensers. That quality of a condenser by means of which it absorbs or "soaks up" a charge of electricity, and conversely, retains part of the charge when the condenser is momentarily discharged. This effect is more

apparent in cases where a solid dielectric material is used. In fact, air condensers (q.v.) are said to have little electric absorption. The reason for this is that mica or other solid dielectrics are strained to a greater extent than air dielectric after the condenser has received a charge. (See Soaking In, also Dielectric Absorption.)

**ELECTRIC DISPLACEMENT**—A term proposed by Maxwell to denote a quantity expressing the state or condition of a dielectric in an electric field in accordance with the supposition that such a field is created by the transfer of positive electricity to one end of the field of force and negative electricity to the other end of the so-called tubes of force (q.v.). (See Displacement Current, also Electrostatic Induction, and Flux Density, Electrostatic.)

**ELECTRIC ELASTICITY**—In a dielectric material, the property which permits it to arrest passage of a displacement current (q.v.) due to electric stress. It is equivalent to the electric stress divided by the electric strain. (See Dielectric, also Displacement Current.)

**ELECTRIC FIELD**—The area surrounding an electrified body in which the electrical influence of that body can be measured or noticed. Also any area or region in which there is an electric force either steady or varying in intensity. For example, the dielectric or insulating surface of a condenser (material separating the plates) contains an electric field. Similarly, an electric field always surrounds a wire or other conductor carrying electric current. (See Field, Magnetic; Field, Electromagnetic; Field, Electrostatic; also Flux.)

**ELECTRIC INDUCTION**—The transfer of an electric state from a charged or electrified body to a non-electrified body without electrical contact. (See Induction.)

**ELECTRICITY**—The term given to an invisible form of energy. Electricity is not tangible to the human senses, but its effects can readily be detected. The phenomenon of electricity is regarded as due to the separation and independent movement of constituent parts of atoms—known as electrons. While electricity is really an intangible thing so far as the human perceptions are concerned, it is known to science not only through its effects or manifestations of energy, but has actually been reduced to quantities. The mass of electricity has been determined, as has also the rate of flow, etc. We have units which are used for the basis of all calculations in electricity. Thus, voltage is regarded as the propelling force; the quantity of electricity is given in coulombs, the current or rate of flow of electricity is given in amperes, etc. Each term for the various phases of electricity is based on a certain unit which represents definite values under given conditions. The universally accepted theory in chemistry is that all matter is made up of molecules, which in turn are composed of one or more atoms. These atoms now are regarded as comprising minute solar systems made up of positive and negative electrical particles. (For more complete explanation of the electron theory see Electron Theory; see also Magnetism, Current, Voltage.)

**ELECTRO-CHEMICAL CONDENSER**—See Electrolytic Condenser.

**ELECTRO-CHEMICAL EQUIVALENT**—The amount of a substance liberated by electrolytic action (electrolysis) by

the passage of one coulomb (q.v.) of electric current. It represents the weight in grams of each element of an electrolyte (q.v.) which is deposited by one coulomb of electricity. It has been determined that one coulomb will liberate .0001035 grams of hydrogen, which is therefore used as the electro-chemical equivalent of hydrogen. Electro-chemical equivalents are much used in applying the law of electrolysis. This law states that the amount (weight) of an ion liberated at an electrode each second during electrolysis is equal to the strength of the current (amperes) multiplied by the electro-chemical equivalent. The corresponding equivalents of other elements compared to hydrogen may be determined by multiplying the figure .0001035 by the atomic weight of the other element in grams and dividing the result by the valency (q.v.) of the element in question. (See Electrolysis, also Electrolyte.)

**ELECTRO-CHEMICAL SERIES**—A table of metals arranged in accordance with the potential they produce in a particular electrolytic solution.

**ELECTRO-CHEMISTRY**—The science dealing with chemical changes due to electricity or effected by means of electricity. (See Electrolysis, also Cell, and Storage Batteries.)

**ELECTRODE**—The conductor through which electric current enters or leaves an electrical device. That is to say the pole or terminal of the current carrying conductors separated by a medium through which electric current can flow from one to the other. The most common usage of the term is in referring to the positive and negative poles (q.v.) of a primary or storage cell. In the case of a dry cell, the two electrodes are the carbon rod or block in the center and the zinc container in most cases. In radio it is used to designate the filament and plate elements of a vacuum tube. The filament is termed the cathode, or negative electrode and the plate is the positive elec-

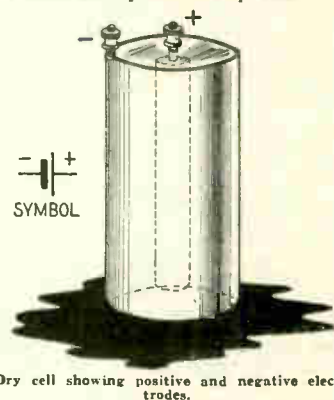

trode or anode. The illustration shows an ordinary dry cell or primary cell with the two electrodes designated as positive and negative. (See Anode, Cathode, Battery, Electrolysis, Positive Electrode and Negative Electrode.)

**ELECTRODYNAMIC**—Term used to denote electric currents or the forces exerted by one current upon another.

**ELECTRO-DYNAMICS**—A branch of the science of electricity dealing with electricity in motion; the study of the force exerted by electric currents upon each other. This branch of electricity was first accorded serious attention when the French scientist, A. M. Ampere (q.v.) announced the result of

his investigations in collaboration with D. F. J. Arago. Ampere stated in 1820 that *parallel conductors* through which electric currents were flowing in the same direction had a tendency to be attracted to each other and to be repelled when the currents were flowing in opposite directions. The subject is discussed under its various separate headings. (See *Ampere, Electricity, Magnetism.*)

**ELECTRO-DYNAMOMETER**—A device for measuring the *current and voltage* in a circuit; that is, the actual power in a circuit. It is a form of *wattmeter* (q.v.) designed to indicate the power in *watts*. It is of particular importance in measuring the power in *alternating current* circuits. In the case of *direct current*, the watts in the circuit are the product of the volts multiplied by the amperes, the result being the actual power. In the case of *alternating current*, however, the product of the volts and amperes is not necessarily, in fact, seldom, the true power or watts. Here we have the problem of true watts and apparent watts, or volt-amperes. If a voltmeter and an ammeter are connected in a circuit and read separately, the readings indicate the maximum voltage and the maximum current or amperage. The product of these two values is the power in watts in a direct current circuit. If the current is an alternating one, the true watts or actual power will be the product of the *instantaneous values* (q.v.) of voltage and current. Under certain conditions in a circuit carrying alternating currents, the current may lag behind or precede the voltage. In other words, the maximum value of

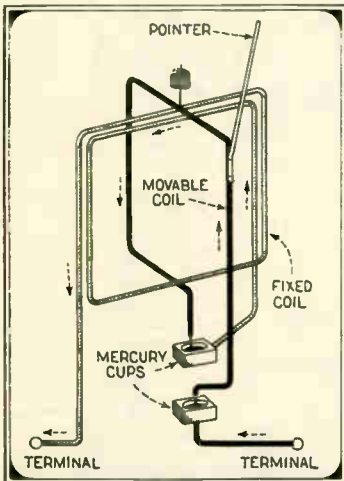

Electro-dynamometer with the current or moving coil shown by heavy lines and the stationary or voltage coil by light lines.

current is not reached at the same moment as the maximum value of the voltage. In this case the true watts can only be determined by obtaining the values of volts and amperes at the same instant, i.e., instantaneous values. The electro-dynamometer shown in the illustration gives the instantaneous values, or rather their product, and thus indicates the power or true watts. Here the heavy lines represent the current or moving coil and the light lines the stationary or voltage coil. (See *Dynamometer, also Wattmeter.*)

**ELECTROLINES**—A term advanced by Professor J. A. Fleming (q.v.) to designate the lines of electric force radiating

from an electron. These lines are pictured as analogous to long straight wires extending in all directions from the center of a small sphere. (See *Electron, also Electromagnetic Waves.*)

**ELECTROLYSIS**—The decomposition of a compound substance, generally a liquid, into its component parts by the action of an electric current passing through it. While electrolysis is an undesired effect in certain phases of electrical power work, causing composition of grounded structures, its application to radio is mainly in the case of cells for producing an *electromotive force* or to furnish current for lighting tubes. The constituent elements of a chemical compound such as used in a wet cell or any device using an electrolyte for the production of electric current, are known as *ions* (q.v.). These ions, which are separated during electrolysis, are of two kinds. The electro-positive ions are known as *cations*, and the electro-negative ions are known as *anions*. The electro-positive ions appear at the cathode or negative electrode during electrolysis and therefore are of positive origin. The electro-negative ions appear at the positive electrode and are therefore of negative origin. This is easily understood when the ions are considered as moving from the positive electrode or to the negative. Thus the ions appearing at the negative electrode must have come from the positive electrode and are therefore considered electro-positive in nature. The illustration shows the action of the ions in a typical *primary cell* (q.v.). The ions are considered

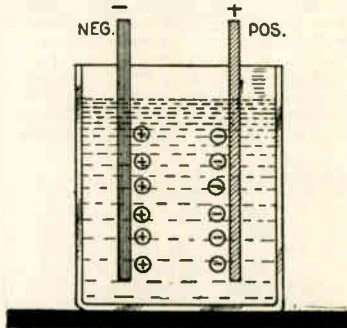

Illustration showing the action of ions in a primary cell.

as carrying the current through the electrolyte—each ion carrying a fixed charge of electricity of positive or negative nature. An ion is capable of carrying only a certain fixed charge of electricity and therefore any increase in the current will necessarily be accomplished by an increase in the number of ions. (See *Primary Cell, Electrolyte, Electrolytic Detector, Interrupter and Condenser.*)

**ELECTROLYTE**—The liquid decomposed during electrolysis, as the exciting fluid or solution in a wet cell or primary cell. The liquid used in any primary, secondary or electrolytic cell. (See *Cell, also Storage Battery.*)

**ELECTROLYTIC ACTION**—The decomposition of a chemical compound (electrolyte) into its constituent elements—ions, by the passage of an electric current through it. (See *Electrolysis, Ions, also Cell.*)

**ELECTROLYTIC BATTERY CHARGER**—A device for converting alternating current such as supplied for house lighting purposes, to direct current for the purpose of charging storage bat-

teries. Essentially one or more cells containing an electrolyte and two metal electrodes, generally lead and aluminum, so arranged that current can only pass in one direction, thus making it uni-directional and suitable for charging batteries. Such chargers are arranged to rectify either one-half of the alternating current cycle, or both halves of the wave. (See *Charger, Storage Battery, Electrolytic Rectifier, also Electrolytic Cell.*)

**ELECTROLYTIC CELL**—An arrangement of two *electrodes* in an electrolyte through which electric current can be passed to produce electrolysis. The electrolyte is decomposed or separated into ions by the action of the current, and at each of the electrodes one of the substances of which the electrolyte is composed accumulates. Such a cell is often used to measure electric current, as the amount of a substance deposited on the electrode depends directly on the amount of current passed through the electrolyte. (See *Electrolysis.*)

**ELECTROLYTIC CONDENSER**—A form of condenser making use of two electrodes placed in an electrolyte and used for alternating current circuits of high voltage and low frequency, low voltage and high frequency or high voltage and high frequency. The action of such an arrangement as a condenser depends on the fact that upon the passage of certain forms of alternating currents through it, a gas is formed around the electrodes, causing *polarization* (q.v.) and opposing the current. This polarization creates a very good insulating medium and a condenser of such nature can be made to have very high capacity. An electrolytic condenser may be used to prevent any sudden surge of pressure due to lightning or other causes. The polarization is instantaneous when any surge of voltage takes place and thus forms an automatic safety device which operates instantly and returns to its normal characteristics as a condenser as soon as the surge has passed. (See *Capacity, also Condenser.*)

**ELECTROLYTIC CONDUCTION**—The action in an electrolyte wherein the ions that have been separated carry positive and negative electric charges in opposite directions to the electrodes. (See *Electrolysis.*)

**ELECTROLYTIC DETECTOR** A device which converts high frequency currents into direct current pulsations

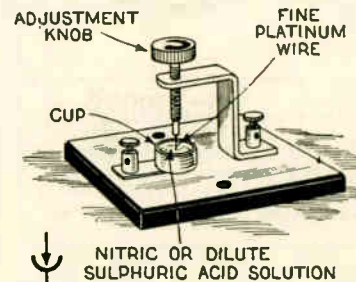

**SYMBOL**

Electrolytic detector originally used in place of a crystal detector for radio reception.

capable of operating a telephone receiver. It is an extremely sensitive detector of electromagnetic waves (radio signals). The illustration shows a simple form as originally used in place of the customary crystal detector. A fine platinum wire dips into a

cup of acid solution, generally either nitric or dilute sulphuric. The fine wire is lowered until it just touches the acid solution and must be very carefully adjusted as it has a tendency to curl up, its diameter being usually but one five thousandth of an inch or less. The high frequency currents can pass in only one direction through the detector which gives the rectifying action and makes the signals audible in the head phones. There are several theories regarding the action of an electrolytic detector, the most probable one being that the contact of the wire on the surface of the acid solution gives the effect of a very small electrolytic condenser. (q.v.) When the high frequency currents are passed through the detector there is a polarization action which causes high resistance to current in one direction but not in the other. (See *Detector*, also *Polarization*.)

**ELECTROLYTIC INTERRUPTER**—A device using electrodes immersed in an electrolyte for the purpose of interrupting or breaking up the flow of current. It is used mainly for induction coils for producing high voltages. The common form comprises a lead plate as a cathode or negative element and a platinum wire extending beyond a glass or porcelain tube in which it is tightly imbedded, both immersed in an electrolyte of dilute sulphuric acid. When current passes through, bubbles form on the platinum electrode causing temporary stoppage of the current. The bubbles are automatically dissipated and the current flows again, this operation occurring at rapid intervals and giving as many as 1000 interruptions per second. (See *Interrupter*, also *Induction Coil*.)

**ELECTROLYTIC RECTIFIER**—A device for changing alternating current into direct current by use of electrodes placed in an electrolytic solution. The action of such electrolytic cells or rectifiers is to permit current to pass only in one direction, thus suppressing one half of each cycle and producing a direct current. The illustration shows

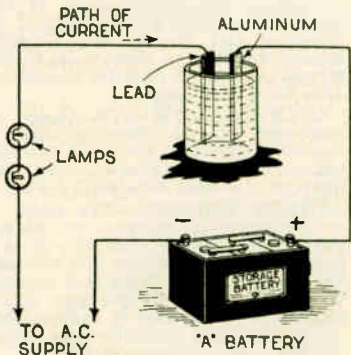

Customary method of electrolytic rectification.

one of the customary arrangements for electrolytic rectification, being an electrolytic cell with two electrodes, one being aluminum and the other a lead electrode. One or more lamps are placed in series or shunt in the circuit to permit the proper current flow. The positive pole of a storage battery is connected to the aluminum plate as shown and the lead electrode connects to the other side of the alternating current line and back to the negative side of the battery. At one instant current flows in the normal direction

through the battery, but when the current reverses and flows in the opposite direction through the electrolytic cell, oxygen is given off at the aluminum electrode and forms a thin film of aluminum oxide which acts as an insulator and prevents the passage of the current in that direction. Thus with one cell one half of each alternating current cycle is stopped or cut off when the aluminum electrode is made positive and the result is an intermittent direct current suitable for charging batteries. Such rectifiers are also used for supplying current to the filaments of vacuum tubes, or voltage to the plate members of the tubes, particularly for transmitting. (See *Electrolytic Rectifier Full Wave*, also *Balkite Battery Charger*.)

**ELECTROLYTIC RECTIFIER FULL WAVE**—This system is much used for charging storage batteries from an alternating current house lighting supply. Four cells are used in this instance. The electrolyte may be a solution of hydrochloric or sulphuric acid, or a saturated solution of sodium phosphate or bicarbonate of soda. Each cell has two electrodes, one iron or aluminum and the other lead. The positive pole of the storage battery is connected to the lead electrodes of two cells and the negative pole is connected to the aluminum electrodes of two cells. By this means both halves of the alternating current cycle are rectified to direct, pulsating current. This is known as *full wave rectification* (q.v.) (See *Charger, Storage Battery, Balkite Battery Charger*, also *Rectifier*.)

**ELECTRO-MAGNET**—A magnet using a curved or straight piece of soft iron or other magnetic material so arranged as to become magnetized by the passage of electric current through a coil of wire surrounding it. The illustration shows one of the commonest forms of electro-magnet. This type is used

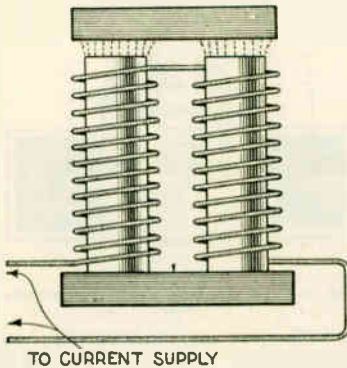

One of the common forms of electro-magnets.

in a bell or buzzer to draw down the vibrator bar and break the circuit. (For explanation of action see *Buzzer*.) When the current is withdrawn from an electro-magnet, the magnetic force or attraction ceases. Electro-magnets are used for a variety of purposes in radio, such as for test buzzers, head phones, relays, etc. (See *Magnet*, also *Magnetic Lines of Force*.)

**ELECTROMAGNETIC CONTROL**—The control of various switches and other apparatus by means of *electromagnets*, usually through an auxiliary contact at a distant point. (See *Remote Control*, also *Electromagnet*.)

**ELECTROMAGNETIC FIELD**—The space understood to be filled with elec-

tromagnetic lines of force. (See *Flux*, also *Lines of Force*.)

**ELECTROMAGNETIC FLUX**—The distribution of the lines of force through an electromagnetic field. (See *Flux*, also *Lines of Force*.)

**ELECTROMAGNETIC IMPULSE**—An impulse or electromagnetic disturbance conveyed to the ether from a conductor carrying high frequency currents. Another term for the electromagnetic waves involved in radio. (See *Electromagnetic Waves*.)

**ELECTROMAGNETIC INDUCTION**—The production of electric currents through a change in a magnetic field (q.v.). Its production is due to a change in the number of lines of force which are linked with a conducting circuit. The simplest example of this means of producing current is shown in the illustration. Here a conductor is arranged to be moved in the immediate vicinity of a magnet, causing a change in the number of lines of force that link the conductor and creating an induced current. This current will persist only so long as the conductor con-

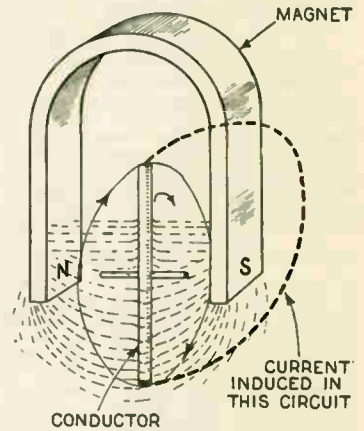

Simple method of producing electric currents by causing changes in the magnetic field.

tinues to be moved in the magnetic field. That is to say when there is no longer any change in the magnetic lines of force linking the conductor, there will be no current induced. The discovery of electromagnetic induction and formulation of its laws was primarily due to the scientist *Faraday* (q.v.). Faraday's law governing electromagnetic induction follows: "The induced electromotive force around any circuit is the rate of the decrease of the total flux of magnetic induction through the circuit." (See *Induction, Flux*, and *Lines of Force*.)

**ELECTROMAGNETIC INSTRUMENTS**—Electrical measuring instruments such as voltmeters, ammeters, etc., which depend for their action on the exertion of electromotive forces upon iron armatures. (See *Ammeter, Thermal*; also *Voltmeter*.)

**ELECTROMAGNETIC MICROPHONE**—A type of microphone in which the sound waves due to speech or music cause vibrations of a suspended coil in a magnetic field, inducing in the coil minute waves of electromotive force corresponding in form to the original sound waves. A form of microphone used in radiophone (broadcasting) transmission when purity of sound is an important consideration. Such a microphone requires that the induced

## Electromagnetic Radiation

currents be heavily amplified. (See *Microphone*, also *Speech Amplifier*.)

**ELECTROMAGNETIC RADIATION**—The propagation or radiation of electromagnetic waves through the ether. (See *Electromagnetic Waves*, also *Ether*.)

**ELECTROMAGNETIC ATTRACTION**—The attraction existing between unlike poles of electromagnets. This attraction is identical with that of two unlike poles of ordinary magnets. (See *Magnetic Attraction and Repulsion*.)

**ELECTROMAGNETIC REPULSION**—The tendency of two like poles of electromagnets to act against or repel each other. (See *Magnetic Attraction and Repulsion*.)

**ELECTROMAGNETIC SWITCH**—A switch for breaking electrical circuits by the action of an electromagnet. (See *Electromagnet*, also *Remote Control*.)

**ELECTROMAGNETIC THEORY OF LIGHT**—The theory and consequent scientific proof that radio waves and light waves are practically identical in nature. Light waves travel at a tremendous speed through the ether, approximately 186,000 miles per second, which is also understood to be the velocity of electromagnetic or radio waves. (See *Electromagnetic Waves*.)

**ELECTROMAGNETIC UNITS**—The fundamental or absolute units employed in electricity as a basis for calculations and on which the practical units are based. The effects of electricity, and hence electricity itself, can be measured in two ways. The first is the measurement of the quantity of electricity by the force it exerts upon another stationary quantity of electricity. This is known as the *electrostatic system*. The second is by measuring the force which a given quantity of electricity exerts upon a *magnetic pole* when flowing through a nearby conductor. This is referred to as the *electromagnetic system*. Fundamental or absolute units are derived from the fundamental units of *length, mass and time*. These units are the *centimeter of length, the gramme of mass and the second of time*. The term centimeter-gramme-second, referring to this system, is abbreviated C.G.S. system. The practical units of electricity are known as *volts, amperes*, etc., and are based on the absolute units. (See *Electrostatic Units, C.G.S. System, also Ampere, Erg, Dyne and Coulomb*.)

**ELECTROMAGNETIC WAVES**—The term applied to the energy radiated from an *antenna* in radio transmission. So called because it is understood to travel in the form of waves. One-half the energy of such a wave is electrical and the other half electromagnetic. *Electromagnetic waves* travel with the speed of light waves or approximately 186,000 miles per second. These waves are of extremely high frequency—that is, their direction changes many thousand times each second. This will be better understood by means of the illustration showing the arrangement of the electric and magnetic fields around a radiating antenna.

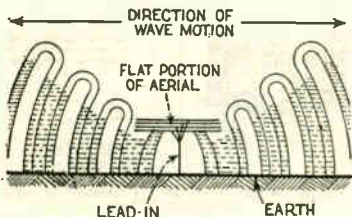

Illustration showing the arrangement of the electric and magnetic fields around a radiating antenna.

tion showing the arrangement of the electric and magnetic fields around a radiating antenna. Here the lines represent the electric field and the shaded portion the magnetic field. The lower loops or "feet" of these waves are assumed to pass over the surface of the earth which is a conductor. Thus when electromagnetic waves are being radiated from an antenna, circular distributions of electric charges are in the earth's surface around the antenna, these charges being alternately negative and positive, the bands of charge spreading out or radiating from the antenna in the manner shown in the illustration. These waves are subject to various influences which have a tendency to refract or reflect the waves much in the manner of light waves.

As these waves move out from the antenna they gradually increase in height, although the distance between the "feet," i.e., from one wave to another, remains the same. This distance is known as the *wave-length*. (See *Reception of Electromagnetic Waves*, also *Wave-length, Radiation Transmission*.)

**ELECTROMETER**—An instrument used for measuring potential differences (voltages) and, under certain conditions, power in *watts*. The operation of the instrument depends upon the attraction or repulsion of electrostatic charges and it may be used for either direct or alternating current measurements. (See *Voltmeter, Electrostatic*.)

**ELECTROMETRY**—The practice or science of electrical measurement. (See *Meter, Voltmeter*.)

**ELECTROMOTIVE FORCE**—Symbol  $E$  or  $\epsilon$ —abbreviation E.M.F. The force or electrical pressure which starts and maintains a current of electricity through a conductor. Electromotive force is commonly referred to in terms

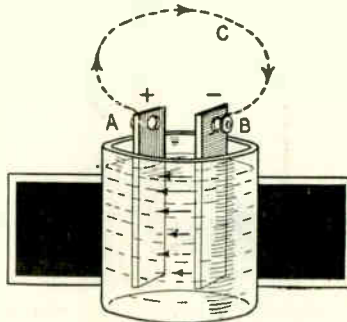

Fig. 1-A. A simple primary or electrolytic cell.

of volts and is abbreviated E.M.F. The electromotive force in electricity is analogous to the difference of level which produces pressure in pipes carrying water and forces the water to flow. Electromotive force is produced by a difference of potential, and this in turn sets up the flow of current. The illustration Fig. 1A shows a simple primary cell or electrolytic cell, and Fig. 1B is the analogous action of two tanks holding water, connected by a pipe and so arranged that the water level in one tank is higher than in the other, thus having a difference of level and creating pressure which makes the water flow. The water in tank A being at a higher level than in the other, the pressure causes the water to seek its common level and it flowed into tank B through the pipe. This flow continues as long as there is difference of level. In the case of the cell Fig. 1A there

are two electrodes, one of which is at a higher potential than the other. That is to say, one is in a state of higher

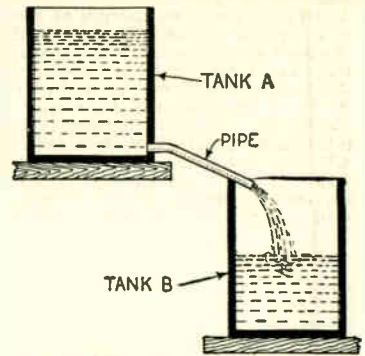

Fig. 1-B. Water in tank "A" seeks its level by discharging into tank "B" in a manner analogous to the flow of electric current where a potential difference exists.

electrification than the other, causing a difference of potential and producing an electromotive force. This force is in the direction from the point of greater potential to point of lesser potential as in the case of the water, and causes a flow of current in that direction. Here the flow is from B to A in the electrolytic solution and from A to B externally through the conductor C. Thus as long as there exists a difference of potential, current will flow in an attempt to equalize the potentials. (This statement holds true only under ideal conditions. See *Polarization*.) This flow of current in the illustration Fig. 1A is according to *Ohm's law* (q.v.), i.e., a difference of potential of one volt will cause one ampere to flow through the external circuit when the resistance of the circuit is one ohm. (See *Ampere, Ohm, Volt, Resistance*.)

**ELECTRON**—The smallest negative charge of electricity known. An English investigator, Dr. Johnstone Stoney, is credited with having named the electron, although it was so named by him in anticipation of its being isolated and measured. The actual proof of the earlier assumptions was due to Sir J. J. Thomson and others, who actually measured, and in all effect weighed, the minute particles of negative electricity. (See *Electron Theory*.)

**ELECTRON FLOW**—The theory of movement of free electrons along a conductor through which an electric current is flowing. (See *Electron*, also *Current, Assumed Direction of Flow*.)

**ELECTRON EMISSION**—The emission or discharge of electrons or minute particles of negative electricity from a heated body, particularly in a vacuum. The emission of electrons in a vacuum tube is the basis of operation of all vacuum tubes as used in radio. (See *Electron Theory*, also *Vacuum Tube, Theory of Operation*.)

**ELECTRON THEORY**—The assumption that the atoms of all substances contain one or more particles of negative electricity, which is of course paramount to saying that all matter is electricity. These particles are known as electrons, and while the assumption is referred to as a theory, it has been rather definitely proven by numerous experiments, and electrons have actually been measured. Under the electron theory it is assumed that the charge carried by a single electron is the smallest possible charge which can exist in nature and that no charge of electricity exists or can be produced which is not an integral mul-

multiple of this charge. (Note: This is merely a mathematical way of stating that any charge of electricity is equivalent to the combined charges of a certain number of electrons.) Probably the most accurate conclusion regarding the charge carried by an electron is due to experiments carried on by Prof. A. E. Millikan of the University of California. His measurements state this charge of a single electron as being  $4.77 \times 10^{-10}$  electrostatic unit, which is  $1.59 \times 10^{-10}$  of a coulomb (q.v.). While the mass or weight of an electron is said to vary with its velocity, assuming

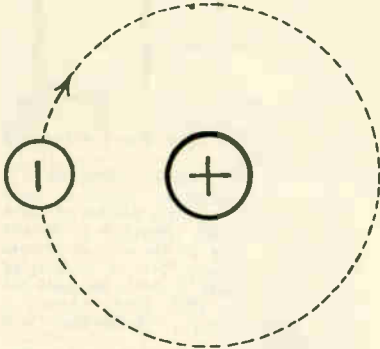

Illustration showing the electron, or negative particle, revolving around the proton or positive nucleus.

a velocity of less than one-tenth that of light, the mass will be  $8.9 \times 10^{-28}$  grams. This is approximately one seventeen hundredth of the weight or mass of an atom of hydrogen. For purposes of calculation the electron is assumed to be in the shape of a sphere. The radius has been estimated at approximately  $10^{-13}$  centimeter. When it is considered that a centimeter is somewhat less than half an inch it is readily seen that an electron is an infinitesimal affair.

The figures as to velocity of electrons vary somewhat with different authorities, but it is probably about 100 kilometers (approximately  $62\frac{1}{2}$  miles) per second at a temperature of zero degrees centigrade, the speed increasing as the temperature rises. Electrons may be understood as comprising minute solar systems of their own. In the illustration the electron or negative particle is shown revolving around the proton (q.v.) or positive nucleus in the manner of a planet revolving around the sun. This represents a normal atom of hydrogen, the simplest of all atoms, which, as shown, is composed of a single positive nucleus and a single electron revolving around it. In the case of an atom of helium there is a doubly charged positive nucleus, or proton, and two negative electrons revolving around it. Other atoms have as many as 92 electrons.

All vacuum tubes used in radio operate on the basis of the emission of electrons from a heated filament within the tube. These electrons are being emitted from the hot filament at all times during operation of the tube. When the incoming signals are such as to charge the grid negatively they are repelled and held back to the filament, thus offering no path for the signals. When the incoming signals have reversed their polarity, as they do thousands of times each second, the grid will be positively charged and the electrons will be aided in their travel to the plate, thus forming a conductive path for the currents. This, of course, re-

sults in the elimination of one-half of each cycle of the incoming currents or oscillations. That is to say, they are rectified to direct pulsating currents. (See *Amplifier, Vacuum Tube, Theory of Operation and Space Charge.*)

**ELECTRON RELAY**—A term occasionally applied to a three element tube (vacuum tube). This alternate term is obviously derived from the fact that the vacuum tube makes use of the path of electrons and in effect acts as a relay. (See *Electron.*)

**ELECTRON TUBE**—Any tube using a high vacuum and depending for operation on the emission of electrons from a heated cathode. (See *Electron*, also *Vacuum Tube.*)

**ELECTRONEGATIVE**—Having the property of being attracted to the positive pole of an electrolytic cell. The electronegative component. (See *Anion*, also *Cathion.*)

**ELECTROPOSITIVE**—Having the property of being attracted to the negative pole of an electrolytic cell during electrolysis. The electropositive component. (See *Anion*, also *Cathion.*)

**ELECTROSCOPE**—A device for detecting minute differences of potential (voltages). Such a machine will not measure the voltage but merely indicate its presence. The simplest form of electroscopes is shown in the illustration. Here a ball B, composed of the pith of some wood, preferably elder due to its extreme lightness, is suspended by a thin silk thread from an insulated stand. The object under in-

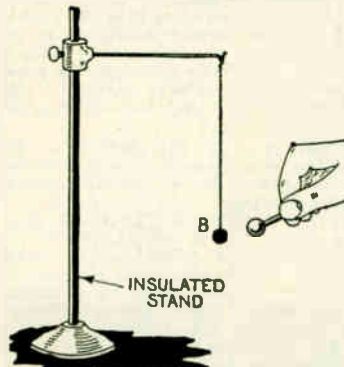

Simplest form of electroscope.

vestigation is moved near the pith ball, which will be repelled or attracted by the object if the object is in a state of electrification; but will remain motionless if no difference of potential exists. (See *Voltmeter, Potential, Difference of.*)

**ELECTROSE**—An insulating composition much used in electrical power work and for radio purposes. It has very high compressive strength, is hard and tough without being brittle, and is moisture, water and oil proof. Electro-se is used extensively for antenna insulation. (See *Insulator.*)

**ELECTROSTATIC**—The term used to designate EMF's (electromotive forces) or potentials, charges, etc., and the resultant forces. That is to say, electricity at rest or stationary in a body in order to distinguish it from the forces due to *electrodynamics* (q.v.).

**ELECTROSTATIC CAPACITY**—The amount of electricity which a condenser or similar body is capable of storing. If a condenser is capable of receiving and storing one coulomb of electricity

under a potential of one volt it is said to have an electrostatic capacity of one farad, which is the unit of electrostatic capacity. The electrostatic capacity of a condenser depends on several factors, mainly the size of the plates and the nature and thickness of the dielectric material (insulating sheets). (See *Capacity*, also *Condenser.*)

**ELECTROSTATIC CHARGE**—The presence of electricity in the form of electrostatic lines of force in a body such as a charged conductor. (See *Charge.*)

**ELECTROSTATIC COUPLING**—The association or coupling of circuits one to another by means of electrostatic action, i.e., condensers. Any capacitive association of one circuit with another. (See *Coupling.*)

**ELECTROSTATIC FIELD**—A region wherein forces are present and exerted due to the presence of electric charges. It is the area immediately surrounding a charged body. (See *Field, Electromagnetic*, also *Field, Electrostatic.*)

**ELECTROSTATIC FLUX**—Lines of force making up an electrostatic field. (See *Field, Flux*, also *Flux, Electrostatic.*)

**ELECTROSTATIC FLUX DENSITY**—The density or number of electrostatic lines of force in a unit area of an electrostatic field. (See *Electrostatic Field*, also *Flux Density.*)

**ELECTROSTATIC FORCE**—The force due to interaction of electric charges. (See *Electrostatic Field*, also *Electrostatic Flux Density.*)

**ELECTROSTATIC INDUCTION**—The production of a charge in a body due to the presence of an opposite charge in a nearby conductor, or synonymous with displacement in the case of a condenser. Electrostatic influence or induction is the basis on which condensers operate. In the illustration Fig. 1 is a simple circuit containing a source of potential, which in this case is a battery. As the circuit is closed through the key a momentary flow of current takes place. This flow of current is accompanied by a condition of electric strain in the insulating material of the condenser. The electrically strained dielectric or insulating material exerts a back pressure against the pressure or force of the battery, and when this back pressure is equal to the original battery pressure the flow ceases. The strain in this dielectric is known as *electric displacement* and this displacement can be transmitted or passed on to neighboring parts of the medium and thence into space. Under the proper conditions this displacement and the magnetic field which accompanies it may be detached from the circuit and move independently in space. This is the fundamental process in the radia-

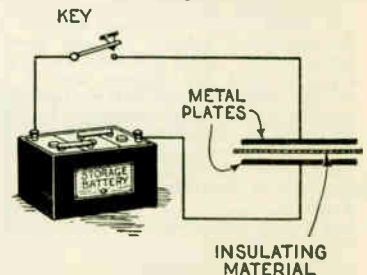

Fig. 1. A simple circuit for illustrating electrostatic induction.

tion of *electromagnetic waves* (q.v.). Now, in Fig. 2, A and B represent two conductors, both insulated. If conduc-

tor A has a positive charge and is brought close to conductor B, although not in actual contact with it, the result is a displacement of electric charge which results in the near side of conductor B becoming negative, while the opposite side assumes the same sign (positive) as conductor A. Actually B has received no charge, but has been placed in a state of strain due to electrostatic induction between it and the conductor A. Due to the negative charge induced on B, the positive potential difference of A has been decreased and in order to maintain the constant potential it must be given a further supply of electricity. In this manner it is actually possible to store the electricity by electrostatic induction between two conductors or plates,

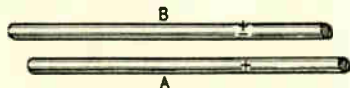

Fig. 2. Illustration of displacement of electric charge due to proximity of charged conductors.

by reason of the strain in the insulating medium—air in the case of the two conductors—which in turn passes the displacement on to conductor B. (See *Conductor, Capacity, Electrostatic, also Induction.*)

**ELECTROSTATIC LEAKAGE**—The gradual loss through leakage, of the electrostatic charge in a body, due to the fact that perfect insulation is impossible to obtain. (See *Electrostatic Induction.*)

**ELECTROSTATIC LINES OF FORCE**—The lines of force traversing an electrostatic field. That is to say the *electrostatic flux* (q.v.).

**ELECTROSTATIC STRAIN**—The strain or state of stress in which a body is placed when in an electrostatic field. In a condenser, the strain experienced by the *dielectric* (q.v.) when the condenser is in a state of charge. (See *Condenser, also Capacity, Electrostatic.*)

**ELECTROSTATIC SYSTEM**—The electrostatic system of C.G.S. units. One of the absolute unit systems in electrical practice. (See *C.G.S., also Electrostatic Units and Electromagnetic Units.*)

**ELECTROSTATIC UNITS**—A system of measurement used in electrical engineering based on the unit of electric quantity under the C.G.S. system (q.v.). This unit quantity of electricity is the quantity of electricity which, placed on a small sphere will repel an equal quantity of electricity of the same sign (both negative or both positive) on a similar sphere with a force of one *dyne* (q.v.) when the centers of the respective spheres are one centimeter apart. With this definition it is assumed that the spheres are in a vacuum, otherwise the distance between centers would vary according to the dielectric or insulating medium. (See *C.G.S., Electromagnetic Units, also Conversion Factors.*)

**ELECTROSTATIC VOLTMETER**—A meter for measuring voltage, depending for its action on the electrostatic action between a fixed and a moving plate connected respectively to the two poles or terminals between which the source of potential is connected. (See *Electrostatic Force, also Voltmeter.*)

**ELECTROSTATIC WATTMETER**—A type of wattmeter depending on the electrostatic action between two sets of

fixed and moving plates. (See *Electrostatic Force, also Wattmeter.*)

**ELECTRO-THERMAL METER**—The term sometimes applied to a *hot-wire ammeter* (q.v.) or voltmeter operating on the principle that the heat generated by the passage of an electric current through a constant resistance will be equal to the square of the current. (See *Thermal Ammeter.*)

**ELEMENT**—A term primarily applied in chemistry to the substances which are not subject to decomposition by electric analysis (see *Electrolysis*). These elements are hydrogen, helium, etc. The term is also used quite generally to denote components such as the electrodes in a primary cell or the plate, grid and filament members of a vacuum tube. (See *Cell, also Vacuum Tube.*)

**EMANATE**—"To flow forth or proceed, as from a source."—Webster. Thus, emanating, issuing from, as the emanation of electrons from a hot filament in a vacuum tube. The throwing off of electrons. (See *Electron Emission.*)

**E.M.F.**—The abbreviation for *electromotive force*. The practical unit of E.M.F. is the volt. (See *Electromotive Force, also Volt.*)

**EMISSION**—The act of sending forth. Used chiefly to designate the emission of electrons from the filament of a vacuum tube as used in radio. The flow of these electrons between filament and plate is controlled by the grid. (See *Electron Emission, also Vacuum Tube, Theory of Operation.*)

**EMISSION CURRENT**—In a vacuum tube for transmitting it is the product of the tube current multiplied by the plate voltage and is generally given in watts. Generally speaking, the power for which the tube is designed. (See *Transmitting Tube, Power Rating, also Vacuum Tubes.*)

**EMISSIVITY OF FILAMENT**—The ability of a filament to emit electrons when heated by an electric current. (See *Electron, also Vacuum Tube.*)

**EMPIRE CLOTH OR PAPER**—A closely woven cambric coated with two or more films of an oxidized oil, or a tough paper treated with some oxidized oil. Empire products serve as insulating materials for transformers, condensers and various other devices requiring thin insulating sheets. In a transformer for relatively high voltages, insulated paper is used between the layers of windings and in certain types of fixed condensers it is used as a dielectric material. The cloth has a higher breakdown strength; that is, it will stand higher voltages than paper. (See *Breakdown Potential, also Dielectric.*)

**ENAMELED WIRE**—Wire, generally copper, covered with a coating of enamel as an insulating covering and to protect it from moisture and corrosion. (See *Magnet Wire.*)

**ENDODYNE**—A term occasionally used to describe reception of radio signals by means of locally generated oscillations such as in the case of the *heterodyne* (q.v.), but wherein these oscillations are created by a circuit or system that is part of the receiving circuit and not a separate arrangement. (See *Self Heterodyne.*)

**ENERGY**—The capacity for doing work in an electrical sense. Energy is something furnished to a body by means of work done on it. Thus, if a ball is thrown, the operation of throwing is the work, and the ball itself in traveling performs work, the means of doing this work being the energy.

There are two kinds of energy, *potential*, as in the case of electricity, and *kinetic*, the energy of a body due to motion. Kinetic energy belongs properly in the realms of mechanics and so will be passed over here with only this brief mention.

When we speak of a difference of potential in a primary cell, it means in effect that the body or cell has potential energy. That is to say, the energy is present although not active. If, now, a wire is connected across the two terminals of the cell, the difference of potential will cause electric current to flow from one pole to the other. Actually, in a cell of this type, we have chemical energy stored up. When a circuit is completed, the stored chemical energy is converted into electrical energy or creates the difference of potential, which in turn causes current to flow and electrical work is thus done. (See *Potential, also Voltage and Generator.*)

**EPSTEIN HYSTERESIS TESTER**—A device for measuring *hysteresis* and *eddy current loss* in a sample of sheet iron by using an alternating current wattmeter. The device is used for determining the properties of samples of iron, particularly those to be used for transformers. (See *Eddy Currents, also Transformer, Hysteresis and Wattmeter.*)

**EQUIVALENT RESISTANCE**—The value which a resistance would be required to have in order to permit the same quantity of current to flow with the same applied electromotive force (voltage) as in the case of a piece of apparatus wherein there are other factors besides pure resistance to determine the amount of current. (See *Impedance, also Reactance.*)

**ERG**—The fundamental unit of mechanical work under the C.G.S. system (q.v.). This is defined as the work done by a force of one *dyne* (q.v.) when the body producing the force and the body on which the force acts are one centimeter apart. (See *Joule, also Practical Units.*)

**E.S.U.**—Abbreviation sometimes used for *electrostatic units* (q.v.). (See *Electromagnetic Units.*)

**ETHER**—or **AETHER**—The term used to denote the supposed or hypothetical medium by means of which electromagnetic and light waves are propagated. (See *Ether Waves.*)

**ETHER WAVES**—Term sometimes applied to electromagnetic or radio waves on account of the assumption that they travel through the supposed medium ether. The assumption of an all-pervading medium such as ether has been the basis of the major part of the extensive research work carried on with light and electromagnetic waves for many years. Various experiments have shown beyond reasonable doubt that there is some such medium, capable of conducting or rather permitting passage of light waves and radio waves. So accurate has this work been that it has been proven beyond question that light waves travel through the ether with the tremendous velocity of 186,000 miles per second (approximately). It has also been determined that radio waves travel at this same speed through the ether. It has further been proven that radio waves all travel at the same identical velocity, regardless of their length, form and other factors. (See *Electromagnetic Waves, also Theory of Propagation of Electromagnetic Waves.*)

**EXCITER**—A small direct current dy-

name used for the purpose of exciting the field magnets of an alternating current generator. Such a device is generally a part of the main machine and mounted on the main shaft, but it

may also be a separate unit. The purpose is to furnish current to the field magnets (electromagnets) to create a magnetic flux. (See *Alternator*, also *Generator*.)

**EXPLORING COIL**—A coil of insulated wire wound on a rotating form as an integral part of a direction finder or goniometer. (See *Direction Finder*, also *Goniometer*.)

## F

**F**—The abbreviation for *dielectric field intensity* (see *Field*, also *Dielectric*), also used as the symbol for the unit of *magneto-motive force*, the *gilbert* (q.v.). The small or lower case *f* is sometimes used to denote the *farad*, the practical unit of *electrostatic capacity* (q.v.) and also as a symbol for *frequency* (q.v.).

**FADING**—The tendency of radio signals to decrease in volume or amplitude, or to fade. The strength of a signal is seldom the same at different hours of the day or night, generally being stronger during the dark hours of the night. This has been attributed to a variety of causes, the most plausible being that the air is more free of disturbances during the night and thus permits more ready passage of the waves through the ether. The difference between the strength of signals in the daytime and at night is sometimes very pronounced, but the phenomenon of fading is usually noticed only when distant signals are being received. It has been fairly definitely established that fading of signals is due to the reflection of the transmitted waves. (See *Wave Distortion*, also *Reflection and Refraction*.)

**FALL OF POTENTIAL**—See *Potential Drop*.

**FAN AERIAL**—An aerial, usually for transmission, constructed in the shape of a fan. (See *Aerial*.)

**FAN CONNECTOR**—A small triangular or fan-shaped piece of metal arranged with several holes along one edge, with set screws for fastening in each the several wires of the lead-in of a multi-wire aerial. The lower apex is fitted with some sort of connecting device to permit a single wire to be led in to the receiver. (See *Lead-in*.)



Illustration by  
Courtesy of Radio Specialty Co., Inc.

**Fan Connector**—The leads from each wire of a multi-wire aerial go to the wide portion and are held by the set screws; the lead to the set goes to the small end.

**FARAD**—The unit of *electrostatic capacity*. It is the practical unit of capacity and is defined as the capacity of a condenser that is capable of being charged to a potential difference of one volt by a charge of one ampere for one second; i.e., one *coulomb* (q.v.). "Farad" is a contraction of the name of the distinguished English scientist *Michael Faraday* (q.v.). Inasmuch as the farad is too large a unit for practical purposes, the *micro-farad*, or one millionth of a farad, is commonly used. (See *Electrostatic Capacity*, also *Condenser*.)

**FARADAY, MICHAEL**. Born 1791, died 1867. An English scientist famous for his discoveries in chemistry, electricity and magnetism. He first produced the rotation of the magnetic needle around the electric current in 1821, based upon Oersted's discovery of electromagnetism in 1820; he discovered electromagnetic induction (1831), a principle upon which is founded the development of dynamo machinery; specific inductive capacity (1838); magnetic polarization of light (1845); diamagnetism (1846). He was a brilliant experimenter, and contributed greatly to the knowledge upon which is based present-day practice of electricity.



Michael Faraday.

**FEEBLY DAMPED**—In spark transmission, signals that are only slightly damped. Where each succeeding oscillation in a train of oscillations is of slightly lesser *amplitude* (q.v.) than the one preceding it, the signals are said to be slightly damped to distinguish them from signals that are highly damped and thus die out quickly. (See *Damping*, also *Damped Waves*.)

**FEED**—In electrical parlance, to furnish with a current of electricity. (See *Feed-Back*.)

**FEED-BACK**—A term applied in radio to the coupling of one circuit to another, whereby a portion of the current present in one circuit is fed back or returned to the other circuit. The common use of the term is in reference to regeneration, where a certain portion of the radio frequency current present in the plate circuit of a detector is returned to the grid circuit of the tube by some form of coupling between the two circuits. It may also apply to the tendency of high-frequency currents to become transferred from one circuit to another due to undesired coupling between two or more circuits. The illustration shows a simple feed-back or regenerative circuit. The incoming signal energy is transferred from the

primary of the coupler to the secondary by means of inductive coupling and tuned by the condenser C. A grid con-

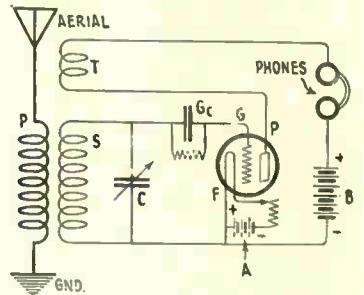

Regenerative circuit in which the coil "T" returns, or "feeds back" to the grid circuit a portion of the radio frequency current in the plate circuit, resulting in increased amplification.

denser and leak GC are placed in the grid circuit in the customary manner. A feed-back or reaction coil T is placed in the plate circuit and inductively coupled to the main coil. A portion of the radio frequency current in the plate circuit or output circuit is transferred back to the grid circuit by the coupling effect between the coil T and the secondary of the coupler. This serves in effect to reduce the resistance of the grid circuit and produces more current in the output or plate circuit, thus acting as a form of amplifier. (See *Regeneration*, *Tickler*.)

**FEED-BACK COIL**—An inductance coil placed in the plate circuit of a regenerative receiver and arranged in inductive relation to the grid coil (secondary of tuner) for the purpose of effecting feed-back or regeneration. (See *Feed-Back*, also *Regeneration*.)

**FEED-BACK COUPLING**—Any process by which the plate circuit of a detector is coupled to the grid circuit to allow a portion of the output current to be transferred back to the grid circuit to produce regeneration. (See *Feed-Back*, also *Regeneration*.)

**FEED-BACK EFFECT**—The effect of feeding back of currents from one circuit to another as in the case of a *regenerative circuit* (q.v.). Generally the expression "feed-back effect" refers to an undesired feed-back. This may be the action of radio frequency components of the currents present in one part of a circuit being fed back to another part of the circuit due to the coupling effect of various coils or other devices used in the circuit. (See *Feed-Back*, also *Regeneration*.)

**FEED-VOLTAGE MODULATION**—A process of modulating or varying the amplitude of a radio frequency alternating current to correspond to any wave form of speech vibrations as in radio broadcasting. The system involves the introduction of additional power into the circuit of the radio frequency generator until the desired wave form variations are obtained. This is done particularly in the case of a vacuum tube transmitter, in which case the voltage supplied to the plate of the

## Ferro-Magnetic Modulator

tube is altered (increased or decreased) to accomplish the purpose. (See *Modulation*.)

**FERRO-MAGNETIC MODULATOR**—A device for modulating or varying the amplitude of radio frequency current to correspond in wave form to the speech or music vibrations in broadcasting. The system makes use of what is known as the *hysteretic energy absorption* of iron, or in some cases utilizes the variation of inductance of iron-core coils. (See *Modulation*, also *Ferro-magnetic Substances*.)

**FERRO-MAGNETIC SUBSTANCES** — Elements or compounds such as iron, nickel, cobalt and others which are strongly attracted by magnetic fields of force. Such substances vary widely in their magnetic properties when subjected to temperature changes. Soft iron loses its magnetization almost immediately on removal of the magnetizing source, and for this reason it is used as a pole piece in an electromagnet. (See *Electromagnet*, also *Magnetism and Magnetic Properties*.)

**FESSENDEN, REGINALD AUBREY.** —Canadian-American Radio expert. Born at Milton, Canada, October 6, 1866, and educated at New York and Port Hope, Ontario. Fessenden became inspecting engineer for the Edison Company, New York, and afterwards professor of physics and electrical engineering at Western University, 1892. Professor Fessenden is the author of a well-known system of wireless, and below are briefly described some of the patents bearing his name.

In 1906 and 1907 Fessenden invented a number of microphone transmitters which carried heavy currents for long periods, and also a heavy current telephone relay which allowed the controlling of heavy currents by means of small currents originating in an ordinary microphone circuit or coming from a telephone line. One of these transmitters was called by Fessenden a trough transmitter. It consisted of a soapstone annulus to which were clamped two plates having platinum-iridium electrodes. Through a hole in the center of one plate passed a rod attached at one end to a diaphragm,



Reginald Aubrey Fessenden.

and at the other to a platinum-iridium spade. The two outside electrodes were water-jacketed. This form of transmitter required no adjusting, all that was necessary being to place about a

teaspoonful of carbon granules in the center space. It was able to carry as much as 15 amperes continuously without articulation falling off, and had the advantage that it never packed. By a combination of the trough transmitter and a differential magnetic relay, Fessenden produced a transmitting relay for magnifying very feeble currents. An amplification of fifteen times is possible without any loss of distinctness. Fessenden is also responsible for a duplex system of Radio telephony, and the *heterodyne* method of reception is due to him. Fessenden has written largely on radio subjects, and is one of the leading authorities on both transmission and reception.

**FIBER—OR FIBRE**—A term used for a variety of substances, composed of fine slender thread-like materials, particularly a composition of vulcanized or compressed paper. It is much used in radio as an insulating material for panels and connection blocks. It is not as efficient as insulating medium as bakelite or some forms of rubber composition, but is durable, cheap and comparatively easy to drill. (See *Bakelite*.)

**FIELD**—The space occupied by electric or magnetic lines of force. (See *Electric Field*.)

**FIELD DENSITY**—The strength of an electric or magnetic field. It is measured by the number of electric or magnetic lines of force contained in a given cross-sectional area. (See *Density*, *Flux*, also *Electric Field* and *Field, Magnetic*.)

**FIELD, ELECTRIC**—The space traversed or occupied by electric lines of force. (See *Electric Field*.)

**FIELD, ELECTROMAGNETIC** — The total area traversed by electromagnetic lines of force. The region in which electromagnetic lines of force are exerted. (See *Field*, also *Electrostatic Force*.)

**FIELD, ELECTROSTATIC**—The region in which electrostatic forces are present or exerted. The total area traversed by electrostatic lines of force. (See *Field*, also *Electrostatic Flux*.)

**FIELD MAGNET** — An *electromagnet*, usually a core of soft iron surrounded by a winding of insulated wire, employed in generating machines to produce a strong magnetic field. As the *armature* of a generator revolves the conducting surfaces pass through the magnetic field created by the field magnets. This field may be merely the ordinary magnetic force due to permanent magnets, but is usually due to the powerful magnetic lines of force resulting from passage of electric current through electromagnets. (See *Alternator*, also *Alternating Current*, *Theory of Production and Electromagnet*.)

**FIELD, MAGNETIC**—The region through which magnetic flux passes. Usually refers to the space (air) through which the magnetic flux lines pass as distinguished from the activity in the iron path itself. (See *Field*, also *Magnetic Flux*.)

**FIELD REGULATOR or RHEOSTAT**—Any device for varying the magnetic strength of the field magnets in a dynamo or electric motor, by which variations certain changes may be accomplished in the operation or performance of the machine. A field rheostat is often used in an electric motor to vary the strength of the field and thus either increase or decrease the speed of the machine without the necessity of changing the applied volt-

age. If the strength of the field (magnetic) is reduced by insertion of resistance, the armature or rotating part speeds up in an attempt to generate the same *counter-electromotive force* (q.v.), which means greater speed. On the other hand, if the resistance is

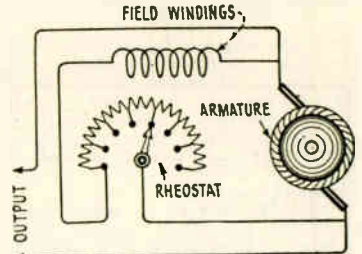
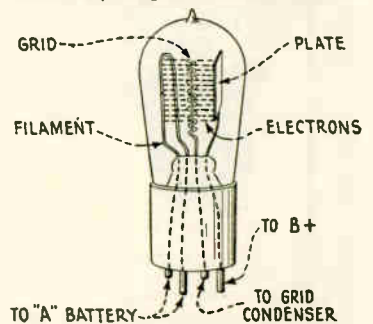

Illustration showing method of connecting a field rheostat or regulator in the circuit of a shunt wound generator.

removed—that is, the strength of the field increased—the fact that the armature is running through a stronger field reduces the speed of rotation, the same counter-electromotive force being present. The use of a field regulator or rheostat in connection with a generator is for the purpose of varying the output voltage without the necessity of altering the speed of the machine. The illustration shows the connection of a field rheostat or regulator in the circuit of the *shunt wound generator* (q.v.). (See *Generator*, *Rheostat*, *Resistance*.)

**FILAMENT**—A fine wire, one of the elements of a vacuum tube, which is heated to throw off electrons. The term is also used to refer to the fine wire used in an incandescent lamp. The filament of a vacuum tube is generally made of tungsten and is supported by glass pillars within the tube in such manner as to be insulated from the other elements. Filaments are made to be heated with various voltages from 1.1 to 6 volts in most receiving tubes, but much higher in the case of high power transmitting tubes. The filament may consume considerable current as in the old styles of six-volt tubes which consumed one ampere. The modern tubes have thoriated filaments, tungsten treated with tho-



When an "A" battery is connected to the filament terminals, heating the filament, electrons are thrown off and fill the space between filament, grid and plate.

rium, which permits maximum efficiency with a minimum of current consumption. When the filament is heated in the vacuum tube, by having the proper amount of voltage applied, electrons are thrown off and fill the space between filament and grid and plate as shown in the illustration. (See *Electron Theory*, also *Vacuum Tube*, *Theory of Operation*.)



**FILAMENT BATTERY**—The battery or cell used in lighting the filament of a vacuum tube. These range from a dry battery (q.v.) having a voltage of one and a half volts, to storage batteries of six volts. Filament batteries are connected across the filament of a

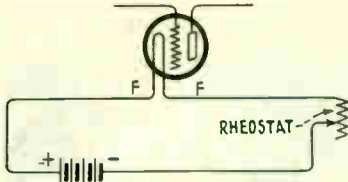

Method of connecting "A" battery in series with rheostat to regulate filament of vacuum tube.

vacuum tube in the manner shown in the illustration. The rheostat is inserted to permit the supply of current to the filament to be varied and thus change the operation of the tube. (See *Filament*, also *Vacuum Tube, Theory of Operation*.)

**FILAMENT CONSUMPTION** — The amount of current consumed by the filament of a vacuum tube. The current requirements of vacuum tubes are

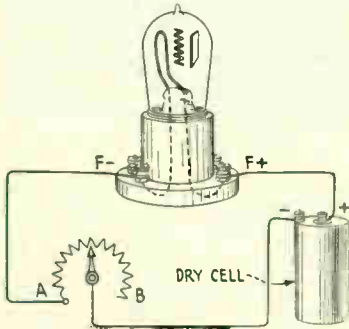

The current produced by the dry cell battery, flowing through the rheostat and filament, is consumed by the filament, at a rate depending upon the type of tube.

always stated by the manufacturer, either in amperes or fractional amperes, or in the case of extremely low consumption, in thousandths of an ampere (milliamperes). Some typical examples are the UV201A and C201A types, which require one-quarter ampere at five volts; the WD11 and 12 and C11 and 12 types, which require one-quarter ampere at approximately 1.1 volts, and the UV200 and C200 tubes, which require one ampere at six volts. Of the so-called standard types, the UV199 and C199 tubes consume the least current, requiring but sixty milliamperes or .06 ampere, with from three to four and a half volts. The statement that a certain tube consumes one-quarter ampere indicates that in operation one-quarter ampere is consumed each hour, this current being supplied by dry cells or storage batteries known as the "A" battery (q.v.).

It will be apparent from the above that the more current consumed by the filament the greater will be the drain on the dry cells or storage battery. For this reason, and also to lengthen the life of the filaments, it is well to operate the tubes at the lowest efficient brilliancy. The brilliancy of the filament may be controlled by adjustment of the filament rheostat. In the illustration the usual "A" battery, which in this case is a dry cell, is shown connected to the filament of a vacuum

tube with a rheostat in series between one filament connection and the negative terminal of the dry cell. Now as the arm of the rheostat is moved from A toward B resistance is introduced into the circuit between the filament and dry cell. As this resistance increases the current in the circuit of the filament will decrease according to *Ohm's Law* (q.v.); i.e.,  $\text{Current} = \frac{\text{Voltage}}{\text{Resistance}}$ , the current in amperes or fractional amperes and the resistance in ohms. (See *Ampere, Current, Filament Resistance or Rheostat and Vacuum Tube*.)

**FILAMENT CURRENT**—The current used to light the filament of a vacuum tube. Different tubes require different amounts of current; that is, one tube may consume a small fraction of an ampere and another may require a full ampere. Of the tubes most commonly used, the UV199 type uses the least current, this tube requiring only .06 of an ampere each hour. The WD11 and 12 types require one-quarter ampere per hour and also the UV201A, while the now obsolete UV200 and UV201 required a full ampere. The 199 type operates with filament voltage of 3 volts, although it is often used with three dry cells in series which deliver  $4\frac{1}{2}$  volts; the WD11 and 12 require 1.1 volts each, which is usually furnished by a dry cell, while the UV201A type is operated with a six-volt storage battery. (See *Vacuum Tubes, Types of*, also *Vacuum Tube, Theory of Operation*.)

**FILAMENT FORMULA FOR ELECTRON FLOW**—The extent of electron emission—that is, the number of electrons—emitted from a hot filament in a vacuum tube is subject to certain definite laws. In ordinary practice the actual number of electrons are not referred to, the ability of the filament to emit electrons being measured in fractional amperes of output current. Thus a tungsten filament having a diameter of .0125 centimeters operating with a power dissipation of 3.1 watts per centimeter of length has been found to emit a current of .03 amperes. This result was obtained with a filament having a clean surface and with no absorbed gas on its surface. The formula for electron flow most commonly used is as follows:

$$I_b = .1T^{\frac{1}{2}} \epsilon \frac{b}{T}$$

$I_b$  is the electron current in milliamperes per square centimeter of filament surface,  $T$  is the absolute temperature and  $A$  and  $b$  depend on the metal used for the filament.

**FILAMENT RESISTANCE or RHEOSTAT**—A device placed in the filament circuit of a vacuum tube, connected between the filament battery and either filament lead on the tube socket for the purpose of reducing or controlling the filament voltage. The illustration Fig. 1 shows one type of



Illustration by Courtesy of The Cutler-Hammer Mfg. Co. Fig. 1. A type of rheostat used to control the flow of current to the filament of a vacuum tube.

filament rheostat which is used to permit variation of the filament current. Fig. 2 shows the manner of connecting such resistance in the filament circuit of a vacuum tube. Fig. 3 illustrates a type of filament control known as an automatic rheostat. In this form of filament resistance a fine wire is placed in a glass tube filled with an inert gas. The wire has the property of increasing its resistance rapidly with any increase in

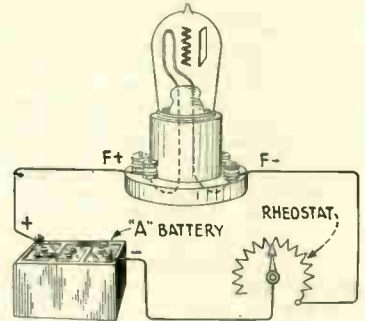

Fig. 2. Showing method of connecting a rheostat in "A" battery circuit of a vacuum tube.

the current passing through it. It is thus possible to arrange such a device to pass only a fixed amount of current for any type of vacuum tube. The device is thus not only an automatic rheostat, but also a safety valve which



Illustration by Courtesy of the Radiall Co. Fig. 3. A type of automatic rheostat.

prevents excessive current reaching the filament and injuring it. These controls are coming into widespread use due to these features and the fact that they reduce the number of controls necessary to operate a receiver. Fig. 4 shows a resistance which is used in series with a rheostat having small resistance in order to enable its use



Illustration by Courtesy of The Cutler-Hammer Mfg. Co. Fig. 4. Resistance used in series with a rheostat having a small resistance in order to enable its use with tubes requiring less current.

with tubes requiring less current to operate. (See *Filament*, also *Vacuum Tube*.)

**FILAMENT, THORIATED**—A filament or heating element of a vacuum tube in which a certain amount of *thorium* (q.v.) has been incorporated. The introduction of this rare metal into the filament in small quantities gives it the property of emitting electrons at a relatively low temperature. From a practical standpoint this permits a vacuum tube to be operated with a low filament consumption (q.v.). A common example of the use of thorium in filaments is that of the UV201A or C201A vacuum tubes, which operate with a filament voltage of 5 volts and

consume but one-quarter ampere of current, giving essentially the same results as the former type UV201 and C201 tubes which consumed one ampere. The value of thorium used in this manner is readily appreciated, the current consumption being materially lessened and the life of the tube conceivably lengthened. (See *Thorium Treatment of Filaments*, also *Vacuum Tubes*, Type UV201A and C201A.)

**FILTER**—In radio, a device arranged to permit passage through an electrical circuit of currents of certain frequency or frequencies (q.v.) while excluding others of different frequencies, or any device for producing smooth direct current from a generating source such as a *direct current dynamo*, or for smoothing out *rectified direct current*. Filters of one sort or another are much used where rectified direct current or direct current from a generator is to be used for operation of tubes in radio trans-

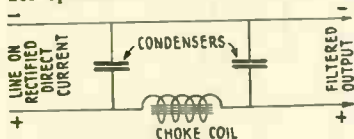

Conventional method of filtering rectified direct current for use as plate supply of a vacuum tube.

mission or reception. In the case of rectified direct current, that is the current derived from any device for changing alternating to direct current, there is always present a tendency on the part of the current to surge or ripple. In other words, it is not smooth and of constant voltage, or there may be present a generator hum which will seriously interfere with proper operation of a tube. The illustration shows the conventional method of filtering rectified direct current for use as plate supply with vacuum tubes in receiving sets. This system may also be used in connection with the output of a direct current generator or dynamo. A filter circuit may be arranged to pass a band of frequencies (see *Band Pass Filter*) or it may be made to pass either high or low frequency current. (See *Filter*, *High Pass*; also *Filter*, *Low Pass*.)

**FILTER, BAND PASS**—See *Band Pass Filter*.

**FILTER CONDENSER**—The condenser, either fixed or variable, forming a part of a circuit for filtering. (See *Filter*, also *Acceptor*, *Wave Trap* and *Rejector*.)

**FILTER, HIGH PASS**—A filter circuit arranged to permit current above a certain frequency to pass freely while blocking out or attenuating all frequencies below it. (See *Filter*, also *Filter*, *Low Pass*.)

**FILTER, LOW PASS**—A filter circuit arranged to permit currents below a certain frequency to pass freely while blocking currents of higher frequency. (See *Band of Frequencies*, also *Filter*, *High Pass*.)

**FIXED COILS**—Inductance coils as used in radio circuits, having no mechanical means of variation, such as in a *Vario-coupler* or *movable coil*. (q.v.) The majority of tuned radio frequency receivers employ fixed coils, shunted by variable condensers. These are known as *tuned radio frequency transformers*. (q.v.) (See *Coupler*, *Loose*, also *Coupler*, *Vario*.)

**FIXED CONDENSER**—A condenser having a certain definite or fixed value of capacity. Any condenser that is not

variable. (See *Condenser*, also *Condenser*, *Variable*.)

**FIXED RESISTANCE**—Any resistance device having a fixed or non-variable value. (See *Rheostat*, also *Potentiometer*.)

**FIXED DISCHARGER**—A fixed *spark gap*. (q.v.) A spark gap used in transmission of radiotelegraphic signals in which the electrodes or sparking surfaces are not moved during operation. (See *Disc Discharger*.)

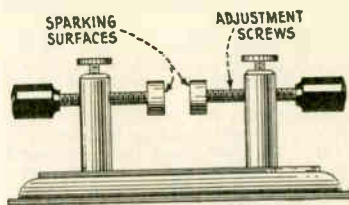

A type of fixed spark gap.

**FLAME MICROPHONE**—A type of microphone for radio telephone transmission, wherein the height of a coal gas flame is varied by and according to the speech fluctuations and the resulting pulsations made audible by means of a selenium cell and phones. (See *Microphone*, also *Selenium Cell*.)

**FLASH SIGNALLING**—See *Code*, also *Morse Light*.

**FLAT-TOP AERIAL or ANTENNA**—An aerial, generally composed of a number of wires placed adjacent to each other equally spaced on a spreader, or hoop, and suspended parallel with the earth. A flat-top aerial may be of the kind known as the *T type aerial* (q.v.) or in the form of an inverted *L*. (See *Aerial*.)

**FLAT TUNING**—A term sometimes applied where the *resonance curve* (q.v.) has a flat top, that is where the peak of resonance is not sharply defined. The effect is known as *broad tuning*. (q.v.) (See *Resonance*, also *Tuning*.)

**FLEMING, JOHN AMBROSE**. British radio expert. Born in Lancaster, November 29, 1849, he was educated at University College, London, the Royal School of Mines, and St. John's College, Cambridge.

From 1873-74 Fleming was demonstrator at the Royal College of Chemistry, and in 1877 he began work under Clerk-Maxwell at the Cavendish Laboratory, Cambridge. There he carried out a series of experimental researches on the British Association Standards of Electrical Resistance. In 1881 Dr. Fleming was appointed the first professor of mathematics and physics at University College, Nottingham, but the following year he joined the Edison Electric Light Company, and on the amalgamation of the Edison and Swan Companies, he was appointed advising electrician, a post he held for twenty years. In 1885 Fleming was appointed to the newly founded professorship of electrical engineering at University College, London, and he was entirely responsible for the design and equipment of the new electrical and engineering laboratories which were opened in 1893. In 1892 he was elected Fellow of the Royal Society.

Dr. Fleming has been very closely associated for many years with radio telegraphy and telephony, and has since 1899 acted as the scientific advisor to Marconi's Wireless Telegraph Company. He is well known as the inventor of the thermionic two electrode vacuum tube, or glow-lamp detector,

which was one of the greatest steps forward in radio telephony.

Dr. Fleming has written a very large number of papers and books on wireless telegraphy and telephony, and his "Principles of Electric Wave Telegraphy" is the standard treatise on the subject. He has also published an "Elementary Manual of Radio Tele-



John Ambrose Fleming.

graphy and Radiotelephony"; "The Wonders of Wireless Telegraphy"; "The Thermionic Valve and Its Development"; "A Pocket Book for Wireless Telegraphists," and other books. As a lecturer at the Royal Society of Arts he has obtained a world-wide reputation for his lectures on electric oscillations and electric waves, Hertzian wave telegraphy, high-frequency measurements, etc. He has given many lectures on wireless at the Royal Institution.

Fleming was awarded the Hughes gold medal of the Royal Society in 1910 as an acknowledgement of the value of his work in electrical science and engineering, and he has twice been awarded the Institution Premium of the Institution of Electrical Engineers, the highest award for communicated papers, and he is an Albert Gold Medalist of the Royal Society of Arts awarded to him for the pioneer invention of the thermionic valve.

**FLEMING'S RULE**—A rule for determining the direction of the *induced current* (q.v.) in a circuit. Hold the right

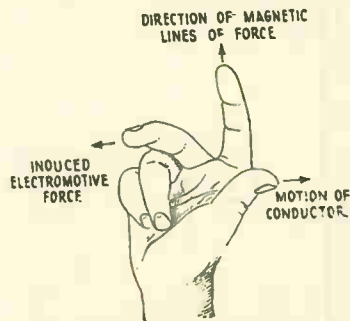

Method of using the right hand in determining the direction of the induced current.

hand as shown in the illustration with the thumb, forefinger and middle finger as nearly as possible at right angles to each other. If the thumb is then pointing in the direction of motion of the conductor and the forefinger points along the direction of the magnetic lines of force, the middle finger will then point in the direction of the induced electromotive force. (See *Induced Current*, also *Electromotive Force*.)

**FLEMING VALVE**—The forerunner of the modern vacuum tube. It was invented in 1904 by Professor J. A. Fleming and was for a short time used as a detector in place of the customary crystal or coherer types. The value of the discovery of the Fleming valve lies chiefly in its influence on the course of radio development, as in itself it was not nearly as efficient as a good crystal detector. As a result of the discovery of the Fleming valve, however, many leading scientists bent their efforts toward the discovery of better methods of detecting radio waves, culminating in the three element vacuum tube designed by Dr. Lee De Forest.

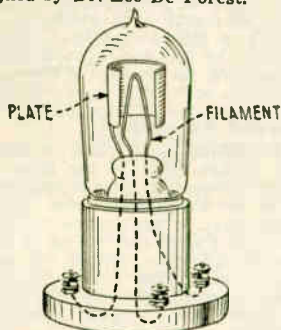

Fig. 1. The Fleming valve, which contained but two elements; i. e., filament and plate. It was the forerunner of the modern vacuum tube.

The Fleming valve consists essentially of an incandescent lamp using a filament of carbon, tungsten or tantalum which can be rendered incandescent by an electric current. The filament is sealed in a glass tube which is highly evacuated, that is from which practically all air has been excluded. Surrounding the filament, but separated from it is a metal cylinder, both ends of the filament and the plate being attached to outside connections by means of leads sealed in the tube. The illustration, Fig. 1, shows the general arrangement of such a tube. The operation of the tube is due to the emission of electrons from the heated filament. It was demonstrated by several investigators that a filament made of certain metals has the property of throwing off minute particles of negative electricity or electrons when heated to a relatively high temperature. It was also found (see *Electron*) that these electrons are thrown off in greater profusion when the filament is placed in high vacuum. It was also found that the escape of negative electrons from the filament would in time leave it positively charged, this charge having an attraction for the negative electrons and preventing their escape from the filament. Hence it was necessary to apply a charge of negative electricity to the filament. The electrons were now found to escape in great number, but had the effect of forming a *space charge* (q.v.) of negative electricity around the filament, which in time served to repel the escape of any more electrons. To counteract this tendency a strong positive charge

was applied to the metal plate surrounding the filament. This made the plate positive in respect to the electrons and served to attract them away from the filament. The stream of electrons thus affords a path for current to flow from filament to plate, and the action of the tube as a detector of high frequency waves depends on this principle. If the tube is connected as indicated in the illustration, Fig. 2, it will serve to rectify the incoming signals, that is change them from high frequency alternating currents, to pulsating direct current. The action is as follows: The aerial is connected to the secondary circuit by means of a standard coupler. The coils, marked L<sub>2</sub>, are the primary and secondary of this coupler; C<sub>1</sub> and C<sub>2</sub> are variable condensers, F the filament of the Fleming valve, B the battery for lighting the filament of the valve and also to supply voltage to the plate, T a pair of headphones, P a 400 ohm potentiometer and R a standard filament rheostat. The incoming signals in the form of high frequency currents, change direction many times each second. Thus, at one instant the plate will have a positive charge while the next instant it will have a negative charge as a result of the changes in direction of

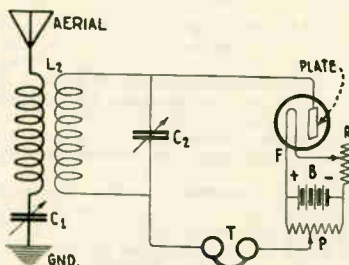

Fig. 2. Method of connecting a Fleming valve in a radio receiving circuit.

the currents impressed across the tube by the antenna circuit. While the plate is positive, electrons will be attracted away from the filament, which at that instant will be negative with respect to the plate. The current thus flows for an instant, stopping when the impressed current changes its direction and makes the plate negative. In this manner we have a flow of current from filament to plate in one direction in the form of surges appearing at every other alternation or change of current. The diaphragms of the phones will respond to these uni-directional surges and will give out sounds almost identical with the original signals transmitted. The tube thus serves as a rectifier of the incoming signals and is known as a detector of high frequency waves, or oscillations. The Fleming valve principle is used in rectifying tubes for changing alternating current to direct current for charging batteries, its use as a detector for radio reception having died out almost entirely. (See *Charger, Storage Battery, Detector, Tungar, Rectigon*, also *Vacuum Tube*.)

**FLEWELLING CIRCUIT**—A modification of the Armstrong Super-regenerative circuit, designed by the American experimenter, Flewelling. In this system, the tendency toward *self-oscillation* (q.v.) is retarded by the use of fixed condensers which are arranged to have a *damping* (q.v.) effect on the grid of the detector tube, automatically controlling the oscillations of the tube. The circuit controls the self-oscillation of the tube without the necessity for the separate control tube used in the

Armstrong circuit. The illustration shows the original Flewelling circuit. It is essentially a standard regenerative circuit with certain necessary modifications.

The coils L<sub>1</sub> and L<sub>2</sub> give magnetic coupling between the plate circuit and the grid circuit. C<sub>1</sub> is a variable condenser for tuning and condensers C<sub>2</sub>, C<sub>3</sub> and C<sub>4</sub> are of the fixed type and afford a path of relatively low impedance (q.v) for the high frequency currents. C<sub>5</sub> is the customary grid blocking condenser across which a grid leak is shunted. The usual telephone receivers T, the plate battery B and the filament battery A are included in the circuit in the customary manner. The coils L<sub>1</sub>

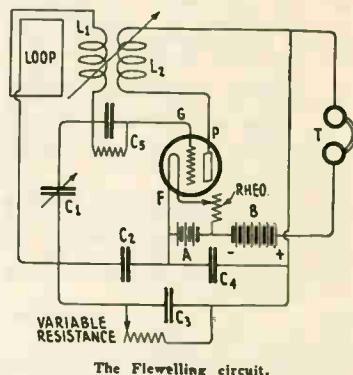

The Flewelling circuit.

and L<sub>2</sub> may be two honey-comb coils having respectively 50 and 75 turns. The tuning condenser C<sub>1</sub> should be .0005 mfd. for the broadcast band of wave-lengths and the loop may be almost any form.

In operation three forms of current pass through the plate circuit including the coil L<sub>2</sub>, namely, the direct current from the plate battery B, the uni-directional surges of rectified current due to the action of the tube as a rectifier and the high frequency currents transferred through the medium of the magnetic coupling of the two coils L<sub>1</sub> and L<sub>2</sub>. The battery current is present only in the plate circuit, the condensers C<sub>2</sub>, C<sub>3</sub> and C<sub>4</sub> blocking the direct current from the grid circuit. These condensers also block the rectified currents but afford two paths for the high frequency currents or oscillations. The condensers C<sub>2</sub>, C<sub>3</sub> and C<sub>4</sub> have definite values, respectively .005, .005 and .006 micro-farads, to allow a by-pass through the grid to the filament, thus causing accumulation of electrons on the grid and stopping oscillation of the tube. The charge then leaks off by means of the grid leak connected across C<sub>5</sub>, the tube then building up oscillations again and continuing the process during operation. The high resistance connected across C<sub>3</sub> is variable and permits control of the by-pass of high frequency current of the grid. Careful adjustment is necessary to obtain maximum signal strength without distortion. (See *Armstrong Circuits, Regenerative Circuit*, also *Super-Regenerative Circuit*.)

**FLEX**—Term used in Great Britain and occasionally in this country to refer to a number of small wires twisted or stranded together to form a single flexible conductor. (See *Flexible Wire*.)

**FLEXIBLE LEAD**—Any conductor, particularly the connections from rotary parts of couplers or condensers, in which the conductor is made up of a number of fine wires in such a way

## Flexible Wire

that the necessary bending in operation of the unit will not snap the wire as would be the case with a solid conductor. (See *Pig-tail*, also *Flexible Wire*.)

**FLEXIBLE WIRE**—Any conductor composed of a number of fine wires to permit constant handling and bending without breaking. (See *Flexible Lead*.)

**FLOAT, BATTERY**—Term sometimes applied to the bulb or float in a hydrometer for testing the condition of storage batteries. (See *Hydrometer*.)

**FLOW OF CURRENT**—An expression used to denote the passage of electric current along a conductor. (See *Current*, *Direction of Flow (Assumed)*, also *Current*.)

**FLOW OF MAGNETIC FLUX**—The passage of lines of magnetic force through any magnetic circuit. (See *Flux*, also *Field*, *Magnetic*.)

**FLUCTUATING CURRENT**—An electric current that does not have steady value, rising and falling in strength or pressure. A current that is not constant. (See *Constant Current*, also *Voltage*, *Constant*.)

**FLUORESCENT SCREEN**—A screen or surface coated with fluorescent matter, used to exhibit shadows cast by rays from various types of tubes. Its application in radio is chiefly in the *Cathode Ray Tube*. (q.v.)

**FLUX**—A very broad term in physics. The three more common examples of flux are: (a) to denote *electrostatic or magnetic flux* (q.v.); (b) a substance used in soldering for the purpose of making the solder flow readily and making it adhere to the parts being united, and (c) in metal smelting, a mineral—customarily chalk or limestone—added to the charge in the furnace to absorb mineral impurities and dispose of them in the form of slag. *Flux* is also used to refer to the amount of heat or light flowing or passing through a given distance or area in a given time. (See *Electrostatic Flux*, *Flux Density*, also *Flux*, *Magnetic*.)

**FLUX DENSITY**—The number of lines of force per square centimeter of sectional area of a magnetic path. The unit of magnetic flux in the C.G.S. (Centimeter Gram Second) or electro-magnetic system of units is the Maxwell. It is generally referred to as a "line." As a magnetic flux is merely the effect of magneto-motive force, we can take the rule that the magneto-motive force is 1.257 x ampere turns as the rule for determining the intensity or density of magnetic flux. (See *Flux*; *Field*, *Magnetic*, also *Ampere Turns* and *Maxwells*.)

**FLUX DISTRIBUTION**—The distribution of lines of force in a magnetic or electrostatic field of force. (See *Field*, also *Flux*.)

**FLUX, ELECTROSTATIC**—Another term for electric displacement as in the case of a condenser. The density of electrostatic flux refers to the intensity of an electrostatic field. (q.v.) (See *Flux Density*, *Field*, *Electrostatic*, also *Electric Displacement*.)

**FLUX LEAKAGE**—Any loss or dissipation of magnetic or electrostatic flux. (See *Flux*, *Electrostatic*, also *Flux*, *Magnetic*.)

**FLUX LINES**—The lines of force in a field of force in which electrostatic or electromotive force is exerted. An alternate term for *lines of force*. (q.v.)

**FLUX, MAGNETIC**—The term broadly used to denote the grouping of magnetic lines of force in a magnetic field. (q.v.). The most common example of

magnetic flux is in the case of an ordinary bar magnet as shown in the illustration.



Fig. 1. Bar magnet, showing how the lines of force, or magnetic flux, create a magnetic field as indicated by dotted lines.

tration Fig. 1. Here the lines of force or magnetic flux create a magnetic field indicated by the dotted lines. The number of lines of force in a field of unit area is used as a basis for determining the density of the flux. (See *Flux Density*.) This effect or magnetic flux field is also present when a current of electricity is allowed to circulate around a coil of wire, the larger the

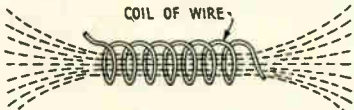

Fig. 2. Coil of wire through which current is assumed to be passing, the dotted lines indicating the flux field.

current and the greater the number of turns, the more powerful the flux created. The illustration Fig. 2 shows a coil of wire through which current is assumed to be passing, the dotted lines indicating the flux field. (See *Choke Coil*, *Transformer*, *Magnet*, also *Flux*, *Electrostatic* and *Magneto-motive Force*.)

**FLUX MAGNETISM**—The magnetic flux, or total number of lines of force passing through a magnetic circuit. It is equal to the product of the magnetic density (see *Flux Density*) and the cross sectional area of the magnetic path. It is also referred to as magnetic flow. (See *Magnetic Flow*.)

**FLUXMETER**—A device for measuring flux density. The Grassot fluxmeter uses an *exploring coil* (q.v.) in conjunction with a special form of moving coil galvanometer. The coil is suspended on a silk fiber and its movements actuate a pointer across a scale. (See *Flux*, *Magnetic*.)

**FLUX, SOLDERING**—See *Soldering Flux*, *Flux*.

**FOCUS or FOCI**—The point or points at which converging lines meet. The magnetic foci are the points on the earth's surface in the vicinity of the magnetic poles, where the magnetic force of the earth is the greatest. Essentially a mathematical term.

**FORCE**—An influence exerted upon a body so as to produce a change or a tendency to change its state of rest or motion. This is mechanical force. In electricity we have its electrical analogy—*electromotive force*. This is the force which causes motion of electricity and sustains the electric currents against the resistance of a circuit. (See *Electromotive Force*.)

**FORCE, MAGNETO-MOTIVE**—The force which produces magnetic flux as in the case of a magnet moving through a magnetic circuit. The abbreviation is M. M. F. and its unit is the *gilbert*. (q.v.) (See *Magneto-motive Force*.)

**FORCED OSCILLATIONS**—Electrical vibrations or high frequency oscillations which are imposed upon an *oscillatory circuit* without being in tune or resonance with the natural period of vibration of the circuit. The opposite

of a free oscillation in which case the circuit oscillates freely on its own account at the same frequency as the imposed or incoming oscillations or one of the *harmonics* (q.v.) of this frequency. Free and forced oscillations may be present in the same oscillatory circuit, the forced oscillations being set up during the first stages of induction of free oscillations. (See *Free Oscillations*, also *Oscillatory Circuit*.)

**FORM FACTOR**—The ratio of the root-mean-square value (q.v.) to the algebraic mean ordinate taken over one alternation (half cycle), starting with zero value of current. It is the ratio of the r.m.s. value of an alternating electromotive force, current, etc., to its true mean value. (See *Wave Analysis*.)

**FORMULA**—A principle or rule expressed in mathematical terms or chemical symbols. Formulae are much used in radio to state a problem as, for example, a formula for calculation of wave-length, which is written: Wave-length =  $1884 \sqrt{LC}$ . This states the problem or rule for the determination of wave-length. Here we have certain values represented by symbols. The capacity is represented by C, the inductance by L, the wave-length in meters being the product of the square root of the product of these two multiplied by the factor 1884. (See *Measurement of Wave-length*.)

**FOSTER BRIDGE**—A form of *Wheatstone Bridge* (q.v.) of the slide wire variety designed to permit comparison of two low value resistances that are nearly equal. It was devised by Professor Carey Foster and is used to determine the difference between two resistances as distinguished from the usual bridge for measuring the resistance of a single unit. (See *Wheatstone Bridge*.)

**FOUCAULT CURRENT**—Another name for *eddy currents*, the *electro-magnetic currents* due to the circulation of induced current in the mass of a conductor. Foucault first proved that these currents were productive of losses of energy as they cannot be utilized except in certain forms of meters. (See *Damping of Instruments*.) Alternating currents tend to set up eddy currents in metal masses near them. Thus in the case of a transformer, eddy currents are produced in the iron core due to the induced currents circulating through its mass. These currents are wasteful and means are therefore used for reducing them. The core of a transformer may be made of numerous flat pieces called laminations, which serve to prevent the free movement of eddy currents in the core. (See *Eddy Currents*, also *Transformer* and *Core Losses*.)

**FOUR ELEMENT or FOUR ELECTRODE TUBE**—A vacuum tube having four elements instead of the usual



A four element vacuum tube.

three. The standard tube has three elements, namely, grid, filament and

plate. The four element tube has an additional grid element. The illustration shows one form of tube having a double grid arrangement. Such a tube can be used for high and low frequency amplification and as a detector simultaneously or it may be used in conjunction with the Solodyne system, which does not use the customary B battery to supply potential to the plate element. (For more complete explanation of the action of a four element tube in the latter manner see *Solodyne*). (See also *Vacuum Tube*.)

**FOURTH CIRCUIT**—A method of controlling oscillation of a regenerative detector used in the *Cockaday Circuit*. (q.v.)

**FRAME AERIAL**—An alternate name for *loop aerial*, a type of aerial consisting of a number of turns of wire wound on an insulated frame and used in place of the regular outdoor aerial with sensitive receiving sets. (See *Loop Aerial*.)

**FREE ALTERNATING CURRENT**—Term applied to alternating current assumed to be produced by the application of a single impulse of electricity to an *oscillatory circuit*. (q.v.) See *Free Oscillations*.)

**FREE ELECTRONS**—Name given to the outer electrons of an atom, which become detached under various chemical transformations and are assumed to participate in electrical effects or phenomena. Free electrons are so named to distinguish them from the bound electrons of the proton or positive nucleus of an atom. (See *Electron*, also *Proton*.)

**FREE MAGNETISM**—The portion of magnetism which does not follow the magnetic path through the metal of a magnetized body, but leaves the surface of the magnet. Sometimes referred to as *surface magnetism*. (See *Magnetism*.)

**FREE OSCILLATIONS**—Oscillations having the natural frequency of the circuit in which they occur. (See *Forced Oscillations*.)

**FREQUENCIES**—The plural of the term denoting the number of complete cycles per second in an alternating current. In referring to vibrations, particularly audible or so-called *voice frequencies*, the term is used to imply all frequencies that are normally considered audible. (See *Frequency*.)

**FREQUENCY**—A term adapted from academic English to use in electrical practice. Thus, the number of times a certain action is repeated per unit of time. In the case of an *alternating current* (q.v.) the current reverses its direction of flow at certain definite intervals. If the reversing process takes place 120 times per second—that is 60 reversals from negative to positive and vice versa—the frequency of the current is said to be 60 cycles. In ordinary commercial practice the majority of alternating current generators produce an alternating current or E.M.F. having a frequency from 25 cycles per second to 60 cycles per second. In radio transmission the alternating current or E.M.F. (Electro Motive Force) has an infinitely higher frequency—the reversals taking place many thousands of times each second. (See *Alternating Current*, *Theory of Production*, also *Alternation*, *Cycle* and *Periodicity*.)

**FREQUENCY, AUDIO**—In radio, a frequency within the limits at which audible sounds are produced. It is generally considered as a frequency less than 10,000 cycles per second, although some authorities refer to fre-

quencies up to 16,000 or 20,000 cycles as being within the limits of audibility. For ordinary practice, the human ear is capable of hearing sounds only up to about 2,500 cycles per second. In receiving sets the audio frequency cur-

**FREQUENCY CIRCUIT, AUDIO**—Any circuit in a radio receiver or transmitter which carries currents within the arbitrary limits of audibility. In the diagram shown herewith, the heavy lines are the connections of the

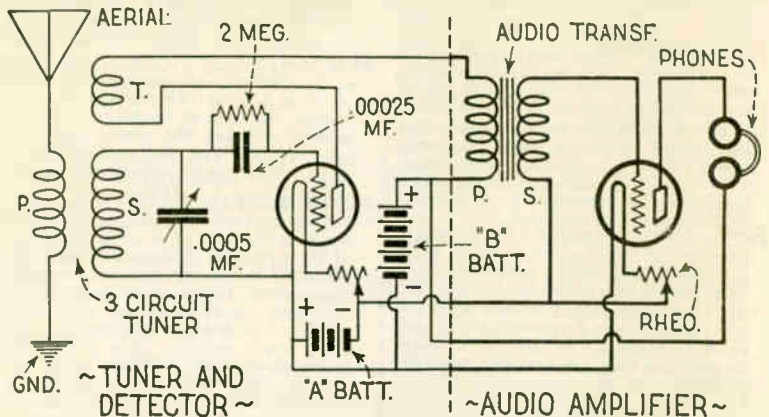

In the diagram above, the heavy lines to the right of the dotted line indicate the audio-frequency circuit of a radio receiver.

rents appear only in the circuits carrying the rectified currents, although some types of super-heterodyne receiver use an intermediate frequency as low as 30,000 cycles per second, these signals then being rectified and made audible in the telephone receivers. (See *Frequency Circuit, Audio*, also *Frequency, High*.)

**FREQUENCY, ALTERNATOR OF**—The frequency of an alternating current dynamo or alternator is expressed in cycles per second. With each complete revolution of the *armature* a complete *cycle* or double *alternation* of current is generated. (See *Alternator*.) It is therefore a simple matter to determine the frequency of alternating current generated when the number of revolutions per second and the number of field poles or magnets is known. The frequency will be  $f = \frac{N \times S}{2}$ , N being the number of field poles and S the number of revolutions per second. The divisor 2 is used to convert the result in *alternations* per second to *cycles* per second, one cycle representing two alternations. (See *Alternating Current*, *Theory of Production of*, also *Frequency*.)

**FREQUENCY BAND**—A term used to denote all the frequencies lying within a certain minimum and maximum limit. Thus, in broadcasting, the frequency band will be the frequencies corresponding to the wave-lengths within the broadcast band. This will be generally between 550,000 and 1,500,000 cycles, or a wave-length band of approximately 200 to 550 meters. (See *Band of Frequencies*.)

**FREQUENCY CARRIER**—In radio broadcast transmission, the radio frequency (high frequency) wave with which the audio frequency speech variations are superposed. (See *Broadcasting*, *General Treatise on Methods*, also *Carrier Wave*.)

**FREQUENCY CHANGER**—A device for converting currents at a certain frequency into currents of a higher or lower frequency, without change of phase or voltage. A frequency converter. Generally an *alternator* driven by a *synchronous motor*. The term is also applied erroneously to certain forms of super-heterodynes. (See *Ultradyme*.)

audio frequency circuit. In this part of the circuit only currents of audio frequencies are present. (See *High Frequency Component of Plate*.)

**FREQUENCY CIRCUIT, RADIO**—The circuits in a receiver in which only high or radio frequency currents are supposed to be present. (See *Feed-Back*, *Audio Frequency*, also illustration in connection with *Frequency Circuit, Audio*.)

**FREQUENCY, FUNDAMENTAL**—The frequency of the fundamental wave. (See *Fundamental Frequency*.)

**FREQUENCY, GROUP**—The frequency of the separate trains of waves in radio communication. (See *Group Frequency*, also *Wave Train*.)

**FREQUENCY, HIGH**—Frequencies over certain definite limits, generally from 10,000 to 20,000 cycles per second in radio usage. Commonly used as synonymous with radio frequency. It is the opposite of low or audio frequency. (See *Frequency*, also *Audio Frequency*, *Limits of Audibility*.)

**FREQUENCY, LOW**—Frequencies below certain limits, generally 10,000 or 20,000 cycles per second. (See *Frequency*; *Limits of Audibility*.)

**FREQUENCY METER**—A device for indicating the frequency of an alternating current in cycles per second. The

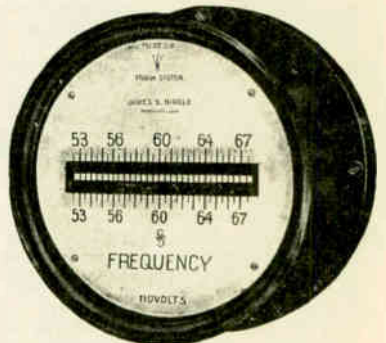

Illustration by Courtesy of Jas. G. Biddle. A vibrating reed type of frequency meter.

most simple form uses a system of tuned, vibrating reeds. The illustration shows a frequency meter of the

reed type. These reeds may be arranged to respond to various frequencies in a similar manner to the reeds in various musical instruments. These reeds are acted upon by an alternating current magnet. When the magnet is acted upon by an alternating current sent through the windings, the reed nearest to that frequency will vibrate in sympathy with the vibration due to the alternating magnetic effect on the magnet. Such meters and also those of the *induction type* are used for comparatively low frequencies such as occur in commercial lighting systems. For measurement of the high frequencies used in radio communication somewhat different systems are used.

**FREQUENCY, RADIO**—An alternating current or electromotive force above certain definite limits, generally above 10,000 or 20,000 cycles per second. The line of demarcation between *audio frequency* and *radio frequency* is not very sharply defined, as, in radio usage frequencies that are actually inaudible to the human ear may yet be referred to as audio frequencies. The term is used to differentiate between the rectified or audio currents and the high frequency oscillations such as are impressed on the antenna in receiving or transmitting. (See *Audio Frequency*, also *Frequency*, *Low*.)

**FREQUENCY, UNIT OF**—Frequency of alternating currents is expressed in cycles per second and is generally written *f*. (See *Frequency*, also *Cycle*.)

**FREQUENCY, VARIATION OF POWER FACTOR WITH**—When a condenser is charged and *dielectric absorption* (q.v.) takes place, it is always accompanied by a loss of power which is apparent in the form of heat produced in the condenser. This loss of power varies with the frequency of the current impressed on the condenser and it is therefore said that the *power factor* (q.v.) varies with the frequency. (See *Condenser*, also *Dielectric Absorption*.)

**FULL LOAD CURRENT**—The current delivered from any electrical source, such as a dynamo or generator operating at its maximum load. The maximum current obtainable from an electric source.

**FULL WAVE RECTIFICATION** — In rectifying alternating current, the process of rectifying both the positive and negative alternations or half cycles. The majority of rectifiers for charging storage batteries rectify only a half wave, or half cycle, and thus do not utilize the full alternating current cycle. (See *Rectifier*, *Full Wave*, also *Charger*, *Storage Battery*.)

**FULLER CELL**—A type of primary cell formerly much used in telephone, telegraph or any intermittent work. (See *Cell*, *Open Circuit*.) A zinc electrode cast in the shape of a cone is at the end of a soft copper wire and rests at

the bottom of a porous cup immersed in a dilute solution of sulphuric acid. The carbon electrode is in an outer jar in a bichromate solution. (See *Cell*.)

**FUNDAMENTAL FREQUENCY** — The frequency or number of cycles per second of the fundamental wave. (See *Frequency*, also *Fundamental Wave*.)

**FUNDAMENTAL UNITS**—Units based on the fundamental quantities of length, mass and time. Under the *C. G. S. system* the unit of length is the centimeter; of mass, the gram; and time, the second. The absolute system of units. (See *Centimeter-Gram-Second*.)

**FUNDAMENTAL WAVE**—In an alternating current, the component of the wave form that is a pure sine wave of the principal frequency. Upon this principal frequency the various higher frequencies (harmonics) may be superposed. A fundamental wave when combined with other frequencies which are a whole multiple of it produce the harmonious note. These terms are derived from acoustics in which the fundamental is the pure sound wave or pure note. (See *Sine Wave of Alternating Current or EMF*.)

**FUNDAMENTAL WAVELENGTH** — Term used to denote the wave-length at which the inductance and capacity of a coil or antenna would be in resonance. In referring to antennas the fundamental wave-length is the wave-length corresponding to the frequency at which free oscillations will occur. This is often referred to as the natural wave-length and the corresponding frequency is referred to as the natural frequency of the antenna.

For practical purposes the fundamental wave-length of an aerial (antenna) may be computed from the dimensions. Where no loading inductance is used, a single wire flat top antenna (T or inverted L type) will have a fundamental wave-length approximately four times the distance from the ground connection to the extreme end of flat or horizontal portion as measured in meters. Thus, if the

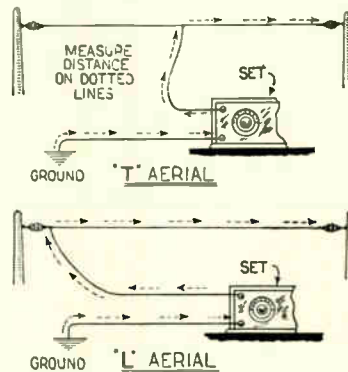

## G

**GALENA**—A natural crystal sulphide of lead. Chemical symbol  $PbS$ . It is an ore of lead, grey in color and showing brilliant metallic lustre when fractured in cubical form. Galena crystals are used either alone or in conjunction with other minerals as *crystal rectifiers* (detectors) in radio reception. When used in combination it is generally in conjunction with *graphite* or *zincite*. Used alone, the

contact may be a fine wire or *cat whisker*. (q.v.) (See *Crystal Detector*.)

**GALVANIC BATTERY**—The term, now obsolete, formerly applied to a primary battery or group of primary cells.

**GALVANI, LUIGI**. Born 1737, died 1798.—An Italian physician and physiologist noted as the discoverer of galvanic or current electricity.

antenna is of the L type with a top one hundred feet long and a lead-in and ground connection sixty feet long, the fundamental wave-length will be about  $4 \times (100 + 60) \times 1.1$ , the result being given in feet. Now as wave-length is always stated in meters it will be necessary to divide this result by 3.28 which is the rough conversion factor from feet to meters. The multiplier 1.1 adds ten per cent to the figures for necessary correction of length. If the antenna is of the T type, the length of the flat portion would be considered as half of the total horizontal length or 50 feet instead of 100 feet. The illustration shows method of measuring length. (See *Wave-length Calculation for Antennae*.)

**FUSE**—A device used in electrical circuits to prevent the passage of excessive currents. Generally a strip of fusible metal, commonly lead with a small percentage of tin, enclosed in a fiber or insulated and fireproof container and inserted in the circuit. When the temperature, due to excessive current, reaches a certain limit, the fuse "blows" causing a break in the circuit. It is thus possible to limit the



Fig. 1. A common type of fuse used in lighting, heating and power circuits.

current flowing in a circuit to a definite maximum in order to protect instruments from excessive charges. The most common use is in commercial

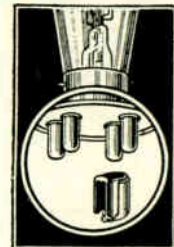

Illustration by Courtesy of Radio Equipment Co.

Fig. 2. A fuse used to protect the filament of a vacuum tube from damage by excessive voltage.

lighting and heating systems where the current on any line is generally limited to ten or twenty amperes for the protection of the lines leading in to the building.

While dissecting the legs of a frog, they came by accident into contact with dissimilar metals which caused muscular action in them. Galvani thought that he had discovered electricity in animal matter. Volta attributed the action to the metallic contact and thereupon constructed his voltaic pile, the forerunner of the primary cell.

**GALVANOMETER**—An extremely sensitive instrument used for detecting and measuring electric currents and also for indicating the direction of the current in a circuit. In its simplest form it consists of a small iron needle pivoted in the center of a hollow coil of wire. The needle is controlled by the earth's field and points north and south when at rest. When an electric current is passed through the galvanometer winding the needle is deflected over a graduated scale the extent of the deflection depending on the force

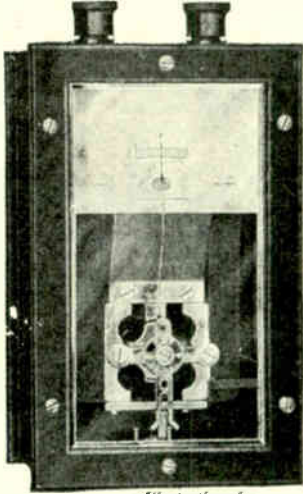

Illustration by  
Courtesy of the Roller-Smith Co.

A galvanometer which is used for measuring electric currents, and also for indicating the direction of flow of current in a circuit.

of the current. The instrument is arranged in such a manner that the needle will be deflected in one direction when the current flows through the windings in a certain direction, and when the current is reversed the needle will be deflected in the opposite direction. Thus when the connections are known the direction of the current is accurately indicated as well as its strength. The galvanometer is one of the most sensitive current measuring devices, the deflection of the needle being due to the electro-magnetic field created by the passage of electric current through the coil of wire. (See *Ammeter* or *Ampere Meter*, also *Galvanometer*, *D'Arsonval* and *Galvanometer, Mirror*.)

**GALVANOMETER CONSTANT**—Generally speaking, a number used to change the galvanometer reading to ordinary units. The instrument measures extremely small currents and this number times a certain function of the galvanometer reading gives the value in customary units. Technically, the strength of the field produced at the center of the coil of a galvanometer by the unit of current to be used. (See *Constant*.)

**GALVANOMETER, D'ARSONVAL**—A form of galvanometer having a dead beat indicator (see *Dead Beat Instrument*) in which the indicating coil is suspended in the field of a powerful horseshoe magnet. It is one of the most sensitive forms of galvanometer. The name was derived from that of the designer, A. D'Arsonval. (See *Galvanometer*.)

**GALVANOMETER, MIRROR**—A type of galvanometer, the moving coil or indicator of which carries a mirror

which reflects a beam of light from a fixed lamp. It is so arranged that the lamp is provided with a lens and the beam is so reflected that a visible spot of light is seen on a scale and deflected when the moving element (carrying the mirror) swings with the passage of current. In the beam of light is a sharp image of fine wire stretched in front of the lamp. This type of galvanometer may also be arranged so that the reflection of a fixed scale may be observed in the mirror by means of a small telescope arrangement. (See *Galvanometer*.)

**GAMMA**— $\Gamma$ —The third letter in the Greek alphabet. (See *Gamma Type Antenna*.) The lower case *Gamma*  $\gamma$  is used as a symbol for conductivity. (q.v.)

**GAMMA TYPE ANTENNA**—An alternate name for the inverted L type of antenna, so called because the third letter in the Greek alphabet,  $\Gamma$ , resembles an inverted "L," and a single wire antenna with lead-in from one end is in the shape of an inverted L. (See *T Type Aerial*.)

**GAP**—See *Spark Gap*, also *Lightning Gap*.

**GAP, AIR**—Term applied to the gap between sections of an iron core as in a transformer for the purpose of preventing saturation. (q.v.) Also applied to speak dischargers where a space is provided between the electrodes across which the spark jumps in operation. The term is used as well in referring to the radial depth of the space between surfaces of the rotor and stator in generating machines or motors. (See *Spark Gap*, also *Rotary Gap*.)

**GAP ARRESTER**—A form of lightning arrester (q.v.) in which small air gaps are provided between non-arcing metal electrodes. (See *Arrester*.)

**GAP, MICROMETER**—A small gap designed to protect apparatus from excessive potentials. (See *Safety Gap*.)

**GASEOUS**—Anything of the nature of a gas, having no natural physical boundaries but accommodating itself to the shape of the container, expanding to the dimensions of any space in which it may be confined.

**GASEOUS TUBE**—A term sometimes applied to a vacuum tube in which a certain amount of gas is present. Such tubes under ordinary conditions are not efficient as amplifiers in vacuum tube circuits, the minute gas atoms presenting a more or less effective obstacle to the free passage of the electrons. (See *Vacuum Tube, Theory of Operation*.)

**GAS RECTIFIER**—The term applied to a vacuum tube which is only partially exhausted of its residual gas. They are also known as *soft tubes* and are generally used as detectors although the tendency now is toward *hard* or highly evacuated tubes due to their adaptability to all purposes in radio receivers whereas the soft tubes do not function well as *amplifiers*. (See *Vacuum Tube*.)

**GASSING**—When the charging current is continued after a storage battery has taken a normal charge the free liberation of oxygen and hydrogen takes place. This is manifest in the form of gaseous emanation or liberation of bubbles from the electrolyte. The same effect may be noted when a battery is charged at higher rate than the normal charging rate stated by the manufacturer, and under certain conditions may occur at the later stages of charging, even when the

battery is not fully charged. In a storage battery that is in good condition it is a fairly accurate indication of a full charge. (See *Charging*, also *Rate of Charging*.)

**GAUGE, WIRE**—The various systems of measurement used for denoting the physical dimensions of wire. The standard gauge in the United States is known as the B & S or Brown and Sharpe gauge. (See *Brown & Sharpe Gauge*.)

**GAUSS**—The term adopted by the American Institute of Electrical Engineers as applying to the magnetic flux density. (q.v.) It is written B or  $\mathcal{B}$  and is also used in conjunction with the Gilbert to denote magnetizing force, one gauss being one gilbert per Centimeter. It is incorrectly used to apply to magneto motive force. (See *Centimeter Gram Second* or *C. G. S.*)

**GENERATOR**—Any machine for producing electric energy. Usually a device for converting mechanical power into electrical energy. It may apply to a vacuum tube used to generate oscillations as in transmission or for heterodyne action. (See *Heterodyne*, also *Vacuum Tube Generator*.)

**GERNSBACK, HUGO**—Born 1884. Educated Ecole Industrielle, Luxembourg; Technikum, Bingen, Germany. President, The Experimenter Publishing Company, Publishers of Radio News, Science and Invention, Amazing Stories and Radio Internacional. President of The Consrad Company, Publishers of Radio Review, Radio Listeners' Guide and Call Book, and Money



Hugo Gernsback.

Making. Editor of Radio News, Science and Invention, Amazing Stories. Author of "Radio for All," "Wireless Telephone," "Ralph 124C-41+."

**GERNSBACK, SIDNEY**—Born 1876. Educated College of Luxembourg, Lycee de Nancy, France. Vice-President and Treasurer of The Experimenter Publishing Company, Publishers of Radio News, Science and Invention, Amazing Stories, and Radio Internacional. Vice-President and Treasurer of the Consrad Company, Publishers of Radio Review, Radio Listeners' Guide and Call Book, and Money Making. Editor of Radio Re-

view, Radio Listeners' Guide and Call Book, and Money Making. Author of



Sidney Gernsback.

"A Thousand and One Formulas,"  
 "Wireless Course in Twenty Lessons,"  
 "Experimental Electricity Course,"  
 "Radio Encyclopedia."

**GILBERT**—Symbol *F*, is the unit of magneto-motive force adopted by the American Institute of Electrical Engineers. (See *Magneto-motive Force*.) It is equivalent to  $4\pi/10$  or 7958 ampere turns. (See *Ampere Turns*.)

**GLASS PLATE CONDENSER**—A condenser, generally of the heavy duty fixed type, consisting of alternate layers of metal or foil and thin glass sheets as the *dielectric*. Glass plate condensers are mainly used for transmitting, glass having a very high dielectric constant. Such condensers may be immersed in oil to stand higher potentials without breaking down. (See *Condenser*, also *Dielectric Coefficient and Constant*.)

**GLASS SILENCER**—A glass tube having wooden ends with holes just permitting discharge electrodes or rods to pass, used in conjunction with spark coils and gaps to enclose the sparking surfaces and thus dampen the noise of the sparking. (See *Spark Gap*.)

**GLOW DISCHARGE**—See *Corona*.

**GLIDING THEORY**—A theory regarding the propagation of electromagnetic (radio) waves, which assumes the waves as following the curvature of the earth and not being subject to reflection due to objects in their path or by any reflecting surface above the earth. This theory has been discarded; due to observations of phenomena of transmission it now is generally assumed that there must be a reflecting surface high in the atmosphere. However, it is considered probable that the waves do not extend very high as a general rule, the exceptions being the cases of extreme distance transmission in certain directions. In the upper atmosphere, due to the rarification of the atmosphere *ionization* (q.v.) is very pronounced and the air may become a fairly good conductor. This conducting region or layer may impose severe obstacles to the electromagnetic waves and thus limit them to a certain restricted zone. In the majority of cases this ionized region may thus be regarded as damping or absorbing the waves, and in others it may conceivably

intensify or concentrate them in one direction, producing instances of transmission over extreme distances with low power. For more complete discussion along these lines see *Heaviside Layer*, also *Refraction and Reflection of Electromagnetic Waves*.

**GOLD LEAF ELECTROSCOPE**—A very sensitive device for determining the presence and nature of an electric charge. It comprises, essentially, two strips of gold foil joined at one end by a conductor and suspended in a glass jar. When an electric charge is present the two strips of foil have a tendency to repel one another and thus, by diverging, indicate the presence of the charge. (See *Galvanometer*.)

**GOLDSCHMIDT ALTERNATOR**—One of the first practical alternators for generating high frequency currents suitable for continuous wave radio transmission. It was designed by Rudolf Goldschmidt in 1912 and was used mainly in Europe. This machine operated on a frequency step-up principle. A single phase alternating current was first produced, the frequency being about ten thousand cycles. This was about the highest possible frequency obtainable with an ordinary type of alternator. By means of a cascade effect, obtained by an arrangement of tuned circuits connected to stator and rotor of the alternator, a much higher frequency could be impressed on the antenna to radiate continuous waves. The machine had a number of disadvantages which limited its commercial value, chiefly the fact that the air gap between rotor and stator was necessarily very small—a difficult matter with a bulky machine, the rotor of which weighed several tons. (See *Alternator*, *Continuous Waves*, also *Goldschmidt*, *Rudolf*.)

**GOLDSCHMIDT, RUDOLF**—Born March 19, 1876, at Neu-Buckow, Mecklenburg, Germany. After finishing his education at Wiemar Municipal School, he studied engineering at Charlottenburg and Darmstadt Technical High School. In Darmstadt he obtained his degree as electrical engineer in January, 1898, and then became assistant to Professor Kittler. In 1900 he obtained the college and travelling scholarship, which enabled him to visit engineering works in Belgium, England and France. Later in the same year he was appointed engineer in the laboratory of the Allgemeine Elektrizitaets Gesellschaft in Berlin. In 1901-2 he occupied the position of chief laboratory engineer and designer to Kolben & Co., Ltd. in Prague. He came to England in connection with the Willesden Electricity Supply Station and was later appointed chief engineer to Messrs. Crompton & Co., of Chelmsford. In 1905 he joined the Westinghouse Company in Manchester. After private preparation he passed the German abitur-examination and obtained the degree of Dr. Eng. In 1907 he returned to Germany as lecturer at Darmstadt Technical College. Here he practiced as a consulting engineer, and also pursued the development of several inventions, chiefly occupying himself with the invention and design of high-frequency alternators for wireless telegraphy. In 1911 he became manager of the "Hochfrequenz-Maschinen Aktiengesellschaft fur drahtlose Telegraphie" in Berlin, a company formed for the utilization of his inventions in wireless telegraphy. In this position he established two large wireless stations at Eilvesen, Province of Hanover, and Tuckerton,

New Jersey, for wireless communication between Germany and America.

**GOLDSMITH, ALFRED NORTON**—Elec. and Radio Engr.; b. New York, N. Y., Sept. 15, 1887; B.S., Coll. of the City of New York, 1907; Ph.D., Columbia Univ., 1911; cons. radio expert, U. S. Dept. of Justice, 1912; cons. radio engr., Atlantic Communication Co., 1914; cons. engr., Gen. Elec. Co., 1915-17; dir. of research, Marconi Wireless Telegraph Co. of America, 1917-19; associated professor of electrical engineering, College of City of New York, since 1924; dir. of research dept., Radio Corp'n of America, 1919-1922; Chief Broadcast Engineer, Radio Corp'n of America, since 1922; editor, Proceedings of the Institute of Radio Engrs., since 1912. Made investigations in simplex and duplex radio telegraphy and telephony, transmission of canal rays, precision measurements in radio eng. Author: "Radio Telephony" (Wireless Press), 1918; "Radio Measurements," "Radio Frequency Changers" (Proc. Inst. Radio Engrs.), 1915; "World Communication" (Jour. A. I. E. E.), 1921. Technical director, U. S. Signal Corps School of Communication, 1917-18; U. S. Naval Radio School, 1917-18. Fellow, A. I. E. E., I. R. E., American Association for Ad-



Dr. Alfred N. Goldsmith.

vancement of Science. Hon. mem., Radio Club of America, Radio Society of Great Britain, Am. Physical Soc.

**GONIOMETER**—A device used in radio reception to determine the direction from which the electromagnetic waves (signals) are coming. The term is also used at times to designate any system of directional transmission or reception. The device was originally designed as an aid to navigation.

The original goniometer was designed by Messrs. Bellini and Tosi (see *Bellini*, *Dr. Ettore*, also *Tosi*, A.), but numerous changes have since been made, notably by Marconi and his associates, to adapt it to the requirements of ships at sea. The form most used is based on the original Bellini-Tosi machine and is essentially a special form of *oscillation transformer* used in conjunction with a special aerial or loop. As an example of the use of a goniometer in connection with ships at sea, suppose a ship is in distress at a point about two hundred miles off the eastern coast. Perhaps the ship's radio apparatus is working, but for some reason the mariner does not know the ship's position. The radio signals are then received, let us say, by three different land stations at widely separated points. The receiving stations use their goniometers and determine



more or less accurately the direction from which the signals are coming. The three stations compare notes on the respective directions and any one of them can readily plot out lines running on a chart from each station in the directions indicated by the goniometers. Then by simple triangulation the location of the ship can be figured, enabling other ships in the vicinity to be instructed accordingly and go to their rescue. There are, of course, many other uses that occur in everyday practice. Goniometers are also much used by radio inspectors to locate stations that are interfering, using an unlicensed transmitter, or are otherwise not complying with the regulations.

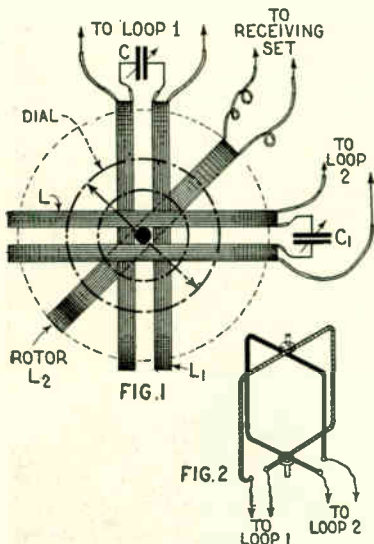

Fig. 1 shows the general arrangement of a goniometer and Fig. 2 shows the loops to which coils L and L-1 are connected.

The illustration Fig. 1 shows the general arrangement of the instrument. Here, coils L and L1 are the main windings of the goniometer. They are wound in two sections with condensers C and C1 inserted between the sections of the two windings for purposes of tuning. Coil L2 is the exploring coil. This is connected to the receiving apparatus, which is the customary detector circuit. Coils L and L1 are connected to the two loop aerials shown in Fig. 2. Here it will appear that the loops are placed at right angles, their relation in this respect being variable. In operation the coils L and L1 have minimum mutual induction, as they are placed at right angles. The exploring coil L2 can be rotated through a complete circle and the pointer indicates the angle with relation to the fixed coils. When one of the two loops points in the direction of a transmitting station it will pick up the signals, the other being at that moment inoperative, as it is at right angles to the first, as previously explained. If the exploring coil L2 is now turned until maximum signal strength is obtained, the pointer will be in the direction of the plane of the loop. If the advancing wave strikes the two loops simultaneously at any angle, a resulting magnetic field will be set up in the coils L and L1 of the goniometer, the field having a direction at right angles to the direction from which the

waves are advancing. Now when the exploring coil L2 is turned to allow maximum signal strength due to this field (permitting maximum inductive transfer), the pointer will be in the direction of the transmitting station. The direction indicated by the pointer is, of course, not the geographical direction, but this can readily be determined by means of a compass. It also appears from the foregoing description that the pointer will indicate two directions, which, however, will be on the same geographic plane. In other words, the pointer may be, for example, exactly north and south.

**GRAMME ARMATURE**—A form of ring type armature (q.v.) used in generators, named for its originator. (See *Generator*.)

**GRANULAR CARBON**—The carbon grains used in a telephone transmitter to vary the resistance between the electrodes. The highest grade is made by carbonizing pure anthracite coal in an electric furnace, after which it is screened and graded. (See *Microphone, Carbon*.)

**GRANULAR COHERER**—A form of coherer (q.v.) used in the early days of wireless. It employed carbon granules between two electrodes, the whole enclosed in a glass tube. (See *Detector*.)

**GRAPH**—The presentation in diagrammatic form of facts, formulae, etc., particularly in the electrical and mechanical fields. Graphs are much used in radio to give graphic illustrations of various functions, such as the relation of currents and voltages. For this purpose ruled and squared paper is used. One of the most common and useful forms of graph is known as a characteristic curve of a vacuum tube. These curves may show the relation of changing values, such, for instance, as the relation of grid voltage to plate current, indicating certain of the operating characteristics of the vacuum tube. (See *Characteristic Curve*, also *Sine Curve*.)

**GRAPHITE RESISTANCE**—A form of resistance composed of graphite, used in any of several ways in radio circuits. The most common usage is in the form of a grid leak (q.v.). Here it may take the form of a thin sheet of paper coated with graphite or a glass tube filled with graphite and some binding medium. Such resistances are also used in resistance coupled amplifiers (q.v.), in which case they are interposed between the plate and "B" battery and couple the successive stages of amplification. (See *Resistance*, also *Resistance Coupled Amplifier*.)

**GRASSOT FLUXMETER**—An instrument used to measure the strength of magnetic fields and the regions around magnetic poles. It is of particular value in measuring the relative strengths of various magnets. The instrument comprises a very sensitive galvanometer of the moving coil type with a special exploring coil. This coil is introduced into the magnetic field to be measured and readings of the proportionate strength of the field are obtained directly from the scale of the galvanometer, which is appropriately divided. The field strength is obtained by dividing the deflection value in Maxwell turns (q.v.) by the area of the search or exploring coil in square centimeters and the number of turns of the coil. (See *Galvanometer*, also *Flux Density*.)

**GRAVITY BATTERY**—A combination

of gravity cells. A group of cells, each cell having two different electrolytes which remain separated without use of a diaphragm due to their difference in specific gravity. (See *Gravity Cell*.)

**GRAVITY CELL**—A type of primary cell (q.v.) in which the specific gravity of one electrolyte is less than the other, which causes this lighter electrolyte to float on top of the heavier fluid. One of the typical examples of gravity cells is the Daniell's Cell (q.v.). (See *Secondary Cell*.)

**GRID**—Generally, any system of wires placed parallel to each other and in the same plane, as a mesh. Specifically in radio usage, the fine network of wires interposed between the filament and plate elements in a vacuum tube. It may be in the form of a flat network of wires or in the form of an oval cylindrical mesh completely surrounding the filament and in turn surrounded by a similarly shaped plate of metal. The illustration shows the form taken by a typical grid member in a modern type of vacuum tube. Here the plate is not shown in order to permit the grid member to show more clearly.

In receiving circuits the grid acts as a valve to control the flow of electrons from hot filament to cold plate. When signals are impressed on the aerial they are tuned by the customary agencies and passed to the grid circuit (q.v.). As the incoming signals are in the form of high frequency oscillations (q.v.) changing their polarity (direction) many thousands of times each second, it will be apparent that the grid is altered rapidly from positive to negative and back. As the electrons flowing from the filament are negative, the grid will thus have a tendency to retard or increase the

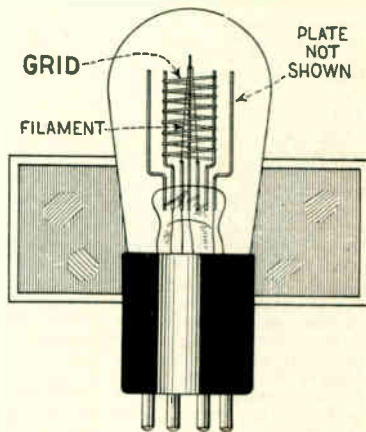

Showing the form taken by a typical grid in a modern vacuum tube.

flow. That is to say, at the instant the grid is positive it will attract more electrons, but when it is momentarily negative the like charges will repel each other and less electrons will flow, some of them being held back to the filament. (See *Grid Battery, Grid Bias*, also *Vacuum Tube, Theory of Operation of*.)

**GRID BATTERY**—A battery of small cells connected in the grid circuit of a vacuum tube to place a negative or positive bias or charge on that element. The illustration Fig. 1 shows a small four and one-half volt battery inserted in such a manner that a nega-

## Grid Bias

tive potential is impressed on the grid. In this case the *characteristic curve* (q.v.) of the tube is assumed to indi-

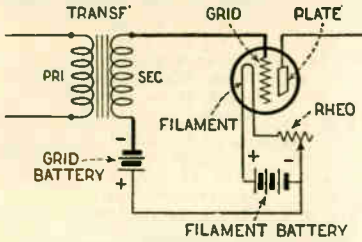

Fig. 1. Method of a 4½ volt battery to impress a negative potential on the grid of a vacuum tube.

cate that more difference in current occurs between points B and C than between A and B in Fig. 2. For this

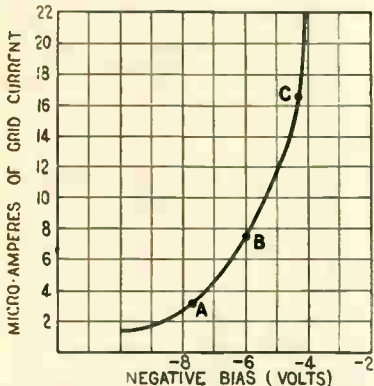

Fig. 2. Characteristic curve of a vacuum tube indicating more difference in current occurs between "B" and "C," than between "A" and "B."

reason a negative potential is applied as shown in Fig. 1. (See *Grid Bias*.)

**GRID BIAS**—A potential of a few volts, generally from four to six, applied to the grid of a vacuum tube to influence its operation by making it more or less negative. The grid bias is usually negative and determines the point of the *characteristic curve* at which the tube will operate. In a sensitive receiver, and particularly where a tube is used as an *amplifier* (q.v.), it is essential to obtain as great a change of grid current as possible. (Note: The greater the change of grid current, the greater the change in plate current and hence the more powerful will be the output.) By applying a negative potential on the grid it is possible to hold it at the point of maximum response. (See *Grid Battery*, also *Vacuum Tube, Theory of Operation of*.)

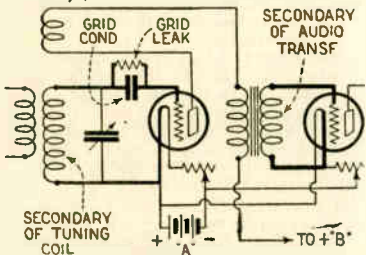
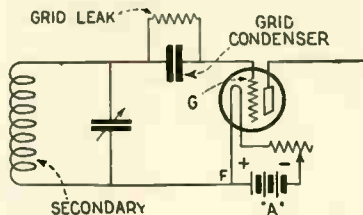

Diagram in which heavy lines at left show the grid circuit of the detector, while those on right indicate audio amplifier grid circuit.

**GRID CIRCUIT**—In a receiver employing vacuum tubes, the part of the cir-

cuit containing the grid of the tube or tubes, but generally referring to the tuning circuit or that part of the system which contains the tuning elements. In the illustration is shown a standard arrangement of a regenerative detector and one stage of audio-frequency amplification. The heavy lines at the left of the diagram represent the tuning circuit or detector *grid circuit*, while the section with heavy lines at the right is the grid circuit of the amplifier tube. The grid circuit of a detector tube may generally be distinguished by means of the grid leak and condenser (so marked in the illustration), which controls the incoming signals and permits the tube to function as a rectifier. (See *Detector, Grid Control*, also *Grid Condenser and Grid Leak*.)

**GRID CONDENSER**—A small fixed condenser, generally from .00025 to .0005 microfarad capacity, inserted in



Showing how grid condenser is connected in a detector circuit.

the circuit of a detector tube between the tuning coil and the grid member of the tube. The illustration shows the manner of connecting the grid condenser in a conventional detector circuit. This condenser insulates the grid from the filament by breaking the path F to G and permits the tube to act as a rectifier or detector. A resistance (called *grid leak*) is usually placed across this condenser to allow the accumulated charges on the grid to leak off. (See *Grid Leak*, also *Grid Control and Vacuum Tube, Theory of Operation of*.)

**GRID CONTROL**—The general term used to designate the various devices and associated connections placed in or allied with the grid circuit of a vacuum tube for the purpose of controlling to a greater or lesser extent the potential of the grid, or to tune or control the incoming oscillations. In the case of a vacuum tube used as a rectifier (detector) the grid condenser and grid leak are placed in series with it. (Note: the grid leak is often connected from the grid directly to the filament instead of across the grid condenser, the operation, however, being approximately the same in either case.) Here the controls permit the tube to function as a detector of the incoming oscillations. Where the tube is used as a radio-frequency (high-frequency) amplifier, the radio-frequency transformer or other amplifying unit controls the grid of the following tube by influencing the fluctuating potential differences impressed on it. (See *Amplifier, Radio-Frequency*.) The most important example of a grid control is by using some means to control the potential applied to the grid, such, for example, as a grid bias or grid battery. (See *Grid Bias, Grid Battery*, also *Vacuum Tube, Theory of Operation of*.)

**GRID CURRENT**—The current present in the grid circuit of a vacuum tube. This is generally very small, perhaps

of the order of fifteen to twenty *microamperes* (q.v.). (See *Plate Current*, also *Grid Bias*.)

**GRID LEAK**—A high resistance placed in the grid circuit of a vacuum tube to permit the electrons forming the grid current to leak off after each charge, thus preventing their accumulating on the grid in such numbers as to stop the flow from the filament. The electrons being negative, a surplus of them on the grid member of the tube would act as a barrier to the free flow of other electrons from the filament through the grid to the plate, thus diminishing the plate current toward zero. It will be understood that a heavy negative charge on the grid will repel a like or negative charge, in this case the negative electrons being thrown off by the hot filament.

The grid leak may have a value ranging from about 250,000 ohms to several million ohms. The value of a grid leak is generally stated in *megohms*—one megohm being one million ohms. Thus a grid leak of 250,000 ohms resistance would be referred to as a ¼-megohm leak and, similarly, one having a resistance of two million ohms would be referred to as a two-megohm grid leak.

Such resistances are furnished in many forms, the most common being a strip of paper impregnated with graphite or some similar high resistance preparation, placed in a glass tube and sealed to prevent moisture from affecting the value. The illustration, Fig. 1, shows a tubular type of grid leak.



Courtesy of Chas. Freshman Co.

Fig. 1.—A tubular type of grid leak.

For experimental work a fairly satisfactory grid leak can be made by the simple expedient of drawing a line on a piece of cardboard with a soft pencil—the graphite mark acting as the resistance. At each end of the cardboard is placed a binding post in contact with



Courtesy of Chas. Freshman Co.

Fig. 2.—Two types of variable grid leaks with condenser incorporated.

the graphite, each binding post being connected to opposite sides of the grid condensers. Variable grid leaks, the resistance of which can be changed at will, are also furnished in an infinite variety of types, two of which are shown in Fig. 2. (See *Variable Grid Leaks*, also *Grid Control and Resistance*.)

**GRID POTENTIAL, MODULATION OF**—In the transmission of *undamped waves* (q.v.) generated by a vacuum tube, the process of varying or modulating the potential of the grid element of the tube with respect to the filament. In this method an alternating potential may be applied to the grid circuit, the frequency of this varying

potential being within the audio band—possibly about 500 cycles—supplied by a generator of that frequency. (See *Modulation*.)

**GRID POTENTIOMETER**—A potentiometer—a variable resistance unit—Fig. 1, used in the grid circuit of a vacuum tube for the purpose of controlling the potential applied to the grid. The conventional method is to place the potentiometer across the "A" battery with the center or variable contact arm connected to the grid of the tube in place of the usual connection to either positive or negative filament lead. This is shown in the illustration, Fig. 2. Here the customary circuit is



Courtesy of the Cutler-Hammer Co.  
Fig. 1.—A type of potentiometer.

shown for the "A" battery to light the filament of the tube. Pri. and Sec. are respectively primary and secondary of the transformer (either radio-frequency or audio-frequency) and C the center arm of the potentiometer. The center arm may be moved either to the right or left, permitting either negative or positive potential to be applied to the grid. This system is much used in amplifying tube circuits to control the action of the tube as an amplifier. Another method would be to connect one of the ends of the potentiometer to the negative lead of the "A" battery and the center arm to the grid leak. In this way the potentiometer would be acting as a pure variable resistance, the potential applied to the grid being

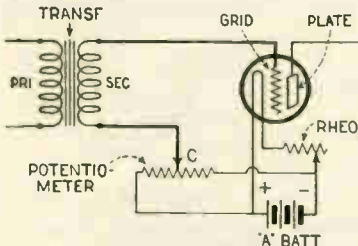

Fig. 2.—Method of connecting potentiometer in grid circuit.

always negative, but susceptible of variation within the limits of the resistance and the voltage of the "A" battery. (See *Grid Bias*, *Grid Battery*, also *Grid Control*.)

**GRINDER**—Term occasionally applied to one of the various forms of atmospheric disturbance known under the general heading of *static*. This form of static is more prevalent in warm weather and does not appear to have its origin in local electric storms. Its effect is to produce rattling sounds of no definite pitch. (See *Strays*, also *Static*.)

**GROUND**—The earth considered as an electric conductor. In radio it is considered as the return circuit for electromagnetic waves. (See *Ground Connection*, also *Theory of Propagation of Electromagnetic Waves*.)

**GROUND CLAMP**—A strip of metal, generally copper, having some sort of



A ground clamp for fastening the ground lead to a water or steam pipe.

arrangement for fastening rigidly to a water or steam pipe to form the ground connection for a radio receiver. The illustration shows a conventional form of clamp. (See *Ground Connection*.)

**GROUND CONNECTION**—In radio reception or transmission, the connection between the earth and the apparatus whereby the currents set up by the electromagnetic waves are returned to the earth as one side of the assumed circuit. The ground or earth connection from a radio receiver or trans-

the aerial, ground and apparatus in such manner that at one position the aerial is connected to the set, which in turn is connected to the ground, and in the other position the aerial being connected directly to the ground to protect the set from excessive static when not in use. (See *Lightning Switch*, also *Aerial Switch*, *Down Lead*.)

**GROUND WIRE**—The wire connecting a receiving or transmitting set to the earth. The underwriters specify not less than No. 14 B & S gauge copper wire. (See *Ground Connection*.)

**GROUND ROTOR**—See *Rotor*, *Grounded Connection*.

**GROUP FREQUENCY**—The number of separate trains or groups of waves per second in a damped or undamped system of radio transmission. This frequency is to be distinguished from the frequency of the individual waves. Thus in a spark transmitter, for example, the condenser in the transmitting circuit will be momentarily charged and discharged. The discharges will occur in the form of trains of oscillations, each oscillation having a certain defini-

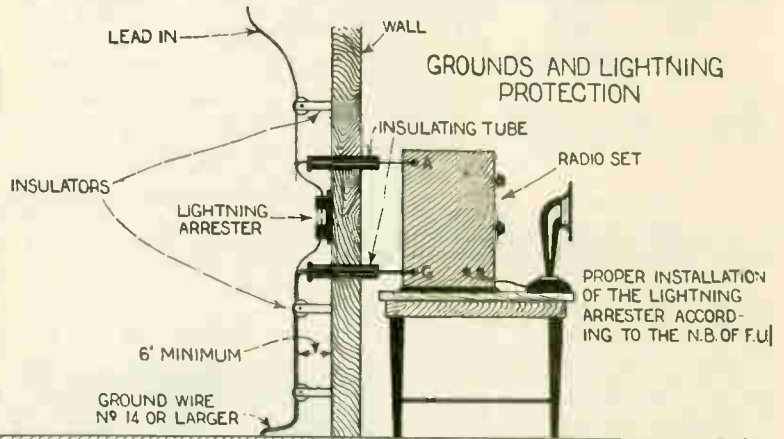

Illustration showing by means of a heavy line, the ground connection of a radio receiver.

mitter should be as short as possible and preferably a heavy wire as shown in the illustration. Such a connection for receiving purposes may be one or more heavy metal plates sunk in the ground and connected by a heavy wire to the apparatus. The more common method is to connect the set to a convenient water or steam pipe, such pipes being almost invariably well grounded, especially the former. (See *Earth*, also *Ground and Transmission*.)

**GROUND CURRENTS**—Electric currents present in the ground due to the grounding of commercial electric machines. These currents very often prove a disturbing factor in radio reception. (See *Ground*.)

**GROUND DETECTOR**—A device for indicating an accidental ground on a power transmission line or for any conducting systems for electric currents. (See *Detector*, also *Ground*.)

**GROUND RESISTANCE**—See *Resistance of Ground Connection*.

**GROUND SWITCH**—A switch, generally of rugged construction, connected to



Switch having a break distance of not less than 1 inches.

nite frequency, but the trains or groups occurring at definite intervals, the frequency of these intervals being called the group frequency. (See *Frequency*, also *Spark Transmission and Undamped Waves*.)

**GUARD LAMP**—An incandescent lamp having a straight filament, sometimes shunted across the armature and field leads of a rotary converter used in radio transmission. Its purpose is to protect the windings from injury due to the inducing of oscillatory surges from the high-frequency circuits. (See *Rotary Converter*.)

**GUTTA PERCHA**—An insulating material derived from the milky secretion of certain trees, used as an insulation for submarine cables on account of its ability to resist the action of salt water. It is used to a lesser extent as a general insulating medium for wires, but owing to its scarcity and limited field of usefulness, rubber or rubber compounds are more widely used. (See *Insulating Materials*.)

**GUY WIRE**—Wires used to brace aerial masts for receiving or transmitting stations. Such guys are generally heavy galvanized wires attached to the mast at various points and extending radially downward and anchored to surrounding rigid objects or by means of some form of anchor in the ground. (See *Aerial*.)

# H

**H**—The chemical symbol for *hydrogen*. In electrical and radio usage it is the symbol for *magnetizing force* or *magnetic field intensity*, adopted as such by the International Electrotechnical Commission and by the American Institute of Electrical Engineers. It has also been adopted by the I. E. C. as the symbol for *Henry* (q.v.). (See *Magnetic Field*.)

**HALF WAVE RECTIFICATION**—The process of changing alternating currents to pulsating direct currents wherein only one-half of the full alternating current wave or cycle is rectified, the other portion being blocked by the action of the rectifier. In the illustration is shown a typical half

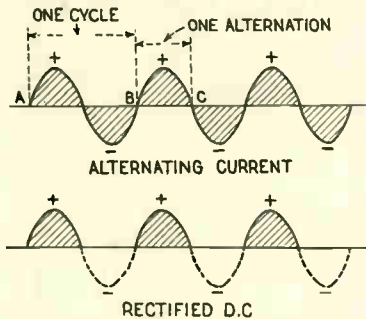

The upper graph represents an alternating current, and the lower graph shows the form taken by the current after passing through a half wave rectifier.

wave rectification process. The upper graph shows the sine wave representing an alternating current, such as supplied from an ordinary alternating current house lighting system. Here A-B represents one complete cycle or two alternations, one positive and the other negative. In the lower graph is shown the form taken by the current after passing through a half wave rectifier. It now appears as a pulsating or intermittent direct current, only the upper or positive alternations having passed through the rectifier. The shaded portions below the line represent the negative or unused alternations. (See *Full Wave Rectification*, *Sine Wave of Alternating Current* or *E M F*, also *Charger*, *Storage Battery*.)

**HALF WAVE RECTIFIER**—Any system for rectifying or changing alternating currents to pulsating direct currents, wherein only half of the full alternating current wave is used. Essentially such a device is a uni-directional conductor, permitting current to pass in one direction only and submerging or blotting out the surges in the opposite direction. A typical example of a half wave rectifier is the crystal detector used in simple receiving circuits. Here the nature of the crystal is such that the currents are permitted to pass only in one direction. In half wave rectifiers used for charging storage batteries the effect is much the same. Where tubes such as the Tungar or Rectigon are employed, one tube is more commonly used, allowing the current to flow in one direction but submerging half of each cycle. (See *Rectifier*, *Full Wave*, also *Rectifier* and *Charger*, *Storage Battery*.)

**HAMMER BREAK**—A magnetically operated device for making and break-

ing contact in an electrical circuit. Hammer breaks are essentially the same as a vibrator or buzzer break but are made to withstand heavy currents without undue arcing, and hence are much slower in action. (See *Buzzer*, also *Spark Coil*.)

**HAMMOND, JOHN HAYS, JR.**—Inventor. Born San Francisco, Calif., April 13, 1888. B.S., Sheffield Scientific School (Yale), 1910; Sc.D., George Washington University. Inventor of type of torpedo for coast defense, controlled by wireless energy from coast fortifications, which was recommended to Congress for exclusive purchase by U. S. by Board of Ordnance and Fortifications, U. S. A.; invented system of automobile torpedo firing; aluminum-thermic incendiary projectiles employed by Allied armies in World War; radio system of control of ships, employed on U. S. S. Iowa for target practice; a system of coastal patrol by aeroplane; a system of selective radio telegraphy, adopted by the U. S. Navy, U. S. Signal Corps, and U. S. Army; system of aerial coast surveying adopted by the Bartlett Expedition for Polar exploration. President Radio Engineering Company of New York; director Hammond Radio Research Labs.; director Radio Corp. of America; consulting engineer to Radio Corp. of America and General Electric Co. Has licensed the American Tel. & Tel. Co., and the Radio Corp. of America under his electrical patents in U. S. and S. A. for commercial purposes only, U. S. Gov't retaining option on military uses. Has applied for over 224 patents in U. S. and Europe relating to Radio Telegraphy and Telephony and Wire-



John Hays Hammond, Jr.

lessly controlled torpedoes and various improvements in pipe organ mechanisms. Formerly member Advisory Board, U. S. Naval Board of Inventors, member Advisory Com. Langley Aerodynamic Lab. of Smithsonian Inst., co-operating with Third Naval Dist.; member Conf. Com. on National Preparedness (Sub-Com. on Finance); Gov. Aero Club America (mem. Aerodynamic, Tech., Pub. Safety and Map and Landing Places Com.); v.-p. Am. Soc. Aeronautic Engineers; mem. Inst.

**Radio Engineers** (ex-treas., etc.), Am. Inst. E. E., Royal Soc. Arts (London); asso. mem. Am. Soc. M. E.; hon. mem. Nat. Inst. of Inventors, Harvard Aeronaut. Soc.; Fellow Am. Geog. Soc.; U. S. del. Radio-Telegraphic Com., London, 1912.

**HAND CAPACITY**—See *Body Capacity*.

**HARD DRAWN WIRE**—In radio usage generally confined to hard drawn copper wire, i. e., copper wire that has been hardened by repeated drawing without being annealed. It is used chiefly for aeriels. (See *Aerial*.)

**HARD TUBE**—A vacuum tube is said to be hard when it has been evacuated of all gases to a high degree. The opposite is a soft tube, one in which the vacuum is not of a very high order and more or less gas particles are present. Hard tubes are used for amplifiers, both audio and radio frequency, while the soft tubes are used mainly as detectors or oscillators. Hard tubes may be used with high plate voltages, whereas soft tubes require comparatively low plate voltages, the tubes having a tendency to turn blue (see *Blue Glow*) under the influence of high plate potentials. (See *Detector*, also *Amplifier*.)

**HARMONIC CURRENT**—An alternating current which can be represented by a simple harmonic or sine curve. It may be considered as an alternating current, the waves of which are sinusoidal or uniform. (See *Simple Harmonic*, also *Sine Curve*.)

**HARMONIC MOTION**—A term signifying any periodic oscillatory motion, as, for example, the vibration or beating of a pendulum. The illustration shows the manner of indicating simple harmonic motion. The distance A-B represents 360 degrees of a circle, or, if it is assumed to represent a sine wave of alternating current, it will represent one complete cycle. Curves representing harmonic motion are used

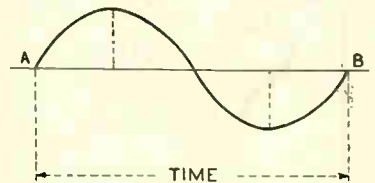

Illustration showing method of indicating simple harmonic motion.

extensively in radio engineering to illustrate, in graphic form, the oscillations of an alternating current. (See *Sine Wave*, also *Simple Harmonic Vibration* and *Oscillations*.)

**HARMONICS**—Oscillations to which a circuit will respond in addition to the basic or fundamental oscillations. The effect is similar to that in sound, where, for instance, the primary or fundamental tone struck by an instrument may be accompanied by notes or tones of a higher pitch. In sound these harmonics are principally the third, fifth, seventh and the octave. In radio, a circuit may respond to oscillations of a frequency either higher or lower than the fundamental frequency, as, for example, one third, one fifth or one seventh, or, again, double or treble the original frequency. As a concrete example, with a fundamental wave-length of 240 meters, the harmonics might be

40 meters or 80 meters. The corresponding frequencies would be approximately 1,250,000 cycles, 7,500,000 cycles and 3,750,000 cycles. (See *Harmonic Suppressor, Side Bands, also Harmonic Motion, Oscillations, Wave-length.*)

**HARMONIC SUPPRESSOR**—A device used in radio transmission and in laboratory work, for the purpose of eliminating undesired frequencies (wave-lengths). Essentially such a device is a filter (q.v.) so arranged as to suppress or eliminate certain frequencies or harmonics (q.v.). In radio broadcasting it is particularly essential that all undesired frequencies or harmonics be suppressed. Basically the system involves a special coil shunted by a condenser and tuned to the frequency of the interfering wave, the main tuning circuit at the same time being adjusted to the desired frequency. (See *Broadcasting, General Treatise on Methods, also Transmission and Radio Telephony.*)

**HAZELTINE NEUTRODYNE RECEIVER**—The radio receiver designed by Professor Hazeltine, employing the Neutrodyne circuit. Essentially these are five-tube receivers employing two stages of tuned and neutralized radio-frequency amplification with the conventional detector and two audio-frequency stages. In addition to the five-tube Neutrodyne receiver there are numerous types involving the Neutrodyne principle in conjunction with reflex systems. (See *Neutrodyne.*)

**HEAD TELEPHONE OR HEADPHONES**—Telephone receivers arranged with a band to fit over the operator's head, thus leaving him free



Illustration by courtesy of C. Brandes, Inc. A type of headphone used extensively in radio reception.

use of both hands. Head-phones are used in commercial radio work, the operator being free to handle a key or the controls of the receiver or transmitter. They are also used in broadcast reception where the strength of signals is not sufficient to permit the use of a loud speaker, and also in some cases to tune in distant signals before attaching a loud speaker. (See *Watch Case Receivers.*)

**HEAVISIDE, DR. OLIVER.** — Born in London on May 13, 1850, Dr. Heaviside was engaged in telegraph work for a few years, but after 1874 he lived in retirement studying Clerk-Maxwell's theory and applying it to telegraph and wireless problems. Elected a Fel-

low of the Royal Society in 1891, he was also Faraday Medallist of the Institution of Electrical Engineers and Hon. Ph.D. of Gottingen University. The name of Dr. Heaviside is primarily associated with the theory, propounded by himself, of the existence of a permanently ionized layer in the upper atmosphere capable of deflecting electromagnetic waves and thus permitting wireless communication round the earth.

**HEAVISIDE LAYER**—An assumed layer or stratum of the atmosphere supposed to exist from fifty to one hundred miles above the earth's surface according to the Heaviside Theory. Heaviside's theory supposes this stratum to consist of heavily ionized gas which is conductive and acts as a gigantic reflector of electromagnetic waves (radio waves). It is this layer which is supposed to reflect the electric waves and force them to follow the curvature of the earth. This theory partially explains—if true—why radio signals are transmitted over great distances instead of being radiated off into space and lost. It has been accorded the support of many eminent scientists. Elihu Thompson has propounded an alternative theory which assumes the waves as attached to the

radiation being unchanged. In other words, increase of height increases the range within certain limits. (See *Radiation from Antenna, also Transmission.*)

**HEISING, RAYMOND A.**—Electrical Engineer, born Albert Lea, Minn., August 10, 1888. Educated University of N. D., Elec. Engineer, 1912; University of Wisc., M.S., 1914 Grad. Work in Physics, Research and Development of Radio Tel. since 1914; Trans-Atlantic test in 1915; for Army and Navy use during War, aeroplane, chaser, intership communication; since War continued research and development ship to shore use, trans-Atlantic test, 1923. Author of several technical papers; numerous inventions widely used in present broadcasting stations.

**HEISING MODULATION**—A system of modulating radio currents for radio transmission, such as broadcasting, developed by E. A. Heising. The fundamental principle is shown by the illustration. Here the customary antenna and ground are connected with a high-frequency alternator, A; the field of the alternator, FW, is connected to the grid return and filament of the vacuum tube circuit, and through the "B" battery BB to the plate P of the tube. The microphone circuit comprises a

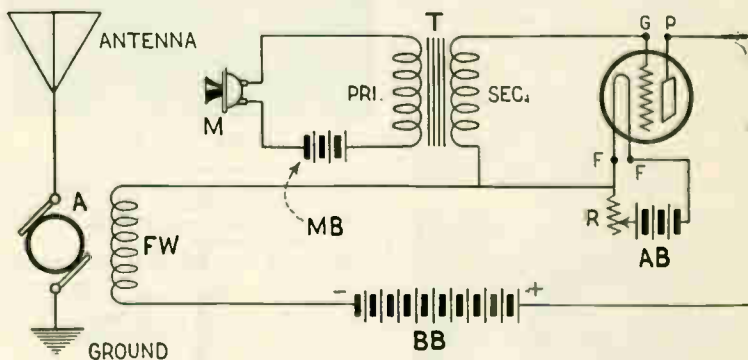

Circuit illustrating the fundamental principle of the Heising system of modulation.

earth and gliding along over the surface. (See *Gliding Theory.*)

**HEAVISIDE LAYER THEORY**—The theory of an upper ionized stratum from fifty to one hundred miles above the earth's surface, which is assumed to act as a reflector of radio waves and thus force them to follow the curvature of the earth. None of the theories thus far advanced has been proven, but it has been definitely established that these waves do follow the curvature of the earth. (See *Heaviside Layer, also Gliding Theory.*)

**HEDGEHOG TRANSFORMER**—A type of audio transformer so called because of its peculiar construction. The core is cylindrical in shape and consists of a great number of soft iron wires around which is a bobbin holding the primary and secondary windings. After the windings are completed the wires forming the core are bent back over the form and held in place, completely surrounding the windings. (See *Audio-Frequency, also Transformer.*)

**HEIGHT OF AERIAL**—The elevation of an aerial system as used in radio transmission or reception. The effective height is roughly considered as the height above the earth or surrounding objects. The range of a station having constant power is dependent upon the height of the aerial, other factors of

microphone M connected to the primary of a transformer T through the battery MB. The secondary of the transformer is connected to the grid G of the vacuum tube and the filament F. R is the usual rheostat to control the filament of the tube and AB is the filament lighting battery. In operation the speech or sound vibrations are impressed on the microphone M, thus varying the resistance of the current flowing from the battery MB and through the transformer T. This serves to vary the potential of the grid G, and as this potential changes, the current in the plate circuit will also be varied, the same characteristics being maintained. As the field winding FW is in the plate circuit, it is evident that the antenna current will be modulated in accordance with the variations of the speech or sounds introduced at M. (See *Grid Control, also Modulation and Broadcasting, General Treatise on Methods.*)

**HELIOGRAPH**—An instrument involving a movable mirror, by means of which the sun's rays are reflected and made use of as a signalling device. In practice it is usually arranged with a blind or shade to cover the mirror at rapid intervals by pressing on a key device. In this manner the flashes may be made at definite intervals, as in the case of the Morse light. (See *Code, also Morse Light.*)

**Helix**

**HELIX**—The shape assumed by a line of wire wound in a single layer around a cylinder. Generally speaking, a *sole-noid* (q.v.). A device in the form of a helix was formally used in transmitting circuits to vary the inductance, or, practically speaking, the wave-length. It usually was a number of turns of heavy copper or aluminum wire wound on an insulating form. Clips were provided to permit a variation in the contact point and hence any necessary change in the value of the inductance. (See *Oscillation Transformer*.)

**HENRY, JOSEPH**—Born in 1797, died in 1878. An American Physicist, noted for his researches in electromagnetism. He developed the electromagnet which had been invented by Sturgeon in England, so that it became an instrument of far greater power than before. In 1831 he employed a mile of fine copper wire with an electromagnet, causing the current to attract the armature and strike a bell, thereby establishing the principle employed in modern telegraph practice. He was made a professor at Princeton in 1832 and during his experimenting there he devised an arrangement of batteries and electromagnets embodying the principle of the telegraph relay which made possible long distance transmission. He was the first to observe magnetic self-induction, and performed important investigations in oscillating electric discharges (1842), and other electrical phenomena. In 1846 he was chosen secretary of the Smithsonian Inst. at Washington, an office which he held until his death. As chairman of the U. S. Lighthouse Board he made important tests in marine signals and lights.



Joseph Henry.

In meteorology, terrestrial magnetism and acoustics he carried on important researches. Henry enjoyed an international reputation and is acknowledged to be one of America's greatest scientists.

**HENRY**—The unit of inductance, named after the American physicist, Joseph Henry, who first produced high-frequency oscillations in 1832. A coil of wire is said to have an inductance value of one henry when a current passing through it changes at the rate of one ampere per second and an electromotive force of one volt is produced. As the henry is too large a unit for practical purposes, the thousandth part of a henry, known as the *milli-henry*, or the millionth part, known as the *micro-henry*, are more commonly used. Another much-used term is the centi-

meter, which is the thousandth part of a micro-henry. The abbreviation for henry is H, and for micro-henry  $\mu\text{H}$ . (See *Centimeter Gram Second, Centimeter*, also *Inductance*.)

**HERTZ, HENRICH RUDOLF**—Born 1857, died 1894. A German physicist noted as the discoverer of electromagnetic waves (1888) which form the basis of wireless telegraphy. He found that waves produced by the spark of a simple device called the oscillator could be detected by a loop or square of wire known as the resonator, and he was able to show the reflection, refraction, diffraction and polarization of the



Heinrich Rudolf Hertz.

waves. These remarkable discoveries demonstrated the practical possibilities of radio-telegraphy. He also made valuable experiments with electric phenomena in vacuum tubes.

**HERTZIAN WAVES**—Term occasionally applied to radio or electromagnetic waves, they being named after Dr. Heinrich Rudolf Hertz owing to his extensive researches into electromagnetic waves. (See *Hertz*, also *Clerk-Maxwell*, and *Ether Theory*.)

**HETERODYNE**—The term originally applied by Fessenden to a method of reception of electromagnetic waves, wherein the principle of *Beats* (q.v.) was employed. It is derived from the words "hetero," meaning other or different, and "dyne," meaning power.

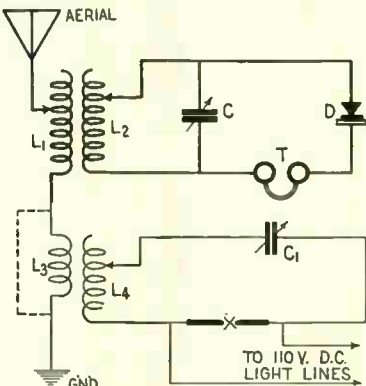
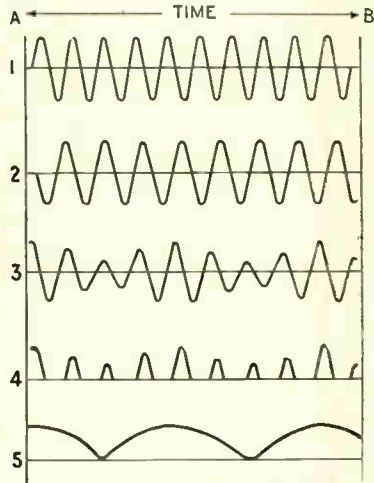

Fig. 1.—The original form of heterodyne receiver.

In its original conception by Fessenden, before the widespread use of vacuum tubes, it was used in conjunction with crystal receivers for the reception of *undamped waves* (q.v.). The hetero-

dyne principle involves production of a local series of oscillations which are tuned to a frequency differing from the frequency of the incoming oscillations from the antenna. The difference between the two is known as the *beat frequency*. (See *Beats*, also *Heterodyne Receiver*.)

**HETERODYNE RECEIVER**—A receiver for electromagnetic (radio) waves employing the *heterodyne* principle. The illustration Fig. 1 shows the original form of heterodyne receiver, wherein the local oscillations were produced by means of a direct current arc gap and associated circuits, and combined through a coupling medium, with the oscillations in the antenna circuit. Here the heavy lines represent a conventional crystal receiver circuit. L1 and L2 are respectively primary and



Series of graphs showing the action of a heterodyne receiver.

secondary of a vario-coupler, C is a variable tuning condenser, D the crystal detector and T the head phones. If the dotted line is assumed as a connection to the ground, this will constitute a complete receiver. For the heterodyne purpose, however, a special coil L3 is employed in the ground circuit. Coupled to this is the secondary L4. C1 is another tuning condenser and A is an arc gap fed by 110 volts direct current. In operation the circuit represented by the light lines acts as a generator of undamped oscillations, these oscillations being supplied to the antenna circuit and the frequency varied by means of the condenser C1 and the coil L4. If the receiving tuner is tuned to a certain wave-length corresponding to incoming signals, and the generator system tuned to a different frequency, the difference between the two frequencies will be a *beat* frequency which will be present in the detector circuit. This new series of oscillations will be rectified by the detector D and will be audible in the head phones, T. The action of this system is shown by the series of curves given in Fig. 2. Here the incoming oscillations (signals) from the antenna are shown in graph 1 at the top of the illustration. These oscillations are of continuous amplitude or *undamped* (q.c.). Graph 2 shows the local oscillations. If we assume that the distance from A to B represents the time, it will be apparent that there are more oscillations per unit of time in the case of the incoming signals—

hence the second graph indicates that the local oscillations have a lower frequency. Graph 3 represents the *beat* resulting from interaction of the two upper series of oscillations and the frequency corresponds to the numerical difference. When the two upper groups of oscillations are opposed, the beat current is zero, and when they are in phase, or assisting each other, the beat current is maximum. When rectified by the crystal detector action the beats take the form shown in graph 4, the lower half of each cycle having been submerged. The telephone current of a periodic nature is indicated by the bottom graph, the original signals being represented in the phones by a series of contractions of the diaphragm. (See *Heterodyne*, also *Beats* and *Super Heterodyne*.)

**HETERODYNE, SELF**—See *Self-Heterodyne*.

**HETERODYNE WAVE-METER**—A wave-meter—device for measuring the wave-length of coils, circuits or incoming and outgoing signals—which utilized the heterodyne principle. Briefly the action is as follows: It has already been explained under *Heterodyne Receiver* that when the local oscillations and the incoming oscillations are opposed, the beat current is zero. It follows, then, that with a pair of phones connected in the circuit, the beat signals will be audible only when the two frequencies are different. Now if a suitable means is present for varying the frequency of the local oscillations, in practice a combination of coil and condenser, the local circuit can be tuned to a point where the two frequencies concur or are similar and no beat is audible. As the frequency is proportional to the capacity and inductance in a circuit, and as wave-length can easily be figured when the frequency of the local generating system is known, the wave-length of the incoming signals must be that of the local circuit when the beat is zero. The condenser dial on the heterodyne wave-meter can thus be calibrated directly in meters and a nearly true reading of the wave-length of incoming signals obtained. (See *Beats*, also *Heterodyne* and *Wave-meter*.)

**HIGH FREQUENCY**—A very general term applied to alternating electric currents. As a rule, alternating currents having frequencies above one thousand *cycles* (q.v.) per second are referred to as high frequency currents. When the frequency is extremely high, of the order of hundreds of thousands of cycles, the current is usually referred to as high frequency, oscillatory current. There is no definite level or line of distinction between high and low frequency currents. In radio practice, the audio frequency currents are generally considered below twenty thousand cycles per second and known as low frequency currents. The radio frequency or frequencies above twenty thousand are considered as the high frequency currents, although here again there is no definite level or line of demarcation between the two areas. (See *Audio Frequency*, also *Radio Frequency* and *Frequency*.)

**HIGH FREQUENCY ALTERNATING CURRENT**—See *High Frequency Current*.

**HIGH FREQUENCY ALTERNATOR**—An alternating current machine or alternator, designed to produce currents having high frequencies, generally above one thousand cycles per second. Such machines are used in high power radio telegraph transmission

(not broadcasting) producing undamped or continuous waves. (See *Alternator*, also *Alexanderson Alternator*.)

**HIGH FREQUENCY AMPLIFICATION**—The process of stepping up or amplifying currents of high frequency. In radio circuits, the high frequency currents are known as radio frequency oscillations. In radio circuits the audio frequency (low frequency) currents and the high or radio frequency currents are usually in different parts of a circuit. When we consider alternating currents having a frequency above, say, twenty thousand cycles per second as radio frequency, and those below that limit as audio frequency, it is easy to consider the radio frequency currents as existing in all stages between the aerial and the detector. Beyond the detector, the alternating currents having become uni-directional surges, we can consider these currents as being audio frequency currents.

Thus we have a definite dividing line in any radio receiver using but one detector, the detector or rectifier marking the transition from radio frequency to audio frequency. Thus, any means of amplifying the signals before they reach the detector will be known as high frequency amplification. (See *Audio Frequency*, also *Amplifier*.)

**HIGH FREQUENCY BUZZER**—A *buzzer* (q.v.) designed to produce a very high note. The term "high frequency" in this case merely indicates that the pitch or frequency (vibration) is high in comparison with the ordinary buzzer, the sounds of course being actually of audible frequency. The general scheme of such a buzzer is about that of the ordinary type as used in conjunction with electric bells or signal systems, the armature, however, being very thin and thus permitting rapid make and break for the current. Such buzzers are used extensively in connection with crystal receivers for the purpose of testing and also for code practice. (See *Buzzer* also *High Frequency* and *Armature*.)

**HIGH FREQUENCY COMPONENT OF PLATE**—The high frequency currents present in the plate circuit of a vacuum tube receiver, as distinguished from the audio or low frequency currents. (See *Feed-Back*, also *Plate Component*, *High Frequency*, and *Regeneration*.)

**H.F.C.**—Abbreviation used abroad and occasionally in the United States for high frequency current. The more common term is radio frequency current and no abbreviation is used as a rule. (See *Radio Frequency Current*, also *High Frequency*.)

**HIGH FREQUENCY CURRENT**—Alternating currents having frequencies above certain limits, as, for example, the radio frequency currents employed in radio transmission, which are usually of a frequency above one hundred thousand cycles per second. (See *High Frequency*, also *Low Frequency* and *Radio Frequency*.)

**HIGH FREQUENCY OSCILLATION**—The term oscillation is generally applied to an alternating current of very high frequency. Thus radio frequency currents, which may run into hundreds of thousands of cycles per second, are called high frequency oscillations. (See *Oscillation*.)

**HIGH FREQUENCY RESISTANCE**—Resistance to the passage of alternating currents of high frequency. Said of wires, coils, circuits and apparatus. The resistance of a certain conductor or part of an electrical circuit, as in

radio, may be comparatively higher in the case of high frequency currents than to alternating currents of a low frequency. This is due to the "skin effect" (q.v.) it being a phenomenon of radio frequency (high frequency) currents that they have a tendency to concentrate near the surface of the conductor. For this reason, small wires are more apt to have high radio frequency resistance, as obviously the surface on which the currents can travel is restricted. (See *High Frequency*, also *Skin Effect* and *Resistance*.)

**HIGH PASS FILTER**—An arrangement of electric circuits designed to permit ready passage of high frequency alternating currents while at the same time presenting high resistance or impedance to alternating currents of low frequency, generally within certain definite limits. (See *Filter* also *Filter*, *High Pass*.)

**HIGH PRESSURE**—A term occasionally used to denote high potentials or voltages. (See *High Tension*, also *High Potential*.)

**HIGH POTENTIAL**—One of the several terms used to indicate high voltage. (See *High Potential Battery*, also *High Voltage*.)

**HIGH POTENTIAL BATTERY**—Another term for "B" battery, the battery used to supply potential to the plate of a vacuum tube. The term "high potential" is used here, only in a comparative sense, the voltage of the battery being high in proportion to that of the filament or "A" battery. High potential batteries for radio usage are generally furnished in blocks of 22½ or 45 volts. (See *High Voltage*, *High Tension* and "B" Battery.)

**HIGH RESISTANCE**—The property of any circuit whereby it offers considerable opposition to the flow of electric currents. There is no very distinct line of demarcation between high and low resistance. One of the common applications of the term is in the case of a *grid leak* or grid resistance. Here the resistance may be upward of a half million ohms, running into several million ohms in certain cases. An example of low resistance elements is that of a *rheostat* for controlling the filament current. Here the resistance is relatively low, rarely more than thirty ohms. The average resistance of the magnet windings in headphones (as used in radio) is one thousand ohms. The term "high resistance" is also used in a comparative sense in respect to various instruments or parts of radio circuits. Here the resistance in most cases should be as low as possible, and therefore a resistance of even a few ohms may be referred to as *high*. While resistance to direct currents is generally the feature of resistance coils and units, the opposition to currents of an oscillatory nature (high frequency alternating currents) may be of the utmost importance, and it is often the case that a circuit has little direct current resistance but very high resistance or impedance (q.v.) to high frequency currents. (See *Resistance*, *Impedance*, also *Skin Effect*.)

**HIGH RESISTANCE JOINT**—Any connection between two wires or conductors which offers resistance to the passage of current due to defective contact or imperfect connection through solder or any other medium. When bare wires are joined they should be carefully scraped and soldered. Too much solder is a bad feature, as the resistance of solder is naturally far higher than that of the copper wire. (See *Corrosion*, also *Soldered Joints*.)

**HIGH RESISTANCE TELEPHONES—**

Headphones or telephones used in radio reception, having high resistance windings. In the ordinary telephone receiver used with the commercial telephone systems, the windings of the telephone magnets have a relatively low resistance, generally less than one hundred ohms. Such phones would not be sufficiently sensitive for radio usage, the average resistance in this case being about one thousand ohms. The resistance here refers to the ohmic resistance of the many turns of wire wound around the magnets. This resistance is not a required feature, the factor of importance being the number of turns. Inasmuch as space is a factor to be considered, it is necessary to use very fine wire in order to permit use of the thousands of turns essential. The resistance of this fine wire is of course high. Where very high resistance windings are used—and this indicates small wire—it is sometimes advisable to use a by-pass for the heavy plate potentials to protect the windings. (See *Ampere Turns*, also *Output Transformer* and *High Resistance*.)

**HIGH SPEED RECEPTION AND TRANSMISSION—**

The reception or transmission of radio messages by automatic means in order to obtain much greater speed than would be possible under the manual system or hand operating and recording. The general practice is to record the messages to be transmitted on a tape by means of a punching machine. They are then sent automatically through a high speed automatic transmitter and received automatically at the same high speed by a machine which punches the messages or records them on some form of tape or sheet. The more common of these methods is the *Wheatstone Transmitter*. (q.v.)

**HIGH TENSION—**

One of the numerous terms used to denote high voltage. "B" batteries as used in radio reception are generally known as high tension batteries to distinguish them from the low voltage storage battery or dry cells used to light the filaments. Abbreviation H. T. mostly used in magazines and books printed in England.

**HIGH TENSION BATTERY—**

Term applied to "B" batteries used in radio reception to supply potential to the plates of the vacuum tubes. These batteries usually are in blocks of twenty-two and a half or forty-five volts. (See *"B" Battery*.)

**HIGH TENSION CIRCUIT—**

Term occasionally applied to the part of a radio circuit in which high potentials are present, as in the plate circuit of a vacuum tube. Here the "B" battery is in the circuit. (See *High Tension*, also *"B" Battery*.)

**HIGH TENSION INSULATOR—**

Insulators of large dimension and rugged design, possessing unusual insulating properties in order to withstand high



A high potential insulator.

voltages. As a rule such insulators are made of high grade porcelain and arranged with annular ridges or "petticoats" to give greater surface and reduce the possibility of surface leakage. The illustration shows a form of high tension or high potential insulator. (See *Insulator*, *High Tension*, also *Petticoat Insulators*.)

**HIGH VACUUM—**A term applied to vacuum tubes when they have been highly exhausted of air. That is, an almost perfect vacuum. When a vacuum tube has a very good vacuum—has been highly evacuated of gases—it is generally called a "hard" tube. A high vacuum is essential in tubes to be used as amplifiers or for transmission. (See *Vacuum Tubes*, *Theory of Operation*.)

**HIGH VOLTAGE—**A very indefinite term, used in ordinary electrical practice to denote voltages above 600, but applied in radio practice to much lower potentials, as, for example, a "B" battery, which is generally referred to as a high voltage battery in spite of being generally below 100 volts. The term used in this sense is one of comparison with the low voltage of a storage or other type of "A" battery. (See *Voltage*, also *Potential*.)

**HIGHLY DAMPED WAVES—**An expression applied to waves or trains of waves wherein the amplitude or strength of each succeeding oscillation or train of oscillations is greatly decreased. If the progressive decrease in amplitude or strength is very gradual, that is, if the waves die out slowly, they are said to be feebly damped, but if they die out rapidly they are referred to as being highly damped. (See *Damped Waves*, also *Decrement* and *Amplitude*.)

**HOGAN, JOHN V. L.—**American radio expert. Born at Philadelphia, Pa. He was educated at Sheffield Scientific School, Yale University, where he



John V. L. Hogan.

made a special study of physics and mathematics. In 1906 he became assistant to Dr. Lee De Forest, and in 1909 he joined the National Electric Signalling Co. In 1914 he was appointed chief research engineer to the International Radiotelegraphic Company. Hogan has written many articles on radio and is a past president of the Institute of Radio Engineers, member of the American Institute of Electrical Engineers, of the American Association for the Advancement of Science, of the Radio Club of America and other societies.

**HOMOPOLAR—**Synonymous with unipolar. Having but one pole. Said of a dynamo having its conductor or armature rotating around a single pole of a field magnet. (See *Multi-Polar*.)

**HONEYCOMB COIL—**A coil used in radio, having a peculiar construction, somewhat similar to a honeycomb. The illustration shows a typical honeycomb coil used as an inductance in re-

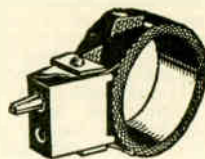

Honeycomb coil used in radio reception.

ceiving circuits. The object of this staggered winding system is to reduce the self-capacity between wires to a minimum without reducing the inductive value. The chief value of such a winding method is that it permits the retaining of high inductance value in a limited space, without undue high frequency resistance (q.v.). (See *Inductance*, *Distributed Capacity* and *High Frequency Resistance*.)

**HOOK UP—**The general term in the United States to designate the diagram for any complete radio receiver or transmitter, or for any specific part of such a circuit. Thus, when we refer to a hook-up for Radio receiver, we mean a diagram, either schematic (using symbols for the parts) or perspective (showing pictures of the parts) which gives the various parts necessary and the manner of connecting them to each other to form the

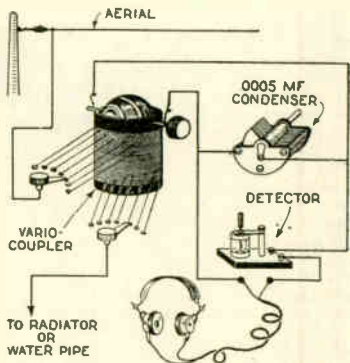
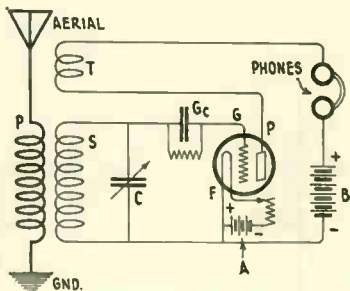

The upper diagram is in schematic form and shows a single tube regenerative receiver, and the lower diagram is in perspective form and shows a crystal receiving set.

complete circuit. Similarly we may use the term "hook-up" to describe a sketch or circuit for connecting various instruments such as *ammeters*, or *voltmeters*, *wavemeters* and the like. (See *Circuit*, also *Diagram*.)



**HOOPER, STANFORD C.**—American Naval wireless expert. Born August 16, 1884, at Colton, California, and educated at San Bernardino, California. He joined the Southern Pacific Company as a telegraph operator. In 1901 he entered the Naval Academy at Annapolis, and entering the Navy was advanced to Commander in 1918. From 1910-11 he was instructor in electrical engineering, physics and chemistry at the U. S. Naval Academy, and in 1912-13 Fleet Radio Officer of the United States Atlantic Fleet. During the great war he was responsible for the supply of wireless instruments, etc., for the American Navy, and he was also responsible for the construction of many of the larger American wireless stations including those at Annapolis, San Diego and Pearl Harbor. Hooper was one of the chief men concerned with the radio-compass system now used in the American Navy.

**HORIZONTAL AERIALS**—Aerials—overhead wire systems—for the recep-

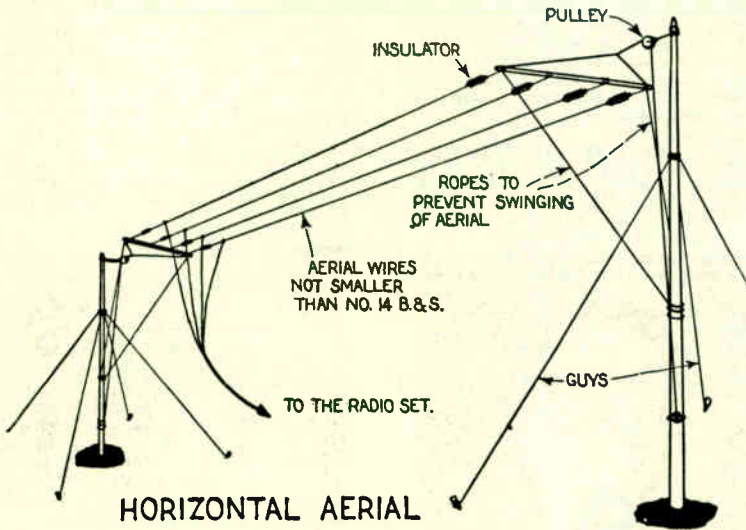

**HORIZONTAL AERIAL**

A horizontal aerial of the inverted "L" type.

tion or transmission of radio signals, wherein the major portion of the aerial is horizontal—parallel to the earth's surface. Typical examples are the "T" and inverted "L" aerials. In the former type, the flat portion suspended horizontally between two supporting structures and a lead-in wire is attached to the center and thence to the apparatus. In the latter type, the lead-in is attached to either end, giving a shape somewhat similar to an inverted L, from which the name is derived. The more common term is "flat top." This term is now somewhat ambiguous, as single wire aerials are used more or less extensively for receiving purposes, whereas formerly a system of several horizontal wires was employed. (See *Flat Top Aerial* or *Antenna*, also *Aerial T Type* and *Inverted I Aerial*.)

**HORN, LOUSPEAKER**—A device, generally in the shape of a horn, used in conjunction with a heavy duty telephone receiver or loudspeaker unit, to reproduce loudly the signals or music from a radio receiver. In operation, the horn has attached to it at its small end a unit or telephone receiver.

When the diaphragm of the unit is actuated by the signals, speech or music, the column of air in the open tube is displaced, creating audible

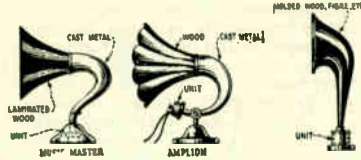

Three types of horn loudspeaker.

sounds which can be heard at a distance or throughout a room. Assuming other conditions equal, the volume will be more or less in proportion to the size of the horn, or more specifically to the amount of air displaced by the signals. When a telephone receiver is used without horn, the opening above the diaphragm being unconfined, only a small column of air is displaced and the volume will not be

nary usage and the customary unit is the watt, which is equal to 10<sup>7</sup> ergs per second. The unit used in electrical power work is still larger; it is the kilowatt or one thousand watts. (See *Units*, also *Watts*.)

**HORSESHOE MAGNET**—A magnet (q.v.) in the shape of a horseshoe or letter U, both poles being brought



Fig. 1. A permanent horseshoe magnet.

nearer together so that they may act on the armature or "keeper." Generally a magnetized steel bar which retains its magnetism for a long

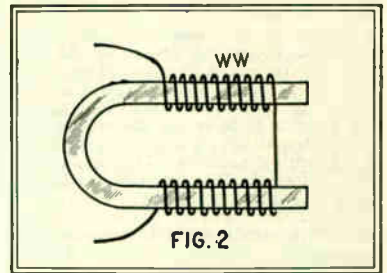

FIG. 2

Fig. 2. A horseshoe electromagnet.

period. The illustration, Fig. 1, shows a permanent horseshoe magnet. Such magnets are also used with external power, then being termed *electromagnets*. In this case the magnet is made of soft iron. The illustration, Fig. 2, shows a horseshoe *electromagnet*. Here the magnetic attraction is supplied by application of an external electric force to the windings WW, and the magnet being of soft iron, loses its magnetic attraction almost immediately upon withdrawal of the electric current, magnetizing force. (See *Telephone Receiver*, also *Electromagnet*.)

**HOT-WIRE AMMETER**—An ammeter, or instrument for measuring electric current amperes, which depends for its action on the expansion of a fine wire under the influences of the heat produced in it, by the passage of the electric current to be measured. In the illustration the current to be measured is passed through the fine resistance wire A-B. P is a pointer moving over a graduated scale, and attached at its other end to a coiled spring S, which in turn is attached to the wire A-B by the silk thread T. The tendency of the spring is to move the pointer to the right, but owing to the pull of the thread in the normal position of the wire A-B, the pointer rests at zero at the left of the scale. As current is passed through the wire A-B, it heats and expands, thus permitting more or less slack to occur in the thread T and allowing the spring S to move the pointer over the scale toward the right. As soon as the current is withdrawn, the wire cools and contracts to its former size, thus again restoring the tension to the thread and

great under ordinary circumstances. When a horn is attached, however, the sound being confined will displace a relatively greater amount of air—depending mainly on the shape and size of the horn—and the volume will be measurably greater. (See *Loudspeaker*, also *Acoustics* and *Loudspeaker Units*.)

**HORSE POWER**—The unit of power used in the United States and Great Britain. It is defined as the power required to lift 550 pounds to a height of one foot in one second, or similarly, 33,000 pounds to that height in a minute. The term "foot-pounds" is derived from this value. Thus, one horsepower is the power required to perform 550 foot-pounds of work per second of time. (See *Horse Power*, *Electrical*.)

**HORSE POWER, ELECTRICAL**—The unit of electrical work similar to the mechanical horse power. It is actually mechanical horse power expressed in *watts* (q.v.). One electrical horse power is equivalent to 746 watts. In the *centimeter gram second* (q.v.) system of units, the unit of work is the *erg*. This unit is too small for ordi-

## Hot Wire Instruments

returning the pointer to zero. Hot Wire ammeters are used extensively for measurement of currents at radio frequency, that is, extremely high frequency as in radio transmission. The

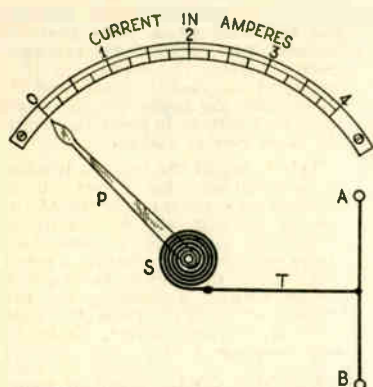

Illustration showing operation of a hot wire ammeter.

average ammeter using a coil of fine wire would not be adaptable to this use, as the high voltage, high frequency current would burn out the coil. In addition to this, the length of these windings would affect the circuit and probably throw it out of resonance (q.v.). (See *Ammeter* or *Ampere Meter*, *Frequency*, *Resonance*, also *Instrument Shunts*.)

**HOT WIRE INSTRUMENTS**—Current measuring instruments which utilize the tendency of a fine wire to sag or expand under the heat caused by passage of an electric current through it. Such instruments may be used for direct or alternating current. (See *Hot Wire Ammeter*.)

**HOT WIRE OSCILLOGRAPH**—See *Oscillograph*.

**HOT WIRE TELEPHONE**—See *Thermal Telephone*.

**HOT WIRE WATTMETER**—An instrument used to measure combined volts and amperes, i. e., watts in a circuit. It comprises essentially a mirror, which is deflected according to the difference in expansion of two fine wires. (See *Hot Wire Instruments*, also *Wattmeter*.)

**HOUR METER, AMPERE**—An instrument used extensively in connection with storage batteries, to measure the input or output in amperes per hour. (*Ammeter* or *Ampere Meter*.)

**HOUSE MAINS**—A term much used in connection with storage battery charger and battery elimination devices. The term implies the main circuit of any standard house lighting system, either direct or alternating current. Thus in the case of a rectifier for charging storage batteries from alternating current, a lead is provided for connecting to the house mains, offering a means for introducing the required current into the device. (See *Current Direct*, also *Alternating Current* and *Chargers*, *Storage Battery*.)

**HOWLING**—The general term used to imply any undesired sounds produced in or by a radio receiver. Howling is usually caused by *feed-back effects* (q.v.). The most common example of

howling is in the case of a regenerative receiver. Here the detector tube may have a tendency to generate its own oscillations. As long as these oscillations are equal in frequency to any incoming signals there will be no howling, but should these local oscillations differ in frequency from the incoming series of signals, the result will be a howl resulting from the *beats* (q.v.) established owing to the difference between the two sets of oscillations. This is essentially the principle of *heterodyne* or "beat" reception, but in the case of a heterodyne, the effect is utilized, whereas in the case of a regenerative receiver it is undesirable. Interaction between various parts or different parts of a circuit may often lead to howling. (See *Feed-Back*, also *Regeneration*, *Reflex*, *Beats* and *Re-Radiation*.)

**H. P.**—Abbreviation sometimes used in radio for *high potential* or *high pressure*. In mechanics it is the standard abbreviation for *horse power*.

**HOZIER-BROWN DETECTOR**—A form of electrolytic detector, which, however, does not use a liquid electrolyte. It consists of a small pellet of lead oxide held more or less rigidly between two electrodes, one platinum and the other lead. (See *Detector*, also *Electrolytic Detector*.)

**HYDROGEN**—A gaseous chemical element. The symbol is H and its specific gravity is taken as 1, that of air being 14.4. It is colorless, tasteless and odorless and is the lightest known body. Hydrogen is a constituent of water, which is composed of one atom of oxygen and two atoms of hydrogen according to the chemical formula for water, H<sub>2</sub>O. Hydrogen is used in radio transmission in connection with *arc generators*. (q.v.) (See *Poulsen Arc*.)

**HYDROMETER**—An instrument used to measure the *specific gravity* (q.v.) of a liquid. In radio it has an extensive use in connection with storage batter-

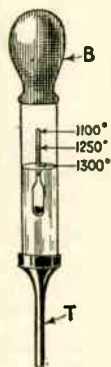

Hydrometer used to test the specific gravity of liquids.

ies. Various types of hydrometers are used to indicate the specific gravity of the electrolyte of a storage battery and hence in a manner, to indicate the state of charge of the battery. The illustration shows the standard form of hydrometer using a weighted float. In the illustration the float is shown inside the barrel of the instrument. In operation the bulb B is compressed and the tube T inserted in the open vent of a storage battery. When pressure

on the bulb is released some of the electrolyte is drawn up inside the barrel and the float rises more or less within the barrel in proportion to the specific gravity or density of the electrolyte. With the hydrometer held in the manner shown, that is, upright, the numbers just at the level of the liquid in the barrel indicate the specific gravity. Thus, if the reading is 1250° or higher the battery is considered in fairly good operating condition—full charge being 1280° to 1300°. If the reading is below 1200° it indicates the need of charging, these levels not being arbitrary, a discharged condition being indicated by a reading of 1150° or lower. The use of a hydrometer is generally advisable and the reading accurate under ordinary conditions. If, however, water has just been placed in the battery, the reading may not be accurate for several hours due to the fact that the water and acid may not mix immediately. (See *Storage Battery Tests*, also *Electrolyte*.)

**HYGROSCOPIC EFFECT**—The effect in any substance which permit it to absorb moisture. In the case of forms or tubes for radio coils and inductances this feature is particularly undesirable, as obviously, moisture lowers the dielectric value of the form and may cause it to warp. (See *Bakelite*, also *Tubing*.)

**HYSTERESIS**—The tendency of magnetization to lag behind the magnetizing force as, for instance, in an iron core in a *transformer* (q.v.). When the core of such a transformer is undergoing rapid reversals of magnetism, there is often an expenditure of energy which is not useful and which is converted into heat, thus representing a loss in power. This effect is more noticeable with certain qualities of iron. In other words, when rapid reversals of magnetism take place in a poor quality of iron core it may display a certain sluggishness. This is actually the lagging of the magnetic flux behind the magnetizing force producing it. This loss of energy is assumed due to the work required to alter the position of the molecules of the iron composing the core and the less energy expended in this manner the less the hysteretic losses. In designing transformers or armature cores, hysteresis must be taken into consideration and the iron must be of high quality to hold these losses at a minimum. (See *Eddy Currents*, also *Core*, *Transformer*.)

**HYSTERESIS COEFFICIENT**—The amount of energy wasted or lost in the process of magnetizing and de-magnetizing a unit volume of magnetic material is referred to as the hysteresis coefficient of that material. (See *Hysteresis*, also *Coefficient*.)

**HYSTERESIS LOOP**—Graphic illustration of losses due to hysteresis in any sample of core material. Loops are plotted in graphic curves of cycles of magnetization. (See *Curve*, also *Hysteresis*.)

**HYSTERESIS LOSSES**—The energy wasted or lost through hysteresis. (See *Hysteresis*.)

**HYSTERETIC LAG**—The lagging of magnetization due to the effect of hysteresis. (See *Hysteresis*, also *Magnetization*.)

# I

**I**—The abbreviation adopted by the *International Electrotechnical Commission* (q.v.) and American Institute of Electrical Engineers, to denote current in amperes. The small or lower case (i) may also be used where the capital letter is not advisable. (See *Current*.)

**I** **ARMATURE**—An armature used in generating machines, having a core resembling the letter I in shape. (See *Armature*, also *Core*.)

**I.C.W.**—The customary abbreviation for "interrupted continuous waves." This is a system of radio transmission wherein the waves are modulated at a constant low frequency. (See *Interrupted Continuous Waves*, also *Modulation*.)

**IDLE CURRENT**—A name often applied to the component of an alternating current which contributes nothing to the power. This is also known as the *wattless component* (q.v.) or the *wattless current* (q.v.). It represents the component which, being in quadrature with the electromotive force in the circuit, thus has no active value—adds nothing to the total power. (See *Current*, also *Electromotive Force* and *Alternating Current*.)

**I.E.C.**—The abbreviation for *International Electrotechnical Commission*, the body which suggested the international electrical and magnetic abbreviations and symbols. (See *Symbols*, also *Units*.)

**IMPACT OR SHOCK EXCITATION**—The method of producing *free oscillations* (q.v.) in a circuit by means of an exciting current of short duration compared to that of the resultant oscillations. The term is a general one and broadly covers the various methods of generating oscillations in which an oscillatory circuit is thrown into elec-

trical vibration at its natural or fundamental frequency by means of an electromotive shock or exciting force of short duration. Also covers the term *Impulse Excitation*. (See *Oscillations*, also *Fundamental Frequency*.)

**IMPACT TRANSMITTER**—Apparatus for transmitting radio waves wherein the transfer of energy from the pri-

mary or exciting circuit to the oscillatory circuit takes place during one pulse or vibration of the exciting current. (See *Impact or Shock Excitation*, also *Transmitter*.)

**IMPEDANCE**—The total resistance to the flow of alternating current in a circuit. Impedance combines the ohmic resistance and the apparent resistance due to self-induction. When a direct electromotive force is impressed on a circuit, the current flowing in that circuit depends directly on the ohmic resistance of the circuit. The formula is according to Ohm's law  $I = \frac{E}{R}$

I representing the current in amperes, R the resistance in ohms and E the electromotive force in volts. Now if this direct electromotive force is replaced by an alternating EMF (electromotive force) and the ohmic resistance remains the same, the total resistance of the circuit to the alternating EMF will nevertheless be greater than in the case of direct current. Now the ohmic resistance is still the same but we have added to it the apparent resistance due to the self-induction of the circuit. In other words the inductance of the circuit has a marked effect on the current flowing in the circuit. What actually occurs is that the self-induction sets up a *counter-electromotive force* (q.v.) which continues to act against the impressed EMF as long as the flow of current persists. The result is a reduction in the current flowing in the circuit, the EMF having been, in effect, reduced, and hence according to the law above,  $I = \frac{E}{R}$

the current is less. This added resistance, due to self-induction, is referred to as *reactance* and the flow of current

actually wastes or dissipates a certain amount of energy. In the alternating current circuit, the ohmic resistance has the same effect. The reactance, however, does not dissipate energy. It merely reduces the effective EMF by means of the counter EMF and thus necessitates the application of a higher impressed voltage in order to maintain the same flow of current.

This is one of the major advantages of alternating over direct current. Alternating current can be transformed readily and can also be readily controlled by means of a reactance or choke coil, which by creating a counter EMF limits the current flowing in the circuit without dissipating any great amount of energy. (See *Alternating Current*, *Current Direct*, *Choke Coil*, and *Reactance*.)

**IMPEDANCE COIL**—A coil of wire or induction coil, generally wound on an iron core, used in alternating current circuits to limit the current flowing in the circuit. In action such a coil serves through the medium of its self-induction, to create a counter electromotive force which acts against the impressed EMF (electromotive force) and thus reduces the current in the circuit according to ohm's law that the current is equivalent to the EMF in volts, divided by the resistance in ohms. An impedance coil is also known as a choke coil although the two may have somewhat different meanings. For example, a choke coil might be used in either direct or alternating current circuits, whereas an impedance coil as its name indicates, offers impedance, an effect only present in alternating current circuits. The simplest formula for impedance of a coil is the following:  $\text{Impedance} = \sqrt{R^2 + PL^2}$ . Here it is

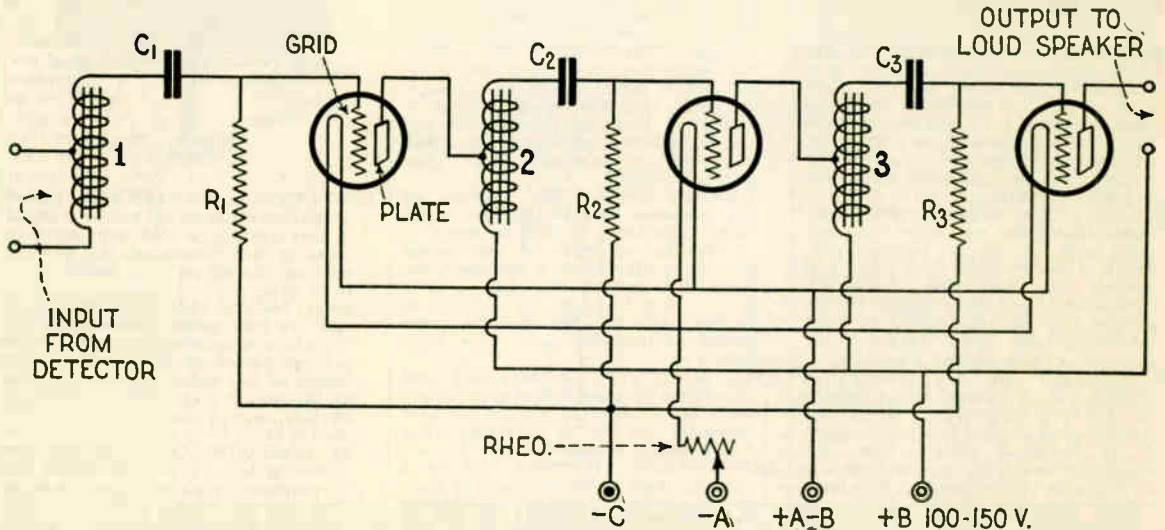

Schematic diagram of an impedance coupled audio frequency amplifier. (See *Impedance Coupled Amplifier*.)

in an alternating current circuit is thus governed by the ohmic resistance and the reactance. The application of the term "apparent resistance" to describe the added resistance due to self-induction, is a concession to the fact that it is not actually resistance in the proper sense of the word. In a direct current circuit, the resistance

assumed that the current takes the form of a *sine wave* (q.v.), then R is the resistance of the coil, L the coefficient of self-induction in henries and p is  $2\pi$  times the number of alternations per second. (See *Choke Coil*, *Alternating Current*, *Current Direct*, *Reactance*, *Impedance*, also *Impedance Coupled Amplifier*.)

**IMPEDANCE COUPLED AMPLIFIER**

—A system of amplifying radio signals, voice or music, whereby the successive stages are coupled or joined by means of impedance coils. This system is much used in audio amplifiers, the amplification being much more uniform over the necessary range of frequencies than in the case of the ordinary audio frequency transformer. This is also known as choke coil coupling or choke coil amplification. The illustration on the preceding page shows a typical impedance coupled amplifier for audio frequency currents. It will be noted that three stages are used. This is necessary owing to the lower amplification per stage. Using this system, then, three stages are necessary in place of the customary two stages of transformer coupled amplification. In the illustration, which is a schematic diagram of the circuit for such an amplifier, the impedances 1, 2 and 3 are in the form of *auto transformers*. (q.v.) R1, R2 and R3 are grid leaks ranging in value between one quarter megohm and one and one-half megohms. C1, C2 and C3 are stopping condensers of about 1 micro-farad capacity each. The variations in potential are transferred successively from stage to stage, the amplification factor being roughly the sum of the individual factors of the tubes. In other words the ratio of the windings of the impedances is one to one, or unity, and therefore no voltage amplification takes place. The resistances are the usual grid leaks and the condensers C1, C2 and C3 are to block the high plate voltages from the grids of the succeeding tubes. (See *Tuned Impedance, also Amplifier and Vacuum Tube Amplifiers, Theory of.*)

**IMPEDANCE FACTOR**—The ratio of the impedance to the ohmic resistance in an alternating current circuit. (See *Impedance, also Resistance.*)

**IMPEDANCES, MATCHED**—Arrangement of an amplifying circuit and the choice of an audio transformer or loudspeaker with due regard for the impedance of the circuit. Thus if the impedance of a certain amplifier tube is 10,000 ohms, and the resistance of a loudspeaker unit being used is 2,500 ohms, then for maximum response when used with an *output transformer* (q.v.) the impedance of the primary of the transformer should be equivalent to the total or 12,500 ohms. (See *Matched Impedances.*)

**IMPREGNATED INSULATING MATERIALS**—Cloth or paper impregnated with an oily or resinous substance to render it moisture proof and improve the insulating properties. Cardboard is sometimes treated in this manner and used for tubing to wind inductance coils. (See *Empire Cloth or Paper, also Insulating Property.*)

**IMPRESSED ELECTROMOTIVE FORCE**—The term used to distinguish the EMF (electromotive force) impressed on or applied to a certain part of an electrical circuit from the counter or back-electromotive force due to constants of the circuit. The term is sometimes used where a direct current is applied in a circuit, but it should be confined to use where a counter EMF (electromotive force) is present. (See *Counter Electromotive Force, also Choke or Choking and Reactance.*)

**IMPRESSED FIELD**—An electric or magnetic field of force impressed on or applied to a body or region (area) for the purpose of producing other fields of force. (See *Field.*)

**IMPULSE**—Electrically, an electromo-

tive force which produces an impulsive rush or discharge of electricity. The term is used to distinguish between this form and an electromotive force producing a steady flow of current. (See *Current, also Electromotive Force.*)

**IMPULSE E.M.F.**—The more specific term designating an EMF (electromotive force) which produces an impulsive rush or discharge of electricity. It is defined technically, as having a maximum value which is large compared with its average value, the average value being taken over a time equivalent to the *time-constant* (q.v.) of the circuit on which the EMF is impressed. (See *Current, also Electromotive Force.*)

**IMPULSE EXCITATION**—Method of exciting or starting oscillations in a circuit, such as the aerial circuit of a transmitter, by a sudden surge of impulse EMF (electromotive force) rather than by application of oscillations of the frequency of the circuit.

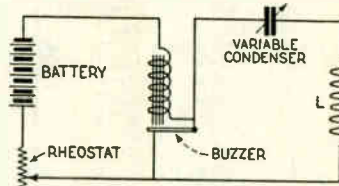

Connections of buzzer for generating damped oscillations suitable for testing by impulse excitation.

This system of impulse or shock excitation may be used for transmission and also has application in connection with testing or comparing of wavemeters. The illustration shows a buzzer connected with the necessary components to form a source of high frequency oscillations. This system is capable of producing through coupling from the coil L, currents by shock excitation. These currents can be used in a variety of ways for testing purposes. In operation the condenser is charged to the voltage of the battery at the instant the buzzer contact is open and when the contact closes, discharges through the coil L thus furnishing a series of oscillations to surge through the coil and by inductive coupling to any other coil placed in proximity to it. (See *Buzzer Exciter.*)

**INCANDESCENCE**—The glowing of any substance when brought to a white heat. The term is used in radio to signify the condition of the heated cathode or filament in a vacuum tube. In order to produce *electrons* (q.v.) it is necessary to cause the filament to become white hot, the condition being known as incandescence. (See *Filament.*)

**INCONDUCTIVITY**—A little used term signifying the condition of a substance by virtue of which it will not act as a conductor for electric currents. (See *Conductivity, Specific.*)

**INDEPENDENT UNIT**—A unit of a quantity, such as length, mass or time, chosen arbitrarily and without having any relation to any other unit. (*Centimeter Gram Second, or C. G. S., also Fundamental Units.*)

**INDICATING INSTRUMENTS**—Any instrument or device which indicates values, as for example, a *voltmeter* or *ammeter*. (q.v.) (See *Instruments, Measuring.*)

**INDIRECT CURRENT**—Term for alternating current—now obsolete. (See *Alternating Current.*)

**INDUCED CURRENT**—The current in

a circuit due to an induced EMF (electromotive force). The current produced by an EMF induced in a circuit due to a change in the magnetic flux linking the circuit with another. (See *Induced EMF, also Induction.*)

**INDUCED E.M.F.**—The electromotive force induced in a conductor or body. The phenomena of induced EMF (electromotive force) is the basis of operation of generating machines. Here a conductor is rotated or moved in a field of force, the action causing a change in the flux lines linking the circuits or the conductor. An EMF may also be induced by placing a coil in inductive relation to another coil through which alternating current is passing. Here the transfer is caused by induction. (See *Induction.*)

**INDUCTANCE**—The broad term used to designate any wire wound coil as used in radio practice for tuning units, inductive couplers and any variety of purpose. Actually the term is derived from self-induction or self-inductance, a property of a coil of wire by virtue of which it sets up a counter EMF (electromotive force) which serves to oppose the original EMF passing through it. When a certain circuit has inductance, it is to say that a number of turns of wire possessing self-induction are present in the circuit. The greater the inductance in a circuit the greater its opposition to the passage of an alternating current. The unit of inductance is the Henry. This is defined as the self-induction of a circuit or coil when the induced EMF is one volt with the inducing current varying at the rate of one ampere per second. (See *Alternating Current, Henry, also Inductance Coils.*)

A type of antenna inductance used in radio transmission.

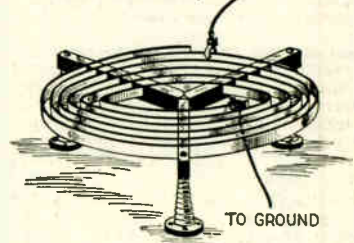

**INDUCTANCE, ANTENNA**—Inductance (coil) placed in antenna circuit of transmitting set for purpose of increasing wavelength of the open or antenna circuit to any desired level. It is generally referred to as an antenna loading inductance or loading coil. In high power transmitting stations it is very often the case that the natural period or fundamental wavelength of the antenna is not as great as the intended operating wavelength. In this case a loading inductance is used to bring it up to the desired value. In some instances the fundamental wavelength is too high, in which case a condenser is placed in series to reduce the wavelength and then a few turns of inductance placed in series with the condenser and antenna for the purpose of tuning. Such inductances must be of a very rugged nature when high power is used, generally consisting of a comparatively few turns of heavy copper ribbon mounted on high tension insulators. The illustration shows a common form of antenna inductance used in radio transmission. (See *Loading Inductance, also Tuned Antenna.*)

**INDUCTANCE COILS**—Any coil of wire wound in such a manner as to possess the property of self-induction. Such a coil may be in almost any conceivable form, providing the turns are separated or insulated from each other. Inductance coils are a very necessary part of



Honeycomb type inductance coils.

radio circuits, being used in conjunction with condensers to obtain resonance or desired wave-length. Such coils can also be arranged as separate circuits and placed in inductive relation to each other, thus permitting energy present in one to be transferred through induction to the other. The

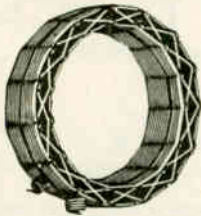

Low-loss air-wound inductance coil made especially for tuned radio frequency work.

most common example of inductance in a receiving set is that of a tuning coil or vario-coupler. The illustration shows several forms of inductances known as tuning inductances. (See under separate headings as follows: *Inductance, Loading, Tuning, Tapped*, also *Inductance, Units of*.)

**INDUCTANCE, DISTRIBUTED**—Added inductance distributed throughout the length of a cable or telephone line to compensate for the capacity of the line. (See *Distributed Inductance*.)

**INDUCTANCE, LOADING**—Literally an inductance to load a circuit. The term is used to designate any inductance coil or unit used in series with the antenna for the purpose of increasing the wave-length of the circuit. (See *Inductance, Antenna*.)

**INDUCTANCE, MEASUREMENT OF**—Any process or means of determining the inductance value of a coil or circuit. The usual method is by formula. (Fully described under *Measurement of Inductance*.)

**INDUCTANCE, MUTUAL**—Symbol *M*. The number of linkages of flux lines or the flux that is common or mutual to two circuits which are adjacent to each other or inductively coupled. It is generally defined as the amount of the flux (q.v.) which is common to two linked circuits per unit of current flowing in the inducing circuit. In the illustration circuit A contains an inductance *L*, which is being traversed by an alternating electromotive force. Circuit B contains merely an inductance *L*, and a measuring device, *M*. Now, as the alternating E.M.F. passes

through coil *L*, it sets up a field of force, or rather flux lines as shown. These lines link with the coil *L*, and an alternating E.M.F. is set up. Now, suppose that the inducing current flowing in circuit A is changing at the rate of one ampere per second and an E.M.F. of one volt is induced in the circuit B, or rather in coil *L*. We then say that the mutual inductance of the two circuits will be one henry. This is the same unit used for self-inductance and in fact, mutual inductance and self-inductance are virtually the same thing.

The effect of mutual inductance must be taken into consideration when measuring the fundamental wave-length, capacity or inductance of an antenna. That is to say, where a number of parallel wires are used, the mutual in-

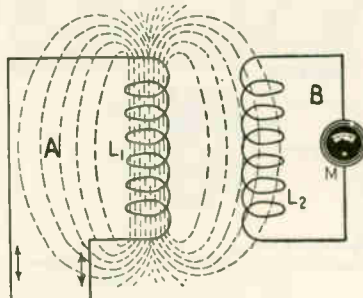

ALTERNATING E.M.F.

Diagram which illustrates the mutual inductance between coil *L*, in circuit A and coil *L*, in circuit B.

ductance between them must be taken into consideration as well as other values or constants. (See *Self-Inductance, Mutual Inductance, Induction, Coupling and Induced E.M.F.*)

**INDUCTANCE, REACTANCE**—Symbol *x*—The reactance present in a coil possessing self-inductance. The self-inductance in such a coil opposes the flow of alternating current due to the back electromotive force set up as a result of the changing magnetic field of the current. *Inductance reactance* (or *inductive reactance*) is the term used to define this opposition. *Inductance reactance* acts similarly to *resistance* (q.v.) in that it opposes the flow of an electric current. It is measured in *ohms* (q.v.), just as *resistance* is measured. It should be noted, however, that *inductance reactance* only opposes the flow of alternating currents, whereas *resistance* opposes the flow of both direct and alternating currents. Furthermore, *resistance* in offering opposition to current flow consumes power, while *inductance reactance* merely takes up energy from the circuit momentarily while current is increasing and thereafter gives it back while the current is decreasing.

The combined opposition offered to the flow of alternating current by the *resistance* and the *inductance reactance* of a circuit is called the *impedance* (q.v.) of that circuit. The voltage drop due to *resistance* is in *phase* (q.v.) with the current. The voltage drop due to *inductance reactance* is 90 degrees in advance of the current.

Expressed as a formula,  $x = \sqrt{Z^2 - R^2}$ , where *x* is the inductance reactance, *Z* is the impedance and *R* is the resistance, all measured in *ohms*.

Knowing the *frequency* (q.v.) of the alternating current and the inductance of the circuit through which this current flows, it is possible to calculate the

*inductance reactance* by using the formula  $x = 2\pi fL$ , where  $\pi$  is a constant equal to 3.1416, *f* is the frequency in *cycles per second*, and *L* is the *inductance* of the circuit in *henry's* (q.v.). This formula is sometimes abbreviated by substituting the symbol  $\omega$  (omega) for  $2\pi f$ . From the formula it can be seen that the *inductance reactance* increases directly both with the inductance of the circuit and with the frequency of the current flowing. (See *Current*, also *Electromotive Force, Resistance, Reactance*.)

**INDUCTANCE, RECEIVING**—Broadly, any form of inductance used in receiving circuits. The term thus includes

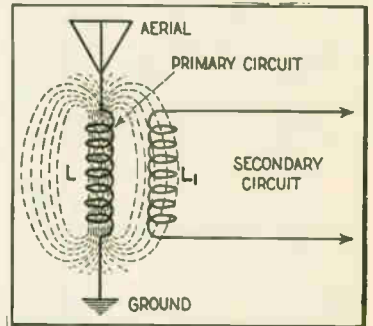

A form of tuning inductance sometimes used in radio receiving sets.

all types of coils for tuning purposes, such as couplers, tuned transformers, variometers, etc. The illustration shows a common form of tuning inductance. Here the coil *L* is an inductance in the aerial circuit and *L*, the coil in the secondary circuit. Here the energy from the aerial traverses coil *L* and by induction is transferred to coil *L*. (See *Tuning Coil, Vario-Coupler, Receiving Circuit*.)

**INDUCTANCE, SELF**—Symbol *L*—An alternate term with self-induction for the *inductance* (q.v.) due to the field of force produced by the circuit itself. It is virtually the same as *mutual inductance*. For example, in a coil of wire being traversed by alternating currents the adjacent turns may act upon each other on the principle of mutual induction between two separate adjacent circuits. The induced currents are the result of self-induction. (See *Self-Induction*, also *Mutual Inductance and Induction*.)

**INDUCTANCE, TAPPED**—Any type of inductance having taps for connecting at different points on the coil in order

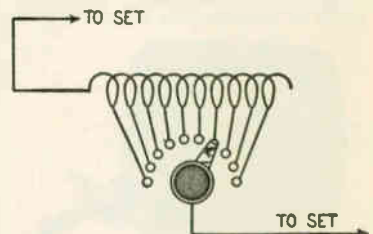

A tapped inductance which permits inductance to be added or taken out of the circuit by rotating the lever switch.

to vary the inductance value. The illustration shows a form of tapped inductance. Here the taps at different portions of the coil are connected to switch points and the switch lever permits instant change to any of the available values. (See *Inductance Coils*, also *Tuning Coil*.)

## Inductance, Units of

**INDUCTANCE, UNITS OF**—The measuring units for inductance. The practical unit is the henry (H), the value of inductance which, if current varies at the rate of one ampere each second, results in an induced electromotive force (q.v.) of one volt. When we speak of an induced E.M.F. of one volt, the volt is used as a practical unit. Under the electromagnetic system of units, the absolute unit of induced E.M.F. is known as the abvolt. This unit is very small, 100,000,000 of them being required to equal one volt. We thus say that the volt of induced E.M.F. is equal to  $1 \times 10^8$  abvolts. The electromagnetic unit of E.M.F., or the abvolt, is defined as the E.M.F. induced in a conductor cutting one line of magnetic force each second. As we have shown that one volt is equal to  $1 \times 10^8$  abvolts of induced E.M.F., and since one ampere is equal to  $1 \times 10^{-3}$  abamps of current (see *Units, Electromagnetic*) then the unit of inductance or one henry =  $\frac{1 \times 10^8}{1 \times 10^{-3}}$

or  $1 \times 10^8$  abhenrys. The unit of inductance (the henry) being too large for practical purposes, the *milli-henry* (one-thousandth henry) or the *micro-henry* (one-millionth henry) are commonly used. Occasionally the *centimeter* is used as a measure of inductance, being the thousandth part of a microhenry or a *milli-micro-henry*. The milli-henry is written as  $1 \times 10^{-3}$  henry, the micro-henry as  $1 \times 10^{-6}$  henry, and the centimeter as  $1 \times 10^{-9}$  henry. (See *Induced Current, Induced E.M.F., Induction, Electromagnetic, also Units.*)

**INDUCTANCE, VARIABLE**—Any coil possessing self-inductance and being arranged in such a manner that the value of the inductance can be changed at will. The simplest form of variable inductance is the sliding contact tuner. This is merely a coil of wire of any pre-

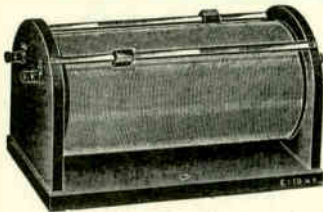

A sliding contact tuner formerly used in radio receiving sets.

determined value (maximum) mounted and arranged with a sliding contact moving over the wires, which are bared of insulation at a certain point

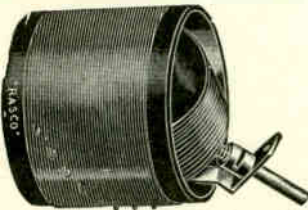

Illustration by courtesy of Radio Specialty Co. Variable inductance known as a variocoupler.

to permit contact. By using the sliding contact as one connection and either end of the coil as the other lead, the effective value of the inductance in the circuit may be varied within the limits of the coil itself. Other forms of variable inductance include the variometer, vario-coupler and various

modifications. The illustration shows the two more common forms of variable

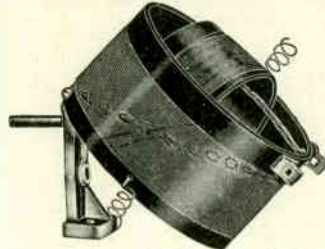

Illustration by courtesy of Radio Specialty Co. Another type of variocoupler.

inductance. (See *Inductance, and Inductance Coils.*)

**INDUCTANCES IN PARALLEL**—Coils possessing the property of self-induction or self-inductance, connected in parallel or shunt to each other. The illustration shows two standard coils

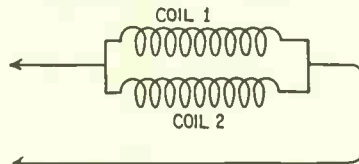

Diagram showing connection of two inductance coils in parallel in a circuit.

connected in a circuit in this manner. The effective inductance is less than that of either coil alone. (See *Inductance Coils.*)

**INDUCTANCES IN SERIES**—Coils possessing the property of self-induction, connected in series in a circuit. The illustration shows two coils con-

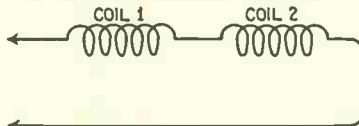

Diagram showing two inductance coils in series in a circuit.

nected in series in a circuit. Here the effective inductance value is the sum of the separate inductances. (See *Inductance Coils.*)

**INDUCTION**—The influence exerted by one field of force (electromagnetic or electrostatic) on another or on a conductor. Whenever a magnetic field interlinked with an electric circuit is changed, an *electromotive force* (q.v.) is induced in that circuit. The magnetic field is considered to originate from the heart of the conductor, spreading out concentrically from the conductor as the current increases and shrinking back into the center of the conductor as the current decreases. In either case, the conductor is cut by the magnetic field, and in accordance with the *law of electromagnetic induction* (q.v.) an electromotive force is induced in the circuit proportional in amount to the rate of change of the magnetic field and acting in a direction which would, by producing a current, tend to oppose the change.

A bothersome type of electromagnetic induction sometimes occurring in radio takes place when a radio aerial is run parallel to a high-tension line or even a trolley line. The varying field of force about the high-tension line sets up, by induction, a corresponding field in the parallel aerial, thus causing a disturbing hum in the loud speaker.

Such a condition can usually be eliminated by running the aerial at right angles to the power line. By doing this, induction between the two conductors is reduced to a minimum.

Electrostatic induction is a re-arrangement of an electrostatic field whereby a body in the neighborhood of a charged body will have an opposite charge induced on it. An *induction machine* (q.v.) known as the Wims-hurst utilizes the principle of electrostatic induction.

**INDUCTION BRIDGE**—Also called inductance bridge. A balance arranged similarly to a *Wheatstone Bridge* (q.v.), used in inductance measurement. (See *Inductance, Measurement of Inductance, also Induction Density.*)

**INDUCTION COIL**—A form of transformer, having a primary winding arranged with a means of making the direct current applied to it, pulsate.

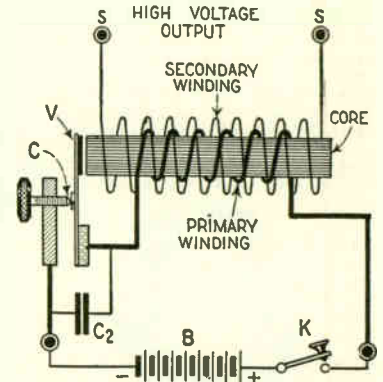

A typical form of induction coil showing diagram of connections, vibrator, core, battery, condenser and key.

Essentially a transformer with open magnetic circuit, carrying a pulsating direct current which induces a high voltage, alternating current in the secondary by means of the step-up effect of the windings. The illustration shows a typical form of induction coil and the associated circuits for producing high voltages. Here, there are two windings, a primary and a secondary, over and insulated from a core, composed of a number of soft iron wires. The primary is arranged with a key, K, and a battery, B, to supply direct current to the circuit. When the key is depressed the current flows through the primary circuit, including the contact C and the vibrator V. The core

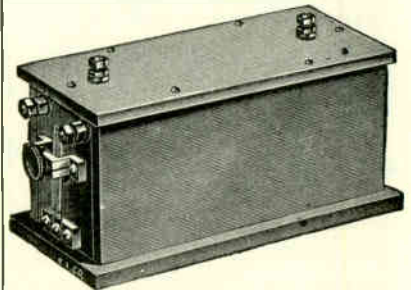

A form of spark coil.

becomes *saturated* (q.v.) or magnetized and attracts the armature or spring V. As this spring is drawn toward the core it breaks the contact between the spring and the contact post. This, of course, breaks the circuit from the bat-

tery and the flow of current stops, resulting in the collapse of the flux through the core. When the magnetic attraction ceases the spring goes back into normal position and the contact is once more complete, allowing current to flow through the windings. This make-and-break process is more or less rapid and is repeated continuously. By induction, an alternating E.M.F. (electromotive force) is created in the secondary windings, and as these windings have many more turns than the primary winding the induced E.M.F. will be proportionately greater. If the breaks occur at a rate of from thirty to one hundred per second, the key can be used to interrupt the primary current and produce at the secondary terminals a high voltage suitable for spark transmission. (See *Induction, Transformer, Spark Coil.*)

**INDUCTION COIL, PRIMARY**—The simplest form of induction coil. It consists of an iron core wound with a relatively large amount of low resistance copper wire, which is well insulated. The iron core increases the effect of self-induction and the size or length of the core and the number of turns of wire determine the efficiency of the coil. Such coils are used extensively for low tension ignition. (See *Induction Coil.*)

**INDUCTION COIL, SECONDARY**—A type of induction coil employing a primary and secondary winding. The primary is wound over an iron core and the secondary is generally wound over the primary. (See *Induction Coil.*)

**INDUCTION DENSITY**—A term occasionally used to refer to the density of flux in a magnetic or electromagnetic field of force. It is synonymous with flux density, under which heading it will be found more fully defined. (See *Induction, Electromagnetic, also Gauss, and Induction, Magnetic.*)

**INDUCTION, ELECTROMAGNETIC**—The production or *inducing* of electric currents in a conductor when it is moved in a magnetic field of force in such manner as to cut magnetic lines of force. The simplest example of this phenomena is the Faraday experiment in which he discovered that a wire with its ends joined, when moved rapidly in the field of a magnet, would result in current being induced in the wire or conductor. All dynamo electric machinery is based upon this principle of electromagnetic induction, as are also alternating current transformers and various other electrical devices.

In the illustration is shown the theory of production of current by electromagnetic induction. Fig. 1 shows a

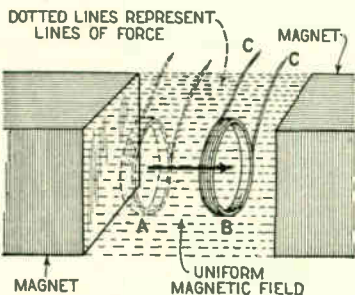

Fig. 1. Coil of wire in a uniform magnetic field of force between two magnets. Here the coil is assumed to have been moved from A to B in the same

plane. This is known as a *motion of translation*, and the field being uniform at all points the same number of lines pass through the coil at both points. Therefore no current is induced in the coil and a sensitive instrument placed across the leads, C, C, would show no current present. In Fig. 2 the same coil is shown at A in its original posi-

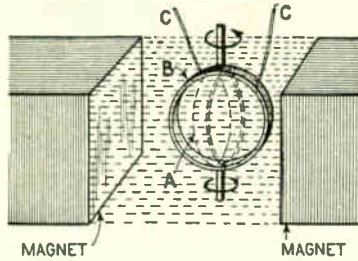

Fig. 2. Same coil, showing cutting of field due to the rotation of the coil.

tion. Here, however, it is rotated, and when in position B it is apparent that less lines of force pass through it. We have thus fulfilled the conditions for inducing current, and if the instrument is placed across the leads, C, C, the presence of electric current will be indicated. If the motion of rotation is continued the number of lines of force passing through the coil will continue to increase and decrease and current will be produced in the coil as long as the motion persists. From the above it will appear that current can be induced either by rotating the coil around any axis in its plane, or by tilting it in its motion across the field. The coil of wire in this case is known as an *inductor* because the current is induced in it. It is also referred to as a *conductor* when describing the production of alternating currents.

Now it was stated that current is induced in the inductor whether the lines of force through it are *increased* or *decreased* by its motion through the field. We can reduce the action to two simple rules. First, the relative motion between an inductor and a magnetic field must be such that the number of lines passing through the inductor are altered, i.e., increased or decreased. Second, the electromotive force induced in the inductor circuit will be proportional to the rate of increase or decrease in the number of magnetic lines embraced by the inductor circuit. We know from the *Lenz Law* (see *Alternating Current, Theory of Production*) that current will flow in the inductor in a direction dependent upon whether the lines of force through it are being increased or decreased, and as the inductor is being rotated continuously the current will change direction with each change in the number of lines. (See *Alternating Current, Alternator, Electromotive Force, Fleming's Rule, Laws of Electromagnetic Induction, Lenz's Law.*)

**INDUCTION, ELECTROSTATIC**—The production of an electric charge in a body due to the presence of a nearby conductor having an opposite charge. The effect is known as a displacement of electric charge. (See *Electrostatic Induction, also Induction.*)

**INDUCTION INSTRUMENTS**—Measuring instruments used in electrical and radio practice, which make use of the principle of electromagnetic induction. Such instruments are used for measuring alternating currents, the torque or actuating force for the indicator being

produced by the effect of a rotating field on a metal disc or drum which is not connected to the circuit carrying the currents. The instruments operate on the same basic principle as the *induction motor* (q.v.).

**INDUCTION MACHINE**—A machine wherein the primary and secondary windings rotate with respect to each other. Examples of induction machines are induction motors, certain types of frequency converters and induction generators. An entirely different kind of induction machine is one which gen-

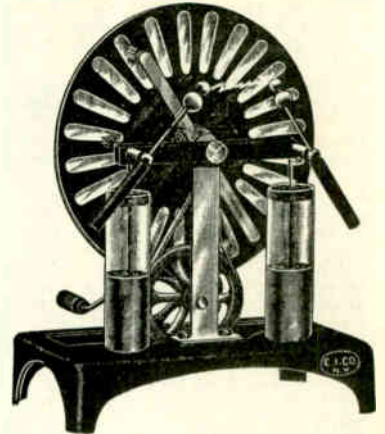

A common type of induction machine known as the Wimshurst.

erates low potentials, utilizing the principle of *electrostatic induction* (q.v.). The most common form of this type is known as the *Wimshurst* (q.v.).

**INDUCTION, MAGNETIC**—The communication of magnetism to a metal by the presence of a magnet without any actual contact. The effect of the presence of a magnet in the neighborhood of a piece of magnetic material is to induce magnetic poles in it. (See *Magnetism, Magnetic Poles, Induction, also Induction, Electromagnetic.*)

**INDUCTION MOTOR**—An alternating current motor in which the input current is passed through the field coils only, the armature not being connected to the external circuit. Here the armature is rotated by currents induced by the varying field set up through the field coils. The induction motor is the most widely used of the alternating current types, maintaining a practically constant speed from no load to full load and being simple and rugged in construction. This type of motor has two windings, the primary and secondary, and two members called stator and rotor. The primary winding is usually on the stator and the secondary winding, which is therefore customarily on the rotating member, is not connected electrically to the primary. Current to operate the rotor is induced in the secondary windings by the magnetic action of the current circulating in the primary windings. (See *Alternating Current, also Induction, Electromagnetic.*)

**INDUCTION, MUTUAL**—The interference or mutual effect between two electric or magnetic fields, due entirely to their proximity and without electrical contact. The mutual induction or electromagnetic influence of one circuit upon another is measured by the coefficient of mutual inductance or induction. (See *Mutual Induction, also Mutual Induction Coefficient, and Mutual Inductance.*)

## Induction Reactance

**INDUCTION REACTANCE**—The value in ohms of the inductance in an electrical circuit as distinguished from the capacity or capacitive reactance. It is the part of the total impedance in an alternating current circuit that is due to the presence of inductance in the circuit. (See *Inductance Reactance, Ohm, Impedance.*)

**INDUCTION REGULATOR**—A system of regulating the voltage in alternating current circuits, employing a choke coil with removable core, or some form of variable ratio transformer which will assist or oppose the current by re-adjustment of the ratio. (See *Choke Coil, Reactance, and Variable Ratio Transformer.*)

**INDUCTION SCREEN**—A metal screen or shield placed between two electrified or magnetic bodies to reduce the effect of induction between them. A common example of this in radio usage is the placing of a sheet of metal between two coils, the sheet being generally grounded, or the provision of a metal shield (q.v.) entirely around each coil. This reduces the interaction of the fields of the coils, which leads to losses or howling, especially in *tuned radio frequency amplifiers* (q.v.). (See *Shielding.*)

**INDUCTION UNIT**—The *henry*, defined as the induction in a circuit when the electromotive force induced in that circuit is one *international volt* (see *volt*) while the inducing current varies at the rate of one ampere each second. (See *Henry, also Self-Induction.*)

**INDUCTION VOLTMETER**—See *Induction Wattmeter, also Induction Instruments.*

**INDUCTION WATTMETER**—An instrument for measuring the power delivered to a circuit. The induction type wattmeter operates on a principle used in the induction motor, a magnetic body attached to a pointer being rotated by a changing magnetic field. (See *Induction Motor, also Wattmeter.*)

**INDUCTIVE CAPACITY**—Generally referred to as the specific inductive capacity in rating the dielectric qualities of a substance. It is the quality of any dielectric substance by reason of which it permits electrostatic induction through it. The term is more or less synonymous with *Dielectric Constant*, the latter, however, being generally given in terms of a numerical value representing its comparative specific inductive capacity with some material taken as a standard. (See *Dielectric Coefficient and Constant, also Specific Inductive Capacity.*)

**INDUCTIVE CIRCUIT**—An electrical circuit possessing inductance but not capacity. (See *Inductance, also Capacity.*)

**INDUCTIVE CONNECTION**—A connection between two circuits entirely through the property of induction and without any metallic contact. The two coils, primary and secondary, of a vario-coupler as used in radio receiving circuits, are said to have inductive connection where the windings are separate. Thus, the primary coil will be in one electrical circuit and the secondary coil will receive energy from it by means of induction. (See *Induction, Coupling, Vario-Coupler.*)

**INDUCTIVE COUPLER**—The inductances or coils placed in inductive relation or inductively connected with each other for the purpose of transferring energy by electromagnetic coupling. Any device consisting of a primary

and secondary inductance and used to transfer energy from one circuit to another by means of induction. (See *Coupler, Induction, Vario-Coupler.*)

**INDUCTIVE COUPLING**—The coupling or connection between two circuits by means of electromagnetic induction.

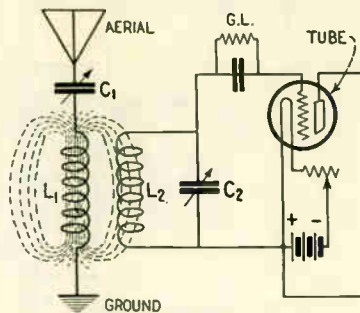

The utilization of a vario-coupler to inductively couple the aerial system with the rest of a receiving circuit.

The most common example of inductive coupling is in radio receiving circuits where coupling coils are used to associate the primary or aerial circuit with the secondary circuit. In the illustration  $L_1$  is the primary of a vario-coupler and  $L_2$  the secondary. The primary is inserted between the ground and aerial and the secondary is connected to the grid and filament of the detector tube. The variable condenser  $C_1$  tunes the primary circuit, the primary coil also being variable by means of taps if desired. The variable condenser  $C_2$  tunes the secondary inductance and the condenser and grid leak  $GL$  are the customary elements in the detector grid circuit. As the high frequency currents traverse the primary circuit, passing through coil  $L_1$ , lines of force are set up as shown and some of these lines embrace the secondary coil  $L_2$ , inducing similar currents in the secondary or vacuum tube circuit. The balance of the circuit is not shown for obvious reasons. This type of coupling between circuits is much more selective than the straight coupling or conductive coupling. (See *Coupling, also Conductive Coupling.*)

**INDUCTIVE DISTURBANCE**—The disturbing effects sometimes experienced in radio broadcast or telegraph reception due to induction from nearby power or telephone lines. This sometimes occurs when an aerial is strung close to and parallel with a line carrying high voltages, and occasionally is experienced with telephone wires near the receiver. (See *Induction.*)

**INDUCTIVE DROP IN VOLTAGE**—The drop or diminution of voltage in an alternating current circuit due to the presence of inductance. Inductance in a circuit carrying alternating current tends by reason of the self-induction to set up a counter-electromotive force which opposes the original E.M.F. (electromotive force), thus reducing the effective voltage in the line. (See *Inductance, also Inductance Reactance.*)

**INDUCTIVE EMF**—The electromotive force due to induction. That is to say, the electromotive force induced in a circuit. (See *Induction, Induced EMF.*)

**INDUCTIVE REACTANCE**—The reactance or portion of the total impedance in a circuit, due to the presence of self-inductance. (See *Inductance Reactance, also Impedance.*)

**INDUCTIVE RESISTANCE**—A resistance element possessing inductance, as for example a resistance coil, which also has the property of self-inductance. (See *Resistance, also Inductance.*)

**INDUCTIVE RISE**—The rise in voltage noted in transformers or other alternating current apparatus due to the presence of a *leading current* (q.v.). (See *Inductance, also Transformer and Angle of Lead or Lag.*)

**INDUCTIVITY**—Another term used alternately with dielectric constant and conductive capacity, referring to the dielectric properties of materials. (See *Dielectric Coefficient or Constant, also Inductive Capacity.*)

**INDUCTOR**—The coils or conductors in which current is induced through electromagnetic induction, as in an induction motor. Any conductor in which current is induced due to a change in magnetic flux may be called an inductor. (See *Induction, Inductor Alternator, and Induction Motor.*)

**INDUCTOR ALTERNATOR**—An alternator for producing high frequency currents. It employs the *armature* and *field windings* on projections inside the *stator*, the rotor consisting of a drum carrying a magnetic material. By using a *rotor* of solid steel, very high speeds and consequently high frequency currents are obtainable. The *Alexanderson Alternator* (q.v.) is an inductor type alternator. (See *Alternator, also Inductor.*)

**INDUCTOMETER**—A device or instrument used to measure self or mutual inductance. The basic principle depends on the relation of two coils, a primary and secondary, one of which can be moved in its relation to the other, the inductance, either self or mutual, being registered on a scale calibrated in units of inductance. (See *Inductance, Mutual, also Inductance, Self.*)

**INERTIA**—In physics, the property of a body which tends to keep it in a state of rest or to resist any change of motion. (See *Inertia, Electric.*)

**INERTIA, ELECTRIC**—Term occasionally applied in place of *self-inductance* (q.v.). When a current flows in a circuit possessing inductance and the circuit is broken, current continues to flow for a short time. It thus appears that in this instance the resistance alone will not stop the flow of current on the instant of breaking the circuit, an interval of time being required as in the act of bringing to rest a moving material. (See *Inertia, Inductance, Self, also Resistance.*)

**INERTIA, ELECTROMAGNETIC**—The same as electric inertia, being, in effect, the energy required to start or stop a current in a circuit possessing self-inductance. (See *Inertia.*)

**INFERRED ZERO**—A term used in connection with certain instruments having extremely high sensitivity, where the zero is removed from the scale. In a galvanometer, for example, the zero position on the scale may be merely assumed, an electrical or mechanical force being applied to bring the zero off the scale entirely, only a part of the full range of the full scale being utilized. (See *Galvanometer.*)

**INFLUENCE**—A broad term signifying action at a distance, as by electrostatic induction, without any actual physical contact. It is considered as the effect of a charged body on a



neutral body or conductor coming within its field. (See *Field*, also *Induction*.)

**INFRA-RED RAYS**—The heat waves or rays which lie between light waves and electromagnetic (radio) waves. The infra-red lies at the extreme low frequency end of the invisible spectrum, the wave-length being extremely high and the frequency conversely low. (See *Wave*, also *Ether Waves*.)

**INFRA-SATURATION PART OF CHARACTERISTIC**—In a characteristic curve of a vacuum tube, this is the portion over which the tube is operable, or the operating portion of the curve. (See *Characteristic Curve*, also *Vacuum Tube, Theory of Operation*.)

**INITIAL MAGNETIZATION**—The initial stages of magnetization as distinguished from the effect after saturation has been approached or reached. (See *Saturation, Magnetic*.)

**INPUT**—Generally speaking, the energy absorbed by a machine as distinguished from the output energy. (See *Input Voltage*, etc.)

**INPUT CIRCUIT OF VACUUM TUBE**—Vacuum tube circuits are generally divided into three separate classes or circuits. The first is the circuit including the filament, i.e., the "A" battery circuit through the filament. The

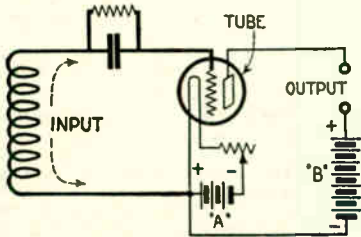

Input and output circuits of a vacuum tube receiver. Heavy lines show the former, light lines the latter.

second is the circuit between filament and grid and the third is the circuit between filament and plate. The filament grid circuit is called the input circuit because the incoming oscillations are impressed on this circuit. The filament plate circuit is known as the output because the rectified or amplified currents are taken from across the plate and filament. The illustration shows both input and output circuits, the former in heavy lines and the latter in light lines. The input circuit of a tube is also known as the *grid circuit*. (See *Grid, Filament, Plate*, also *Vacuum Tube, Theory of Operation*.)

**INPUT VOLTAGE**—The voltage impressed on a circuit or machine as distinguished from the output voltage. (See *Input*.)

**INSTANTANEOUS CURRENT**—The value of current in an alternating current circuit measured at any instant, as distinguished from the average current value. (See *Instantaneous Values*.)

**INSTANTANEOUS VALUES**—The actual value of an alternating current, E.M.F. (electromotive force), etc., measured at any instant. This value may be anything from zero to maximum or peak. It must be remembered that in an alternating current the current and voltage are both variable factors, rising to a maximum in one direction, then falling to a minimum, and then rising to a maximum in the other direction. Thus, a wattmeter

measures the actual value of current and voltage at each instant and the instantaneous torque at each instant is proportional to the instantaneous power. The average torque acting on the moving element during each cycle of the current and voltage is then proportional to the average power. If we measure an alternating current with an ammeter, and then measure the voltage with a volt-meter, the product of the two will be the apparent power, (apparent watts). It should be noted that these instruments measure effective and not instantaneous values. In order to ascertain the true watts (q.v.), it is necessary to multiply the apparent watts by the power factor. A wattmeter measures true watts. (See *Effective Electromotive Force, Power Factor*, also *Wattmeter*.)

**INSTANTANEOUS VOLTAGE OR PRESSURE**—The voltage or pressure in an alternating current circuit measured at any instant, as distinguished from the average value of E.M.F. (electromotive force). (See *Instantaneous Values*.)

**INSTRUMENTS, MEASURING**—In electricity or radio, any device or instrument for recording or indicating values, such as an ammeter for indicating the current in amperes, or a voltmeter to indicate the electromotive force in volts. (See *Ammeter or Ampere Meter, Voltmeter, Wattmeter*.)

**INSTRUMENT SHUNTS**—In electrical measuring instruments, a branch conductor, generally of relatively heavy wire or metal strip, joining the meter circuit at two points and forming a parallel circuit, thus dividing the current and protecting the delicate windings of the instrument. (See *Shunt*, also *Ammeter*, or *Ampere Meter, Hot Wire Ammeter*.)

**INSULATE**—To provide a protective covering or shield for a part or conductor, preventing flow of electricity from it or the passage of electricity through it. A conductor of electric currents is generally insulated to prevent the flow of the electricity through contact with other parts or conductors except where contact is intended to be made. (See *Insulated Wire*.)

**INSULATED WIRE**—Wire, generally copper, covered with insulating material to prevent leakage of the electric current. Standard insulated wire of the heavier gauges is usually covered with a layer of rubber and an outer covering of braided cotton. (See *Lead-In*, also *Insulation*.)

**INSULATING COMPOUND**—Liquid or easily liquifiable mixture of some in-

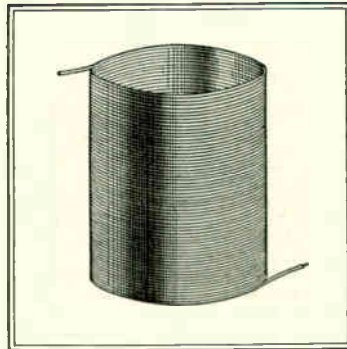

Air core coil made rigid by use of insulating compound.

insulating material, used in radio to coat cardboard tubes and to cover any open

point of contact in an otherwise insulated conductor or part. Coils are very often coated with shellac or some other liquid and quick-drying substance. This serves to hold the windings in place and also acts as a protective covering. A very valuable application of an insulating liquid is shown in the illustration. Here an inductance is wound on a form of stiff paper or cardboard tube and after being completed is coated with one or two treatments of collodion or similar liquid. (Shellac introduces losses through the medium of *distributed capacity*.) The form is then cut away and the coil remains self-supporting as shown. This method produces a coil having the least possible dielectric and distributed capacity loss for a cylindrical shape. (See *Dielectric, Inductance Coil, Low Loss Coils, Collodion*.)

**INSULATING MATERIALS**—Non-conducting substances, for example, glass, hard rubber or porcelain, which do not conduct electric currents. Strictly speaking, there are no perfect insulating materials. The most perfect insulators are certain gases, although at low pressure these may act as very good conductors. The more common insulating materials in radio are the following: mica, glass, bakelite and hard rubber, the insulating values being in that order. When we speak of the insulating property of a material we are actually referring to its resistance, a good insulator offering infinite resistance to the passage of electric currents and poor ones being relatively good conductors. The term *specific resistance* is used extensively in connection with the insulating properties of materials. This term is defined as the resistance of a piece of material of unit length and unit cross-sectional area at a given temperature, the value being given in ohms. (See *Dielectric Coefficient and Constant, Table of*, also *Ohms, Resistance and Insulate*.)

**INSULATING PROPERTY**—The ability of any material to *insulate* electric currents. Accepting mica as an insulator, we say that its insulating properties are superior to glass or hard rubber. (See *Insulating Materials*, also *Dielectric Coefficient and Constant and Insulation of Aerial*.)

**INSULATION**—Broadly any material or gas used to insulate electric currents. In radio, insulation plays a most important part, providing protective coverings or separators between conductors of the electric current and between the conductors and the ground. Insulation is really a material or gas having extremely high specific resistance; the better the insulating property, the higher the resistance to passage of electricity. There is no clearly defined line of demarcation between an insulator and a conductor, a poor insulator being to some extent a conductor. (See *Bakelite, Conductor, Dielectric Coefficient and Constant, Insulations of Aerial, Panel*.)

**INSULATION OF AERIAL**—The means used in connection with an aerial for



Aerial insulator.

reception or transmission of radio waves, to prevent leakage or ground-

## Insulation Resistance

ing of the currents. The insulation of an aerial for reception purposes should be given very careful consideration. The wires may be suspended by means of small glass or porcelain insulators and the lead-in rubber covered wire, entering the building through a *lead-in insulator* (q.v.). The aerial for transmission must be accorded specially careful attention as far as insulation is concerned. The bare wires must be suspended with heavy duty insulators, capable of withstanding high voltages without "breaking down." The lead wire must be conducted into the building through a high-tension insulating tube or other lead-in device to prevent leakage of the current to the ground. (See *Aerial, Insulation of Aerial and High Tension Insulators*, also *Lead-In Insulator*.)

**INSULATION RESISTANCE**—The actual resistance in ohms, generally megohms, of the insulation of any conductor or piece of apparatus. If we assume two conductors, carrying separate currents and crossed so that the only protection would be the actual insulation of the wires, the insulation resistance would be the actual resistance in megohms from one path to the other. Conceivably a small current might leak from one conductor to the other, this current, of course, depending on the resistance of the insulation. The term "insulation resistance" is more easily understood when it is considered that an insulator or insulating material is merely a very poor conductor, or one having extremely high resistance to electric currents, there being actually no perfect insulator. (See *Insulation, Insulated Wire*, also *Conductor and Resistance*.)

**INSULATION TESTER**—An instrument or set of meters for testing the resistance of an insulator in fractional ohms, generally megohms. (See *Insulation Resistance*.)

**INSULATOR**—Any substance having insulating properties. *Insulators* are used to keep electric currents flowing in predetermined paths. It is neces-

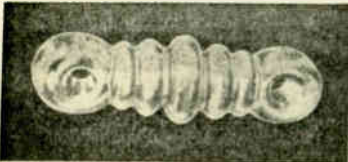
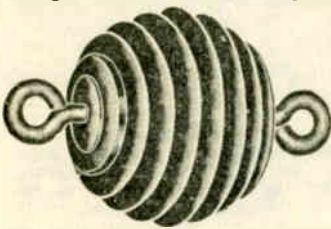

Illustration by courtesy of Corning Glass Works.

A typical small antenna insulator, showing corrugated surface.

sary to use insulators on all electric circuits in order to prevent *grounds*, *leakage* and *short circuits*. Insulators are of the utmost importance in radio. At the transmitting end, where high voltages as well as high frequencies



A corrugated ball insulator.

are used, the insulators must be specially designed to prevent leakage. A

typical installation of insulators in use on the aerial system of a modern broadcasting station utilizes a 12-inch pyrex insulator at each end of each wire between the spreaders. A standard porcelain strain insulator is used every 14 feet on each guy wire. At each end of each guy wire a standard 24-inch porcelain insulator is used.

Insulators used on receiving antennas are made of porcelain, pyrex, rubber and composition. These are usually about 4 inches in length. Sometimes porcelain tubes are used as insulators to bring a *lead-in* (q.v.) into a building, but these have been generally superseded by flat *window lead-ins*. **INSULATOR, LEAD IN**—The insulating tube through which a lead wire



A flat window lead-in which permits entrance of lead-in into building without the necessity of boring holes.

from a radio aerial enters a building, used to prevent grounding or leakage of the current by contact with another

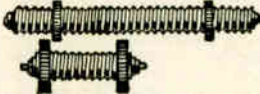

Lead-in insulators of conventional type.

conducting surface. (See *Lead-In Insulator*.)

**INTEGRATING DETECTOR**—The name sometimes given to any detector which yields a response proportional to the total energy received from a spark train rather than to the maximum value of the current or voltage in the train.

**INTEGRATING INSTRUMENTS**—Meters so designed as to record the total quantity of electricity (ampere hours) or the total energy (watt-hours) passing in a circuit in a given time. (See *Ammeter* or *Ampere Meter*, also *Integrating Wattmeter*.)

**INTEGRATING WATTMETER**—An instrument which measures and records the total amount of electrical energy being consumed in a circuit. These instruments are also known as *recording watt-hour meters* (q.v.), *integrating watt-hour meters*, and sometimes are simply referred to as *watt-hour meters* (q.v.).

Broadly speaking the *integrating wattmeter* is a type of small motor whose rotations are counted by means of a worm on the armature shaft engaging a set of cogs working a counter. The construction is such that the average torque (q.v.) exerted by the motor is proportional to the average power taken by the load. In other words, the motor rotates at a speed directly proportional to the energy being expended. For direct current work, *integrating wattmeters* are either of the commutator type, such as the Thompson, Westinghouse and Duncan meters or of the no-commutator type, such as the Sangamo. The commutator type instruments operate on the *dynamometer* (qv.) principle. Meters of the no-commutator type are essentially motors whose armatures always cut the same direction flux. That is to say, they are essentially *homopolar* (q.v.) motors. The principle of operation of these meters is the law of motor action which states that a conductor, free to move and carrying a current whose direction of flow is at

right angles to a fixed magnetic field, will be moved out of this field, and in a direction at right angles both to the direction of current flow and to the field. For alternating current work, *integrating wattmeters* are of the *induction* (q.v.) type. The principle of operation of these meters is identical to that of *induction motors* (qv.) having shunt and series windings stationary and so related and located as to produce a rotating field acting upon a closed rotatable secondary. In the induction meter the secondary consists of a light aluminum disc. These meters may be either of *single phase* (q.v.) or *polyphase* (q.v.) construction. (See *Electro-dynamometer*.)

**INTEGRATOR**—A device which automatically, by means of clockwork, adds up and records on a dial items of calculation or measurement. The system used in a recording or integrating wattmeter. (See *Integrating Wattmeter*.)

**INTENSIFICATION**—Broadly an intensifying or increasing of the density of electric current, but specifically in radio it refers to the tendency of radio signals to increase in intensity under certain conditions. The phenomena of intensification is naturally closely related to fading, as obviously the intensification process must necessarily follow or be followed by a fading process. The tendency toward intensification is more pronounced toward night and generally on the shorter wavelengths, it being noted that quite often signals from a distant station will be increased in volume or intensity as much as fifty per cent or more between the late afternoon and late evening. While the periodic *fading* of signals and the subsequent increase in volume over regular periods, usually of a few minutes' duration, may be considered as *fading* and *intensification*, it is preferable to think of fading as one operation together with the subsequent increase in volume, and the term *intensification* as referring strictly to the change to greater volume that takes place toward night. (See *Fading*, also *Phenomena of Electric Wave Propagation*.)

**INTENSITY OF ELECTRIC CURRENT**—A term more or less in use to imply the strength of an electric current in amperes, the symbol *I* for current being derived from it. (See *Ampere*, *Current Density*, also *Intensity of Field*.)

**INTENSITY OF FIELD**—The intensity or strength of the force exerted in a magnetic field. It is measured by its action or effect on a unit pole placed at any point in the field, the intensity of the field, of course, varying at different points. (See *Flux Density*, *Intensity of Magnetic Flux*.)

**INTENSITY OF MAGNETIC FLUX**—The strength of the force exerted in a magnetic field. (See *Intensity of Field*, also *Flux Density*.)

**INTENSITY OF MAGNETIZATION**—The density of force per unit cross-sectional area of a magnetized material. The extent of the magnetizing effect on a material placed in a magnetic field of force. This applies only to material in a magnetic circuit and should not be confused with the lines of force due to a field arising from the presence of neighboring currents or magnets. (See *Magnetization*, also *Intensity of Magnetic Flux*.)

**INTERFERENCE**—The interruption or interference with desired electromag-

netic waves by undesired or extraneous waves. The interference of undesired broadcast or radio-telegraph signals with the desired signals. Also, broadly, the detrimental effect of power lines and other electric circuits on radio communication. Interference is encountered chiefly in receiving sets having poor *selectivity* (q.v.). In some instances interference may be due to the fact that another transmitter is operating on the desired wave-length, and being sufficiently close as to make it practically impossible to obtain clear signals from the desired station. Ordinarily, and where the effect is due to lack of sharp resonance or tuning, certain changes can be made in the receiver to sharpen the tuning, or if the disturbance is due to the transmitting stations and the receiver is normally sharp, various circuits can be employed to filter out the undesired signals. (See *Interference Preventer*, also *Wave Trap*.)

**INTERFERENCE ELIMINATOR**—A device or system as shown in the illustration for reducing or preventing reception of undesired signals in radio work. Practically all *interference eliminators* make use of a separately tuned inductance across the aerial and ground and in parallel with the re-

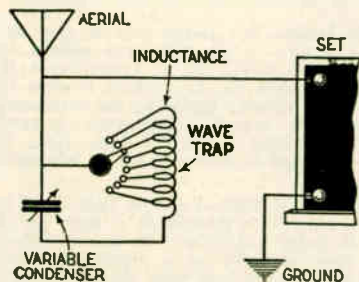

A wave trap or interference eliminator which dispenses with the ground connection.

ceiving set. The inductance is usually tuned by means of a variable condenser which allows it to be tuned to the wave-length of the interfering signal. The interference can thus be by-passed to the ground. *Interference eliminators* of the kind described are generally known as *wave traps* (q.v.). A special form of interference due to atmospheric and electrical disturbances is known as *static* (q.v.). (See *Static Eliminator*.)

**INTERFERENCE PREVENTERS**—Any arrangements either within the receiving set, or external to the set, for limiting or preventing interference. In addition to *interference eliminators* (q.v.) and *static eliminators* (q.v.) various other methods are utilized in radio to prevent interference. Thus the arrangement of a receiving set to give sharp tuning and great selectivity, results in the prevention of much interference. A method of preventing interference which has been used, is the utilization of filter circuits which can be tuned to pass any desired frequency and exclude all others. The use of the *loop aerial* (q.v.) results in great selectivity. The loop has a very pronounced directional effect and this in itself acts to narrow the field of stations offering possible interference. For example, if stations of very nearly the same wave length are in opposite or different directions and are sending at the same time, the loop permits selection of the station

wanted, with no interference from the others.

**INTERMEDIATE CIRCUIT**—A closed circuit consisting of two inductance

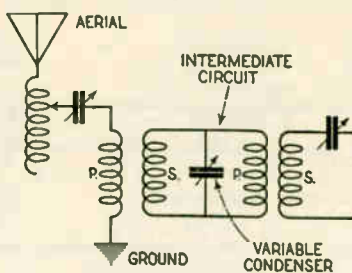

A multiple tuner intermediate circuit.

coils shunted by a variable condenser. One coil acts as primary to the secondary coil of the detector circuit and the other coil acts as secondary to the primary of the aerial circuit. A circuit such as this is sometimes referred to as a *multiple tuner intermediate circuit* and may be used as an *interference eliminator*.

**INTERMEDIATE FREQUENCY**—This is a frequency higher in number of oscillations than *audio frequency* (q.v.) but lower than *radio frequency* (q.v.). It is generally around 30,000 cycles or 10,000 meters wave-length. In the *super-heterodyne* (q.v.) the incoming signal is converted from the broadcast frequency to the so-called *intermediate frequency* at which it can be amplified by means of fixed winding transformers to almost any extent desired. The method of converting the incoming signal in a *super-heterodyne* from radio frequency to *intermediate frequency* is by the *beat* method. In this case an oscillating circuit controlled by means of a variable condenser so as to obtain any desired frequency, is brought into interference with the first detector and produces a *beat note* (q.v.) for the *intermediate frequency* which has all the characteristics of the original signal. In this way, no matter what the frequency of the intercepted signal may be, the intermediate frequency amplification is always carried on at a fixed wave-length, thus making for high efficiency. (See *Beat Frequency*; *Beats*.)

**INTERMEDIATE FREQUENCY AMPLIFIER**—An arrangement of tubes and transformers for stepping up the current, used in the *super-heterodyne* (q.v.) circuit. The intermediate frequency amplifier is located between the first detector and the second detector. (See *Intermediate Frequency*.)

**INTERMEDIATE TRANSFORMER**—The name given to the transformers used in the *intermediate frequency amplifier* (q.v.) of the *super-heterodyne* circuit. *Intermediate transformers* are often referred to as *intermediate frequency transformers*. They are *radio frequency transformers* (q.v.) but have an iron core and instead of tuning to a maximum of 550 or 600 meters they are designed to cover wave-lengths of 10,000 meters or higher. (See *Intermediate Frequency*.)

**INTERMITTENT CURRENT**—A current which flows irregularly or which is interrupted at intervals, or without continuity. The current obtained from a *magneto generator* (q.v.) is an interrupted or *intermittent current*. Such a current may be either alter-

nating or direct. A magneto generator constructed to give direct current is equipped with a two segment commutator having a stationary brush in contact with it. (See *Pulsating Current*.)

**INTERNAL RESISTANCE**—Resistance within an electric source. In the case of a primary cell such as a dry battery, the internal resistance causes an interference with the flow of current. This varies in amount with the construction and materials of the battery.

**INTERNATIONAL MORSE CODE**—This is also known as the *Continental code*. (See *Code*.)

**INTERPOLE**—A small magnetic pole placed between the main field poles of an electric generator for the purpose of obtaining better commutation. Interpole windings are connected in series with the armature winding and the load. The action of the interpole is exactly analogous to the shifting of the brushes, but when interpoles are used, brush shifting is dispensed with and the magnetic flux is shifted instead.

**INTERRUPTED CONTINUOUS WAVES**—abbreviation I.C.W.—These waves are obtained by the modulation at audio frequency, during signalling, of an otherwise *continuous wave* (q.v.). (See *Continuous Waves Key Modulated*, also *Continuous Waves Modulated at Audio Frequency*.)

**INTERRUPTED WAVES**—abbreviation I.W.—Interrupted waves are waves produced by modulation at audio frequency, of otherwise continuous waves. (See *Interrupted Continuous Waves*.)

**INTERRUPTER**—A combination of an electro-magnet with a vibrating armature which carries a contact point on a piece of spring steel fastened to the armature. When the electro-magnet attracts the armature the contact points are drawn apart thus interrupting the circuit. This action

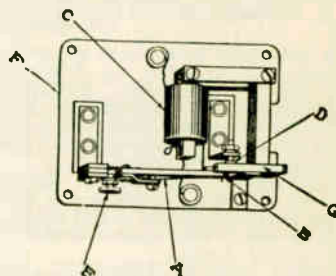

The vibrator panel of an efficient type of mechanical charger.

is only momentary for the spring again brings the circuit back to its original condition. The most important use of the interrupter in radio is as a *rectifying valve* (q.v.) in mechanical chargers. A typical vibrator panel is shown in the illustration. The armature, A, is the moving element. This carries at its outermost end a heavy Tungsten contact, B, which is caused to vibrate in synchronism with the supply current, by the actuating coil, C. When the current from the transformer is of the correct polarity and value the actuating coil attracts the armature, closing the charging circuit to the battery through the fixed contact, D. The contact end of the armature, A, vibrates within the air gap of the pole shoe, G.

A common use of the *interrupter* is in the ordinary electric bell. In this

**Interrupter, Electrolytic**

apparatus, the electromagnet pulls the armature carrying the spring and contact point, breaking contact and opening the circuit. This immediately de-energizes the magnet since its coils are in series with the circuit. The spring tension pulls the armature back to its original position thus again closing the contact. As soon as the contact is closed, the electromagnet is again energized and it again attracts the armature, opening the circuit. This action keeps on indefinitely as long as a difference of potential is maintained at the terminals of the bell.

The interrupter is used in the induction coil (q.v.) for breaking up the direct current into a series of impulses, thus producing an intermittent current. (See *Circuit Breaker*.)

**INTERRUPTER, ELECTROLYTIC**—A jar containing diluted sulphuric acid as the electrolyte, a large sheet of lead as one electrode and a platinum needle point introduced through a glass tube as the other electrode. If these electrodes are connected through

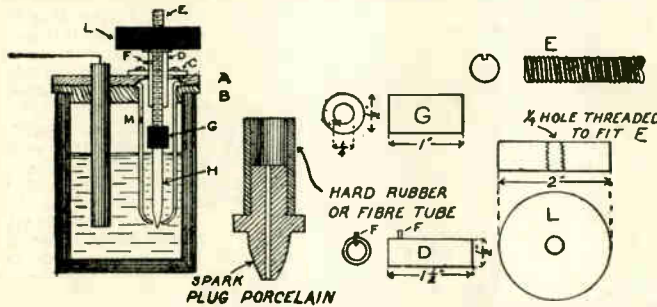

A simple type of Wehnelt interrupter. The positive pole of the direct current supply is connected to the brass part C, while the negative pole is attached to the lead rod. L is a fibre handle; E is a threaded rod, which is constructed to fit the threaded handle, but slotted so as to engage the pin F and prevent it from turning; H is a copper or platinum rod; D is a brass tube; M is the overflow hole in the fibre tube, into the lower end of which a portion of an old spark plug porcelain part has been driven; finally C is a small brass block as shown. This is the adjustable type of Wehnelt interrupter, since the fibre handle can be operated to allow more or less surface to be exposed to the acidulated water.

an inductance to a source of current supply, the current in the circuit will be rapidly interrupted. *Electrolytic interrupters* are suitable for radio transmitters using small spark coils and are also used in X-ray work. (See *Electrolytic Interrupter*.)

**INVERTED "L" AERIAL**—A flat top aerial (antenna) in which the down lead is tapped off one end of its horizontal span. (See *Length of Aerials, Horizontal Aerial*.)

**INVERSE DUPLEX CIRCUIT**—A circuit in which the vacuum tubes are utilized both for radio frequency and

radio frequency tube is also the first audio tube and the second radio frequency tube is the second audio tube. The *inverse duplex circuit* has the advantage over the reflex in that the

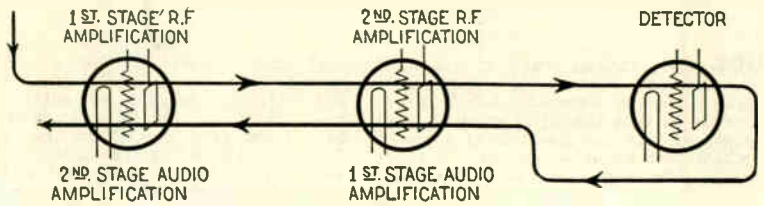

Diagram showing method of reflexing in an inverse duplex circuit.

tubes which are reflexed operate more efficiently since the relatively weak radio currents pass through the same tube as the stronger audio currents and vice-versa. The *inverse duplex circuit* is the invention of David Grimes.

**ION**—An atom of matter carrying an electron or an atom deprived of elec-

when they allow the flow of electricity. A gas may be made conductive by passing X-rays (q.v.) through it, by the action of ultra-violet light, by subjecting it to radium rays, by passing

it close to a flame or hot piece of metal or by forming in it a brush discharge or corona (q.v.). Gases which have been made conductive carry current because of their dissociation into ions, which carry positive or negative charges of electricity. (See *Electrolysis, Electrolytic Action, also Valve Detectors*.)

**I.R. DROP**—The voltage drop due to the resistance in a current-carrying conductor. It is directly proportional to the current flowing in the circuit multiplied by the resistance of that circuit.

**I<sup>2</sup>R LOSS**—The power loss in any circuit due to the resistance offered to current flow. It is proportional to the square of the current flowing in the circuit multiplied by the resistance of the circuit. Whenever current flows there is an I<sup>2</sup>R loss. This is measured in watts (q.v.) or kilowatts (q.v.).

**IRON PYRITES**—Formula FeS<sub>2</sub>.—This is a mineral, a disulphide of iron, found in large quantities. It was formerly used in radio as a crystal detector mineral but has been almost entirely superseded by vacuum tube detectors. *Iron pyrites* is flaked with shiny spots which have the appearance of gold, and for this reason it is sometimes called "fools gold." *Iron pyrites* is very hard and brittle. The present commercial use of *iron pyrites* is in the production of sulphuric acid. Ferrous Sulphide, FeS, has also been employed in the past as a radio detector. This substance is chemically formed by fusing equivalent quantities of sulphur and iron together. The resultant substance has a smooth surface. (See *Crystal Detector*.)

**ISOCHRONOUS**—A term applied to two or more oscillatory circuits, meaning that they have the same natural frequency (q.v.). Stated in another way, two or more radio frequency circuits are isochronous when they are in electrical resonance (q.v.). Circuits are said to be in resonance when they have the same oscillation constant (q.v.). The oscillation constant of a circuit is equal to the square root of the product of the inductance multiplied by the capacity of that circuit. Circuits having equal oscillation constants will have the same discharge frequency.

**ISODYNAMIC LINES**—Lines on a magnetic map connecting all parts of the earth where the magnetic intensity is the same. In other words, these lines pass through points of equal horizontal component of the earth's magnetic field.

**ISOGONIC LINES**—Lines on a magnetic map passing through points of equal declination. Lines connecting

trons. *Monad-ion* refers to a unit charge, *dyad-ion*, *divalent* carries two units, the *triad-ion* carries three unit charges. The positive ion is an atom minus an electron. A negative ion is an atom plus an electron. (See *Anion, also Cathion, Electron, Electron Theory*.)

**IONIZATION**—sometimes spelled IONISATION—The splitting up of molecules into ions (q.v.). Ionization may apply either to a chemical compound or to a gas. When an electric current is passed through an electrolyte (q.v.)

for audio frequency amplification as in the reflex (q.v.) circuit with this important differentiation that the first radio frequency tube is utilized as the second audio frequency tube and the second radio frequency tube is used as the first audio frequency tube. In the ordinary reflex circuit the first

the constituents of the electrolyte which are liberated or deposited at the electrodes (q.v.) are called ions and this process is called ionization. Gases at or near atmospheric pressure are normally good insulators. They are said to undergo ionization when they are made conductive, that is

all points of equal variation of the magnetic meridian from the geographic meridian.

**ISOTHERMS**—Lines on a meteorolog-

ical chart joining all points having the same temperature.

**ISOTROPIC CONDUCTIVITY**—Equal conductivity in every direction. A

## J

**JACK**—An arrangement of spring terminals as shown in the illustrations which can be connected together or separated thus closing or opening circuits through the insertion of a *plug* which also forms a part of the circuit. The *plug* (q.v.) has a tip and

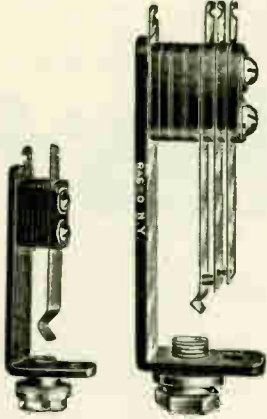

Illustration by courtesy of Radio Specialty Co.

Illustration at left shows one-spring open circuit jack. At the right is a three-spring jack.

a sleeve at one end (that is at the end inserted into the jack) and at the other end it has the two terminals for connecting the apparatus to be cut into the circuit. As an example, the terminals of the plug may be connected to a *loud speaker* (q.v.). The jack in this case is of the *open circuit* variety. That is to say, the springs of the jack are separated when not in use and the circuit is normally open. When the plug is inserted, the tip of the plug makes contact with one spring and the sleeve makes contact with the other thus closing the circuit through the *loud speaker*. In cases where the plug is used to open a circuit, that is to make the *jack* springs break contact with

each other, the *jack* is called a *closed circuit jack* since its spring terminals are normally making contact. In cases where the jack is used not only to put the loud speaker in the circuit, but also to act as a filament switch, it is known as an *automatic filament control jack*. Jacks which are used to control a single circuit only, are referred to as *single circuit jacks*. Those controlling two or more circuits simultaneously are known as *multiple circuit jacks*. Jacks are usually mounted on a panel so that the plug can be inserted from the outside of the panel while the spring terminals are concealed behind the panel.

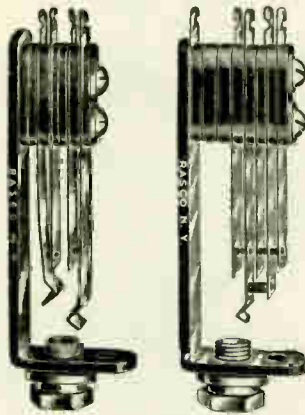

Illustration by courtesy of Radio Specialty Co.

The jack shown at the left is a four-spring double circuit jack. At the right is a five-spring automatic jack.

**JAMMING**—An expression denoting interference at a receiving station caused by a transmitting station not desired to be heard. More specifically, such interference, prevents the reception of signals, *jamming* the receiving station by drowning out with stronger signals or noises the station desired.

## K

**KANALSTRAHLEN**—A German word meaning Rays of Canal. It has been found that by perforating the cathode of a tube producing *cathode rays* (q.v.), faint luminous streaks will come through these perforations in a direction opposite to that of the *cathode rays*. These are called *kanalstrahlen*. They communicate a positive charge to an insulated conductor. In terms of the *electron theory* (q.v.) they are positively charged *ions* (q.v.) The cathode particle is an electron traveling in one direction, and the kanalstrahlen particle traveling in the opposite direction is what remains of the atom which has lost an electron.

**KATHODE**—This is a negative *electrode* (q.v.). (See *Cathode*, also *Electrolysis*.)

**KATHODE OF CELL**—The positive pole of a cell. This is indicated by the plus (+) sign. (See *cell*.)

**KATHODE RAYS**—The stream of *electrons* (q.v.) thrown off by the *kathode* of a vacuum tube. These produce a glow when they strike the walls forming the tube. They can be deflected by a magnet. (See *Cathode Rays*.)

**KATION**—The charged particles or *ions* (q.v.) moving in the direction of the *cathode* (q.v.). (See *Cathion*.)

**KEEPER**—The piece of iron used to close a magnetic circuit to protect it from external disturbances. The term *keeper* is generally used to refer to such a piece of iron when used with a permanent magnet such as a horseshoe magnet. In the case of the piece of iron which closes the magnetic circuit of an electromagnet, this is more often referred to as an *armature* (q.v.). The *keeper* may be used with a straight bar magnet also. In this case, two bar magnets are laid side by side with un-

conductor is said to be *isotropic* when it offers the same resistance to the flow of an electric current in every direction through its mass.

**JANET, PAUL**—Born in Paris, January 10, 1863. Educated at Lycee Louise-Grand and at the high school. He was Professor of Physics at the University of Paris and University of Grenoble. Professor Janet was the author of several important works, and first to make the experiments in electrical resonance successful. The results of these experiments are applied in present day wave meters.

**JAR**—A unit of electrostatic capacity. It is mainly used in the British Naval service. One *jar* equals 1000 *centimeters* which equals .0011 *microfarads* (q.v.).

**JIGGER**—A term generally accepted to denote an *oscillation transformer* (q.v.). Used for transforming trains of oscillations from one circuit to another. Dr. J. Erskine Murray refers to high frequency oscillations as *Jigs*. *Jiggers* are also known as *magnetic coupling transformers* (q.v.). They are also sometimes referred to as *auto-jiggers*.

**JOULE**—symbol J—The practical unit of electrical energy. It is equal to 10<sup>7</sup> *ergs* (q.v.). The *joule* is also the unit of electrical work. It is equal to the work done or the heat generated by a *watt second* (q.v.); or an *ampere* (q.v.) flowing for a second through a resistance of one *ohm* (q.v.). Expressed another way the *joule* is the work done by one *coulomb* (q.v.) flowing under the pressure of one *volt* (q.v.). One *joule* is equal to .73732 foot pounds, or .24 calories (q.v.).

**JOULE EFFECT, or JOULEAN HEATING**—This occurs when an electric current traverses a resisting conductor. The rate of generation of heat in the conductor by a steady current equals the square of the current multiplied by the resistance.

**JOULES EQUIVALENT**—The amount of energy equal to a heat unit.

**JOULES LAW**—The heat produced in an electric circuit is directly proportional to the square of the current, to the resistance of the conductor and to the time of current flow.

like poles adjacent and two keepers are used, one at each end. The use of

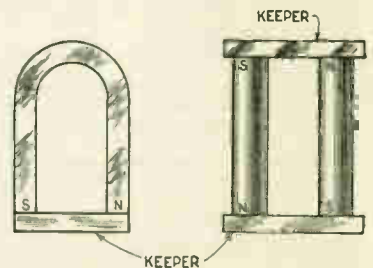

At left is shown keeper used with a horseshoe magnet. At right two keepers are shown used with two bar magnets.

a keeper avoids the demagnetizing effect of *leakage lines* (q.v.). (See *Horseshoe Magnet*.)

## Kelvin, Lord

**KELVIN, LORD** (William Thomson) was born at Belfast in 1824; he entered Glasgow University as a student at 10 years of age; graduated at Cambridge in 1845. When only 22 years of age he was called to occupy the chair of natural philosophy in the University of



Lord Kelvin (William Thomson)

Glasgow, a chair which he adorned by his genius for fifty years. He was for 40 years or more regarded as the acknowledged leader of British science on its physical and mathematical side. His great inventions in telegraphy, his magnetic compass and sea sounding apparatus brought him fame and fortune. He was knighted in 1866; and in 1892 was raised to the peerage as Baron Kelvin of Largs; he died on December 17, 1907.

**KELVIN'S BRIDGE**—A method of measuring low resistance in which the voltage drops, produced by the same current in the resistance under test and in a standard low resistance slide wire are balanced against each other. This bridge is a modification of the *Wheatstone Bridge* (q.v.) and was designed by Lord Kelvin to eliminate the errors introduced when measuring resistances much less than one *ohm* (q.v.). In the case of the *Wheatstone Bridge*, such resistances could not be measured accurately on account of the errors produced by the terminal and contact resistances.

**KELVIN'S ELECTROSTATIC VOLT-METER**—A voltmeter used for measuring high, and in some cases low, alternating current voltages. It is constructed on the principle of an air condenser. One type of electrostatic voltmeter is a high potential instrument having the needle made of a thin aluminum plate suspended vertically on delicate knife edges, with a pointer extending from the upper part to a scale. Two quadrant plates, metallically connected together, are placed on either side of the needle and parallel to its face. These serve as one terminal of the circuit to be measured. The needle acts as the opposite terminal. When there is a difference of potential between the needle and the plates, the needle is deflected out of its neutral position. The value of the scale indications can be changed by hanging calibrated weights on the bottom of the needle.

**KENOTRON**—A type of *vacuum tube rectifier* (q.v.) in which the vacuum is



Illustration by courtesy of Radio Corp. of America  
A kenotron tube.

extremely high and the discharge is carried almost entirely by electrons,

elementary text-books on same. He has written a very large number of papers on radio, and he is an authority on alternating currents.

He is past president of the American Institute of Electrical Engineers, was president in 1916 of the Institute of Radio Engineers, and vice-president of the International Electrical Congresses, held in Paris and Turin. He is a member of many scientific societies, and has received many honorary degrees. In 1921 he was appointed a delegate to the Interallied Radio Technical Committee in Paris.

**KEY**—A form of switch for conveniently and quickly opening and closing a transmitting circuit, in the act of transmitting signals. An *operating*, or *telegraph*, so-called *Morse key* is a

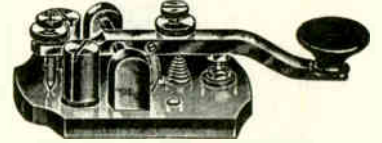

A standard transmitting key.

form of *tapping key* designed especially for the rapid sending of signals by the dot and dash code. A tapping key has one contact carried by a springy strip

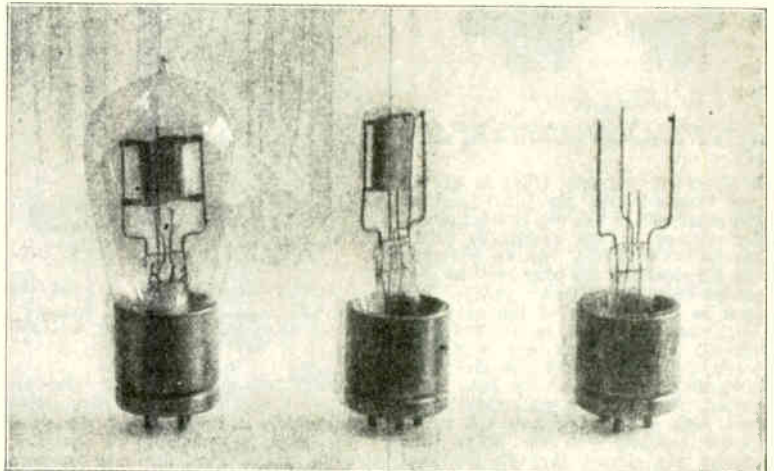

Illustration by courtesy of Radio Corporation of America.  
Stages in the construction of a kenotron.

not by gas ions. In these tubes, the plate current is always less than that actually emitted by the hot filament. *Kenotrons* are made sufficiently large to rectify several kilowatts.

**KENNELLY, A. E.**—Anglo-American radio expert. Born at Colaba, Bombay, December 17, 1861, he was educated in England, Belgium, France and Italy. In 1875 he became a telegraph operator in the employ of the Eastern Telegraph Company, and in 1886 became the principal electrical assistant to Thomas Alva Edison in the laboratories at Orange, N. J., a post he held until 1892.

He was engineer-in-chief with E. J. Houston, of the Thomson-Houston Company, for the laying of the cables from Vera Cruz to Campeche, 1902. Since 1902 he has been Professor of Electrical Engineering at Harvard University, and since 1914 professor of the same subject at Massachusetts Institute of Technology.

Kennelly has written a large number of books on electricity and radio, and is the author of one of the standard

of metal. In signalling, this key is depressed by the fingers, thus closing the circuit by bringing the contact together with a fixed contact. A standard type of *transmitting key* (q.v.) such as used in sending wireless messages is shown in the illustration. These keys must necessarily be made with larger contacts and of more solid construction than those used to interrupt the smaller currents used in wire telegraphy.

**KEY, ANTI-CAPACITY**—This is in reality a form of switch. (See *Switch*.)

**KEY, HIGH-SPEED**—A transmitting

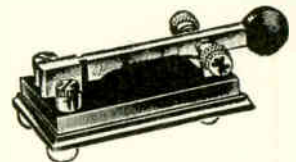

High speed key.

key usually operated from side to side instead of downwards, which makes

contact both on the right and on the left side. Such a key requires only half the travel of the ordinary transmitting key and thus facilitates high-speed manual transmission of code signals.

**KEY SWITCH**—A type of switch adapted for operation by a removable portion in the form of a handle or key. In radio work, *key switches* are sometimes used to lock a receiving set so that it cannot be operated unless the filament circuit is closed by the insertion and turning of the key. Key switches are generally operated by a hollow slotted key, although there are other types on the market. The slot in the key fits a projection or pin on the spindle or shaft of the switch which carries the movable contact. When the key is inserted in the socket and turned, it turns the shaft and brings the movable contact against a fixed contact. *Key switches* are also used for turning on or off electric lights and for locking or unlocking the ignition systems of automobiles.

**KILO**—Symbol K—A prefix placed before the name of a unit to indicate the multiple 1000 or 10<sup>3</sup>. In cases where standard units are too small for convenient use, it is customary to utilize this prefix as, for example, in stating the voltage of a high tension transmission line. This would often be given as 10 kilovolts (K.V.) rather than as 10,000 volts. In like manner, in referring to large amounts of power, it would be preferable to give the amounts in kilowatts rather than in watts. Thus the better way to express 10,000,000 watts would be to divide by 1,000, thus converting to 10,000 kilowatts.

**KILOAMPERE-TURN**—One kiloampere-turn is equivalent to 1,000 ampere-turns. In referring to the magnetic circuits of electrical machinery it is usual to specify the magnetomotive-forces in kiloampere-turns rather than in ampere-turns. (See *ampere-turns*, also *magnetomotive-force*.)

**KILOCYCLE**—1,000 *cycles*—Two immediately succeeding half waves of an alternating current constitute a *cycle* (q.v.). The number of *cycles* per second is called the *frequency* (q.v.). In house-lighting and similar circuits, where a comparatively low frequency is used, it is usual to refer to the *frequency* in cycles per second. However, in radio circuits, where currents as high as 300,000,000 cycles per second are used, it is preferable to divide by 1,000, thus converting to *kilocycles*. If the wave-length in meters is known, it is a simple matter to determine the frequency in *kilocycles*. This is calculated as follows: The speed of light is 186,000 miles per second and experiments have shown that this is practically the same as the velocity of electromagnetic or radio waves. Expressed in meters this is equal to 300,000,000 (appx.) meters per second. Assuming that a transmitting station is using a wave-length of 500 meters, the frequency will be obtained in cycles per second by dividing the velocity of the waves by the

KILOCYCLES TO METERS, OR METERS TO KILOCYCLES

Meters	Kilocycles	Meters	Kilocycles	Meters	Kilocycles	Meters	Kilocycles	Meters	Kilocycles	Meters	Kilocycles	Meters	Kilocycles
10	29980	720	416.4	1430	209.7	2140	140.1	2850	105.2	4120	72.77	6400	46.85
20	14990	750	410.7	1440	208.2	2150	139.5	2860	104.8	4140	72.42	6450	46.48
30	9994	780	405.2	1450	206.8	2160	138.8	2870	104.5	4160	72.07	6500	46.13
40	7496	810	399.8	1460	205.4	2170	138.2	2880	104.1	4180	71.73	6550	45.77
50	5996	840	394.5	1470	204.0	2180	137.5	2890	103.7	4200	71.39	6600	45.43
60	4997	870	389.4	1480	202.6	2190	136.9	2900	103.4	4220	71.05	6650	45.09
70	4283	900	384.4	1490	201.2	2200	136.3	2910	103.0	4240	70.71	6700	44.75
80	3748	930	379.5	1500	199.9	2210	135.7	2920	102.7	4260	70.38	6750	44.42
90	3331	960	374.8	1510	198.6	2220	135.1	2930	102.3	4280	70.05	6800	55.09
100	2998	990	370.2	1520	197.2	2230	134.4	2940	102.0	4300	69.73	6850	43.77
110	2726	810	365.6	1530	196.0	2240	133.8	2950	101.6	4320	69.40	6900	43.45
120	2499	830	361.2	1540	194.7	2250	133.3	2960	101.3	4340	69.08	6950	43.14
130	2306	840	356.9	1550	193.4	2260	132.7	2970	100.9	4360	68.77	7000	42.83
140	2142	850	352.7	1560	192.2	2270	132.1	2980	100.6	4380	68.45	7050	42.53
150	1999	860	348.6	1570	191.0	2280	131.5	2990	100.3	4400	68.14	7100	42.23
160	1874	870	344.6	1580	189.9	2290	130.9	3000	99.94	4420	67.83	7150	41.93
170	1764	880	340.7	1590	188.6	2300	130.4	3020	99.28	4440	67.53	7200	41.64
180	1666	890	336.9	1600	187.4	2310	129.8	3040	98.62	4460	67.22	7250	41.35
190	1578	900	333.1	1610	186.2	2320	129.2	3060	97.97	4480	66.91	7300	41.07
200	1499	910	329.5	1620	185.1	2330	128.7	3080	97.34	4500	66.61	7350	40.79
210	1428	920	325.9	1630	183.9	2340	128.1	3100	96.72	4520	66.33	7400	40.52
220	1363	930	322.4	1640	182.8	2350	127.6	3120	96.10	4540	66.04	7450	40.24
230	1304	940	319.0	1650	181.7	2360	127.0	3140	95.48	4560	65.75	7500	39.98
240	1249	950	315.6	1660	180.6	2370	126.5	3160	94.88	4580	65.46	7550	39.71
250	1199	960	312.3	1670	179.5	2380	126.0	3180	94.28	4600	65.18	7600	39.45
260	1153	970	309.1	1680	178.5	2390	125.4	3200	93.69	4620	64.90	7650	39.19
270	1110	980	305.9	1690	177.4	2400	124.9	3220	93.11	4640	64.62	7700	38.94
280	1071	990	302.8	1700	176.4	2410	124.4	3240	92.54	4660	64.34	7750	38.69
290	1034	1000	299.8	1710	175.3	2420	123.9	3260	91.97	4680	64.06	7800	38.44
300	999.4	1010	296.9	1720	174.3	2430	123.4	3280	91.41	4700	63.79	7850	38.19
310	967.2	1020	293.9	1730	173.3	2440	122.9	3300	90.86	4720	63.52	7900	37.95
320	936.9	1030	291.1	1740	172.3	2450	122.4	3320	90.31	4740	63.25	7950	37.71
330	908.6	1040	288.3	1750	171.3	2460	121.9	3340	89.77	4760	62.99	8000	37.48
340	881.8	1050	285.5	1760	170.4	2470	121.4	3360	89.23	4780	62.72	8050	37.25
350	856.6	1060	282.8	1770	169.4	2480	120.9	3380	88.70	4800	62.46	8100	37.02
360	832.8	1070	280.2	1780	168.4	2490	120.4	3400	88.18	4820	62.20	8150	36.79
370	810.3	1080	277.6	1790	167.5	2500	119.9	3420	87.67	4840	61.95	8200	36.56
380	789.0	1090	275.1	1800	166.6	2510	119.5	3440	87.16	4860	61.69	8250	36.34
390	768.8	1100	272.6	1810	165.6	2520	119.0	3460	86.65	4880	61.44	8300	36.12
400	749.6	1110	270.1	1820	164.7	2530	118.5	3480	86.16	4900	61.19	8350	35.91
410	731.3	1120	267.7	1830	163.8	2540	118.0	3500	85.66	4920	60.94	8400	35.69
420	713.9	1130	265.3	1840	162.9	2550	117.6	3520	85.18	4940	60.69	8450	35.48
430	697.3	1140	263.0	1850	162.1	2560	117.1	3540	84.70	4960	60.45	8500	35.27
440	681.4	1150	260.7	1860	161.2	2570	116.7	3560	84.22	4980	60.20	8550	35.07
450	666.3	1160	258.5	1870	160.3	2580	116.2	3580	83.75	5000	59.96	8600	34.86
460	651.8	1170	256.3	1880	159.5	2590	115.8	3600	83.28	5020	59.72	8650	34.66
470	637.9	1180	254.1	1890	158.6	2600	115.3	3620	82.82	5100	58.79	8700	34.46
480	624.6	1190	252.0	1900	157.8	2610	114.9	3640	82.37	5150	58.22	8750	34.27
490	611.9	1200	249.9	1910	157.0	2620	114.4	3660	81.92	5200	57.66	8800	34.07
500	599.6	1210	247.8	1920	156.2	2630	114.0	3680	81.47	5250	57.11	8850	33.88
510	587.9	1220	245.8	1930	155.3	2640	113.6	3700	81.03	5300	56.57	8900	33.69
520	576.6	1230	243.8	1940	154.5	2650	113.1	3720	80.60	5350	56.04	8950	33.50
530	565.7	1240	241.8	1950	153.8	2660	112.7	3740	80.17	5400	55.52	9000	33.31
540	555.2	1250	239.9	1960	153.0	2670	112.3	3760	79.74	5450	55.01	9050	33.13
550	545.1	1260	238.0	1970	152.2	2680	111.9	3780	79.32	5500	54.51	9100	32.95
560	535.4	1270	236.1	1980	151.5	2690	111.5	3800	78.90	5550	54.02	9150	32.77
570	526.0	1280	234.2	1990	150.7	2700	111.0	3820	78.48	5600	53.54	9200	32.59
580	516.9	1290	232.4	2000	149.9	2710	110.6	3840	78.08	5650	53.07	9250	32.41
590	508.2	1300	230.6	2010	149.2	2720	110.2	3860	77.67	5700	52.60	9300	32.24
600	499.7	1310	228.9	2020	148.4	2730	109.8	3880	77.27	5750	52.14	9350	32.07
610	491.5	1320	227.1	2030	147.7	2740	109.4	3900	76.88	5800	51.69	9400	31.90
620	483.6	1330	225.4	2040	147.0	2750	109.0	3920	76.49	5850	51.25	9450	31.73
630	475.9	1340	223.7	2050	146.3	2760	108.6	3940	76.10	5900	50.82	9500	31.56
640	468.5	1350	222.1	2060	145.5	2770	108.2	3960	75.71	5950	50.39	9550	31.39
650	461.3	1360	220.4	2070	144.8	2780	107.8	3980	75.33	6000	49.97	9600	31.23
660	454.3	1370	218.8	2080	144.1	2790	107.5	4000	74.96	6050	49.56	9650	31.07
670	447.5	1380	217.3	2090	143.5	2800	107.1	4020	74.58	6100	49.15	9700	30.91
680	440.9	1390	215.7	2100	142.8	2810	106.7	4040	74.21	6150	48.75	9750	30.75
690	434.5	1400	214.2	2110	142.1	2820	106.3	4060	73.85	6200	48.36	9800	30.59
700	428.3	1410	212.6	2120	141.4	2830	105.9	4080	73.49	6250	47.97	9850	30.44
710	422.3	1420	211.1	2130	140.8	2840	105.6	4100	73.13	6300	47.59	9900	30.28
										6350	47.22	9950	30.13

## Kiloline

length of a single wave, which in this case would be equal to 300,000,000 (appx.) divided by 500, equalling 600,000 cycles per second or (reduced to kilocycles by dividing by 1,000) 600 kilocycles. On the preceding page is given a chart for converting kilocycles to meters, or meters to kilocycles.

**KILOLINE**—This is equal to 1,000 lines of force, or 1,000 maxwells (q.v.). The maxwell or the line of force is the unit used to measure magnetic flux. (See *Line of Force, Maxwell, Magnetic Flux.*)

**KILOVOLT**—abbreviated K.V.—The kilovolt is equal to 1,000 volts.

**KILOVOLT-AMPERE**—Abbreviated K.V.A. or kv-a.—The product of the effective volts across the terminals of a circuit by the effective amperes flowing in that circuit, divided by 1,000. Alternators are rated in kilovolt-amperes because their load determines the power factor. This with a zero power factor (q.v.) the true power (q.v.) in kilowatts would equal zero even if the alternator were delivering maximum amperes and maximum volts. At 50% power factor the kilowatt capacity would be half that at 100% power factor. On the other hand the kilovolt-ampere capacity remains the same no matter what the power factor.

**KILOWATT**—abbreviation K.W.—The kilowatt is a unit of electrical power having the value of 1,000 watts. One kilowatt equals 1,000 watts. To reduce the power expressed in kilowatts to watts, it is necessary to multiply the number of kilowatts by 1,000. Most electrical formulas use watts rather than kilowatts. Therefore, in solving such formulas, where the power is given in kilowatts, it is necessary to multiply this by 1,000 before using it in the formula. For example, suppose the power expended in an electrical circuit carrying 100 amperes is 20 kilowatts. The voltage will equal the power in watts divided by the current

in amperes. This is  $\frac{20 \times 1,000}{100}$

volts. Motors are often rated in kilowatts instead of horsepower. For practical calculations, the horsepower rating of a motor is equivalent to two-thirds of its kilowatt rating. (See *watts.*)

**KILOWATT-HOUR**—The energy expended when work is done for one hour at the rate of one kilowatt. It is possible to calculate the energy expended in an electrical circuit over a certain period of time, knowing the current in amperes and the resistance of the circuit. Using the following formula the energy expended will be obtained in kilowatt-hours:

Work performed or energy expended =  
Current<sup>2</sup> × Resistance × Time†

3,600,000

= kilowatt-hours.

**KIMURA SHUNKICHI**—Japanese radio authority. Kimura was born in 1866, and educated at the Scientific College of the Tokyo Imperial University, his special study being physics, which he continued to study at Harvard and Yale Universities, United States.

In 1901 Kimura entered the Japanese Navy and first began to study wireless telegraphy, particularly for naval use. In 1906 he was appointed the Japanese delegate to the International Wireless Telegraph Conference, Berlin, and after his retirement from the Navy,

1912, he became the director of the Nippon Radio Telegraph and Telephone Company. Kimura has written largely on radio subjects for various scientific journals.

**KINETICS**—That branch of dynamics dealing with forces that produce or change motion. Energy is usually classified either as *potential* or *kinetic*. When energy is available for the production of work it is referred to as potential energy. Energy at work is *kinetic energy* (q.v.). The term *kinetic* refers to motion.

**KINETIC ENERGY**—The work a body is able to do by reason of its motion. The unit of energy is the *erg*. This unit is also used to measure work. (See *Erg.*) It should be noted that *kinetic energy* is stored in the magnetic field. It requires more energy to start a current in a circuit having great inductance than in one having small inductance. This greater amount of energy is stored in the magnetic field and is returned to the circuit when the current decreases to zero.

**KINRAIDY SPARK GAP**—A form of *quenched spark gap* (q.v.) consisting of two water-cooled flat terminals close together and between which discharge occurs.

**KIRCHOFF'S LAWS**—These are two in number. First Law: The sum of the currents flowing to a point, in any electrical circuit, is equal to the sum of the currents flowing away from that point. Second Law: In any closed electrical circuit, the sum of the impressed *electromotive forces* (q.v.) will equal the sum of the *voltage drops* (q.v.). This statement requires modification, in so far as "addition" of voltages is concerned. Voltages are added provided that they are in the same direction, but must be subtracted if in opposite directions. These two laws depend on *Ohm's Law* (q.v.) and constitute a further application of that law to more complicated electrical circuits. In addition to simple electrical circuits, conductors may be connected in various complicated networks, all of which come under the heading of *divided circuits*. By means of *Kirch-off's Laws*, the current in any part of a divided circuit may be found, if the resistances of the various parts, and the electromotive forces are given.

**KITES AS AERIAL SUPPORTS**—During the early experiments with wireless, kites were successfully employed by Marconi as aerial supports.

**KLEIN, RENE HENRI**—Anglo-French radio expert. Born at Soult-sous-Forêt, France, in 1880, he first became interested in wireless telegraphy in 1908. He was the founder and first honorary secretary of the Wireless Society of London, 1913-20, and became a vice-president of the society. He was one of the inventors with H. L. McMichael of the synthetic galena crystal Radiocite, and has written many articles on wireless subjects.

**KNIFE SWITCH**—A switch in which the movable arm wedges in between two parallel spring clips. Knife switches may be either of the *single pole* (s.p.) or *double pole* (d.p.) types and also may either be *single throw* (s.t.) or *double throw* (d.t.). Knife switches are often referred to as *Lever switches*. They are used on direct current circuits up to 250 volts and on alternating current circuits up to 500 volts (See *Ground Switch; Double Throw Switch.*)

**KLEMENCIC THERMAL JUNCTION**

—A device consisting of two thin

sheets of brass, designated in the illustration as A, A. These are 4 inches by 11.8 inches and are placed about 1 inch apart. Soldered to one plate is a fine platinum wire and to the other plate

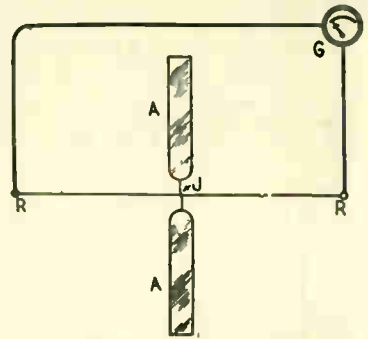

Schematic diagram showing Klemencic thermal junction.

is a fine platinum-nickel wire. These two wires are connected together at J to form a *thermal junction* (q.v.) and are then led off at right angles and are soldered at their other ends to the leads R, R, of a sensitive *galvanometer* (q.v.). This resonance system is fixed at the focal line of a suitable cylindrical metallic reflector. When electric waves, with the electric force parallel to A A fall on this receiver, electric oscillations between A and A produce heating at the junction J which is the point of contact between the two dissimilar metals. In consequence, the heat developed gives rise to a thermoelectromotive force at the junction and consequently to a current in the galvanometer. This instrument can be used to detect and measure electric waves.

**KOEPSSEL PERMEAMETER**—An instrument used for measuring the *permeability* (q.v.) of an iron or steel bar. In its principle of operation, this device is a movable coil milli-voltmeter in which the permanent magnet is replaced by an electromagnet. The sample to be tested forms a part of this electromagnet. The flux produced in the sample and in the pole pieces of the instrument is measured by a movable coil similar to those used in direct current voltmeters. The coil is supplied with energizing current from a small dry battery. Deflections are indicated by a pointer on a dial, the scale being calibrated directly in magnetic densities.

**KOHLRAUSCH'S LAW**—This law states that the rate of motion of each atom in a solution undergoing electrolysis for a given liquid is independent of the element with which it may be have been in combination.

**KOLSTER, FREDERICK A.**—American radio authority. Born at Geneva, Switzerland, January 13, 1883, he was educated at Cambridge, Mass., and Harvard University. From 1902-08 he was assistant to J. S. Stone, the radio expert, and from 1909-12 to Dr. Lee de Forest. He was appointed chief of the Radio Section of the Bureau of Standards, a post he held until 1921, when he became research engineer to the Federal Telegraph Company.

Kolster has written a large number of articles on radio subjects, including those on the "Effects of Distributed Capacity in Coils," "Reinforced Harmonics in Radio Transmission," etc. He is the inventor of the Kolster decimeter, of a radio compass, of directional radio systems, etc., and is a

\*Ohms. †Seconds.



member of the American Institute of Radio Engineers.

**KOOMANS, NICHOLAS**—Dutch radio authority. Born at Delft, 1879, he was educated there as a mechanical and electrical engineer. In 1908 he received his doctorate for his dissertation "Regarding the Influence of Self-Induction in Telephone Conducting Wires." He was one of the founders of and editor of the "Monthly Review of Telephony and Telegraphy," and was also one of the founders of the Dutch Society for Radio Telegraphy. Koomans is a member of the International Electro-technical Commission and professor in physics and theoretical electrical engi-

neering at the school of the Dutch Post and Telegraph Administration.

**KORDA AIR CONDENSER**—A variable condenser (q.v.) using air as the dielectric (q.v.) consisting of two sets of semi-circular plates, one set being connected together and fixed in position and the other set being also connected together but capable of being rotated about a central axis. Rotating the movable plates brings a greater or less area of the two sets of plates into interlapping positions, thus permitting the capacity of the condenser to be varied. This condenser was patented by Korda in Germany in 1893.

**KORN, ARTHUR**—German radio ex-

pert. Born at Breslau, Germany, 1870, Korn was educated at Leipzig and Paris and became professor of physics at the University of Munich, 1903-8, and afterwards professor at the Polytechnical High School, Charlottenburg, Berlin.

Korn is well known for his experiments on and the invention of a method of transmitting photographs by telegraphy, the first photograph being telegraphed from Munich to Berlin in 1907 by his methods. He is the inventor of a system of telautography and wireless phototelegraphy, and the author of a number of standard books on electricity.

## L

**L**—The symbol of inductance (q.v.) or the coefficient of self-induction. In general, the coefficient  $L$  by which the rate of change of current in any circuit must be multiplied to obtain the value of the self-induced electromotive force (q.v.) is called the coefficient of self-induction or simply the inductance. (See *Self-induction, coefficient*.)

**LAG**—One alternating current quantity reaching its maximum at a later time than a second alternating current quantity. As an example,—the current is said to lag behind the impressed voltage when maximum current occurs after maximum voltage. In other words, the current and voltage in such an alternating current circuit are out of phase (q.v.). In the above example, since the current lags behind the voltage, the voltage is said to lead the current. Inductance (q.v.) in an alternating current circuit will cause the current to lag behind the impressed voltage. Capacity (q.v.) in such a circuit will cause the current to lead (q.v.) the impressed voltage. The word lag may be applied to magnetic quantities as well as electrical quantities. Thus, one magnetic flux may lag behind another as in the case of an induction motor where the induced magnetic flux (q.v.) lags behind the impressed magnetic flux. Another type of magnetic lag is the retardation of magnetic effects behind their causes, due to hysteresis (q.v.) in the magnetized substance. (See *Lead*, also *Leading Current*.)

**LAMINATED**—Composed of a number of thin plates, one on top of another. Examples of laminated construction are laminated brushes, laminated cores laminated conductors, etc.

**LAMINATED CORE**—An arrangement of soft iron plates or stampings forming the core of a transformer, or of an armature of a motor or generator. Cores are laminated in this way, principally to reduce eddy current (q.v.) losses. In the case of an armature core, this must be laminated parallel to the direction of rotation (in other words, perpendicular to the axis of rotation). Laminations are insulated from each other by means of japan, varnish, shellac or simply rust.

**LAMP BANK**—A bank of incandescent lamps arranged so that they can be connected in series or parallel. Lamp banks are used in laboratories in conjunction with electrical machinery under test. In this case, the lamps act as the load, the more lamps being connected in parallel, the greater the amount of current being drawn. Lamp banks are sometimes connected in series in a circuit for the purpose of reducing voltage. An example in this

connection is the use of a lamp or bank of lamps in charging a 6-volt storage battery from a 110-volt direct current

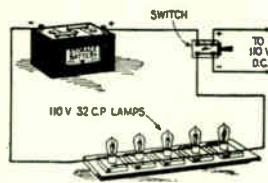

Use of lamp bank in charging storage battery.

source. Lamp banks are sometimes called lamp panels or lamp batteries.

**LANGMUIR, IRVING**—American radio authority. Born at Brooklyn, New York, January 31st, 1881, he was educated at the School of Mines, Columbia University, and was for some time assistant to Professor Nernst at the University of Göttingen. In 1906-9 he was instructor in chemistry at the Stevens Institute of Technology, and in the latter year he became a research assistant to the General Electric Company, at Schenectady. He has carried out a series of brilliant researches on apparatus used in wireless telegraphy and telephony, on electron discharge apparatus, atomic and molecular structure, etc.

Langmuir has paid particular attention to high-vacuum valves, and is the inventor of the Langmuir valve. To him is due the discovery that by treat-

ing the tungstic oxide used in the construction of tungsten filaments with certain compounds of thorium the filament becomes thoriated tungsten and the electronic emission is enormously increased. These filaments are the ones used in dull emitter valves, the electrons being given off at comparatively low temperatures. Langmuir is the author of many papers to scientific and technical journals, including those on pure electron discharge, thermionic currents in high vacua, etc. He is also well known for his mercury condensation pump for high vacua.

**LAP WINDING**—An armature winding in which the opposite ends of each coil are connected to adjoining commutator segments. As a result the windings lap back and upon themselves forming loops. Lap winding is also called loop winding, parallel winding and multiple winding. In the elementary form of lap winding the method of connection to the commutator bars is as follows: One side of a coil is connected to a commutator bar, and the other side of the coil, which is located 180 electrical degrees (the distance from the center of a north pole to the center of the adjacent south pole) away, has its end connection brought back and soldered to the next adjacent commutator segment. This method of overlapping the ends is continued all the way around the armature until all the slots have been filled and the circuit has been closed on itself. The coils must all be symmetrical. This means that if there is a forward throw of a certain num-

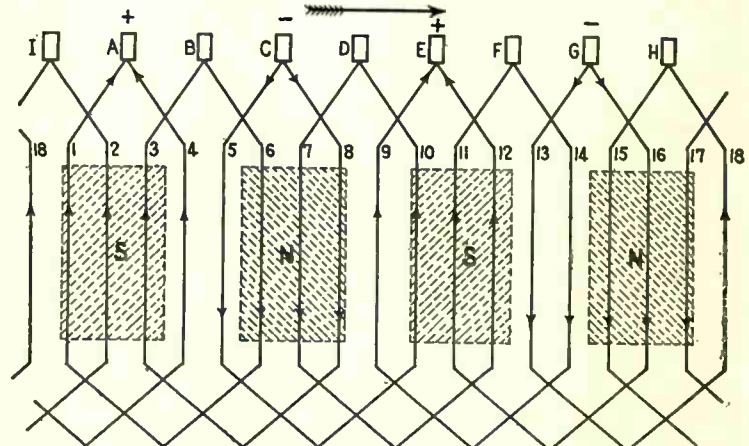

A typical lap winding shown in developed view. In the winding shown each inductor is connected at the rear of the armature to one five slots away. Thus 1<sup>st</sup> is connected to 8, 5 to 10, etc. After having made one complete "element"—as, for example, A-1-8-B—the winding forms a second "element." B-3-8-C, which laps over the first. This is continued around the armature until the winding closes on itself.

## Law of Electromagnetic Induction

ber of slots on the first coil, all the other coils must have the same forward throw. In like manner all the return throws must be the same. In the *lap wound* generator there are as many paths for the current as there are poles. Hence the name *parallel* or *multiple winding*. This necessitates the use of as many sets of brushes as there are poles. An increased number of paths in parallel means increased current capacity. In the case of a motor, the greater the number of armature paths between brushes, the greater will be the speed, other conditions remaining equal.

**LAW OF ELECTROMAGNETIC INDUCTION**—Also known as the "Law of Generator Action" and as "Faraday's Law." If there is relative motion between an electrical conductor and a magnetic field, such that the conductor cuts flux, an *electromotive force* (q.v.) will be induced in the conductor. The amount of the induced electromotive force will depend upon the strength of the magnetic field, upon the speed of cutting, upon the length of the conductor cutting the field and upon the direction of motion between the conductor and the field. Thus the stronger the magnetic field, the greater the induced electromotive force. The induced electromotive force will also increase with increased speed of cutting and with increased conductor length. When the conductor cuts the flux at right angles, the induced electromotive force is maximum. If the flux is cut in any other direction, the induced electromotive force will be less. The induced electromotive force decreases from maximum to zero as the angle of cutting decreases from 90 degrees to zero degrees. If a conductor is of such length and moves in such a direction, and at such a speed, as to cut 100,000,000 lines of force in one second, one volt (q.v.) will be induced in it. Expressed as an equation the induced electromotive force (in volts) will equal the flux cut (in lines or maxwells) divided by the product of the time (in seconds) times 100,000,000. This equation refers to the average value of the electromotive force induced in a single conductor. If a number of conductors are used the same electromotive force will be induced in each. If the conductors are so connected that their electromotive forces add up, the total average electromotive force can be found by multiplying the above equation by the number of conductors.

**LATOURE, MARIUS**—French radio expert. Born in October, 1875, he was educated at the University of Paris and the Ecole Supérieure d'Électricité, Paris. He was for many years consulting engineer to the General Electric Company, and he specialized in the construction of high-frequency machines. Latour is the designer of the so-called S. F. R. alternator, in which there are a smaller number of stator slots than usual.

During the World War Latour was engaged in research work under General Ferrie, and he invented a system of elimination of the interference produced in telephone lines by neighboring high-tension power lines which has been installed throughout the greater part of France. Latour is the inventor of the now widely used system of high-frequency multiplex telegraphy and telephony, using the three-electrode valve for generation and reception. He is a member of many scientific societies, including the Institute of Radio Engineers, and of the American Institute of Electrical Engineers. He has written many articles on radio for

scientific and technical journals, and is the inventor of a great many important radio developments covering practically the whole range of the art.

**LEAD**—Pronounced LEED—One alternating current quantity reaching its maximum at an earlier time than a second alternating current quantity. Thus in an alternating current circuit, the current is said to *lead* the voltage if maximum current occurs before maximum voltage. If the current reaches its maximum 90 electrical degrees ahead of the voltage, current and voltage are said to be in *quadrature* (q.v.) with current *leading* and voltage *lagging*. (See *Degrees, Electrical, also Leading Current and Lag.*)

**LEAD SULPHATE**—Formula  $PbSO_4$ .—A white insoluble salt which is found in native form in the ground and which can be formed artificially by adding sulphuric acid to a soluble lead salt. The active elements of a lead storage battery (q.v.) consists of ( $PbO_2$ ) lead peroxide on the positive plate and (Pb) spongy lead on the negative plate, with dilute sulphuric acid ( $H_2SO_4$ ) as the electrolyte (q.v.). The final result, on discharge of such a battery is the formation of lead sulphate on both the positive and negative plates. This is a part of the process of producing current. After a normal discharge, the sulphate is finely crystalline and of such nature that it is easily reduced by the current flowing through the battery on charge. If charging is neglected and the battery is allowed to stand in a discharged state, the sulphate gradually ceases to be crystalline. It fills the pores of the plates and finally makes the active material hard and dense, thus lengthening the time required for a charge. A battery in this condition is said to be *sulphated*. If sulphating proceeds too far, it will result in *buckling of plates* (q.v.), loss of active material, greatly decreased capacity, lower efficiency and an increased internal resistance. A moderately sulphated battery can be restored by means of a prolonged charging at a moderate rate. In a badly sulphated battery, a number of successive charges and discharges may be necessary.

**LEAD-IN**—The wire leading from the aerial to the radio apparatus. *Lead-in* wire, as used for receiving sets, is usually rubber covered wire although bare antenna wire can be used provided it is properly insulated from the walls of the building. A poorly insulated lead-in will greatly reduce the efficiency of the finest antenna. (See *Down Lead.*)

**LEAD-IN INSULATOR**—Any form of insulator used for passing aerial lead-in through window, wall or roof. These insulators are usually made of porcelain, electrose or insulated copper strips. (See *Insulator, lead-in, also Window Lead-in.*)

**LEADING CURRENT**—An alternating current which reaches its maximum value at an earlier time than the voltage. When an inductance is inserted in an alternating current circuit, the self-induced *electromotive force* (q.v.) will combine with the *impressed* electromotive force and the resultant of the two will be the active electromotive force which causes the current flow. The current will always be exactly in *phase* (q.v.) with and proportional to the resultant electromotive force. The induced electromotive force is 90 degrees behind the current and therefore behind the resultant electromotive force, which is in phase with the current. The impressed electromotive force will lead the current and will be higher than the resultant electromotive force

by an amount which at each instant is equal to the counter-electromotive force of the inductance. When a condenser is inserted in an alternating current circuit the current will charge the condenser. As the amount of current stored in the condenser increases, the electromotive force of the condenser increases also until the impressed and the condenser electromotive forces are equal. The condenser electromotive force, being a counter pressure, the current flow will cease when the two electromotive forces balance. The current being zero at this point and the condenser electromotive force a maximum, it follows that the condenser electromotive force is 90 degrees in advance of the current and hence of the resultant electromotive force which is in phase with the current. The impressed electromotive force lags behind the current which in this case is a *leading current* and moreover the impressed electromotive force is greater than the resultant electromotive force. It follows that if either capacity or inductance be placed in an alternating current circuit, the phase of the current with respect to the impressed electromotive force will change and the current flow will be reduced. Capacity sets up an electromotive force 90 degrees in advance of current flow, while inductance sets up an electromotive force of 90 degrees behind current flow. These two effects tend to neutralize each other when the proper amount of inductance and capacity are connected in series in a circuit and when they are just equal, no electromotive force other than the impressed is left to act on the circuit, the resultant and impressed electromotive forces are identical and there is no phase displacement. This is said to be a *resonant* (q.v.) circuit. (See *Lead, Lag, also Inductive Rise.*)

**LEADS**—Wires conveying or "leading" current from one point to another in a circuit. The conductors in any system of electrical distribution are referred to as *leads*. Sometimes the term *lead* is applied to the flexible wire or cable conveying current to or from a piece of apparatus.

**LEAK**—See *Grid Leak*.

**LEAKAGE LINES**—Also termed *leakage flux*—That part of the total magnetic flux in a magnet, transformer, generator, etc., which fails to complete the closed magnetic circuit and hence is dissipated or wasted. (See *Keeper*.)

**LEAKAGE SURFACE**—The flow of electricity across the surface of insulators. Its amount depends on the material and preparation of the surface and the humidity of the atmosphere and is recorded by measuring the surface *resistivity* (q.v.). Several methods are employed to reduce *surface leakage*. Porcelain insulators for outdoor use are often of the *petticoat* type so that a portion of the surface of the insulator remains dry during a rain or snow-storm. Another method very generally used in radio work to reduce surface leakage, is the use of corrugated surfaces on insulators. This method increases the length and hence the resistance of the surface across which leakage is likely to take place.

**LENGTH OF AERIAL**—The distance from the aerial binding post at the instrument to the farthest point of the antenna system, measured to any of its extremities. Only one component wire of a system is taken into consideration even if two, three or four are used. In a *T aerial* only half of the horizontal span must be added to the length of the down lead. In the *umbrella* type, the length of one radial lead is added to the down lead.

**LENZ'S LAW**—An induced current always tends to stop the motion which produces it. Stated in another way, whenever current flows in a conductor, due to electromagnetic induction, the action between the magnetic field which is being cut and the field around the conductor is always such as to tend to oppose further motion of the conductor. The following is still another way of stating *Lenz's Law*: The field due to the induced current always acts to prevent a change of the original field.

**LEYDEN JAR**—A condenser consisting of a glass jar with an outer and an inner coating of tinfoil covering the bottom and the sides nearly to the neck.



A small leyden jar.

A brass rod terminating in an external knob passes through a wooden stopper and is connected to the inner coating by a loose chain. This condenser received its name from Leyden, the city in Holland in which it was invented.

**L. F. C.**—Abbreviation for *Low Frequency Current*. (See *Frequency, Low, also Frequency*.)

**LIGHT**—Radiant energy or visible radiation which affects the eye so that objects become visible. Light consists of ether vibrations varying between 400 billions per second producing waves 271 ten-millionths of an inch in length and giving red light, up to 750 billions per second producing waves of 165 ten-millionths in length, giving violet light. Faster or slower vibrations produce waves not visible to the human eye. Shorter waves are called *ultraviolet rays*, while those immediately above the red rays are known as *infra-red rays*. The speed of light waves is identical with that of other electromagnetic waves and electricity, and is 186,000 miles or 300,000,000 meters per second.

**LIGHT LINE AERIAL**—A device which acts as an aerial for a radio receiving set and which utilizes the electric lighting system by means of a plug to which a condenser is attached. The plug is inserted in any lighting socket and the aerial connection of the receiving set it attached by means of a flexible lead to one terminal of the condenser. (See *Adapter, Aerial*.)

**LIGHTNING ARRESTER**—(Also called *lightning protector*.) A device for protecting radio or other electrical apparatus from lightning or from atmospheric discharges. Radio lightning arresters are provided with two terminals, one being connected with the

medium which offers practically no resistance (or technically speaking, which offers low impedance (q.v.)) to the flow of very high frequency currents such as lightning discharges. However, this medium acts as an insulator to the normal operating currents. Hence, during the ordinary re-

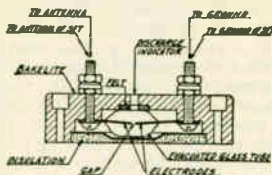

Vacuum type of lightning arrester for indoor work.

ception of radio signals, the currents flow past the arrester to the receiving instrument but they are unable to pass through the insulating medium of the lightning arrester to the ground. When there is a lightning discharge, the arrester offers the shortest and most direct path to the ground and hence the dangerous current never reaches the apparatus but proceeds directly to the

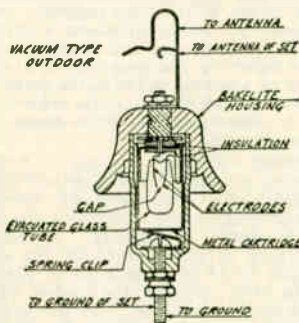

Sectional view of vacuum type lightning arrester used for outdoor work.

ground through the lightning arrester. The more popular designs of lightning arresters are of three types: vacuum, non-air-gap and air-gap. The vacuum type is the more sensitive of the three, due to its having a low functioning voltage. In a usual form, it consists



Outdoor vacuum type lightning arrester shown above in sectional view.

of two terminals in a sealed glass chamber from which air has been partially exhausted. This type of arrester can be discharged repeatedly without impairing its efficiency. The non-air-gap type of arrester involves the use of a carborundum stone, with a special clay binder. This type of arrester has a rectifying action similar to that used in a carborundum detector. The air-gap type of lightning arrester depends for its efficiency on a closely spaced

air-gap which offers a low break-down voltage. The Underwriters requirements call for the use of an approved lightning protective device on all radio receiving sets where outside aeri-als are used. Further requirements are that such arresters shall operate on 500 volts or less. (See *Arrester*.)

**LIGHTNING GAP**—This refers to the air gap or vacuum gap in a lightning arrester (q.v.). This gap is connected across the aerial and ground leads to the receiving set. When the potential in the aerial rises above a certain value (usually 500 volts or less) a spark jumps the gap, discharging the excessive energy to the ground without damage to the radio apparatus. (See *Gap Arrester*.)

**LIGHTNING SWITCH**—A single pole, double throw knife switch (q.v.) used for grounding the antenna during a storm, or in some cases at all times when the apparatus is not in use. The



Lightning switch combined with vacuum type lightning arrester.

upper terminal of the switch is usually connected to the aerial, the central terminal to which the switch arm is connected, leads to the radio set and the lower terminal is connected to the ground. In most installations, the lightning switch is mounted outside the building in which the radio apparatus is located. (See *Ground Switch*.)

**LIKE CHARGES**—Bodies which carry like electrostatic charge (q.v.) exert a repulsion against each other.

**LIKE POLES**—Like magnetic poles repel one another. This is one of the laws of magnetism. (See *Magnetism, Laws of*.)

**LIMITING VOLTAGE OF BRUSH DISCHARGE**—The potential at which a brush discharge passes into an arc or spark. Brush discharges and arcs may be reduced in radio transmitting apparatus by eliminating sharp points or edges on conductors and by coating the edges of metal plates with paraffin. (See *Brush Discharge, also Corona*.)

**LIMITING VOLTAGE OF GLOW DISCHARGE**—The potential at which the glow gives place to the brush discharge (q.v.) in a high tension line or in a radio transmitting aerial (q.v.). (See *Corona*.)

**LIMITS OF AUDIBILITY**—The limiting frequencies (q.v.) at which audible sounds are produced. These range from 500 to 1000 cycles per second up to as high as 10,000 cycles per second. *Audio frequencies* (q.v.) are sometimes defined as those conveniently heard in the telephone. (See *Frequency, High, also Frequency, Low*.)

**LINE**—A conducting wire between terminals in a system of electric communication or distribution. The positive wire is sometimes specifically referred to as the *line* and the return wire as *earth*. In many cases the earth or ground is used in the place of a return wire.

**LINE OF FORCE**—A theoretical conception used to map out a magnetic field and to show the direction along which the magnetism acts. *Lines of force* are conceived as forming closed loops and the path they traverse is called the *magnetic circuit* (q.v.) The positive direction of the *lines of force* is arbitrarily taken as that in which the north-seeking end of a compass moves. *Lines of force* are represented

A carborundum type lightning arrester consisting of a block of carborundum held between two pieces of high resistance carbon.

aerial and the other directly to a ground. Between these terminals is a

## Linear Oscillator

in diagrams by curves so drawn that the direction of the tangent at any point is the direction of the magnetic force (q.v.) at that point. The closeness of the lines is used to indicate the intensity of the force. The line of force is also used to indicate and map out an electrostatic (q.v.) field in the same way as it is used for the magnetic field. The line of force is also called the line of flux or the line of induction. This latter term is used especially where the line of force is being considered in respect to its electrical effect. In some cases it is simply referred to as a line. Thus a line (of force, or of flux, or of induction) is an electromagnetic unit of magnetic flux and is equal to  $10^{-8}$  webers (q.v.). In the practical system of measurements, the maxwell (q.v.) equal to one line, is the unit of magnetic flux (q.v.). When 100,000,000 maxwells are cut by a single conductor, in one second, one volt (q.v.) will be induced. (See Law of Electromagnetic Induction, also Electromagnetic field.)

**LINEAR OSCILLATOR**—See Oscillator, Linear.

**LINE RADIO**—Also known as *Wired Wireless*—A system of communication devised by Major General George O. Squier which permits the transmission of electromagnetic waves along a wire or conductor. Instead of the waves spreading out in all directions, as in ordinary broadcasting, the waves travel along a predetermined path, viz: the conductor. It is possible to transmit either code or speech by *wired wireless*. Vacuum tubes are used as oscillators at the transmitting end and a specially designed vacuum tube set is used as the receiver. When code transmission is desired, a telegraph key is inserted in the circuit to intermittently stop and start the oscillating waves. This produces dots and dashes and in this way it is possible to send code using undamped radio frequency waves. When it is desired to telephone, the key is omitted and the radio frequency or carrier waves (q.v.) are produced continuously except when they are varied or modulated in amplitude corresponding to the voice of the speaker at the transmitting end. The wave which passes from the transmitting end of the wire to the receiving end is of radio frequency and is called the carrier wave. In a way, this wave is analogous to the wire which carries the voice current in wire telephony. Line radio can be transmitted over ordinary telephone or telegraph lines at the same time as these lines are being used for their ordinary purposes and without any interference whatsoever. High-tension lines are also used for transmission of *wired wireless*.

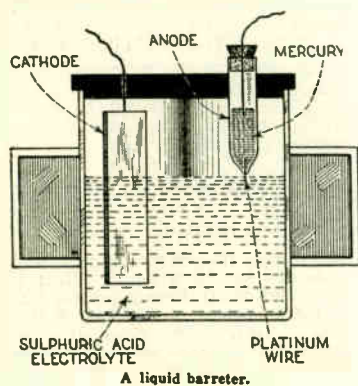

**LIQUID BARRETER**—An electrolytic detector which utilizes a very fine platinum wire dipped to a small depth in nitric or sulphuric acid. These detectors were formerly used to some extent in receiving wireless code messages. The electrolytic detector of the barreter type was invented and named by Fessenden (q.v.). The illustration shows a liquid barreter. In the glass jar is a platinum glass-anode, lead cathode and sulphuric acid electrolyte.

**LITZENDRAHT**—abbreviated Litz—A German word, meaning braided wire. A high frequency conductor built up of a number of very fine conducting strands. The individual strands are enameled and the conductor is usually so constructed that each strand comes to the surface or very near the surface at regular intervals. In the most effective form of conductor the strands are braided so as to form a woven tube. The strands are usually covered by a single braided silk wrapper. The use of litz tends to reduce skin effect (q.v.). This type of wire has been found to be especially effective when used in the construction of loop antennas (q.v.).

**LOADSTONE**—also spelled *Lode-stone*—Iron ore which shows magnetic properties. The name loadstone is derived from a word meaning leading stone and refers to the property of a compass of pointing to the north magnetic pole. The loadstone is also referred to as a natural magnet. (See Magnetite, also Magnet.)

**LOADING**—Adding capacity or inductance to a circuit. Inductance coils (q.v.) called loading coils are used to increase the inductance and condensers are used to increase the capacity. A loading coil may be used to increase the wave length (q.v.) of an antenna by placing it in series between the lead-in (q.v.) and the receiving set. In the case of a transmitting antenna, the loading coil may be used to tune the aerial for resonance (q.v.) at a desired frequency. An example of the use of loading, is that of the addition of a loading coil to a receiving set for the purpose of enabling the set to receive higher wave lengths.

**LOADING INDUCTANCE**—An inductance coil used to increase the wave length of a circuit. This term usually refers to an inductance coil used in connection with a radio receiving set for increasing its receptive wave length range. Sometimes the term loading coil is applied to a unit consisting of an inductance coil, mounted beneath a panel in a small cabinet. On the outside of the panel is a contact arm and a number of studs. These latter lead to taps taken from the inductance coil. By moving the contact arm from one stud to another it is possible to vary the loading of the circuit as desired. A loading coil connected in series with the aerial will increase the natural wave length of the aerial. (See Loading, also Inductance, Antenna.)

**LOCAL ACTION**—Electrochemical action within a cell, usually at the positive plate, which does not add to the useful output. In primary cells, zinc is the material usually employed for the positive plate. This zinc practically always contains impurities such as carbon, iron, etc. When the zinc is immersed in the electrolyte, there is a difference of potential between the zinc and the impurities and small local currents flow from the zinc through the electrolyte to the impurities and back to the zinc again. These currents serve no useful purpose and moreover

use up the zinc and the electrolyte. Local action can be practically eliminated by coating the surface of the zinc with mercury. This is called amalgamation. In secondary cells or accumulators (q.v.) local action is due to the action which takes place between the lead of the positive and the coating of lead sulphate.

**LOCAL OSCILLATIONS**—Oscillations set up in the vicinity of a receiving set for test purposes or within the set, as in the super-heterodyne, to produce oscillations differing in frequency from the incoming oscillations so as to establish a beat frequency. Local oscillations may be produced by means of a buzzer. This is a method frequently used in testing. The use of such oscillations enables a manufacturer of radio receiving sets to test these sets for selectivity, etc., without waiting for actual broadcasting. In the super-heterodyne (q.v.) local oscillations are produced by a suitably arranged vacuum tube. (See Driver.)

**LOCUS**—The path of a movement graphically represented by a curve. In mathematical language, the locus of an equation is the curve that contains all the points whose co-ordinates satisfy the equation. The circle is defined as the locus of all points in a plane equidistant from a fixed point in the plane called the center.

**LEDGE, SIR OLIVER**—British Physicist and radio pioneer. Born at Pen-



Sir Oliver Lodge.

hull, near Stoke-upon-Trent, June 12th, 1851, Oliver Lodge went to the Newport Grammar School at the age of eight, but at fourteen was taken into business to help his father. He worked in the evenings for the intermediate examination in science at the University of London, and eventually took first-class honors in physics. In 1872 he went to University College, London, and in 1877 took his D.Sc. in electricity and became demonstrator, and afterwards assistant professor in physics at University College.

In 1881 he was appointed first professor of physics at Liverpool, and in 1887 he was made a Fellow at the Royal Society. In 1888 he received the honorary L.L.D. of the University of St. Andrews, the first of a long series of such distinctions. In 1900 he was appointed the first principal of the University of Birmingham, a post from which he retired in 1920. In 1902 he was knighted. Sir Oliver Lodge is one of the foremost physicists of his time, and his brilliant series of researches into electrical phenomena, which he has made his special study have had a profound effect in all branches of that subject. To him, indeed radio owes as much as to any man, for he dealt with fundamentals when the whole subject of electromagnetic radiation was in its infancy. He was led to study the surging and oscillating char-

acter of an electrical discharge along wires as a result of his investigations as to the best means of protection against lightning.

One very remarkable experiment of his is now well known under the name of Lodge's resonating jar, now used as a measurer of wave length. In these experiments Lodge was really dealing with the electromagnetic waves discovered by Hertz in 1888. Lodge early recognized the vast importance of the discovery by Hertz, which so brilliantly confirmed the theories of Clerk-Maxwell, and he threw himself into work of investigating these ways with an energy which made him the foremost British physicist on the subject at the time. All this was pioneer work before Marconi and others came along and built upon the solid foundations which Lodge had prepared.

It was during this early period that Lodge discovered his coherer, and with this detector devised the first practical wireless telegraph, sending signals over a distance of several hundred yards. In May, 1897, Lodge took out his fundamental patent for tuning—a patent that was successfully upheld in the law courts, and extended for seven years by Lord Parker. The patent was acquired by the Marconi Company in 1911. Sir Oliver Lodge has been a pioneer in many other directions. His theories and experiments in connection with the ether, of which he is the leading exponent, are well known, and he has carried out a number of interesting researches on the passage of electricity through liquids. Sir Oliver was the first to devise a simple and direct experiment to show the speed and direction of travel of the constituents of a salt in solution when broken up by a current of electricity. For his researches on electric waves and the passage of light through a moving medium, Sir Oliver Lodge received in 1898 the Rumford Medal of the Royal Society, one of the highest honors the society bestows.

Sir Oliver Lodge has won a well-deserved reputation for the clearness and simplicity with which he is able to explain many of the difficult and fundamental truths of physics, and this clarity of expression is well shown in the many articles he has written.

**LOGS**—A list of dial readings of a radio receiving set with corresponding call letters of the broadcasting stations received at these readings. A radio set is said to *log* when the same stations always come in at exactly the same dial readings. Thus on a three dial set, if WEAJ comes in at 61, 60 and 60 and always comes in at these identical readings using the same aerial, the set *logs*. All present day sets are constructed so that stations can be accurately logged. Sometimes the term *log* is used to refer to a graph or chart on which dial settings are plotted against wave lengths of

stations recorded. A graph is a diagrammatic representation by means of lines, of the relation between several quantities. Figure 1, gives a simple illustration of this. Suppose it is desired to obtain a general idea of how the radio business varies from year to year or from season to season. On a piece of paper, ruled both vertically

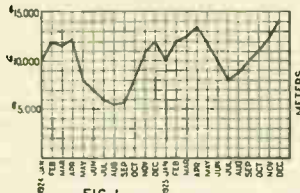

FIG. 1  
Log showing variation of a business.

and horizontally, as in Figure 1, the months and years are marked at the bottom horizontally. The vertical lines then represent the months and the bottom horizontal line is called the *axis of time*. These vertical lines are known technically as *ordinates*. The vertical line to the extreme left is called the *axis of ordinates* and after it has been marked as shown in Figure 1, to represent dollars, it may be

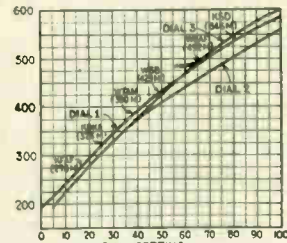

FIG. 3  
A three-dial radio log using only one chart.

referred to as the *axis of dollars*. The horizontal lines are known as *abscissas*, the bottom horizontal line being the *axis of abscissas*. Assume that a certain radio concern did \$10,000 worth of business in the month of January, 1924. Looking upward along the vertical line representing this month, until the horizontal line representing \$10,000 is reached, a point is put at the intersection of these two lines. Suppose that in the following month, February, 1924, the firm does \$12,000 worth of business. The point is found as before by following the line February, 1924, up to the line indicating \$12,000. Each horizontal line in the figure represents \$1,000, so that this point should be found two lines higher than the one marked for \$10,000. This can then be continued indefinitely, plotting the amount of business for each month. Assume that in the summer there is a lull in busi-

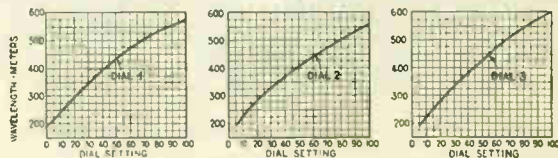

Fig. 5—A three-dial radio log using three separate charts.

ness. The decline starts, say, in the month of May. The business done amounted to \$8,000. By glancing at the chart it is possible to ascertain a number of facts which stand out much clearer than where columns of figures are given. Thus the seasonal char-

acter of the business is apparent at a glance. It can also be seen readily that the business was better in 1925 than in 1924, etc. Radio logs are plotted in exactly the same way. Each point must be obtained individually in order for the curve to be absolutely accurate, although in many cases a few well chosen points are

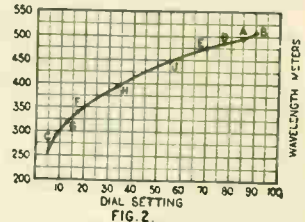

FIG. 2  
A radio log.

sufficiently satisfactory. In Figure 2, the dial setting is marked along the bottom of the chart. The scale is here chosen at one division on the chart equal to 5 divisions of the dial. If preferred the scale could be chosen so that one division on the chart would equal one division on the dial as shown on chart on the following page, which is a typical log of an actual set. Proceeding, it is first necessary to find

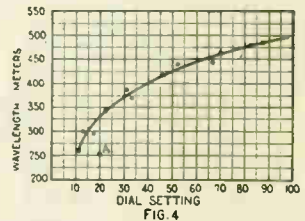

FIG. 4  
Radio log showing curve drawn so as to touch as many points as possible.

out the limits of the chart. The limits of the horizontal scale are already known, i.e., zero to 100 on the dial. Looking over the list of broadcasting stations, it is found that they all have wave lengths which fall, roughly between 200 and 600 meters. Therefore it is not necessary to make the vertical scale include wave lengths outside of this range. Consequently the vertical scale is started at 200. Counting upward, two divisions on the chart are taken, for convenience, as equal to 50 meters. Having done this, actual readings are next taken on the radio set. Suppose that the first station tuned in is WEAJ and that this is tuned in at 85 on the dial. This station has a wave length of 492 meters. Looking along the bottom of the chart for 85, the vertical line is then followed until the position of 492 meters is reached. This is slightly below the

500 line on the chart, Figure 2, and is indicated by the letter A. Next suppose that WOO, having a wave length of 509 meters is tuned in at 90 on the dial. This, then gives the point marked B. Then another station is tuned in, indicated by the point C.

Various stations are thus located by points on the chart until enough points are obtained to draw the curve. If the points do not give a smooth curve, it is necessary to approximate a curve, that is to draw it so as to pass through as many of the points as possible. This has been done in Figure 4.

Sometimes points are obtained that do not seem to have any meaning, such as the point A in Fig. 4. This point may have been subject to inaccuracies in reading the dial, or perhaps the operator did not read the wave length correctly from the list of stations. There is always the possibility, also, that he did not plot the point properly. He has plotted the point A as 251 meters at a setting of 20 when it might have been 335 meters at 20 on the dial, in which case it would have fallen directly upon the curve. If none of these difficulties can be found with the point A it can be discarded, however, because it is an absurd point, as the 12 other points, which determine the curve, will testify. Generally it is not good practise to discard points, but the experimenter must learn to use his good judgment.

for this is, that although these sets are supposed to tune to stations with identical dial settings, many of them do not do so, a difference as great as 10 divisions on the dial often being found. A three dial log is shown in Fig. 5. Separate charts may be used for each dial, or, for convenience, as has been done in Fig. 3, the three charts may be combined into one. If the difference between the dial settings is very small, say only a division or two, one curve will be sufficient.

Many things can be learned from studying the curves obtained. Take for instance, Fig. 2. This is practically a straight line at the higher wave lengths, changing from about 500 meters to about 400 in 55 divisions of the dial. In the remaining 35 divisions of the dial the wave length changes from 400 to 250. In the first case there was a range of 100 meters for 55 divisions and in the latter case a range of 150 meters in 35 divisions. This is because the curve bends downward. At the low dial settings a small change in the dial reading means a relatively large change in wave length, while at the upper end of the dial the same change in dial reading will mean

cycle equals 1000 cycles), and a station on 200 meters corresponds to a frequency of 1,363.5 kilocycles. In other words the difference in wave length is only 20 meters whereas the difference in kilocycles in 136.5. These two wave bands are at the low end of the present broadcast wave band. Now at the high end of the band we find a wave length of 600 meters corresponds to 500 kilocycles, and a wave of 580 meters corresponds to 517.2 kilocycles, or a difference of but 17.2 kilocycles for the 20 meter difference in wave length. At the lower end of the broadcast band between 200 and 220 meters we found a difference of 20 meters equalled 136.5 kilocycles. This indicates that as the wave length becomes lower the difference in frequency becomes very high.

To bring this most strongly to the mind, go down to the extremely low wave of 5 meters. Here the frequency is found to be 60,000 kilocycles. Going up to 25 meters, this corresponds to 12,000 kilocycles, so that for this difference of 20 meters there is the tremendous difference of 48,000 kilocycles.

The accompanying illustration, Fig. 6 will explain the matter very clearly.

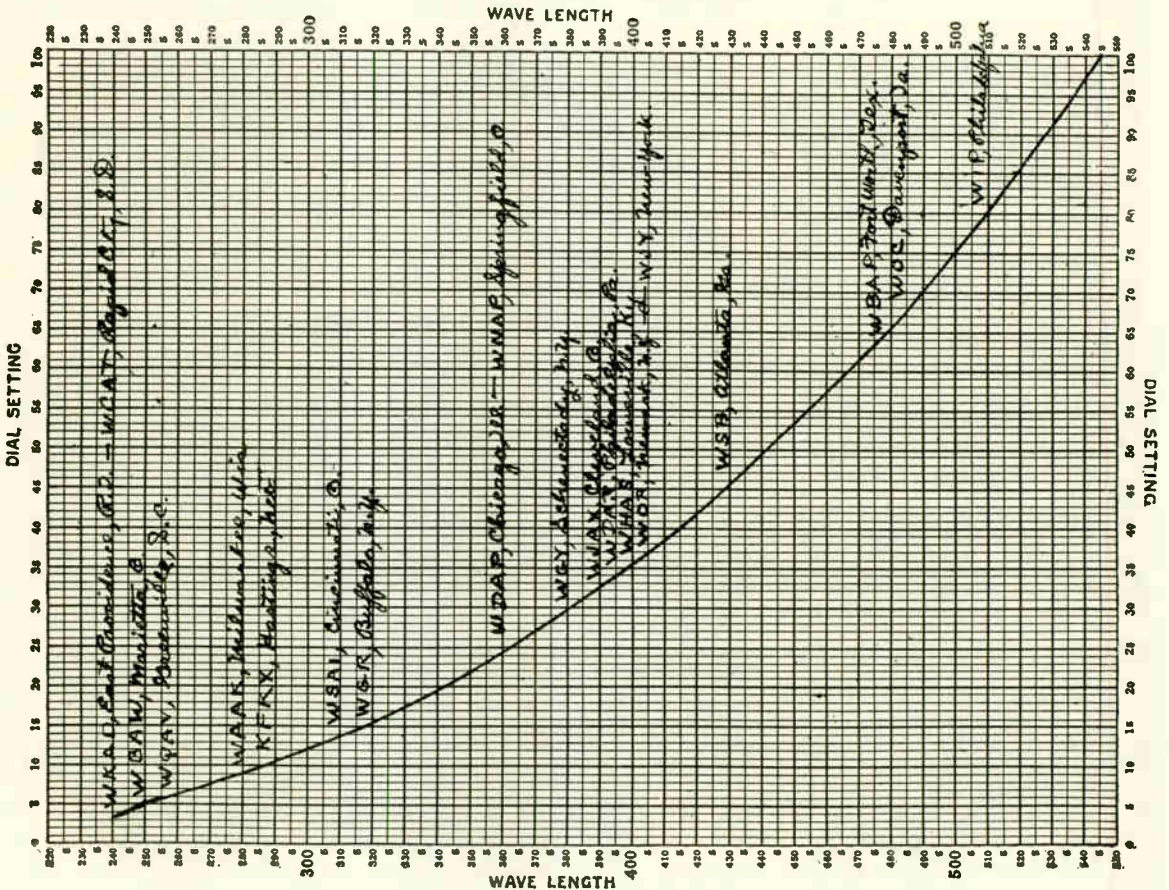

An example of a station log chart.

In single-control sets, where only one dial is employed it is only necessary to have one of these radio log curves. In receivers, such as the Neutrodyne or any two-stage radio frequency amplifier, where three dials are employed, it is generally necessary to log each dial separately. The reason

a relatively small change in wave length. The reason why the stations are so crowded at present, at the small end of the dial, is then very apparent, i.e.:

To illustrate, a station operating on a 200 meter wave corresponds to a frequency of 1500 kilocycles (1 kilo-

In changing the dial setting from 100 to, let us say, 90, the wave length is changed roughly from 600 to 580 meters. This is a change from 500 to 517 kilocycles. On the other end of the dial from zero to about 10 we have a change of wave length of roughly 200 to 220 meters, an approx-

mate change of from 1500 to 1363 kilocycles. In the first case on the upper part of the dial we have only made a change of 17 kilocycles in the frequency. On the lower end of the dial we have made a change of 137 kilocycles.

a number greater than unity is positive and is one less than the number of figures to the left of the decimal. The characteristic of a number less than unity is negative and is one greater than the number of ciphers between the decimal and the first sig-

resistance and the smaller the inductance, the more rapid is the damping and the rate at which the oscillations increase. If the resistance, inductance and capacity of the circuit have fixed values, each successive maximum of current is the same fraction of the preceding maximum as the latter is of the maximum immediately preceding it. Thus, if the second maximum is 75 percent of the first maximum, the third will be 75 percent of the second, etc. The numerical value of the rate of decrease in this case is .75 and the natural logarithm of .75 is the logarithmic decrement or simply the decrement. (See Decrement, also Damped Waves.)

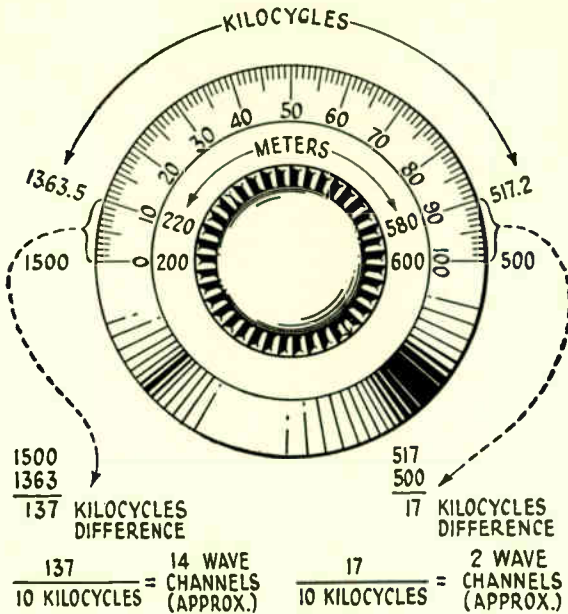

Fig. 6—This illustration shows clearly why stations are crowded on the dial at the lower wave lengths.

According to the frequency allocation as made by the Government, which places broadcast frequencies 10 kilocycles apart, on the upper 10 divisions of the dial there is room for approximately 2 frequency channels whereas on the lower 10 divisions of the dial there is room for roughly 14 frequency channels. This shows very clearly that we would have to be able to separate 14 stations on the lower 10 divisions whereas we have only 2 to separate on the upper 10 divisions of the dial.

So it will be understood why turning the dials but a degree or two at the low setting causes a relatively large change in frequency, tuning in perhaps several stations within one degree of the dial, while at the higher waves, due to the small difference in frequency, as stated, on the higher waves, it may be necessary to turn the dials two or three degrees on either side of the peak of the broadcast wave before it is tuned out. (See Dial.)

**LOGARITHM**—abbreviation **LOG**—The power to which a number (defined as a base) must be raised in order to equal a given number. As an example, given the number 100, assume that it is desired to determine the logarithm of this number to the base 10. (When 10 is used as a base, the logarithms obtained are said to belong to the common or Briggs system.) Then the exponent or power which will raise 10 to the value of 100 is known as the logarithm of 100. Obviously,  $10^2$  equals 100, therefore 2 is the logarithm of 100. Logarithms are used in the processes of multiplication, division, raising to powers and taking roots. The whole number, or integer part of a logarithm is called its characteristic and the fractional part, is referred to as its mantissa. The characteristic of

significant figure. A table of logarithms gives the mantissas only, the characteristic being determined as indicated above.

Logarithms are also used which have as their base the number 2.718 +. These are called natural or Napierian logs. The base number is usually represented by the symbol  $e$  (epsilon). The natural logarithm of any number may be found from a table of common logarithms by dividing the common log by the logarithm of 2.718 or simply by multiplying the common log by 2.30259. The symbol  $\ln$  is often used for the natural logarithm and the abbreviation *log* without a subscript is usually used for the logarithm to the base 10. (See Napierian Log, also Mantissa, and Log Table.)

**LOGARITHMIC CURVE**—A curve which has no definite minimum in a decreasing curve, or no definite maximum in an increasing curve. A logarithmic curve may be further defined as a curve whose ordinates increase arithmetically while its abscissas increase geometrically. A series of damped electrical oscillations diminish according to a logarithmic law and hence a curve drawn tangent to the successive maximum displacements will be a logarithmic curve.

**LOGARITHMIC DAMPING**—See Damping.

**LOGARITHMIC DECREMENT**—The Napierian logarithm (q.v.) of the ratio of any maximum to the next following maximum, with the current in the same direction in a decaying wave train. In other words the logarithm of the ratio of two maxima, one cycle apart. The rapidity with which the oscillations decay depends not only on the resistance of the circuit, but on the inductance as well. The greater the

**LOG TABLE**—A tabulated arrangement of logarithms which gives the mantissas (q.v.) only. The numbers whose logarithms are to be looked up are arranged for convenience in consecutive order. (See Logarithm.)

**LOMBARDI, DR. LUIGI**—Italian radio authority. Dr. Lombardi was born at Dronero, August 21, 1876. He graduated from the Royal Engineering School at Turin, Italy. He was Professor of Electricity at the Zurich Polytechnical School, Zurich, Switzerland, and also at the Royal Polytechnic School, Naples, Italy. Dr. Lombardi published many scientific papers including a study of condensers for transmission and he also invented a special high-tension electrical condenser.

**LONGITUDE**—The distance east or west of a meridian passing through Greenwich, England, measured in degrees, minutes and seconds.

**LOOP ANTENNA**—*Loop Aerial*—Also called *Coil Aerial* or simply *Loop*—A receiving or transmitting aerial (q.v.) consisting essentially of one or more turns of wire connected to the radio set so as to form a closed circuit. The loop acts as a simple inductance coil. The ordinary radio aerial acts as a huge condenser with the aerial system as one plate of the condenser and the ground or counterpoise (q.v.) as the other. Electromagnetic waves reaching the aerial set up an alternating electromotive force between the wires forming the upper plate of the condenser and the ground or lower plate of the condenser. This action takes place through electrostatic induction (q.v.). In the loop aerial, electromagnetic induction (q.v.) sets up an induced electromotive force thus causing

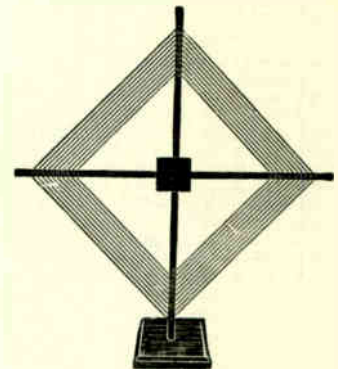

A typical loop antenna.

alternating current to flow to the detecting apparatus. While coil antennas may be used for transmitting, their use in this connection is rather limited. On the other hand, the use of the loop for radio receiving is widespread. The greater the area enclosed

## Loops

by a loop the greater the amount of energy it will receive. Loops more than two feet in diameter are usually constructed so as to be collapsible. A common type of loop shown in the illustration is 36 inches high and 28 inches wide. It consists of twelve turns of wire wound in the same vertical plane and held in place by polished hard rubber strips. It has a heavy cast base permitting rotation of the loop as desired. This loop folds up so as to fit into a four inch tube. In another type of loop, sometimes called the *box type*, the wires are wound so as to lie in the same horizontal plane instead of the vertical plane. The use of *Litzendraht*

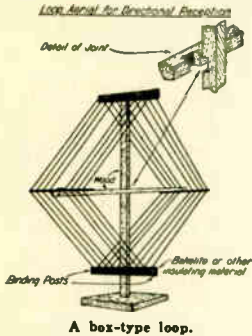

(q.v.) for winding loops has been found to add to their efficiency. Loops are commonly used on *super-heterodyne* (q.v.) sets, *reflex* (q.v.) sets and in some *tuned radio frequency* (q.v.) sets. These latter generally require an extra stage of amplification, although tuned radio frequency sets having only five tubes (detector, two stages of radio frequency and two stages of audio frequency) will operate on a loop and give especially good results when used with the new power tube. As a general rule, it may be stated that any set which will give good results with a loop, will give better results, insofar as distance is concerned, with an outside aerial. For this reason loop operating sets are quite generally constructed with extra binding posts for connecting aerial and ground. The loop is connected directly into the grid circuit, while the aerial and ground are connected to the circuit through an inductance such as an *oscillo-coupler* or antenna coupler. Loops may be used with satisfactory results inside of buildings. Where a compact, portable and selective aerial is desired, the loop is especially useful. The use of the loop, results in a marked directional effect and also has a tendency to reduce *static* (q.v.) and other forms of *interference* (q.v.). Loops are employed in wireless direction finders or *radio compasses* (q.v.) and are also used as aerials in submarine and aeroplane work. Where the loop is used as an aeroplane antenna it may be wound on the wings of the plane or it may be wound on a small frame and placed in the rear of the plane. (See *Coil Antenna*, also *Frame Aerial*.)

**LOOPS**—The points of greatest amplitude in a wave train. Sometimes called *antinodes*. The term *loop* is also used in describing the electrostatic field spreading out from a charged aerial. Each time an aerial is charged (for example by an induction coil) and discharged across a spark gap a group of gradually decaying oscillations is produced in the aerial called a *train of oscillations*. The interval of time

which elapses between a flow of the electricity in the aerial in one direction, and a succeeding similar move-

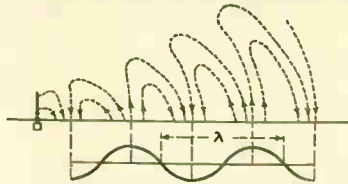

Semi-loops of electric force represented by the dotted lines moving away from the aerial represented by the short black line.

ment is called the *periodic time* and the reciprocal of this is called the frequency. For example, if the periodic time is one-millionth of a second, the frequency is one million. The diagram shows the manner in which *semi-loops* of electric force represented by the dotted lines move away from the aerial which is represented by the short black line.

**LORENZ COIL**—A form of low loss inductance coil, having an air core and of cylindrical shape, being wound in a single layer, with turns slightly linked to make the coil self-supporting. (See *Coil, Inductance Coils*, also *Low Loss Coils*.)

**LOUD SPEAKER**—A sound producing device for converting audio frequency currents into sounds loud enough to be heard by an assemblage of people. Nearly all *loud speakers* utilize an electromagnet in order to directly or indirectly cause a diaphragm to vibrate.

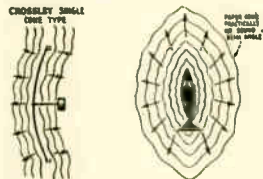

At the left is shown a cone-type speaker having a single diaphragm; at the right one with a double diaphragm.

The audio frequency currents flow through the windings of the electromagnet and the vibrations of the diaphragm correspond to the minute changes and fluctuations of the current thus accurately reproducing sounds. In loud speakers which utilize a metallic diaphragm, the electromagnet directly actuates the diaphragm. In other types, the diaphragm may be of mica, as in the Baldwin unit type, or of parchment or wood as in the cone type speakers. In these speakers, the electromagnet actuates an armature which in turn actuates the diaphragm through a lever action. In certain loud speakers, the electromagnet is of very powerful type and has a very small coil of fine wire attached to a diaphragm but not touching the poles of the magnet. The small coil is connected to the radio set or amplifier and the fluctuating audio frequency currents pass through it. These currents force the coil out of the strong magnetic field in the air gap. In moving, it moves the diaphragm to which it is attached. Speakers of this nature are sometimes called *electrodynamical speakers*. They are also referred to as *power speakers*. Such speakers give plenty of volume and in certain makes are reasonably good in tonal quality but they have the disadvantage that the electromagnet must be energized from a source of current such as the storage battery. A loud speaker

has been developed in England called the *Crystavox* for use with crystal sets. This consists essentially of an electromagnetically operated speaker connected with a microphonic relay. The relay is actuated by a storage battery. Its function is to magnify the incoming signals from the crystal set, passing them along with increased strength to the electromagnet of the loud speaker. Still another type of speaker which has been used to a limited extent abroad, dispenses entirely with the electromagnet as the actuating source of diaphragm vibration. In this type, electrostatic principles are involved. An agate cylindrical drum, over which a band of copper or similar metal is wound, is revolved at a uniform rate by a small motor or by clockwork. To one end of the band a diaphragm is fastened mechanically. The other end of the band is secured by a fairly stiff spring. Current from the receiving set is led to the cylinder by means of a brush contact and as the current fluctuates the attraction of the band to the cylinder fluctuates with it and the drag on the diaphragm due to the rotation is increased and decreased. The use of the motor constitutes the most serious disadvantage in this type of loud speaker.

Having discussed the various *types*

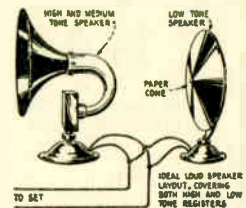

A high and a low pitched speaker connected in parallel for simultaneous operation.

of loud speakers, from the standpoint of principles of operation, the more important of these will now be considered from the constructional standpoint. The early forms of directly actuated metallic diaphragm, electromagnetic loud speakers consisted essentially of a watch-case telephone receiver, or a pair of receivers attached to a horn. The purpose of the horn was to concentrate and redistribute the sounds caused by the vibration of the diaphragm. One of the first im-

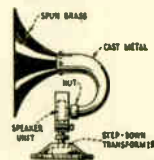

A loud speaker of the horn type having curved cast metal neck and spun brass bell.

provements was to modify the shape of the horn so as to make it conform more nearly with correct acoustical principles. Another improvement was to introduce an adjustment by means of which the air gap could be varied. In some cases this was accomplished by moving the magnet closer to the diaphragm and in others by moving the diaphragm itself. This adjustment provided a means of getting greater sensitivity on distant stations (by drawing diaphragm closer to the magnet) and of preventing sticking of diaphragm or rattling, on local stations. The ordinary metallic diaphragm has one frequency to which it will respond most strongly. This is called its *resonant frequency*. Special speakers



called *tuned receivers* have been designed in England which permit the resonant frequency to be varied. In one type, the variations of the magnetic field operate a vibrating reed attached to a non-magnetic diaphragm. The resonant frequency can be varied by adjusting the position of the vibrating reed with a set screw. Another method of getting rid of resonant points in diaphragms has been to use corrugated instead of flat diaphragms. In some of these diaphragms the center is left flat, the remainder of the diaphragm being corrugated with concentric circles either evenly spaced or spaced in section at radii bearing a ratio to each other corresponding to prime numbers. In some cases conical diaphragms with corrugated edges are used. The material as well as the shape of the horn have been found to materially affect the sound reproduction. Horns are constructed of metal, fibre, composition, hard rubber, wood, etc. In general the horn should be of a material which will not give out metallic sounds. The tone arm which carries the speaker unit at one end and the horn at the other is usually constructed of cast metal such as a lead alloy or aluminum. The requirement here is that it must be of an acoustically "dead" material. In some cases the speaker unit and sound chamber are concealed in an artistically designed cabinet thus forming a *cabinet speaker*. Loud speaker units are also made especially for use in conjunction with the sound chamber of a phonograph. These are referred to as *phonograph attachments*. They are ordinarily attached to the phonograph tone arm being put in place of the phonograph reproducer. Some phonographs are now made with provision for attachment of the speaker unit without removal of the reproducer. There is also an attachment on the market for use in connection with a phonograph which has provision for conveniently changing over from the reproducer to the speaker unit or vice versa. Cone speakers may be of the single cone variety or of the double cone style. In these speakers a metal rod extends from the magnet armature and is rigidly fastened to the cen-

ter of the cone. The most common type of cone speaker has a parchment diaphragm. This seems to give excellent reproduction especially for tones in the lower register. Its points of disadvantage are that it is affected to some extent by moisture and temperature change and furthermore seems to bring out static interference more clearly than some other types. Another type of cone speaker uses a teak wood diaphragm. Some of these speakers have a small fastening screw at the point of attachment between the rod and the diaphragm. This is provided so that tension can be removed from the diaphragm during shipment and also if the speaker is to remain in a room where change in temperature may take place. A cylindrical parchment speaker which utilizes the same principle as the cone speaker, has recently been placed on the market. Its chief point of difference is that the parchment is not under tension as in the case of the cone speaker. Large volume loud speakers are provided with power amplifiers which are often an integral part of the speaker itself. One of the most recent loud speakers is contained in a large cabinet and contains apparatus for utilizing ordinary lighting circuits for operating the set and speaker. The power amplifier unit is also contained within the speaker cabinet and the design of the speaker is such that it can handle any volume without distortion. The rectifier is arranged to supply not only the necessary voltages for the power amplifier but also plate voltage for practically any type of receiving set. (See *Horn, Loudspeaker, also Distortion.*)

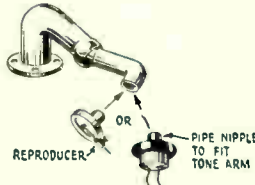

A loud speaker unit used as a phonograph attachment.  
**LOUDSPEAKER UNIT**—The sound reproducing unit attached to the tone

arm of the horn type speaker or to the diaphragm of the cone type speaker. Various types of units are described under the heading *Loudspeakers*.

**LOW FREQUENCY**—See *Low Frequency Current*.

**LOW FREQUENCY CURRENT**—An alternating current of less than 10,000 cycles. In radio work the alternating currents used are often classified as *low frequency currents* and *high frequency currents*. While there is no fixed value separating high and low frequencies, 10,000 cycles is generally taken as the dividing line. Thus audio frequency currents are considered as low frequencies and radio frequency currents are high frequencies. The term *low frequency current* as applied to power and lighting circuits refers to circuits having frequencies of 25, 60, etc., cycles per second. (See *Current, High Frequency*.)

**LOW FREQUENCY IRON CORE INDUCTANCE**—A variable inductance having an open-ended iron wire core. This inductance is used with spark transmitters to place the primary transformer circuit in resonance with the alternating current frequency.

**LOW LOSS COILS**—*Inductance coils* (q.v.) having low resistance and specially wound so as to reduce to a minimum condenser effect and hence dielectric losses. The term *low loss* has been used rather loosely but for practical purposes coil losses should be taken as referring to self-capacity, often called *distributed capacity* (q.v.) ohmic resistance, *skin effect* (q.v.) in the wire due to the effects of frequency and leakage and absorption in or through the insulating materials upon which the coil is built or with which the wire is covered. While it is impossible to obtain a coil having pure inductance only, it is feasible to design the coil so that the various losses will be reduced to a minimum. Often, it has been found that a design which will greatly reduce one type of loss will result in an increase of another. The illustrations show various types of low loss coils together with curves showing comparative efficiency tests. Figure 1 shows the results of an investigation regarding the distributed

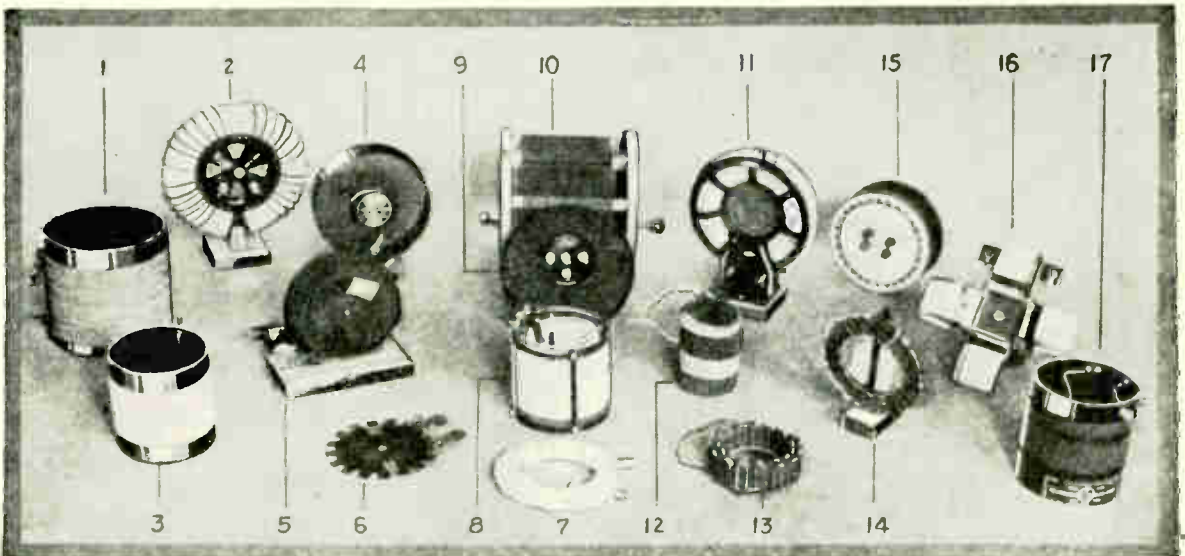

Various types of low loss coils including: 1. Bell wire coil; 2. Naxon; 3. Marco; 4. All-American; 5. Orbit; 6. Turney; 7. Sickles; 8. Aerocoil; 9. Erla; 10. Wavemeter coil; 11. Thorola; 12. Pathe; 13. Freshman; 14. Coast Coil; 15. Summitt; 16. Quadroformer; 17. Bruno.

**Low Tension**

capacity of various coils. This was obtained by making measurements of

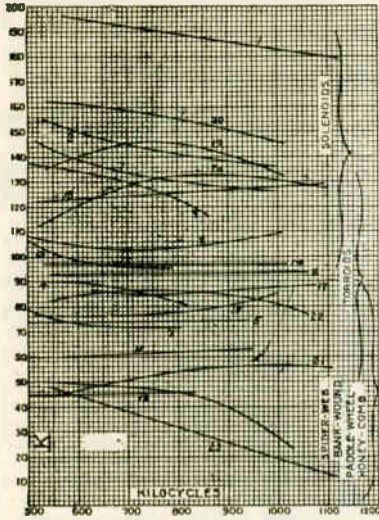

The efficiency of a coil is indicated by the height of its curves on this graph.

the inductance of the coils. If the self-capacity of the coil is very small,

amounts to anything, the curve showing the relation between inductance

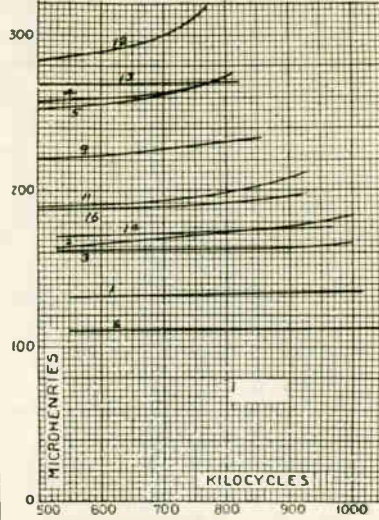

Fig. 1.—The curvature of the graphs indicate the presence of distributed capacity in the coils.

and frequency will bend upward as the frequency increases, and the

give any idea of what value the self-capacity may have, but simply show whether the inductance varies or not, which is one method of determining how harmful is the effect of the distributed capacity. The more sharply the curve bends upward the less desirable is the coil. In general, the smaller the size of the wire (for sizes smaller than about No. 16 B & S) the higher the resistance. The larger the wire and the thinner the insulation, the greater is the skin effect. The greatest inductance is obtained for a given amount of wire when the coil has a true cylindrical shape. The skin-effect in multi-layer coils is much greater than in single-layer coils. The effect of coil capacity and absorption or leakage in insulation is small compared with the skin-effect except in multi-layer coils, where the distributed capacity may become very great. To keep the physical size of toroidal coils within practical limits the diameter of the turns must be relatively small, so that many more turns are required to obtain a given inductance.

**LOW TENSION**—abbreviation L. T.—A comparatively low voltage. A circuit supplied by a low voltage battery such as the filament circuit of a vacuum tube is called a low tension circuit. In electrical engineering work, any circuit of 600 volts or under is considered to be a low tension circuit.

**LUGS**—Metal projections used for permanently connecting conductors with electrical apparatus. In one type of lug, the metal is bent over at one end to form a tube into which the conductor can be soldered, while the other

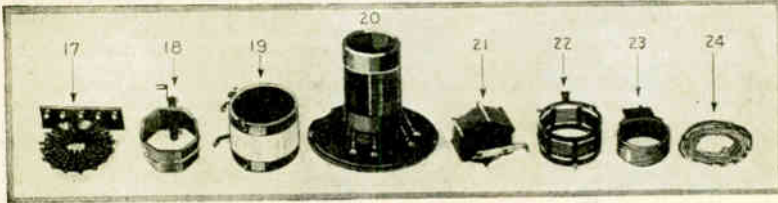

Additional examples of low loss coils: 17, Marwol; 18, Eastern Coil; 19, Workrite; 20, Walbert; 21, Andrews; 22, Bremer Tully; 23, Cotocoil; 24, Kresge Lorenz coil.

the self-inductance will not change perceptibly as the frequency changes. On the other hand, if the self-capacity

greater the capacity of the coil, the more sharply will the curve bend. The curves shown in Figure 1 do not



Typical lugs.

end is flat and has a hole drilled to receive any desired terminal.

**M**

**MAGNET**—A piece of iron or steel having the power to attract other pieces of iron and to attract or repel other magnets. Natural magnets are known as *Loadstones* (q.v.). (See *Electromagnet*, also *Permanent Magnet* and *Temporary Magnets*.)

**MAGNET WIRE**—Insulated wire for the construction of magnet coils. In radio extremely fine wire is used to wind the coils of the electromagnets used in headsets and loud speaker units. The most common insulation used in radio work for magnet wire is enamel. Other types of magnet wire utilize a single cotton covering, a double cotton covering or a silk covering. (See *Enamelled Wire*.)

**MAGNETIC ATTRACTION AND REPULSION**—The mechanical force tending to draw together two magnetic poles of unlike polarity, or to force apart two magnetic poles of like polarity.

**MAGNETIC BLOWOUT**—An electromagnet with its pole pieces placed so that the direction of the magnetic field will be at right angles to the movement of the ions in an electric arc. The coil of this magnet is energized in some cases in series with the

line and acts to expel or blow out the arc. In the series arrangement, the

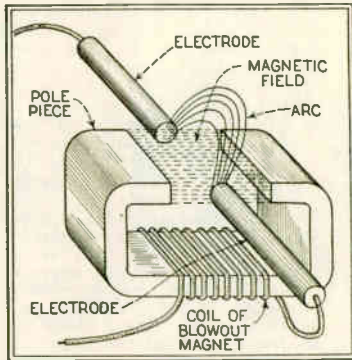

A magnetic blowout.

blow-out action is stronger, the larger the current to be interrupted. For small shunted arcs, permanent magnets are often used. The operating principle of the blowout coil depends upon the fact that in a magnetic field, an electric current tends to move across the lines of force or in other words to

cut them. In the illustration, the pole pieces are shown so placed that the general direction of the lines of force is at a right angle to the flow of the ions in the arc. The electromagnetic action causes the arc to move outside the field. This increases the length of the arc, thus rapidly breaking it. Magnetic arcs are used in connection with *keys* (q.v.) used for interrupting a large current, in certain types of *lightning arresters* (q.v.) and also in motor controllers..

**MAGNETIC CIRCUIT**—The path traversed by magnetic lines of force. A magnetic circuit may be entirely through iron, as in the case of a closed core transformer or partly through iron and partly through air as in the case of a motor or generator. (See *Line of Force*.)

**MAGNETIC COUPLING**—See *Coupling*.

**MAGNETIC COUPLING TRANSFORMERS**—See *Coupling Transformer*, also *Jigger*.

**MAGNETIC FIELD**—The whole space over which a magnet exerts influence. The space traversed by the magnetic flux. Wherever magnetism is present the space in the immediate vicinity is

called a magnetic field. (See *Electromagnetic Induction*.)

**MAGNETIC FLOW**—The passage of magnetic lines through a magnetic circuit. This term is sometimes used in the place of magnetic flux. (See *Flux Magnetism*.)

**MAGNETIC FLUX**—Symbol  $\phi$ —The total magnetism present at any cross-section perpendicular to the lines of force. Magnetic flux is analogous to current flow. That is to say, it is convenient to consider a flow of magnetism in the same way as electricity is considered to flow. The unit of magnetic flux in the c.g.s. (centimeter gram second system) electromagnetic system is the *maxwell* (q.v.) or simply the *line*. The unit of magnetic flux in the practical system is also the *maxwell*. (See *Line of Force, Alternator, also Flux, Magnetism*.)

**MAGNETIC FLUX DENSITY**—The number of lines of force per unit cross-sectional area of a magnetic path. The *gauss* (q.v.) is the unit of magnetic flux density. It is equal to one *line* (q.v.) per square centimeter.

**MAGNETIC FORCE**—The force with which a magnet attracts or repels any piece of iron or steel. The intensity of a magnetic field at any point as measured by the force which it would exert upon a unit magnetic pole if placed at that point.

**MAGNETIC FORCE DUE TO CURRENT**—A magnetizing force due to current flow which can be determined mathematically for any point in the surrounding medium. Consider any closed stream line of electric current surrounded by a medium having uni-

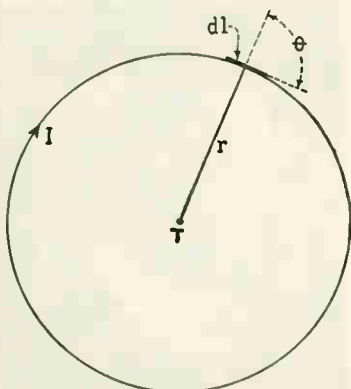

Diagram illustrating method of determining magnetic force due to current.

form magnetic properties. It can be demonstrated that each elementary length of the current stream line,  $dl$ , contributes to the magnetizing force  $H$ , at any point  $T$  an amount  $dH =$

$$\frac{(I \sin \theta) dl}{r^2}$$

where  $I$  is the current flowing along this stream line,  $r$  is the distance from  $T$  to  $dl$ , and  $\theta$  (theta) is the angle between  $r$  and  $dl$ . The direction of  $dH$  is perpendicular to the plane of  $r$  and  $dl$ . The total magnetizing force at  $T$  is the vector sum of  $dH$  for all the elementary lengths into which the current stream line is divided.

**MAGNETIC HYSTERESIS**—The opposition which minute particles of a magnetic material offer to being magnetized or to having their magnetization changed. It is sometimes referred to

as molecular friction or as *magnetic lag*. (See *Hysteresis*.)

**MAGNETIC INDUCTION**—See *Induction*, also *Diamagnetic Material*.

**MAGNETIC INDUCTIVE CAPACITY**—symbol  $\mu$  (mu)—Also termed Magnetic Inductivity—Names sometimes used instead of *Permeability* (q.v.). The ratio between the number of lines of force per unit area passing through a magnetizable substance and the magnetizing force which produces them. Stated another way, it is the ratio of flux density to magnetizing force. It can be considered as a measure of the ease with which magnetism passes through any substance. The magnetic inductive capacity of air is taken as unity. The term magnetic inductive capacity is analogous to *specific inductive capacity* (q.v.) which is the ratio of the dielectric constant of a material to that of a vacuum.

**MAGNETIC INTERRUPTER**—A device energized by an electromagnet for interrupting a circuit. (See *Interrupter*.)

**MAGNETIC KEY**—An electromagnetic adjunct to a wireless transmitting key for reducing or eliminating sparking due to the self-induction of the heavy

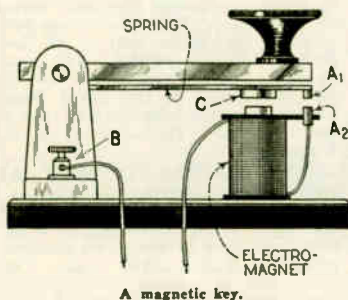

A magnetic key.

currents which are interrupted. A form of magnetic key is shown in the illustration. Underneath the lever arm of the key is placed a spring to which an iron armature  $C$  and a platinum contact  $A_1$  are attached. If the key and hence the spring are pressed down contact  $A_1$  touches contact  $A_2$  and the path of the current is completed. The current passes not only through the key, but also through the winding of the electromagnet. If the key is released so as to move upward, the contact  $A_1$  still remains touching  $A_2$ , as the magnetic action due to the current continues to hold down the armature  $C$  and hence the spring with the contact  $A_1$ . Not until the alternating current reaches a zero value is the armature released. This releases  $A_1$  from  $A_2$ , at an instant of zero current and hence there is no spark.

**MAGNETIC LEAKAGE**—Magnetic flux which serves no useful purpose. There are no substances which will prevent the passage of magnetic flux. This fact introduces a certain amount of difficulty into practical magnetic circuit calculations, since it is impossible to confine all the flux into a predetermined magnetic path. Since there is no magnetic insulator there will always be a certain amount of *leakage flux*. However this can be reduced to a minimum by proper design of the magnetic circuit. Magnetic Leakage is also referred to as *Stray Flux*.

**MAGNETIC LINES OF FORCE**—See *Line of Force*, also *Electromagnet*.

**MAGNETIC MOMENT**—The product of the strength of pole of a magnet and its virtual length. The torque ex-

erted by a magnetic field upon a magnet depends upon the magnetic moment.

**MAGNETIC NEEDLE**—A light, thin steel magnet mounted on a pivot or suspended so as to be free to move. It takes a position pointing to the magnetic north.

**MAGNETIC POLES**—Points on a magnet where the lines of force leaving or entering the iron are concentrated. In a magnetic needle, that end which tends to point north is called a north or positive pole; that end which tends to point south is called a south or negative pole. A unit magnetic pole is defined as one which, when placed at a distance of one centimeter from a like pole of equal strength, will repel it with the force of one dyne. The north magnetic pole of the earth is situated in latitude 70 North and longitude 97 West. The south pole is located at latitude 70 South and longitude 102 East. It should be noted that the magnetic poles do not coincide with the geographical poles. (See *Induction, Magnetic*.)

**MAGNETIC PROPERTIES**—Materials are classified according to whether or not they offer a good path for the magnetic lines of force. Substances of comparatively low *reluctance* (q.v.) are termed *magnetic*. They are also often referred to as *ferro-magnetic*. They include iron, steel, nickel, cobalt, manganese, chromium, magnetite, certain alloys of copper, manganese and aluminum (called Heusler Alloys), and certain other oxides. The magnetic laws governing these substances can best be set forth by means of magnetization curves. Substances having high reluctance are termed *non-magnetic*. For commercial purposes, air is the most important non-magnetic substance. However, practically all substances, with the exception of the ferro-magnetic ones, follow the same magnetic laws as air. While the reluctance of a non-magnetic substance is constant, the reluctance of magnetic substances varies, as the amount of *flux* (q.v.) in the substance changes. Although air and all other substances, with the exception of the ferro-magnetic ones are classed as non-magnetic substances, and are poor conductors of magnetic flux, when compared to iron, etc., nevertheless they are by no means magnetic insulators. There are no substances which will absolutely prevent the passage of magnetic flux. (See *Ferro-Magnetic Substances*.)

**MAGNETIC PYRITES**—See *Pyrites*.

**MAGNETIC STORM**—Sudden and irregular variations of the earth's magnetic field. Magnetic storms are sometimes coincident with the appearance of sun spots. These storms often disrupt telegraph service and also cause much interference with radio communication.

**MAGNETISM**—A phenomena exhibited by certain materials which is characterized by the attraction or repulsion of soft iron or of conductors carrying electricity. Magnetism is one of the manifestations of electricity, since a current flow is always associated or linked with a *magnetic field* (q.v.). (See *Free Magnetism, Magnet, also Magnetic Properties*.)

**MAGNETISM, LAWS OF**—Like magnetic poles repel one another; unlike magnetic poles attract one another. The force exerted between two magnetic poles is proportional to the product of their strengths and is inversely proportional to the square of the distance between them. (See *Like Poles*.)

## Magnetite

**MAGNETITE**—symbol  $Fe_2O_3$ .—A mineral composed mainly of magnetic oxide of iron. When found in magnetized condition it is known as a *loadstone* (q.v.) or a natural magnet. It is a black brittle substance having a specific gravity of 5.2.

**MAGNETIZATION**—(also spelled *Magnetisation*)—The process of communicating magnetism. The act of rendering iron, steel, etc., magnetic. According to Ewing's theory, a substance which is magnetized has its molecules rearranged so that they assume symmetrical positions, each molecule lying in line with or parallel with its neighbor. In this rearranged position each molecule adds its separate magnetic force to every other one and the cumulative effect of this is that the substance exhibits the property of a magnet. (See *Demagnetization*.)

**MAGNETO GENERATOR**—A small generator consisting essentially of an armature rotating between permanent magnets, usually of the horse-shoe type. Magnets are mainly used for motor ignition, medical coils, bell ringing and for firing high explosives. (See *Intermittent Current*.)

**MAGNETOMOTIVE FORCE OR DIFFERENCE OF MAGNETIC POTENTIAL**—abbreviation m.m.f.—The force causing magnetic flow. *Magnetomotive force* is the magnetic cause, while *flux* (q.v.) is the magnetic effect, just as in electrical terms, *electromotive force* (q.v.) is the cause and current is the effect. The c.g.s. (centimeter gram second) unit of magnetomotive force is the gilbert (q.v.). The unit ordinarily employed in practical calculations of the magnetic circuit is the *ampere-turn* (q.v.). (One ampere-turn is equal to 1.2566 gilberts.) An ampere-turn consists of a current of one ampere flowing through one complete turn of a conductor. The expression "turn" means that the conductor is wound in a solenoid. That is to say, it is wrapped around a core which may consist of air or of any other substance. The same magnetic field will result from ten ampere-turns consisting of ten amperes flowing through one turn, as from ten ampere-turns consisting of one ampere flowing through ten turns. (See *Force, Magnetomotive*.)

**MAGNIFIER, OR RELAY**—An apparatus for intensifying the variations of a current. The term *magnifier* has been incorrectly used for *amplifier* (q.v.). One type of *magnifier* used in radio is the microphonic relay (see loud speaker) by means of which the minute currents in a crystal set can be magnified so as to actuate a loud speaker. In the ordinary telephone repeater, a microphone is acted upon by the receiver of the first line circuit so as to introduce a local circuit which acts inductively on the second line wire. Relays are also used in wire telegraphy to boost weak line currents by means of strong local batteries. (See *Relay*.)

**MANTISSA**—The decimal part of a *logarithm* as differentiated from the integral part or characteristic. For example in the logarithm 1.23578, 1 is the characteristic and the decimal .23578 is the mantissa. (See *Logarithms*.)

**MARBLE**—The name given to any limestone sufficiently compact to permit being polished. Pure marble is white, the presence of oxides giving the different colors. Marble is used extensively for switchboard work and when

so used must be free from metallic veins. Where circuits carrying 1000 volts or more are used, the switchboard should be saturated with an insulating varnish and baked. Inasmuch as the marble shows oil spots, it is sometimes stained black and given a finish called a *marine finish*.

**MARCHANT, EDGAR WALFORD**. British radio expert. Born in 1876, he was educated at University School, Hastings, and Central Technical College and London University. In 1897 he was appointed superintendent of the laboratory and workshops of Lord Blythwood at Renfrew, where he carried out many experiments in wireless telegraphy. He became chief assistant at Finsbury Technical College, 1900, under Professor Silvanus P. Thompson, and the following year was appointed lecturer in electro-technic at University College, Liverpool. In 1903 he was appointed the first professor of electrical engineering at the university.

Marchant was for some time closely associated with W. Duddell in developing the oscillograph, and the two read a joint paper on the study of the electric arc by the aid of oscillographs to the Institution of Electrical Engineers, of which institution Marchant became vice-president. He is also vice-president of the Radio Society of Great Britain. He has written many papers on radio, and contributed an article to the proceedings of the Royal Society on the magnetic behaviour of iron under oscillatory discharge of a condenser.

**MARCONI FILINGS COHERER**—Also called *Marconi Coherer*—A detector of electric waves consisting of fine nickel and silver filings contained in a suitable glass tube between two electrodes consisting of two silver plugs. These two plugs are connected to platinum wires brought out through the sealed ends of the tube, which is carefully exhausted of its air. The metallic filings in a loose condition have feeble conductivity for the current from a single dry cell. If a very weak electric oscillation is passed through the coherer, the filings cling together or cohere and hence conduct electricity better and they will then pass sufficient current from a single dry cell to operate a telegraphic relay. To bring

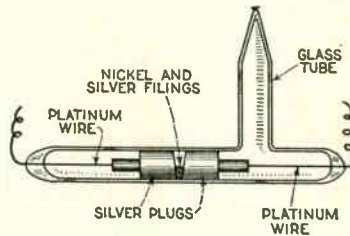

The Marconi filings coherer.

these filings back to a non-conductive condition, the tube is tapped by an electromagnetic tapper, similar to an electric bell with the gong removed. The Marconi coherer is now obsolete. (See *Coherer*.)

**MARCONI, GUGLIELMO**—Italian-Irish radio pioneer. Guglielmo Marconi was born at Bologna, Italy, April 25, 1874, and was educated at the Leghorn Technical School, under Professor Rosa. From his earliest years he was keenly interested in communication by means of Hertzian waves, and began his brilliantly successful series of experiments in June, 1895. These first experiments

were carried out on his father's estate near Bologna. Marconi soon found that the Hertzian form of resonator gave only feeble signals at a distance, and he substituted a vertical wire, with the result that in 1895 he was able to transmit signals to a distance of one and a half miles. About the same time he improved the Branly coherer, which he was using as a detector, and invented an electric tapping device to decohere the filings.

This early apparatus of Marconi, from which has sprung the far-flung wireless chain of to-day, consisted of a coherer, a relay, a decoherer, and a Morse printing instrument, all working from storage batteries. Between the coherer and the relay Marconi interposed choke coils, and this had a very marked effect on the receptivity of his set. By close attention to the details of his system he was able to carry on his signals at greater ranges than had up to this time been accomplished by other experimenters.

The transmitting apparatus used by Marconi in these early efforts consisted of a large spark gap to which the aerial and earth wires were connected. The high-tension current for the spark was provided through an induction coil from batteries. The spark gap consisted of a ball discharger comprising four brass balls. The two middle balls were separated by a small space filled with vaseline oil, the actual spark jumping from the two end balls to the middle ones and through the vaseline, producing a high-frequency spark.

Marconi came to England in 1896, where he took out the first patent ever granted for a practical system of wire-



Guglielmo Marconi.

less telegraphy. He made a number of experiments at Westbourne Park, and demonstrated his system before Sir William Preece and other high officials at the Post Office. In the following year he increased the range of his set to nine miles using a 29 in. spark coil and kites to raise the vertical aeriels. In July, 1897, in demonstrating before the Italian Government, he covered 12 miles between warships, and he began to install a number of his sets for lighthouses, and the success of his experiments led to stations being erected for the corporation of Trinity House.

In 1899, the first proof of the advantages of wireless over other forms of communications came with the saving of the lives on board the ship R. F. Matthews, which ran into the East

Goodwin lightship. The latter was equipped with one of Marconi's transmitting sets and was able to communicate with the South Foreland light-house and summon assistance.

The genius of Marconi lies not so much in his inventions, as in his far-sightedness in being the first man to realize the immense commercial possibilities of radio, and to make the best use of all the scientific effort of his time to further the object he had in view.

Marconi has received innumerable honors from all countries. He holds the honorary degrees of universities all over the world, and the freedom of a large number of cities. In 1909 with Professor Braun, he was awarded the Nobel Prize for Physics, and in 1914 he was given the Honorary Knighthood of the Grand Cross of the Victorian Order. He has been awarded the Albert Medal of the Royal Society of Arts, the Gold Medal of the Institute of Radio Engineers of New York, the John Fritz Gold Medal for the invention of wireless telegraphy, and the Franklin Gold Medal of the Franklin Institute. He was the Italian delegate to the Peace Conference, and signed on behalf of Italy. He is chairman of the board of directors of the Marconi Company.

#### MARINE TYPE CHARGING PANEL—

A switchboard equipped with resistance coils, carbon filament pilot lights, voltmeter and necessary switches. Manipulation of the switches allows the battery to be placed on charge or on the line. By throwing a switch on this board, it is also possible to work the wireless transmitter either from the ship's generator or from the storage battery.

**MASS**—The quantity of matter which a body contains. Physical quantities such as force, velocity, etc., are expressed in terms of length, mass, and time. The unit of length is the centimeter; of mass, the gram; and of time, the second. Hence this system of measurement is known as the C.G.S. (centimeter gram second) system. The gram is equal to 15.432 grains and represents the mass or quantity of a cubic centimeter of water at 4 degrees centigrade.

**MASTER-OSCILLATOR SYSTEM**—A radio telephone transmitting circuit in which a small extra *audion* (q.v.) is used to supply the power to excite the grid circuit. This extra oscillator or exciter is referred to as the master-oscillator. The master-oscillator system has several advantages over the self-excited system. Changes in antenna constants, such as might be caused by a swaying aerial or *lead-in* (q.v.) do not affect the transmission where the former system is used. In addition the master-oscillator system is more convenient to work with and the adjustment for maximum output for different wave lengths and antenna resistances is more easily made.

**MASTER-OSCILLATOR SYSTEM AMPLIFIER**—In the master-oscillator system, the power tube acts as an amplifier of the power supplied by the small extra exciting, or master-oscillator. The exciter must develop sufficient power to supply the losses in its own oscillating circuit and those of the grid circuit of the power tube.

**MASTS, ERECTION OF**—High powered stations generally use latticed steel masts. In some cases tubular metal masts in telescoping sections are used. Wooden masts have been used to quite an extent. For portable out-

fits, these are made in sections which can be fitted together like a fishing rod. Guy ropes or wires are necessary in practically every instance. In erect-

a circuit is acted upon by a force urging it in such a direction as to make it enclose the greatest possible number of lines of force.

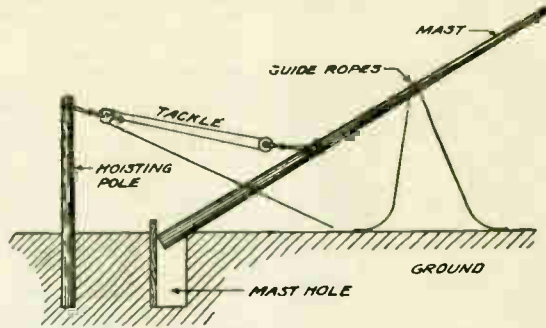

A method of erecting a tall mast using tackle and hoisting pole.

ing a mast, it is usual not to make the installation too rigid, but rather to allow some freedom of movement so that the mast may sway slightly in the wind. Where a one-wire aerial is being erected this may be fastened to any support available. In marine construction, the ship's masts are used to support the aerial, the wires being stretched between the two booms or spreaders from which halyards run to the masts. (See *Aerial*.)

**MATCHED IMPEDANCES**—Circuits balanced or matched so that the total impedance of one circuit will equal the impedance of another circuit with which it is coupled. (See *Impedances, Matched*.)

**MAXWELL**—symbol  $\phi$ —The unit of magnetic flux (q.v.). It is also known as the *line* (q.v.). One maxwell is equal to one line of force. (See *Flux Density*, also *Kiloline*.)

**MAXWELL'S CORKSCREW RULE**—If the direction of travel of a right-handed corkscrew represents the di-

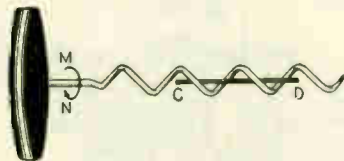

Illustration of Maxwell's corkscrew rule. When current flows from C to D, magnetic lines encircle the wire in the direction of the curved arrow MN.

rection of current in a straight conductor, the direction of rotation of the corkscrew will represent the direction of the magnetic lines of force.

**MAXWELL'S LAWS**—The magnetic fields surrounding parallel currents in the same direction will react upon each other in such a way that the conductors will tend to move together. In the case of parallel currents in opposite directions, the fields between the two conductors will be in the same direction and will merge together, thus tending to push the conductors apart. The magnetic fields around two conductors at an angle will react upon each other in such a way as to tend to bring the conductors parallel, and with the currents flowing in the same direction.

**MAXWELL'S LAW OF MOTOR ACTION**—A conductor carrying a current whose direction of flow is at right angles to a magnetic field, will tend to move out of this field.

**MAXWELL'S RULE**—Every portion of

**MAXWELL TURNS**—The deflection value in a ballistic galvanometer or *fluxmeter* (q.v.). This depends upon the number of turns in the exploring coil and the instantaneous value of the flux in maxwells linked with this coil. (See *Grassot Fluxmeter*.)

**McLACHLAN, NORMAN W.**—British radio authority. Born at Longtown, Cumberland in 1888, and educated at Carlisle Grammar School and the George Watson and the Heriot Watt Colleges, Edinburgh, and Liverpool University. He was appointed lecturer in Engineering and Mathematics at Newcastle-on-Tyne in 1909. In 1913 McLachlan was appointed supervisor of classes in engineering subjects in the Liverpool Technical Institutes, and after the Great War, during which he was engaged in aeronautical research and the study of anti-submarine devices, he made a special study of magnets at the National Physical Laboratory, Teddington. Appointed research engineer to the Marconi Company, he is the author of many papers on wireless and electrical subjects in the journal of the Institution of Electrical Engineers and other scientific journals, including those on Characteristic Curves of a Poulsen Arc, the Magnetic Behaviour of Iron at very High Frequencies; and Theory of Iron-cored High Frequency Transformers. He has taken out a number of radio patents.

**MEASUREMENT OF INDUCTANCE**—Some methods of measuring inductance (also applicable to the measurement of *capacity*) are various bridge methods; by measuring the voltage, current, power, and frequency; and by the wave meter method. Connections in one bridge method for measuring inductance are similar to those in the ordinary *Wheatstone Bridge* (q.v.). A coil having a known inductance is balanced against the inductance to be measured. A device called a *Secohmmeter* is in use to increase the sensibility of bridge measurement of inductance. The *Secohmmeter* serves the purpose of making an alternating current to use in measurements of self-induction and of commutating such portion of this current as flows in the galvanometer circuit to a direct current. When a source of alternating current of known frequency is available the following method is convenient. Place the inductance across the alternating current mains, measure the power absorbed, the current flowing, the voltage across the unknown inductance and the frequency of the circuit. Then the inductance  $L$  is equal to the reactance,  $x$ , divided by

## Measurement of Wave Length

$2\pi$  times the frequency. Expressed as a formula

$$L = \frac{x}{2\pi f} = \sqrt{\frac{(E)^2}{(I)^2} - \left(\frac{\text{Power}}{I}\right)^2}$$

The inductance  $L$  should be expressed in henries. This method gives results of fair accuracy but is not adapted to measurements of low values of inductance. Small inductances are more usually measured by bridge methods. In the wave meter method, a condenser is discharged through a spark gap in a circuit containing a known capacity and by means of a wave meter measuring the wave length. The expression for the number of oscillations in a closed circuit containing both inductance and capacity is given by the formula

$$n = \frac{1}{2\pi\sqrt{LC}}$$

and the wave length is equal to the velocity of propagation divided by the number of waves and calling  $\lambda$  the wave length we have

$$\lambda = V \text{ times } 2\pi\sqrt{LC}$$

In this last equation everything is known but the inductance which can be calculated. (See *Inductance, Measurement of.*)

### MEASUREMENT OF WAVE LENGTH

The usual method of measuring an unknown wave length is by means of a wavemeter. Other apparatus required in this connection is a hot wire ammeter indicator in a coupled circuit, or crystal detector and telephones. Also an antenna excited oscillating circuit supplied by electron tube. A wavemeter placed in inductive coupling with a coil or antenna carrying radio current will show decided increase of current in its own coil and condenser when it is tuned to resonance with the source. The wave length is read directly from the wavemeter setting for resonance or from a calibration curve. A receiving set can be used to measure the wave lengths of received waves if it is first standardized in terms of wave lengths. The operator listens in through the head set attached to the receiving set. As the wavemeter condenser knob is turned the loudest sound is heard when the wavemeter circuit is tuned to the same wave length as that for which the receiving set is adjusted. The wave length is then read from the wavemeter scale or calibration curve. Continuing in this manner, the receiving circuit can be calibrated as a wavemeter by setting it at many different adjustments and reading the wave lengths at resonance each time. The wave length of the waves emitted by an antenna, when no added inductance or capacity is inserted in the antenna circuit, is known as its fundamental wave length. For a single vertical wire grounded antenna the fundamental wave length is slightly greater than four times the length of the wire. The approximate constant often used is 4.2 and this applies also to "L" or "T" type aeriels with vertical lead in wire, the total length being measured from the transmitting apparatus up the lead-in wire and over to the end of the flat top. It is of course, more accurate to measure the wave length radiated from an antenna directly by use of a wavemeter. The wavemeter coil needs merely to be brought near the antenna or lead-in wire and the condenser of the wavemeter adjusted to give maximum current in the wave-

meter indicator. The wave length corresponding to the wavemeter setting is then the length of the waves radiated by the antenna. The fundamental wave length of the antenna may be determined by gradually decreasing the number of turns in the *loading inductance* (q.v.), measuring the wave length for each setting of the loading coil and plotting a curve showing the wave length corresponding to the various numbers of turns of the loading coil. The fundamental, then, is the wave length corresponding to zero turns and is found at the point where the extension of the curve cuts the wave length axis. (See *Measurement of Inductance, also Formula.*)

**MECHANICAL MIXTURE**—A mixture of two or more elements which leaves them essentially the same. This is sometimes incorrectly called a mechanical compound. Sugar and sand mixed together give an example of a mechanical mixture. A *chemical compound* is formed when two or more substances combine chemically to form another substance having different characteristics. Thus iron filings and sulphur can be combined to form a third substance unlike either of the original two.

**MEG OR MEGA**—symbol M—The prefix placed before the name of a unit to denote one million times ( $10^6$ ) that unit, as for example *megohm* (q.v.) *mega-volt*, *megery*, etc.

**MEGGER**—An instrument for measuring insulation resistance or in general any resistance by the direct deflection of a pointer on a scale. The "Ever-shed" type is made in two forms (1) the *megger* insulation testing set and (2) the *bridge-megger* testing set which combines the functions of type (1) with those of a *Wheatstone Bridge* (q.v.). Both types consist of an ohmmeter of the moving coil type combined in one box with a hand driven generator for providing the necessary

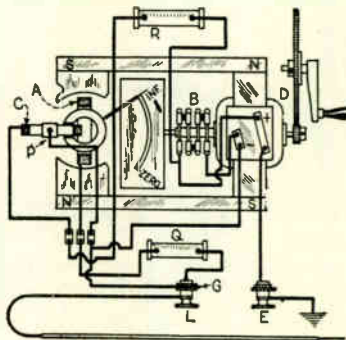

A diagrammatic illustration of a megger.

testing voltage and current. When the handle of the generator is not being turned, the pointer is entirely free and will rest anywhere on the scale. The general principles underlying the construction and operation of the megger are shown in the illustration. As can be seen, the megger is a combination of a *magneto generator* (q.v.) shown at the right, with an ohmmeter shown at the left, in a magnetic circuit common to both and consisting of two pairs of field poles braced by strong bar magnets, NS, NS, and forming two bi-polar field magnets in series. In the right hand one, and rotated by a folding handle and spur gearing D, is the armature of the generator, with its brush gear

B, and terminal bars marked + and -. In the left hand field is the current coil A, pressure coil P, and compensating coil C of the ohmmeter, connected to resistances Q and R, a *guard plate* G, and the only two external terminals L and E (marked Line and Earth on the actual instrument). The bridge-megger testing set is available for use both as an insulation testing set and as a specialized Wheatstone Bridge. It differs from the ordinary megger in outward appearance only by the addition of two pairs of terminals and of two switches, one of which is the *ratio* switch of the Wheatstone Bridge and the other one is a two-way change-over-switch. This latter when set to "Megger" prepares the instrument for measuring insulation resistance or high metallic resistance by coupling the two windings of the constant voltage generator in series and making the two front terminals, marked Line and Earth, the only two available for connection. When the change-over switch is set to "Bridge" the instrument is ready for Wheatstone Bridge work, the two windings of the generator now being connected in parallel in order to increase the current obtainable from it. In this case the ohmmeter part is changed into a galvanometer for the bridge and the arms of the bridge are switched into their appropriate places in the circuit and connected to the terminals marked R and X at the end.

**MEGOHM**—One million ohms. This unit is usually employed in the measurement of insulation resistance. It is also used in measuring *grid leaks* (q.v.), etc. See *Ohm*, also *Begohm*.

**MEGOHMITE**, also spelled *Megohmit*—An insulating material similar to micanite, obtainable in several forms, one of which is known as *hard megohmite* and is made of thin sheets of mica built up of shellac. *Flexible megohmite* consists of sheets of mica stuck together by vegetable adhesives. Flexible megohmite covered with Japanese paper is called *mica paper* while flexible megohmite covered with linen, is called *mica linen*.

**MEISSNER, ALEXANDER**.—Austrian radio expert. Born at Vienna, 1883, he was educated at the Technical High School and University of Vienna. He joined the Telefunken Company in Berlin, 1907, and is one of the leading authorities in Germany on radio. To him is due a large number of wireless inventions, including the Telefunken compass, musical quenched sparks, interference preventers, the direct current cathode valve relay for the reception of Morse Code, etc. In 1913 he invented the generation of oscillations by means of the three-electrode valve. He holds many patents, including spark gap for impulse excitation, quenched-spark signalling in conjunction with G. Von Arco, etc., and he is the author of many papers for scientific journals and societies on the subject.

**MERCURY ARC RECTIFIER (MERCURY VAPOR CONVERTER)**—A device for changing alternating current to direct current, which depends for its action upon the unidirectional conductivity of the mercury arc in an exhausted vessel. An idea of the principle of operation of the mercury arc rectifier may be obtained from the illustration. Assume an instant when the terminal H of the supply transformer is positive, the anode A is then positive and the arc is free to flow between A and B, B being the mercury cathode. Following the direction of

the arrows still further, the current passes through the lead J, through the reactance coil E and back to the negative terminal G on the transformer. A little later when the impressed electromotive force falls below a value sufficient to maintain the arc against the counter electromotive force of the arc and the lead, the reactance E which heretofore has been charging, now discharges, the discharge current being in the same direction as formerly. This serves to maintain the arc in the rectifier until the electromotive force of the supply has passed through zero, reverses and builds up to such a value as to cause A' to have a sufficiently positive value to start

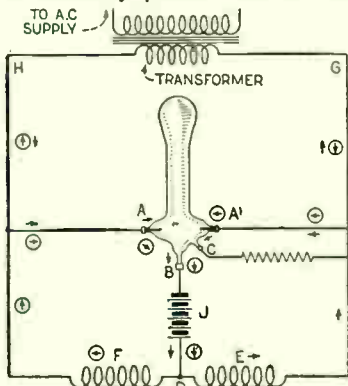
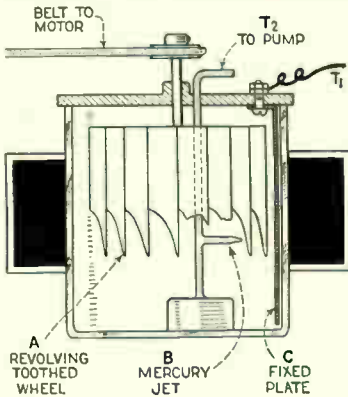

Illustration showing action of mercury arc rectifier.

an arc between it and the mercury cathode B. The discharge circuit of the reactance coil E is now through the arc A'B, instead of through its former circuit. Consequently the arc A'B is now supplied with current, partly from the transformer and partly from the reactance coil E. The new circuit from the transformer is indicated by the arrows enclosed in circles. The amount of reactance inserted in the circuit reduces the pulsations of the direct current sufficiently for all ordinary commercial purposes. The mercury rectifier is used in small sizes for charging storage batteries from alternating current circuits and in the larger sizes for operating direct current arc lamps from alternating circuits and also in electric traction work in the place of rotary converters in the substations or even on the train itself.

**MERCURY INTERRUPTER (MERCURY JET INTERRUPTER)**—A contact breaker in which contact is made between moving metallic contacts and a jet of mercury provided by a small centrifugal pump driven by the same motor as the contacts. When the primary winding of an induction coil is supplied with a continuous current it is necessary to interrupt the current in order that a secondary voltage shall be induced in the secondary winding. The mercury interrupter offers a satisfactory method of accomplishing this. In one type of mercury interrupter a stream of mercury is forced from a jet against a metal plate. The stream of mercury is interrupted by a toothed wheel of insulating material so that the electrical circuit is periodically made and broken between the mercury and the metal plate. In some forms of mercury interrupters, the jet itself revolves, the mercury impinging against a fixed metal plate. The mercury interrupter is used in operating X-ray bulbs from an induction coil where

the source is direct current. A form of mercury interrupter is shown in the illustration. A is a tooth-shaped wheel made of insulating material. This wheel is driven by a small motor and the number of revolutions can be



A type of mercury interrupter.

varied within wide limits. A small centrifugal pump forces the mercury upon the jet B, while the revolving wheel A interrupts the contact of the mercury with the plate C. The wheel A can be raised or lowered, thereby enabling the duration of contact of the mercury with the plate to be varied without altering the number of interruptions in a given time.

**MESH GROUPING**—A method of connecting coils in a polyphase circuit whereby they form a closed circuit and have the line wires attached to the points of junction between the coils. The term mesh is used interchangeably with delta. (See *Delta Connection*.)

**METER**—An instrument used to make measurements. (See *ammeter* or *ampere-meter*, *double range meters*, *integrating wattmeter*, *voltmeter*, *wavemeter*, *wattmeter*.)

**METER (Measure)**—A unit of length in the metric system (q.v.). One meter is equal to 100 centimeters or 39.37 inches. It is equal to the length of a standard platinum bar, kept in Paris, and representing approximately a ten-millionth part of a quadrant of the earth's meridian measured from the equator to the pole through Paris. Wireless waves are measured in meters. The length of a wave is the distance, usually measured in meters between two points in the successive waves where the disturbance is at a maximum or at a minimum or between any two points of equal disturbance. There is a fixed relationship between the length of a single wave, the frequency of oscillation and the velocity of the wave. Thus if 3,000,000 waves pass a given point in one second, each wave must be 100 meters long, since the velocity of radio waves is equal to 300,000,000 meters per second.

**METER-AMPERES**—The product of the antenna current in amperes at the point of maximum current and the antenna effective height in meters, for any radio transmitting station. It constitutes a factor for indicating the radiating strength of radio transmitting stations.

**METRIC SYSTEM**—A system of measurement in which the meter is the fundamental unit of length and in which all the units both fundamental and derived are divided decimally and higher units are formed in multiples of ten. (See *Centimeter Gram Second*.)

**MFD**—Abbreviation for *Microfarad* (q.v.)

**MICA**—An anhydrous silicate of aluminum and potash or sodium. Mica has very high insulating qualities and can withstand high temperatures. Mica obtained in the natural state is separated into laminations which are sorted and graded. These are then cemented together to form plate or flexible mica of any desired thickness or purity. Mica is used in radio work as the dielectric of small fixed condensers. It is also used as the sound producing diaphragm in certain types of head sets and loud speakers (q.v.).

**MICABOND CLOTH**—India sheet mica faced on one side with muslin and on the other side with Japanese insulating paper bonded together with a special binder. It is used for insulating field coils and transformer coils.

**MICABOND PAPER**—India sheet mica faced on one side with Japanese insulating paper of one grade and on the other side with paper of a different grade.

**MICABOND PLATE**—Mica sheets bonded together with orange shellac. Various grades of plate are made some of which are used for magnet spools, others for insulating of commutator segments, while still others are used in electric irons.

**MICANITE**—A form of reconstructed mica. Canadian amber mica and white India mica are used.

**MICRO**—A prefix placed before the name of a unit to denote one-millionth part of that unit, as for example *microfarad* (q.v.).

**MICRO-AMPERE**—One-millionth of an ampere. A unit used in measuring extremely small currents. (See *Ampere*.)

**MICROFARAD**—abbreviation Mfd.—A unit of electrical capacity equal to one-millionth of a farad. Since the farad is too large for most practical measurements, the microfarad is generally used. (See *Farad*, also *Jar*.)

**MICROHM**—A unit of resistance equal to one-millionth of an ohm (q.v.).

**MICROMETER**—An instrument for making minute measurements. Usually controlled by an accurate screw of fine pitch.

**MICROMETER SPARK GAP**—A minute adjustable spark gap of about four-hundredths of an inch placed in the aerial circuit of a multiple tuner to allow heavy charges to pass readily to earth by sparking across its points.



Courtesy of Western Electric Co. An example of the microphone used in modern broadcasting.

**MICROPHONE**—A sound magnifier. The ordinary form of microphone con-

sists essentially of a diaphragm set in vibration by the sound waves and causing by its motion variation in the resistance of a mass of loosely packed carbon granules. This variation in resistance causes corresponding variations in the current through the instrument so that at every instant the form of the current corresponds to the variations in sound. This type of microphone is often referred to as a *Carbon Microphone*. The telephone transmitter is a form of microphone, and the microphone (nicknamed *Mike*) used in radio broadcasting is merely a larger and more sensitive variation of the same instrument. (See *Electromagnetic Microphone*.)

**MICROPHONE, CARBON**—See *Microphone*, also *Granular Carbon*.

**MICROPHONE TRANSMITTER**—See *Microphone*.

**MICROPHONIC JOINT**—A loose contact between two solid conductors, so inelastic that feeble vibrations vary its resistance.

**MICROPHONIC RELAY**—An instrument for magnifying the variations of a given current by passing it through an electromagnet that acts on the diaphragm or reed of a microphone. The resistance variations are repeated in the current produced by a constant voltage in a circuit in series with the *microphone* (q.v.). In general a microphonic relay can be described as a microphone combined with a telephone so that a message transmitted over the telephone is repeated by the microphone over another line.

**MIL**—A unit of length equal to one-thousandth part of an inch.

**MIL-FOOT**—A wire one foot long having a diameter of one mil. Unit resistance may be measured in *ohms* (q.v.) per mil-foot. This refers to a conductor having a cross-sectional area of a *circular mil* (q.v.) and a length of one foot.

**MILLI**—The prefix placed before the name of a unit to indicate one-thousandth part of that unit, as for example *milli-ampere* (q.v.).

**MILLI-AMPERE**—One-thousandth of an *ampere* (q.v.). Sometimes abbreviated to *milli-amp*.

**MILLI-MICRO**—A prefix denoting one thousand millions. ( $10^{-9}$ ). The term *Billi* is an alternate prefix.

**MILLI-VOLT**—One-thousandth of a volt.

**MILS, CIRCULAR**—See *Circular Mils*.

**MIRROR GALVANOMETER**—A galvanometer for measuring very small currents which utilizes a reflected beam of light for a pointer. In one type of mirror galvanometer a fixed nearly circular magnet is used and a coil of wire is suspended in its field. When the current flows through the coil it tends to turn the coil so as to set its axis in the direction of the magnetic force. This movement can be observed by means of a beam of light reflected from a mirror fixed to the coil. (See *Galvanometer*.)

**MINERALLAC**—An insulating compound made in several different grades all of which are impervious to water and show no alkali or acid reactions.

**M.M.F.**—Abbreviation for *Magnetomotive force* (q.v.).

**MODULATED CURRENTS**—Currents which have their amplitude periodically varied as in the case of the carrier current used in radio telephony which is varied or modulated in accordance with the vibrations of a microphone. If a sound wave actuates a microphone, its inward and outward displacement, varying the resistance in the aerial circuit, results in a high

frequency current in the aerial of variable amplitude, called a modulated high frequency current. The illustration shows an extremely simplified diagram of the apparatus in a broadcasting station. The initial impulse that starts a radio signal towards the receiving set is furnished by the voice of the speaker or singer or by some other sound originating in the studio. This sound strikes the microphone, the operating element of which is a thin metal disk or diaphragm. The sound waves cause this diaphragm to vibrate. In doing so, the disk causes changes to take place in the electrical circuit. Pulsations of current are set up, the pulsations corresponding in strength to the variations of the spoken word, music or other sound as the case may be. These fluctuations are quite weak when they first come from the microphone and therefore they must be strengthened. They go through what is known as a voice amplifier which utilizes vacuum tubes to make the current stronger. The next piece of apparatus to consider is the *oscillator* (q.v.). This consists of one or more vacuum tubes, connected in a circuit of such a type that the tubes, when lighted and properly furnished with a high voltage direct current, will generate another current, alternating in character, which is said to be oscillating at radio frequency. Upon this current so generated, the voice current is impressed or superimposed. This process is called *modulation* (q.v.). The current from the oscillator is known as the *carrier wave* (q.v.) current and when voice currents are impressed upon it, it is known as modulated radio frequency current. This current flows in the aerial and there sets up radio waves.

**MODULATION**—Variation of current or wave form to conform to sound waves



Graph of a modulated carrier wave.

or to other predetermined forms. Various forms of modulation are dot and dash modulation, chopper modulation, buzzer modulation and *speech modulation* (q.v.). (See *Distortion*, *Double Modulation*, also *Modulation Frequency Ratio*.)

**MODULATION, DOUBLE**—See *Double Modulation*.

**MODULATION FREQUENCY RATIO**—The ratio of modulation frequency to wave frequency. An alternating current is said to be *modulated* when the amplitude of its oscillations is varied periodically. The frequency at which the variations occur, that is to say the *modulation frequency* is necessarily less than the frequency of the alternating current which is being modulated. The nature of the variations may assume practically any form. As examples, there are dot and dash modulation, chopper modulation, buzzer modulation and *speech modulation* (q.v.).

**MOLECULE**—The smallest group of atoms of an element or compound which can exist by themselves. A familiar analogy states that if a drop of water could be magnified to the size of the earth, its component molecules would be the size of base-balls.

**MOLYBDENITE**—symbol  $MoS_2$ —A lead gray sulphide of Molybdenum. It is used as a rectifier detector in contact with copper.

**MOLYBDENUM**—Symbol  $Mo$ —A silver

white metal found in nature as *molybdenite* (q.v.), a sulphide of molybdenum. When pure this metal is ductile and can be forged. It is used chiefly as an alloy to produce extremely hard steel. Molybdenite is used as a *crystal* (q.v.) in the detection of radio waves.

**MORSE LIGHT**—A search light used to signal code messages by means of intermittent flashes. (See *Code*.)

**MORSE INKER**—An instrument for recording Morse code signals in the form of dots and dashes on a moving paper band. In one form of Morse recorder, the attraction of the armature raises an inked wheel against the paper ribbon and thereby prints upon it the dots and dashes of the message.

**MOSCICKI CONDENSER**—A condenser in which the dielectric thickens out at the edges. It is essentially a form of *Leyden Jar* (q.v.) composed of a glass tube, especially thickened at the neck where the dielectric stress is greatest, coated inside and out with metal foil. The design of this condenser is such as to minimize *brush discharge* (q.v.) or *corona* (q.v.) effect at its edges.

**MOTOR**—A device for transforming electrical energy into mechanical energy. Motors may be designed for operation on direct current, on alternating current or on either direct or alternating current. These latter are known as *universal motors*. Direct current motors are classified as shunt, series and compound. This classification is arrived at according to the manner in which the field windings are connected. In the shunt motor the field winding is connected in parallel with the brushes (that is with the armature winding). In the series motor the field winding is connected in series with the armature and the line. Compound motors have a shunt winding in parallel with the brushes and a series winding in series with the armature and the line. Compound motors may be further classified as differentially compounded and cumulatively compounded. A differentially compounded motor is one in which the series field winding is so connected as to oppose the shunt field. A cumulatively compounded motor is one in which the series field aids the shunt field. The speed of the shunt motor is nearly constant, falling slightly as the load increases. The speed of the series motor decreases as the load increases. The differential motor may be constructed so that an absolutely constant speed will be maintained at all loads. The speed of the cumulative motor decreases rapidly as the load is increased. Alternating current motors are of the series type, the induction type, commutator type, synchronous type and repulsion type. There are a number of special classifications of alternating current motors such as single phase induction, polyphase induction, repulsion induction, etc. An ordinary direct current series motor used on alternating current will operate but at a low power factor, with a large eddy current loss and with violent sparking at the commutator. In order to adapt the series motor for universal use, it must be specially designed, the field structure being *laminated* (q.v.) in order to avoid *eddy currents* (q.v.) and the field coils having only a few turns to avoid too great *self-inductance* (q.v.) and consequently low *power factor* (q.v.). Sparking at the brushes can be avoided to a certain extent by designing the motor for a small field flux and with but a few turns in series in each armature coil.



**MOTOR-ALTERNATOR**—A motor generator (q.v.) set consisting of an alternator (q.v.) driven by a direct or alternating current motor. Such a set

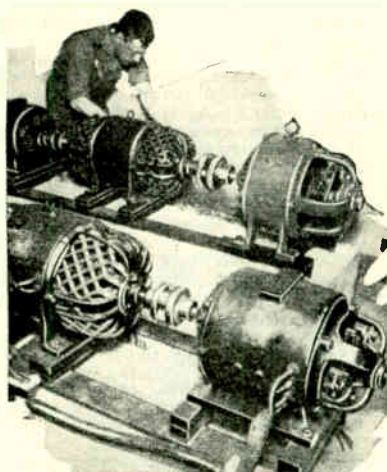

Motor Alternator set installed at Station WRNY.

may be used for converting from direct to alternating current, or for frequency changing.

**MOTOR-GENERATOR**—A generator or generators driven by an electric motor. Motor generators are used for converting alternating current to direct current or vice versa, for changing from one voltage or from one frequency to another or to obtain a variable from a fixed voltage.

**MOVABLE COIL**—Inductance coils which can be moved or rotated so as to vary the inductance. Examples of movable coils used in radio are vario couplers, loose couplers, etc. (See *Coupler, Loose; Coupler, Vario, also Fixed Coils.*)

**MULLARD, S. R.**—British radio authority. Born in 1884, he was educated as an electrical engineer and was ultimately appointed head of the research laboratory of Edison & Swan, Ltd., where he developed the Pointolite arc lamp. During the World War, he served in the Royal Air Force and became head of the wireless section laboratory at the Imperial College of Science for the Air Ministry. He carried out a series of researches on vacuum tubes and in 1920 founded the Mullard Radio Valve Company.

**MULTIPLE**—As applied to an electric circuit, a divided circuit. Two conductors are said to be connected in multiple or parallel (q.v.) when their two ends are joined together.

**MULTIPLE SERIES**—See *Series Parallel.*

**MULTIPLIER**—A resistance placed in series with a voltmeter for limiting and controlling the amount of current flowing through the voltmeter windings. This resistance may be either internal (enclosed by the voltmeter case) or external.

**MULTI-POLAR**—Having more than two poles. Usually a generator or motor whose field magnet has more than two poles. Small machines may be made with two poles, *bi-polar* (q.v.), but all others have a number of poles, that is to say they are *multi-polar*. The use of multi-poles results in a lighter machine and incidentally there is a saving of field copper and a reduction in sparking. If there are too many poles, however, there will be excessive leakage flux between the poles. (See *Homo-polar.*)

**MUSICAL SPARK**—A spark giving a regular distinct musical note. This may be produced by a high speed rotary discharger, a *quenched gap* (q.v.) or an arc.

**MUSICAL SPARK SIGNALS**—Signals in which the sparks occur at regular intervals of time and fast enough to give a musical note. Usually the spark rate is between 100 to 1200 discharges per second.

**MUTE ANTENNA**—A local circuit or resistor used in testing transmitting apparatus. The mute antenna in this case is substituted in the place of the actual antenna. It is also referred to as a *dummy aerial, phantom antenna, mock antenna, or artificial antenna.*

**MUTUAL CAPACITY**—The capacity effect of one conductor upon another one in the same electrostatic field. The mutual capacity is not the same as the capacity of the two wires regarded as the two plates of a condenser, one positively charged while the other is charged negatively. It really represents a decrease in the capacity of one of the wires with respect to earth caused by the presence of the electrostatic field of the other. The total capacity of the two wires is diminished by the overlapping of the two individual fields. (See *Capacity Measurement of Antenna.*)

**MUTUAL INDUCTANCE**—Symbol *M*—The magnetic flux that is common or mutual to two inductively coupled circuits. The mutual inductance of two circuits is the change in the interlinkage of flux that takes place in one circuit for a change of unit current in the other. This is also called the *coefficient of mutual induction* or the *mutual induction coefficient*. The units of mutual inductance are the same as those of *self-inductance*. (See *Inductance, Mutual; Self-Inductance, Induction, Coupling, Induced E.M.F.,*

*Induction, Mutual; Coefficient, and Mutual Induction Coefficient.*)

**MUTUAL INDUCTION**—The interaction between two current-carrying coils, not having direct metallic connection. The reactance of a coil such as shown in the illustration at A, is reduced by the proximity of another coil, A<sub>2</sub>, if the circuit of the latter contains no external source of electromotive force, such as an alternator. The reason for this lessening in the primary reactance is that the flux excited by the first coil induces a current in the secondary coil and this current opposes the action of the primary current. As a result the total *magneto-motive force* (q.v.) the *flux* (q.v.) and consequently the *counter-electromotive*

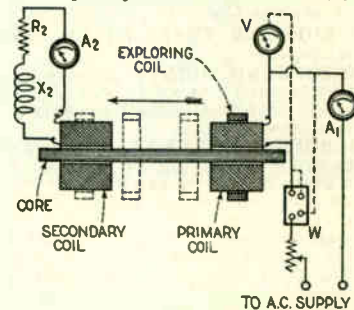

Diagram illustrating mutual induction. The reactance of the coil A<sub>2</sub> is reduced by the proximity of coil A<sub>1</sub>, since the circuit of A<sub>2</sub> contains no source of electromotive force. The effect of the secondary coil depends not only upon its distance from the primary coil but also upon R<sub>2</sub> and X<sub>2</sub>. The presence of the iron core greatly increases the action.

*force* (q.v.) induced in the first coil are reduced. The effect of the secondary coil depends upon its distance from the primary coil and upon the amounts of the resistance R<sub>2</sub> and reactance X<sub>2</sub>. If both coils are mounted on the same iron core, the action is greatly increased. In some instances mutual induction is desirable, as in the case of coupled radio circuits, or even in the ordinary transformer. In other cases, mutual inductance may be undesired as in the case where a radio antenna parallels a power line. (See *Induction, Mutual; Mutual Inductance, also Mutual Induction Coefficient.*)

**MUTUAL INDUCTANCE COEFFICIENT**—Another name for *mutual induction* (q.v.) That coefficient by which the rate of change of the current in a circuit must be multiplied to give the electromotive force induced in an adjacent circuit. From the principle of conservation of energy, it can be shown that the mutual inductance of a circuit A with respect to a second circuit B equals the mutual inductance of B with respect to A. (See *Mutual Inductance, Inductance, Mutual; Self-Inductance, Induction, Coefficient, also Coupling.*)

## N

**NAGYAGITE**—A mineral containing lead, gold, antimony, sulphur, and tellurium. It receives its name from the location of its discovery near Nagyag in Transylvania. It is also known as black or leaf tellurium, and has been used as a crystal rectifier in conjunction with zincite.

**NALLY, Edward Julian**—American

radio pioneer. Born April 11th, 1859, in Philadelphia, he joined the Western Union Telegraph Company in St. Louis and worked his way up in the telegraph service until in 1913, he was appointed vice-president and general manager of the Marconi Wireless Telegraph Company of America. Nally was one of the first to see the possibili-

ties of wireless, and under his control the first commercial wireless communication was established between the United States and Japan, in 1914, and in 1920, he founded the first commercial wireless service between the United States and Great Britain, and afterwards to other countries. He was appointed the first president of the

## Name Plate

Radio Corporation of America, and is a member of many scientific and other societies.



Edward Julian Nally.

**NAME PLATE**—A metal plate affixed to a radio set or other apparatus, giving the maker's name, trade name of apparatus, serial number or other details concerning the machine.

**NAPERIAN BASE**—The base of the so-called natural system of *logarithms* (q.v.). It is usually represented by the symbol  $\epsilon$  (epsilon) and is numerically equal to 2.718 appx. (See *Damped Waves*.)

**NAPERIAN LOG**—See *Naperian Logarithms*.

**NAPERIAN LOGARITHMS**—Also called *Natural Logarithms*. Logarithms to the base  $\epsilon$ . Logarithms constitute a tabular system of numbers, by which the operation of multiplication can be performed by addition, division by subtraction, involution by a single multiplication, and evolution by a single division. John Napier, Laird of Merchiston, Scotland, is generally regarded as the inventor of logarithms. The logarithms set forth by Napier were those of trigonometric functions. Later on Napier's logarithms were adapted to positive integers, using as a base the number 2.718 appx. and these logarithms are now called natural or Naperian logarithms. (See *Decrement*, also *Logarithms*.)

**NATIONAL ELECTRIC CODE**—A uniform code of rules, based upon the requirements of fire underwriters, for the electric wiring and electric installations in buildings. Unless these rules are compiled with fire insurance will not be issued or if issued previously will be voided. The National Electric Code contains a section covering special requirements for radio installations. The code is revised annually to meet new conditions and requirements. Copies of the code can be obtained from local insurance agents or from the National Board of Fire Underwriters at New York or Chicago.

**NATURAL ELECTRIC WAVES**—Wireless waves due to natural causes such as lightning discharges. When received in the radio apparatus, they are called *strays* (q.v.), *static* (q.v.), *atmospherics*, *X's* (q.v.), and various other names. There are many different causes for these stray waves. Some produce a grinding noise in the loud speaker, others a hissing noise often associated with snow or rain. Nearby

lightning produces a sharp snap. Another type of strays cause loud crashes in the speaker.

**NATURAL MAGNET**—A substance which possesses in a natural state the properties of a magnet. Such a substance is the *lodestone*, a magnetic oxide of iron also called *magnetite* (q.v.). (See *Loadstone*.)

**NATURAL FREQUENCY**—The frequency at which free oscillations occur in a circuit. If L, C, and R are respectively the inductance, capacity and resistance of a circuit, then free oscillations in the circuit will have the frequency

$$f = \frac{1}{2\pi} \sqrt{\frac{1}{LC} - \frac{R^2}{4L^2}}$$

This is the natural or *fundamental frequency* of the circuit. The natural frequency of an aerial is the frequency corresponding to the natural wave length. (See *Natural Wave Length*, also *Measurement of Wave Length*.)

**NATURAL RECTIFIER**—A mineral which possesses the property of conducting an electric current in one direction only. (See *Crystal*, also *Crystal Detector*.)

**NATURAL WAVE-LENGTH**—Length of the wave emitted by an aerial when no added inductance or capacity is inserted in the aerial circuit. This is also known as the *fundamental wave length* (q.v.). By putting *inductance coils* (q.v.) (*loading inductance*) (q.v.) in the aerial circuit, longer waves may be radiated, while condensers put in series with the antenna enable it to produce shorter waves than the aerial would ordinarily radiate. The use of a series condenser is avoided wherever possible since it has the effect of decreasing the total capacity of the aerial circuit and thereby decreasing the amount of power which can be given to the antenna. The addition of some inductance has a beneficial effect, since the decrement of the aerial is thereby lessened and a sharper wave results. (See *Measurement of Wave Length*; *Wave Length*.)

**NAUTICAL MILE**—abbreviation *Naut*—A marine unit of distance. Equivalent to one minute of longitude at the equator. This unit is also sometimes referred to as a *Telegraph Naut*. It is equal to 1.1528 statute miles (the statute mile being equal to 5,280 feet). The term *nautical mile* is used especially in submarine cable work, and also in matters pertaining to navigation. The term *naut* is differentiated from *knot* in that the former refers to a distance whereas the latter refers to a rate or unit of speed.

**NEGATIVE CARRIER\***—An electron combined with neutral gas molecules. When the velocity of the electrons in a vacuum tube is less than the value necessary to cause ionization by collision, the electrons attract the neutral gas molecules and so form heavy negative carriers. The ease with which this formation of negative carriers takes place depends on the nature of the gas. Such gases as argon and mercury vapor do not readily form negative carriers, while hydrogen and oxygen combine with electrons more easily. The effect of this negative carrier formation is to counteract the reduction of the negative space charge occasioned by the heavy positive ions formed by collision ionization. The positive ions are ions of the gas from which one or more electrons have been

removed. The ions therefore have very nearly the same weight as the gas atoms. The negative carriers, on the other hand, may consist of an atom or molecule to which has been attached an electron. It is also possible that the attraction between an electron and the neutral gas molecules can result in the formation of clusters consisting of more than one molecule held together by the electron. These negative carriers, therefore, move as slowly as, and often more slowly than, the positive ions and consequently have a relatively great effect in counteracting the tendency of the positive ions to reduce the negative space charge of the electrons. (See *Electron Theory*, also *Ion*.)

**NEGATIVE CORPUSCLE**—The natural unit of negative electricity. The *electron* (q.v.). It is more usual to refer to the negative corpuscle simply as the *corpuscle*. This was the name given by Sir J. J. Thomson to the carriers of electricity shot off from the cathodes in vacuum tubes. The corpuscle was found to have a charge equal to the electron and a mass which is  $\frac{1}{1845}$  of that of the hydrogen atom.

**NEGATIVE ELECTRODE**—In a *primary cell* (q.v.) the *cathode* (q.v.) which is the carbon, copper, etc., electrode, is the *negative electrode*, while the *pole* of this electrode is the positive pole, since it is positive in relation to the external circuit. In a *secondary* or *storage cell*, the spongy lead plate, which is the anode during discharge, is called the *negative electrode* and its pole the *negative pole*.

**NEGATIVE ION**—An atom, which is the smallest particle of an element capable of existing, plus an *electron* (q.v.). (See *Anion*, *Cathion*, *Electron Theory*, also *Ion*.)

**NEGATIVE POLE**—The south-seeking end of a magnet. In a generator, the terminal into which the current returns from the external circuit. In a storage cell, the terminal of the negative plate. In a primary cell, the pole of the positive plate.

**NEGATIVE RESISTANCE**—A current path within a vacuum tube or an arc in which current decreases as voltage increases. The emission of electrons from cold electrodes under the impact of electrons (known as *secondary electron emission* (q.v.) or *delta rays*) results in a negative resistance or *falling characteristic*. The presence of sec-

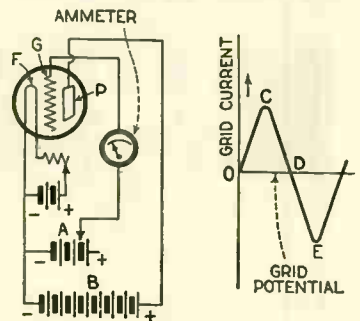

At the left is a hook-up for demonstrating negative resistance. The curve at the right shows the decrease of grid current although grid potential is increased.

ondary electrons can be shown by referring to the illustration. The plate P is kept at a constant positive potential with respect to the filament F by means of the battery B. When there is no difference of potential between the filament and the grid G, the cur-

(\*Van der Bijl—The Thermionic Vacuum Tube.)

rent in the circuit FGA is very small, since practically all the electrons emitted from the filament are drawn through the openings of the grid and thrown on to the plate. If the potential of the grid (positive with respect to the filament) is increased, the current to the grid at first increases, as shown by the part OC in the accompanying curve. When the grid potential reaches a certain value, the current as indicated by the ammeter begins to decrease, drops down to zero at D and then reverses its direction of flow. The reason for this is that while the difference of potential between the filament and the grid is small, the electrons that strike the grid enter it, but as the positive grid potential is increased the electrons on striking the grid emit secondary electrons from it and these are drawn to the plate which is maintained by the battery B at a positive potential, with respect to the grid. The net current as shown by the ammeter is the sum of the electrons entering the grid and those leaving it. When the velocity with which the electrons strike the grid increases beyond a certain value, one primary electron can knock out more than one secondary electron from the grid and the current in the filament-grid circuit reverses. When the positive grid potential is increased to such an extent that the grid becomes positive with respect to the plate, the secondary electrons are no longer drawn away to the grid so that the reversed current in the grid circuit again decreases as shown at E on the curve, and finally assumes the original direction. Hence, considering the current as indicated by the ammeter and the voltage between filament and grid, it can be seen that over the portion of the curve CDE, the current decreases as the voltage increases. Therefore CDE represents a *negative resistance* characteristic. It has been found that a device which possesses a negative resistance can function as an amplifier and also as a generator of continuous oscillations.

**NEGATRON**—An English vacuum tube

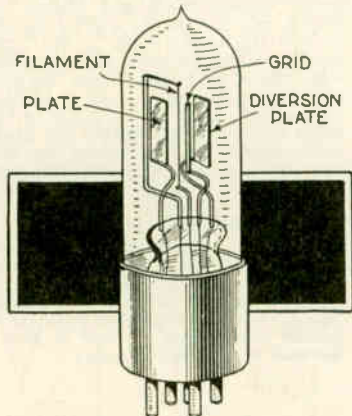

A negatron tube, showing the two plate construction.

containing a filament, a grid and two plates. This tube was devised by J. Scott-Taggart, who used it for obtaining *negative resistance* (q.v.) characteristics. The two plates are fixed one on each side of the filament. The accompanying illustration shows a typical negatron. The bulb is tubular in shape and the four electrodes are plainly shown. The grid, in this tube, is a metal rod.

**NEON LAMP**—An incandescent lamp in which a reddish light is produced by the incandescence of neon gas at low pressure. This lamp has very low current consumption and has been applied to pilot lights, signs, etc.

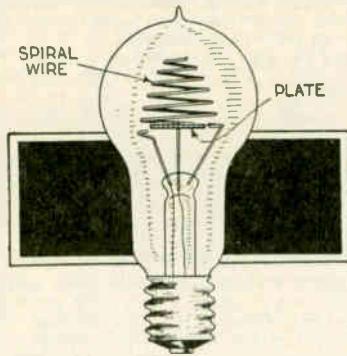

Neon Lamp

**NEON TUBE**—A vacuum tube containing the gas neon at low pressure used in the Fleming *Cynometer* (q.v.) etc. In this instrument, which is used to measure the frequency of electric waves, wave lengths, etc., a capacity formed by one brass tube sliding over another can be varied simultaneously with an inductance consisting of an air core solenoid and arranged so that the point at which resonance takes place is indicated by the glowing of the *neon tube* and can be read from a calibrated scale.

**NERNST LAMP**—An incandescent lamp in which the incandescent body consists of a strip of material composed of a mixture of oxides of metal such as zirconium, magnesium and other refractory oxides. The incandescent portion of the lamp is called the *glower*

connected alternator is also known as the neutral wire. The neutral wire is here also known as the *common return*.

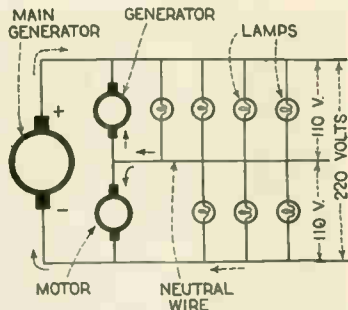

A three wire system with unbalanced load, showing neutral wire.

**NEUTRODYNE**—See *Neutrodyne Circuit*, also *Hazeltine Neutrodyne Receiver*.

**NEUTRODYNE CIRCUIT**—A circuit

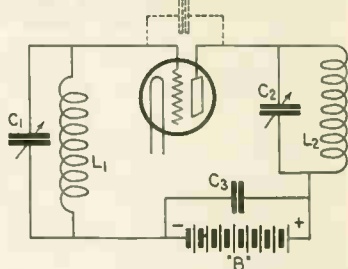

Fig. 1. A portion of a receiving circuit. Dotted line shows tube capacity represented by an equivalent condenser.

used in radio reception in which radio frequency amplification is used for neutralizing the effects of capacity of

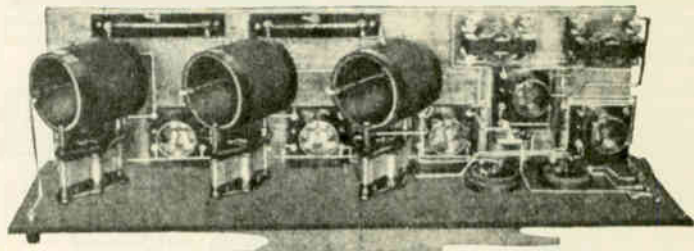

Fig. 2. A typical neutrodyne set.

and is conductive only at a high temperature. Consequently it has to be heated by an auxiliary heating coil. The heating coil is automatically cut out of the circuit when the current starts to flow through the glower.

**NEUTRAL BODY**—A body void of electrification. A charged body which loses its electrification is said to be *discharged* or *neutralized*. All matter is capable of electrification.

**NEUTRAL LINE OF MAGNET**—The middle portion between the two magnetic poles of a bar magnet, where there is no manifestation of magnetism.

**NEUTRAL WIRE**—A middle wire, in a *three wire system* (q.v.) of power distribution, which is kept at a potential mid-way between the positive and the negative mains. In the three-phase system of alternating current distribution, the conductor connected to the neutral point of a "star" or "Y" con-

the tube and its socket. Figure 1 shows a portion of a receiving circuit. In this diagram the tube capacity is represented by a condenser shown in dotted lines. By studying this circuit, it can be seen that a closed oscillatory circuit exists, made up of the inductances and capacities in the plate and grid circuits. Just as radio frequency currents can pass through condensers in a receiving set, so they can pass through or across the vacuum tube from the plate to the grid, which forms a condenser. This condenser effect is the reason why radio frequency amplifiers oscillate. A difference of potential occurs in the plate side of the coil in the plate circuit. Instead of this being handed on to the next tube for additional amplification, a portion of this potential leaks through the capacity of the tube and its socket and affects the grid in such a way that trouble is experienced with self-oscillation. In the neutrodyne circuit, the

## Nichrome Wire

inter-element capacity of the amplifier vacuum tubes is neutralized by means of special condensers called *neutrodons*. The capacity of these is very low, being approximately equal to the internal capacity of a vacuum tube. By reason of this equality, any tendency of a large amount of radio frequency current to pass back through the tube through the grid is defeated and instead is neutralized by the combination of the neutralizing capacities, the inter-element capacity of the vacuum tubes and the secondary windings of the tuned radio frequency transformers. This effect is in reality a bucking one, since the current is made to take two paths. Each neutralizing condenser must be adjusted so that its capacity will equal that of the vacuum tube it is connected with. Since it is impossible for a neutrodyne circuit to oscillate, there is no radiation of energy from the set, with consequent disturbance of other receiving sets in the vicinity.

The neutrodyne circuit was invented by Professor L. A. Hazeltine. The typical neutrodyne receiving set uses five tubes, employing two stages of tuned and neutralized radio frequency amplification, with detector and two audio frequency stages. (See *Hazeltine Neutrodyne Receiver*.)

**NICHROME WIRE**—A nickel-chromium-steel alloy wire, which is able to withstand a bright red heat in the atmosphere without oxidizing. Nichrome is practically non-corrosive. It has a very high melting point, about 1550 degrees Centigrade and is used extensively in electrical heating appliances and resistance elements.

**NIGHT EFFECT**—Changes in the strength of radio signals noticeable especially at night. This effect is also known as *fading* (q.v.). Fading does not generally occur in the immediate vicinity of the transmitting station. It seems to happen more often on wave lengths below 400 meters. A certain station is being received with normal intensity, when suddenly the sounds become very faint and in a few minutes they may again become normal or may even become stronger than usual. In some cases the variations from strong signals to weak take place every few minutes while in other cases there may be an interval of several hours. It has been observed that fading takes place over land more often than in radio transmission at sea.

**NOBLE, Sir William**—British engineer. Born in 1861 and educated at Gordon's College, Aberdeen, he thereafter entered the Aberdeen telegraph office. In 1893 he was appointed engineer for the northeast area of Scotland, rising rapidly in the service until he became chief engineer in 1919. He retired from the Post Office in 1922, and became a director of the General Electric Company and of the British Broadcasting Company. Sir William Noble has

written many articles on telegraphy and telephony and is considered to be an authority on these subjects.

**NODES**—In a wave form, such as shown in the illustration which represents an alternating current sine wave, the zero points. Thus in the alternating current sine wave, the points of zero current or potential, at A, C, E, and G, are nodes, and the points B, D, and F are the anti-nodes or *loops* (q.v.).

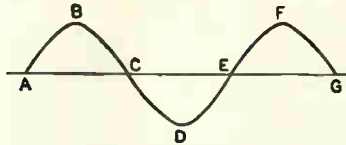

Sine wave illustrating nodes and anti-nodes.

**NODEN VALVE**—An electrolytic rectifier (q.v.) which allows only current in one direction to pass through it. This rectifier utilizes an aluminum rod or cylinder as a cathode and the anode may be of iron, lead or of carbon. Ammonium phosphate is used as the electrolyte. The principal operation of this rectifier depends upon the

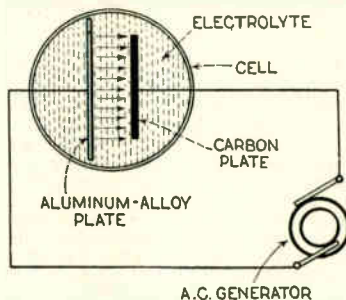

Fig. 1. Diagrammatic illustration of the principle of the Noden valve.

fact that the current in the positive direction is stopped at the aluminum plate through the formation of an in-

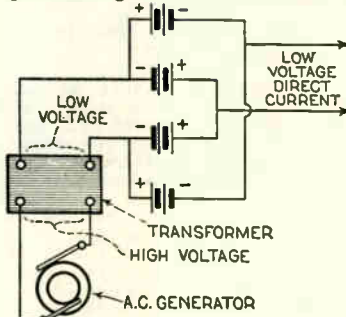

Fig. 2. A hook-up for connecting four Noden cells to obtain full wave rectification.

solating crust of aluminum phosphate and aluminum oxide. These two sub-

stances present an extremely high resistance to the passage of the current in the positive direction, but the compounds dissolve again upon reversal of the current. By suitably combining two or more cells, both the half waves of an alternating current can be rectified. In Fig. 1 is shown the principle upon which the Noden Valve acts, and Fig. 2 shows a hook-up for connecting four cells to obtain full wave rectification. (See *Electrolytic Rectifier Full Wave*, also *Rectifier*.)

**NON-CONDUCTOR**—See *Insulator*.

**NON-INDUCTIVE COIL**—A coil having negligible inductance. Such a coil may be wound by doubling the wire upon itself and then winding the two parallel halves side by side.

**NON-OSCILLATORY**—Free from oscillations or vibrations. Without periodicity, that is to say, *aperiodic* (q.v.). A current which is uniform in direction and flow and free from oscillations is said to be a non-oscillatory current. A non-oscillatory circuit is one in which an impressed potential will produce current that gradually diminishes in amplitude without reversing its direction of flow. This is also called an *aperiodic circuit* (q.v.). Such a circuit can have no natural period of oscillation.

**NON-PERIODIC**—See *Aperiodic*, also *non-oscillatory*.

**NON-RADIATIVE ANTENNA**—A combination of capacity and inductance equivalent to that of an aerial, used to test transmitting apparatus without radiating waves. (See *Mute Antenna*.)

**NORTH MAGNETIC POLE**—A point on the earth at a latitude 70 degrees North, longitude 97 West. The north magnetic pole does not coincide with the north (geographic) pole. (See *Magnetic Poles*.)

**NORTH POLE**—See *Magnetic Poles*, also *North Magnetic Pole*.

**NO-VOLT RELEASE**—An electro-magnetically controlled device, inserted in the field circuit of a motor so that it holds the handle of the motor starter in place on the last stud, but if the supply current fails, the magnet becomes de-magnetized and allows the spring attached to the starter handle to pull the handle back to the "off" position. This prevents damage to the windings of the motor, in case the current comes on again, since it is then necessary to start up the motor in the usual way, using the starter and gradually increasing the voltage by cutting out the limiting resistances provided in the starter. (See *Overload Release*.)

**NULL METHOD**—An electrical method of testing in which adjustments are made so that zero deflection is obtained in a galvanometer, as for example when using a *Wheatstone Bridge* (q.v.). This is sometimes referred to as the *zero method*. (Null is also a German word meaning zero.)



**OCTAHEDRITE**—Chemical Symbol  $TiO_2$ .—Titanium dioxide, an eight sided crystal which has been used as a crystal detector for detecting and rectifying radio currents. (See *Crystal*.)

**OERSTED**—The unit of *reluctance* (q.v.). The reluctance or in other words, the magnetic resistance offered by a cubic centimeter of vacuum. Unit *magneto-motive-force* (q.v.) will generate a unit of *magnetic flux* (q.v.)

through unit reluctance. The oersted was named after the Danish physicist, H. C. Oersted.

**OHM**—Symbol  $\Omega$  (Omega)—The unit of electrical resistance. It is the ratio of unit *electromotive force* (q.v.) to unit current. The ohm is the basis of the entire electrical system of units and the volt and the ampere are defined in relation to it. Very elaborate apparatus is required in order to de-

termine the ohm absolutely. However, resistances can be compared easily and once the standard is determined it is a simple matter to make duplicates. In accordance with an act of Congress, the ohm was adopted as a legal unit and defined as follows: The unit of resistance shall be what is known as the international ohm, which is substantially equal to one thousand million units of resistance of the centi-

meter-second-gram system of electromagnetic units and is represented by the resistance offered to an unvarying electric current by a column of mercury at the temperature of melting ice, 14.4521 grams in mass, of a constant cross-sectional area and of the length of 106.3 centimeters. Stated in English units, the ohm is specified as the resistance offered to an unvarying electric current by a column of mercury at the temperature of melting ice (32 degrees Fahrenheit), 0.5050 of an ounce in mass (approximately 3/100ths of a pound), of a constant cross-sectional area and of a length of 3.487 feet.

**OHMMETER**—An instrument used to measure resistance directly in ohms. It is particularly adapted for measuring high resistances, although certain types of ohmmeters are made for measuring lower resistances. In one form of ohmmeter, the moving system is deflected by forces due to currents in two coils at right angles to one another. These carry currents in one case proportional to the current through the conductor under test, and in the other case proportional to the potential drop across it. This is in effect, a special form of *galvanometer* (q.v.) and when combined with a hand driven generator gives the conventional *megger* (q.v.) The bridge type ohmmeter depends on the *Wheatstone Bridge* (q.v.) principle. In this instrument, however, the rheostat resistance remains constant and the bridge arms are formed by a wire, called a *slide wire*, resistances being varied by means of a moving contact as shown in the illustration. This type of instrument is often referred to as a *slide wire ohmmeter*. While a straight slide wire is used in some types, in others the wire is wound

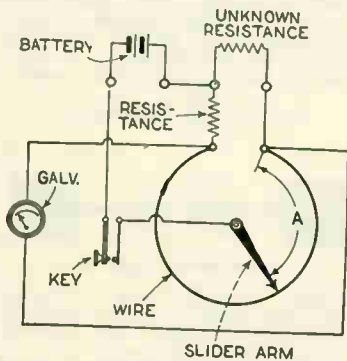

Diagram of connections of a slide wire ohmmeter.

on an insulating cylinder. In the Weston direct-reading ohmmeter, there is a permanent magnet and a moving coil having two windings and an adjustable magnetic shunt. Provisions are made for connecting an unknown resistance and an auxiliary battery in the circuit of the instrument. A checking plug is provided for checking the accuracy of the instrument before use. When the key is closed, the battery current is divided between two windings. The magnetic force exerted on the one winding, which is in series with a fixed resistance, tends to deflect the pointer up the scale, while the force exerted on the other winding tends to return it to zero. With the correct battery voltage the magnetic shunt may be adjusted to bring the pointer to full scale position. When the plug is shifted to the low range position, a resistance equal to that of the low range is removed from the cir-

cuit whose magnetic force tends to deflect the pointer towards the zero position. By connecting a resistance equal to that of the low range across the "unknown" binding posts, the previous condition is restored and the pointer will go back to the full scale position. For values of resistance lower than this the opposing force will be greater and hence the coil will be brought back to a lower position on the scale. At zero resistance across the "unknown" binding posts, the magnetic forces of the two windings will balance each other, thus causing the coil to stand at zero on the scale. The Vawter indicating ohmmeter is of the galvanometer type and utilizes two coils carried by a shaft and moving in the field of a permanent magnet. A specially shaped core is used to give the desired scale characteristics. By making connections to the coils through spirals of negligible torque, the position of the pointer does not depend upon the value of the current nor on the strength of the permanent magnet.

**OHMIC COUPLING**—See *Resistance Coupling*.

**OHMIC DROP**—The fall in potential which occurs when an electric current flows through a resistance. (See *IR Drop*.)

**OHMIC LOSS**—Power or energy loss due to the resistance which an electrical circuit offers to the flow of current. (See *I<sup>2</sup>R Loss*.)

**OHM'S LAW**—Current flowing in a conductor will increase directly with increase of voltage and will decrease directly with increase of resistance. In other words, voltage is the cause, while current is the effect. The effect is directly dependent upon the cause and inversely dependent upon the opposition offered to the cause. Ohm's law is the fundamental law of electrical engineering. Ohm's law can be stated as an equation as follows:

$$\text{Current (in amperes)} = \frac{\text{Voltage (in volts)}}{\text{Resistance (in ohms)}}$$

$$\text{Voltage} = \text{Current} \times \text{Resistance}$$

$$\text{Resistance} = \frac{\text{Voltage}}{\text{Current}}$$

The above three equations all mean the same thing and serve to express in various forms, the idea set forth above. Ohm's law can be applied to every conductor, provided that the conductor stays at a constant temperature, that there is no internal electromotive force in the conductor and that the distribution of the stream lines in the conductor remains unchanged. Ohm's law is easy to understand and easy to apply. Thus in a particular circuit, a certain voltage causes a certain current to flow. Double the voltage will cause double the current to flow, if the resistance is the same. If the resistance is doubled, however, the same voltage will result in only half the current flow. Double voltage and double resistance results in unchanged current flow. Ohm's law applies to a portion of an electrical circuit as well as to the entire circuit. Care must be taken when applying the law to only part of the circuit, to consider only the resistance, current and voltage of that part.

**OMNIBUS BAR**—A conducting bar of copper, mounted in back of a switchboard, or panel and serving as a common connector for two or more pieces of apparatus. This term is more usually shortened to *bus bar* (q.v.)

**OMNIGRAPH**—An instrument which sends code (dots and dashes) me-

*Open Circuit Primary Cell*

chanically. It is usually operated by clockwork and is connected with a buzzer. It employs metal disc records

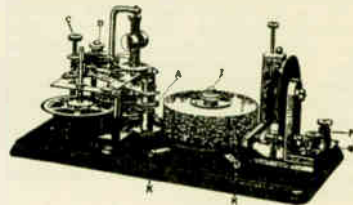

The omnigraph—an instrument which sends code mechanically.

each of which has a series of notches which correspond to the dots and dashes of the telegraph code. The omnigraph is used by beginners in learning the code and is also used to test the speed of reception of applicants for radio operators' licenses.

**ONDOGRAPH**—An instrument for automatically recording the wave forms of varying currents, especially currents which are alternating rapidly. This form of curve tracer was invented by Hospitalier.

**ONDOMETER**—Another name for a *wave meter* (q.v.)

**OPEN ANTENNA**—According to the report of the Institute of Radio Engineers standardization committee, this is a condenser antenna, that is to say an antenna consisting of two capacity areas. Antennas may be subdivided into two general classes, those which act principally as condensers, usually simply called antennas, and those which act principally as inductances. These latter are *loop antennas* (q.v.), *coil antennas* (q.v.), etc. When electric waves reach a condenser antenna, they set up an alternating electromotive force between the wires forming the upper plate of the condenser and the ground or the other lower plate of the condenser. As a result of this alternating electromotive force, alternating current will flow in the antenna system. (See *Aerial*.)

**OPEN CIRCUIT**—An electrical circuit which does not offer a complete path for the flow of electricity. There may be one or more breaks in the path. An open circuit is often referred to as a *broken circuit*. Open circuits often cause trouble in radio apparatus. They may be due to the burning out of a winding, to a connection coming off a terminal, to a soldered connection breaking loose or to similar causes. The method of testing for an open circuit is to connect a battery and a headset in series with the circuit in question. If there is no click in the headset, there is evidently a break in the circuit.



An open circuit primary cell.

**OPEN CIRCUIT PRIMARY CELL**—A primary cell (q.v.) designed for inter-

### Open-Core Transformer

mittent use and normally kept on open circuit. Such cells usually have a *depolarizer* (q.v.) which acts slowly. In certain cases, no depolarizer whatsoever is employed. Open circuit cells are designed for use during short intervals of time only and must stand for long periods on open circuit, during which the hydrogen is gradually taken away from the negative plate. The operation of the open circuit cell will not be satisfactory if the rest periods are not long enough or are not at frequent intervals.

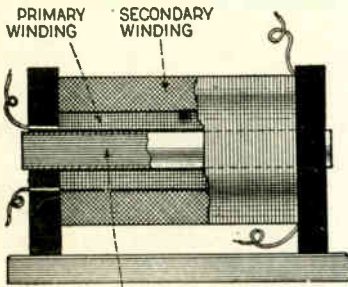

An open-core transformer.

**OPEN-CORE TRANSFORMER**—A transformer in which the (useful) magnetic circuit is partly through iron and partly through air, instead of entirely through iron as in the *closed-core transformer* (q.v.). It is sometimes referred to as a *polar transformer*. In one type of open-core transformer the arrangement is similar to that of an *induction coil* (q.v.), a hollow iron core, filled with soft iron wires being employed to concentrate the magnetic field.

**OPPOSING ELECTROMOTIVE FORCE**—See *Back Electromotive force*.

**OPTOPHONE**—An instrument utilizing a telephone receiver controlled by the variations of resistance of a *selenium cell* (q.v.) by means of which the blind are enabled to read ordinary type, through the sense of hearing.

**ORDINATE**—A mathematical term used in radio in making *logs* (q.v.) or other curves. Defined in mathematical language, the ordinate is that one of the coordinates of a point which is drawn parallel to a line (called the axis of ordinates) to the point from the other

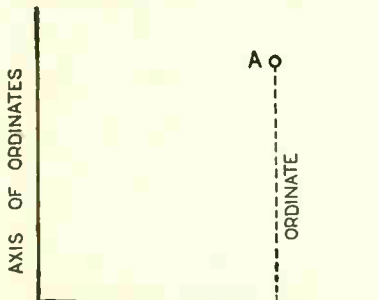

The dotted line is an ordinate.

axis (called the axis of abscissas) or from the plane of the other axis of coordinates, assumed as a basis of reference. This definition will be clearer if reference is made to the accompanying illustration. The dotted line drawn from the point A to the axis of

abscissas is the ordinate of the point A.

**OSCILLATING CURRENT**—An alternating current of high frequency, consisting of a succession of waves of constant length. In some cases, the term oscillating current refers particularly to a current where the amplitude is decreasing in constant proportion due to damping. (See *Oscillation, Oscillation Frequency*, also *Logarithmic Decrement*.)

**OSCILLATING IMPULSE**—An oscillating current set up for the purpose of producing electric waves.

**OSCILLATING PERIOD**—The time of one complete *oscillation* (q.v.).

**OSCILLATION**—Periodical surging first in one direction and then in the other. Electrical oscillations are the surgings backward and forward of current periodically, as, for example, in the case of a condenser being discharged in an oscillating circuit. The oscillating action in a discharging condenser is as follows: In the case of a condenser, positively charged, upon being discharged through an inductance, the charge rushes out of the condenser, the current increasing in strength until it reaches a maximum. Then, due to self-induction the current prolongs itself, and it continues until its energy is changed back into an electric charge of an opposite sign, current flowing into the condenser which is then charged negatively. The condenser again discharges giving a maximum current in the opposite direction, the current thereafter flowing back into the condenser with the same direction charge as at first. This action constitutes one complete swing or oscillation and the current continues to oscillate, each time becoming weaker and weaker as the energy is dissipated into heat and also partially into electric waves. It is important to note that the propagation of electric waves could not be accomplished without electrical oscillations. Thus at the transmitting station, the electrical oscillations are converted into electric waves and at the receiving station, the waves are re-converted back into oscillations.

**OSCILLATION CONSTANT**—The square root of the product of the capacity and the inductance of a circuit. The *natural period* of a circuit is determined by its inductance and capacity in the same manner as the natural period of a steel spring clamped at one end in a vise is determined by its mass and elasticity. Where a simple aerial is used it is an easy matter to calculate the length of a wave radiated from it, provided the oscillation constant has been found. The velocity of electric waves is approximately  $3 \times 10^{10}$  cm. per second, and hence the length of the wave radiated is about 60 times the oscillation constant where the wave length is measured in meters. (See *Aerial Tuning Condenser*, also *Isosynchronous*.)

**OSCILLATION FREQUENCY**—The number of complete oscillations or cycles flowing in a circuit per second. The oscillation frequency of a circuit varies inversely as the square root of the product of the inductance and capacity. The frequency is inversely proportional to the wave length, hence the addition of either *capacity* (q.v.) or *inductance* (q.v.) to the oscillatory circuit will result in an increase of *wave length* (q.v.). (See *Frequency*.)

**OSCILLATION POINT**—That current value, known as the *critical current* (q.v.), at which the vacuum tube or

tubes in a radio receiving set start to oscillate.

**OSCILLATION TRANSFORMER**—A high-frequency air-core transformer used for transferring electrical oscillations from one circuit to another. Either one or both the windings may be tuned to the frequency of the oscillations. The transformer used for coupling the oscillator of a transmitting set to the aerial is an example of an oscillation transformer. (See *Coupling, Inductive Coupler*, also *Transformer*.)

**OSCILLATION VALVE**—See *Oscillator*, also *Vacuum Tube*.

**OSCILLATOR**—A device or apparatus for producing electrical oscillations. The *vacuum tube* (q.v.) under correct conditions may be used to produce sustained oscillations of a definite amplitude and frequency. In order for a vacuum tube to act as an oscillation generator it must be capable of amplifying, part of its output energy must be returned to the input, an oscillation circuit must be combined with the tube, which possesses inductance, capacity and resistances of values such that the tube will oscillate with the desired frequency and finally the tube must have certain characteristics which when combined with the constants of the oscillatory circuit, will determine the amplitude of the oscillations. Oscillations may also be produced by means of a high frequency alternator and by a direct current generator and electric arc. (See *Alternator*, also *Alexanderson*.)

**OSCILLATOR, HERTZIAN**—Two insulated rods, with axes in line, with their nearer ends forming a spark gap and their outer ends bearing plates or balls to give the system the required capacity. The overall length is usually less than  $6\frac{1}{2}$  ft. and the whole constitutes an open oscillator. A Hertzian oscillator is sometimes called a

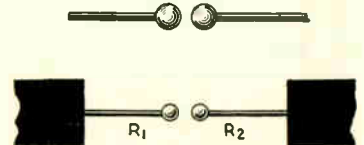

Typical Hertzian Oscillators.

*dipole*. When the rods are brought near each other but not in actual contact and the conductors are connected to the terminals of an *induction coil* (q.v.) a succession of sparks can be caused to jump the gap and these set up electric waves in the *ether* (q.v.).

**OSCILLATOR, LINEAR**—The straight wires connected on either side of the spark gap of an induction coil, traversed by oscillations. Linear oscillators are of the open type. As used by Hertz, they consisted of two rods, having a spark gap between their adjusted ends, while their outer ends terminated in plates or balls in order to increase the capacity of the system.

**OSCILLATOR, RIGHT**—In this type of oscillator, the spark gap is established between two metal spheres placed between two smaller spheres. (See *Oscillator*, also *Oscillator, Hertzian*.)

**OSCILLATOR, THERMIONIC**—A vacuum tube used to generate continuous oscillations. (See *Oscillator*.)

**OSCILLATORY CIRCUIT**—A circuit possessing *inductance* (q.v.) and *capacity* (q.v.), the electrical constants being such that an oscillatory current can be set up. The accompanying

figure shows a simple oscillatory circuit, consisting of a condenser, an inductance and a spark gap. When a source of high potential is connected across the spark gap and the latter is properly adjusted, the condenser is charged and there is a spark across the gap. Provided that there is not too much resistance in this circuit,

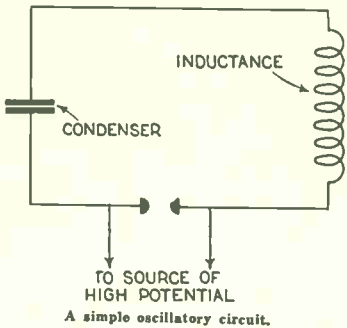

there will be set up an oscillating current (q.v.) of high frequency, decreasing in amplitude according to a fixed ratio. Such a current can be used to set up electric waves. Oscillatory circuits are of two general classes, closed as shown in the illustration and open, as in the case of an aerial system. An aerial which has no tuning condenser or inductance in its circuit still has distributed inductance and capacity, whereas an aerial having a tuning inductance and a condenser in its circuit, has a combination of concentrated and distributed inductance and capacity.

**OSCILLATORY CURRENT**—See *Oscillating current*.

**OSCILLION**—Name which has been applied to the vacuum tube (q.v.) especially where used as an oscillation generator.

**OSCILLOGRAM**—A picture, graph or record of a wave form usually obtained by means of an oscillograph (q.v.).

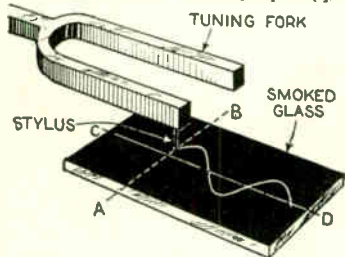

An oscillogram obtained by means of a tuning fork.

The illustration shows an oscillogram obtained on smoked glass by means of a tuning fork. (See *Oscillograph*.)

**OSCILLOGRAPH**—An instrument for recording photographically or showing visually the wave form of alternating currents or of other rapidly changing currents or voltages. The essential parts of such an instrument are a moving coil mirror galvanometer, a rotating or vibrating mirror and a moving photographic plate or film. Figure 1 illustrates the principle of the oscillograph and shows the curves it produces. The oscillograph was invented by M. A. Blondel in 1893. By means of the oscillograph the wave form of a current may be shown as a curve and its characteristics may thus be examined and studied. In order to form the curve, it is necessary to have simultaneous motion in two directions. The

vibrator of the oscillograph which consists of a delicate coil of wire, with mirror attached, is made extremely light so that the moving system will have as little inertia as possible. The

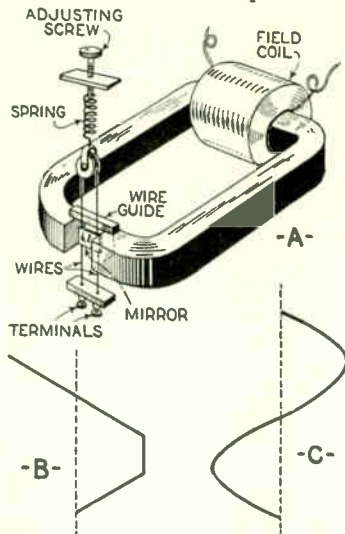

Fig. 1. The principle of operation of the oscillograph is shown at A. At B are shown diagonal and straight paths traced by the beam of light falling on a moving photographic plate. The type of curve which an oscillograph traces for alternating currents is shown at C.

coil is placed in a powerful magnetic field and when an oscillating current is passed through it, it oscillates in synchronism with the current. A spot of light focused on the mirror is made to fall on a screen at the predetermined distance from the vibrator. This spot of light traces out a straight line on the screen. Substituting a photographic film for the screen and arranging the film so that it will move in a vertical path across the moving beam of light (which is assumed to be moving from right to left across the screen) a curve is traced on the film. The commercial form of oscillographs are provided with apparatus whereby the curve may be examined without the necessity of photographing it. In these the beam of light is reflected from a rotating or vibrating mirror in

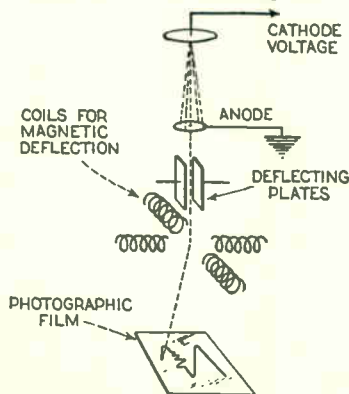

Fig. 2. A diagrammatic representation of the Dufour oscillograph.

such a way that it receives a horizontal and an up and down motion and is focused onto a curved plate of glass. Tracing paper may be stretched over the glass so that the image of the spot of light traces a visible curve on it. The curve being repeated very rapidly

appears to be standing still and hence it is possible to trace over it with a pencil or even to place a piece of photographic paper on the curved glass and make a record of the curve in this way. The motion picture camera has been applied to the oscillograph and is useful where longer records are required. It should be noted that oscillographs which utilize a moving coil, such as the Duddell or Blondin types, will work over a band of frequencies up to a maximum of about 300 cycles per second. Inasmuch as the oscillations common in radio work are of much higher frequency than 300 cycles, it has been found necessary to use an oscillograph whose moving parts are without appreciable weight. The use of electrons as moving parts has solved this problem. A Frenchman, Alexander Dufour, has applied the Braun tube to the construction of an oscillograph which has no appreciable inertia and which is capable of operating at a frequency up to a million cycles per second. This device uses only minute amounts of energy in its operation and therefore does not disturb the original circuit. It is able to register both voltage and current simultaneously and is so arranged that a single impulse is sufficient for a photographic impression. The Dufour oscillograph consists essentially of two glass tubes fitted by means of a ground joint into a bronze chamber. The upper glass tube carries a cathode and an anode and the other tube has one pair of deflecting plates for electrostatic deflection of the electron stream. Two sets of coils perpendicular to each other are used for magnetic deflection and these are placed outside the tube and slightly below the deflecting plates. In order to photograph the oscillations, a drum is used which is provided with a film magazine allowing six films to be taken in succession. When visual examinations of the oscillations are to be made, a fluorescent screen is turned up into position covering the opening into the interior of the drum thus preventing the films from being exposed when using the screen. After the films are put into the drum, this is placed within the bronze chamber and locked into position. An air-tight door is used to close the opening and the film changing mechanism is operated by means of external controls. Glass windows on either side of the bronze chamber allow the fluorescent screen to be seen. The accompanying sketch shown at Figure 2, gives a diagrammatic representation of the operation of the Dufour oscillograph.

**OSMOSIS, ELECTRIC**—When an electric current is passed through an electrolyte having an anode on one side of a porous diaphragm and a cathode on the other side, there is a tendency for the liquid to pass through the diaphragm towards the cathode raising the level of the liquid on the cathode side. This phenomenon is known as electric osmosis.

**OTOPHONE**—A device for the hard of hearing, which utilizes an extremely sensitive microphone connected to a two-stage vacuum tube amplifier. The instrument uses dry cell tubes and the batteries are contained in the case with the microphone. A small telephone receiver completes the outfit.

**LOUDIN RESONATOR**—A device used for obtaining high-frequency brush discharges. Discharges of this nature are used in the investigation of resonance effects and also in medical work. The accompanying diagram explains the principle of the Oudin resonator.

## Output

B D is an uninsulated coil of copper wire wound on an insulating core with each turn separated from the next adjacent one. At B, the helix is connected to an induction coil and it is tapped by means of a sliding contact at C. The sliding contact is connected through a condenser to the induction coil H, with a spark gap G in parallel

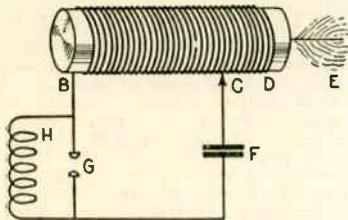

Connections of the Oudin resonator.

in the circuit as shown. The circuit BGFC is a closed oscillatory circuit receiving its excitation from the induction coil H. The circuit C D E is an open circuit in contact with the oscillatory circuit. By moving the sliding contact, C, a point is reached where a brush discharge appears at E, thus indicating that electric oscillations are being set up in the open circuit. (See *Brush Discharge*, *Corona*, also *Oscillator*.)

**OUTPUT**—The useful energy given out by a machine, circuit, vacuum tube or other device. (See *Input*; *Output*, *Transformer*; *Output Circuit of Vacuum Tube*.)

**OUTPUT CIRCUIT OF VACUUM TUBE**—The filament-plate circuit as differentiated from the filament-grid or input circuit. (See *Input Circuit of Vacuum Tube*.)

**OUTPUT, TRANSFORMER**—The product of the voltage at the secondary terminals of a transformer by the current flowing in the secondary winding. The output of any transformer is always less than the input by an amount equal to the losses. The efficiency of a transformer is the ratio of its useful output to the total input. (q.v.)

**OVERLOAD RELEASE**—A n electromagnetic device which is used to cause a motor starter handle to return to

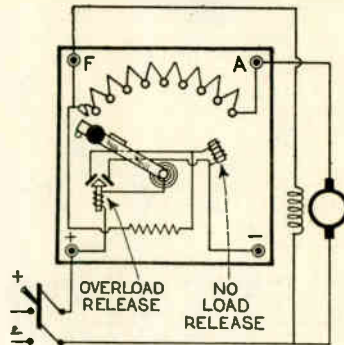

Overload Release.

the off position when the current exceeds a pre-determined overload value.

The overload magnet is usually arranged so that too strong a current will result in short-circuiting the no-volt release thus switching off the driving current. One form of overload release consists of a magnet in series with the line and the armature. This magnet is arranged to attract a pivoted iron keeper whenever excessive current flows. The pivoted arm, when attracted by the magnet, makes connection between two contacts, themselves connected so as to short circuit the holding magnet when the circuit is closed. Therefore, when more than the allowable current is drawn from the line, the overload magnet attracts its pivoted keeper which closes the circuit short-circuiting the holding magnet. The contact arm is then released by the holding magnet and the arm is pulled back to the off position, thus cutting the motor off the line. Another form of overload release utilizes an electromagnet to attract a pivoted arm, arranged so that this will break the circuit between the motor and the line. This results in operating the no-voltage release. (See *No-Volt Release*.)

**OVERTONE CURRENTS**—Alternating currents which have harmonic frequencies of a higher value than the fundamental or first harmonics.

**OVERTONES**—Higher harmonics associated with the first harmonic. This term particularly refers to sound waves. In various musical instruments, different overtones are brought out and this results in each instrument having its own tone characteristic.

# P

**PACKING**—(referring to a microphone).

The tendency of carbon granules in a microphone to settle or pack. In this position they are no longer sensitive and do not readily respond to the vibrations of the diaphragm. Packing may be caused by irregularity in the sizes of the carbon granules. It may be remedied by gently tapping the microphone.

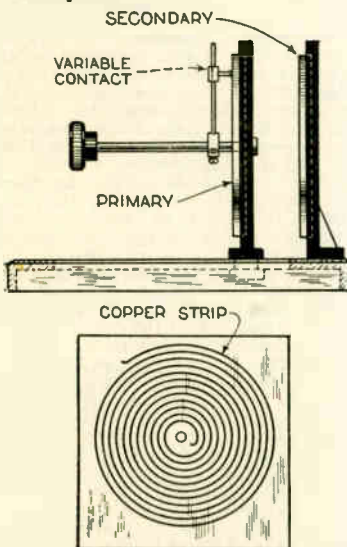

Front and side view of a pancake coil.

**PANCAKE COIL**—A flat inductance coil. Coils of this type are used in radio receiving sets as radio frequency

transformers, also as antenna couplers and oscillator couplers. They may be *basket wound* (q.v.), *spider wound*, etc. In wireless transmitting apparatus, aerial tuning inductances, loading inductances, and oscillation transformers (illustrated) are frequently of the pancake coil type. (See *Inductance*, *Antenna*.)

**PANEL**—A board of insulating material carrying the controlling or measuring devices of an electric circuit. The panel for controlling the charging of storage batteries is called a *charging panel*. A panel carrying generator controls is referred to as a *generator panel*. Where only a single panel is used this is usually called the *switchboard*. The usual switchboard comprises a number of panels. Switchboard panels are commonly made of marble. The usual varieties available are white Italian, pink or grey Tennessee and blue Vermont marbles. Plain slate is sometimes used for panels where the voltage is not too high. When the panels do not require a finish, soapstone is sometimes used. The front of a radio receiving set on which the dials and rheostat controls, etc., are mounted is also called a panel. These panels are usually made of Bakelite, hard rubber, composition or similar insulating substances, although a number of sets are being made with metal panels. The horizontal panel on which the sockets and transformers are usually mounted is known as the *sub-panel* (q.v.).

**PANNILL**, Charles Jackson—American radio pioneer. Born in Petersburg, Virginia, May 13, 1879. He entered the American Navy, 1898. In 1902 he took a post under Professor R. A. Fes-

senden and carried out a series of wireless experiments at Hampton Roads, later inaugurating wireless communication between New York and Philadelphia. Pannill was the first man to install wireless on the battleships of the U. S. Navy. Afterwards he carried out a series of communication experiments between various parts of the United States and erected a number of wireless stations. He joined the Marconi Wireless Telegraph Company in 1912 and became a radio adviser to the United States Government, 1914, and assistant director of Naval Communications, 1916. Pannill is a fellow of the Institute of Radio Engineers and a member of the Washington Society of Engineers.

**PAPER CONDENSER**—A fixed condenser, usually made of tin foil and utilizing a dielectric of paraffin-waxed paper. The 1 microfarad by-pass condenser is a typical example of a paper condenser. (See *Condenser*, *By-pass*.)

**PARALLEL**—See *Parallel Connection*.

**PARALLEL CONNECTION**—Two or more parts of an electrical circuit so connected that the current divides between them. This is also known as a *multiple* (q.v.) connection, *divided circuit*, or *shunt circuit*. Where a number of parts of a circuit are connected in parallel, the same potential is impressed on each part. The current flowing in each branch will depend upon the impressed voltage and the resistance of each branch. (See *Circuit*, *Parallel*.)

**PARALLEL RESISTANCES**—Resistances connected so that their terminals have the same difference of potential between them. The greater the number of resistances in parallel, the less



will be the total resistance of the circuit. If there are three resistances in parallel of  $\frac{1}{2}$ ,  $\frac{1}{3}$  and  $\frac{1}{5}$  ohm, respectively, then the total resistance is equal to the reciprocal (one divided by a number) of the sum of the separate reciprocals. In this case the sum of the reciprocals is 2 plus 3 plus 5 equal to 10 and the reciprocal of this is equal to one-tenth, so that the total resistance of this parallel circuit is one-tenth of an ohm. It can be seen that the total resistance of any circuit having a number of resistances in parallel is less than the resistance of any one of the branches. (See *Circuits Parallel*, also *Parallel Connection*.)

**PARALLEL RESONANCE**—When a concentrated capacity and a concentrated inductance are connected in parallel between terminals to which an alternating electromotive force is applied, and the inductance or capacity or frequency is varied, the condition of parallel resonance exists when the current supplied by the source is a minimum. It should be noted that in series resonance, the total current supplied by the source flows through both the inductance and the capacity whereas in parallel resonance the current supplied by the source is the vectorial sum of the two currents, one flowing through the capacity and one through the inductance.

**PARAMAGNETIC**—Having a permeability greater than unity. Magnetic as opposed to diamagnetic. The term *paramagnetic* is used in some cases to apply to substances which have only a slightly greater permeability than air such as liquid oxygen, the rare metal erbium, etc. If used in this sense it does not include *ferro-magnetic substances* (q.v.). (See *Diamagnetic material*.)

**PARTIAL**—An acoustical term denoting any one of the natural vibrations of which a body is capable. An electrical *oscillator* (q.v.) possessing distributed capacity and inductance has, theoretically, an infinite number of possible frequencies, each of which is called a *partial*. The lowest frequency is called the *fundamental*. (See *Harmonics*, *Harmonic Current*, *Overtone*, also *Overtone Currents*.)

**PARTITION INSULATOR**—An ebonite tube having a metallic rod running through its center with wing nuts at each end. It is used for continuing a circuit through a wall or partition.

**P.D.**—Abbreviation for *potential difference*. (See *Potential*, *Difference of*.)

**PELTIER EFFECT**—The change in temperature, either heating or cooling, at the junction of two unlike metals, depending upon whether an electric current originating from an external electromotive force, is sent through the junction in one direction or the other. The Peltier effect is the opposite of the *thermo-electric effect*.

**PERCENTAGE COUPLING**—The coefficient of coupling between the primary and the secondary of an oscillation transformer in a wireless transmitting system. When the primary winding is placed close to the secondary, the coupling is said to be *close* or *tight*. When the two windings are apart the coupling is said to be *loose*. With the ordinary spark gap in the closed circuit, if the primary and the secondary windings are closely coupled a broad wave will be radiated from the aerial system. If they are loosely coupled, a *sharp* wave will be radiated.

(See *Combination Detector*, also *Crystal Detector*.)

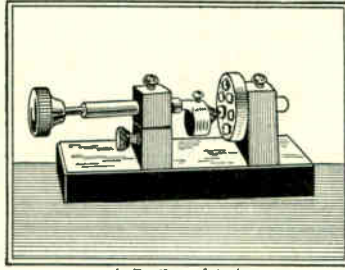

A Perikon detector.

**PERIOD**—The time required for one complete *cycle*. (q.v.) Referring to an *alternating current* (q.v.) it is the time required for the current or electromotive force to pass through the various values from zero to a positive maximum back to zero again, then to a negative maximum and finally to zero.

**PERIODIC**—A vibration is said to be periodic if all the phenomena are repeated regularly at equal intervals of time. This time is called *periodic time* or the *period*.

**PERIODICITY**—A synonym for frequency, or for angular velocity.

**PERMANENT MAGNET**—Hardened steel which when magnetized retains its magnetism after the removal of the magnetizing force. The usual method of making permanent magnets is to place the steel in a powerful electromagnetic field. They can also be made by stroking with another magnet. Permanent magnets are used in all electromagnetically operated headsets and loud speakers. (q.v.) (See *Magnet*, *Electromagnet*, also *Temporary Magnets*.)

**PERMEABILITY**—The *permeance* (q.v.) existing between the opposite faces of a cube of the substance each side of which is one centimeter in length. Since the permeability of air is assumed to be unity, the permeability of any substance is the ratio of the flux that passes through it to the flux that would exist in air if the magnetomotive and flux path remained unchanged.

**PERMEANCE**—That property of a magnetic circuit which allows the flow of magnetic flux. Its reciprocal is *reluctance* (q.v.) which is the property of a magnetic circuit by which it resists the flow of magnetic flux.

**PERMITTANCE**—A synonym for *capacity* (q.v.) or *capacitance* (q.v.). This property is possessed by every electrical circuit, but does not manifest itself unless there is a change in voltage. The greater the permittance of a circuit, the greater will be the opposition offered to a change in voltage.

**PERMITTIVITY**—See *Dielectric Coefficient* and *Constant*, *Inductive Capacity*, also *Inductivity*.

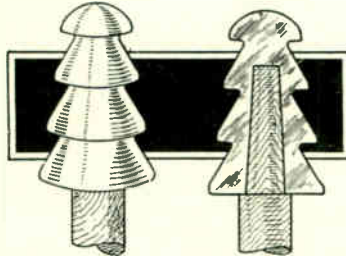

A petticoat insulator. Shown in cross-section at the right.

**PETTICOAT INSULATOR**—An insulator having two or more flanges or

petticoats arranged one on top of the other for the purpose of reducing leakage and preventing accumulation of moisture. Petticoat insulators are usually made of porcelain. Insulators used on low tension lines are also of the petticoat type, in such cases being constructed of glass. (See *High Tension Insulator*, also *Insulator*.)

**PHANTOM AERIAL**—See *Mute antenna*.

**PHASE**—A particular state in a regularly recurring cycle of changes. In simple harmonic motion, uniform circular motion, or in periodic changes of any magnitude varying according to a simple harmonic law (as for example an alternating current) the point or stage in the period to which the rotation, oscillation or variation has advanced, considered in its relation to the position or instant of starting or to some other standard position. This relationship is usually expressed in angular measure. Defined in electrical terms, phase is the distance, usually measured as an angle, of the base of any *ordinate* (q.v.) of an alter-

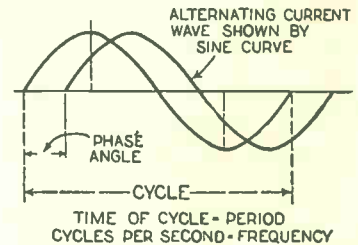

Phase displacement, cycle, etc., illustrated by means of sine curves.

nating wave from any chosen point on the time axis. This distance represents the phase of the ordinate with respect to the point. In any sinusoidal alternating current quantity, the phase at any instant may be shown by the corresponding position of a *vector* (q.v.) revolving about a point with such an angular velocity that its projection at each instant upon a chosen reference line is proportional to the value of the quantity at that instant. As an example, consider a conductor rotating in a magnetic field. The induced electromotive force, in one complete revolution, passes through the following values. It starts at zero and rises to a maximum positive value, then falls to zero and rises to a maximum positive value in the reverse direction, finally falling to zero again. The transitions through these various values constitute a *cycle* (q.v.). The time of this transition is called a *period*, the number of cycles per second being the *frequency* (q.v.). The angle at any instant through which the conductor has rotated since the electromotive force changed its sign from negative to positive is the *phase angle*. This is ordinarily designated by the Greek letter  $\Phi$  (phi). If  $\omega$  (omega) is the angular velocity of the rotating conductor and  $f$  the frequency, then  $\omega = 2\pi f$  (since there are  $2\pi$  radians in a complete revolution). If the time in seconds which has elapsed since the conductor last passed the point of zero electromotive force be represented by  $t$ , then the phase  $\Phi$  at that particular instant is equal to  $\omega t = 2\pi ft$ . Periodic variations are conveniently expressed by sine curves and the relative phases are indicated by the relative positions of the *nodes* (q.v.) and *loops* (q.v.).

## Phase Angle

Magnitudes having maximum and minimum values occurring simultaneously are said to be *in phase*. If they do not occur simultaneously, they are *out of phase*. When the corresponding maximum or minimum values of two sinusoidal alternating quantities of the same frequency occur at different instances, the two quantities are said to differ in phase by the angle between their nearest negative maxima or their nearest positive maxima or any other nearest corresponding values. The quantity whose maximum value occurs first is said to *lead* (q.v.) the other. The quantity whose maximum value occurs later is said to *lag* (q.v.). Where one quantity lags behind another by 180 degrees, the values are said to be of *opposite phase*. An alternating current may be *single phase* or *polyphase*. Another term for polyphase is *multiphase*. In a three-phase alternating current system the three separate currents differ in phase from each other by 120 degrees. In a polyphase system, if the various phases each carry or supply equal current, the system is said to be *balanced*.

**PHASE ANGLE**—See *Phase*.

**PHASE DISPLACEMENT**—The difference in phase or the phase angle between two alternating quantities, such as voltage and current, of the

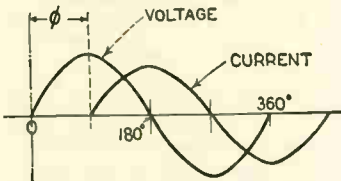

Sine curves of current and voltage, showing difference in phase.

same frequency. Such quantities do not pass through their respective maximum positive quantities or through their zero values at the same time. The instantaneous values of any sine-shaped wave can be represented as being proportional to the sine of an angle, a complete cycle being equal to 360 degrees. When two quantities are out of phase, the respective angles corresponding to each quantity at any given instant are unequal, the difference between the two angles being called the *phase displacement* or the *phase difference*. In the accompanying illustration, the current and voltage relationship in an alternating current circuit are shown by the two sine curves. As can be seen, the current and voltage are out of phase, the phase displacement being equal to the angle

$\Phi$ , in this case 90 degrees ( $\frac{\pi}{2}$  radians).

The current reaches its maximum value at a later time than the voltage. In this case the current *lags* behind the voltage by the angle  $\Phi$ , the voltage leading the current by this angle. Since the angle of lag of the current is 90 degrees, the current and voltage are said to be in *quadrature*. In an alternating current circuit having pure inductance and no resistance (a theoretical circuit, since all electrical conductors possess resistance), the current would lag by 90 degrees as in the example given. (See *Lag, Lead, Leading Current, also Phase*.)

**PHENOMENA OF ELECTRIC WAVE PROPAGATION**—Electric waves are created by electric *oscillations* (q.v.). They are often referred to as *radio waves*. Electric waves, light waves

and radiated heat waves are included in the general term *electromagnetic waves* (q.v.). The velocity of electric waves is the same as that of light waves, 300,000,000 meters per second or 186,000 miles per second (appx.). Electric waves used for radio work have frequencies from about 10,000 to 3,000,000 cycles per second. Since the velocity of electric waves is known, it is possible to calculate the length of a wave if the frequency is known. Thus if the electric wave has a frequency of 10,000 cycles per second, the wavelength is found by dividing the velocity in meters per second by the frequency in cycles per second, which gives in this case a wavelength of 30,000 meters. Electric waves are in reality a combination of electromagnetic and electrostatic disturbances in space. The displacements are at right angles to the motion of the wave train. The electric field and the magnetic field are at right angles and travel together. They spread out or expand from the point of disturbance just as water waves spread out from a point where a stone strikes the surface of the water. Electric waves are propagated from an aerial when certain forms of alternating current flow in the aerial. Since the frequency of the propagated wave corresponds to the frequency of the current in the aerial, high frequency current must flow in the aerial to produce the high frequency electric waves used in radio. Such current may be produced by a high-frequency generator, by a direct current generator and an electric arc, or by means of vacuum tubes. The latter offer the simplest means of producing the rapidly reversing currents. Electric waves may be classified as *continuous* and *discontinuous*. Examples of the former are the waves produced by a high frequency alternator, an oscillating vacuum tube or a Poulsen arc. Examples of the latter are the waves produced by condenser discharges in a spark circuit. In these the amplitude of the waves diminishes in each wave train and the waves are referred to as *damped waves*. The high frequency current used to produce continuous waves used in radio telephony is *modulated* in accordance with the vibrations of a *microphone* (q.v.). As a result modulated waves are sent out from the aerial and these correspond in wave form to the variations of the sound waves. The sensitive apparatus at the distant receiving set picks up or intercepts the modulated electric waves, reconverts them to high frequency electric currents which are rectified into direct currents capable of actuating a 'phone and usually amplified so that they have energy enough to operate a loud speaker. (See *Oscillator, Carrier Wave, also Modulated Currents*.)

**PHILLIPS, Raymond**—British radio expert. Born October 6, 1879, he was educated at Edgebaston, Birmingham Schorne College, Buckinghamshire, and Windsor High School. For three years he was engaged on railway constructions and repairs, with special application to electric railways. In 1902 he invented a system of automatic train control and a number of appliances for electric railways which were widely adopted. In 1905 he took up the study of wireless and specialized in the control of mechanisms at a distance by electric waves. In 1910 he patented a system for controlling airships by radio and by means of a working model demonstrated how an airship could be thus controlled. During the World

War he was inspector of ordnance machinery and in 1921 was appointed a member of the Inter-Allied Commission of Control in Germany. He is the author of many articles on the control of machines by electric waves.

**PHONOGRAPHIC RECORDING**—This refers to the amplifying of code signal currents by means of relays in tandem until the sounds produced in a telephone receiver are loud enough to cut a distinct record on the wax of a phonograph. The signals can be received at high speed and thereafter read at low speed. Instead of a phonograph a telegraphone may be used.

**PHOTO-ELECTRIC EFFECT**—A change in the electrical conductivity of a gaseous or solid substance when radiations of certain wavelengths come in contact with them. This refers particularly to rays of the visible spectrum and ultra-violet and infra-red rays.

**PHOTOGRAPHIC RECORDER**—A device for recording high-speed wireless messages by recording the deflections of a sensitive galvanometer on a moving photographic film. (See *Auto-Receiver*.)

**PICKARD, Greenleaf Whittier**—American radio expert. He was born at Portland, Maine, on February 14, 1877, and was educated at Westbrook Seminary, Lawrence Scientific School, Harvard and Massachusetts Institute of Technology. He made a special study of wireless telegraphy and telephony



Greenleaf Whittier Pickard.

and has taken out many United States and foreign patents for radio inventions. He is noted for his pioneer work in radio telephony. Pickard began radio work in 1899 at Blue Hill observatory, Milton, Massachusetts, under a grant from the Smithsonian Institute. He was on the engineering staff of the American Telephone and Telegraph Company from 1902 to 1906. Later he was connected with the Wireless Specialty Apparatus Company as consulting engineer. He has an extensive practice as a patent expert in radio patent litigation. Pickard is a fellow of the American Institute of Electrical Engineers, a Member of the American Chemical Society and also is a Member of the Society of Chemical Industry.

**PIG-TAIL**—A flexible braided or

also used on the carbon brushes of motors and generators. (See *Flexible Lead*.)

**PITCH**—Frequency of vibration of a sound. A shrill note is said to be of high pitch, a bass note of low pitch. The pitch of an armature winding refers to the distance from the center of a winding to the center of the next winding.

**PLAIN AERIAL**—An aerial having the transmitting or receiving circuit connected directly to it without the utilization of inductive coupling or any intermediate tuned circuit. An example of a plain aerial is one used to transmit code, having a spark gap in series with the aerial and the ground.

**PLATE**—The anode or positive electrode of a vacuum tube. The vacuum tube plate is usually made of nickel. The shape of the plate varies according to the type and construction of the tube. In some tubes the plate is tubular; in others flat. When the cathode or filament is heated, it emits electrons which pass to the grid or through the grid to the plate, depending upon the grid charge. In power tubes (transmitting) it is necessary to use some cooling device to conduct away the heat dissipated at the plate. In some cases a liquid bath or a blast of air is used

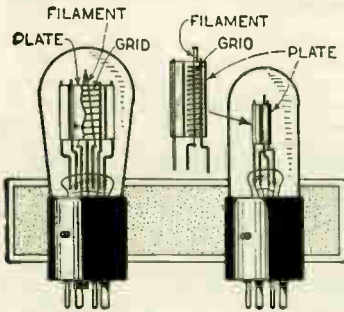

Vacuum tubes, showing construction of plates.

or the plate may be constructed so that it can be cooled by water circulation. Other methods of preventing overheating of these tubes are increasing the area of the plate as for example increasing the diameter of a tubular plate, or blackening the surface of the plate to increase its heat emissivity.

**PLATE BATTERY**—A battery, usually referred to as the "B" Battery having its positive terminal connected to the plate of the three-electrode vacuum tube and its negative terminal leading to the filament. The purpose of this battery is to keep the plate voltage positive with respect to the filament so that the electrons will be attracted sufficiently to the plate. Plate batteries are usually dry cells although there are a number of storage plate or "B" batteries on the market, both of the acid and the alkaline types. It is possible to dispense with the plate battery by using a "B" eliminator, which is connected to the ordinary house-lighting circuit. (See "B" Battery.)

**PLATE CIRCUIT**—The circuit connected to the plate (q.v.) or anode of a three-electrode vacuum tube.

**PLATE COMPONENT, HIGH FREQUENCY**—The radio frequency current flowing in the plate circuit (q.v.) of a vacuum tube. (See *High Frequency Component of Plate*.)

**PLATE CONSUMPTION**—This refers to the current consumed in energizing the plate of a vacuum tube. Increasing

the grid voltage tends to increase the plate consumption. An increasing plate voltage also increases the plate current, but tends to decrease the relatively small grid current. (See *Consumption, Current*; also *Consumption, Plate*.)

**PLATE CONTROL**—The vacuum tube starts oscillating at a plate voltage which will depend on the adjustments of the circuit. When the plate voltage is raised, the oscillation current becomes greater, increasing in direct proportion.

**PLATE CURRENT**—The current in the plate circuit (q.v.) of the three-electrode vacuum tube. The current passing between the plate and the heated cathode or filament.

**PLATE IMPEDANCE**—The total resistance offered to alternating current between the filament and the plate in a vacuum tube. It is often referred to as the *tube impedance*. The impedance is independent of the alternating current input voltage.

**PLATE VOLTAGE**—The voltage of the plate of a vacuum tube above the filament. The potential difference between the plate and the filament. This term is usually used to refer to the voltage of the "B" battery (q.v.) connected to the plate, as for example, if the 22½-volt terminal of the "B" battery is connected to the plate of the detector tube, the plate voltage is said to be 22½ volts. Soft tubes, formerly used as detectors, operated best at this voltage. Most of the amplifier tubes now used as detectors operate best with 45 volts on the plate, although these tubes vary individually, some operating better with slightly increased voltage and others with a voltage less than 45. The plate voltage generally used on the amplifiers is 90 volts. The new power reception tubes use plate voltages up to 135 volts.

**PLIODYNATRON**—A special vacuum tube, designed by A. W. Hull, having two grids instead of one. This tube utilizes the normal amplifying property of the vacuum tube to obtain a very high voltage amplification, as high as 1,000 fold. When such high amplification is obtained, however, the operation is unstable and extremely careful adjustment is necessary.

**PLIOTRON**—A name given to a highly evacuated vacuum tube used for transmitting purposes. Large pliotrons are capable of developing as high as 500 watts output since they are so highly exhausted that several thousand volts may be applied to the plate and also since they can carry a plate current of nearly one-half an ampere.

**PLUG**—A connecting device used extensively in radio and telephone work for making connection or "plugging in" loud speakers (q.v.), head sets, power supply, microphone transmit-



Cross-section of plug.

ters, etc. The plug has an insulating handle and the metal contact tip is designed to fit into a standard jack (q.v.). A flexible wire fits into terminals in the plug, the other end of the wire being connected to the apparatus such as the loud speaker, etc. The plug connection terminals may be of the conventional small binding post type or they may consist of internal spring clips.

**PLUG-IN COIL**—An interchangeable coil, often of the honey-comb type, which can be plugged into a socket, thus permitting it to be quickly and conveniently put into or taken out of a circuit. Plug-in coils are used in some cases in receiving sets designed for operation on widely varying wave bands.

**PLUG-IN TRANSFORMER**—A plug-in coil (q.v.) specifically used as a radio frequency transformer.

**POLARITY**—In magnets the differentiation between *North Pole* and *South Pole*. In electrical devices or circuits, the difference between *positive* and *negative poles*. It is often necessary to determine which is the positive pole or terminal of a direct current circuit, and which the negative. There are various methods of indicating polarity. A voltmeter or an ammeter will show the direction of current flow. An extremely simple method of determining polarity is to place the two terminals in a glass jar containing salt water or some other electrolyte. A much greater number of bubbles will be observed to collect around the terminal of negative polarity. A piece of used blue print paper can be utilized to indicate polarity. It is simply necessary to moisten the paper and place the terminals on it, at a distance of about ¼ of an inch apart. The paper will be whitened at the negative terminal.

**POLARIZATION**—In a primary cell, the current liberates hydrogen from the electrolyte in passing through it. The hydrogen is carried to the negative plate with the current and collects there. It thus increases the internal resistance of the cell. This makes it harder for the current to pass through it and as a result the electromotive force available at the terminals is materially lowered. In addition there is a slight difference of potential between the negative plate and the hydrogen and this acts in opposition to the electromotive force of the cell. This further reduces the effective voltage of the cell. The entire effect is known as polarization. Polarization may be carried to such an extent that current can no longer flow from the cell. It may be counteracted or prevented by the use of *depolarizers* (q.v.). There are three different kinds of depolarizers. Chemical depolarizers are placed in the cell near the cathode. Substances such as manganese dioxide, potassium bichromate, nitric acid or cuprous chloride are used. When the hydrogen reaches the depolarizer it combines with it to form a new compound. Electrochemical depolarizers depend for their action upon the use of a substance which will liberate a metal such as copper at the cathode instead of hydrogen. Thus with no hydrogen present there is no polarization. Of course it is necessary to use the proper electrodes and the correct electrolyte to obtain this result. Mechanical depolarizers merely blow or sweep the hydrogen away from the cathode. Being the least effective of the three methods, the latter is seldom used. (See *Local Action*.)

**POLARIZATION, ELECTRIC**—The state of a dielectric when subjected to electrostatic forces. Electric polarization is synonymous with electric displacement.

**POLARIZED RELAY**—A relay in which a magnetized swinging arm is placed between poles of two electromagnets. When current passes, one pole must change, so that the arm is attracted by one and repelled by the

**Poles**

other. A polarized relay is much more sensitive to weak currents than the ordinary relay.

**POLES**—See *Magnetic Poles*.

**POLYPHASE**—Referring to an alternating current system in which the circuits are divided up into two or more branches having their currents displaced in phase from each other. The term *multiphase* has the same meaning as polyphase. (See *Phase*.)

**POLYPHASE ALTERNATOR**—An alternating current generator wound in such a way that it supplies two or more currents which differ in phase (q.v.) from each other by definite phase angles. The usual form of polyphase alternator is the three-phase alternator.

**PORCELAIN CLEAT**—See *Cleat*.

**POSITIVE ELECTRODE**—In a primary cell, the zinc plate or *anode* (q.v.) is the *positive electrode*, while the *pole* of this electrode is the *negative pole* (q.v.) because it is negative in relation to the external circuit. In a storage cell, the lead peroxide plate, which is the cathode during discharge, is called the *positive electrode* and its *pole* the *positive pole*.

**POSITIVE TERMINAL POLE**—The pole or terminal out of which current is considered to flow. This is more or less of a handy convention, but is contrary to the present day knowledge of electrical flow inasmuch as electrons move from negative to positive.

**POTENTIAL**—See *Potential, Electric*.

**POTENTIAL, DIFFERENCE OF**—abbreviation P.D.—Difference of electrical level. Theoretically the potential difference between two points in an electric field is measured by the work done by the electric field on a unit point charge of positive electricity moved from one point to another without disturbing the field. Potential difference is measured in volts. It may refer to any two points in a circuit, even though there is no source of electromotive force between these points. When applied to circuit between two points not possessing a source of electromotive force, the potential difference between the two points under consideration is equal to the product of the current flowing times the resistance of the circuit between the two points. In the case of an open circuit, such as the terminals of a cell, the potential difference is equal to the electromotive force. (See *Potential, Electromotive force*, also *Volt*.)

**POTENTIAL DROP**—The fall in voltage in a circuit due to the resistance of the conductor. (See *Potential, Electric*; also *Potential, Difference of*.)

**POTENTIAL, ELECTRIC**—Electrical pressure, or the degree of *electromotive force* (q.v.). Potential is electrical level. Electrical potential can be compared with the "head" of water. Thus it is customary to measure the height or head of water above sea level, which is taken as an arbitrary base. In a somewhat similar manner, the potential of the earth is taken as zero and all potential is measured from this as an arbitrary base. With this understood, it is no longer necessary to refer to the degree of electromotive force, but simply to the electromotive force or the potential. (See *Potential, Difference of*, also *Volt*.)

**POTENTIAL ENERGY**—Energy of position. When energy is available for the production of work, it is referred to as potential energy. Energy at work is *kinetic energy* (q.v.).

**POTENTIAL RECTIFIER**—A *crystal* (q.v.) or other form of rectifier which requires an initial current to pass through it to become sensitive.

**POTENTIOMETER (Potential Divider)**—A resistance connected across a bat-

at Fig. 1. Potentiometers used in radio apparatus are usually made either from high resistance wire or from carbon granules. In electrical engineering work, the term potentiometer means, in general, an arrangement of

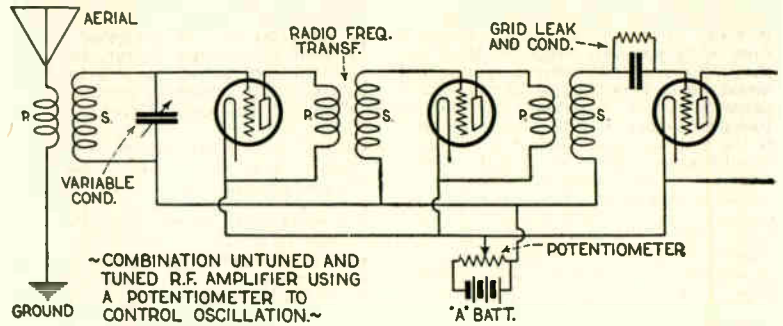

Fig. 1. Tuned radio frequency circuit showing use of potentiometer to control oscillations.

tery or other source of electromotive force and equipped with a slider so that the voltage on another circuit may be varied from zero to the full potential of the battery. Where a gas content detector vacuum tube is used, the purpose of the potentiometer is to permit a close adjustment of the plate battery (q.v.) potential. The potenti-

circuits for measuring potential difference.

Using certain accessories, laboratory potentiometers can be used to measure voltages over all ranges, and by applying's *Ohm's law* (q.v.) the measurements obtained can be used to determine a wide range of current values.

The simplest form of potentiometer used for electrical measurements is shown in Fig. 2. AC is a resistance in which a constant current from the battery B is flowing. F is a regulating resistance used to compensate for the variations of the electromotive force of the battery. The current in AC is checked for constancy by noting that the drop in potential between the two points selected in it is equal to the electromotive force of a standard cell. The standard cell is connected in the circuit GHJ at J and the regulating resistance is adjusted until the sensitive galvanometer shows no deflection. With the assumption that AC has a uniform resistance throughout its length, and the current in it remaining constant, it is obvious that any other voltage not greater than the drop between A and C can be measured by connecting it in the circuit at J and shifting the points G and H until the galvanometer again comes to a balance.

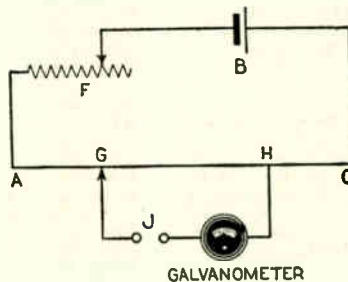

Fig. 2. A simple form of potentiometer used for electrical measurements.

meter is shunted around the filament heating or "A" battery, its resistance being so high that its power consumption is practically negligible. In tuned

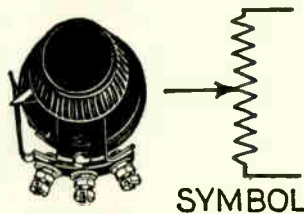

Illustration of a radio potentiometer, showing symbol at the right.

radio frequency sets, a potentiometer is used to control the tube oscillation. The advantage of being able to make a system oscillate is obvious, as the greatest amplification is obtained when the circuits are operated just at the point before self-oscillation starts. This condition is easily found in operation, since the instant self-oscillation starts, a whistle is heard in the phone or loud speaker when tuning to any station it is desired to receive. The use of a potentiometer to control oscillations in a tuned radio frequency circuit is illustrated in the diagram shown

A direct reading scale may be placed between A and C. For ordinary potentiometer measurements, the drop between A and C is made about 1½ volts as this is approximately the electromotive force of a standard Clark cell.

**POULSEN ARC**—An arc usually burned in hydrogen between a rotating carbon cathode and a water-cooled copper anode in a magnetic field. This arc is connected to an oscillating circuit, and due to its instability it maintains continuous oscillations which are utilized for the production of continuous waves for radio telegraphy and telephony.

**POULSEN, Valdemar**—Danish radio pioneer. Born in Copenhagen, November 23, 1869; he was educated at Copenhagen University and in 1893 he joined the Copenhagen Telephone Company. In 1903 he invented his famous system of arc transmission. Poulsen is a fellow of the Danish Society of Sciences. In 1900 he was awarded the Grand Prix at Paris.

**POUNDAL**—A unit of force. That force which acting on a mass of one pound gives it a velocity of one foot per second. It is equal to the weight of a pound mass divided by the acceleration of gravity; equal to 13,825 dynes or approximately half an ounce.

**POWER**—The rate of doing work. A certain amount of work may be done in a day or in a week. In the former case, more power is expended than in the latter case. Mechanical power is measured in *horse power* (q.v.). One horse power is equivalent to 33,000 foot-pounds per minute. Since power is the rate of doing work, the expression for power must contain a time element and a work element. Work is a measure of a force exerted through a distance. Hence the foot-pound measures work. Electrical power is the product of voltage times amperage. It is measured in *watts* (q.v.). (See *Kilowatt*.)

**POWER AMPLIFIER**—See *Power Amplification*.

**POWER AMPLIFICATION**—Amplification by means of apparatus consisting of a combination of power vacuum tubes, designed to carry larger currents than the ordinary tubes and specially designed transformers. Power amplifiers provide additional audio

**CIENT**—The ratio of the output power to the grid input power of a vacuum tube. This value may be as high as 10,000. The output power of a vacuum tube comes from the plate battery. When the grid is operated at low or negative voltage, the input power needed to produce the changes in grid voltage may be made very small compared with the output power of the tube.

**POWER, APPARENT**—The product of the voltage and the current in an alternating current circuit expressed in volt-amperes. This expression does not take into account any difference in *phase* (q.v.) between the voltage and the current. Thus in an extreme case (theoretical) where an alternating current flows in a purely inductive circuit, the current will lag behind the voltage by a phase angle of 90 degrees. In such a circuit, the *true power* (q.v.) would be zero, since the cosine of the phase angle between the current and the voltage would be zero, whereas the apparent power might be quite high and a heavy current might be flowing in the circuit. Apparent power is ordinarily expressed in *kilovolt-amperes* (q.v.). (See *Power Factor*.)

**POWER FACTOR**—The ratio of the *true power* (watts) in an alternating current circuit to the *apparent power* (volt-amperes). Where the wave form of the alternating current is sinusoidal, the power factor is equal to the cosine of the angle between the voltage and the current. Expressed as an equation, power  $P$  is equal to the product of the current  $I$  and the component of the impressed electromotive force which is in phase with the current,  $E \cos \phi$ , where  $\phi$  is the angle of phase displacement between the current and the voltage ( $P = IE \cos \phi$ ). Expressed in another way, the power factor is the fractional amount which, if multiplied by the effective values of the current and the voltage, will give the value of the power expended. (See *Effective Electromotive force*,

*Power, Apparent*, also *Power, True*; *Kilovolt-ampere*, *Kilowatt*.)

**POWER, TRUE**—The product of the *apparent power* and the *power factor* (q.v.) in an alternating current circuit. A wattmeter will measure true power, inasmuch as it takes into account the *phase displacement* (q.v.) between the current and the voltage. A voltmeter and an ammeter cannot be used to measure power, however, since the product of the two readings only gives the apparent power.

**POWER TUBE**—See *Vacuum Tube, Power*.

**PRACTICAL UNITS**—In the practical system of electrical units, the ohm, the ampere and the volt are the fundamental units. While the practical system is based originally on the Centimeter Gram Second systems, it is in no way dependent upon these systems for practical use. When used with the fundamental units of length and time, all other electrical as well as magnetic units can be derived from the fundamental units of the practical system. At the recommendation of the Chicago International Electrical Congress in 1893, the fundamental electrical units of the practical system were adopted as legal units in the United States by an act of Congress, July 12, 1894.

**P R B**—International Radiotelegraphic Convention abbreviation. Followed by question mark it means, "Do you wish to communicate by means of the International Signal Code?" Without the question mark it means, "I wish to communicate by means of the International Signal Code." (See *Abbreviations, International Radio Telegraphic Conventional*.)

**PRESSURE**—See *Potential, Electric*.

**PRESSURE, ELECTRICAL**—The term is synonymous with *voltage* (q.v.) or *electromotive force* (q.v.). Electrical pressure is the cause of current flow. It is measured in *volts* (q.v.). The flow of electricity along a conductor is analogous to the flow of water through a pipe. In order to make water flow, a pump is often used to force the water or in other words to apply pressure. Similarly, electrical pressure must be applied in order for an electric current to flow.

**PRIMARY CELL**—A device for transforming chemical energy into electrical energy. It consists of two different conductors placed in a liquid which acts chemically on one conductor, or more on one conductor than on the other, thus keeping a difference of potential between them. While the cell is being discharged either one or both of the conductors is used up and the liquid is also consumed. In many types of primary cells these can be replaced. The liquid is called an *electrolyte* (q.v.). In some cases an acid is used while in others a salt solution is the *electrolyte*. (q.v.) (See *Cell, Cell Secondary; Cell, Theory of Primary; Electrolysis, Local Action, Polarization, also Storage Cells*.)

**PRIMARY CIRCUIT**—A circuit supplying current to another which is called the secondary circuit. The two circuits are usually coupled by means of a transformer, the primary winding being in the primary circuit and the secondary winding being in the secondary circuit.

**PRIMARY CURRENT**—See *Current, Primary*.

**PRIMARY ELECTRONS**—The main stream of electrons given off by the hot filament of a vacuum tube, as differentiated from *secondary electrons* (q.v.) which may be detached from the plate by the impact of the primary

electrons. (See *Negative Resistance*.)

**PRIMARY TUNING INDUCTANCE**—A variable inductance in the primary circuit of a radio transmitter. It is also referred to as the *aerial tuning inductance*. The aerial inductance coil may be continuously variable utilizing a sliding contact which bears on an edgewise copper strip or it may be of the drum type, in this case being made of stranded copper cable. (See *Inductance Coils*, also *Pancake Coils*.)

**PRINCE, Charles Edmond**—British radio expert. Born in 1874 at Cape Town and educated at Clifton and Faraday House, he joined the Marconi Wireless Telegraph Company in 1907, where he was concerned chiefly in research work on wireless telephony. In 1909 he carried out experiments in Italy and Switzerland with the first Marconi Field Station and made a number of valuable improvements in the Bellini-Tosi direction finder. In the World war, he joined the Royal Flying Corps and in 1915 he installed the first radio telephone on aircraft.

**PRINTER, MORSE**—See *Morse Inkler*.

**PROTON**—A unit of positive electricity. The smallest quantity of positive electricity capable of existing in a free state. A minute particle or quantity of positive electricity carried by the nucleus of a hydrogen atom. See *Electron Theory*, also *Free Electrons*.

**PULSATING CURRENT**—A periodic current, that is to say a current passing through the successive equal cycles of values, the average value of which is not zero. A pulsating current is the sum of an alternating and a direct current. A current which varies regularly in magnitude is said to be pulsating while if it remains the same in magnitude it is called continuous. (See *Continuous Direct Current*, also *Current, Pulsating Direct*.)

**PULSATING DIRECT CURRENT**—See *Pulsating Current*.

**PUPIN, Michael**—American radio authority. Born in Hungary, October 4th, 1858, he came to the United States at the age of 10, and was educated at Columbia University. He also studied at Cambridge University, England. In 1891 he was appointed professor of



Michael Pupin.

mathematical physics at Columbia University, where he carried out an important series of researches in radio telegraphy and telephony. He is the holder of a large number of patents relating to telephony and radio, has done valuable research work on reso-

## Push-Pull Amplification

nance and has developed radior circuits of extreme selectivity.

**PUSH-PULL AMPLIFICATION**—A method of connection in a vacuum tube receiving set, for supplying more power to the loud speaker than that ordinarily obtainable from a one or two stage audio amplifier. In the push-pull amplifier two tubes are used in the final stage of the amplifier, connected in such a way that they are used alternately on the two halves of

are usually used for the other two transformers. These have connections brought out from the center point of one of the windings as shown. The transformer between the two stages has a split secondary while the last transformer has a split primary. In cases where a tapped wound transformer is not available, two transformers can be used instead. In this case the two primary windings are connected in series and the two secondary windings are also connected in

one tube during one half of the cycle and the other tube during the other half of the cycle. While the terminal of the secondary transformer winding leading to the grid of the tube is at a positive potential with respect to the middle of the winding, the tube is effective. During the remaining half of the cycle when the terminal is negative with respect to the tap, the tube is not

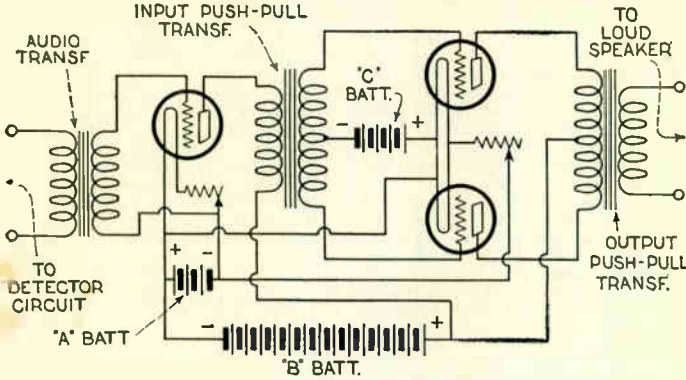

Fig. 1. Diagram of a push-pull amplification circuit.

each audio frequency cycle. A push-pull amplification circuit is shown in Figure 1. The first tube at the left gives the first stage of amplification and the other two in combination give the second stage. An ordinary audio frequency amplifier transformer is connected to the grid and filament of the first tube. Special transformers

series. Figure 2 shows the method of connecting two transformers for this purpose, a connection being made to the mid-point between the secondary windings. It is essential that the two windings in series be connected so that they are continuous in the same direction around the transformer cores. In theory, the push-pull amplifier uses

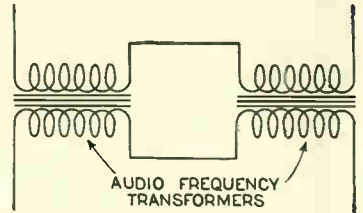
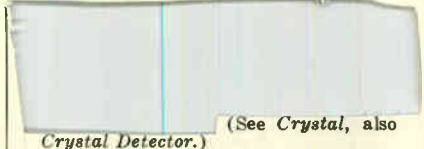

Fig. 2. Method of connecting two transformers where a tapped wound transformer is not available.

operating. The action however is such that one tube is effective at all times. Although ordinary amplifier tubes can be used in the push-pull amplifier circuit it is desirable to use special power tubes which have a high amplification coefficient.



(See *Crystal*, also *Crystal Detector*.)  
**PYRON DETECTOR**—A crystal detector (q.v.) having an iron pyrites crystal and a copper or other metallic contact point.

## Q

**Q SIGNALS**—International Radiotelegraphic Convention abbreviations. When the signal is followed by a question mark it asks the question. Otherwise the answer is indicated. A list of these abbreviations and their meanings follow:

Abbreviation	Question	Answer
QRA	What ship or coast station is that?	This is . . . . .
QRB	What is your distance?	My distance is . . . .
QRC	What is your true bearing?	My true bearing is . . . degrees.
QRD	Where are you bound for?	I am bound for . . . .
QRF	Where are you bound from?	I am bound from . . . .
QRG	What line do you belong to?	I belong to the . . . Line.
QRH	What is your wave length in meters?	My wave length is . . . meters.
QRHH	What tune shall I adjust for?	Adjust to receive on tune . . . .
QRJ	How many words have you to send?	I have . . . words to send.
QRK	How do you receive me?	I am receiving well.
QRL	Are you receiving badly? Shall I send 20 . . . — . for adjustment?	I am receiving badly. Please send 20 . . . — . for adjustment.
QRLI	Request permission to test . . . minutes.	Permission to test granted.
QRM	Are you being interfered with?	I am being interfered with.
QRN	Are the atmospherics strong?	Atmospherics are very strong.
QRO	Shall I increase power?	Increase power.
QRP	Shall I decrease power?	Decrease power.
QRQ	Shall I send faster?	Send faster.
QRS	Shall I send slower?	Send slower.
QRT	Shall I stop sending?	Stop sending.
QRU		{ I have nothing to transmit.
QRV	Are you ready?	{ I have nothing for you.
QRW	Are you busy?	I am ready. All right now.
		I am busy (or, I am busy with . . . . Please do not interfere).
QRX	Shall I stand by?	Stand by. I will call you when required.
QRY	When will be my turn?	Your turn will be No. . . . .
QRZ	Are my signals weak?	Your signals are weak.
QSA	Are my signals strong?	Your signals are strong.
QSB	Is my tone bad? Is my spark bad?	The tone is bad. The spark is bad.
QSC	Is my spacing bad?	Your spacing is bad.
QSD	What is your time?	My time is . . . . .
QSF	Is transmission to be in alternate order or in series?	Transmission will be in alternate order.
QSG		Transmission will be in a series of 5 messages.
QSH		Transmission will be in a series of 10 messages.
QSJ	What rate shall I collect for?	Collect . . . . .

Abbrev'n	Question	Answer
QSK	Is the last radiogram cancelled?	The last radiogram is cancelled.
QSL	Did you get my receipt?	Please acknowledge.
QSM	What is your true course?	My true course is . . . . . degrees.
QSN	Are you in communication with land?	I am not in communication with land.
QSO	Are you in communication with any ship or station (or: with . . . . .)?	I am in communication with . . . . . (through . . . . .)
QSP	Shall I inform . . . . . that you are calling him?	Inform . . . . . that I am calling him.
QSQ	Is . . . . . calling me?	You are being called by . . . . .
QSR	Will you forward the radiogram?	I will forward the radiogram.
QSS	Are my signals fading?	Your signals are fading.
QST	Have you received the general call?	General call to all stations.
QSU	Please call me when you have finished (or: at . . o'clock).	Will call when I have finished.
QSV	Is public correspondence being handled?	Public correspondence is being handled. Please do not interfere.
QSW	Shall I increase my spark frequency?	Increase your spark frequency.
QSX	Shall I decrease my spark frequency?	Decrease your spark frequency.
QSY	Shall I send on a wave length of . . . . . meters.	Let us change to a wave length of . . . . . meters.
QSZ		Send each word twice. I have difficulty in receiving you.
QTA		Repeat the last radiogram.
QTC	Have you anything to transmit?	I have something to transmit. I have one or more radiograms for . . . . .
QTE	What is my true bearing?	Your true bearing is . . . . . degrees from . . . . .
QTF	What is my true position?	Your true position is . . latitude . . . . . longitude.

**QUADRANT**—A term formerly in use as the unit of *inductance* (q.v.), now called the *henry* (q.v.). Inductance has the same dimensions as length and this unit is equivalent to 10<sup>9</sup> cm., this being approximately the length of one quadrant of the earth.

**QUADRANT ELECTROMETER**—A sensitive *electrometer* (q.v.) which in its calibrated form is known as an *electrostatic voltmeter* (q.v.). In the usual type, the "needle" consists of a thin aluminum plate suspended on delicate knife edges, with a pointer extending from the upper part to a scale. Two pairs of quadrant plates, having opposite faces metallically connected together, are placed on either side of the movable plate and parallel to its face. Each pair is insulated from the other pair. When the pairs of quadrants are subjected to a difference of potential, the needle, if highly charged, will be attracted into one pair or repelled out of the other. (See *Kelvin's Electrostatic Voltmeter*.)

**QUADRATURE**—The differing in *phase* (q.v.) of two alternating current quantities by 90 degrees. For example, when the current lags behind the impressed voltage by 90 degrees, as in the case of pure inductance in a circuit, the current and the voltage are said to be in quadrature. (See *Log, Lead, also Leading Current*.)

**QUANTITY OF ELECTRICITY**—When referring to static electricity, it is the amount of the charge. Referring to electricity in motion, or an electric current, it is the amount of current flowing in a given time. Quantity of electricity is measured in *coulombs* (q.v.). The coulomb is the quantity of electricity which has passed when a current of one ampere flows for one second. The symbol which is usually used to signify quantity of electricity is *Q*.

**QUANTOMETER**—A type of ballistic galvanometer in which the swing of the movable system is proportional to the quantity of electricity passing through the instrument. A *galvanometer* (q.v.) of this type is used for magnetic testing as in the case of the *fluxmeter* (q.v.).

**QUARTER PHASE**—A two-phase alternating current system. An alternating current system having two currents differing in phase by 90 degrees or in other words by one-quarter of a cycle.

**QUARTZ LAMP**—A mercury vapor lamp which utilizes a tube of quartz

instead of a glass container. Increased current densities can then be employed, since higher temperatures can be used with quartz than with glass.

**QUARTZ OSCILLATOR**—The piezoelectric quartz plate may be used as a *resonator* (q.v.) or as an *oscillator* (q.v.). When used as an oscillator it may be used either as a *master oscillator* controlling the frequency of a radio transmitting station's output or as a frequency indicator. All three of these uses are applicable to the work of maintaining station frequencies constant. The applicability of the piezo oscillator as a frequency indicator in broadcasting stations has been tested carefully by the United States Bureau of Standards, and found to be useful and satisfactory. This method gives a means of maintaining an extremely accurate check of the transmitting station frequency. (See *Master-Oscillator System, also Frequency Meter*.)

**QUENCHED GAP**—See *Quenched Spark Gap*.

**QUENCHED SPARK**—See *Quenched Spark Gap*.

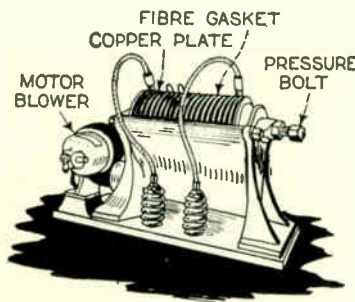

A typical quenched spark plug.

**QUENCHED SPARK GAP**—A spark discharger in a wireless telegraph transmitting circuit in which the spark is deionized to prevent the gap remaining conductive after the spark has passed. In this way only a few sharply defined oscillations are permitted to occur. The particular advantages of the quenched spark gap is that it enables the aerial to oscillate at its own frequency regardless of the period of the spark system. In one form of construction, a number of heavy copper plates are used, separated by micanite, fiber insulating washers

or other insulating material. These are placed in an iron rack and compressed by means of a pressure bolt. The inside edge of the washer rests upon a groove which is cut in each plate. This makes it impossible for the spark to discharge over the edge of the washer. In order to make the discharge surface airtight, the washers are specially treated and as a result this helps in quenching the primary oscillations and makes the discharge noiseless. A small motor driven blower is mounted at the base of the spark discharger for the purpose of forcing air through the base of the rack against the cooling flanges of the plates. (See *Deionization, Musical Spark, Kinraid Spark Gap, also Quenched Spark Transmitter*.)

**QUENCHED SPARK TRANSMITTER**

—A radio telegraph transmitter which employs a quenched spark gap. The quenched spark transmitter is not used for very high powers as it is not satisfactory for such use. In this case, a form of disc discharger is usually used. The quenched spark transmitter, however, has no moving parts and is noiseless in operation. In addition it gives large values of antenna current because closer coupling is possible. (See *Quenched Spark Gap*.)

**QUICK BREAK SWITCH**—A switch provided with auxiliary contacts which are released after the main contacts. The auxiliary contacts are separated rapidly, regardless of the speed with which the switch handle is pulled. This action is obtained by the tension of a spring connected between the main

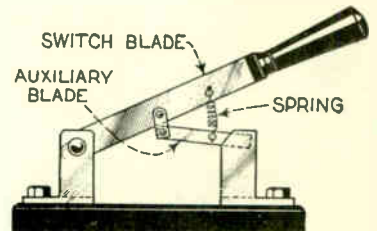

Quick Break Switch. Note the auxiliary spring-controlled blade.

switch blade and the auxiliary blade, as shown in the illustration.

**QUIESCENT AERIAL**—In a radio telephone transmitter, an aerial operated in such a manner that the carrier wave is suppressed when transmission is not actually taking place.

# R

"R"—Symbol for *resistance* (q.v.)

**RADIANT ENERGY**—Energy transmitted through space by means of vibrations of the ether, such as electromagnetic energy, light or heat. (See *Actinic Ray*.)

**RADIANT HEAT**—Infra-red radiation (q.v.) as for example radiation from substances at temperatures insufficient to cause visible light rays.

**RADIATING CIRCUIT**—An electrical circuit which emits energy in the form of ether waves. In a transmitting system, the aerial circuit. Any circuit which radiates energy is a radiating circuit.

**RADIATION**—The transference of energy in waves through space which is not necessarily occupied by matter. Transference of energy through ether (q.v.). Electric or electromagnetic radiation refers to the radiation by means of electromagnetic induction. The radiation field is transmitted by wave motion. Various types of electromagnetic waves may be sent out by a radiating system. In one system the waves are known as *damped waves* (q.v.), in another *undamped waves* (q.v.) are used.

**RADIATION EFFICIENCY**—The radiation efficiency of an antenna at a given wave length is the ratio of the power radiated to the total power delivered to the antenna (resistance).

**RADIATION FROM ANTENNA**—In the case of a simple vertical antenna, electromagnetic waves are radiated in semi-loops since the lower end of the aerial is grounded. Fig. 1 gives an

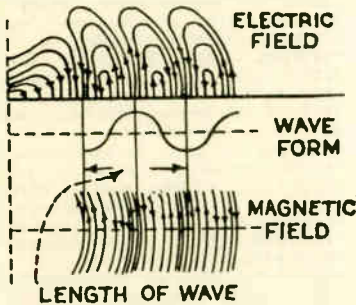

Fig. 1. Electric and magnetic fields about a vertical wire aerial.

idea of the way in which the intertwined electric and magnetic fields radiate from the antenna. It should be noted that the electric and the mag-

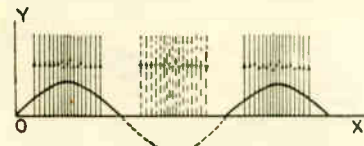

Fig. 2. Electric lines of force shown after the wave has travelled some distance from the aerial.

netic fields are in planes which are at right angles to each other. The electric lines are shown in elevation while the magnetic lines appear in plan, with the wave form common to both being shown between. At any single point in space, the lines separate and come together like a bellows. After the wave has travelled a certain distance, the lines can be regarded as

sections of planes and the electric lines can be represented by the diagram shown in Fig. 2. The magnetic lines can be shown by the same figure, provided this is considered to have been rotated about its horizontal axis through an angle of 90 degrees. Regardless of whether the aerial is of the open or closed coil type, the radiation will take place in the same general way, *loops* (q.v.) being formed and detached as described. (See *Electromagnetic Waves*, also *Height of Aerial*.)

**RADIATION RESISTANCE**—The ratio of the total power radiated by an antenna to the square of the effective current at the point of maximum current. The property of an antenna by means of which radiation of energy takes place. Some of the power supplied to a circuit, carrying radio currents, is radiated in the form of electric waves. The radiation is a measure of the useful work obtained from the circuit. The greater the power radiated in comparison with the power dissipated in the circuit itself, the better will be the transmission. At any frequency, the power radiated is proportional to the square of the current flowing, hence the radiative effect may be regarded as causing artificially, an increase in the effective resistance of the circuit. This resistance increase is known as "radiation resistance" and is directly proportional to the square of the frequency or inversely proportional to the square of the wave length. (See *Antenna Resistance*.)

**RADIATION TRANSMISSION**—See *Radiation from Antenna*.

**RADIO**—The transmission of intelligence by means of electromagnetic waves through the ether. Radio falls under two general classifications; *radio telephony* (q.v.) and *radio telegraphy* (q.v.). (See *Radio Channel*, *Radio Communication*, *Radio Control*, also *Radio Frequencies*.)

**RADIO-ACTIVITY**—The emanation of energy by certain substances, such as radium, caused by a continuous detachment of electrons from the substance.

**RADIOCAST**—A term sometimes used instead of *Broadcast* (q.v.). To transmit speech, music or other sounds by *radio telephony* (q.v.).

**RADIO CHANNEL**—A band of wave lengths or frequencies of a width sufficient to permit of its use for radio communication without the radiation of subsidiary waves of more than a certain intensity at wave lengths or frequencies outside of such a band.

**RADIO COMMUNICATION**—The transmission of intelligible signals by means of electromagnetic waves. The signals may be in the form of code as in radio telegraphy or in the form of speech or music as in radio telephony. They may be transmitted through the ether (q.v.) without the use of intervening conductors as in ordinary radio, or along conductors as in *wired wireless* (q.v.).

**RADIO COMPASS**—A simple form of *radio direction finder* especially used for marine work. The radio compass depends for its principle of operation upon the directional effect of a coil antenna. Hence a coil antenna mounted on a vertical axis so that it can be rotated freely, is an essential part of the radio direction finder. By

rotating the coil while a particular station is transmitting, it is possible to fix the line of direction of the station. The coil may be mounted so that the maximum signal will be received when the transmitting station lies in the plane of the coil. The device may also be set for minimum signal reception in which case the transmitting station lies in a direction perpendicular to the face of the coil. It is possible to obtain a much sharper determination of direction by setting the coil on the minimum position and hence this method is generally used for direction finder work. (See *Goniometer*.)

**RADIO CONTROL**—The control of motor driven devices such as marine vessels, trains, torpedoes, automobiles, etc., by means of special radio receiving apparatus designed to respond to radio impulses. E. P. Glavin's radio controlled automobile is an example of the radio controlled vehicle. *John Hays Hammond, Jr.* (q.v.) has invented radio controlled torpedoes, radio controlled ships and also radio controlled air craft.

**R.F.**—Abbreviation for radio frequency.  
**RADIO FREQUENCIES**—Frequencies higher than those corresponding to normally audible sound waves. (See *Frequency, Radio*; *Frequency, High*; *Audio Frequency*; also *Frequency, Low*.)

**RADIO FREQUENCY COILS**—*Inductance coils* (q.v.) used to carry radio frequency currents or to couple radio frequency circuits. Radio frequency transformers (q.v.) may be of either iron core or air core types although the air core transformers are more generally used. (See *Low Loss Coils*, also "*D*" Coils.)

**RADIO FREQUENCY CURRENT**—An alternating current having a frequency of from 20,000 to 2,000,000 cycles per second. There is no hard and fast rule regarding the upper and lower limits, since much higher or much lower frequencies may still be considered as radio frequency currents. (See *High Frequency Current*.)

**RADIO FREQUENCY SELECTIVITY**—The radio frequency selectivity of a simple element of a receiving system is the ratio of resonant response (in terms of effective voltage or current measured at the indicator) to the non-resonant response when the radio frequency portions of the elements of that system are detuned by one percent of the resonant frequency. In this case, a simple element refers to a combination of an inductance, a capacitance and optionally a resistance.

**RADIO FREQUENCY SIGNALS**—Currents flowing in a radio receiving circuit up to the point of rectification. The currents flowing in the antenna circuit are radio frequency currents corresponding to the currents flowing in the transmitting aerial. (See *Amplifier, Radio Frequency*.)

**RADIO GONIOMETER**—See *Goniometer*.

**RADIOGRAM**—A message sent in code by radio. A radio telegraphic message.

**RADIO PHARE**—A radiotelegraphic "lighthouse" intended to aid navigation by emitting characteristic signals. By estimating the bearings of two charted radiophares, the mariner may determine the position of his ship.

**RADIO TELEGRAPHY**—The transmission of messages by means of electro-



magnetic waves using dot and dash code signals. A transmitter furnishes a source of high frequency alternating current which oscillates rapidly in the antenna system thus sending out electromagnetic waves. These are intercepted at the receiving station by the receiving aerial. At the receiving aerial, the electromagnetic waves are changed back into alternating current which is rectified by a detector in the receiving apparatus, then amplified and made audible in a head telephone (q.v.) or loud speaker (q.v.). Of course, a means of interrupting the current to produce dots and dashes must be present in the transmitter and suitable tuning devices are used in both the transmitter and the receiver.

**RADIO TELEPHONY**—The transmission of speech, music or other sounds by means of electromagnetic waves. In the standard systems of radio telephony continuous waves are used of a much higher frequency than those of audible sounds. The amplitude of these is modulated by the connection of a microphone in the transmitting circuit. The receiving apparatus is similar to that employed in radio telegraphy and is arranged so that the head set or loud speaker responds to the modulations of the waves and reproduces the sounds as originally produced at the transmitter.

**RADIO TRANSMISSION**—The sending of signals, speech, music, or other sounds by means of electromagnetic waves. The transmission of intelligence through the ether. (See *Radio Communication, Radio Control, Radio Telegraphy*, also *Radio Telephony*.)

**RAT-TAIL**—A single wire, or a group of wires used to connect the main part of an aerial with the lead-in (q.v.) wire.

**RATIO**—Relative values of quantities of the same kind, or number of times one quantity is contained in the other.

**RATIO OF TRANSFORMATION**—The ratio between the primary and secondary windings of a transformer. This determines the ratio of the primary to the secondary voltages. Thus if a transformer has a ratio of transformation of 3 to 1, then the secondary will have three times as many turns as the primary and the secondary voltage will be, approximately triple that of the primary voltage.

**RATIO OF UNITS**—The ratio of the unit pole in the electromagnetic system to the unit pole in the electrostatic system, or of the unit charge in the electromagnetic system to the unit charge in the electrostatic system. Its numerical value is approximately  $3 \times 10^{10}$ .

**RAYLEIGH, John William Strutt**—British physicist. Born at Langford Green, Essex, November 12th, 1842. He was educated at Trinity College, Cambridge. In 1879 he was appointed Cavendish professor of experimental physics in succession to Clerk-Maxwell, a post he held until 1884. In 1887 he became professor of natural philosophy at the Royal Institution and was appointed president of the Royal Society in 1905. In 1908 he was appointed Chancellor of Cambridge University, and died June 30th, 1919. Rayleigh was considered by many to have been one of the most brilliant experimental physicists of the nineteenth century. He not only had a remarkable power of mathematical analysis, but was equally skillful in carrying out the experimental proofs of his theoretical researches. Many of his experiments were made with

home-built apparatus. He threw a fresh light on nearly every branch of physics, from the theory of gases to wave theories and electric and magnetic problems. Due to the care with which he carried out his experiments, he was the first to detect the presence of neon in the atmosphere, this being the forerunner of the discovery of a number of inert gases in the atmosphere. The Rayleigh balance for absolute current measurement is as well known as it is important. Lord Rayleigh was one of the original members of the Order of Merit. In 1882 he was awarded the Royal Medal, in 1899 the Copley Medal of the Royal Society and in 1904 the Nobel Prize for physics.

**REACTANCE**—That property of an electric circuit, aside from its ohmic resistance, which tends to oppose the flow of an alternating current. Mathematically, reactance is defined as the square root of the difference between the square of the impedance (q.v.) and the square of the effective resistance of a given portion of an electric circuit. Expressed as an equation reactance  $x = \sqrt{z^2 - r^2}$  where  $z$  is the impedance and  $r$  the resistance of the part of the circuit under consideration. Reactance due to capacity in a circuit is capacity or condensive reactance. The reactance of a condenser of capacity  $C$  to an alternating current (of sine wave form) of frequency  $f$  is expressed by

$$\text{the equation } X_c = \frac{1}{2\pi f C}. \text{ Reactance}$$

due to inductance in a circuit is *inductive reactance* (q.v.). The reactance of an inductance coil of inductance  $L$  to an alternating current (of sine wave form) of frequency  $f$  is expressed by the equation  $X_L = 2\pi f L$ . Reactance is measured in ohms.

**REACTANCE COIL—REACTION COIL**—Terms used in England to describe the tickler coil (q.v.) used in regenerative sets to couple back part of the energy in the plate or output circuit to the input circuit.

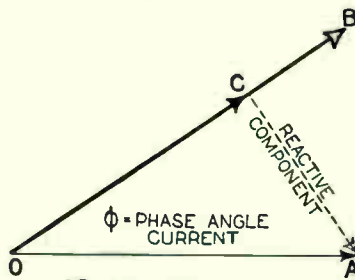

OB—VOLTAGE  
OA—AMMETER READING  
OC—ACTIVE COMPONENT  
AC—REACTIVE COMPONENT

The current represented by vector OA may be considered as divided into two components, OC in phase with the voltage, and CA the reactive component.

**REACTIVE COMPONENT**—The component of an alternating current used to overcome the reactance of the circuit. This component acts at an angle of 90 degrees from the voltage. It is also known as *wattless current* (q.v.).

**REACTIVE CURRENT**—See *Reactive Component*.

**REACTIVE DROP**—The portion of the voltage drop in an alternating current circuit, due to the reactance.

**REAL POWER**—See *True Power*.

**RECEIVER**—A term rather loosely applied to cover the entire radio receiv-

ing apparatus within a station. Also sometimes used as a synonym for *Detector* (q.v.).

**RECEIVING AERIAL**—A wire or group of wires suspended at a suitable height and connected to a receiving set. The purpose of the receiving aerial is to intercept the electromagnetic waves. It should be placed well above surrounding buildings if possible, and should be well insulated from the ground. (See *Aerial*, also *Directional*.)

**RECEIVING CIRCUIT**—Any electrical circuit used in connection with the reception of radio. The more important vacuum tube receiving circuits are the *super-heterodyne* (q.v.), the *neutrodyne* (q.v.), the *reflex circuit* (q.v.), the *regenerative circuit* (q.v.) and the *tuned frequency circuit* (q.v.). There are various modifications and combinations of these circuits.

**RECEPTACLE**—A form of socket into which a plug is inserted for making electrical connections.

**RECONSTRUCTED MICA**—See *Mica-nite*.

**RECORDER**—A telegraphic instrument which automatically records messages sent over a telegraph system.

**RECORDING WATTHOUR METER**—An instrument for measuring and recording the total amount of electrical energy being consumed in a circuit. (See *Integrating Watthmeter*.)

**RECTIFICATION**—The changing of alternating current to direct current. In the usual radio receiving circuit rectification is accomplished by means of the vacuum tube, although the ordinary crystal detector rectifies the alternating current also. Before a storage battery can be charged from an alternating current source, the current must first be changed to direct current. Hence the battery charger designed to work on alternating current must be equipped with a rectification device, or rectifier (q.v.).

**RECTIFIED CURRENT**—An alternating current (q.v.) which has been changed to uni-directional or direct current either by preventing alternate waves from flowing or by reversing their direction. (See *Rectified Signals, Rectification*, also *Rectifier*.)

**RECTIFIED SIGNALS**—Radio signals which have passed through a detector, such as a vacuum tube or a crystal. Rectification of the oscillations results in audible or audio frequency currents which can be heard in a telephone receiver. (See *Rectification, Rectifier, Rectifying Tube*, also *Rectifying Action of Crystal Detector*.)

**RECTIFIER**—An apparatus for converting alternating current to uni-directional or direct current. Examples of rectifiers are certain crystals used as crystal detectors, the commutators of direct current motors and generators, vacuum tubes, electrolytic devices used for charging batteries, etc. (See *Rectified Signal, Rectification, Rectifying Tube, Rectifying Action of Crystal Detector, Rectified Current, Rectifier, Full Wave, Full Wave Rectification*, also *Half Wave Rectifier, Electrolytic Rectifier, Mercury Arc Rectifier, Charger, Storage Battery; Chemical Rectifier; Tungar; Rectigon*.)

**RECTIFIER, FULL WAVE**—A device for converting alternating current to direct current, in which both the positive and negative alternations are utilized. This differs from the half-wave rectifier which rectifies by suppressing alternate waves. (See *Full*

## Rectifying Action

*Wave Rectification, also Half Wave Rectifier.*)

**RECTIFYING ACTION OF CRYSTAL DETECTOR**—The crystal detector has the property of allowing radio frequency alternating currents to flow through it in one direction only. In other words the alternating current is rectified. (See *Crystal Detector—Theory of Operation, Crystal Detector, Crystal Rectifier, Rectified Signals, also Rectified Current.*)

**RECTIFYING TUBE**—A vacuum tube used to convert alternating current into direct current. Rectification can be accomplished by a two-electrode tube, having filament and plate. In this case the electron flow is from the hot filament to the plate. A two-electrode vacuum tube made especially for rectifying purposes is known as the *kenotron* (q.v.). Another recent type of rectifying tube, known as the *helium tube* (trade name, *Raytheon*) utilizes a different operating principle, known as the "short path" principle, whereby the rarefied gas acts as an insulator between points which are in close proximity. This is in apparent contradiction of the observed phenomenon that the smaller the distance between two points the more readily a spark will jump between them due to the ionization of the gas. How-



Fig. 1. A Raytheon tube.

ever, if the distance is small enough and a suitable gas is used at a low enough pressure, an electron may encounter no gas molecules in its path between the points and there will be no ionization by collision. Consequently, the inert gas helium, may be made to act as a perfect insulator at low pressures. Furthermore, it has been found that when a larger electrode of a gas conduction tube is negative, there is a greater current flow than when the smaller electrode is negative and that the smaller the positive relative to the negative electrode, the smaller is the back current and hence the more complete is the rectification. Figure 1 shows a typical helium tube, while Figure 2 illustrates its construction. The two small positive electrodes A, A, are carried through two small glass tubes imbedded in a lava insulating block L so as to project very slightly into a lava cup C whose wells constitute the negative electrode, being connected to the negative terminal through the base. The diameters of the small wires and the diameters and positions of the holes whereby they enter the cup are so proportioned as to give the necessary short path to the negative electrode. The cup C contains helium gas at such low pressure as to prevent gaseous conduction.

This gives an insulation of great reliability and long life and makes possible extremely small anode surfaces which reduce the back current to a negligible quantity.

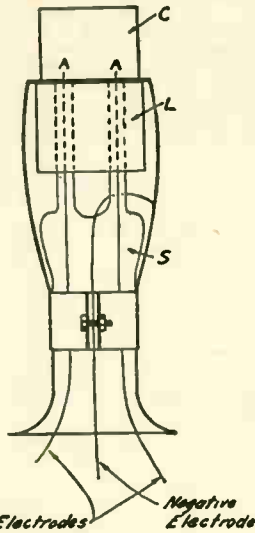

Fig. 2. Construction of the Raytheon tube.

**RECTIFYING VALVE**—This usually refers to a *rectifying tube* (q.v.) although it may refer to an *electrolytic rectifier* (q.v.)

energy striking it. A conductor parallel to the direction of motion of a wave serves to guide the direction of the wave. The reflection and other modifications of radio waves serves to explain *fading* (q.v.) and other irregularities of broadcast signals. It has been found that broadcast signals will have most uniform intensity when long waves are used and during the daytime. Moreover, transmission will be better over a uniform conducting surface, such as the ocean. It is assumed that the space through which a radio wave travels is bounded by the surface of the earth and by an upper region which during the day is a fairly good conductor. The transmitted waves are guided by the two conducting mediums but in addition are assisted materially by reflection especially during the time that the air is partially ionized by the radiation of the sun.

**REFLECTION COEFFICIENT**—(Of a surface of discontinuity between two media.) The ratio of the reflected field intensity near the surface to the incident field intensity near the surface.

**REFLEX**—See *Reflex Circuit*.

**REFLEX CIRCUIT**—A radio receiving circuit invented by Marius Latour in which the vacuum tubes are made to perform double duties as both radio and audio frequency amplifiers. The incoming radio frequency current is amplified at radio frequency, rectified by a detector (which may be a crystal detector) and then amplified at audio frequency, using the same tube.

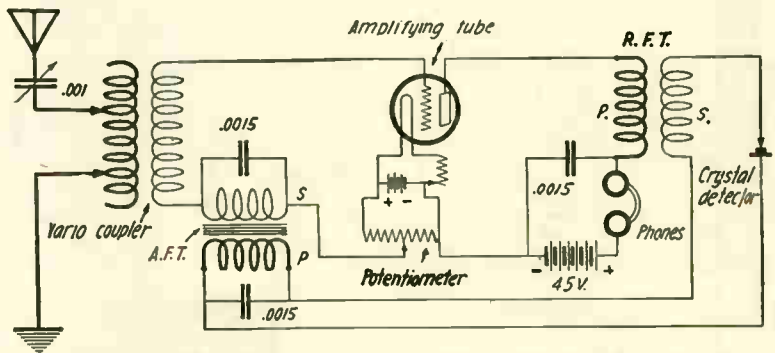

A typical reflex circuit using one tube and a crystal detector.

**RECTIGON**—The trade name of a storage battery charger which utilizes the vacuum tube rectifier principle. (See *Charger, Storage Battery, also Rectifying Tube.*)

**RED MAGNETISM**—An obsolete term for the lines of force coming from the north pole of a magnet.

**REDUCE WAVE-LENGTH OF AERIAL**—The wave-length of an antenna may be reduced by the use of series condensers. However, this method should be avoided where possible, since it results in a loss of power. Shortening the aerial is a preferable method of reducing wave-length.

**REFLECTING GALVANOMETER**—See *Mirror Galvanometer*.

**REFLECTION**—Radio waves are reflected and also refracted when they pass into a region of different dielectric constant. A perfect conducting sheet would reflect all of the wave

A typical four tube reflex set uses the second and third tubes as amplifiers simultaneously for both the radio and the audio frequency amplification. As a result the four tubes are made to produce the effect of six. Reflexing may be accomplished in a number of different ways. In some cases all the tubes are made to work twice. In other cases, only a part of the tubes are used for dual amplification. A variation of the reflex circuit, is the *Inverse Duplex Circuit* (q.v.). In this system the incoming signal reaches the first tube where it is amplified at radio frequencies and passes to the second tube, where it is again amplified at radio frequencies. From the second radio frequency tube, it is passed to the detector tube, where it is converted to audio frequency. The current then flows back to the second radio frequency tube which is now used as an audio frequency amplifier. Thence it flows to the first radio frequency tube which acts as the second

stage of audio frequency amplification.

**REFRACTION**—The refraction of electric waves is analogous to the refraction of light. The electric (radio) waves are refracted when they pass into a region of different dielectric constant. That is to say, their direction is slightly altered. (See *Fading, Gliding Theory, also Reflection.*)

**REFRACTION AND REFLECTION OF ELECTROMAGNETIC WAVES**—See *Refraction, also Reflection.*

**REGENERATION**—The amplifying properties of the three-electrode vacuum tube can be used to obtain what is termed *regeneration*. Since it is possible to have greater output energy than input energy, part of the output may be returned to the input side, thus resulting in amplification of energy or in regeneration. By *feeding back* the correct amount of energy and in the right phase relation a constant reamplification may be obtained, and the tube can be made to act as a generator of sustained oscillations. (See *Armstrong Circuits, Feed-Back, Feed-Back Coil, Feed-Back Coupling, Feed-Back Effect, also Regenerative Circuit.*)

**REGENERATIVE**—See *Regenerative Circuit.*

**REGENERATIVE CIRCUIT**—A method of connecting up vacuum tubes for radio reception in which the amplified variations of the plate circuit are superimposed inductively on the grid or input circuit thus producing a reinforcing effect which results in increased sensitivity. (See *Armstrong Circuits.*)

**REGENERATIVE COUPLING**—A radio receiving system designed to increase amplification in a vacuum tube, by coupling the plate or output circuit back to the grid or input circuit thus producing regeneration. (See *Feed-Back, Feed-Back Coil, Feed-Back Coupling, Feed-Back Effect, also Regenerative Circuit.*)

**REINARTZ CIRCUIT**—A selective regenerative circuit devised by John L. Reinartz in which a *spider-web* inductance coil is used, the coil acting as primary, secondary and tickler. Capacity *feed-back* (q.v.) is accomplished

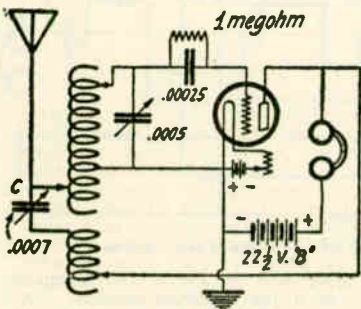

Diagram showing Reinartz circuit

by means of a variable condenser. In the improved Reinartz a variocoupler is used, connected as a variometer, in addition to the condenser *feed-back*.

**REJECTOR**—See *Rejector Circuit.*

**REJECTOR CIRCUIT**—A circuit consisting of a combination of inductance and capacity for filtering out or preventing the passage of currents of certain frequencies. This circuit is used in connection with a radio receiving set to obtain greater selectivity. The inductance and the capacity are ar-

anged in parallel to form a resonant circuit. The constants of this circuit are chosen so that at the particular frequencies to be filtered, the capacity current will exactly equal the inductive current, thus giving zero resultant current. The primary application of the rejector circuit is as an *interference eliminator* (q.v.) or *wave trap* (q.v.). Figure 1 shows the application of the rejector circuit applied to a radio receiving set. The circuit shown is a combination *acceptor-rejector* circuit. The rejector circuit is shown in heavy

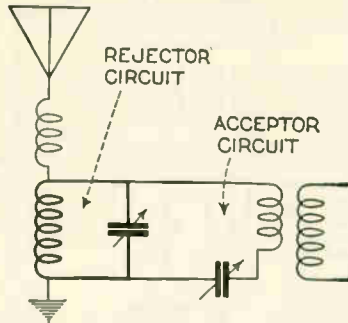

Fig. 1. An acceptor-rejector circuit used as a wave trap.

lines. The inductance and the capacity are connected in parallel with each other and with the acceptor circuit and this latter is inductively coupled to the receiving set circuit. Both the acceptor and the rejector circuits are tuned to the wave length of the receiving aerial. By using more than one

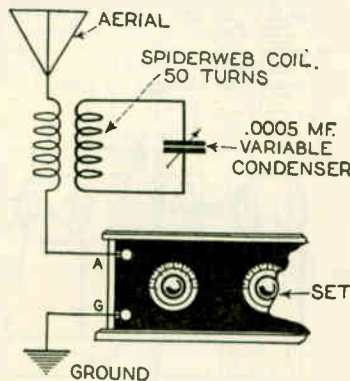
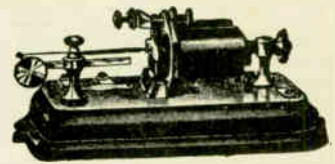

Fig. 2. A rejector circuit designed to filter out undesired spark signals.

rejector and acceptor circuit increased selectivity can be obtained. A rejector circuit used to filter out undesired spark signals is shown in Figure 2. A small inductance of about ten turns is employed in this circuit and this is inductively coupled to a closed tuned circuit and wired in series with the aerial, and the aerial terminal of the set. If a spider-web coil is used in the closed circuit, a suitable value for broadcast wave lengths is a 50 turn coil, placing the aerial coil in such a position as to get closest coupling. The variable condenser should have a capacity of .0005 mfd. (See *Acceptor.*)

**RELAY**—An electromagnetic device by means of which contacts in one circuit are operated by a change in conditions

in the same circuit or in one or more associated circuits. (See *Magnifier.*)



A telegraphic relay.

**RELUCTANCE**—Magnetic resistance.

The reluctance of a magnetic circuit is analogous to electrical resistance. All magnetic circuits offer reluctance to flux. The name *rel* is widely used as the unit of reluctance. The *rel* is the reluctance of a magnetic circuit which will have one line of force in it, upon application of one *ampere-turn*. The *rel* can also be specified as the reluctance of a cylinder of air, or of any other non-magnetic material, one square inch in cross-sectional area, and 3.19 inches long. The flux through a magnetic circuit is equal to the *magnetomotive force* (q.v.) divided by the reluctance. (See *Magnetic Properties.*)

**RELUCTIVITY**—The *reluctance* (q.v.) per unit length and per unit cross-section. The reluctance per inch<sup>2</sup> or per cm<sup>2</sup>. Reluctivity may be defined as specific magnetic resistance. It is the reciprocal of *permeability* (q.v.).

**REMANENCE**—The term applied to the magnetism remaining in a magnet after the magnetizing force is removed.

**REMOTE CONTROL**—A control system whereby a radio transmitting or receiving apparatus may be operated at any desired distance from the apparatus. The chief advantage of remote control lies in the fact that the high tension apparatus and the tall aerial masts may be located in outlying districts whereas the studio can be located at any desired, convenient point. In addition it is possible to broadcast concerts, theatrical entertainments, prize fights, etc., direct from the scenes of action by utilizing remote control.

**REPEATING COIL**—A transformer of unity ratio used in telephone practice.

**RE-RADIATION**—The relaying of a radio wave through the action of a receiver employing regeneration. This phenomenon is most commonly observed in receivers of the *super-heterodyne* type.

**RESIDUAL CHARGE**—The residuary electricity retained by a condenser after discharge. This is also known as *electric residus* or *soakage*. After the condenser is discharged in the ordinary way, the residual charge permits a second discharge, smaller than the first. (See *Soaking in.*)

**RESIDUAL MAGNETISM**—The magnetism retained by a piece of iron, after the magnetizing force is withdrawn. After a mass of iron has become magnetized, some of the magnetism will remain, even though the magnetizing force has been taken away. The amount of residual magnetism depends on the quality of the iron. Pure wrought iron, in general, retains very little residual magnetism, whereas wrought iron which has gone through a hardening process, or which contains a large percentage of impurities and also cast iron possess a much larger amount of residual magnetism.

**RESINOUS ELECTRICITY**—An obsolete term for negative charges of electricity, adopted because of the fact that resinous bodies become negatively charged by friction. (See *Vitreous.*)

**RESISTANCE**—Symbol  $\Omega$  (Omega) —

Every conductor of electricity offers opposition to the flow of electricity. Resistance is a property of the conductor itself. It increases with increased length of conductor, decreases with increased cross-sectional area, and is greater or less depending upon the material of the conductor. Resistance is measured in *ohms*. (q.v.). The ohm is equal to  $10^9$  C.G.S. electromagnetic units.

**RESISTANCE BOX**—A box containing a number of wire coils of known resist-

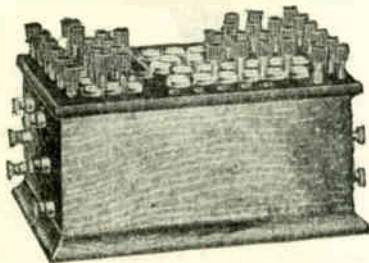

A resistance box.

ances connected in various combinations, by means of switches or plugs, to produce any desired total resistance.

**RESISTANCE COUPLED AMPLIFIER**

—A type of *amplifier* (q.v.) which utilizes high resistances for interstage coupling. Resistance coupled amplifi-

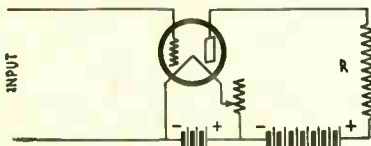

Fig. 1. The introduction of the non-inductive resistance in the plate circuit of the tube is the first step for explaining the principles involved.

cation is generally used only for audio frequency amplification although it may be used for radio frequencies above 1000 meters. The chief advantage of resistance coupling consists in the purity of tone obtainable and the absence of distortion. In addition radio receivers of this type are comparatively inexpensive to build. It should be noted, however, that with resistance coupled amplification, the amplification per tube is much less than with transformer coupled amplification and furthermore the drain on the "B" batteries is also much greater. Of course,

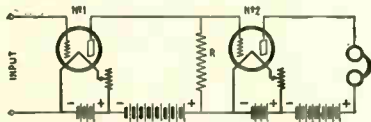

Fig. 2. In this circuit there must be two sets of batteries, but even then the grid of tube No. 2 will have a positive bias, which is undesirable.

where a "B" eliminator is used "B" battery consumption is not a consideration. The resistances used for resistance coupling are non-inductive and may have resistances of from .1 megohm to 2 megohms. Figure 1 shows an elementary circuit utilizing a non-inductive resistance in the plate circuit of the tube. When a signal is impressed upon the grid circuit of this amplifying tube, there is a corresponding voltage set up in the plate circuit. The resistance R in the plate circuit

causes a voltage drop to take place in two places in the tube. The total resistance of the plate circuit is equal to the internal resistance of the tube added to the resistance R, and if the

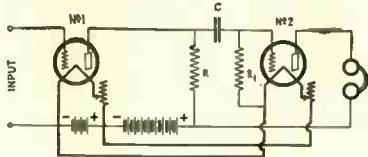

Fig. 3. The resistance coupled amplifier circuit with the introduction of a grid leak and condenser. The reasons for this are explained in the accompanying text.

"B" battery has 90 volts and if R is equivalent to the tube resistance at that moment the voltage drop across the tube will be 45 volts with the same drop across R. Theoretically it is possible to vary the voltage drop across R from zero to almost 90 degrees. Discounting the small resistances of the "A" and "B" batteries, a changing voltage will occur across the filament and plate when the grid potential varies, and also across the resistance R. Naturally these last variations depend upon the tube resistance and upon the value of the resistance R. These variations will be largest when R has a greater resistance than that of the tube. The resistance or impedance of the tube is constantly in a state of change and can assume very high values. For this reason the value of R should be equal to the higher values of the tube impedance in order to maintain maximum effectiveness. As used with ordinary amplifier tubes, a value of 100,000 ohms has been found to give satisfactory results. The next step is to apply the voltage variations across R to the grid circuit of the next tube. In Figure 2, the resistance R lies in the grid circuit of tube 2 as well as in the plate circuit of tube 1. Hence the magnified changes in tube 1 are

number of tubes in an amplifier. In order to do this the grids of the tubes must be separated electrically from the high voltage of the plates of the preceding tubes, but only as far as the steady voltage is concerned, while the fluctuating voltage of these plates must be impressed on the grids of the following tubes. This is done by introducing condensers between the two resistances. These effectively block the direct currents while they afford easy passage to alternating currents. Figure 3 shows the introduction of the condenser between the plate resistance and the grid resistance. Inspection of this diagram shows that although tube No. 1 remains the same, the plate instead of being connected directly to the grid of tube No. 2 is separated from the latter by means of the condenser C. If voltage fluctuations now occur across the resistance R, they will also be effective across the grid and filament of tube No. 2, because R exerts its influence between plate and filament of tube No. 1. As the condenser, C, conducts the variations very easily, the voltage fluctuations against R are then effective across the filament and grid of tube No. 2. It is necessary that tube No. 2 be provided with a grid leak, R<sub>1</sub>, for the accumulated negative charges to leak off the grid to the filament. This grid leak at the same time serves the purpose of a by-pass for voltages, occurring due to possible leaks in the condenser C, which would tend to make the grid positive, thus allowing a grid current to flow and stopping the perfect action of the tube as an amplifier. Since the grid leak R<sub>1</sub> is a direct shunt across the grid and filament of tube No. 2, it must have a relatively high value in order to retain the highest possible amplification. R<sub>1</sub> should have a value lying between 500,000 and 2,000,000 ohms. If this resistance is made variable, it will be possible to control the resulting amplification completely. The value of the condenser C, must be chosen so that its re-

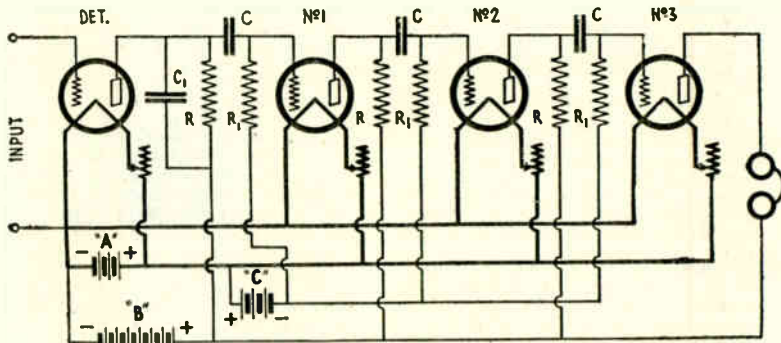

Fig. 4. Diagram showing three stages of resistance coupled amplification.

transferred from R to the grid and filament of tube 2, thus the latter tube will be affected directly by the output circuit of the first tube and thus there will be amplification in both tubes thereby causing a resultant magnified signal to be heard. However, in such a hook-up, the same "A" and "B" battery cannot be used since this would mean that there would be a positive charge on the grid of tube No. 2, which would then be unable to function. Naturally, it would be impracticable to use a circuit having so many batteries, so a means must be found whereby it is possible to have a power supply consisting of but one filament battery and one plate battery for any given

resistance to the flow of alternating current will be as low as possible. Figure 4 shows three stages of resistance coupled amplification with a "C" battery used to give proper grid bias. The value of the resistance R, in the plate circuit of the tubes is 100,000 ohms and the value of the resistance in the grid circuits is 1,000,000 ohms (1 megohm). The condenser C has in each case a capacity of 0.05 mfd. The value of the "C" battery is about 4½ volts, but this should be determined by experiment for best results.

**RESISTANCE COUPLING—RESISTIVE COUPLING**—The transference of electrical energy from one circuit to

another, by means of resistance common to both. (See *Resistance Coupled Amplifier*.)

**RESISTANCE, HIGH FREQUENCY**—The increased resistance of a conductor to high frequency currents, due to concentration of current at the surface of the conductor. This phenomenon is known as *skin effect* (q.v.) Skin effect becomes more pronounced, the greater the frequency of the impressed electromotive force. Skin effect also increases with increased cross-section of the conductor, with increased conductivity of the conductor and with increased magnetic permeability (q.v.). As a result of skin effect, the actual resistance of a conductor to alternating currents is greater than to direct currents.

**RESISTANCE OF GROUND CONNECTION**—The connecting wire leading from the radio apparatus to the ground should be of low resistance. If possible, the ground should be made by burying a copper plate in moist earth. The usual way to obtain a ground is to fasten a copper strap or *ground clamp* (q.v.) around a water or a steam pipe.

**RESISTANCE (RADIATION)**—This is the ratio of the total energy radiated (per second) by the antenna to the square of the root-mean-square current at a potential node (generally the ground connection).

**RESISTANCE, RADIO FREQUENCY**—The ratio of the heat produced per second, in watts, to the square of the root-mean-square current (radio frequency), in amperes, in a conductor.

**RESISTIVITY**—See *Resistivity of a Material*, also *Resistivity, Surface*.

**RESISTIVITY OF A MATERIAL—SPECIFIC RESISTANCE**—Symbol  $\rho$  (rho)—The resistance in ohms of unit length and unit cross-section of the material under consideration. Resistivity may be measured in ohms per inch cube or per centimeter cube, but more commonly it is measured in ohms per *mil-foot* (q.v.). The material of a conductor has an important bearing upon its resistance. Thus a unit length and unit cross-section of aluminum has about one and one-half times the resistance of copper having the same dimensions. Platinum has about six times the resistance.

**RESISTIVITY, SURFACE**—Referring to an insulating substance, surface resistivity is the resistance between two opposite edges of a surface film, 1 centimeter square. Surface resistivity depends to a considerable extent on humidity.

**RESONANCE**—A condition which exists in an electrical circuit where the frequency of the applied electromotive force is the same as the natural frequency of the circuit. Resonance is the cumulative effect produced by a periodic force in a circuit, so adjusted in frequency that the effect can attain the highest value. The effect measured is usually the current and the circuit when adjusted for maximum current, is said to be in resonance with the force, or with the circuit from which the force comes. The effect of resonance is to bring the current into phase with the electromotive force. Resonance in a circuit has the effect of bringing the reactance due to the inductance (inductive reactance) in exact opposition to the reactance due to capacity (capacity reactance). The total reactance is therefore zero and therefore the impedance is equal to the resistance. When two or more circuits have the same natural frequency they are said to be in resonance. Res-

onance of a circuit to a given exciting alternating electromotive force is that condition due to variation of the inductance or capacity in which the resultant effective current (or voltage) in that circuit is maximum. Instead of varying the inductance and the capacity, the frequency of the exciting field may be varied. The condition of resonance is determined by the frequency at which the current or voltage is maximum.

**RESONANCE CURVE**—A curve showing the relationship between the current induced in an oscillatory circuit and the frequency of the inducing current. In the case of two oscillating circuits placed near each other so that

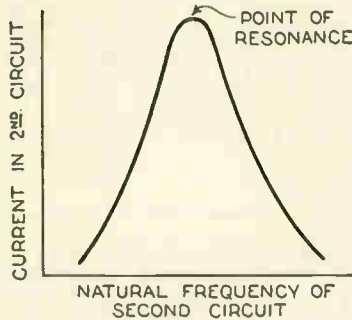

A typical resonance curve.

oscillations in one circuit will induce oscillations in the other, the induced oscillations will be weak or strong depending whether or not the second circuit is in tune with the first one. The capacity and the inductance of the second circuit can be varied until it is exactly in tune with the first at which time maximum current will flow in it. The resonance curve is obtained by measuring the current in the second circuit for various noted oscillation constants, and plotting the curve with the ordinates representing the current and the abscissae the corresponding natural frequency of the second circuit. The diagram shows a typical resonance curve. The peak of the curve is the point where the two circuits are in tune, or in other words, the point of resonance.

**RESONANCE INTENSIFIER**—An automatic receiver used for the reception of high-speed radio telegraph signals.

**RESONANCE TRANSFORMER**—Any loose-coupled tuning inductance having a primary and secondary each with a variable condenser in the circuit. Tuning the secondary circuit brings it in resonance with the primary, thus enabling signals to be heard with greatest volume.

**RESONANT**—See *Resonance*.

**RESONATOR**—A device for detecting by resonance, oscillations produced by an oscillator. This term is also used to refer to the sound box employed with the telegraph sounder.

**RESONATOR, ACOUSTIC**—A vessel containing a volume of air which can easily be set into vibration by sound waves or by the oscillation of a solid object. Typical forms are cylindrical or spherical and the ear is applied to a small tube opening into the air chamber.

**RETARDATION COIL**—A reactance coil used in a circuit for the purpose of selectively reacting on currents which vary at different rates.

**RHEOSTAT**—A variable resistance used to control current flow. Rheostats may

be made of resistance wire or of carbon or for special purposes liquids may be used. In radio work, rheostats are connected in series with the filaments of vacuum tubes and the "A" battery in order to control the amount of current flowing in the filaments.

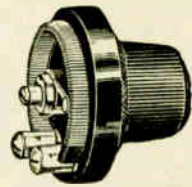

A rheostat constructed of resistance wire.

**R. M. S.**—Abbreviation for *Root Mean Square* (q.v.)

**ROBERTS, Joseph Harrison Thomson**—Born in 1890, he was educated at Liverpool and Cambridge Universities. He carried out many physical researches at the Cavendish Laboratory, Cambridge, and did a great deal of work on thermionics and other radio problems. He is a doctor of science and a Fellow of the Institute of Physics. He has several radio patents to his credit and is an expert in electrical, optical and acoustical sciences.

**ROBINSON, James**—British radio inventor. Born in 1884, he was educated at Durham and Göttingen Universities. He was appointed lecturer in physics at Durham University, 1906-07, lecturer in physics Sheffield University, 1910-12, and lecturer in physics at the East London College, London University, 1912-15. Robinson is known chiefly for his direction finding apparatus. He is a member of the Radio Society of Great Britain.

**ROBINSON, Samuel S.**—Rear-Admiral, U.S.N. He was born May 10th, 1867, and was educated at the United States Naval Academy, from which he graduated. He wrote the *Manual of Wireless Telegraphy for Naval Electricians*, and was in charge of the Bureau of Equipment, Navy Department.

**ROOT MEAN SQUARE**—The square root of the mean value of the square of an alternating current or voltage. An alternating current whose root-mean-square value is one ampere has the same heating effect as a direct current of one ampere. Root mean square is also referred to as *effective* or *virtual value*. The root mean square is derived as follows. In electrical measurements, it is necessary to compare direct and alternating currents. Moreover, the same units of measurement, the *ampere* (q.v.) and the *volt* (q.v.) are used in referring to both direct and alternating currents. However, in a direct current, a certain voltage will produce a steady current, whereas in an alternating current, both the voltage and the current are constantly varying both in magnitude and direction. The common basis of measurement is found in the value of the alternating current which will produce the same amount of heat as a certain direct current. Heating effect, according to *Joules Law* (q.v.) is directly proportional to the square of the current. Hence, in an alternating current varying according to a sine law, it is necessary to square each ordinate, find the mean or average value of these squares, and then extract the square root of this mean. Stated in concise terms, it is necessary to find the root mean square. An alternating current having a *maximum* value of one ampere would have a root mean square value of .707 amp. (See *Form Factor*.)

### Root-Mean-Square Value

**ROOT-MEAN-SQUARE VALUE**—See *Root-Mean-Square*.

**ROTARY CONDENSER**—A synchronous motor used on a power line to advance the *phase* (q.v.) of the current. As a result there is an improvement in the *power factor* (q.v.). The action of the synchronous motor is similar to that of a condenser, whence the name rotary condenser.

**ROTARY CONVERTER**—A device for converting alternating current into direct current or vice versa. The rotary converter is also known as a *synchronous converter*. It is built like a direct current generator, except that it has certain commutator segments or conductors in the armature, connected to slip rings. Two, three, four, or six rings may be used. When the armature is rotated there is an alternating voltage between the rings. If the converter is driven by a motor or by an engine, it may be used as a *double current generator*, direct current being obtained from the brushes and alternating current from the slip rings (collector rings). When the collector rings are supplied with alternating current, the converter runs as a synchronous motor and direct current can be obtained from the brushes on the commutator. It should be understood that there is only one set of windings on the rotary converter which act simultaneously as alternating current motor and direct current generator. A converter which is used to convert direct current to alternating current is called an *inverted converter*. In the *single-phase* converter, there are two slip rings connected to the windings by as many equally spaced taps as there are poles. In the three-phase converter, three rings are used, with three equally spaced taps for each pair of poles. The single phase rotary converter must be brought up to synchronous speed by external power as it will not start itself. The polyphase con-

verter will start itself from the alternating current side, but since it draws a very great lagging current, it should be started whenever possible from the direct current side. (See *Converter*.)

**ROTARY CURRENT**—A term infrequently used to denote *polyphase* (q.v.) current.

**ROTARY DISCHARGER**—A rotating disc discharger used in wireless transmitters in which the sparks occur between metal studs mounted on a motor driven disc. (See *Disc Discharger*.)

**ROTARY FIELD**—A magnetic field rotating in space. It may be due to rotating windings or stationary windings properly spaced through which polyphase currents are flowing.

**ROTARY GAP**—A form of rotating spark gap utilizing two or more rotating discs carrying studs between which the sparks pass. Spark gaps of this type were formerly used in wireless telegraph transmitters. (See *Discharger*, also *Disc Discharger*.)

**ROTARY HYSTERESIS**—Hysteresis (q.v.) produced by a rotating field as distinguished from that produced by a changing field.

**ROTARY SPARK GAP**—See *Rotary Discharger*.

**ROTARY TICKER**—A *ticker* (q.v.) in which the interruptions are produced by the chattering of a springy brush on a rapidly rotating metal wheel.

**ROTOR**—The rotating part of any electrical apparatus. It may refer to the revolving portion of a *motor* (q.v.) or *generator* (q.v.) or to the rotatable part of a variable *condenser* (q.v.). The rotor in a direct current motor or generator is the armature. In an alternator or an alternating current motor, the rotor may be either the armature or the field.

**ROTOR, GROUNDED CONNECTION**—This refers to the grounding of the rotors of variable condensers in a ra-

dio receiving set. This is often done to eliminate hand capacity. Sometimes the rotors are connected to the shielding, which is grounded.

**ROUGH CALIBRATION**—Meters such as voltmeters, ammeters, etc., are often calibrated by comparison with standard instruments. In case such instruments are not available, it may be necessary to use less accurate methods. As an example of rough calibration, an experimental wave meter could be calibrated roughly by tuning in on various broadcasting stations whose wave lengths are known. (See *Calibration*.)

**RUHMKORFF COIL**—See *Induction Coil*.

**RUTHERFORD, Sir Ernest**—British physicist. Born at Nelson, New Zealand, he was educated at Canterbury College, Christchurch, New Zealand University, and Trinity College, Cambridge. From 1898 to 1907 he held the position of MacDonald professor of physics at Manchester University. In the latter year he was appointed Cavendish professor of physics and director of the Cavendish laboratory at Cambridge. Rutherford is an extremely brilliant physicist and has carried out a series of researches on the ultimate composition of matter. Many of these experiments have confirmed the researches of J. J. Thomson and others. Some of Sir Rutherford's experiments have revolutionized the theories of matter. He has received many honors for his brilliant researches including the Nobel prize for chemistry awarded to him in 1908. He has written extensively on radio activity, his books including "Radioactivity," 1904; "Radioactive Transformations," 1906; "Radioactive Substances and their Radiations," 1913; as well as many papers for technical journals. Sir Ernest was knighted in 1914.

## S

**SAFETY GAP**—A spark gap which is connected in parallel with a condenser or other apparatus, and which protects the apparatus from excessive voltage. When the voltage exceeds a predetermined limit, the gap breaks down, thus passing the current around the apparatus. (See *Gap*, *Micrometer*.)

**SAL AMMONIAC**—A term commonly used for ammonium chloride. This substance is a white crystal, very soluble in water, and is used as an electrolyte in primary cells and also in many electroplating processes. (See *Cell*.)

**SATURATED**—The magnetic condition of a substance when increase of magnetizing force produces no further increase in flux density. A point is reached in every magnetic material, where further increase of magnetic intensity will not produce any increase of flux density. At this point, the material is said to be saturated. Cast iron becomes saturated at a lower flux density than steel or wrought iron.

**SATURATION**—See *Saturated*.

**SATURATION, MAGNETIC**—See *Saturated*.

**SECONDARY CELL**—A unit consisting of a positive and a negative electrode immersed in an *electrolyte* (q.v.) which becomes active only after the passage of an electric current. The electrodes are of metal or of a metallic

compound. An electric current, flowing into a secondary cell causes certain chemical actions to take place whereby electrical energy is transformed into chemical energy. This process is termed "charging." After the cell is charged, the reverse action takes place and chemical energy is transformed into electrical energy. In this case, the cell is able to deliver an electric current to an outside circuit. This process is termed "discharging." The secondary cell is also known as an *accumulator* or *storage cell*. However, the cell does not store electricity. It merely holds or stores the chemical energy for immediate transformation into electrical energy. It is usual practice for several positive plates to be connected in multiple to form one positive electrode and for several negative plates to be connected in parallel to form a single negative electrode. The *storage battery* consists of two or more storage cells. The operation of the storage cell depends upon the fact that certain metals immersed in an electrolyte may differ in potential. In the secondary cell, no electrical action takes place until after charging. Thereafter, chemical action maintains a difference of potential until the stored energy has been retransformed. While the negative electrode is used up to a certain extent during the process of discharging, it is replaced electrochemically during the

charging process, due to the flow of current through the electrolyte in the opposite direction to that of discharge. The two principal types of storage cells are the lead cell and the nickel-iron-alkaline (or Edison Cell). In lead cells, the negative electrode is made of spongy lead and the positive electrode is of lead peroxide. The electrolyte is dilute sulphuric acid. The following chemical action takes place within the lead cell. When the cell is charged, hydrogen is released at the negative plate, and oxygen at the positive plate. The oxygen combines with the lead of the positive plate to form lead peroxide while the hydrogen reduces the oxide in the negative plate. When the cell is discharged, both electrodes are changed to lead sulphate and the liberated hydrogen combines with the oxygen to form water. Care must be taken not to allow the cell to discharge too far as in this case, too great an amount of lead sulphate may form and this may cause buckling of the plates or may make it very difficult to recharge the cell. The indications of a completely charged cell are increased gassing of electrolyte together with a stop in the rising of the voltage and the specific gravity. In the Edison-type secondary cell, the active materials are of nickel and iron. Nickel hydrate forms the active material of the positive plate, while iron oxide forms the active material of the nega-

tive plate. The electrolyte is a 21 per cent. solution of potassium hydrate combined with a small amount of lithium hydrate. The chief advantage of the *Edison cell* (q.v.) is that it can be left idle indefinitely in a fully charged, semi-charged, or fully discharged state without any harm to the cell. In addition it is lighter and smaller than the same capacity lead cell. The unit used for measuring the capacity of storage cells is the *ampere-hour* (q.v.). This is based on the rate of discharge normally used in measurement, the eight-hour rate. As an example, an 80 ampere-hour storage battery will furnish a continuous current of 10 amperes for 8 hours. If the battery is discharged at a more rapid rate, it will not have the rated capacity.

**SECONDARY CURRENT**—The current flowing in the secondary windings of inductive apparatus. Current induced in a secondary winding due to the action of *primary current*. (See *Current, Primary*.)

**SECONDARY ELECTRON EMISSION**—See *Secondary Electrons*, also *Secondary Emission*.

**SECONDARY ELECTRONS**—Electrons emitted by the plate of a vacuum tube when struck by the electron stream from the filament. (See *Negative Resistance*, also *Secondary Emission*.)

**SECONDARY EMISSION**—Electron emission in which the exciting agency is bombardment of the emitting material by electrons. The emission of electrons from cold electrodes under the impact of other electrons. (See *Negative Resistance*.)

**SELECTIVE**—See *Selectivity*.

**SELECTIVITY**—The sharpness with which a radio receiving set can be tuned to a particular wavelength. A selective set is one which tunes sharply, whereas a non-selective set tunes broadly. Too long an aerial will often result in making a set tune broadly. A short aerial makes the receiving set more selective but reduces the volume.

**SELECTOR**—A tuning device connected in a radio receiving circuit for the purpose of eliminating undesired stations. (See *Wave Trap*.)

**SELENIUM CELL**—A cell constructed of a thin layer of the metal selenium. This metal is extremely sensitive to light. In its crystalline form, it is a conductor of electricity, its conductivity varying with the amount of light allowed to fall on it. As a result it is possible to regulate the flow of current in a circuit by varying the light. The selenium cell thus offers a means of transmitting pictures by wire or radio. Selenium cells are also being used in experimental devices for the transmission of motion pictures and for obtaining *television* (q.v.).

**SELF-CAPACITY**—The capacity of a circuit or a portion of a circuit. Every electrical circuit possesses inherent capacity, which varies in degree, depending upon the shape, size, etc., of the circuit. Self-capacity is also referred to as *distributed capacity* (q.v.). In general self-capacity is detrimental, especially in radio circuits, since it introduces losses. By using special forms of windings, the self-capacity of coils can be greatly reduced. (See *Low Loss Coils*.)

**SELF-EXCITED GENERATOR**—A generator which depends upon its own current for its field excitation. Such a generator must build up its magnetic field and hence its voltage, gradually. In order to get a start, it depends upon the *residual magnetism*

(q.v.) present in the iron of the poles. There are three types of self-excited generators, the *shunt generator* (q.v.), the *series generator* (q.v.) and the *compound generator*. (See *Compound Wound*.)

**SELF-HETERODYNE**—A system of reception of continuous wave signals by the production of audio frequency beats, through the use of a device which is both a radio frequency generator and a detector of the audio frequency beat currents produced.

**SELF-INDUCTANCES**—See *Inductance, Self*.

**SELF-INDUCTION**—Inductance due to the field produced by the circuit itself. Changes in current are always accompanied by self-induction. When the current is decreasing, the electromotive force of self-induction is in the same direction, thus tending to prevent the decrease. When the current is increasing, the electromotive force of self-induction tends to prevent the increase. (See *Inductance, Self; Mutual Inductance, also Induction*.)

**SELF-INDUCTION COEFFICIENT**—The ratio of the number of lines of induction produced by a current flowing in the circuit divided by the current in the circuit. The coefficient of self-induction of a conductor of finite cross-section may be defined as the ratio of twice the energy of the magnetic field produced by the current flowing to the square of the current. The following factors affect the coefficient of self-induction of a circuit: the cross-section and shape of the conductor, the size and shape of the circuit, the permeabilities of the surrounding medium and of the conductor itself. Where the skin effect is large, the frequency of the current and the specific resistance of the conductor will also affect the coefficient of self-induction.

**SELF-OSCILLATION**—The tendency for the vacuum tubes in a radio receiving set to act as generators of radio frequency oscillations. (See *Body Capacity, also Boltho Circuit*.)

**SENSITIVE SPOTS**—Points on the mineral of a crystal detector which show a greater response to incoming oscillations than others. Dust, grease, or dampness reduce the sensitivity of these spots and therefore the crystal should be properly protected.

**SEPARATELY EXCITED GENERATOR**—A generator in which current for producing the magnetic field is obtained from some source external to the generator itself. This source is either another generator or else a storage battery. Separately excited generators are generally used only for special work such as battery charging, electroplating and testing.

**SERIES**—See *Series Connection*.

**SERIES CONNECTION**—When two or more parts of an electrical circuit are so connected that the same current

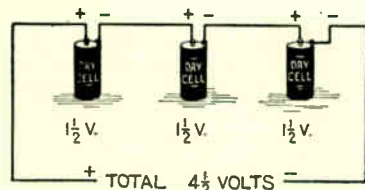

The three dry cells are here shown connected in series.

flows through them they are said to be in *series* and the circuit is called a *series circuit*, the connection being a

*series connection*. In order to connect primary or other cells in series, it is necessary to connect the positive terminal of one to the negative terminal of another, etc. In this case, the total voltage of the battery equals the sum of the separate voltages.

**SERIES GENERATOR**—A generator in which the exciting winding is connected in series with the armature and the load. This type of generator is of small commercial importance being used mainly for certain constant current systems.

**SERIES MOTOR**—A commutator-type motor having the field and armature windings connected in series. Ordinarily, the series motor is a direct current motor, but with minor modifications, such as lamination of the field as well as armature, this motor can be used for alternating current also. With the applied voltage constant, the greater the load, the less will be the speed of a series motor. As the load is lessened, the motor will speed up, and if the load is entirely removed, it will "run away." The *torque* (q.v.) characteristic is the most important feature of a series motor. Instead of varying directly with the current as in the shunt motor, the torque increases with the square of the current.

Hence, if the current is doubled, the torque will be increased four times, while if the current is quadrupled, the torque will be increased sixteen times. For the same current, the torque of the series motor is higher than that of the shunt and in addition, the series motor has a much better starting torque.

**SERIES-PARALLEL**—This refers to a circuit which is a combination of a

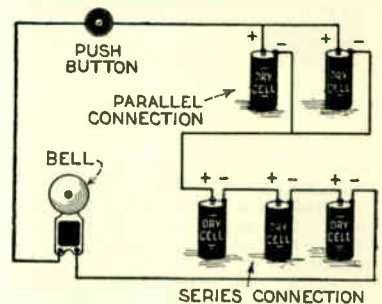

A series-parallel circuit. The three dry cells are connected in series with each other and with the bell and the push button. They are also in series with the other two dry cells, these latter being in parallel with each other.

*series circuit* and a *parallel circuit*. The term *series-parallel* is generally used to indicate a series circuit having certain minor branches in parallel; the term *parallel-series* denotes a parallel circuit having certain minor branches in series. The illustration shows a series parallel circuit having two dry cells in parallel and three dry cells in series. The push button and the bell are also in series. (See *Parallel Connection, Series Connection, also "A" Battery*.)

**SERIES RESONANCE**—When a single lumped capacity and a single lumped inductance are connected in series between terminals to which an alternating electromotive force is applied, and the inductance or capacity or frequency is varied, the condition of series resonance exists, when the current is a maximum. (See *Resonance, also Resonance Curve*.)

**SHARPNESS OF RESONANCE**—A quantity expressing the fractional change of current in a simple series circuit for a given fractional change in either capacitative or inductive reactance.

**SHARPNESS OF TUNING**—See *Selectivity*.

**SHARP WAVE**—A wave in which the energy radiated is confined to a single frequency of oscillation. Tight coupling of the oscillation transformer tends to give a broad wave, whereas loose coupling gives a sharp wave. (See *Décément*.)

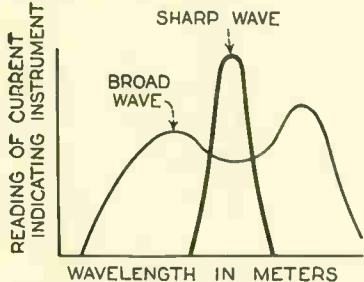

Graph showing difference between sharp and broad waves.

**SHIELDED TRANSFORMER**—An audio or a radio frequency transformer surrounded by a metal casing. Shielding of radio frequency transformers prevents interference from external

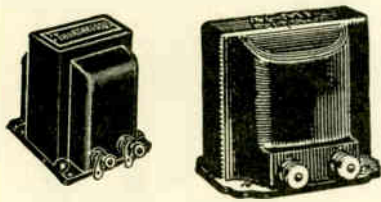

Typical shielded transformers.

fields and also keeps body capacity from affecting the tuning. Audio frequency transformers are shielded mainly to prevent interaction between the flux from the transformer and other parts of the radio set.

**SHIELDING**—Metallic screening placed around radio apparatus to prevent interference from stray electromagnetic or electrostatic fields. In radio sets, the inside surface of the panel is often shielded by means of a metallic lining, thus eliminating body capacity. It is usual to ground the shielding. In sets having more than two stages of radio frequency amplification complete shielding is essential. (See *Induction Screen*.)

**S.H.M.**—Abbreviation for *Simple Harmonic Motion* (q.v.).

**SHOCK EXCITATION**—See *Impact Excitation*.

**SHORT**—See *Short Circuit*.

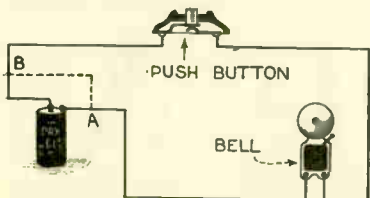

The dotted line between A and B represents a conductor short-circuiting the dry cell.

**SHORT CIRCUIT**—A short circuit re-

fers to a condition of an electrical circuit whereby an external path of low resistance is connected across the source of electrical energy. A short circuit is accompanied by an increase in current flow, although this current is no longer usefully employed. Apparatus may be protected from short circuits by means of *circuit breakers* (q.v.) or *fuses* (q.v.).

**SHORTENING CONDENSER, or ANTENNA TUNING CONDENSER**—A condenser connected in series with the antenna and the ground, for the purpose of diminishing the natural wave length.

**SHUNT WOUND GENERATOR**—A generator in which the field winding is shunted across the armature terminals. The resistance of the shunt winding is made high enough so that only a small percentage of the load current flows through it.

**SHUNT WOUND MOTOR**—A motor in which the field winding is connected in parallel with the brushes (and the armature winding). The speed of a shunt motor is practically constant, but falls to a slight extent as the load is increased. The drop in speed may be only a few per cent between no load and full load, for large motors, while for small ones it may be as high as 15 per cent. As the load on a shunt motor is increased, the torque

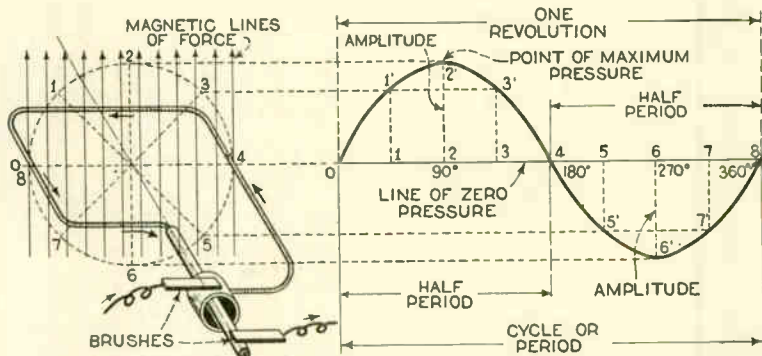

A sine curve is shown at the right. At the left a coil is shown rotating in a magnetic field. As the coil cuts the magnetic lines it generates the varying electromotive force represented by the sine curve.

which the motor develops will increase and the armature current will also increase in almost direct proportion.

**S.I.C.**—Abbreviation for *Specific Inductive Capacity* (q.v.).

**SIDE BANDS**—A group or band of frequencies formed by the interaction of the *Carrier Wave* (q.v.) and the modulations above and below the main carrier wave frequency. (See *Harmonics*.)

**SIGNAL, STRAY RADIO**—See *Strays*.

**SILICON**—A metalloid occurring widely in nature. It is a component of most of the rocks forming the earth's crust. Silicon crystals are used as detectors in radio work. (See *Crystal*, also *Silicon Detector*.)

**SILICON DETECTOR**—A *crystal detector* (q.v.) using silicon as its crystal. The silicon is used in a crystalline state and a *cat-whisker* (q.v.) is generally used to locate the *sensitive spots* (q.v.) and make contact.

**SIMPLE HARMONIC**—Referring to a *simple harmonic motion* (q.v.). If a point moves at a uniform rate around a circle and the point is projected in

a straight line in the plane of the circle, the back and forth motion of the projected point is referred to as *simple harmonic motion*. True simple harmonic motions are the motions of a pendulum, a vibrating tuning fork, particles of water in a wave, etc. Other motions which are not precisely simple harmonic motions may be treated as resulting from several such motions. Examples of these are motions occurring in alternating currents in light waves, in electric waves and in sound waves.

**SIMPLE HARMONIC MOTION**—Abbreviation S.H.M.—The motion executed by the foot of a perpendicular let fall on the diameter of a circle from a particle moving with uniform velocity in that circle. The piston rod of a steam engine, turning a crank uniformly approximates a simple harmonic motion.

**SIMPLE HARMONIC VIBRATIONS**—The vibrations of a body such as a tuning fork which follow the law of *simple harmonic motion* (q.v.). (See *Angular Velocity*, also *Simple Harmonic*.)

**SINE CHARACTERISTIC OF ALTERNATING CURRENT**—See *Sine Curve*, also *Sine Wave*.

**SINE CURVE**—A curve whose perpendicular at any point is proportional to the sine of the angle corresponding to that point. The sine curve is used to represent the changes in direction and

strength of an alternating current or voltage. The coil illustrated at the left in the accompanying diagram generates a sine wave current as it revolves through the magnetic field shown by the arrows. When the coil is moving parallel to the magnetic flux, no electromotive force is induced and hence current flow is zero. As the coil is rotated in a clockwise direction, it cuts the flux at a greater and greater angle, until the maximum is reached when the flux is cut at a right angle. This gives a gradually increasing electromotive force (and hence current) until maximum is reached, then when the angle at which flux is cut decreases, the electromotive force decreases until the coil again moves parallel to the flux, at which point electromotive force is again zero. Then when the coil starts to cut the flux in the opposite direction, electromotive force is reversed, increasing to a maximum and then decreasing to zero thus completing the *cycle* (q.v.). Current or electromotive force in one direction (positive) is represented by the height of the ordinates of the sine curve above the line, while current in the re-



verse direction is represented by the height of the ordinates below the line. The horizontal distances (abscissae) represent time generally measured in phase angles (position of coil at any particular instant). (See *Alternating Current, also Curve of Sines.*)

**SINE WAVE**—As referring to an alternating current, a sine wave or a simple alternating current, is a current whose wave shape is sinusoidal. The wave shape is the shape of the curve obtained when the instantaneous values of the current are plotted against time in rectangular co-ordinates. The wave shape is independent of the frequency and of the scale to which the curve is plotted.

**SINE WAVE OF ALTERNATING CURRENT OR E.M.F.**—See *Sine Wave.*

**SINGING ARC**—See *Duddell Singing Arc.*

**SINGING SPARK**—A spark used in a wireless telegraph transmitter which produces a singing note in the receiving head set. A spark which occurs at regular intervals and at an audible frequency such as that obtained in a quenched spark system of wireless telegraphy.

**SINGLE CIRCUIT TUNER**—A regenerative receiving circuit in which the antenna and grid circuits are conductively coupled. *Feedback* (q.v.) is obtained by placing the plate circuit in inductive relation with the primary.

**SINGLE-PHASE**—This term is used to refer to an alternating current, an alternating current system of distribution, or to alternating current apparatus. A single phase system or circuit is one energized by a single alternating electromotive force. A single phase circuit is usually supplied through two wires. The currents in these two wires counted outwardly from the source, differ in phase by one-half a cycle (180 degrees). In the single phase generator the voltage per phase is the same as the voltage between the lines and the current per phase is the same as the current per line. Since there is a great saving of copper in the use of three phase transmission of power, three phase generators are more frequently used than single phase machines. (See *Alternator.*)

**SINOIDAL VIBRATION**—See *Simple Harmonic Motion.*

**SIPHON RECORDER**—A moving coil galvanometer originally used for recording messages sent over long submarine cables. The received currents are passed to a coil suspended in a strong magnetic field. This coil carries a fine glass syphon which discharges ink onto a moving paper tape. In cable signaling, dots and dashes are usually indicated by opposite deflections which result in a wavy line being produced on the tape.

**SKINDERVIKEN TRANSMITTER BUTTON**—A small carbon grain microphone (q.v.) button less than an inch in diameter and about half an inch high containing a polished metal



Fig. 1. Skinderviken Transmitter Button.

lic button affixed to a mica diaphragm and a surrounding case of brass, the space between the case and the pol-

ished button being partially filled with a good grade of carbon granules. The button is very sensitive to sound waves when it is attached to any form of a

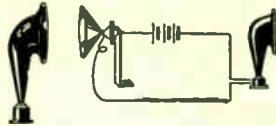

Fig. 2. Retransmitting radio programs.

diaphragm, thus making it applicable wherever a sensitive telephone transmitter should be used. Fig. 1 shows the external appearance, full size, of the Skinderviken button. This transmitter button has a number of applications in radio work and can be used in connection with speech amplifiers,

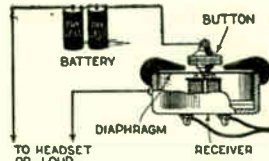

Fig. 3. Retransmission from ear phone.

telephone transmitters, detectaphones, etc. It can be made to transmit in any position, either horizontal or vertical. It is small enough to be readily concealed. Fig. 2 shows how radio music can be re-transmitted to distant points and incidentally amplified at the same time. The microphone but-

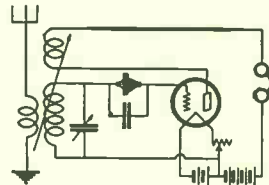

Fig. 4. Button used as grid leak.

ton is shown fastened to a cone and mounted in front of the loud speaker. The leads from the button are connected in series with several dry cells and another loud speaker at a distant point. Fig. 3 shows how the trans-

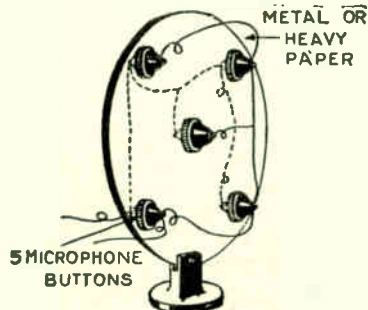

Fig. 5. Combining buttons to form sensitive microphone.

mitter button can be attached to an ordinary receiver to produce the same effect. In this case also, the leads are

connected in series with several dry cells and with a low resistance phone at the distant end. In Fig. 4 the transmitter button is shown in use as a grid leak in a regenerative circuit. Where it is desired to get greater sensitivity and volume for either radio telephone transmitting or for ordinary phone transmission the system illustrated in Fig. 5 will be found highly suitable.

Fig. 6 shows the construction of a hand microphone for transmitting sets

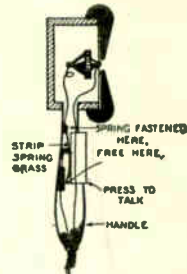

Fig. 6. Construction of hand microphone.

or for inter-departmental telephone circuits. A very simple circuit closer is mounted in the handle of the microphone which in this particular case is simply an ordinary piece of wood hollowed out to receive the switch and the wires. This wooden handle is then fastened to the rubber case of a telephone receiver. The coils and magnets in the telephone receiver are removed, a small hole is drilled or punched in the diaphragm, and the transmitter button is fastened as indicated in the diagram.

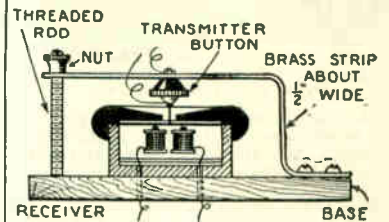

Fig. 7. Method of fastening a button to ear phone.

Another method of fastening a transmitter button to a telephone receiver is illustrated in the diagram in Fig. 7. Here the transmitter button is mounted on a brass strip which is bent so that the center of the button will rest upon the diaphragm of the telephone receiver fixed to the base. A threaded rod and nut regulate the pressure of the button against the diaphragm. In the event that it is not desired to make any changes to a pair of telephone receivers, the transmitter button can be

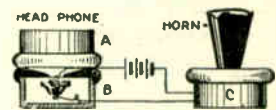

Fig. 8. A simple form of amplifier.

fastened in the shell of an old receiver, B in Fig. 8, and the head phone may be rested on the shell. For

use with a Baldwin receiver, a microphone transmitter button is fastened to it in the following manner: The diaphragm of the Baldwin receiver is

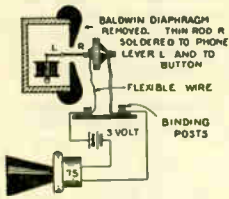

Fig. 9. Button attached to Baldwin 'phone.

first removed, and a thin rod is soldered to the lever, as indicated in Fig. 9. The transmitter button is then soldered to the rod as shown. Another

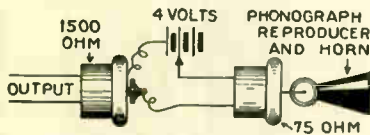

Fig. 10. Loud speaker operation from 1-tube set.

way of making a loud speaker set from an ordinary one-tube receiving set is illustrated in Fig. 10. Where a phonograph is available, the hook-up illustrated may be employed, placing the reproducer of the phonograph on the

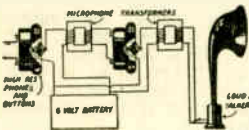

Fig. 11. An effective radio amplifier.

receiver, which should be placed in a suitable position on the turntable. Inasmuch as the movement of the diaphragm of the seventy-five ohm receiver is an up and down one, the reproducer of the phonograph should be turned as it would be for "hill and dale" records. A tiny drop of solder should be dropped upon the diaphragm of the seventy-five ohm receiver and a small nick placed in the center of the solder for receiving the needle of the phonograph reproducer.

Very often it is desired to further amplify the music or sounds picked up by a transmitter button. For this purpose, microphone transformers, or as they are better known, modulation or telephone induction transformers, are employed. In Fig. 11 this instrument is illustrated, together with the circuit for its use. Here the incoming radio

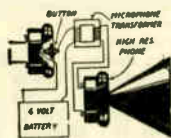

Fig. 12. A single stage amplifier.

signals are made to operate the microphone fastened to the receiver. The current which the microphone passes then goes through the primary of the microphone transformer, the second-

ary of which is connected to another receiver similarly fitted with another transmitter button. The output of the second microphone transformer is then connected to a loud speaker. A dia-

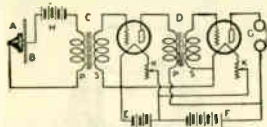

Fig. 13. A 2-stage vacuum tube amplifier.

gram for using but one stage of amplification through transformers is illustrated in Fig. 12. For the better class of work, however, it is desirable to use a standard vacuum tube amplifier as illustrated in Fig. 13. Here the microphone button is placed in series with the primary of a modulation transformer, and in series with several dry cells or flash light batteries. The secondary of the modulation transformer then connects to the grid and filament, the same as it would in a standard vacuum tube amplifying circuit. The music from

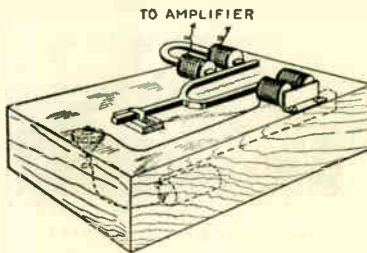

Fig. 14. A tuning fork oscillator.

the output is, of course, very loud. A very splendid oscillator is illustrated in Fig. 14. Here a tuning fork of standard frequency is mounted on a suitable holder in a cigar box. Two low resistance coils, about five to

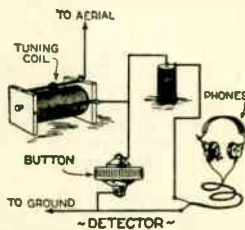

Fig. 15. Transmitter button used as radio detector.

seventy-five ohms, are then placed under one prong of the tuning fork. These are connected in series with the transmitter button fastened in the cigar box, which serves as a base for mounting the tuning fork. The batteries may be concealed in the cigar box. Thus when the tuning fork is struck, it will continue to vibrate as long as the current is applied to the microphone. To use this as an oscillator, a pair of magnets from a telephone receiver and the permanent magnets are mounted near the other vibrating prong. The current constantly being changed by means of the vibrating bar of steel produces a standard frequency, which when amplified can be used for making radio measurements of different kinds. Fig.

15 shows the transmitter button connected in a radio circuit for use as a detector of radio waves. Fig. 16 shows a method of making a code practice device. An audio frequency howl is produced which will enable an instructor to teach an entire classroom the radio code. Sometimes the key, instead

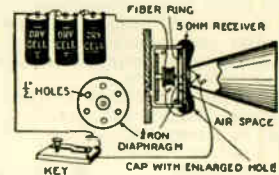

Fig. 16. A code practice machine.

of interrupting the circuit, merely shunts a small portion of the current passing through the transmitter button, and for this purpose the key

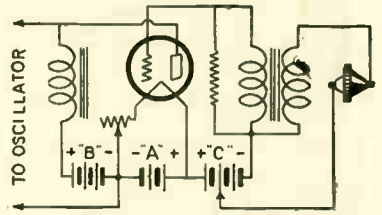

Fig. 17. Use of button in Heising modulation system.

would have to be placed directly across the transmitter button and in series with a small resistance. Fig. 17 shows

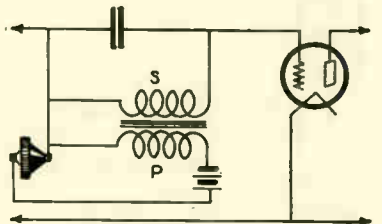

Fig. 18. Method of varying grid voltage of oscillator tube.

how the transmitter button may be used in Heising modulation. Fig. 18 indicates its adaptation to the variation of grid voltage of the oscillator

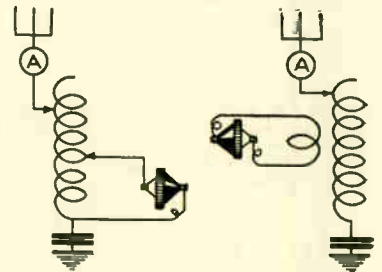

Fig. 19. Method of modulating output current.

tube and Fig. 19 shows how the transmitter button may be hooked up to modulate the output current. These last three figures indicate the use of transmitter buttons in vacuum tube transmitters.

**SKIN EFFECT** — The name given to the crowding of alternating or oscillatory currents into the surface layers of a solid conductor. This phenomenon increases with increased frequency. As a result the resistance of solid conductors is much higher at high than at low frequencies. (See *High Frequency*, also *High Frequency Resistance*.)

**SLABY-ARCO-SYSTEM** — A system of wireless telegraphy which used a quenched spark gap. This system is now obsolete.

**SLABY-ARCO-VACUUM COHERER** — A filings coherer enclosed in a sealed glass tube from which the air has been extracted.



A Slaby-Arco vacuum coherer.

**SLIP RINGS** — Metallic rings, separated by insulators, from which collecting brushes pick up current generated by an alternator. Slip rings take the place of the commutator used on the direct current generator.

**SLOTS** — Channels cut in the armature core discs and into which the windings fit.

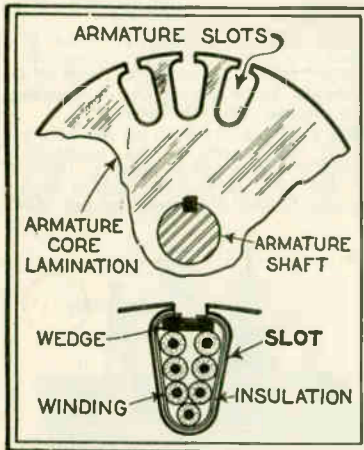

Details of armature slot.

**SLUDGING OF TRANSFORMER OIL** — The thickening of the oil used for cooling in large transformers. A muddy deposit is formed due to oxidation. The presence of metallic copper in contact with the oil is considered to hasten this action catalytically.

**SOAKING-IN** — An increase in a condenser charge above its initial value, which takes place gradually if the potential is kept applied. Soaking-in takes place due to a change in the dielectric (q.v.).

**SOAKING-OUT** — A gradual continuation of the discharge of a condenser after the first rapid discharge. In this case, the dielectric is returning to its original state.

**SOCKET** — A receptacle for holding and making electrical connections with a vacuum tube, an incandescent lamp, or a connection plug. Vacuum tube sockets are made of bakelite, hard rubber, porcelain, pyrex and other suitable dielectrics (q.v.). They are usually molded. One type of socket is composed of a shell of insulating material, or in some cases of metal. Four contact blades extend within the base

of the socket, for making contact with the prongs of the tube. These blades may be of strong phosphor bronze. Their outer ends are attached to binding posts. It is important that the base supporting the binding posts and

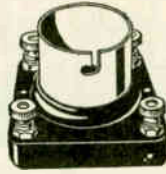

A metal shell socket.

contacts be of good insulating material such as bakelite or hard rubber. Modern sockets are of the *spring* or *shock absorbing* type. This construction protects the tube and does away with microphonic sounds. One type of spring socket consists of two molded bakelite parts, the outer one square with a binding post at each corner and the inner one circular with holes for the tube prongs and steel spring contacts fastened underneath the holes.



Shock absorbing or spring-type socket.

The circular molding is suspended within the square one by means of two rubber pads. Other types of shock absorbing sockets use spring suspension instead of rubber.

**SOFT IRON INSTRUMENTS** — Ammeters, voltmeters and other measuring instruments which depend upon the magnetic force between a current carrying coil and a movable core of soft iron to produce the deflection of the needle or pointer. The movement of the iron may be controlled by a spring or by gravity. These instruments may be used for either direct or alternating current measurements. They are not as accurate as instruments of the dynamometer type.

**SOFT TUBE** — A vacuum tube which contains a gas content instead of being highly evacuated. Soft tubes were formerly recommended for use as detector tubes but at present have been superseded for this use by the ordinary amplifying tube.

**SOLDER** — An alloy of lead and tin used for making good electrical connections.

**SOLDERED JOINT** — A connection between two metallic surfaces, cemented together by means of solder. Where the joint is between two electrical conductors, it must be made both mechanically and electrically secure.

**SOLDERING** — The process of joining together two or more conductors or other metallic surfaces by means of solder, so as to give a good electrical or mechanical connection, or both. After the surfaces to be united are carefully cleaned, a flux is applied to dissolve the oxides which occur on the surface of the parts to be joined with solder.

**SOLDERING FLUX** — A substance used to dissolve the oxides on the surfaces

of the metals to be soldered. When these oxides are dissolved, the flux enables the solder to enter the minute pores of the metal surface, effectually sealing it against the penetration of oxygen. Fluxes range in character from very strong acids to very mild acid bearing substances. For radio use, it is necessary to use a flux which is non-corrosive and which in its use will leave a residual matter that will have no tendency to collect moisture, dust, or other foreign material. Rosin has been found to be very suitable as a flux in radio soldering. (See *Flux*, *Soldering*.)

**SOLENOID** — A coil of wire of helical form used as an electromagnet, generally to attract a movable iron plunger, which is drawn within the

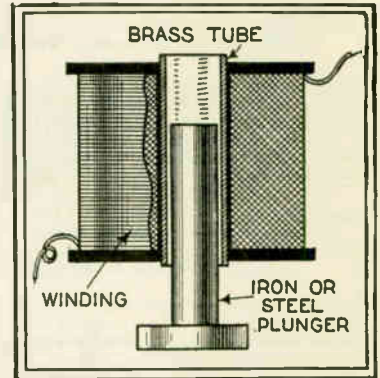

A typical solenoid.

solenoid when the current flows through the windings. The solenoid never has a fixed core. A coil wound on a cylinder so as to give uniform magnetic field within it when traversed by a current is often called a *straight solenoid*.

**SOLODYNE** — A radio circuit which dispenses with high-tension or "B" batteries and which utilizes a double grid vacuum tube. The solodyne principle is also known as the *Unidyne*. The theory of the solodyne is as follows: The small plate current due to the electron emission from the lighted filament passes through the tickler coil which feeds back to the main grid circuit in the usual way, the primary of a step-up transformer, through the telephone receivers, and then back again to the filament of the tube. The electron stream passing from the filament to the plate inside the tube must pass the two grids. The first of these, which may be referred to as the additional grid, is primarily made positive by connecting it directly to the positive terminal of the "A" battery. This in itself tends to assist the electron stream, to reduce the resistance of the vacuum of the tube. But the additional grid is assisted in its work by having impressed upon it the stepped up voltage from the plate circuit, due to the transformer, the secondary of which is in direct connection with the additional grid. Thus a building up process is introduced, every possible electron primarily due to the electron emission of the filament of the tube being made use of and ultimately passing through the telephone receivers to be reproduced in the form of audible signals. The main grid functions in the usual manner, except that this too, can be made to help the additional grid as well, by giving it a strong positive bias. A typical Solodyne circuit is

**Sounder.**

shown in Figure 1. In this circuit L and L' may be honeycomb coils or a variocoupler. In Figure 2 is shown the

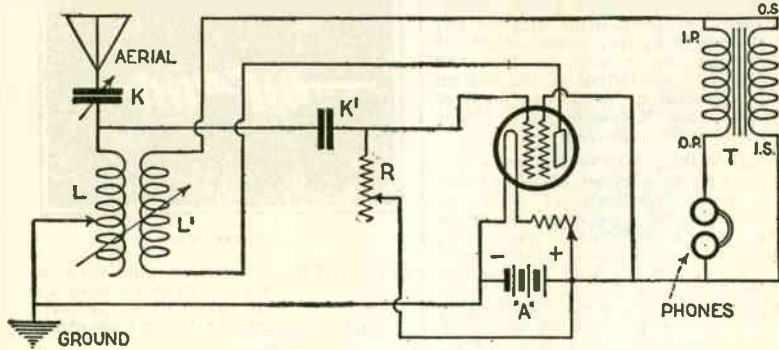

A Solodyne circuit. L and L' may be honeycomb coils or a variocoupler.

Cowper Solodyne circuit which utilizes standard tubes. In this diagram, the numbers printed near each coil indicate the size of honeycomb or duo-lateral coils to use in each circuit. (See Four Element Tube.)

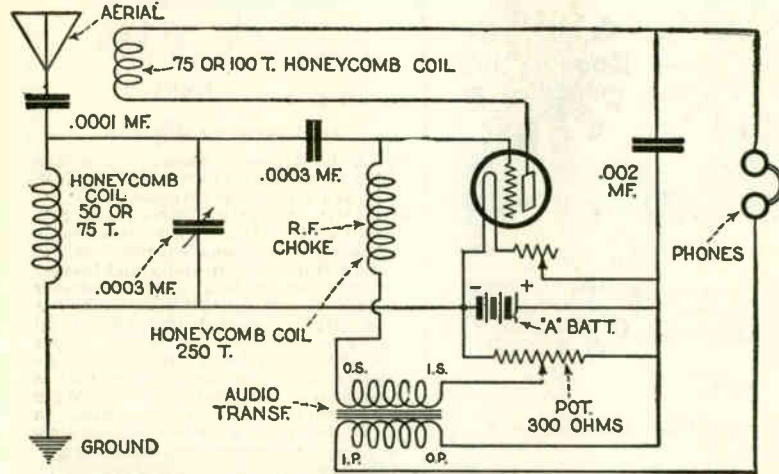

The Cowper circuit uses no "B" battery and is quite stable in operation.

**SOUNDER**—An instrument used for receiving telegraph signals which utilizes the attraction of an armature by an electromagnet to make sounds as the armature hits against stops at the beginning and end of each current impulse. The sounds thus produced form the characteristic dots and dashes of

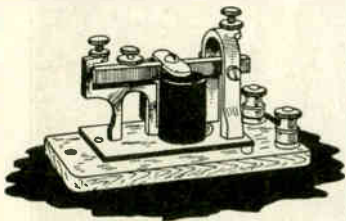

Telegraph sounder.

the telegraph code and can be easily read by the experienced telegraph operator.

**SOUND WAVE**—A wave of alternate condensation and rarefaction through an elastic body such as air, water, etc. Sound waves travel at the rate of 1090 feet per second in air.

**SOUTH MAGNETIC POLE**—Situating in Latitude 70 South and Longitude 102 East. The South Magnetic Pole

does not coincide with the geographic South Pole. **SOUTH POLE**—When referring to a magnet, the pole which tends to point to the south when the magnet is freely suspended.

**SOUTH SEEKING POLE**—See South Pole.

**SPACE CHARGE**—The difference between the number of electrons and positive ions in unit volume, multiplied by the charge per ion. This is also called the volume density of electrification. Let us consider the distribution of electrons in a vacuum tube, between the hot filament and the plate. An electron close to the surface of the plate is attracted to the plate by two forces, attraction from the plate and repulsion from the electrons located between it and the filament. An electron close to the surface of the filament, however, is repelled by the electrons between the plate and itself, although it receives some attraction from the plate. It may either move towards the plate or go back to the filament. This will depend upon whether the plate voltage is high enough to result in a force of attraction sufficiently great to overcome the repulsive force of the space charge.

**SPACE CURRENT**—Current which flows between the cathode and the anode in a vacuum tube. Space current is the result of the motion of electrons through space. It does not

follow the same laws which govern the flow of current in a metallic circuit, deviating from Ohm's law to a certain extent, depending upon the relation between the impedances of the tube and the metallic portion of the circuit and also upon the nature of the discharge. **SPAGHETTI**—A varnish-impregnated cloth tubing used to insulate bare conductors. (See *Cambric, Varnished.*) **SPARK**—See *Spark Discharge.* **SPARK COIL**—An induction coil (q.v.) used to produce spark discharges (q.v.).

**SPARK DISCHARGE**—A passage of electrical current between two conductors across a previously non-conducting space. The discharge is accompanied by light, heat and sound. It may take place through a liquid, a solid or a gas but whenever it occurs, it means that there has been a breaking down of the dielectric stress. A spark passing through a solid will puncture it. The passage of a spark through a liquid does not affect the dielectric properties of the liquid. On the other hand, a spark passing through a gas, usually ionizes the gas for a period of time after the passage of the discharge and as a result a continuous arc may follow the first spark. An oscillating current (q.v.) may produce a rapid train of sparks which persists until the oscillations are damped out. (See *Sparking.*)

**SPARK DISCHARGER**—A form of spark gap (q.v.) such as a rotary discharger (q.v.) or a fixed gap, such as a quenched spark gap (q.v.). (See *Discharger, also Disc Discharger.*)

**SPARK GAP**—A break in an oscillating circuit which acts as an automatic safety valve to the condenser. Since the air between the gap has a high resistance, the condenser cannot dis-

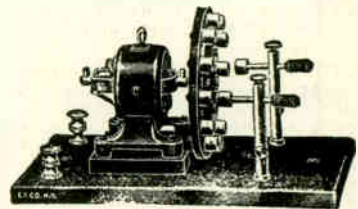

A rotary spark gap.

charge until the potential is sufficient to break down its insulation, thus permitting only heavy discharges to take place. (See *Quenched Spark Gap, Fixed Discharger, also Safety Gap.*)

**SPARKING**—The production of spark discharges, especially when an inductive circuit is broken. Sparking at the brushes of a motor or generator is caused by armature reaction and self-induction. Sparkless commutation can be obtained by shifting brushes or by the use of *interpoles* (q.v.). Sparking is injurious to contact surfaces and should be avoided if possible. Sparking between contacts of induction coil vibrators is usually reduced by placing a condenser across the gap.

**SPARK MICROMETER**—A graduated adjustable spark gap for determining sparking distances for various voltages, etc. This device also permits the approximate measurement of high voltages provided the sparking distances for the particular type of terminals, are known.

**SPARK RATE, SPARK FREQUENCY, or GROUP FREQUENCY**—The number of sparks per second occurring in a spark system of wireless telegraph

transmission. It refers to the *Group Frequency* of the wave train rather than to the waves themselves.

**SPARK RECORDER**—An instrument for recording telegraph signals, in which sparks from an induction coil pass through and mark a paper tape carried on a drum which turns under a metallic pointer. The use of a spark recorder dispenses with the use of ink, thus doing away with the friction of the pen on the paper.

**SPARK TRANSMISSION**—A wireless telegraph transmitting system which uses a succession of spark discharges in an oscillating circuit, to produce oscillations. These traverse an aerial system and a series of short trains of damped waves are emitted.

**SPECIFIC GRAVITY**—abbreviation S.G.—The weight of a body compared with that of another, having equal bulk, considered as a standard. The standard for liquids and solids is water, while hydrogen or air is the standard for gases. The specific gravity test of the radio storage battery is an important means of testing the condition of the battery. A *hydrometer* (q.v.) is used for this purpose.

**SPECIFIC INDUCTIVE CAPACITY**—symbol *k*—abbreviation S.I.C.—A measure of the degree to which a body permits electrostatic induction through it. The ratio between the capacities of two condensers, one employing the material under consideration as the dielectric and the other using an air or vacuum dielectric. The Specific Inductive Capacity of a material is the *inductivity* (q.v.) of that material relative to that of air. (See *Inductive Capacity* also *Dielectric Coefficient* or *Constant*.)

**SPECIFIC RESISTANCE**—The resistance in ohms, of unit length and unit cross-section of a conductor. (See *Resistivity of a Material*, also *Resistivity, Surface*.)

**SPECTRUM**—An image formed by rays of light or other radiant energy in which the parts are arranged according to their refrangibility or wave length. The image may be visible or invisible. The arrangement is such that all parts of the same wave length fall together, while those of different wave lengths are separated from each other forming a regular series. The spectrum produced by the light of the sun passing through a triangular glass prism and falling on a screen is one of the most common forms. The various colors, since they are unequally refracted, are spread out into a band, showing the seven rainbow colors. The red is at one end (that of the least deviation), while the violet is at the other end.

**SPEECH AMPLIFIER**—An audio frequency amplifier designed especially for public address systems, where addresses are to be heard over a comparatively wide area. By means of speech amplifiers, it is possible for one speaker to address an unlimited number of listeners.

**SPEECH MODULATION**—The modulation of radio frequency currents, as utilized in radio telephony. The production of speech modulated waves calls for a source of undamped waves and a method of causing variations in the current output of this source which will accurately correspond to the vibrations of the voice. The source of undamped waves may be a high-frequency alternator or an electron tube generator, the latter being in

most common use. The radio frequency antenna current may be varied by inserting a speech-controlled variable resistance, such as a microphone, in the antenna circuit at the transmitter. The microphone may be put in the direct current power supply of the generating system, so that the radio frequency output of the system will be varied as the power input is varied. (See *Modulation*, also *Modulation Frequency Ratio*.)

**SPEECH VIBRATIONS**—The wave corresponding to a given sound. There are various methods of obtaining graphically, the picture of the wave form of any particular sound. One method is to make a phonograph record of the sound and then as the sound is reproduced from the record, to magnify the movement of the needle, using a lever to trace the form of the waves.

**SPIDER WEB COIL**—A form of inductance coil in which the wires are wound on a frame consisting of radiating arms similar to the spokes of a wheel. The wire is wound in successive turns in and out around the arms,

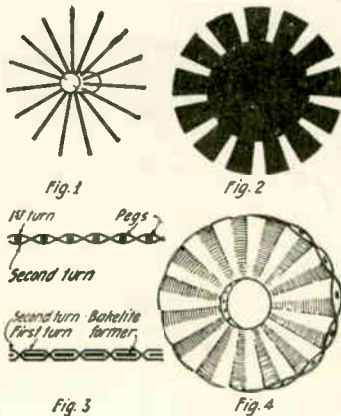

Details of spider web coil construction.

starting from the center, until it reaches the ends of the arms. An odd number of turns are used so that alternate turns will follow the same wave; that is to say, adjacent turns will be on opposite sides and separated by an arm. Coils of this type have comparatively low distributed capacity and in addition have the advantage of being extremely compact. Figure 1 illustrates the frame on which the wire is wound. This is known as the *spider*. A spider cut from  $\frac{1}{16}$  inch bakelite, as shown in Figure 2, can also be used, although, owing to a smaller number of divisions, the latter does not have such a large inductance as the former. In winding, the wire is fastened around one of the pegs and is then taken in and out around the pegs, as shown in Figure 3. When starting the second turn, the wire will be around the pegs the opposite way to the first turn, and all successive odd-number turns will be on the same side as No. 1, while all successive even number turns will be on the same side as No. 2. The finished coil is shown in Figure 4. Spider web coils are also known as *basket wound* (q.v.), *basket woven*, or *stagger wound* coils.

**SPLICE**—A method of joining two or more conductors by interweaving or

entwining the strands, in a similar manner to that of splicing a rope.

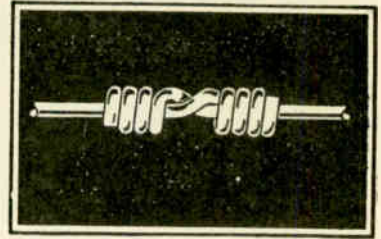

A strong splice.

**SPREADER**—A spar or pole used on an aerial, where two or more wires are used, to keep these wires properly spread out and parallel to each other.

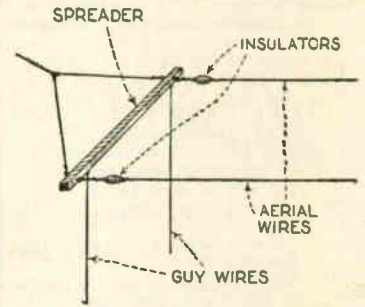

Aerial showing use of spreader.

**SQUARE MIL**—A square mil is the area of a square, one mil, or 0.001 inch on each side. (See *Circular, Mil*.)

**SQUIER, MAJOR-GENERAL SIR GEORGE OWEN**—American radio authority. He was educated at the Johns Hopkins University and became a research student under Professor Rowland and Sir William Preece at the British General Post Office. In 1904 he published his famous paper on the absorption of electromagnetic waves by living vegetable organisms and showed how trees could be used for the reception of radio messages. In 1911 he read a paper on multiple



Major-General George Owen Squier.

telephony before the American Institute of Electrical Engineers. In 1912 he was awarded the Elliot Cresson Gold Medal for his researches in multiple telephony and in 1919 the Franklin Medal of the Franklin Institute. Major-General Squier was awarded

## Squirrel Cage Ind. Motor

the K. C. M. G. for distinguished services during the World War. He is a member of the National Academy of Sciences and the International Electro-technical Commission. He is the inventor of *Line Radio* (q.v.) which is also known as *Wired Wireless*, *Wire-Radio Telephony*, *Guided Wave Telephony*, and *Carrier Current Telephony*.

**SQUIRREL CAGE INDUCTION MOTOR**—A type of induction motor having a rotor consisting of copper bars connected to rings at each end so as to form a short-circuited system. There are no windings in this type of rotor nor are there any external connections through slip rings. These motors are used for constant speed work, where starting is necessary only at infrequent intervals. The squirrel cage motor draws a large starting current, but has a relatively small starting torque. It is possible, however, by properly designing the rotor so as to have enough resistance, to use small motors of this type for loads requiring frequent starting, rapid acceleration and high starting torque.

**SQUIRREL CAGE ROTOR**—See *Squirrel Cage Induction Motor*.

**STAR GROUPING**—A method of connecting up polyphase apparatus or circuits. One end of each phase is connected to a common point, usually called the neutral point. This method of connection is called a "Y" grouping, in the case of a three-phase system.

**STATIC**—An irregular disturbing noise, heard in the radio loud speaker or head set due to atmospheric discharges, lightning and similar phenomena. A common form of static produces an

plate resistance of the tube. In cases where the external circuit contains reactance, the true characteristic could not be obtained using direct current. In this case, an alternating electromotive force is impressed on the grid and the curves obtained are known as *dynamic characteristics* (q.v.).

**STATIC ELECTRICITY**—Electricity which is stored in a circuit, manifesting itself in the form of charges at high potential. Electricity, as produced by frictional or influence machines.

**STATIC ELIMINATORS**—A device for eliminating or reducing the effect of static (q.v.). Various circuits have been proposed for accomplishing static elimination. Some of the most recent and successful of these are the McCaa anti-static circuits described in the July, 1925, issue of *RADIO REVIEW*, on page 63. There are two types of McCaa circuits, one applicable to radio telegraphy and the other to radio telephony. Both have for their object the reduction of signal static ratio. The wiring diagram shown is that of a standard five-tube neutrodyne receiver plus a McCaa anti-static device of the receiver type. In this diagram Ta is the repeater tube, Tb and Tc are the two radio-frequency amplifier tubes, Td is the detector tube and Te and Tf are the two audio-frequency amplifier tubes. The circuit from tube Tb on is unchanged and is the same as any standard neutrodyne receiver. The input circuit of tube Tb, however, and also the antenna circuit, have been

22 d. c. c. wire. The coupling between these coils is not variable. After the proper value of coupling has been found by experiment it may be made permanent.

Coils Ld and Lq are also shown coupled in the diagram. They may be 50 and 75 turn honeycomb coils, respectively, or 60 and 90 turn homemade coils wound on a three-inch diameter tube with No. 22 d. c. c. wire. The coupling between these coils is also fixed after the proper value has been determined by experiment.

The proper values for the various capacities used in this circuit are as follows: Co., .001 mfd. (43 plate); Cs, .000035 mfd. (17 plate); Cr., .00035 mfd. (17 plate); Cd, .00035 mfd. (17 plate).

In building this set it is advisable to place both the anti-static device and the receiver in the same cabinet. This cabinet must be shielded and the shield should be connected to the ground. It is also advisable to shield the anti-static device from the receiver proper. The batteries should also be shielded either by placing them inside the cabinet or in metal boxes which are connected to the ground. The wires from the batteries to the set may be effectively shielded by using BX cable, the outside covering of which should also be connected to the ground. For the phone wires special phone cords which are shielded with a flexible copper braid are desirable.

**STATIC**—The stationary plates of a rotary condenser. The fixed portion of a motor or a generator, which carries a winding. In induction motors, that

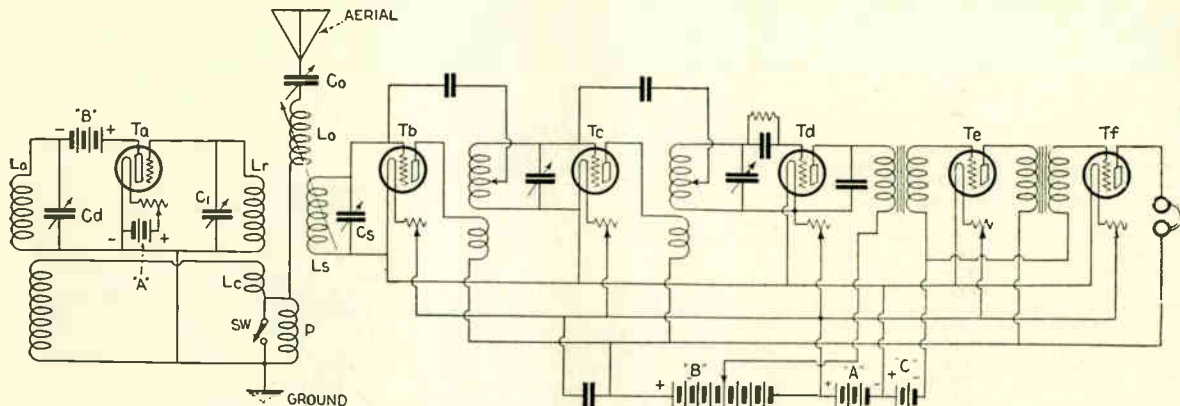

Arrangements of a static reducing device employing repeater circuits.

intermittent crashing sound. Other types cause grinding noises or hissing sounds. Nearby lightning is usually accompanied by a sharp snap in the loud speaker. Various methods have been devised for eliminating or reducing static, although it cannot be said that any of these has been entirely successful. The combination of coil and ground aerials results in the reduction of static; also the use of *beat reception*, using continuous waves as in certain methods of wireless telegraphy. Static is also referred to under various other names, such as *strays*, *atmospherics*, *X's*, etc.

**STATIC CHARACTERISTIC**—The curves obtained by the use of a steady direct-current potential for showing the performance, efficiency, etc., of a vacuum tube. The static characteristics of the tube itself are obtained when the resistance of the external circuit is very small in comparison to the

altered to make possible the installation of the anti-static device.

For the neutrodyne which usually couples the first tube of a neutrodyne to the antenna circuit, the coils L0, Ls and Lp have been substituted. These coils may either be homemade coils or honeycomb coils. If honeycomb coils are selected each may have fifty turns. The coupling between Ls and Lp should be fixed so that the coils are about an inch apart and some arrangement should be made for changing the coupling between L0 and Ls. If homemade coils are used each coil should have approximately sixty turns of No. 22 d. c. c. wire on a three-inch diameter tube and they should be coupled the same as the honeycomb coils.

The coils Lr and Lc are also coupled and may be either 50 and 10 turn honeycomb coils, respectively, or 60 and 10 turn homemade coils wound on a three-inch diameter tube with No.

portion of the motor which is fixed in position and which carries the winding connected to the external circuit. (See *Rotor*, also *Alternator*.)

**STATIC PLATES**—The plates of a condenser which remain stationary in position as differentiated from the plates which rotate. (See *Shielding*, also *Stator*.)

**STOPPING CONDENSER**—A condenser which opposes or prevents the flow of direct current, but which allows alternating current to flow in a circuit.

**STORAGE BATTERY**—See *Secondary Cell*.

**STORAGE BATTERY TESTS**—The testing instrument most commonly used in storage battery work is the *hydrometer* (q.v.). The purpose of the hydrometer is to determine the state of the charge of the battery, as indicated by the *relative specific gravity* of the electrolyte. The specific gravity of a fully charged battery is not a fixed

value but depends entirely upon the standard specific gravity employed by its manufacturer which may be anywhere from 1.250 to 1.300. The user should always ascertain the correct specific gravity for the make of battery before attempting to test it with a hydrometer. A voltmeter may be employed as a means of testing a storage battery provided it is of the proper type and is used correctly. It must be accurate with sufficient length of scale to read tenths of a volt clearly. Voltmeters are obtainable which may be used for both the "A" and "B" batteries whether dry or storage. It is not possible to test the storage "A" battery with cheap types of so-called pocket voltmeters. It must be kept in mind that a voltmeter reading on a storage "A" battery is of value only when the battery is either charging or discharging, except when the battery is practically dead. A voltmeter reading taken when the battery is not connected to the circuit, either charging or discharging, may be misleading. If a reading is taken with the filaments lighted and the voltmeter indicates a full six volts, the battery is charged. Under the same conditions, if the voltmeter lags appreciably below six volts the battery should be charged in order to keep it in the best condition. When it falls to 5.4 volts the battery is discharged and cannot possibly operate the set with any degree of satisfaction. When the battery is connected to the charger and the voltmeter shows from 7.5 to 7.8 volts the battery is fully charged. It is possible to test roughly without instruments. If neither a hydrometer nor a voltmeter is handy it is possible to recognize the necessity for charging by the fact that the amplifying rheostats have to be moved forward of the normal working position, indicating low voltage and that the battery must be charged. When the battery is on the charging line, being charged at the ordinary rate of the commercial charger, and all of the cells of the battery are bubbling, this is an indication that the battery is charged. An interesting meter has recently been placed on the market which should prove of considerable use to owners of storage batteries. It is an ammeter of special design which is to be connected in series with the storage battery on charge. There is a third terminal on back of the instrument by means of which the same instrument can be used to measure the current consumption of the filaments. By pressing a small button in the center of the meter, the needle swings over to the right-hand portion of the scale and indicates whether the battery is fully charged, half charged or low.

**STORAGE CELL**—See *Secondary Cell*.

**STRAIN INSULATOR**—An insulator used under tension, as for example the

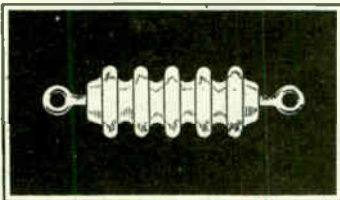

A strain insulator.

insulators to which the guy wires of an aerial are attached. The simplest form of strain insulator consists of a cylinder or ball having an eye-bolt at each end. Where the aerial guy is fastened to a strain insulator, the pur-

pose of the insulator is to prevent the guy from having a natural wave length nearly the same as the wave length of the antenna. A common form of strain insulator is of nearly spherical form and is so grooved as to carry the two wires firmly, without permitting them to come into contact.

**STRANDED WIRE**—A wire made up of a number of smaller wires, twisted or braided together. An uninsulated, large stranded wire is generally referred to as a bare cable. Stranded wires are of four general classes; (1)

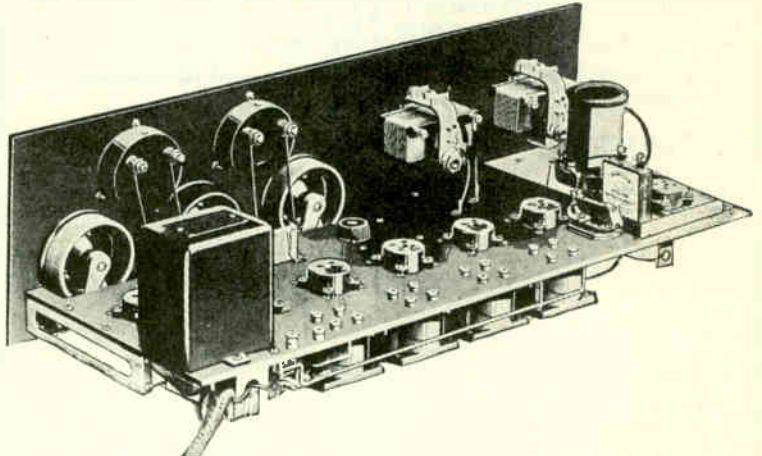

This is the rear view of the Callies Super. Note particularly the long wave transformers at the rear of the set and how they support the sub-panel.

wire braid, (2) bunched wire, (3) rope-lay cables, (4) concentric-lay cables. Wire braid is used to afford

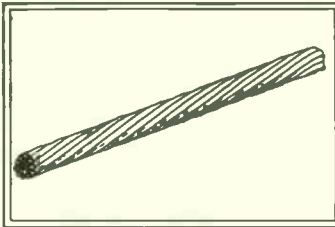

Stranded wire.

protection to the insulation of various types of cable. In flat form, it is used as a flexible lead. Bunched wire is a type of cable also referred to as a cord. This form of cable is very flexible, since the individual wires are small. Rope-lay cables are made up of a central core of stranded wire, having one or more layers of stranded wire wound helically about it. Concentric-lay cables are formed in the same way as the rope-lay type, except that the core and layers are of individual solid wires instead of stranded. Stranded wire is very often used in radio work as aerial wire. It has the advantage of being more flexible than solid wire and it also has a lower resistance at high frequencies because of *skin effect* (q.v.). A greater cross-sectional area is available in the stranded conductor than in the solid conductor of the same weight, for carrying current. If used for radio frequency currents, however it is essential that the individual strands be enameled if the lower resistance is to be attained.

**STRAY CURRENTS**—Currents induced by stray magnetic fields such as eddy currents. Such currents always result in an energy loss. In electric railway systems, the currents returning

through the earth, through piping, etc., rather than through the path provided are known as stray currents.

**STRAY FLUX**—Magnetic flux which is not usefully employed. The *leakage flux* or *leakage lines* (q.v.) which stray from the closed magnetic path provided in a transformer or other electromagnetic or magnetic apparatus. (See *Magnetic Leakage*.)

**STRAYS**—Atmospheric disturbances which manifest themselves as noises in the radio loud speaker or head set. (See *Static*.)

**SUB-PANEL**—A secondary panel in a radio set, mounted at an angle with the main panel. The sub-panel usually carries the transformers, sockets, grid condenser and grid leak. Sub-panels are made of bakelite or composition, hard rubber, etc. (See *Panel*.)

**SUPER-HETERODYNE**—See *Super-Heterodyne Receiver*.

**SUPER-HETERODYNE RECEIVER**—A circuit used in radio reception in which the wave lengths of the incoming signals are increased to several thousand meters, by the aid of a local source of oscillations. It is a recognized fact that radio signals at "radio frequencies," that is, the original signals as they are impressed on the receiving set from the aerial, must be amplified or built up in some way to operate the detector. However, signals at low wave lengths such as in use for broadcasting, cannot be amplified very efficiently at radio frequencies. By changing the waves from the ordinary broadcast band between about 200 and 550 meters to wave lengths of from 4,500 to 10,000, it is possible to obtain more complete amplification. As a result the receiver is more sensitive and greater distance can be received. In the super-heterodyne receiver, a *difference frequency*, termed a *heterodyne note*, is created. This is done by an arrangement for generating oscillations locally. When the incoming oscillations are combined or superimposed with the local oscillations in such a manner that there is a difference in frequency, this difference will be in the form of a new set of oscillations. If the receiver is arranged in such a form that the new set of oscillations has a comparatively low frequency, the wave length will be correspondingly high. In a standard super-heterodyne receiver the action can be imagined as follows: the signal energy

**Super-Heterodyne Receiver**

from a certain transmitting station is gathered on an antenna or loop aerial. These signals are tuned in by means of a condenser in the case of a loop

fier, consisting essentially of a vacuum tube and a radio frequency transformer). At this point in the circuit, between the tuning device and the first

local frequency. In this way, the difference between the incoming oscillations and the locally generated oscillations may be adjusted to a prearranged value or frequency. In inductive relation to the grid and plate coils, another coil is arranged, referred to as a pick-up coil. The energy obtained from the first detector tube signals having a frequency equal to the difference between that of the incoming signals and the local oscillations, is sent to a filter transformer or tuned filter. The construction of this filter and the number of windings used is of the utmost importance, as it determines the frequency of the new set of oscillations and will permit the passage of no other frequency than the desired band. This is a very essential feature, as it is necessary to pass only the desired frequency in order to permit maximum transfer of energy. The energy at this predetermined frequency is then passed to the intermediate frequency amplifier (q.v.). After being amplified or built up by the intermediate frequency amplifier consisting of tubes and transformers, the energy is then passed to the second detector tube and rectified or changed from radio fre-

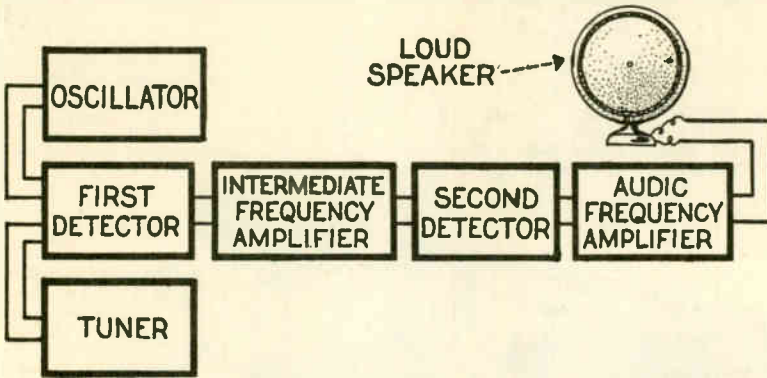

Fig. 1.—This shows the general arrangement of the units of a typical super-heterodyne receiver.

aerial, or by a regular tuning device such as a coupler and condenser in the case of an outside antenna. The energy

detector, the apparatus for producing the heterodyne action is located. This part of the outfit consists of a vacuum

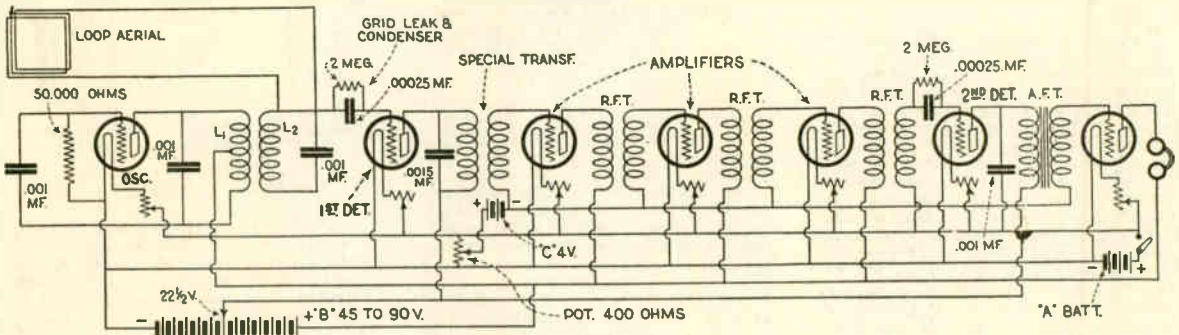
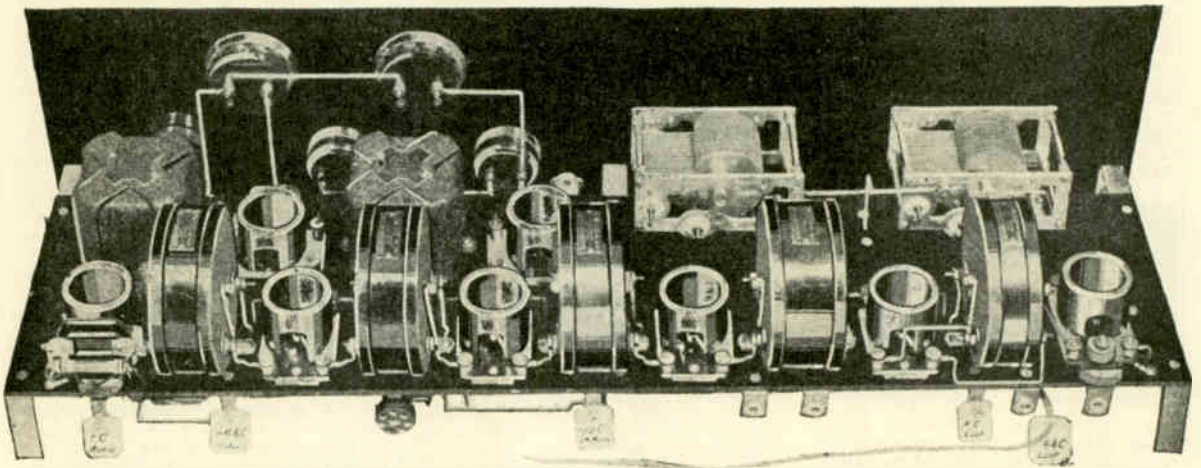

Fig. 2.—Wiring diagram of a standard 7-tube super-heterodyne.

thus obtained is passed through to the grid member of a vacuum tube, which is known as the first detector tube. (In some cases the energy is first amplified by a radio frequency ampli-

tube with coupled coils in the grid and plate circuits, with a variable condenser (the heterodyne condenser) connected across them, having a suitable value for obtaining any desired

quency. The audio frequency signals are now amplified by one or two audio frequency amplifiers consisting of amplifying tubes and transformers and the resulting signals, speech or music



The photograph above shows an eight-tube super-heterodyne set of extra fine quality. Each of the heterodyners are shielded in nickel-plated metal shields. The two variable condensers for tuning the aerial and oscillator circuits should be of the straight line frequency type. The two audio frequency transformers are extra large concert type, the first stage of audio being all that is necessary for average reception on a loud speaker.



are used to operate the loud speaker. Figure 1 shows the general arrangement of the various sections or units of a typical Super-Heterodyne receiver. To go a little more fully into the action of the receiver, let us suppose that a certain station is broadcasting on a wave length of 400 meters. Every wave length is equal to a certain frequency.

That is to say, every wave has a certain number of vibrations per second. The frequency of a wave 400 meters in length will be about 750,000 cycles or 750 kilocycles. By adjusting the wave length condenser, the aerial or loop circuit is placed in resonance with this particular wave length or frequency. This energy is passed through the oscillator pick-up coil and the local oscillations super-imposed on it.

The oscillator condenser, let us say, has been adjusted to permit the oscillator circuit to produce oscillations of a frequency such that the difference between the incoming oscillations and the local ones will be in resonance with the windings of the tuned filter. For instance let us suppose that the tuned filter is arranged for tuning to 10,000 meters, which corresponds to 30,000 cycles.

Now the oscillator circuit must be tuned either 30,000 cycles above or below the incoming wave frequency. In other words, if the incoming wave frequency is as stated—750,000 meters, the oscillator circuit will be tuned to either 780,000 or 720,000 cycles so that the difference between the two frequencies will be 30,000 cycles. No matter what the frequency of the incoming oscillations, the local oscillating circuit will be tuned in a manner to produce the definite difference of 30,000 cycles. These signals will then be passed to the intermediate frequency amplifier and built up before being passed to the second detector tube for rectification.

After this, the signals that are now of audio frequency can be further amplified or built up by the audio frequency amplifier. The two operations that are of the utmost importance in receiving with the super-heterodyne are first, the tuning of the incoming signals and second, the adjustment of the oscillator circuit to produce the difference between two frequencies according to a definite plan. Figure 2 shows the hook-up of a typical Super-Heterodyne receiver.

**SUPER-REGENERATION**—See *Super-Regenerative Circuit*.

**SUPER-REGENERATIVE CIRCUIT**—A radio receiving circuit which permits reception under conditions of operation, which in an ordinary regenerative set would result in howling. In the regenerative set, which is tightly coupled, the signal strength increases to a maximum, and thereafter a still further increase in regeneration will result in greatly increased signal strength for a minute fraction of time, followed by violent oscillations. In the super-regenerative circuit, the signals are received at the point of very high amplification by suitably controlling the set. The great advantage of the super-regenerative circuit is the enormous amplification obtainable. Another advantage is the fact that radio code signals are not amplified to the same extent as radio telephony. The super-regenerative circuit was devised by Major Armstrong. The *Flewelling Circuit* (q.v.) is a modification of the

Armstrong circuit. (See *Armstrong Circuits*.)

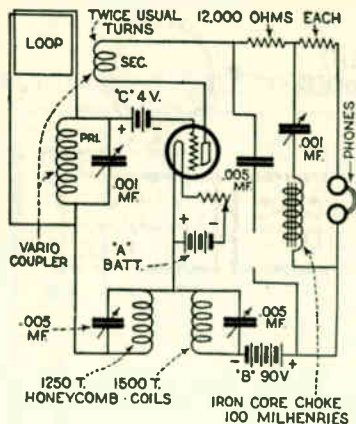

Flivver Armstrong Super-Regenerative circuit.

**SURFACE MAGNETISM**—A synonym for *Free Magnetism* (q.v.).

**SUSTAINED WAVES**—Continuous or undamped waves. Waves in which similar current cycles follow each other continuously instead of being broken up into groups like *damped waves* (q.v.). The sustained waves may be interrupted by means of a sending key and thus used for sending radio telegraph messages or they may be modulated and thus utilized in radio telephony. Sustained waves are obtained by the use of high frequency alternators, arc condensers, or thermionic electron tubes (vacuum tubes). The use of sustained waves has made radio telephony practicable. Sustained waves permit sharper tuning, require less energy at the transmitter than in the case of undamped waves, and permit the use of "beat" reception and other sensitive methods of reception. (See *Continuous Waves*.)

**S.W.G.**—Abbreviation for Standard Wire Gauge. The full name of this wire gauge is the *British Standard Wire Gauge*. It is also referred to as the *New British Standard*, the *Imperial Wire Gauge*, and the *English Legal Standard*. It is the legally adopted standard of Great Britain. The following table shows a comparison between the American Wire Gauge (B. & S. Gauge) and the Standard Wire Gauge:

Gauge No.	American Wire Gauge Dia. in Mils	Standard Wire Gauge Dia. in Mils
10	102	128
11	91	116
12	81	104
13	72	92
14	64	80
15	57	72
16	51	64
17	45	56
18	40	48
19	36	40
20	32	36
21	28.5	32
22	25.3	28
23	22.6	24
24	20.1	22
25	17.9	20
26	15.9	18
27	14.2	16.4

**Switchboard**

Gauge No.	American Wire Gauge Dia. in Mils	Standard Wire Gauge Dia. in Mils
28	12.6	14.8
29	11.3	13.6
30	10.0	12.4
31	8.9	11.6
32	8.0	10.8
33	7.1	10
34	6.3	9.2
35	5.6	8.4
36	5.0	7.6
37	4.5	6.8
38	4.0	6.0
39	3.5	5.2
40	3.1	4.8

**SWITCH**—A device for conveniently making or breaking an electrical circuit. Switches must be designed to carry their rated current without overheating or undue voltage drop, to handle overloads, to prevent arcs on

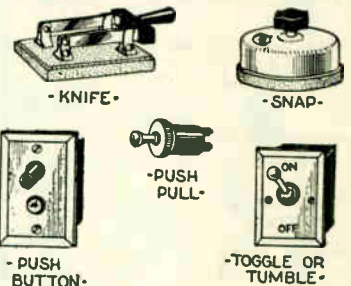

Various types of switches.

being opened and to properly insulate live parts when switch is open. The most common form of switch is the *knife switch* (q.v.). A switch which opens or closes but one circuit, that is operating in only a single position, is called a *single throw switch*. One operating when thrown in either of two positions is called a *double throw switch* (q.v.). A switch which controls only one side of a circuit is a *single pole switch*; both sides of a circuit, a *double pole switch*. The abbreviation for a single pole, single throw switch is S. P. S. T. The abbreviation for a double pole, double throw switch is D. P. D. T., etc. There are various types of switches ranging from *oil switches* used to handle enormous currents to the small push button or snap switches for turning on or off electric lights. Among the switches used in radio work may be mentioned the *ground switch* (q.v.), *aerial switch* (q.v.), *quick break switch* (q.v.) and *anti-capacity switch*. This latter usually consists of a small handle with a cam attached to its other end which serves to press together or release spring contacts. The electrostatic capacity between the springs is low, due to the construction used. The *plug* (q.v.) and *jack* (q.v.) constitute a form of switch extensively used in radio equipment. The *push-pull switch*, operating as its name implies, is often used to control the filament lighting circuits of radio receiving sets.

**SWITCHBOARD**—In its broadest sense, this term is applied to any collection of control, operating and measuring apparatus mounted on a panel or panels for the purpose of starting, stopping or otherwise controlling an electrical installation. In a small electrical plant, all control and switch gear





## Switchgear

may be mounted on a single structure, which is referred to as the switch-board. Switchboards are used at the radio broadcasting station to carry the various meters, control rheostats, switches, etc. (See Panel.)

radio hook-ups to represent various electrical and radio apparatus. The use of symbols has been standardized and results in clearer and more easily drawn diagrams. A table of symbols is given below:

rotary gap discharger driven by a synchronous motor from the same line supplying the transformer in a radio telegraph transmitting system or a rotary gap mounted on the shaft of the alternator supplying the 500 cycle or

### Table of Radio Symbols

	ANTENNA			VOLT-METER			SWITCH FILAMENT	
	LOOP ANTENNA			CRYSTAL DETECTOR			SWITCH S.P. S.T.	
	"A" BATTERY DRY CELL			GRID LEAK FIXED			SWITCH S.P. D.T.	
	"A" BATTERY STORAGE			GRID LEAK VARIABLE			SWITCH D.P. S.T.	
	"B" BATTERY			JACK SINGLE CIRCUIT			TRANSFORMER AUDIO FREQ.	
	BUZZER			JACK DOUBLE CIRCUIT			TRANSFORMER RADIO FREQ.	
	CHOKE COIL AUDIO FREQ.			JACK FILAMENT CONTROL			TRANSFORMER TUNED RADIO FREQ.	
	INDUCTANCE COIL FIXED			NO CONNECTION			VACUUM TUBE	
	INDUCTANCE COIL TAPPED			POTENTIOMETER			VARIOMETER	
	CONDENSER FIXED			RECEIVERS TELEPHONE			VARIOCOUPLER	
	CONDENSER VARIABLE			RHEOSTAT			LIGHTNING ARRESTER	
	CONNECTION			RESISTANCES			GROUND	

**SWITCHGEAR**—Apparatus used in connection with the control of an electrical installation, such as switches, rheostats, starters, circuit breakers, etc.

**SYMBOLS**—Conventional signs used in

**SYNCHRONOUS**—As applied to alternating currents, these are said to be synchronous when of the same frequency (q.v.) and exactly in phase (q.v.).

**SYNCHRONOUS DISCHARGER**—A

higher frequency current. (See *Disc Discharger*.)

**SYNTONY**—The relationship between two oscillating currents when one resonates to the waves produced by the oscillations of the other.

# T

**TABLE OF DIELECTRIC STRENGTH**  
—A table showing the voltages at which certain thicknesses of various materials will break down or puncture. The following table has been obtained from Pender's Handbook for Electrical Engineers:

MATERIAL	DIELECTRIC STRENGTH	
	Specimen thickness mm.	Kv. per mm. (a)
Ambroin	0.84	6.0
Asbestos paper	1.2	4.2
Asphalt (Byerlyte)	3.6	14.0
Bakelite, C-1		up to 27.5
Bakelite, wood molding mixture		17.7 to 21.6
Bakelite, asbestos molding mixture		up to 9.8
Bakelite, Continental	3.2	15.7
Bakelite, Micarta-21B		up to 31.4
Bakelite, Micarta-21D		5.9
Bakelite, Micarta-21H		15.7
Bakelite-Dilecto-X	3.2	25.6
Bakelite-Dilecto-XX	3.2	25.6
Celluloid (clear)	0.25	12 to 28
Celluloid (colored)	0.25	10.2 to 18.9
Condensite (molded)	5.7	19.7
Condensite (celoron)	5.7	29.5
Conite	0.13	15.7
Copal	3.0	8.2
Empire cloth, canvas	.41	28.9
Empire cloth, linen	.15	54.0
Empire cloth, muslin	.38	48.0
Empire cloth, silk	.15	48.0
Faturan	3.	10
Fiber, vulcanized, including hard fiber all colors	0.79 to 12.7	8.9 to 16.7
Galalith (white)		3.2 to 10.8
Glass (ordinary)		3.9 to 8.9
Hermite		3 to 5.9
Jute (impregnated)	6	6 to 8.5
Lava		8 to 9
Litholite	4.5	2 to 3
Marble		1 to 1.2
Mica	6	4.5 to 10
Micabond, plate	1.6	21 to 28
Micabond, flexible	1.6	37.5
Micanite, plate	1.6	23.1
Micanite, flexible	1.6	37.5
Minerallac		1.6
Paper	0.13	39.4
Paraffin (parawax)		8.7
Porcelain	20	11.5
Pressboard (oiled)	0.25	8
Pressboard (oiled)	1.53	39.3
Pressboard (oiled)	3.17	29.2
Pressboard (varnished)	0.25	21.1
Pressboard (varnished)	1.58	26.3
Pressboard (varnished)	3.17	15.5
Presspahn		9.5
Redmanol (molded)	5.1	5.2 to 9.3
Redmanol (laminated)	0.8	11.8 to 18.5
Rubber (hard)	0.5	41 to 51
Slate	10.3	70
Vulcabeston	1.9	10.3 to 1.3
Wood (maple), paraffined	15.2	31.5 to 7.1

(a) To obtain volts per mil, multiply kilovolts per millimeter by 25.4.

**TANGENT OF AN ANGLE**—In a right angle triangle having the given angle as one of its angles, the tangent of the

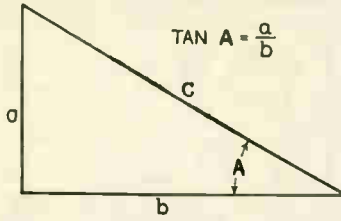

The tangent of angle A is the ratio of side a to side b.

angle under consideration is equal to the ratio of the side opposite the angle to the base of the triangle.

**TAP-TAPPING**—The connection made to an intermediate point in a winding thus permitting the number of turns in the circuit to be varied at will. Variometers, variocouplers and other coils are made with taps, also transformers, armatures of rotary converters, etc.

**TAPPED**—See *Tap*, also *Tapped Inductance*.

**TAPPER**—An electromagnetic device, similar to an electric bell, but with gong removed, arranged so that a hammer gently taps a coherer thus decohering filings after the passage of incoming oscillations. This device was formerly used as a detector of wireless telegraph signals.

**TAPPING-BACK**—The application of a light blow to a filings coherer to decohere the filings. (See *Tapper*.)

**TELEFUNKEN SYSTEM**—A wireless telegraph system employing a *quenched spark gap* (q.v.) and giving a singing spark of rather high note. This system has been developed and used by the Germans.

**TELEGRAPH**—Any system of transmitting intelligence from one point to another over a distance. The word was at one time applied to visual systems such as wig-wagging and semaphore, but at the present is used only to refer to electrical systems. The one exception to this rule is the use of the term to refer to signals sent either mechanically or electrically from the bridge of a ship to the engine room.

**TELEGRAPHONE**—A magnetic phonograph in which speech currents or signal currents are recorded as permanent magnetic impressions on a moving steel wire. Instruments such as this have been used for recording telephone conversations and also in high speed automatic wireless telegraph transmission. (See *High Speed Reception and Transmission*.)

**TELEGRAPH NAUT**—A nautical mile of 2,029 yards or 1.1528 statute miles. (See *Nautical Mile*.)

**TELEGRAPHY, RADIO**—See *Radio Telegraphy*.

**TELEPHONE CONDENSER**—In radio work, this is a fixed condenser shunted across the head set or loud speaker. Used in this connection, the condenser is also referred to as a by-pass condenser since it offers a path of low resistance to the radio frequency currents. By-pass condensers are usually made of tin foil with a mica or paper dielectric. Condensers used for ordinary telephone work are also referred to as telephone condensers.

**TELEPHONE RECEIVER**—An electromagnetic instrument by means of which variations of current are caused to reproduce sound waves corresponding to words spoken into a transmitter at a distant point. The essential features of the telephone receiver are an electromagnet, a permanent magnet and a diaphragm held in a suitable case. The diaphragm is supported by the rim of the case, at a short distance from the face of the magnet and it is attracted by the magnet when it is energized by the current flowing in the windings. The steady magnetic flux of the permanent magnet draws the diaphragm to the pole pieces, leaving a small gap between, so that the diaphragm is held under tension. The currents passing through the electromagnet are modulated in accordance with the transmitted speech. These change the tension of the diaphragm due to the change in magnetic pull and as a result the diaphragm vibrates giving forth speech or music. The telephone receivers used in radio work are of the *watch case* type. (See *Head Telephone or Head-Phone*.)

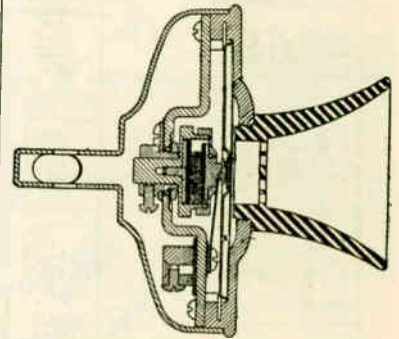

A cross sectional view of a telephone transmitter showing details of construction.

**TELEPHONE TRANSMITTER**—A sound-wave operated or vibration-operated device designed to produce electromagnetic waves or vibrations which correspond to the sound waves or vibrations actuating it. The standard transmitter used in ordinary telephone work is known as the "solid-back" transmitter. A gong-shaped back supports the transmitter and carries all the parts. A mouth piece of hard rubber is screwed into the front. Just to the rear of the front is placed an aluminum diaphragm which fits into a receptacle cut out for it. An insulated cushion seat of rubber is placed above and below the diaphragm. The diaphragm is held securely by damping springs having soft rubber cushions at their tips, so that it can only assume forced vibrations. An auxiliary diaphragm of mica is used which is fastened to the front electrode of the transmitter button. Both the front and the rear electrodes are made of carbon discs, between which carbon granules are placed in a cylindrical chamber lined with varnished paper. A rigidly connected pin communicates the vibrations of the diaphragm to the front electrode. The movement of the electrode varies the pressure on the carbon granules, thus giving the required variation of resistance which in turn varies the current. The *microphone*

**"T" ANTENNA**—A flat top antenna in which the down lead is taken from the center of the horizontal portion. (See *Aerial*, also *Flat Top Aerial*.)

**TAILS**—Name given to small iron wires forming core of *induction coils* (q.v.).

**TANGENT GALVANOMETER**—A type of galvanometer in which the strength of the currents which pass through the coil is proportional to the tangent of the angle of deflection of the magnetic needle in the center of the coil. In construction, the tangent galvanometer consists essentially of a small magnetic needle suspended in the center of a large circular coil made of the few turns of insulated wire. Attached to the needle is a light aluminum pointer which allows the deflections to be read on a horizontal scale. The coil is placed in the magnetic meridian with the needle and the coil in the same plane. When the current passes through the coil, the pointer is deflected and the angle of deflection recorded. Knowing the constant of the galvanometer, it is possible to calculate the current in absolute units or in amperes by multiplying the constant by the tangent of the angle recorded.

## Telephone, Tuned

(q.v.) used in radio broadcasting is a modification of the telephone transmitter.

**TELEPHONE, TUNED**—See *Tuned Telephone*.

**TELEPHONY, RADIO**—See *Radio Telephony*.

**TELEVISION**—Electric vision at a distance. The transmission by wire or by radio of vision—that is to say the ability to see objects at any distance by changing the light waves to electric currents or to electromagnetic waves, transmitting these to the distant receiving point, and then retransforming them back to the original light waves. Television is still in the experimental stage. Of course, the sending of pictures by radio has been accomplished by Capt. Ranger, in this country, Belin in France, Karolus in Germany, Baird in England, and several others. Both Belin and Baird have been working on the problem of television and are reported to be nearing success. In this country, Mr. C. Francis Jenkins, of Washington, D. C., has constructed a non-commercial (that is in its present stage) machine which will send motion pictures by radio. This is practically the last word in the

ness according to a graduated scale. Revolving the disc causes the image to move in a straight line. When the end of the prism passes the lens, there is instantaneous snapping back of the picture and the journey is repeated. If a small hole be made in the screen, the light from a given point on the picture will pass through and can be made to operate a light sensitive cell at the back of the screen. When the image is made to move down over the screen by the prismatic ring, the aperture will admit light of varying intensity, according to the light value along a line across the picture. This means that the light falling on the photo cell as the image travels will represent a line across the picture from top to bottom. This leads to the creation of the successive lines that make up the picture as a whole. The image is moved along from side to side by means of a second prismatic ring working along at right angles to the first, but at much lower speed. This second prism makes but one revolution during the time that the first makes one hundred, producing the hundred lines assumed to be necessary for making the picture. The cell used may be selenium or thalium oxide. The former requires twenty minutes to

discs similar to those at the transmitting end. As noted above, the main difference between sending photographs and motion pictures is in the necessary speeding up. For this purpose, Mr. Jenkins uses a potassium light-sensitive bulb, the action of which is much more rapid than that of either selenium or thalium oxide. The cell is composed of a bulb with its inner surface coated with metallic potassium. The bulb has a high vacuum. The device has two electrodes, one being a wire through the stem, ending in a loop in the center of the bulb; the other passing through the side of the bulb and connecting with the potassium deposit. Absence of the potassium from a small part of the surface forms a "window" opposite the last named contact. Application of a positive potential to the central electrode, attended by connection with the potassium coating, permits no current to flow as long as no light enters the bulb. The admission of light frees electrons from the potassium, in numbers proportionate to the strength of the light. In this way a current flows through the bulb when light enters the "window." In this cell, there is no appreciable lag due to the amazing speed of the electrons.

The sending station has a motion picture projector, a small machine used to cut up the image, a light-sensitive cell, and a transmitter. The receiving station has a radio receiving set, a machine for reassembling the picture, and a screen for the reproduction of the image.

The lamp required for the receiving station must be able to pass swiftly from darkness to extreme brilliancy, and the ordinary filament lamp could not attain the tremendous speed involved. The lamp used by Mr. Jenkins is the creation of Professor McFarlane Moore, and is capable of handling complete cycles at the rate of 75,000 to the second. This lamp has a glass bulb containing two concentric cylinders, the larger almost filling the bulb, and the smaller almost filling the larger. The inner cylinder has a small axial hole, drilled almost to the bottom and forming a deep cup. The principle of this lamp is much the same as that of the Amrad "S" valve.

It is a truism that the fundamental principle of cinema pictures is that the human eye continues to see an image

The cylinder is covered with plane mirrors, revolving downward on the side toward the lantern. One ray at a time from 1/25,000 of the area of the image, passes through the opening in C. The fixed mirrors D and F send it back to the mirror G, opposite B on the cylinder, and it is finally reflected against H in a position corresponding exactly to the portion of the image from which it was first taken. The effect of continuous vision is produced.

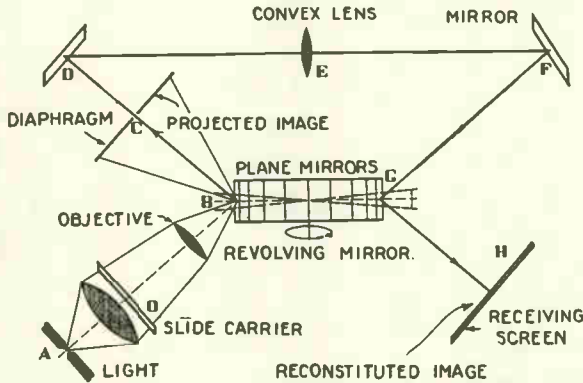

present development of television. It is possible to broadcast a film picture with this device at the rate of sixteen pictures per second showing the moving outlines as silhouettes, but without the intermediate tones. The method by which a photograph is transmitted by radio in the Jenkins system may be illustrated by the example of a coin covered by a thin sheet of paper on which serrated pencil lines are drawn. The design of the coin appears in lines varying in intensity. The variations in the lines may be transformed into pulsing electric current by means of a light sensitive cell passing over the lines in question. Place the lines end to end and the current can modulate a carrier wave. The forming of the continuous line presented a difficulty which was solved in the following way. The inventor proceeded along the line that a prism bends a ray of light and that an image will appear upon a photographic lens placed before a picture. From this it follows that a prism placed near a lens will cause the image to be displaced sideways, the extent of the displacement being dependent on the angle of the prism. If the prism could change its angle, the result would be motion on the part of the image. The prism used is circular, with rapid change of form across the prismatic section. Around the circumference of the disc, the prism changes in thick-

cover the picture, the latter six. It is obvious that to reproduce the picture at the other end the process must be reversed, the lines being replaced side by side by means of a pair of prismatic

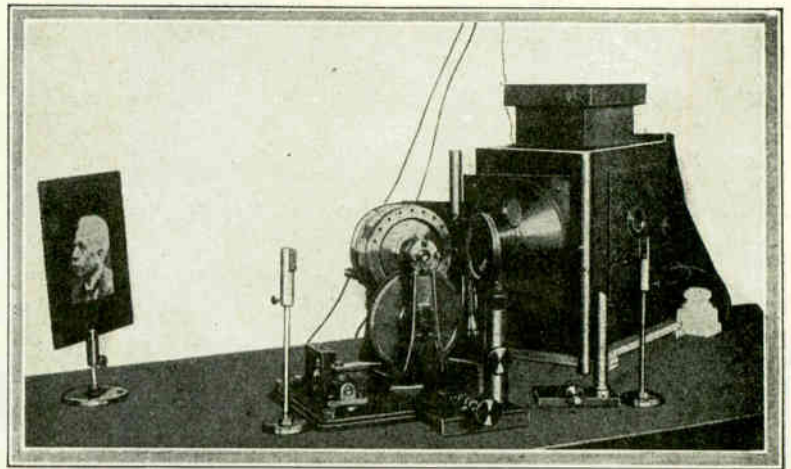

This apparatus is diagrammed above: the projecting lantern at the right; the drum of mirrors, center; and the adjusting stands for diaphragm and fixed mirrors in front. At the left a continuous image appears on the screen, although only 1/25,000 of it is actually projected at any instant.

after that image itself has disappeared. In the case of an electric spark lasting one ten thousandth of a second, the image lasts for at least one-sixteenth of a second as visualized by the eye. Mr. Jenkins assumes that if 10,000 dots of light and shade flash successively on a screen with sufficient speed, the eye will see the picture to which the dots belong even though but one dot is on the screen at a time. He, therefore, aimed at flashing the 10,000 dots on the screen within the space of one-sixteenth of a second.

Theoretically, this feat might be accomplished by halving the slow disc revolving rate to 960 revolutions per minute, keeping the faster disc at a rate exactly one hundred times greater. But the glass disc would be shattered by the centrifugal force before the attainment of a speed of 96,000 revolutions per minute.

Mr. Jenkins gets over this difficulty by the use of forty-eight lenses attached to a large aluminum disc rotating in front of the prismatic disc, thus giving the effect of a slow-moving lens. Each of these forty-eight lenses makes a line across the plate, which thus becomes the screen of the motion picture apparatus. This makes it possible to reduce the speed to one forty-eighth of that which would otherwise be required, that is, to one of 2,000 revolutions per minute.

At the receiving station, the modulated wave is received by a set but slightly different from many in common use. The last amplifier tube is one of 5 watts. By the use of the McFarlane Moore light already described, the modulations in the plate circuit of the last valve are transformed into light, and the rays are distributed over the screen by prismatic and lens discs similar to those used at the sending station. In actual practice, the picture appears on a screen about 6 in. by 8 in. More powerful lamps would allow of larger pictures.

The process described is for sending photographic pictures. But it can be adapted for the sending of direct views without the intervention of photography.

All that is done in this case, is to remove the projector and focus the lens so that it will throw the view as an image.

So far as radio features of the transmission are concerned, there is little to be explained. At the receiving station the circuit resembles the superheterodyne. The picture is at 75 kilocycles frequency and does not interfere with broadcasting.

The carrier wave may be modulated with voice frequency, so that the voice can travel with the picture, which enables vocal explanations to be given simultaneously with the flashing of the film or actual scene being transmitted.

**TEMPORARY MAGNETS**—Magnets which lose their magnetic properties as soon as the magnetizing force is removed. Soft iron displays the properties of a temporary magnet and hence is ideal for use as the core of electromagnets. (See *Magnet, Electromagnet*, also *Permanent Magnet*.)

**TERMINAL**—A binding post or other fitting attached to the electrodes, ends of windings or other parts of electrical apparatus so as to permit the external circuit to be connected to the apparatus.

**TESLA COIL**—An oscillation transformer for producing high potential discharges from oscillations of low potential. The *Tesla Coil* or *Tesla Transformer*, as it is sometimes called,

is somewhat similar to the ordinary transformer, although it is much more heavily insulated and has the ends of the secondary connected to a condenser which discharges across a spark gap, thus increasing the rapidity of the oscillations, which then pass into a secondary induction coil. This second coil has no iron core. The Tesla Coil consists essentially of a primary winding having a relatively small number of turns of heavy wire and a secondary having a large number of turns of fine

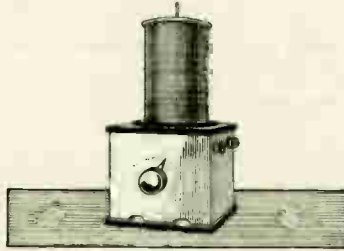

Tesla coil.

wire. An air, glass, or ebonite dielectric separates the primary and the secondary. Due to the sufficient thickness of the dielectric, there is no possibility of a direct discharge between the two windings. Both the primary winding and the secondary winding consist of but one layer each. The primary winding forms part of an ordinary oscillation discharge circuit. A high frequency electromotive force is induced in the secondary winding, due to the high frequency oscillating currents which flow in the primary winding thus setting up an oscillating magnetic field. Due to the high ratio between the windings of the primary and the secondary, very high voltages are set up in the secondary, in some cases as high as a million volts, and hence a very powerful brush discharge can be obtained.

**TESLA, NIKOLA**—American electrical and radio expert. Tesla was born at



Nikola Tesla.

Smiljan, in Jugo-Slavia, 1857, and was educated at Graz and Prague Universities. He entered the Austrian Telegraph Service and in 1884 he came to the United States where he became an assistant to Edison. He specialized in the study of high frequency and high potential alternating currents. Tesla is noted for his many revolutionary inventions which include polyphase al-

ternating current systems, the rotating field alternating current motor, arc lighting, the *Tesla transformer* (q.v.), and radio apparatus of many kinds including *radio control* (q.v.) devices.

**TESTING CIRCUIT (BUZZER)**—A circuit in which a buzzer is used for the purpose of testing or of locating faults in radio apparatus. A buzzer connected in series with a dry cell can be used for locating open circuits and also for testing for short circuits. A buzzer connected in series with a battery and an inductance coil, so as to form a closed circuit and having the inductance coil placed so as to be coupled with the antenna coil of a crystal detector receiving set, can be used to determine the most sensitive point of contact of the crystal. A *tuned buzzer tester* is sometimes used in connection with radio direction finder systems.

**THEORY OF CURRENT FLOW**—While it is assumed for convenience, that an electric current flows along a conductor from the positive terminal of the source and back to the negative terminal, modern theory is that the electrons actually travel in the opposite direction. Whenever there is a flow of electricity in a conductor, it is believed that extremely small particles of electricity, called *electrons* (q.v.), pass along this conductor. Matter is made up of atoms, which in turn are composed of electrons. The electrons are minute particles of negative electricity revolving around a positive particle. All electric current flow is based upon the motion of electrons within a conductor.

**THEORY OF DETECTOR ACTION (OF VACUUM TUBE)**—The vacuum tube used as a detector performs a two-fold purpose—it rectifies the current so that it is capable of actuating a telephone receiver and in addition it amplifies or strengthens the current. The rectification takes place due to the fact that the electron flow is only possible from the filament to the plate, but not in the reverse direction. The radio frequency currents applied to the grid regulate the number of electrons passing from the filament to the plate, the variation being exactly in accordance with the variations of the radio frequency current. (See *Detector, Vacuum Tube*.)

**THEORY OF OPERATION OF VACUUM TUBES**—The operation of the three-electrode vacuum tube depends upon the emission of electrons from the hot filament to the plate and the control of the flow of these electrons by means of the potential variations applied to the grid. The vacuum tube consists of an evacuated bulb containing a tungsten filament treated with thorium, an anode or plate, which may be in the form of a cylinder or plate, and a grid consisting of a wire grating inserted between the filament and the plate. When the filament is heated it gives forth electrons which are attracted to the plate under the influence of a difference of potential by which the plate is maintained positive with respect to the filament. The grid is an automatic control, regulating the flow of electrons from filament to plate. Potential variations applied to the grid serve to vary the electron flow between the filament and the plate. The circuit in which the vacuum tube is used may be divided into two parts, the input circuit connecting the filament to the grid through the secondary of a transformer or other method or applying potential changes to the grid, and the output circuit between filament and plate. The vacuum tube may be used as a detector or rectifier, as an oscil-

lator or generator of high frequency oscillations, as an amplifier, as an electrostatic voltmeter, as a voltage and current regulator, a power limiting device, etc.

**THEORY OF PROPAGATION OF ELECTROMAGNETIC WAVES—**

Waves are due to vibrations transmitted through a continuous elastic medium. Electromagnetic waves are due to vibrations caused by an oscillating electric charge in a circuit (the transmitting aerial circuit). The current flowing in the aerial is oscillating (surging back and forth) at an enormously high frequency and in addition to its induction field, the aerial has associated with it a radiation field which spreads out in all directions from the aerial. The strength of the radiation field decreases in inverse proportion to the distance from the aerial. At any given point the strength is directly proportional to the frequency. The transmission of electromagnetic waves is considered as due to the motion of the lines of force. There is a displacement of electricity along these lines against the elastic force of the medium, termed for convenience the ether (q.v.). Displaced electricity continuously tends to go back to its position of rest under the action of the elastic forces. There is pressure at right angles to the lines of force in addition to the tension along them. The pressures may be considered as due to the repulsion between the displaced charges of the same sign in neighboring lines of force.

**THEORY OF RECEPTION OF ELECTROMAGNETIC WAVES—**As electromagnetic waves cut across a receiving aerial, the electric field intensity along the aerial alternates in value. There is an alternating potential between the aerial and the ground which gives rise to the flow of an alternating current. Another explanation is based on the principle of induction. The magnetic and electric fields, in cutting the aerial, induce electromotive forces which cause current to flow. This is radio frequency current and it is passed to the grid of the detector tube and rectified as explained under *Theory of Detector Action (of Vacuum Tube)*. (See *Electromagnetic Waves*.)

**THEORY OF VACUUM TUBE OPERATION—**See *Theory of Operation of Vacuum Tubes*.

**THERMAL—**Pertaining to heat. There are various electrical and radio devices which depend upon heating or thermal properties. The *thermal ammeter* (q.v.) is described under the heading *Hot-Wire Ammeter*. The *thermal detector* is taken up under *Barreter* and *Liquid Barreter*.

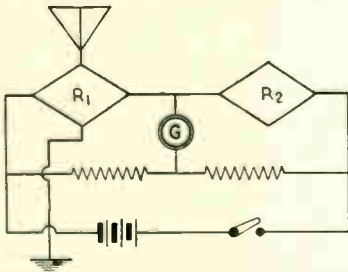

A thermal detector. By means of the change of resistance of a conductor, due to heating, electro-magnetic waves are detected. R<sub>1</sub> and R<sub>2</sub> are two rectangles of very fine iron wire.

**THERMAL AMMETER—**A current meter, in which the current or a fixed proportion of the current in question, passes along a fine wire. This heats

the wire, causing it to expand or sag. This deflects a pointer or mirror across a calibrated scale. The thermal ammeter can be used for measuring direct or alternating currents. (See *Electro-thermal Meter*, also *Hot-Wire Ammeter*.)

**THERMAL DETECTOR—**A radio detector (q.v.) which depends for its operation upon the heating of a fine wire by the passage of electrical oscillations. (See *Barreter*.)

**THERMAL JUNCTION—THERMO-ELECTRIC JUNCTION—**The contact point or joining point of the two dissimilar metals of a *thermo-electric couple* (q.v.). (See *Klemencic Thermal Junction*.)

**THERMAL TELEPHONE—**A telephone receiver in which the movements of the diaphragm are regulated by the variations of expansion of a wire heated by the telephone currents thus reproducing sound waves. In another type of thermal telephone, the diaphragm is dispensed with, sound waves being reproduced directly through the expansion and contraction of air in contact with the heated wire. This device is also known as a *thermal receiver* or a *hot-wire telephone*.

**THERMIONIC EMISSION—**The emission of a stream of negative electrons from a heated filament (cathode) in a vacuum tube.

**THERMO-ELECTRIC COUPLE—THERMO-COUPLE—**A pair of dissimilar metal pieces placed in contact

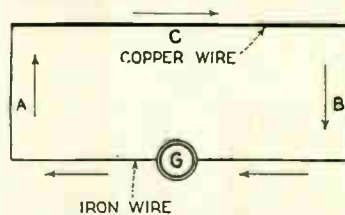

A current is caused to flow by heating the junction of two dissimilar metals. If the end at B is heated the direction of flow will be as shown by the arrows.

and connected by electrical conductors in a closed circuit. When the junction of the two dissimilar metals is heated, an electric current will flow.

**THERMO-ELECTRIC CURRENT—**A current which is caused to flow due to an electromotive force set up at the junction of two dissimilar metals when these metals are at different temperatures. (See *Peltier Effect*.)

**THERMOPILE—**A device for magnifying the effect of the thermo-couple by

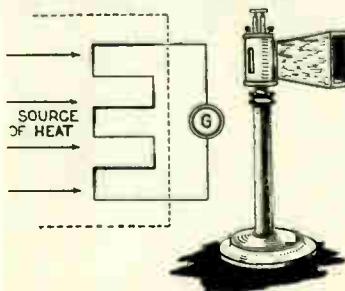

At the left is shown method of joining thermopile junctions to multiply the effect. At the right is a sensitive thermopile.

connecting a number of these in series and exposing one set of alternate junctions to the heat, thus causing the electromotive forces to add up.

**THOMSON EFFECT—**The phenomenon of the appearance or disappearance of

heat when a current flows from a cold towards a hot part of a conductor. If copper is unequally heated, heat is liberated at a point when the current and the heat flow in the same direction and is absorbed when they flow in opposite directions. The Thomson effect is measured by a quantity termed "the specific heat of electricity."

**THORIUM—**A rare metal which in certain compounds is radio-active. This metal has a specific gravity of eleven and an atomic weight of 232.5. Thorium is used for coating Welsbach mantles and is also used in connection with the coating of the tungsten filaments used in vacuum tubes. (See *Filament, Thoriated*, also *Thorium Treatment of Filaments*.)

**THORIUM TREATMENT OF FILAMENTS—**A compound of thorium, thorium (ThO<sub>2</sub>) is used extensively in the manufacture of filaments for vacuum tubes. Sometimes thorium nitrate is used for this purpose. The filament so treated is termed thoriated tungsten. Since the rate of electron emission from a thoriated tungsten filament at a given temperature is several thousand times greater than in the case of the ordinary tungsten filament, it is possible to use the former at a much lower temperature. (See *Filament, Thoriated*.)

**THREE CIRCUIT TUNER—**A regenerative circuit (q.v.) in which the primary, the secondary or grid circuit, and the plate circuit are capable of being tuned in resonance with each other.

**THREE-ELECTRODE THERMIONIC TUBE—**An evacuated bulb or vessel containing a combination of a heated cathode, a relatively cold anode and a third electrode for controlling the current flowing between the other two electrodes. (See *Triode*, also *Vacuum Tube*.)

**THREE-ELECTRODE TUBE—**The three element thermionic vacuum tube having a filament or cathode, a plate or anode, and a grid. This tube can be used with minor modifications as a *rectifier* (q.v.) or *detector* (q.v.) of radio signals, an *amplifier* (q.v.), an *oscillation generator* (oscillator (q.v.)), an *electrostatic voltmeter* (q.v.), as a *power limiting device*, etc.

**THREE WIRE SYSTEM—**In direct current work, a system of transmitting electrical energy, which utilizes three wires, one of which is maintained at a potential, midway between the other two. A part of the load is connected

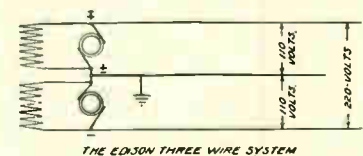

THE EDISON THREE WIRE SYSTEM

between one wire and the neutral and part between the other wire and the neutral. As a result the neutral wire only carries current equal to the difference in the loads. The main advantages of this system are a saving in copper and availability of double voltage. Thus 110 volts may be required for lights, whereas 220 may be wanted for electric motors. In alternating current work reference is sometimes made to a two-phase three wire system. In this system there are two single phase currents which differ in phase by 90 degrees. Each current has a separate outgoing wire, but unites in a common return wire. (See *Neutral Wire*.)

**TICKER or TIKKER**—A form of interrupter or an equivalent apparatus, used in sustained wave telegraphy. It is really a commutator interrupter. In a commercial type illustrated, a disk is mounted on a motor shaft. The disk has a number of teeth filled in between with fibre or other insulating material. The radio frequency currents flow

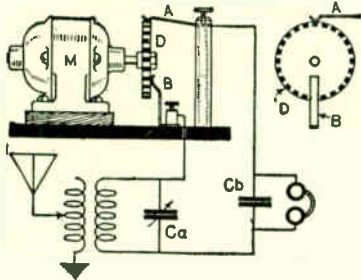

A simple Poulsen ticker. This is used to interrupt circuits of a receiving tuner at a uniform rate per second.

from one brush to the other through the disk which interrupts them at the rate of from 300 to 1000 times per second. A charge is built up in the condenser  $C_a$  by resonance with the aerial system and this discharges into the telephone condenser  $C_b$  at regular intervals. The telephone condenser then discharges through the head set, thus producing a single sound corresponding to the charge accumulated. Since the tikker discharges the condenser,  $C_a$  at different places on the cycle of the incoming oscillations, the note produced is not uniform and is hard to read through atmospheric interference. (See *Chopper*.)

**TICKLER—TICKLER COIL**—A coil placed in the plate circuit of a regenerative receiver and coupled inductively in the grid coil in order to obtain regeneration. (See *Feed-Back, Feed-Back Coil, Feed-Back Coupling, Regenerative Circuit, Regenerative Coupling, also Regeneration*.)

**TIME CONSTANT**—The ratio, in an electric circuit, of the inductance in henries to the resistance in ohms. It is the time, in seconds, required for a current to attain 63.2 per cent of its ultimate value as given by Ohm's Law. (See *Impulse E.M.F.*)

**TONE WHEEL**—An apparatus used in the reception of wireless telegraph signals in continuous wave systems, utilizing a wheel in which the conducting teeth are separated by insulating material. A brush is used to make contact with the wheel. The tone wheel is similar in principle to the *tikker* (q.v.) except that it converts the incoming oscillations to audio frequency currents, thus doing away with the non-uniform note of the *tikker*. In addition to this the tone wheel utilizes more of the incoming energy than does the *tikker*. The tone wheel is run at such a speed that the frequency of the interruptions differs slightly from that of the incoming oscillations thus giving *beats* (q.v.) which produce audio frequency currents which can be heard in the telephone receiver. Since the tone wheel mechanically converts radio frequency currents into audio frequency currents it is sometimes called a *frequency transformer*.

**TORQUE**—The moment of a system of forces tending to produce rotation. It is usually measured in foot-pounds. Torque may also be defined as that

which produces or tends to produce torsion. Thus if a force acts at a tangent to the periphery of a circle, thus producing a turning moment about the center of the circle, the product of the force and the radius of the circle is called the torque.

**TRAIN RADIOPHONE**—Communication by means of radio between moving trains and ordinary land-line telephone systems. Such a system is in operation commercially in Germany on trains operating between Berlin and Hamburg. The voice frequency currents from the telephone are impressed on a carrier wave by a method similar to the *Heising Modulation* (q.v.) system. Each train has a special wave length assigned to it. The modulated wave is emitted through a four-wire antenna, strung along the roofs of two coaches. The nearby telegraph wires pick it up and carry it to the receiving sets, located in stations along the line. The ground for the system is obtained through contact of the car wheels with the rails. In reverse order, the voice frequencies of messages from the telephone at the other end are used to modulate a carrier wave (using a different frequency) at the nearest train-telephone switchboard. They are then transmitted over the wires and inductively to the train. An arrangement is provided to prevent interference between the sending and the receiving sets.

**TRANSFORMER**—A type of induction apparatus, usually stationary, having primary and secondary windings, ordi-

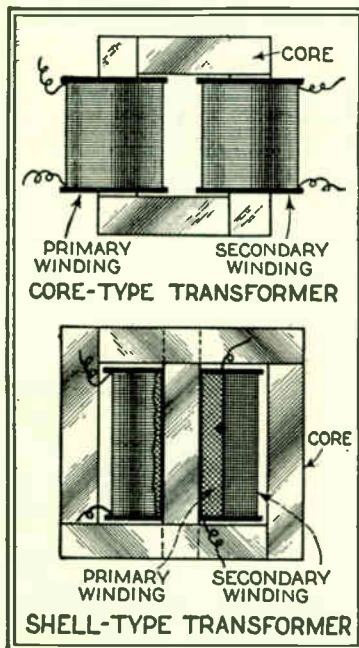

Two standard types of transformers.

narly insulated from each other. These are wound about an iron core. The function of the transformer is to change the electrical energy either increasing or decreasing the voltage, current, frequency or phase. Transformers can only be used in connection with alternating currents. Transformers for changing voltage have a different number of turns in the primary than in the secondary. In the step-up transformer, the primary usually consists of a small number of

turns of comparatively heavy wire, while the secondary consists of a larger number of turns of fine wire. The ratio of the primary and secondary windings determines the ratio between the input and the output voltages; thus a 10 to 1 step-up transformer could be used to step a primary voltage of ten to a secondary voltage of 100. There are various methods of classifying transformers, namely, according to their operating characteristics, according to their method of cooling, or to their construction. Transformers which are meant to give a constant voltage on the secondary side are known as *constant potential transformers*. Those meant to give constant current are called *constant current transformers*. Transformers may be air cooled, water cooled or oil cooled. In some cases a natural air draft is used as in transformers of the smaller types. Larger transformers may be designed with special ducts through which blowers force a current of air. Oil cooled transformers may have the cores and windings immersed in oil, or the oil may be circulated through external coils. Water cooled transformers are immersed in oil, but have pipes carrying running water submerged in the oil. According to construction, transformers are of the core type and the shell type. The core type transformer is used more for high voltage, low capacity work, while the shell type is used for low voltages and high capacities. Transformers find a wide application in radio apparatus. *Audio transformers* are used to couple audio frequency circuits as for example in the case of an audio frequency amplifier. Audio transformers have an iron core and may be *shielded* or *unshielded*. *Radio frequency transformers* are used to couple radio frequency circuits. They are usually of air core type, although in special instances iron cores are used. Transformers are also used in alternating current chargers, in "A" and "B" battery eliminators and in power sets which operate directly from alternating current house-lighting circuits. (See *Charger, Storage Battery, Audio Amplifier, Coupling Transformer, Jigger, Intermediate Transformer, Inductive Coupler, Oscillation Transformer, Air Core Transformer, Core Transformer, Ratio of Transformation, also Shielded Transformer*.)

**TRANSFORMER COUPLING**—A method of transferring the electrical energy of an alternating current from one circuit to another inductively by means of a transformer, one of whose windings is connected in one circuit, the other winding being connected in the second circuit. Radio frequency circuits are usually coupled by *radio frequency transformers*, *audio frequency transformers* being used to couple audio circuits. (See *Coupling, also Amplifier, Intermediate Frequency*.)

**TRANSFORMER STEEL**—A special steel usually containing a high silicon content used for stamping out transformer laminations. (See *Eddy Currents*.)

**TRANSFORMER, TUNED**—See *Resonance Transformer*.

**TRANSMISSION**—As applied to radio communication, this is the sending of signals, speech or music from one point to another by means of electromagnetic waves. (See *Radio Telephony, Radio Telegraphy, Theory of Propagation of Electromagnetic Waves*.)

**TRANSMISSION OF PHOTOGRAPHS BY RADIO**—Various methods have been devised and are now in use for the transmission of photographs by radio. Among these may be mentioned the systems of *Belin* (q.v.), *Baird*, and *Jenkins*. The principles underlying the *Jenkins* system are explained under the heading of *Television*. Using the system developed by Capt. R. H. Ranger, photographs were transmitted by radio from Honolulu to New York, a distance of 5,136 miles. Recently commercial picture transmission service has been inaugurated between New York and London using the Ranger apparatus. Two distinct methods have been applied for analyzing the picture in the process of trans-

the electron flow constitutes a discharged circuit, so that the grid becomes less negative. The first amplifying tube is a direct current potential amplifier, and is resistance coupled. The grid and plate connections of the amplifier are connected across a condenser which becomes discharged with the fall in the grid to plate resistance of the valve brought about by the grid potential fluctuations. A charging circuit is connected to the condenser and is controlled by a valve, the grid circuit of which operates by variations of the potential across the condenser. The charging current is fed through the plate circuit of this valve, in which a relay is connected, which working through other mechanical relays in

each time the stylus completes a forward and backward movement across the paper. A small flashing neon lamp is used to indicate the correct speed adjustment of the driving motor.

**TRANSMITTER**—An apparatus for sending out electrical messages. As applied to radio telegraphy or radio telephony, the transmitter refers to the entire sending apparatus. The term transmitter is often used to refer to a *telephone transmitter* (q.v.). (See *Automatic Transmitter*, also *Wheatstone Transmitter*.)

**TRANSMITTING AERIAL**—A wire, or more usually a group of wires, suspended at a suitable height and connected to a radio transmitting set. The purpose of the aerial is to facilitate the radiation of the electromagnetic waves generated by the high frequency oscillating current which flows in the aerial. (See *Directional*, also *Receiving Aerial*.)

**TRANSMITTING JIGGER**—An *oscillation transformer* (q.v.) having a variable secondary, permitting of various degrees of coupling, by adjustment, between the two circuits. (See *Jigger*.)

**TRANSMITTING KEY**—A telegraph key, used in the sending of radio code messages. This key must be of rather heavy construction since it handles larger currents than those used in ordinary wire telegraphy. Pressing the key, closes the circuit, and by holding the key down for a longer or a shorter period, the dots and dashes of the continental code are reproduced. (See *Code*, *Key*, *Key High Speed*.)

**TRANSMITTING TUBE, POWER RATING**—The useful power output from an oscillating tube is the power expended by the oscillating current in the resistance of the output circuit. The power input to the tube, not counting that expended in heating the filament, is the product of the plate supply voltage and the average plate current during an oscillation.

**TREMBLER**—A springy metallic blade carrying a soft iron armature. The spring makes contact with a fixed con-

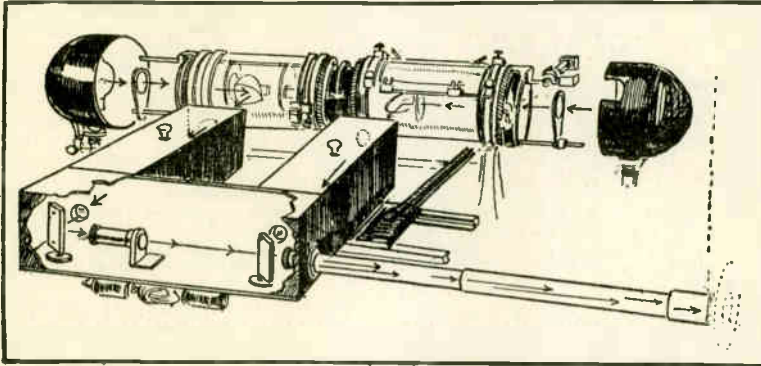

A pencil of light traverses the picture which is attached to the glass drums and is analyzed by a slow rotating action as well as a backwards and forwards movement of the carrier.

mission. One arrangement consists of producing an image as a non-conducting deposit upon a metal foil which is traversed by a stylus, while the other method makes use of an opaque image deposited upon a transparent film which is traversed by a beam of light, the light interruptions being recorded by a light sensitive cell. The Ranger system makes use of this latter method. The image is photographically recorded upon a celluloid sheet large enough to accommodate easily a picture of half-plate size. In the case of sketches and written messages the image for transmission is made directly by writing upon a piece of transparent film with a dense black ink. The image is then secured to the face of a glass cylinder, and by means of a lamp, focussing lens and reflecting prism, a narrow pencil of light is passed through the film. The cylinder is mounted on a carrier which is caused to be moved backward and forward so that the beam of light is concentrated in turn on all parts of the picture. A rotary motion is applied, as well as the transverse motion, the cylinder being given a slight rotation when it completes each transverse motion. The beam of light is passed through a special photo-electric cell. This consists of a spherical globe, coated on the inside with potassium hydroxide, which is very sensitive to light. The coating is connected to the grid of a vacuum tube, while an "electron collector" near the center of the tube is joined to the plate of the first amplifier. When no light is falling on the deposit on the inner surface of the globe, the grid acquires a negative charge, stopping the flow of electrons between filament and plate, and hence no current flows in the external circuit. The ray of light, however, causes an electron stream to flow between the coating and the collector, and since the coating is connected to the grid,

controls the radio transmitter. Wave trains from the transmitting station after detection and amplification, are applied to the picture recorder. The recording mechanism, in order that it may be sensitive to exceedingly small currents, comprises, a small moving coil, in a magnetic field created by three electromagnets. The coil of wire, in moving in the field, as the received fluctuations

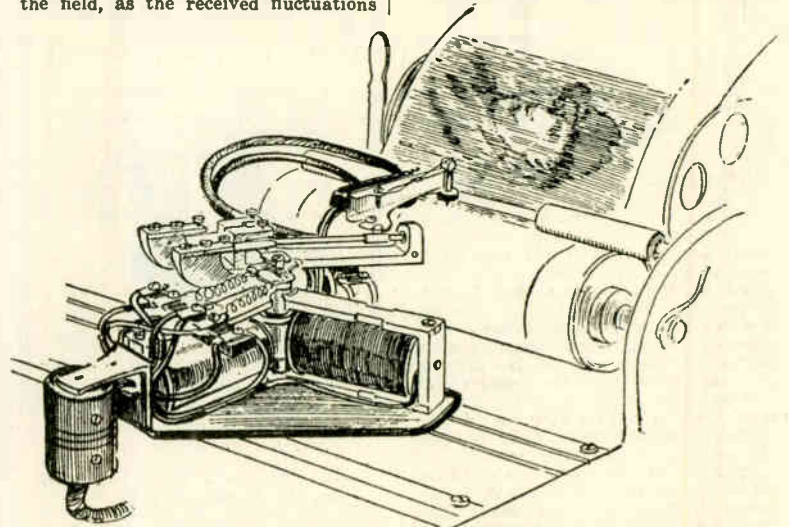

The recording mechanism of the receiver. Three electromagnets produce the magnetic field in which a moving coil controls the stylus.

are applied through its windings, operates a stylus while travelling across the surface of the paper. The stylus traverses the paper in perfect synchrony with the carriage of the transmitter, the paper being lifted

tact point, but when current passes through the electromagnet, the armature is attracted and the contact is broken. The spring then resumes its normal position, re-establishing the contact and the same process is re-



peated again and again. (See *Inter-rupter*.)

**TRIGGER BATTERY**—A term (seldom used) denoting a small battery inserted in the grid circuit to give the grid its initial charge when a tube is being used for radio transmission. In this connection, the battery is used to replace the potentiometer. (See *Grid Battery*, also *Grid Bias*.)

**TRIODE**—A name used to designate the three-electrode type of *thermionic tube*. Other names sometimes applied to the same device are *audion* (q.v.), *audiotron*, *aerotron*, *electron relay* (q.v.), *electron tube* (q.v.), *pliotron* (q.v.), *thermionic valve*, *oscillion* (q.v.), *vacuum tube* (q.v.), etc. (See *Three-Electrode Thermionic Tube*.)

**TRUE POWER**—The product of the *apparent power* and the *power factor* (q.v.) in an alternating current circuit. (See *Power*, *True*, also *Power*, *Apparent*.)

**"T" TYPE AERIAL**—See *"T" Antenna*.  
**TUBE OF FORCE**—A theoretical conception, similar to *Line of Force* (q.v.) used in mathematical considerations of electrostatic or electromagnetic fields.

**TUBE RECTIFIER**—A vacuum tube or gas filled tube used to change or rectify alternating current to direct current. The principle of the action of the vacuum tube rectifier is the fact that the electrons will flow from the hot filament to the plate, but not in the reverse direction. Tubes are made for half-wave or full-wave rectification. (See *Rectifying Tube*.)

by short transverse ribs for the purpose of giving strength to the plate. This gives a large surface and since there is no central web, the electrolyte is enabled to circulate through the plate thus working the active material uniformly.

**TUNED ANTENNA**—A transmitting aerial, having a loading inductance or a variable condenser or both in series with it, for the purpose of changing the antenna wave length.

**TUNED IMPEDANCE**—This refers especially to a circuit, or to a method of radio frequency amplification in which a tuned inductance connected in parallel with a variable condenser is used as the method of coupling rather than transformer or resistance coupling. (See *Impedance Coupled Amplifier*.)

**TUNED RADIO FREQUENCY**—See *Tuned Radio Frequency Circuit*.

**TUNED RADIO FREQUENCY AMPLIFIER**—A combination of a *radio frequency transformer*, a variable condenser and an amplifying vacuum tube in a radio receiving circuit for the purpose of increasing the intensity or amplifying the radio frequency signals.

**TUNED RADIO FREQUENCY CIRCUIT**—A radio receiving circuit employing radio frequency amplification in which the radio frequency amplifier circuits may be tuned to the desired wave lengths by varying the inductance or the capacity, or both although the usual method of tuning is by means of a variable condenser in parallel

**TUNED TRANSFORMER**—See *Resonance Transformer*.

**TUNGAR**—A trade name for a two-electrode vacuum tube especially de-



A typical rectifier tube of the Tungar type. The screw-base allows it to be inserted in a standard lamp socket from which current is obtained for the filament. Connection is made to the graphite disc by means of a Fahnestock connector which clips on to the wire post projecting from the other end of the tube.

signed for rectifying purposes. Tungar tubes are made in two ampere and five ampere capacities. They are used in *chargers* (q.v.) and also in

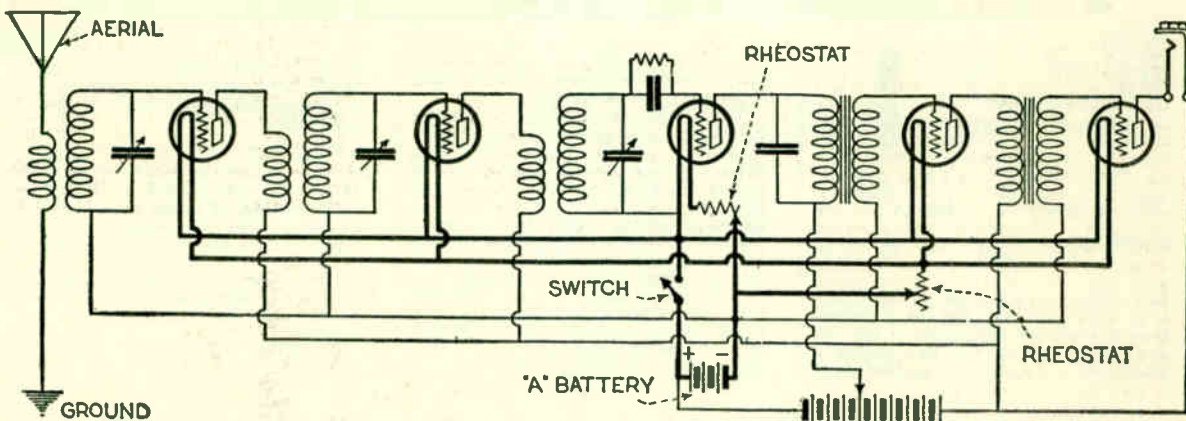

A standard five tube tuned radio frequency circuit.

**TUBE, THREE ELEMENT**—See *Triode*, also *Three-Electrode Thermionic Tube*.

**TUBE, TWO ELEMENT**—See *Fleming Valve*.

**TUBING**—In general, this refers to the bakelite or hard rubber forms used to wind inductance coils on. Another type of radio tubing is defined under *Spaghetti*.

**TUDOR ACCUMULATOR**—A storage battery having special positive plates formed by the *Plante* process and negative plates of the *Faure* or pasted type. The Tudor positive is of the cast-lead type. This plate has no central web and is made by casting pure soft lead in a mold. Casting is advantageous since it permits the distribution of the metal in the plate without limitations in the manufacturing process. After the plate is removed from the mold, its surface consists of a large number of short vertical ribs which run entirely through the plate. These are bound together

with the secondary of the radio frequency transformer. A typical five-tube tuned radio frequency circuit is shown in the accompanying illustration. This consists of two stages of tuned radio frequency amplification, a detector and two stages of audio frequency amplification.

**TUNED RADIO FREQUENCY TRANSFORMERS**—An air core transformer (q.v.) shunted by a variable condenser used in a *tuned radio frequency circuit* (q.v.). (See *Fixed Coils*, also *Low Loss Coils*.)

**TUNED TELEPHONE**—One in which the diaphragm is adjusted to vibrate at the same frequency as the current impulses to be indicated. In addition the telephonic circuit may have its inductance and capacitance chosen to have the same electrical frequency, and a tuned acoustic resonator may intervene between the diaphragm and the car.

radio sets operating directly from the lighting socket without the use of batteries. (See *Rectifying Tube*.)

**TUNING**—The process of regulating the inductance and the capacity of a radio circuit in order to be in unison with a desired wave length.

**TUNING, BROAD**—Reception of a signal over a wide range, that is on a number of wave lengths, rather than on a single one. A receiving set which tunes broadly cannot be used where the broadcasting stations are transmitting on wave lengths near to one another. Too long an aerial may result in a receiving set tuning broadly. (See *Selectivity*.)

**TUNING COIL**—A coil of wire so arranged that each turn is electrically insulated from its neighbor and with a device by which contact may be made to bring any desired number of turns into the circuit so as to increase or decrease the inductance of a radio

**T.Y.K. Arc**

circuit so as to tune it to the desired wave length. A variable inductance (q.v.) used for tuning an oscillatory circuit. (See *Lengthening Coil*.)

**T.Y.K. ARC**—A transmitting arc used for radio telephony invented by W. Torikata, E. Yokoyama and M. Kitamura of Japan. This arc uses magnetite and brass electrodes instead of copper-carbon electrodes. A circuit diagram of the T.Y.K. system is shown in the illustration. The materials used for the electrodes are such that a high resistance film forms on their surfaces. This requires a temporary high voltage to start the discharge. This is accomplished as follows: An armature, A, is attached to one of the electrodes. The two electrodes are in contact, and

a steady current is caused to flow in

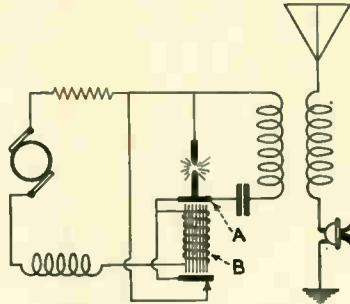

Circuit diagram of the T. Y. K. arc.

the circuit, through the spark induction coil B. This attracts the armature A, drawing the electrodes apart. The break of the spark coil current at its interrupter induces a high electromotive force which, acting through the coil and the spark gap in series, breaks down the film on the gap electrodes. The power supplied to the gap is 500 volts and 0.2 ampere. A condenser of approximately .05 mfd. is used in the primary oscillating circuit.

T.Y.K. sets have been used only in small units, having a range of 30 or 40 miles.

Several unusual features appear in the circuit shown in the accompanying illustration, which gives the circuit diagram of the T.Y.K. arc.

**U**

**ULTRA-AUDION**—A name sometimes applied to the vacuum tube used in connection with *beat* reception for supplying local oscillations. In general, however, the name ultra-audion applies to a circuit for radio reception. (See *Ultra-Audion Circuit*.)

**ULTRA-AUDION CIRCUIT**—A type of circuit used for long wave radio recep-

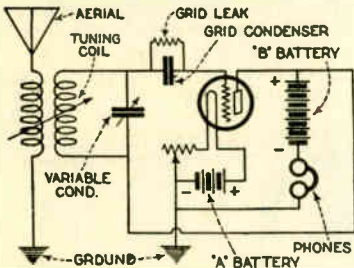

Diagram of an ultra-audion regenerative circuit.

tion which uses a form of regeneration, without calling for the introduction of auxiliary equipment in the circuit. A typical ultra-audion circuit is illustrated. It will be noticed that

while one terminal of the secondary goes to the grid, the other terminal, which usually goes to the filament, in this case goes to the plate. Thus there is a direct plate-filament circuit which does not involve the plate and filament batteries in the usual manner.

**ULTRADYNE**—A modification of the *super-heterodyne circuit* (q.v.), which uses the modulation method to produce beats. In this method the incoming signal is caused to modulate the oscillations produced locally in a similar way to that in which the speech or music modulate the carrier wave of a broadcast station. It is claimed that this method is simpler than the ordinary super-heterodyne and also more sensitive to weak signals.

The circuit of the improved model L-2 Ultradyne, incorporating regeneration is shown below. The long wave intermediate transformers are accurately tuned to a wave length of 3000 meters. Referring to the diagram, it will be noted that a special form of oscillator, comprising a grid and plate coil, are used together with an oscillator tuning condenser connected across the grid coil. The first tube, which is usually the detector in the standard super-heterodyne circuit, is known as the modulator tube. (See *Super-Heterodyne Receiver*.)

**UMBRELLA ANTENNA**—An antenna, the conductors of which form elements of a cone with the apex at the top to which the *down lead* (q.v.) is connected.

**UNDAMPED**—See *Undamped Alternating Current*, also *Undamped Waves*.

**UNDAMPED ALTERNATING CURRENT**—Periodic current (i.e., current passing through successive equal cycles of values) whose average value is zero.

**UNDAMPED OSCILLATIONS**—Oscillations which are sustained. *Undamped alternating current* (q.v.). Oscillations such as are generated by a *vacuum tube oscillator* or by an *arc generator*.

**UNDAMPED WAVES**—Continuous waves. Waves in which similar current cycles follow each other continuously instead of being broken up into groups. (See *Sustained Waves*, *Decadent Wave*, also *Damped Waves*.)

**UNITS**—Specified amounts of physical quantities used as a basis of measurement. (See *Practical Units*.)

**UNITS, ELECTROMAGNETIC**—See *Electromagnetic Units*.

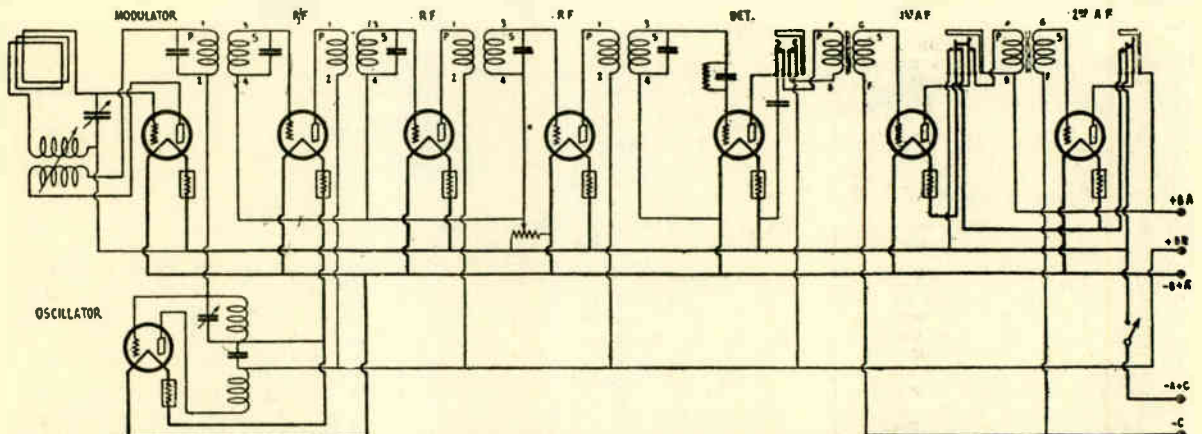

This shows the hook-up of the Ultradyne super-het. This set is not radically different from the average super-heterodyne. The heterodyners are of the tuned air core type and the filter is shown at the input side of the circuit. Aerial and ground as well as loop may be used with this set and instead of the first detector the inventor uses a tube known as the "modulator."

# V

**VACUUM TUBE**—An evacuated bulb, or one containing a rare gas and having three elements, filament, plate and grid. (See *Three-Electrode Thermionic Tube, Triode, also Dynatron.*)

mately 4½ volts to 45 volts, depending upon the type of power tube. Tubes suitable for developing considerable power, in radio transmission are also referred to as power tubes.

low shows one of the new power tubes used for reception.

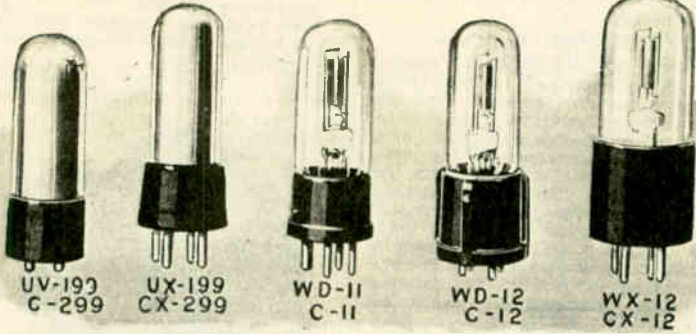

A group of dry-cell vacuum tubes. The first two differ only as to the type of base; both are intended to be operated from a 4½-volt "A" battery, that is, three dry-cells connected in series. The filaments draw very little current, as can be determined from the chart. The last three tubes also have identical characteristics, but are designed to fit different types of sockets. These tubes operate from a single 1½-volt dry cell and draw approximately ¼ ampere of current. The filaments are oxide-coated and very rugged.

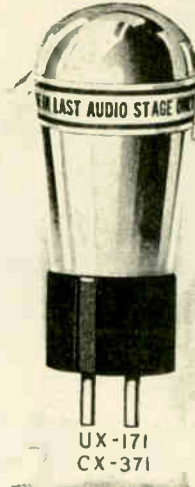

A new storage-battery type power amplifier tube, for use in the last stage of a radio amplifier only. This tube takes the same filament voltage and filament current as the No. 112 tube but employs a "B" voltage of 180 and 40½-volt "C" battery. Special means should be provided for handling its heavy output.

**VACUUM TUBE AMPLIFIER, THEORY OF**—The vacuum tube may be used as an amplifier or magnifier because of the fact that under proper conditions, a small variation of the electromotive force applied between the filament and the grid produces a very large variation in the current flowing in the plate circuit. It is usual to use several amplifying tubes together, suitably coupling the plate of one tube to the grid of the next, thus increasing the amplification to the desired value.

**VACUUM TUBE CHARACTERISTICS**  
Performance curves of vacuum tubes. These are obtained experimentally by keeping the filament current constant and applying various known voltages between the plate and the filament and between the grid and the filament and reading the resultant currents that flow to the plate and the grid. The various values obtained are then plotted on cross-section or graph paper. Such curves are convenient for determining the operating characteristics of a particular vacuum tube under consideration. (See *Characteristic Curve.*)

**VACUUM TUBE GENERATOR**—The vacuum tube can be used to produce sustained oscillations without the necessity of supplying potential variations to the grid from an external source. This can be accomplished as a direct result of the amplification properties of the vacuum tube, since the energy of the output circuit is greater than the energy of the input circuit and part of this output energy may be returned to the input to produce constant reamplification.

**VACUUM TUBE, POWER**—A tube of special design, made for use in the last audio stage of a radio receiving set, which will handle greater current than the ordinary amplifying tube, thus resulting in more volume and at the same time clearer and more satisfactory tone reproduction. Power tubes now on the market require higher plate voltages than conventional tubes, ranging from 135 volts upwards. The amount of grid bias or "C" battery ranges from approxi-

By increasing the surface area and hence the filament emission or by increasing the degree of evacuation of the bulb, thus allowing a higher plate voltage, the output of the tube may be increased. A form of transmitting power tube is described under the heading *Pliotron*. The illustration be-

**VACUUM TUBE RECTIFIER**—A vacuum tube designed or used to change alternating current to direct current. (See *Rectifying Tube, Kenotron, also Tube Rectifier.*)

**VACUUM TUBE, THEORY OF OPERATION**—See *Theory of Operation of Vacuum Tubes.*

## CHART OF VACUUM TUBE TYPES AND CHARACTERISTICS

TYPE	USE	"A" bat- tery Volts (Supply)	Filament Terminal Volts	"A" Battery Current Amperes	"B" Battery Volts		Negative "C" Battery Volts	Voltage Amplification Factor	Output Resistance Ohms
					Det.	Amp.			
UV, UX-199 C, CX-299	Det. or Amp.	4.5	3	.06	45	90	4.5	6.25	15,000
UV, UX-200 C, CX-300	Det. only	6	5	1.0	16 to 22½				
UX-200-A CX-300-A	Det. only	6	5	.25	Max. 45				
UV, UX-201-A C, CX-201-A	Det. or Amp.	4.5	3	.25	45	90 to 135	4.5 9.0	8 8	12,000 11,000
UX-120 CX-220	Pow. Amp. (Lat. stg. only)	6	5	1.125		135	22.5	3.3	6,600
UX-112 CX-112	Det. or Amp.	6	5	.5	22½ to 45	135	9.0	Var.	Var.
UX-171 CX-371	Pow. Amp. (Lat. stg. only)	6	5	.5		180	40.5		
UX-210 CX-310	Oscillator	6	6	1.1		90 to 425	4.5 to 35	Var.	Var.
WD-11 C-11	Det. or Amp.	1.5	1.1	.25	22½	90	4.5	5.6	14,000
WD, WX-12 WX, CX-12	Det. or Amp.	1.5	1.1	.25	22½	90	4.5	5.6	14,000
3VB-199 3VBX-199	Det. or Amp.	4.5	3	.06	20	80	4.5	6.0	
3V-A 3VAX	Det. or Amp.	4.5	3	.12	20	90	4.5	6.5	
5V-A 5VAX	Det. or Amp.	6	5	.25	20	100	4.5 to 9.0	9.4	9,400
5VC 5VC	Pow. Amp. or Det.	6	5	.5	22½	90 to 157½	6 to 10.5	8.6	5,900
99 99X	Det. or Amp.	4.5	3	.06	22½	90 to 150	3 to 12		
OIA OIX	Det. or Amp.	6	5	.25	22½	90 to 150	3 to 12		
MU-20 MU-6	Audio Amp. Pow. Amp.	6	6	.25	22½	90 to 150	4.5 to 10.5	20	40,000
B-6 A	(Lat. stg. only) Det. only	6	6	.5		90 to 150	4.5 to 10.5	6	5,000
B C	Det. or Amp.	6	5	.25	16 to 22½	120	4.5 to 9		
E	Det. or Amp.	4.5	3	.06	20	80	4.5		
F	Pow. Amp. (Lat. stg. only)	4.5	3	.125		135	22.5		
G	Pow. Amp. (Lat. stg. only)	6	5	.5		90 to 180	4.5 to 9		
DC—	Audio Amp.	6	5	.25		90 to 180	4.5 to 9		
DC—	Det. or Amp.	4.5	3	.06	45	90	4.5	6.3	16,500
DC—	Det. or Amp.	6	5	.25	45	90	4.5	8.5	10,000
DC—	Pow. Amp. (Lat. stg. only)	4.5	3	.125		112 to 135	13 to 22.5	3.3	6,300
DC—	Pow. Amp. (Lat. stg. only)	6	5	.5		90 to 157.5	6 to 10.5	8.0	8,500

Vacuum Tubes, Types of

**VACUUM TUBES, TYPES OF**—Vacuum tubes are of various types and designs depending upon the work which they must do. They may be divided into two general classes, receiving tubes and transmitting tubes.



A new type of detector tube which has greater sensitivity than former types, due to the use of an alkaline vapor. It can be used as a detector in any type of receiving circuit.

Tubes for receiving purposes are designed either for dry cell operation or else are of the storage battery type.

**VALENCY**—The property possessed by elements in combining with or replacing other elements in a certain definite proportion. Also referred to as *valence*. (See *Electro-Chemical Equivalent*.)

**VALVE**—This generally refers to a vacuum tube used as a detector or rectifier. The name *valve* is used in many foreign countries to refer to the thermionic vacuum tube, as used for any purpose.

**VALVE DETECTOR**—See *Valve*.

**VARIABLE CONDENSER**—A condenser having rotatable or movable metal plates and an air dielectric. Both the stationary and rotating plates may be made of brass, copper or aluminum. Bakelite, fibre or composition are used to insulate the stationary from the movable plates. Turning the movable plates either increases or decreases the capacity of the condenser. Variable condensers are primarily used in radio for *tuning* (q.v.). They are constructed so as to have straight line frequency characteristics either by undercutting a portion of the movable plates or else by making these of a variable thickness.

**VARIABLE GRID LEAK**—A variable high resistance unit designed to be

merely tightening a thumb-screw. (See *Grid Leak*, also *Adjustable Grid Leak*.)

**VARIABLE RATIO TRANSFORMER**—A transformer in which the ratio between the primary and the secondary windings can be varied, usually by means of suitably located taps.

**VARIABLE RESISTANCE**—Both the *rheostat* and the potentiometer used in radio work, are variable resistances. Variable resistances are usually of high resistance wire type, with a sliding contact so that the resistance can be easily altered.

**VARIO COUPLER**—A tuner formerly used in radio receiving sets, having a



A standard form of vario coupler.

primary and a secondary coil inductively coupled, with the secondary arranged so as to be rotatable within the primary. The amount of coupling depends upon the variation of the angle between the axes of the two coils.

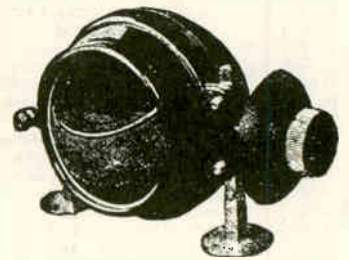

A variometer.

**VARIOMETER**—A tuner, similar to the vario-coupler, except that the primary and secondary coils are electrically connected.



These power amplifier tubes are designed for use in the last stage of an audio frequency amplifier. On the left is a dry cell tube which requires a 4½-volt "A" battery. The center tube employs exceptionally high "B" battery voltage, and is usually employed with an amplifier that operates from the house current. This tube can also be used for transmitting purposes. The right-hand tube is of the storage battery type and has a very rugged filament. It makes an excellent detector tube as well as a power amplifier.

They may be further classified as detector tubes, amplifying tubes or power tubes. There are many special types of tubes, such as *kenotrons* (q.v.), *pliotrons* (q.v.), etc.

placed in the grid circuit of a vacuum tube used as a detector. Certain types of variable grid leaks may have their resistance varied from ¼ megohm to 10 or more megohms by



The characteristics of these vacuum tubes are given in the vacuum tube chart on page 187. The first tube is of the dry-cell type, requiring a 4½-volt "A" battery for lighting the filament. 3V-A is a standard 5-volt tube. 5VX is a power amplifier which can be used in the last stage of any audio-frequency amplifier. There is no necessity of changing any of the wiring in the set for the addition of more "B" battery, as binding posts are included on the tube itself. 5VA has a sponge rubber ring included as a part of the base which tends to absorb all vibrations which might otherwise cause the tube to become noisy. The next type of tube is for use as a detector only. The last is the well-known 201-A type, which can be employed as a detector or an amplifier.

**VECTOR**—A graphical illustration used in mathematical calculations, consisting of a line with an arrow-head at one end, used to show by means of its length, direction and the angle between itself and another vector or vectors, the magnitude, direction and phase angle of alternating current quantities.

**VELOCITY**—The distance passed through in a certain time. Velocity is measured in feet per second, miles per hour, etc.

**VIBRATION**—A to and fro motion. An oscillating or swinging motion.

**VITREOUS**—Consisting of or pertaining to glass. (See *Resinous Electricity*.)

**VOLT**—The practical unit of *electromotive force* (q.v.). The volt is a measure of the electromotive force which will cause a current of one ampere to flow through a resistance of one ohm. It is equal to  $10^9$  absolute electromagnetic units (Abvolts).

**VOLTAGE**—The electrical pressure or the electromotive force between two points in an electrical circuit, measured in volts.

**VOLTAGE, CONSTANT**—A steady unvarying electrical pressure or electromotive force, as differentiated from a pulsating or fluctuating voltage.

**VOLTAGE DROP**—The fall in potential caused by the resistance of the conductor through which the current is flowing. The longer the conductor, the greater will be the voltage drop. The greater the cross-section of the conductor, the less will be the voltage drop.

**VOLT-AMPERES**—The product of volts as measured with a voltmeter, by the current as shown on an ammeter, in an alternating current circuit, gives the apparent power, or in other words the apparent watts. (See *Instantaneous Values*.)

**VOLTMETER**—An instrument for measuring voltage drop or potential difference. Most of the voltmeters



A plug-in type of voltmeter.

used in radio work operate on the

## Wave Length Allocations

moving coil principle. (See *Galvanometer*.)

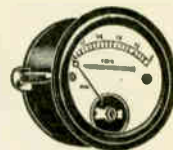

Panel-type of voltmeter.

**VOLTMETER CALIBRATION**—A method of correctly marking the voltage readings on the scale of a voltmeter or of checking up the voltmeter readings to make sure that they are accurate. The usual method of calibration is to check the voltmeter reading by comparison with a standard voltmeter. (See *Calibration*.)

**V.T.**—Abbreviation for *vacuum tube*.  
**VULCANITE (EBONITE)**—A hard black substance produced by vulcanizing rubber with about 25 per cent sulphur. It is readily polished and has excellent insulating properties.

**VULCANIZED RUBBER**—Pure rubber, mixed with five per cent sulphur and baked at a temperature of about 150 degrees Centigrade. Vulcanized rubber must not be allowed to come into contact with copper, which is chemically attacked by the sulphur.

## W

**WALL TUBE**—See *Partition Insulator*.

**WATCHCASE RECEIVER**—A telephone receiver having a shape somewhat similar to a watch. Watch case receivers are compact in construction and are the usual type used in the radio telephone *head set*.

**WATT**—The unit of electric power. One *Joule* (q.v.) per second. To find power in a direct current circuit, multiply voltage by amperage. The *Kilowatt* (q.v.) equals one thousand watts. Seven hundred and forty-six watts are equivalent to one electrical horsepower.

**WATT HOUR**—The commercial unit of electrical work. The work done in one hour by a current of one ampere flowing between two points of a conductor having a difference of potential of one volt.

**WATT-HOUR METER**—An integrating

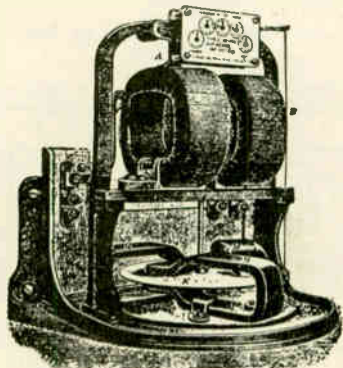

A direct current watt-hour meter.

meter which measures energy in watt-hours or in kilowatt-hours. (See *Integrating Wattmeter*.)

**WATT, INTERNATIONAL**—symbol W—The energy expended per second by an unvarying electric current of one International ampere under an electrical pressure of one International volt.  $1W = 1 \text{ Joule per second} = 10^7 \text{ ergs per second}$ .

**WATTLess COMPONENT—WATTLess CURRENT**—The component of an alternating current which is in quadrature with the voltage. (See *Reactive Component*.)

**WATTMETER**—An instrument designed to measure the power being expended in an electrical circuit. The most common form of direct current wattmeter is of the dynamometer type. This has two coils, one fixed and one movable, one coil being connected so as to exert a force proportional to the current flowing in the circuit, and the other coil exerting a force proportional to the electromotive force. The *induction* type of wattmeter is in general use for alternating current circuits. (See *Electro-Dynamometer*, *Dynamometer*, also *Induction Wattmeter*.)

**WATT SECOND**—A unit of electrical energy, representing the energy expended by one watt flowing for a second. The watt second is the same as the *Joule* (q.v.) and is usually applied to the measurement of heat developed by an electric current.

**WAVE**—A periodic alternation of an alternating current. As applied to an electric or electromagnetic disturbance, an electric wave is an undulatory movement of the ether, radiated from conductors carrying electrical oscillations.

**WAVE ANALYSIS**—A study of the wave form of an alternating current or other type of wave. The wave form of commercial alternating current used for lighting purposes approximates a *sine curve* (q.v.). A convenient instrument for the analysis and study of alternating current wave

form is known as the *oscillograph* (q.v.).

**WAVE ANTENNA**—A horizontal antenna, the physical length of which is approximately equal to the length of signaling waves to be received, and which is so used as to be strongly directional.

**WAVE DISTORTION**—Alteration in the wave form of a wave after it has traversed a considerable distance. (See *Distortion*.)

**WAVE FORM**—Referring to an alternator, the "shape" of the curve of the current generated.

**WAVE FREQUENCY**—See *Frequency*.

**WAVE LENGTH**—symbol  $\lambda$  (lambda)—The distance between two successive *antinodes* (q.v.) in the same direction. In referring to the wave length of electrical oscillations in a circuit, this means the length of the waves in free space that would have a frequency corresponding to the given oscillations. Electromagnetic waves used in radio work have frequencies of from 10,000 to 3,000,000 cycles per second. Since these waves have a velocity of approximately 300,000,000 meters per second, it is possible to calculate the length of a wave by dividing the velocity by the frequency. In other words meters per second divided by cycles per second gives length of the wave in meters. Thus a wave having a frequency of 100 kilocycles (100,000 cycles) will have a wave length of 300,000,000 divided by 100,000 or 3,000 meters.

**WAVE LENGTH ALLOCATIONS**—In order to prevent radio transmitting stations from interfering with each other, or creating interference at a receiving station, various wave length bands have been allotted to each type of service. The following table shows the present short wave assignments and the service for which they are used:

**Wave Length Calc. for Ant.**

Wave-length in Meters	Service
109-105	Relay broadcasting only.
105-85.7	Public toll service, Government mobile, and point-to-point communication by electric power supply utilities, and point-to-point and multiple address message service by press organizations only.
85.7 -75.0	Amateur, Army mobile, naval aircraft, and naval vessels working aircraft only.
75.0 -66.3	Public toll service, mobile Government point-to-point and point-to-point public utilities.
66.3 -60.0	Relay broadcasting only.
60.0 -54.5	Public toll service only.
54.5 -52.6	Relay broadcasting only.
52.6 -42.8	Point-to-point only.
42.8 -37.5	Amateur and Army mobile only.
37.5 -33.1	Public toll service, mobile, Government point-to-point, and point-to-point public service utilities.
33.1 -30.0	Relay broadcasting only.
30.0 -27.3	Public toll service only.
27.3 -26.3	Relay broadcasting only.
26.3 -21.4	Public service, mobile, and Government point-to-point.
21.4 -18.7	Amateur only.
18.7 -16.6	Public toll service, mobile and Government point-to-point.
16.6 - 5.35	Experimental.
5.35 - 4.69	Amateur.
4.69 - 0.7496	Experimental.
0.7496- 0.7477	Amateur.

Radio broadcast stations work within the wave length band of 200 to 545 meters at intervals of 10 kilocycles. 600 meters is reserved for distress signals. The higher wave lengths are allocated to various marine, government, university, aircraft and other uses.

**WAVE LENGTH CALCULATION FOR ANTENNA**—For the ordinary vertical wire grounded antenna, the fundamental wave length is slightly greater than four times the length of the wire. A constant suggested is 4.2 and applies approximately also to flat top antennae having vertical lead ins. For other calculations see *Fundamental Wave Length*.

**WAVE LENGTH, FUNDAMENTAL**—See *Fundamental Wave Length*.

**WAVE LENGTH, NATURAL**—In a loaded antenna (that is with series inductance or capacity) the natural wave length corresponds to the lowest free oscillation. (See *Natural Wave Length*.)

**WAVE LENGTH OF STATIONARY S. H. M. WAVES**—On a straight wire, the smallest distance between two points where the disturbance is of the same amplitude and phase; or, since consecutive loops (q.v.) are in opposite phases, the wave length is double the distance between consecutive loops or consecutive *nodes* (q.v.). (See *S.H.M.*)

**WAVEMETER**—A radio instrument for measuring frequency. A calibrated resonator of variable frequency, capable of easy excitation by the oscillation under test, combined with a means of indicating the attainment of resonance. The calibration may be

given directly in wave lengths or frequencies or both.

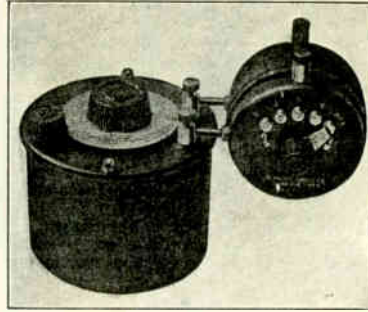

Photo by courtesy of General Radio Co.

The selectivity of the radio set may be greatly increased by the use of this wavemeter as a radio filter.

**WAVEMETER CALIBRATION**—Wavemeters may be calibrated by comparison with a standard wavemeter. An accurate method of calibrating a wavemeter, known as the *Three-Way Method* is shown in the accompanying diagram. In this illustration A is the standard wavemeter, B the wavemeter to be calibrated, and C is a condenser and coil of size permitting resonance

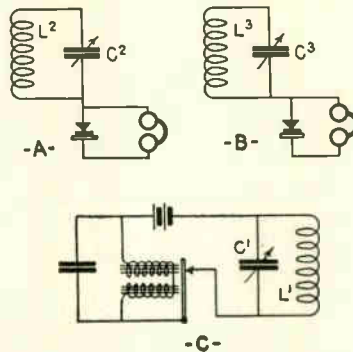

Diagram showing three-way method of wavemeter calibration.

with A. To calibrate, the buzzer should be put in operation, varying the capacity of the condenser C<sup>1</sup> until L<sup>1</sup>C<sup>1</sup> is in resonance with L<sup>2</sup>C<sup>2</sup> as noted in the head set. The wavemeter B should then be put in inductive relation to C and the condenser C<sup>2</sup> varied until the wavemeter A resonates with C. The wave length of B is now the same as A. This procedure should be carried out over the whole range of the condenser C<sup>1</sup>.

**WAVE MOTION**—A disturbance of the equilibrium of a medium or body, extended or propagated from point to point with a continuous motion, each particle vibrating only on each side of its position of equilibrium, while each phase of vibration moves onward. Examples of wave motion are the propagation of electromagnetic waves, or the waves on the surface of a body of water.

**WAVES, CONTINUOUS**—See *Continuous Waves*.

**WAVES, CONTINUOUS, KEY MODULATED**—See *Continuous Waves, Key Modulated*.

**WAVES, CONTINUOUS, MODULATED AT AUDIO FREQUENCY**—See *Continuous Waves at Audio Frequency*.

**WAVES, ELECTROMAGNETIC**—Periodic electromagnetic disturbances progressive through space. (See *Wave*.)

**WAVES, SUSTAINED**—See *Sustained Waves*, also *Continuous Waves*.

**WAVE TRAIN**—A series of waves. An example of a wave train is the series of disturbances set up by each spark in a spark system of radio telegraphy.

**WAVE TRAP**—A device consisting of a variable condenser and coil, usually connected in the antenna circuit of a receiving set, to eliminate interference from undesired stations. (See *Filter, Filter Condenser, Acceptor*, also *Rejector*.)

**WAVE-WOUND**—A class of drum armature in which connections produce a "stepping forward" in a zig-zag way line all the time. Also called *Series and Two Circuit Windings*.

**WEBER**—The *Practical Unit* (q.v.) of magnetic flux. The engineers' unit is the "line" which is also the electromagnetic unit. 1 Weber is equal to 108 electromagnetic units (or "lines"). The Weber is produced by a current of one ampere flowing through a circuit having one henry of inductance.

**WEHNELT BREAK**—An *electrolytic interrupter* (q.v.).

**WEIGHT**—The force with which the earth attracts a body. A body varies in weight according to its distance from the centre of the earth, although its mass remains constant.

**WESTON CELL**—The present standard cell. It consists of mercury with a paste of mercurous and cadmium sulphates which form the cathode. The Weston cell has an anode of 12.5 per cent cadmium amalgam in an electrolyte of saturated solution of cadmium sulphate. It has a constant electromotive force of 1.0125 volts at 20 degrees Centigrade. (See *Electromotive Force*, also *Cadmium*.)

**WHEATSTONE BRIDGE**—An instrument for measuring resistance in

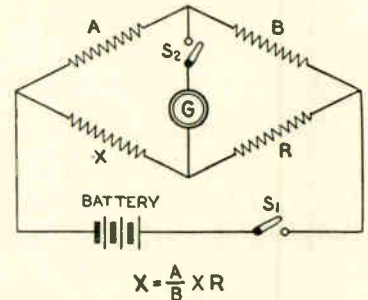
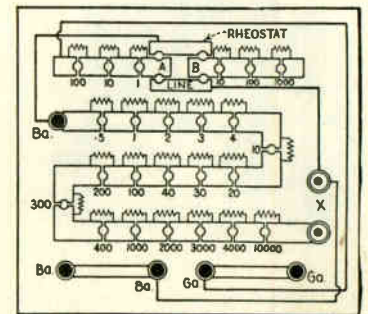

Diagram illustrating principle of the Wheatstone Bridge.

which the current from a battery divides into two parallel circuits, each



Post-Office type of Wheatstone Bridge.

divided into two "arms" capable of being adjusted so that there is no difference of potential between the dividing points on both sides. The point of zero difference of potential is indicated by the absence of deflection of a galvanometer placed across the dividing points. The ratio of the resistance of the two parts of the arms is then the same, so that if the resistance of three of the arms is known, that of the fourth arm (i.e. the resistance to be measured) can be determined.

**WHEATSTONE TRANSMITTER**—An apparatus for delivering telegraphic currents to a line at high speed. Control is effected by aid of a moving perforated paper tape, prepared according to a code.

**WHIPPING**—The binding of string or small wire round the end of a rope or multiple wire to prevent the ends from fraying out.

**WIMSHURST**—A type of Induction or Influence Machine consisting, in a simple form, of two discs of insulating material revolving in opposite directions. These carry a number of equal sectors which form combined inductors

and carriers. There are usually two collectors and two pair of brushes. (See *Induction Machine*.)

**WINDOW LEAD-IN**—A form of insulator for passing an aerial lead-in through a window. In some cases porcelain tubes are used as window lead-in's. A common form of window lead-in consists of a flat copper conductor covered with woven cotton insulation.

**WIRED WIRELESS**—A method of transmitting radio messages, in which the waves are guided by wires instead of radiating freely through the ether. (See *Line Radio*.)

**WIRE GAUGE**—A device for measuring the diameter of a round wire in accordance with a predetermined scale. The gauge commonly used in this country is the Brown and Sharpe (B. & S.) or American gauge.

**WIRELESS TELEGRAPHY**—Also known as **RADIO TELEGRAPHY** (q.v.)—A system of telegraphy, utilizing electromagnetic waves set up by oscillating currents as the means of transmission. The waves generated at the transmitting station spread out from the aerial (q.v.) in all directions.

They are intercepted by the receiving aerial, detected by a rectifying device such as a crystal or vacuum tube, amplified and delivered to a head set or loud speaker. A key is used at the transmitter to control the duration of the waves so that they will correspond to the dots and dashes of the *continental code* and these dots and dashes are reproduced in the phones at the receiving station.

**WOLLASTON WIRE**—Platinum wire, drawn extremely fine by the process of coating fine platinum wire with ductile material, drawing the whole down together, and (if required) removing the coating by dissolving it off.

**WORK**—The action of a force upon a body to overcome resistance. Work is measured by the product of the force exerted and the distance moved. Work may be measured by *ergs* (q.v.), *foot-pounds*, *horsepower*, etc.

**WOOD'S METAL**—A soft metallic alloy having a low melting point. This alloy consists of two parts of lead, one part of tin, four parts of bismuth, and one part of cadmium, all by weight. This metal has been used extensively for setting detector crystals in their cups, so as to make a good electrical contact.

## X, Y, Z

**X**—Symbol for *Reactance* (q.v.).

**"X" RAYS**—Also called *Roentgen Rays*. Electric waves of much higher frequency than light, produced by the striking of *cathode rays* upon a solid substance. These rays are not deflected by electric or magnetic fields and possess the property of penetrating solid substances which could not be penetrated by ordinary light rays. The use of the "X" Rays permit photographs to be taken of bones or other parts of the human body which could not be seen in any other way.

**X'S**—Disturbances of an erratic nature heard from time to time in the phones or loud speaker of a radio receiving set, due to storms, electric disturbances, etc. (See *Atmospherics*, *Natural Electric Waves*, *Static*, also *Strays*.)

**YAGI SPARK GAP**—A form of spark gap originated by H. Yagi. It is a quenched spark gap, the electrodes of which are aluminum and brass. The gap functions in an atmosphere of coal gas.

**"Y" GROUPING**—See *Star Grouping*.

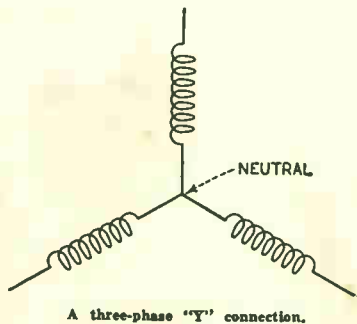

**YOKE**—A piece of soft iron used in certain forms of electromagnets to yoke two parallel cores together mag-

netically. The cores of the ordinary electric bell are fastened together at one end by means of a yoke.

**YOKOJAMA, EITARO**—Japanese radio expert. He was born in 1883 and was educated at the Engineering College of the Tokyo Imperial University. While at college, he specialized in radio. He was appointed to the Electro-technical Laboratory of the Japanese Ministry of Communications, to carry out research work in wireless telegraphy and telephony. He was one of the inventors of the T.Y.K. oscillation gaps for radio telephony, for which he received many distinctions. In 1910 he was appointed head of the Radio Section. Yokojama, who is one of the most brilliant Japanese radio experts, is a member of the Institute of Radio Engineers and of many other scientific societies.

**ZEEMAN EFFECT**—Doubling of the spectrum lines of light sources when placed in a strong magnetic field.

**ZENNECK, J.**—German wireless expert. He was born April 15th, 1871, at Wurtemberg and was educated at Tuebingen. In 1895 he was appointed assistant in the Physical Institute in Strassburg, a post he held until 1899, when he carried out a series of tests in radio telegraphy in the North Sea. In 1905 he was appointed assistant professor of physics at the Institute of Technology, Brunswick and was appointed professor at Munich in 1913. Professor Zenneck has written a number of authoritative books on wireless and also a large number of articles on electro-magnetic oscillations.

**ZERO BEAT RECEPTION**—The detection of continuous modulated waves using a local source of high frequency current having a frequency equal to that of the incoming wave. When this continuous voltage is impressed on the incoming modulated voltage, (both of the same frequency) the output of the detector contains a current of audio frequency similar in char-

acter to the modulated current at the transmitter.

**ZERO METHOD**—A method of measurement in which various adjustments are made until the current flowing through a galvanometer is reduced to zero, as in a *Wheatstone Bridge* (q.v.). (See *Null Method*.)

**ZINC**—A metallic element. Its chemical symbol is Zn. In color, zinc is bluish-gray. It is practically non-corrosive in the atmosphere, is capable of taking a high polish, is unaffected by water, but is soluble in nitric acid and in soda and potash solutions. Pure zinc is attacked very slowly by sulphuric acid, but this feature is one of the greatest in the application of zinc in radio work and in electrical work generally.

Zinc is one of the most important components of most dry cells. It forms the negative terminal in most "B" batteries. Zinc in rod form is used in most forms of wet cells.

**ZIRCONIUM**—One of the metallic elements. Its chemical symbol is Zr, and its atomic weight is 90.6. Zirconium is an iron-gray powder in one form, or it may be made to crystallize. The crystals look like antimony, are very brittle and extremely hard, being capable of scratching glass and rubies. Zirconium resembles thorium in many of its chemical properties. For the control of the vacuum in high vacuum tubes, a small quantity of thorium or zirconium is included in the tube. These metals combine with hydrogen, oxygen, nitrogen, etc., to form compounds of very low vapor pressure.

THE HISTORY OF

THE CITY OF BOSTON

FROM THE FIRST SETTLEMENT TO THE PRESENT TIME

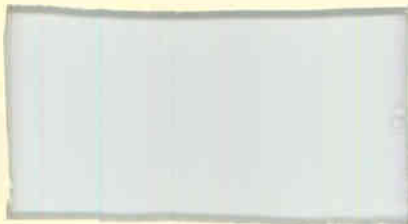



# SUPPLEMENT

## CLASSIFIED INDEX TO S. GERNSBACK'S RADIO ENCYCLOPEDIA

In the following index various co-related subjects have been gathered together for the convenience of the reader or student, under appropriate headings. Thus, under the heading of "Circuits," every circuit contained in the Encyclopedia is listed. Other important subjects are similarly treated. Where the reader is interested in but a single item such as, for example, "Bolitho Circuit," this can be found more conveniently by referring to the Encyclopedia itself, which, of course, is arranged in alphabetical order. All separate and unrelated headings or subjects should be looked up in this manner, that is by referring directly to the Encyclopedia, as these are not listed in the index.

### A

<b>AERIAL, (6)</b>	<b>Page</b>
Balancing .....	21
Circuit .....	9
Fan .....	65
Frame .....	71
Height of .....	79
Horizontal .....	83
Insulation of .....	91
Insulator .....	92
Inverted "L" .....	94
Length of .....	100
Light Line .....	101
Plain .....	125
Quiescent .....	129
Receiving .....	131
Switch .....	9
Transmitting .....	154
Tuning Condenser .....	9
Wire .....	10
<b>ALTERNATING CURRENT, (11)</b>	
Theory of Production .....	12
Undamped .....	156
<b>ALTERNATOR, (12)</b>	
Alexanderson .....	11
Definition .....	12
Goldschmidt .....	74
High Frequency .....	81
Inductor .....	90
Laminated Core .....	99
Polyphase .....	126
Single Phase .....	139
Synchronous Motor .....	148
<b>AMPLIFICATION</b>	
Audio Frequency .....	19
Cascade .....	32
Constant .....	14
Factor .....	14
Impedance Coupled .....	86
Radio Frequency .....	15
Resistance Coupled .....	134
Voltage .....	14
<b>AMPLIFIER, (14)</b>	
Action of Vacuum Tube .....	15

Audio .....	19
Intermediate Frequency .....	15, 93
Radio Frequency .....	15
Resistance Coupled .....	134

### ANTENNA, (6)

Aeroplane .....	10
Cage .....	29
Capacity Measurement .....	31
Gamma type .....	73
Inductance .....	80
Non Radiative .....	118
Resistance .....	16
Tuned .....	155
Tuning Condenser .....	138
Umbrella .....	156
Wave .....	159
Wave Length Calculation for.....	160

### ARC

Characteristic .....	16
Duddell Singing .....	56
Generator .....	16
Generator System .....	16
Magnetic Blowout for.....	108
Poulsen .....	126

### B

### BATTERIES, (22)

"A" .....	3
Accumulator .....	136
"B" .....	22, 125
"C" .....	32
"C" Curve .....	32
Cell .....	33
Charger, Balkite .....	21
Chloride .....	35
Daniell's Cell .....	50
Electrolytic Cell .....	60
Filament .....	67
Float .....	70
Galvanic .....	72
Gravity .....	75
Grid .....	75
High Potential .....	81

CLASSIFIED INDEX TO S. GERNSBACK'S RADIO ENCYCLOPEDIA

	Page
High Tension .....	82
Of Alternators .....	22
Parallel Connection .....	3
Plate .....	125
Primary Cell .....	127
Secondary Cell .....	33, 136
Series Connection .....	3
Series-Parallel Connection .....	3
Storage .....	3, 136
Testing Instruments .....	22
Theory of Primary Cell .....	34
Trigger .....	155

**BIOGRAPHIES**

Alexanderson, Ernst F. W. ....	10
Appleton, Edward Victor .....	16
Arco, Graf George Von. ....	17
Armstrong, Edw. H. ....	17
Austin, Louis Winslo .....	19
Belin, Edward .....	23
Bell, Alexander Graham .....	23
Bellini, Dr. Ettore .....	23
Blondel, Andree .....	23
Blondlot, Professor Prosper Reno .....	23
Branly, Edward .....	24
Braun, Ferdinand .....	25
Brown, Sidney George .....	27
Carpentier, Jules .....	31
Clerk-Maxwell, James .....	36
Cohen, Louis .....	39
Crookes, Sir William .....	45
De Forest .....	51
Dubilier, William .....	56
Edison, Thomas Alva .....	58
Faraday, Michael .....	65
Fessenden, Reginald Aubrey .....	66
Fleming, John Ambrose .....	68
Gernsback, Hugo .....	73
Gernsback, Sidney .....	73
Goldschmidt, Rudolph .....	74
Goldsmith, Dr. Alfred N. ....	74
Hammond, John Hays, Jr. ....	78
Heaviside, Dr. Oliver .....	79
Heising, Raymond A. ....	79
Henry, Joseph .....	80
Hertz, Heinrich Rudolph .....	80
Hogan, John V. L. ....	82
Hooper, Stanford C. ....	83
Janet, Paul .....	95
Kelvin, Lord William Thompson .....	96
Kimura, Shunkichi .....	98
Kolster, Frederick A. ....	98
Koomans, Nicholas .....	99
Korn, Arthur .....	99
Langmuir, Irving .....	99
Latour, Marius .....	100
Lodge, Sir Oliver .....	102
Lombardi, Dr. Luigi .....	105
Marchant, Edgar Walford .....	110
Marconi, Guglielmo .....	110
McLachlan, Norman W. ....	111
Meissner, Alexander .....	112
Mullard, S. R. ....	115

	Page
Nally, Edward Julian .....	115
Noble, Sir William .....	118
Pannill, Charles Jackson .....	122
Phillips, Raymond .....	124
Pickard, Greenleaf Whittier .....	124
Poulsen, Valdemar .....	126
Prince, Charles Edmond .....	127
Pupin, Michael .....	127
Rayleigh, John William Strutt .....	131
Roberts, Joseph Harrison Thompson .....	135
Robinson, James .....	135
Robinson, Samuel S. ....	135
Rutherford, Sir Ernest .....	136
Squier, Major-General George Owen .....	143
Tesla, Nikola .....	151
Yokojama, Eitaro .....	161
Zenneck, J. ....	161

**C**

<b>CAPACITY, (30)</b>	<b>Page</b>
Calculation .....	29
Amt. of .....	31
Circuit .....	30
Condenser .....	40
Condenser Curves .....	40
Condensers in Parallel .....	30, 41
Condensers in Series .....	31, 41
Conversion Factor .....	30
Definition .....	30
Distributed .....	55
Earth .....	30
Electrostatic .....	63
Farad .....	65
Frequency Factor .....	30
Ground .....	30
Measurement of Antenna .....	31
Mutual .....	115
Resistance .....	31
Switch .....	31

**CIRCUITS**

"A" Battery .....	3
Armstrong Circuit (Original) .....	18
Armstrong 3-Circuit Regenerative Receiver .....	18
Armstrong Super-Regenerative .....	147
Audio Amplifier .....	19
Audio Frequency .....	71
Autoplex .....	19
Balanced .....	20
Balanced Metallic .....	20
"B" Battery .....	22
Bolithe .....	24
Breaker .....	36
Broken .....	36
Buzzer .....	29
Buzzer Exciter .....	29
Cascade N. F. and detector .....	32
Closed Circuit .....	37

	Page
Cockaday .....	37
Cockaday, with push-pull amplifier .....	37
Coupled circuits .....	44
Crystal .....	31, 46
Definition .....	36
Detector .....	52
Direct Coupled .....	54
Fourth .....	71
Heising .....	79
Heterodyne .....	79, 80
Impedance Coupled .....	85
Interference Eliminator .....	98
Inverse Duplex .....	94
Neutrodyne .....	117
Open .....	36
Parallel .....	36
Receiving .....	131
Reflex .....	132
Regenerative .....	65
Reinartz .....	133
Resistance Coupled .....	134
Series .....	3
Series Parallel .....	3
Short .....	138
Single Stage Radio Frequency amplifier .....	15
Super-Heterodyne .....	145, 146
Super-Regenerative, Armstrong .....	147
Three-Wire .....	117
Tuned Radio Frequency .....	155
Two-stage Audio Amplifier .....	19
T. Y. K. Arc .....	156
Ultradyme .....	156
Vacuum Tube, Non-Regenerative .....	52
Vacuum Tube, Regenerative .....	52

**COHERER, (39)**

Autocoherer .....	19
Branley .....	24
Definition .....	39
Granular .....	75
Lodge Disc Detector .....	103
Marconi Filings .....	110
Slaby-Arco-Vacuum .....	141

**CONDENSER, (40)—See also Capacity**

Aerial Tuning .....	9, 138
Air .....	10
Balanced Rotary .....	21
Billi .....	23
By-Pass .....	40
Compressed Air .....	39
Curves .....	40
Definition .....	40
Electrolytic .....	60
Filter .....	68
Fixed .....	41
Grid .....	41, 76
In Parallel .....	41
In Series .....	41
Korda Air .....	99
Leyden Jar .....	101
Mica .....	41

	Page
Moscicki .....	114
Paper .....	122
Phone .....	41
Rotary .....	136
Shortening .....	138
Stopping .....	144
Telephone .....	149
Variable .....	41

**COILS (39)**

Antenna .....	39
Astatic .....	18
Basket .....	21
Choke .....	35
Cockaday .....	38
"D" .....	50
Damping .....	50
Definition .....	39
Duolateral .....	56
Exploring .....	65
Feed-Back .....	65
Fixed .....	68
Honey-Comb .....	82
Impedance .....	85
Inductance .....	87
Induction .....	88
Jigger .....	95
Loop Antenna .....	105
Lorenz .....	106
Low Loss .....	107
Movable .....	115
Pancake .....	122
Plug-In .....	125
Primary Induction .....	89
Radio Frequency .....	130
Reactance .....	131
Reaction .....	131
Retardation .....	135
Repeating .....	133
Spark .....	142
Spider Web .....	143
Tesla .....	151
Tickler .....	153
Tuning .....	155
Vario Coupler .....	44, 158
Variometer .....	158

**COUPLING, (44)**

Coefficient .....	44
Close .....	37
Conductive .....	41
Coupled Circuits .....	44
Degree of .....	45
Definition .....	44
Direct .....	54
Electrostatic .....	63
Feed Back .....	65
Inductive .....	90
Regenerative .....	133
Transformer .....	45, 153

	Page
<b>CRYSTALS</b>	
Bornite .....	24
Carborundum .....	31
Cat-Whisker for .....	32
Cerussite .....	34
Chalcopyrite .....	34
Definition .....	45
Detector .....	45
Galena .....	72
Iron Pyrites .....	94
Molybdenite .....	114
Nagyagite .....	115
Quartz Oscillator .....	129
Receiver .....	46
Rectifier .....	46
Silicon .....	138
Theory of Operation .....	46
Zincite .....	161

<b>CURRENT, (46)</b>	
Alternating .....	11, 47
Anode .....	16
Assumed Direction of Flow .....	18
Audio frequency .....	19
Carrying Capacity of Wire .....	47
C. G. S. Unit of .....	34
Constant .....	42
Consumption .....	42
Continuous Direct .....	42
Convection .....	42
Critical .....	45
Decay of .....	50
Definition .....	46
Density .....	47
Direct .....	47
Direction of Flow (Assumed) .....	47
Displacement .....	54
Eddy .....	58
Electron Theory .....	62
Emission .....	64
Flow of .....	70
Fluctuating .....	70
Foucault .....	70
Free Alternating .....	71
Full Load .....	72
Grid .....	76
Ground .....	77
Harmonic .....	78
High Frequency .....	48, 81
High Tension .....	48
Idle .....	85
Intermittent .....	93
Leading .....	100
Low Frequency .....	48, 107
Modulated .....	114
Nature of Electric .....	49
Oscillating .....	120
Oscillatory .....	120
Overtone .....	122
Primary .....	48
Production of Electric .....	48
Pulsating .....	127

Pulsating Direct .....	48
Radio Frequency .....	130
Reactive .....	131
Rectified .....	131
Rotary .....	136
Secondary .....	48, 137
Space .....	142
Stray .....	145
Theory of Alternating .....	11
Theory of Electric .....	49
Theory of Flow .....	151
Undamped Alternating .....	56

## D

<b>DETECTOR, (52)</b>	
Balanced .....	20
Barreter .....	21
Carborundum .....	31
Circuit .....	52
Coherer .....	39
Combination .....	39
Crystal .....	45
Crystal, Theory of Operation .....	46
Cymoscope .....	49
Damped Wave .....	52
Disc, Lodge .....	103
Electrolytic .....	60
Hozier-Brown .....	84
Liquid Barreter .....	102
Lodge Disc .....	103
Marconi Filing Coherer .....	110
Perikon .....	123
Silicon .....	138
Theory of Detector Action .....	151
Thermal .....	152
Ticker .....	153
Tikker .....	153
Tone Wheel .....	153
Vacuum Tube .....	52, 157, 158
Valve .....	158

<b>DIELECTRIC, (53)</b>	
Absorption .....	53
Coefficient and Constant .....	53
Frequency .....	54
Constants, Table of .....	54
Hysteresis .....	54
Strength .....	54

<b>DISCHARGE</b>	
Brush .....	27
Corona .....	43
Oscillatory .....	120
Oudin Resonator for .....	121
Spark .....	142

# E

	Page
<b>ELECTRIC</b>	
Absorption .....	59
Adhesion .....	6
Displacement .....	59
Elasticity .....	59
Field .....	59, 66
Induction .....	59
Electricity .....	59
Osmosis .....	121
Potential .....	126

## ELECTROLYTIC

Action .....	60
Battery Charger .....	60
Cell .....	60
Condenser .....	60
Conduction .....	60
Decomposition .....	51
Detector .....	60
Interrupter .....	61, 94
Rectifier .....	61
Rectifier, Full Wave .....	61

## ELECTROMAGNETIC

Attraction .....	62
Control .....	61
Field .....	61, 66
Flux .....	61
Impulse .....	61
Induction .....	61, 89
Inertia .....	90
Instruments .....	61
Microphone .....	61
Radiation .....	62
Repulsion .....	62
Switch .....	62
Theory of Light .....	62
Units .....	62
Waves .....	62, 160

## ELECTROMOTIVE FORCE, (62)

Active Pressure .....	6
Back .....	20
Breakdown Potential .....	25
C. E. M. F. ....	34
Counter .....	44
Current, Resistance Relationships (Ohms Law) .....	119
Definition .....	62
Induced .....	86
Kirchoff's Laws .....	95
Potential, Electric .....	126
Pressure, Electrical .....	127
Volt .....	159
Voltage .....	159
Voltage, Constant .....	159
Voltage Drop .....	159

## ELECTRON (62)

Flow .....	62
Emission .....	62
Relay .....	63
Theory .....	62
Tube .....	63

## ELECTROSTATIC, (63)

Capacity .....	63
Charge .....	63
Coupling .....	63
Field .....	63, 66
Flux .....	63, 70
Flux Density .....	63
Force .....	63
Induction .....	63, 89
Leakage .....	64
Line of Force .....	64
Strain .....	64
Systems .....	64
Units .....	64
Voltmeter .....	64
Wattmeter .....	64

# F

## FEED BACK, (65)

Armstrong's Circuits .....	17
Coil .....	65
Coupling .....	65
Definition .....	65
Effect .....	65
Regeneration .....	133
Regenerative Circuit .....	133
Reinartz Circuit .....	133
Tickler .....	153

## FIELD, (66)

Density .....	66
Electric .....	66
Electromagnetic .....	66
Electrostatic .....	66
Magnet .....	66
Magnetic .....	66
Regulator .....	66

## FILAMENT, (66)

Battery .....	67
Consumption .....	67
Current .....	67
Formula for Electron Flow .....	67
Rheostat .....	67
Resistance .....	67
Thoriated .....	67

## FLUX, (70)

Density .....	70
Distribution .....	70
Electrostatic .....	70
Leakage .....	70
Lines .....	70

	Page
Magnetic .....	70
Magnetism .....	70
<b>FREQUENCY, (71)</b>	
Alternator of .....	71
Audio .....	19, 71
Band .....	71
Carrier .....	71
Changer .....	71
Circuit, Audio .....	71
Circuit, Radio .....	71
Cycle .....	49
Definition .....	71
Fundamental .....	71
Group .....	71, 77
High .....	71
Low .....	71
Meter .....	71
Periodicity .....	123
Radio .....	72
Unit of .....	72
Variation of Power Factor with.....	72

## G

<b>GALVANOMETER, (73)</b>	
Constant .....	73
D'Arsonval .....	73
Mirror .....	73, 114
<b>GRID, (75)</b>	
Battery .....	75
Bias .....	76
Circuit .....	76
Condenser .....	41, 76
Control .....	76
Current .....	76
Leak .....	6, 76
Potential, Modulation of .....	76
Potentiometer .....	77
<b>GROUND, (77)</b>	
Clamp .....	77
Connection .....	77
Currents .....	77
Detector .....	77
Switch .....	77
Wire .....	77

## H

<b>HETERODYNE, (80)</b>	
Beats .....	22
Dissonance .....	55
Driver .....	56
Local Oscillations .....	102
Receiver .....	80
Self- .....	137

	Page
Super-Heterodyne Receiver .....	145
Wave Meter .....	81
<b>HIGH FREQUENCY, (71, 81)</b>	
Alternator .....	81
Amplification .....	81
Buzzer .....	81
Choke .....	35
Current .....	48, 81
Component of Plate .....	81
Oscillation .....	81
Resistance .....	81, 135

## I

<b>IMPEDANCE, (85)</b>	
Coil .....	85
Coupled Amplifier .....	86
Factor .....	86
Matched .....	86
Tuned .....	155
<b>INDUCTANCE, (86)</b>	
Antenna .....	86
Coils .....	87
Distributed .....	87
Loading .....	87
Measurement of .....	87
Mutual .....	87
Parallel .....	88
Reactance .....	87
Receiving .....	87
Self .....	87
Series .....	88
Tapped .....	87
Units of .....	88
Variable .....	88
<b>INDUCTANCE COIL</b>	
Basket Wound .....	21
Choke .....	35
Definition .....	87
Duolateral .....	56
Honey-Comb .....	82
Lorenz .....	106
Spider Web .....	143
Tuning .....	155
Vario Coupler .....	44, 158
Variometer .....	158

<b>INDUCTION, (88)</b>	
Bridge .....	88
Coil .....	88
Coil, Primary .....	89
Coil, Secondary .....	89
Density .....	89
Electromagnetic .....	89
Electrostatic .....	89
Instruments .....	89

	Page
Machine .....	89
Magnetic .....	89
Motor .....	89
Motor, Squirrel Cage .....	144
Mutual .....	89
Reactance .....	90
Regulator .....	90
Screen .....	90
Unit .....	90
Wattmeter .....	90

**INDUCTIVE**

Capacity .....	90
Circuit .....	90
Connection .....	90
Coupler .....	90
Coupling .....	90
Drop in Voltage .....	90
E. M. F. ....	90
Reactance .....	90
Rise .....	90
Resistance .....	90

**INSULATING MATERIALS, (91)**

Bakelite .....	20
Compound .....	91
Definition .....	91
Dielectric Constants .....	5
Ebonite .....	57, 159
Eburin .....	57
Electrose .....	63
Impregnated .....	86
List of .....	149
Mica, .....	113
Micabond Cloth .....	113
Micabond Paper .....	113
Micabond Plate .....	113
Micanite .....	113
Property .....	91
Table of Dielectric Strength .....	149
Vulcanite .....	159
Vulcanized Rubber .....	159

**K**

**KEY, (96)**

Anti-Capacity .....	96
Definition .....	96
High-Speed .....	96
Magnetic .....	109
Modulated Continuous Waves .....	42
Switch .....	97
Transmitting .....	154

**M**

**MAGNET, (108)**

Artificial .....	18
------------------	----

	Page
Compound .....	40
Definition .....	108
Electro- .....	61
Horseshoe .....	83
Natural .....	116
Negative Pole .....	116
North Pole .....	118
Permanent .....	123
South Pole .....	142
Temporary .....	151
Wire .....	108

**MAGNETIC**

Attraction and Repulsion .....	108
Blowout .....	108
Circuit .....	108
Field .....	66, 108
Flow .....	109
Flux .....	70, 109
Flux Density .....	109
Force .....	109
Force Due to Current .....	109
Hysteresis .....	109
Induction .....	109
Inductive Capacity .....	109
Interrupter .....	109
Key .....	109
Leakage .....	109
Needle .....	109
Poles .....	109
Properties .....	109
Storm .....	109

**O**

**OSCILLATIONS**

Back .....	20
Constant .....	120
Damped .....	49
Definition .....	120
Forced .....	70
Free .....	71
Frequency .....	120
High Frequency .....	81
Impact Excitation .....	85
Local .....	102
Logarithmic Decrement .....	105
Master Oscillator System .....	111
Oscillation .....	121
Oscillogram .....	121
Oscillograph .....	121
Point .....	120
Poulsen Arc .....	126
Resonator .....	135
Tesla Coil .....	151
Transformer .....	45, 120
Undamped .....	156
Valve .....	120

	Page
<b>OSCILLATOR, (120)</b>	
Hertzian .....	120
Linear .....	120
Magnetic Blowout for .....	108
Master .....	111
Negatron .....	117
Righi .....	120
Quartz .....	129
Thermionic .....	120

## P

	Page
<b>PLATE, (125)</b>	
Battery .....	125
Circuit .....	125
Component, High Frequency .....	125
Consumption .....	42, 125
Control .....	125
Current .....	125
Impedance .....	125
Voltage .....	125

## R

<b>RADIATION, (130)</b>	
Definition .....	130
Efficiency .....	130
Electromagnetic .....	62
From Antenna .....	130
Gliding Through .....	74
Heaviside Layer .....	79
Resistance .....	130, 135
Theory of Propagation of Electromagnetic Waves .....	152
Theory of Reception of Electromagnetic Waves .....	152

<b>RADIO, (130)</b>	
Activity .....	130
Channel .....	130
Communication .....	130
Compass .....	130
Control .....	130
Frequency .....	72
Telegraphy .....	130, 161
Telephony .....	130
Transmission .....	130

<b>RADIO FREQUENCY, (72)</b>	
Ammeter .....	14
Amplifier .....	15
Circuit .....	71
Coils .....	130
Current .....	130
Resistance .....	135
Selectivity .....	130

Signals .....	130
---------------	-----

<b>REACTANCE, (131)</b>	
Capacitive .....	30
Coil .....	131
Inductance .....	87

<b>RECTIFIER, (131)</b>	
Electrolytic .....	61
Full Wave .....	131
Half Wave .....	78
Potential .....	126

<b>RESISTANCE, (134)</b>	
Antenna .....	16
Box .....	134
Contact .....	42
Coupled Amplifier .....	134
Coupling .....	134
Definition .....	134
Field Regulator .....	66
Graphite .....	75
High Frequency .....	81, 135
Litzendraht .....	102
Of Ground Connection .....	135
Ohm .....	118
Ohmic Drop .....	119
Ohmic Loss .....	119
Ohm's Law .....	119
Radiation .....	135
Radio Frequency .....	135
Variable .....	158

<b>RESONANCE, (135)</b>	
Curve .....	135
Intensifies .....	135
Parallel .....	123
Series .....	137
Transformer .....	135

## S

	Page
<b>SWITCH, (147)</b>	
Aerial .....	9
Board .....	147
Capacity .....	31
Dead End .....	50
Double Throw .....	56
Electromagnetic .....	62
Gear .....	148
Ground .....	77
Jack .....	95
Key .....	96
Key, Anti-Capacity .....	96
Knife .....	98
Lightning .....	101
Plug .....	125
Points .....	42
Quick Break .....	129



# T

	Page
<b>THEORY OF CURRENT FLOW. (151)</b>	
Detector Action (of Vacuum Tube).....	151
Electric Current .....	49
Magnetism .....	14
Operation of Crystal Detector.....	46
Operation of Vacuum Tubes .....	151
Primary Cell .....	34
Production of Alternating Current.....	12
Propagation of Electromagnetic Waves.....	152
Reception of Electromagnetic Waves.....	152
Vacuum Tube Amplifier .....	157
<b>TRANSFORMER. (153)</b>	
Air Core .....	10
Auto .....	20
Closed Core .....	37
Coupling .....	45, 153
Hedgehog .....	79
Intermediate .....	93
Open Core .....	120
Oscillation .....	45, 120
Output .....	122
Plug-In .....	125
Resonance .....	135
Shielded .....	138
Steel .....	153
Tuned Radio Frequency .....	155
<b>TRANSMISSION</b>	
Aerial, Cage .....	8
Automatic .....	19
Broadcasting, General Treatise on Methods.	25
Carrier Wave .....	31
Chopper .....	31
Fading .....	65
Fan Aerial .....	65
Feed-Voltage Modulation .....	65
Ferro-Magnetic Modulator .....	66
Flame Microphone .....	68
Frequency Carrier .....	71
Heising Modulation .....	74
Key .....	96, 154
Key, High Speed .....	96
Jamming .....	95
Jigger .....	95, 154
Microphone .....	113
Modulation .....	114
Of Photographs by Radio .....	154
Phenomena of Electric Wave Propagation..	124
Quartz Oscillator .....	129
Queenland Gap Transmitter .....	129
Radio .....	131
Radio Telephony .....	131
Radio Telegraphy .....	130
Remote Control .....	133
Spark Coil .....	142
Spark Rate .....	142
Speech Modulation .....	143

	Page
Synchronous Discharger .....	148
Telefunken System .....	149
Television .....	150
Tesla Coil .....	151
Theory of Propagation of Electromagnetic Waves .....	152
T. Y. K. Arc .....	156
<b>TUNING, (155), See also Coil: Condenser</b>	
Broad .....	155
Coil .....	155
Condenser, Aerial .....	9
Inductance Coils .....	87
Inductance, Variable .....	88
Interference Eliminator .....	93
Interference Preventers .....	93
Rejector Circuit .....	133
Selectivity .....	137
Sharp .....	137
Static Eliminators .....	144
Syntony .....	148
Wave Trap .....	160

# U

<b>UNITS, (156)</b>	
Ampere .....	14
Ampere-Hour .....	14
Ampere, International .....	14
Ampere Turns .....	14
Ampere Volt .....	14
B.A. Ampere .....	20
Beg Ohm .....	23
B. O. T. .....	24
B. T. U. .....	27
Capacity .....	31
Centimeter .....	34
Centimeter, Gram, Second .....	34
C. G. S. Unit of Current .....	34
Circular Mil .....	36
Coulomb .....	44
Current .....	34
Definition .....	156
Dyne .....	57
Electromotive Force .....	62
Electrostatic .....	64
E.M.F. .....	64
Erg .....	64
E.S.U. .....	64
Farad .....	65
Frequency .....	72
Gauss .....	73
Gilbert .....	74
Henry .....	80
Horse Power .....	83
Horse Power Electrical .....	83
Inductance .....	88
Induction .....	90
Jar .....	95

	Page
Joule .....	95
Kilo .....	97
Kiloampere-Turn .....	97
Kilocycle .....	97
Kilocycles to Meters .....	97
Kiloline .....	98
Kilovolt .....	98
Kilowatt-Hour .....	98
Magnetomotive Force .....	110
Maxwell .....	111
Maxwell Turns .....	111
Meg .....	112
Mega .....	112
Meter .....	113
Metric System .....	113
Mfd. ....	113
Micro .....	113
Microfarad .....	113
Microhm .....	113
Mil .....	114
Mil-Foot .....	114
Milli .....	114
Milli-Ampere .....	114
Milli-Micro .....	114
Milli-Volt .....	114
M.M.F. ....	114
Oersted .....	118
Ohm .....	118
Poundal .....	127
Practical .....	127
Volt .....	159
Volt-Amperes .....	159
Watt .....	159
Watt Hour .....	159
Watt, International .....	159
Watt Second .....	159
Weber .....	160

## V

### VACUUM TUBE, (157)

Adapter .....	6
Aging .....	10
Amplifier, Action of .....	15
Amplifier, Theory of .....	157
Audion .....	19
Characteristics .....	157
Definition .....	157
Diode .....	54
Double Grid .....	55
Dull Emitter .....	56
Dynatron .....	57
Electron Relay .....	63
Electron Tube .....	63
Filament Consumption of .....	67
Filament Current .....	67
Filament, Formula for Electron Flow.....	67
Filament, Thoriated .....	67

	Page
Fleming Valve .....	69
Four Element Tube .....	70
Gaseous Tube .....	73
Gaseous Rectifier .....	73
Generator .....	157
Grid .....	75
Input Circuit of .....	91
Kenotron .....	96
Neon Lamp .....	117
Neon Tube .....	117
Oscillation .....	120
Output Circuit of .....	122
Plate .....	125
Pliodynatron .....	125
Pliotron .....	125
Power .....	157
Rectifier .....	157
Rectifying .....	132
Theory of Detector Action .....	151
Theory of Operation of .....	151
Thermionic Oscillator .....	120
Three-Electrode .....	152
Three Electrode Thermionic Tube.....	152
Transmitting Tube Power Rating.....	154
Triode .....	155
Tube Rectifier .....	155, 157
Tungar .....	155
Types of .....	158
Ultra-Audion .....	156
Valve .....	158

## W

### WAVE

	Page
Amplitude .....	15
Analysis .....	159
Antenna .....	159
Antinode .....	16
Calculations for Antenna .....	160
Carrier .....	31
Continuous .....	42
Continuous, Key Modulated .....	42
Cymoscope, to detect .....	49
Damped .....	49
Damping .....	50
Decadent .....	50
Definition .....	159
Distortion of .....	55, 159
Electromagnetic .....	62, 160
Form .....	159
Frequency .....	71
Fundamental .....	72
Gliding Theory .....	74
Heaviside Layer .....	79
Length .....	159
Length Allocations .....	159

CLASSIFIED INDEX TO S. GERNSBACK'S RADIO ENCYCLOPEDIA

	Page
Length of Stationary S.H.M. ....	160
Length, Natural .....	160
Meter .....	160
Meter, Calibration .....	160
Motion .....	160
Natural Length .....	116, 160
Nodes .....	118
Radiation from Antenna .....	130
Refraction .....	133
Sine .....	139
Sound .....	142
Sustained .....	146
Theory of Propagation of Electromagnetic. ....	152
Theory of Reception of Electromagnetic... ..	152

	Page
Train .....	160
Trap .....	160
Undamped .....	156
Wound .....	160

**WIRE**

Aerial .....	10
Enameled .....	64
Flexible .....	70
Gauge .....	161
Hard Drawn .....	78
Insulated .....	91
Magnet .....	108



## OTHER VINTAGE RADIO BOOKS

Vintage Radio, by Morgan E. McMahon. A pictorial history of wireless and radio, 1887-1929. Collector's and historian's reference, based on Harold Greenwood's original work. Good browsing. Hard-cover and handbook editions. 263 pages.

Radio Collector's Guide, by Morgan E. McMahon and Harold F. Langley. A listing of over 50,000 facts on 4,000 radio receiver models built by 1,100 manufacturers, 1921-1932. Handbook edition. 264 pages.

From Static to Snow, by Morgan E. McMahon. A pictorial history of radio and early television, 1930-1950. Good browsing. Collector's and historian's reference. Hard-cover and handbook editions. Release date May, 1974.

We are always looking for new material and ideas for future books. We will be releasing new books from time to time. If you have suggestions or want further information, please write to Vintage Radio, Box 2045, Palos Verdes Peninsula, California 90274.



## OTHER INFORMATION SOURCES

Vintage Radio books are the standard references on early wireless and radio equipment. However, there are some excellent narrative books available from other publishers. Erik Barnouw's series "A Tower in Babel", "The Golden Web" and "The Image Empire" (Oxford University Press, N.Y.) is a very interesting factual history of broadcasting. Ron Lackman's "Remember Radio" (G.P. Putnam's Sons, N.Y.) and Jim Harmon's "The Great Radio Comedians" and "The Great Radio Heroes" (Doubleday and Co., Garden City, N. Y.) are entertaining and informative memory trips. Jane Morgan's "Electronics in the West" (National Press Books, Palo Alto, Calif.) is a very readable history of some of the people who are now "folk heroes" of radio and electronics.

Old magazines, books and manuals are good sources of fun and information. Some people are publishing reprints of manuals.

Interesting ads can be found under "radio" in antique and collectibles periodicals. You will find advertisements for old books, magazines, radios, parts, tapes of old programs, restoration services, information services, old-time radio premiums and other interesting memorabilia.

If you are seriously interested in radio history and collecting, write to the Antique Wireless Association, Holcomb, N.Y. 14469; The Antique Radio Club of America, 516 Country Lane, Louisville, Ky. 40207; or the Canadian Vintage Wireless Association, P.O. Box 51, Station R, Toronto, Ontario, M4G 2E6.



