

The  
STORY  
of  
STEREO:  
1881-  
John Sunier



\$5.00  
(in the U.S.)

*The  
Story  
of  
Stereo:  
1881—*

---

JOHN SUNIER

GERNSBACK LIBRARY, INC.—NEW YORK 11, N.Y.



© 1960 Gernsback Library, Inc.  
*All rights reserved under Universal  
International, and Pan-American  
Copyright Conventions.*

*Library of Congress Catalog Card No. 60-53320*

# contents

chapter

1

## **Stereophonic sound**

page

7

Hearing with two ears. Theories of stereophonic hearing. Time-difference theory. Intensity and phase theory of stereophonic hearing. Binaural beats. Binaural interaction or fusion. "Cocktail party" effect. Sound "shadow." Directional accuracy of the ears. Echolocation. Slapback. Limitations of monophonic sound. Listening fatigue. System definitions. Ideal and practical stereophony. Advantages of stereophonic reproduction.

2

## **Early developments**

27

Ader's experiment. Binaural receiving trumpets. The geophone. Stereo broadcasting in the 1920's. Plastic tone reproduction. Early description of multiplexing. The early 1930's — Blumlein and Fletcher. Two-channel stereophonic system. The 1933 Bell experiment. Auditory perspective. Problems of acoustics. Developments following the Bell experiment. Post-war developments. The Cook stereo disc. First commercial stereo tape.

3

## **Stereophonic sound on film**

51

Stereo sight and sound. The Bell Stereo Sound Film System. The compandor. Fantasound. Stereophonic recording arrangements. Vitasound system. Other new film-sound processes. Recording set-up for CinemaScope films. Magnetic oxide on film. Cinerama and CinemaScope sound. Pan-potting. Compatibility. Perspecta sound system. An optical-track system. Recording sound on film. Stereo sound and the exhibitor's problem. Other stereo mediums.

4

## **Stereophonic sound on tape**

73

Simplicity of tape for multichannel work. Early stereo on tape. Stacked and staggered stereo pickup heads. Advantages of two-channel tape recording. Coded stereophonic tape system. Stereo tapes in the home. Three-channel head. Universal adapter. Advantages and disadvantages of tape. Duplication of tapes. Advantage of discs. Making and reproducing a stereo disc. The tape cartridge. The high frequencies. The tape enthusiasts' problem.

**Stereophonic sound on discs**

page

91

Dynamic range of discs and tape. Experimental stereo disc systems. Cook stereo discs. The EMI two-styli system. The VL (vertical and lateral) single-groove system. MSD (Minter Stereo Disc). CBS (Columbia) system of stereo disc recording. The Westrex 45/45 system. The stereophonic cartridge. Tracking weight. Crosstalk. First 45/45 discs. Stereo problems. Suggested cures. Stereo disc popularity. Stereo 45-rpm discs.

**Stereophonic broadcasting**

113

Types of stereo broadcasting. AM-AM. AM-FM. Disadvantage of AM-FM. FM-FM. TV-AM or TV-FM. Three-channel TV and FM radio. Multiplexing. Musicasting. Simplex. Compatibility. The subcarrier. Multiplex adapter Systems of compatible stereo. FM multiplex. Sum and difference signals. Stereosonic. Crosby system. Halstead system. The Burden method. Phantodyne. Calbest. EMI-Percival. Matting system. AM stereocasting. Other systems.

**Stereo techniques**

147

Microphone placement. Pseudo-stereo. American and European (Stereosonic) methods. Middle-side stereophony. Pseudo-stereo. Kluth system. Sound enhancement. Disadvantages of pseudo-stereo. Single-channel stereo. The 3D converter. Phase-differential enhancing devices. The Xophonic method. The Weathers technique. The Stereophoner. Stereo in business and industry. The Audio-Analgesiac. Stereo control of pain.

**Index**

157

# introduction

THIS book is designed to aid in an understanding of the principles behind stereophony and what the medium has accomplished. It is the writer's hope that in doing so the great value of stereophony in communications will be demonstrated.

The need for further research on the subject is great. A full-scale investigation of stereophonic reproduction and its relation to the communications industry would not be useful if numerous writers had not agreed on the distinctiveness of the medium. Engineers of a top consumer testing organization have called stereophonic sound a major step forward — greater than that made when the long-play record was first introduced. Not every electronic “improvement” has obtained ready consumer acceptance but stereo has because it is different. Engineers have even gone so far as to add: “Stereo is not a development that applies only to hi-fi. It is an entirely new approach to sound reproduction.”

Certain musicians also have realized the value of a technically “complete” method of communication. Leopold Stokowski, for example, discussed stereophonic sound in a 1935 article, using an early name for stereophony, auditory perspective. “Adequate transmission of music must meet three requirements: it must faithfully transmit (1) the complete frequency range; (2) the complete intensity range and (3) with the true auditory perspective. . . . To convey music with full and true auditory perspective, we should have, in my opinion, double circuits which could be made to correspond to our method of hearing with two ears.”

The first two chapters of this study provide the necessary background for a complete understanding of contemporary studies on stereo. The physiological basis of hearing with two ears is delineated in Chapter 1, while Chapter 2 documents the early history of stereo experimentation.

The arrangement of the following chapters is based on two factors. One possible division would have been by the type of

program material carried in stereo. This, however, would involve elements of information theory and complicated technical matters. Therefore, the division chosen was by the medium which carries the stereophonic information — namely, film, tape, disc and broadcasting.

The second factor in these divisions was the order in which the four media presented stereophonic sound to large numbers of the population. Film, while not the first medium of stereophony, was the first to bring it before many people in the theaters of the country. Magnetic tape next made possible the sale of commercially recorded stereo tapes that could be bought by financially able music-lovers. The stereo disc, however, launched the real stereo revolution. Finally, broadcasting in stereo, while it had been done as far back as 1924, has been mainly experimental. For the few stations doing it regularly, it is at best a makeshift operation. The real advent of stereocasting will come only when a standard system of multiplexing is chosen so that stereophonic material can be broadcast by a single radio station without tying up a second station for the second channel. Therefore, this technique is listed last in the arrangement of chapters by media. The seventh chapter deals with miscellaneous stereo techniques.

JOHN SUNIER

# stereophonic sound

THE quest for stereophonic sound came about because human beings hear with two ears, while conventional electronic communication is “one-eared.” The quality of hearing in one ear may

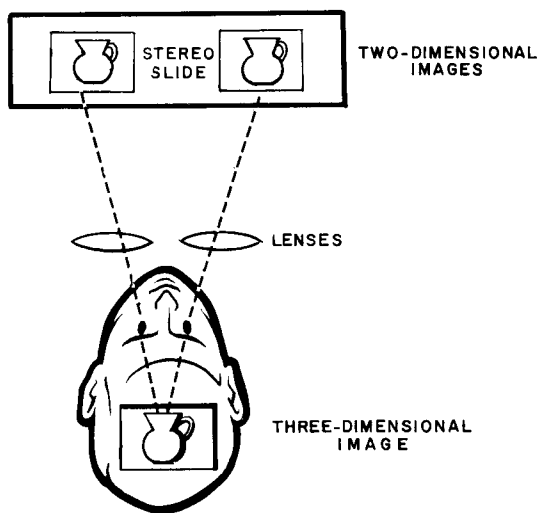

Fig. 101. A popular explanation of the stereophonic effect compares sight with two eyes to hearing with two ears. Here we see two-dimensional slides, taken with two spaced camera lenses, combined into a three-dimensional image in the brain of the viewer.

differ from the other ear, but this does not greatly affect the stereophonic effect unless the difference is very large.<sup>1</sup>



## Hearing with two ears

The common analogy of two-eared hearing is stereo photography (Fig. 101). This explanation abounds in popular publications endeavoring to "simplify" stereophonic theory, and is also found in dealers' sales pitches. It draws attention to the great

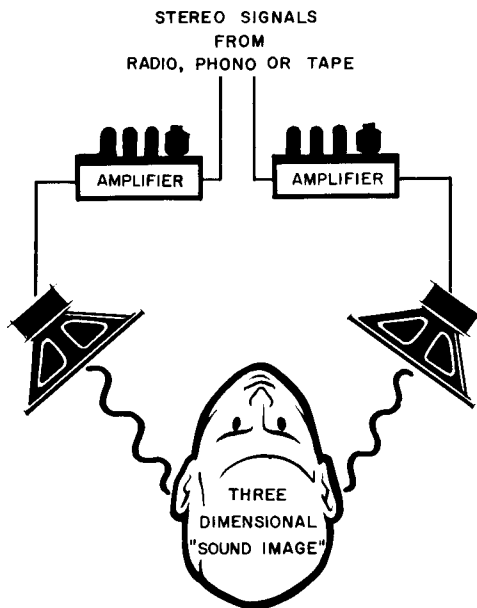

Fig. 102. In the hearing counterpart of stereo sight, the two sound channels, recorded by two spaced microphones, are reproduced through separate amplifiers and speakers and combined into a three-dimensional sound image in the brain of the listener.

difference between ordinary photographs, either black and white or in color, and stereoscopic slides. It explains that ordinary photographs are two-dimensional, or flat, whereas the stereoscopic slides have "depth" or a third dimension. The difference between two-dimensional or ordinary sound and three-dimensional or stereophonic sound (Fig. 102) is supposed to be just as dramatic.<sup>2</sup>

Granted, there is a startling difference between three-dimensional and two-dimensional photography, but the analogy is a poor one when applied to stereophonic theory, for several reasons. There is no true parallel for the difference between ordinary and stereophonic sound. Norman Crowhurst puts it lucidly:

In the realm of sound there is no such thing as a direct counterpart for the two-dimensional or flat picture. It is quite impossible to have a two-dimensional sound. I am not saying there is no difference between stereophonic and non-stereophonic sound. There is. But the difference is not to be easily explained as by drawing an illustration with 2-D and 3-D pictures.

The qualities about sound and listening that give us an impression of depth are quite different from the qualities about light and vision that give us a similar impression of the things we see.<sup>3</sup>

It is true that sight with both eyes, by dint of their small amount of separation and the later fusion of their separate images into a

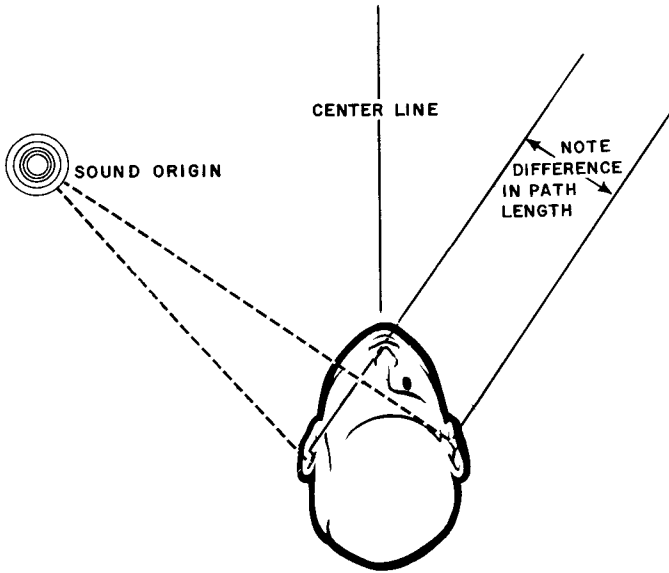

Fig. 103. Origin of path-length differences due to sound source off median line.

single one in the brain, enables a person to judge depth more accurately. However, viewing a subject with only one eye does not appreciably change the visual effect. It may be more difficult to judge distances and speeds, but for the greater part the differences are more subtle than in hearing.<sup>4</sup>

But a marked difference is heard when sounds are received by only one ear. *They sound different.* Several very important clues which enable the ears as a pair to estimate distance and direction and to separate reverberation from original sound, have been destroyed.<sup>5</sup>

## Theories of stereophonic hearing

One of the hearing cues has been called the “time-difference” theory, and was first suggested by Hornbostel and Wertheimer.<sup>6</sup> Sound waves travel through the air, and as such contain periodic peaks and valleys in the same way as any cyclical variation. Now, since the two human ears are several inches apart, a given sound will travel over two slightly different paths in reaching them. If

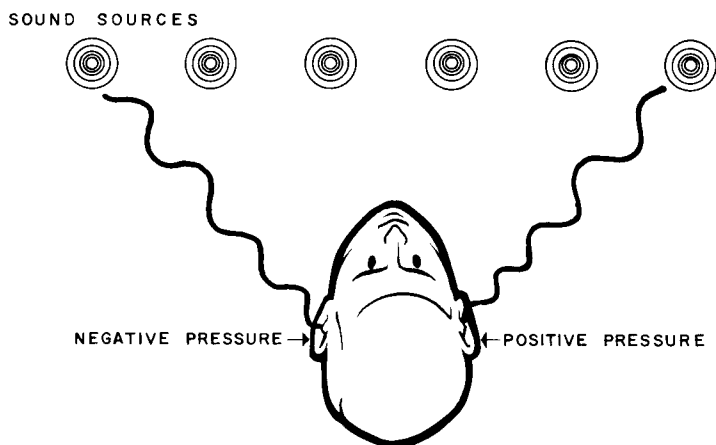

Fig. 104. *The intensity and phase theory of stereophonic hearing. "Beats" are caused by the alternative addition and subtraction of differing sound pressures at the two ears.*

the lengths of these two paths are not equal, there is a time difference in the arrival of the sounds at each ear. This occurs whenever the sound source is neither directly behind nor in front of the listener, that is, neither at  $0^\circ$  nor  $180^\circ$ . Thus the time differential is nearly always present.<sup>7</sup> (See Fig. 103.)

### Intensity and phase

One of the other theories (Fig. 104) is that of intensity and phase.<sup>8</sup> While one ear is receiving a positive pressure peak in the sound wave, the other ear may simultaneously hear a negative peak. Very seldom are both sound pressures at exactly the same point in the cycle as they strike the two eardrums. Since this relationship of phase is constantly changing, in the case of pure tones used in research, there will be an alternate addition and subtraction that will cause audible “beats.”<sup>9</sup>

These “binaural beats” were studied at length by S. P. Thomson in 1877.<sup>10</sup> A sound led into one ear by a telephone earpiece was capable of giving beats with another sound of slightly differ-

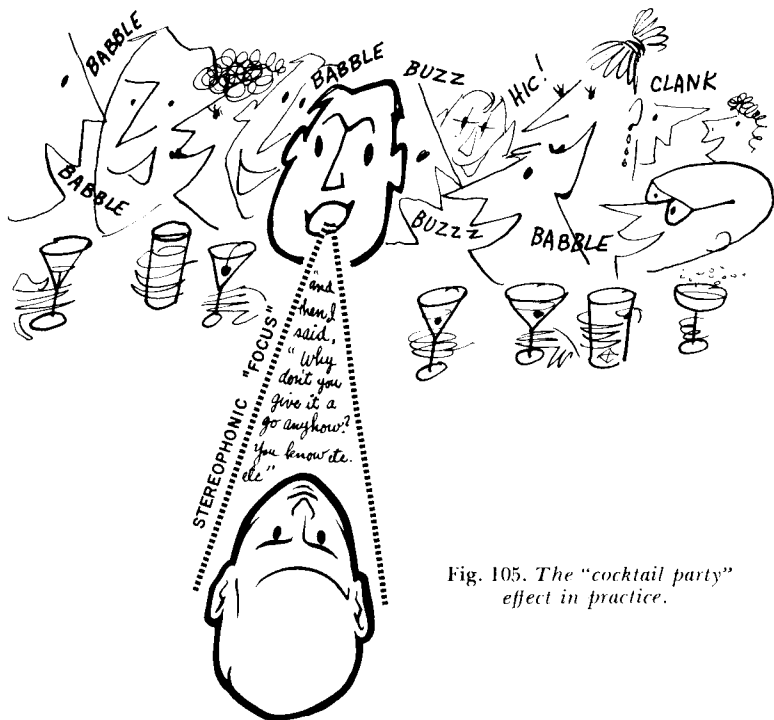

Fig. 105. The "cocktail party" effect in practice.

ent frequency led into the other ear. In 1925, C. E. Lane came to the conclusion, after gathering experimental evidence, that the beats were not due to cross-conduction through the head, but were of central origin and resulted from the sense of binaural localization of sound by phase.<sup>11</sup>

### Binaural interaction

What appears to the writer to be exactly the same phenomenon has recently been dubbed both "binaural interaction" and "binaural fusion." W. H. Huggins reported that his work in 1953 showed a binaural stimulus to give a fairly clear perception of pitch although the separate stimuli applied to the two ears gave no such perception.<sup>12</sup> The basic stimulus consisted of white noise<sup>13</sup> introduced into one ear while the same white noise, phase-transformed into a narrow band of frequencies, was introduced into the other ear. He continues:

It has been clearly demonstrated that under certain conditions noise may be introduced separately to the two ears, and a pitch-like quality will be perceived which is entirely due to binaural interaction between the phases of the noise stimuli . . . binaural phase interaction must be taken into account in order to give a satisfactory explanation of existing data.<sup>14</sup>

Again, the mechanism of "binaural fusion" is discussed by B. M. Sayers and E. C. Cherry in the same journal. They deem it a statistical operation based on the brain's execution of running a cross-correlation of the two ear signals. It must be understood, according to the researchers, before any consideration of our binaural directivity sense and our speech discrimination sense is attempted.<sup>15</sup>

### "Cocktail party effect"

Speech discrimination brings to light another phenomenon (Fig. 105) whimsically entitled "the cocktail party effect." Irwin Pollack and J. M. Pickett, again writing in the *Journal*, say that it has long been felt that directional information of a talker may improve the intelligibility of his speech when heard against the voice babble of other talkers. They decided to explore this effect scientifically. The reception of words of one syllable, presented against a background babble of one, two four, or seven talkers, was compared under two listening conditions: (1) In the stereophonic listening condition, one set of background talkers was presented to one earphone, another set of background talkers was presented to the other earphone, and the test words were presented to both earphones, binaurally, in phase. (2) In the control listening condition, only a single set of background talkers, and the test words, were presented to a single ear. The stereophonic advantage (really the binaural advantage, by strictest definition), for 50% word intelligibility, ranged from 12 db with one background voice per channel to 5.5 db with seven background voices per channel. To quote:

"In summary, large gains in word intelligibility above a background of speech babble may be obtained with stereophonic listening as compared with nonstereophonic listening."<sup>16</sup>

This area, or lobe of maximum sensitivity, can be "pointed" by the two ears in any desired direction without turning the head. In the direction chosen, the sensitivity is some 10 to 15 db higher than it is over the rest of the azimuth. (See Fig. 106.) Here an analogy with sight might be more appropriate than the one mentioned earlier. We can *see* objects through an area of 160° in azimuth, although we *focus* on objects in only a few degrees at one time. The steerable directivity characteristic of hearing would be impossible if we possessed but one ear.<sup>17</sup>

James Moir goes into greater detail in explaining the mechanism of the stereophonic advantage. He finds the time difference to be an average of 0.63 millisecond between the ears, when the

sound source is on either side of the head.<sup>18</sup> Naturally, when the source is equidistant from both ears, the time differential is zero. According to Galambos, the reference point used by the brain is the first positive maximum in the waveform of the sound.<sup>19</sup>

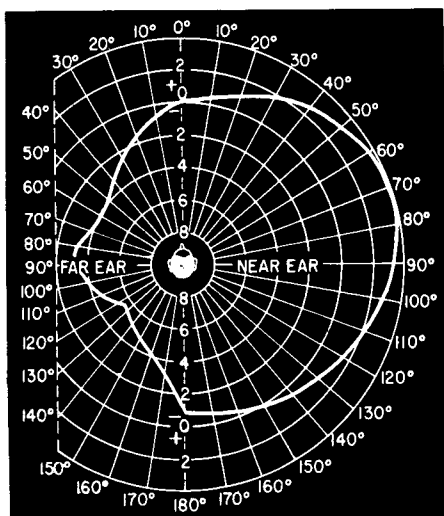

Fig. 106. *The directivity characteristics of the ear clearly show the importance of bin-aural hearing.*

### Sound shadow

The intensity difference is further elaborated by Moir. The insertion of an obstacle into a progressive sound wave will produce, according to research, a sound “shadow” analogous in all respects with the shadow thrown in a light beam. The sound wave is disturbed and bends round the obstacle; this effect of diffraction is common to all forms of wave motion. The sound pressure or intensity in the near ear can exceed that in the far ear by as much as 16 db at 5,000 cycles per second or even up to 30 db at 10,000 cycles. Differences in energy spectrum are also claimed to provide an important secondary clue in detecting direction of sounds. This is shown by the fact that the frequency characteristic contains more high-frequency components at the near ear.<sup>20</sup>

### Directional accuracy of the ears

The frequency range being heard influences the amount of directional accuracy of the ears. Klumpp and Eady<sup>21</sup> and Zwillocki and Feldman,<sup>22</sup> indicate that the ear’s angular accuracy due to the time difference alone is roughly constant at about 1.5°

below 1 kilocycle per second. Moir<sup>23</sup> finds the just noticeable angular difference to be about  $1.2^\circ$  if the entire frequency range is used. If the speech frequencies are limited to the band below 500 cycles per second, it rises to  $4^\circ$ . The inclusion of frequencies below 3,000 cycles per second tends to confuse the brain, for the highest angular accuracy is obtained when reproducing sounds in the 3,000- to 7,000-cycle category only. However, this deduction from the results shows the need, according to Moir, for further experimental confirmation before being completely accepted.<sup>24</sup>

## Echolocation

Research into binaural hearing has not been entirely a recent development. Very early work on this function of hearing was done by Rayleigh.<sup>25</sup> Geiger and Scheele began the erroneous analogy to 3-D photography by comparing binaural audition to stereoscopic vision.<sup>26</sup> Bats have been a fruitful source of information about binaural hearing. Recent observations of the Plecotus bat, which uses binaural cues to aid in locating the reflections of its high-frequency sounds, have proved useful. The process used by the bat (Fig. 107) has been called "echolocation."<sup>27</sup>

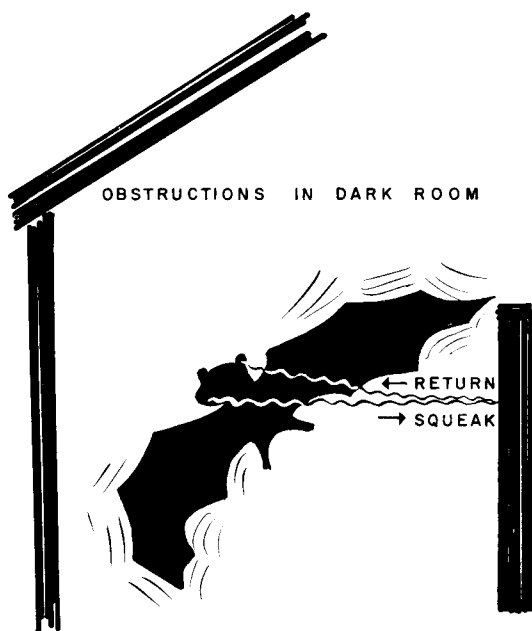

Fig. 107. *The Plecotus bat employs ultrasonic squeaks to find its way in the dark by the process of "echolocation."*

## Reverberation

There is yet another sort of selection that binaural hearing makes possible. This is the separation of the primary sound source from the secondary sound source, or reverberation.

As an example, let us consider a concert in a large hall. The performing group measures about 80 feet in width and 40 feet in depth. From it emanates the primary sound. However, to this primary source we must add the reflected sound which we hear from the ceiling, back and sides of the hall, the nature of which is governed by the hall's acoustical characteristics. The most important aspect of this secondary sound source (Fig. 108) is the element of *time delay* involved in its perception. In character, this secondary sound may be simply decay of the primary sound or it may be an actual echo — what audio engineers refer to as “slapback.” When a musical group performs outdoors, especially without the benefit of a reflecting bandshell, this secondary sound source will be virtually nonexistent, which is the reason so many outdoor concerts seem lacking in brilliance and excitement compared to what is heard in a fine concert hall.<sup>28</sup>

## Limitations of monophonic sound

When binaural hearing, or binaural recording, is not possible, reverberation presents many problems. The single recording microphone in a monophonic recording arrangement cannot differentiate between the primary and the secondary sound

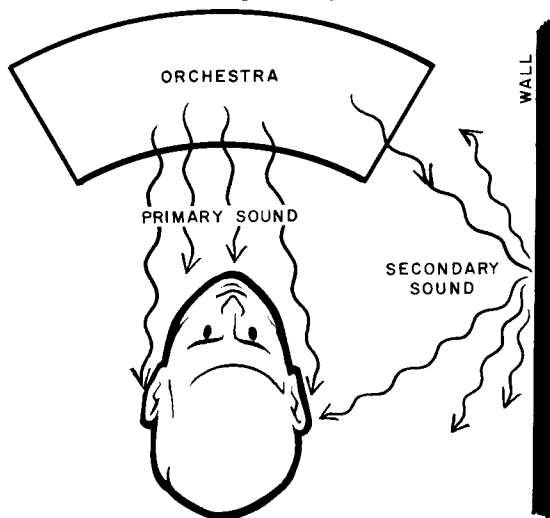

Fig. 108. *The difference between primary sound and secondary sound.*



sources. As a result the microphone must receive all the sounds, original and reverberant, and reproduce them through one loudspeaker. When the recording area is too "live," it causes an annoying amount of reverberation in the resultant recording. It sounds as if someone has not only removed all the furniture in the room or hall, but had also made the space considerably larger, so as to get more echo.<sup>29</sup> With stereophonic recording, this emphasis of reverberant sound does not occur. In fact, some subjects actually require a longer reverberation rate than would seem natural to the ear.<sup>30</sup>

The human hearing system simply cannot receive the necessary psychoacoustic cues and stimuli for natural listening from monophonic or single-channel sound. The naturalness of stereo, which provides these cues, causes a listener, under perfect conditions, to forget eventually that he is listening to recorded sound at all.<sup>31</sup> The problem of "listening fatigue" is overcome. This phenomenon is defined by Newitt as "a recognized psychoacoustic effect which eventually makes the listener either subconsciously dislike (and ignore) the music being played or (in more severe cases) compels him to shut off the source".<sup>32</sup> Stereophonic reproduction keeps the hearing system active continuously and reduces the fatigue effect.<sup>33</sup>

### **System definitions**

Now that we understand something of the stereophonic advantage in human hearing, perhaps it would be helpful to define clearly the various types of systems used in the reproduction of sound, for the writer will be using them often in the following discussions.

Harry F. Olson, an audio pioneer, has defined the systems in use today. He prefaces his definitions with a description of the reproduction of sound. He says this is the process of picking up sound at one point and reproducing it either at the same point or at some other point, either at the same time or at some subsequent time. He defines the four systems in use today (Fig. 109) which he says are continually confused with one another, even by noted engineers.<sup>34</sup>

**MONAURAL:** A monaural sound reproducing system is a closed-circuit type of sound reproducing system in which one or more microphones are connected to a single transducing channel which in turn is coupled to one or two telephone receivers worn by the listener. (See Fig. 109-a.)

**BINAURAL:** A binaural sound reproducing system is a closed-

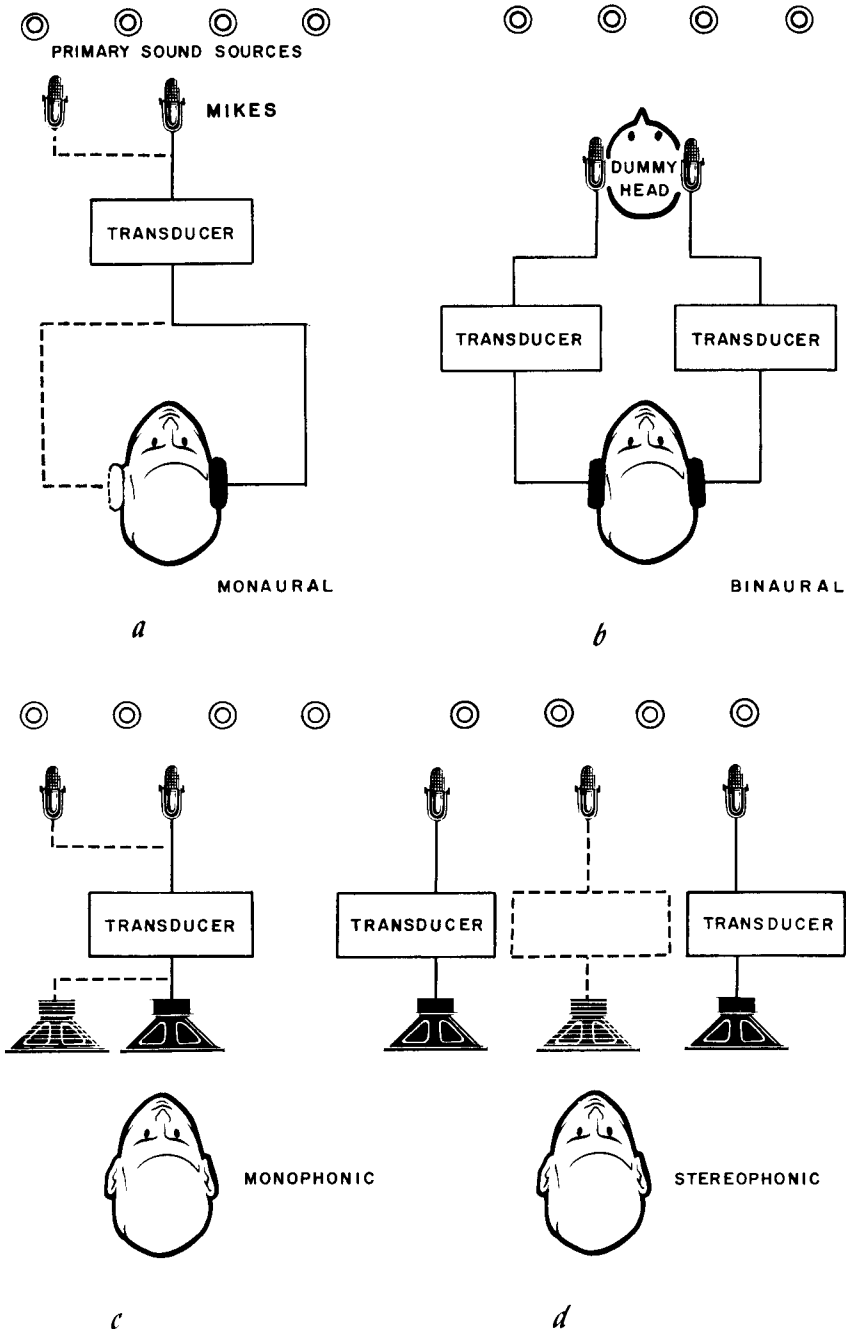

Fig. 109. Sound reproduction systems: (a) monaural, (b) binaural, (c) monophonic and (d) stereophonic.

circuit type of sound reproducing system in which two microphones, used to pick up the original sound, are each connected to two independent corresponding transducing channels which in turn are coupled to two independent corresponding telephone receivers worn by the listener. (See Fig. 109-b.)

**MONOPHONIC:** A monophonic sound reproducing system is a field type sound reproducing system in which one or more microphones, used to pick up the original sound, are coupled to one or more loudspeakers in reproduction. (See Fig. 109-c.)

**STEREOPHONIC:** A stereophonic sound reproducing system is a field type sound reproducing system in which two or more microphones, used to pick up the original sound, are each coupled to a corresponding number of independent transducing channels which in turn are each coupled to a corresponding number of loudspeakers arranged in substantial geometrical correspondence to that of the microphones.<sup>35</sup> (See Fig. 109-d).

### **True binaural**

The ideal system of the four is shown in Fig. 109-b which has also been called "true binaural." It requires the two microphones to be placed in something which is acoustically the equivalent of the human head. The facial features — nose, cheeks, and so on — must be faithfully reproduced and the microphones must be placed in replicas of the outer ears. Under these conditions the listener has the auditory sensation of being present in the exact location of the dummy microphone head. From a psychoacoustic point of view this is ideal, but the method unfortunately has two principal shortcomings.<sup>36</sup>

First, the human ear does not react the same way to sound originating from a pair of headphones as it does to sound coming from loudspeakers. The brain seems to receive the impression of the sound being "piped" to each ear instead of the ears being free to pick up sounds out of space. In addition to this, few persons can stand the discomfort of wearing headphones for more than a short time. Of course, the problem for group listening is even more complex.

The second major shortcoming of binaural audition arises from the fact that the head of the dummy is in a fixed position — the microphones and the dummy head do not move the way the listener is free to move his head — whereas if a person moves his head *at all* while listening binaurally (Fig. 110) the effect is that of the entire auditorium or hall with its performers rotating along with his head. This is unnatural, and the only way to avoid the strange effect is to keep the listener's head clamped in one position.<sup>37</sup>

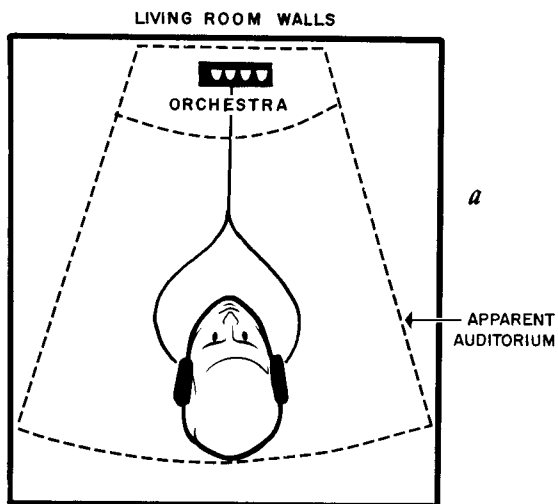
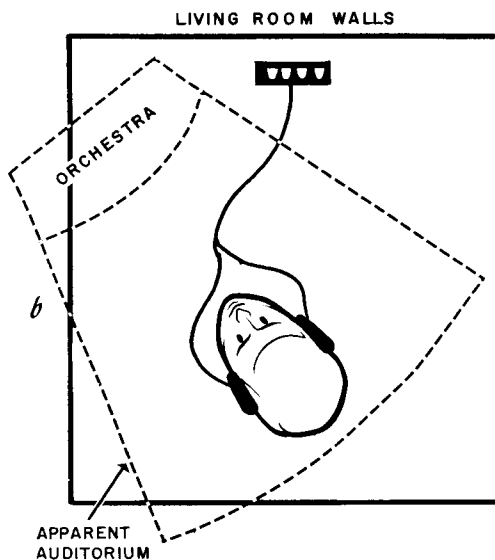

Fig. 110. The "shifting auditorium" effect indigenous to binaural audition.



The definitions of *monaural* and *monophonic* should correct the erroneous use of the first term to apply to systems using loudspeakers. A monaural system may or may not have microphones closely spaced, but it must terminate in closely fitted headphones on the listener's ears to keep the closed circuit. The same applies

to binaural, with, of course, the separate channels. More correct writers in the technical periodicals now use the word *monophonic* when referring to single-channel systems terminating in loudspeakers.

A monophonic system can be built to satisfy all the usual criteria, and could provide performance indistinguishable from the original — but only if the sound source is a single person's voice coming from a prescribed position directly in front of the microphone. This deficiency is the result of the failure of the monophonic system to transmit an indication of the position of sound with respect to the microphone. A system should transmit this position indication, because, as Moir points out:

“... in comparatively recent years it has become apparent that our enjoyment and appreciation of both speech and music is greatly influenced by the accuracy with which the spatial characteristics of the original sound source are transmitted.”<sup>38</sup>

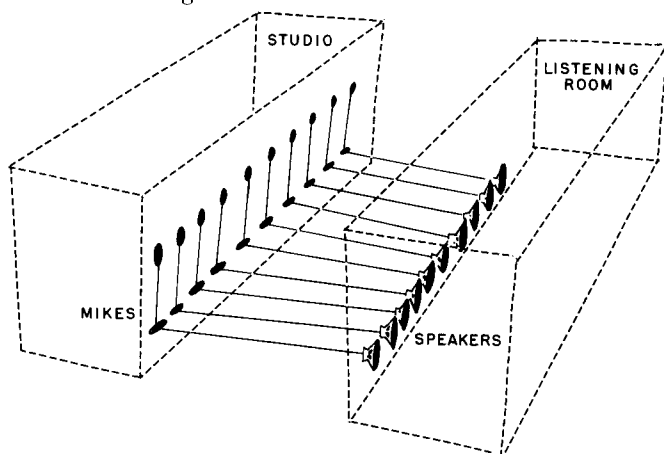

Fig. 111. *Perfect stereophonic reproduction would be approached only by this "electronic orchestra" system.*

To clarify our semantics, the word *stereophonic* has as its roots the ancient Greek words *stereo* (solid) and *phone* (sound). The word itself, then, is an adjective meaning in essence, "having to do with solid (three-dimensional) sound".<sup>39</sup>

### **"Ideal" and practical stereophony**

The original idea for stereophonic reproduction suggested a whole line of microphones arranged along one wall of a studio or hall where the orchestra or other group performs and, to correspond to it, a similar line of loudspeakers (Fig. 111) to be placed all along one wall of the listening room. Each separate

loudspeaker would relay the channel of sound picked up by its corresponding microphone. The result of this "electronic orchestra" was that the exact form of the sound wave reaching the wall of microphones was reproduced in the listening room. Considerable improvements were noted in this idealized system, which endeavored to "remove" the double wall between the studio and listening room.<sup>40</sup>

### **Number of channels**

While this plan might be feasible for a violin sonata or a trio, it would certainly get out of hand economically when reproducing a symphony — we certainly cannot have a separate channel for each instrument of the orchestra.<sup>41</sup> However, the principle can be scaled down to a practical size. We might get down to the seven separate channels of Cinerama sound tracks, the five of CinemaScope or the three of Fantasound.<sup>42</sup> It was found by some engineers that three microphones, feeding three separate channels ultimately into three loudspeakers, gave an optimum degree of realism — one that was not appreciably improved by adding more channels — while using only two channels gave a realism much better than obtained with just a single microphone and loudspeaker (monophonic), but noticeably below the standard achieved by the three-channel system.<sup>43</sup>

Newitt thinks the three-channel system impractical for the home because of complexity and expense. His three recommendations are as follows:

1. No more than two channels are necessary or desirable for a home type of stereophonic system.

2. A separate volume-expansion track is not necessary or advantageous.<sup>44</sup>

3. Placement of the speakers in the reception room is important and the spacing of such speakers should simulate the effect of the original microphone spacing.<sup>45</sup>

Recordings made binaurally sound extremely bad when played through stereophonic reproducing systems. This is especially true for those listeners sitting some distance from the center line between the speakers. As one moves out of the central position, the effect of the performance soon becomes that of two monophonic systems, transmitting no impression of size or source position.<sup>46</sup>

The pickup end must be changed to remedy this situation. The microphones must be placed out toward the limits of stage

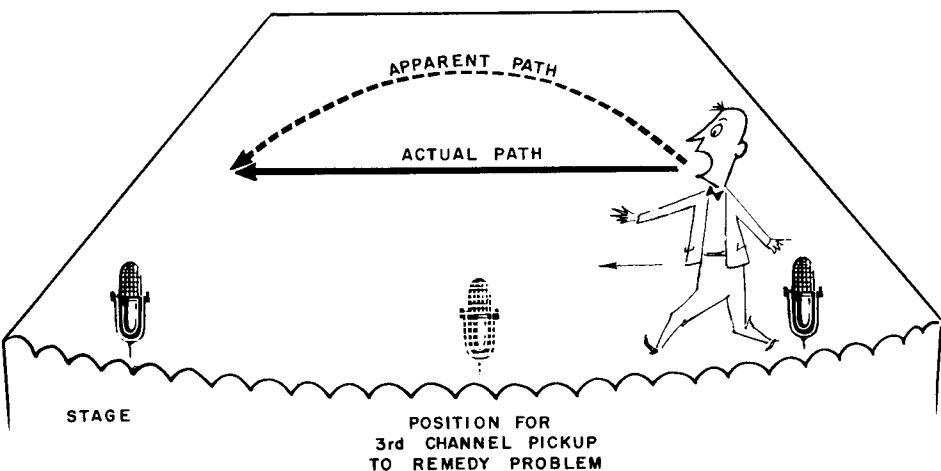

Fig. 112. The problem of the recession of the middle of the sound image, caused by the two microphones being too far apart. A middle microphone would bring the center into proper position.

action, with the speakers mounted roughly the same way. Now a new problem creeps in. While this increases the stereophonic area, it results in a marked recession of the center of the stage, making actors walking a straight line in front of the speakers appear to follow a concave path (Fig. 112) as the area between their distance from the microphones is greater. To bring the center of the stage into its proper position, we must return to three channels, which reproduce size and position satisfactorily over 90–95% of the floor area.<sup>47</sup>

### Two-channel limitations

Steinberg and Snow at the Bell Telephone Laboratories studied the limitations of two-channel stereophonic systems as compared to three-channel systems with a caller taking nine positions in front of microphones in a room while the speakers in a small auditorium played the sound to an audience which tried to indicate by checking a card the apparent position of the caller. Two-channel reproduction decreased the accuracy of localization considerably. Nevertheless, the researchers said a two-channel system may be acceptable for domestic use where the listeners don't stray far away from the center line of the speakers.<sup>48</sup>

One large difference between binaural and stereophonic reproduction is pointed out by Moir. Binaural electrically translates the listener to the position of the audience in the hall or

studio. Stereophony, however, “samples” the sound field existing at the microphone plane and then reproduces it in the living room. The brain appears able to reconstruct the acoustic scene

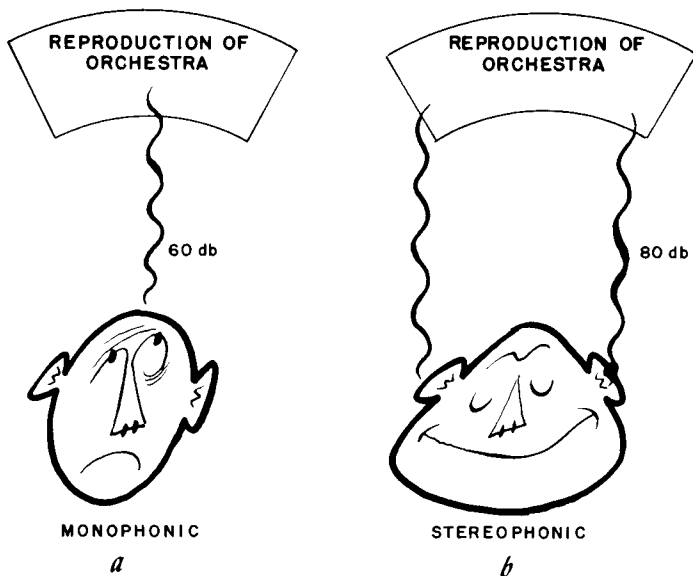

Fig. 113. Comparison of relative maximum sound levels preferred by a listener on (a) a monophonic system and (b) a stereophonic system.

from a fraction of the total information that would at first seem necessary. This is shown by the poor localization by the ear in certain areas. Localization by ear in the vertical plane is so poor that a  $25^\circ$  displacement of sound source from visual image is not noticed, while only  $10^\circ$  angular error of sound in a horizontal plane is noticed.<sup>49</sup>

### Sound intensity

The matter of intensity of sound was mentioned only briefly earlier in this chapter.<sup>50</sup> Experiments conducted by Somerville in England and Chinn in the United States showed that a large orchestra playing at full volume could not be tolerated by listeners to a high-quality monophonic system. People preferred much lower maximum levels since the single channel prevented them from “listening away” when the sounds were too penetrating. The annoyance is understandable when one considers that the orchestra, measuring perhaps 100 by 30 feet, was being con-



densed in all its spread of sound into a single 8- or 10-inch diameter hole.<sup>51</sup> (See Fig. 113.)

### **The illusion of realism**

None of the binaural or stereophonic systems are able, even in theory, to achieve perfection of their objectives when more closely examined. It is apparent that the really important thing is to produce a good *illusion* of realism, though in order to do it we may have to use what some whimsical engineers have dubbed a "bistereonastralphonic" system, something which is a bit of each, or nothing at all, according to the "classic" theory.<sup>52</sup>

The advantages are great even when other true-fidelity criteria suffer at the hands of the stereophonic effect. J. P. Maxfield of Bell Telephone Laboratories has said:

"I would rather hear a two-channel system reproduction good to 6,000 cycles per second than single-channel reproduction flat to 15,000 cycles per second; it is more pleasing, more realistic and more dramatic."<sup>53</sup>

### **Advantages of stereophonic reproduction**

To conclude, let us sum up the advantages of stereophonic reproduction:

1. Increase in clarity.
2. Reduction of blurring.
3. Increased enjoyment from movement of sound source.
4. Increased naturalness of performance.<sup>54</sup>

### **Bibliography and References**

- <sup>1</sup> Donald Carl Hoefler, "Ready for Stereo?," RADIO-ELECTRONICS Magazine, October 1958, page 36.
- <sup>2</sup> Norman H. Crowhurst, *Stereophonic Sound* (New York: John F. Rider Publisher, Inc., 1957).
- <sup>3</sup> *Ibid.*, page 2.
- <sup>4</sup> Hoefler, *op. cit.*, page 36.
- <sup>5</sup> *Ibid.*
- <sup>6</sup> Cited in Albert B. Wood, *A Textbook of Sound* (New York: Macmillan Co., 1930), page 362.
- <sup>7</sup> Hoefler, *op. cit.*, page 36.
- <sup>8</sup> Wood, *loc. cit.*
- <sup>9</sup> Hoefler, *loc. cit.*
- <sup>10</sup> S. P. Thompson, *The London, Edinburgh and Dublin Philosophical Magazine and Journal of Science*, V, 1877, page 274.

- <sup>11</sup> C. E. Lane, *Physical Review*, XXVI, 1925, page 401.
- <sup>12</sup> Elliot M. Cramer and W. H. Huggins, "Creation of Pitch Through Binaural Interaction," *The Journal of the Acoustical Society of America*, May 1958, pages 413-417.
- <sup>13</sup> White noise is an envelope of high-frequency "hiss" with no musical tones, often used in hearing and conditioning research.
- <sup>14</sup> *Ibid.*, page 417.
- <sup>15</sup> B. M. Sayers and E. C. Cherry, "Mechanics of Binaural Fusion in the Hearing of Speech," *The Journal of the Acoustical Society of America*, XXIX, 1957, page 973.
- <sup>16</sup> Irwin Pollack and J. M. Pickett, "Stereophonic Listening and Speech Intelligibility against Voice Babble," *The Journal of the Acoustical Society of America*, February 1958, page 131.
- <sup>17</sup> James Moir, *High Quality Sound Reproduction* (London: Chapman & Hall, Ltd., 1958), page 561.
- <sup>18</sup> *Ibid.*, page 563.
- <sup>19</sup> *Ibid.*, pages 563-664.
- <sup>20</sup> *Ibid.*, page 565.
- <sup>21</sup> Klumpp and Eady, "Measurements of Internaural Time Difference Thresholds," *The Journal of the Acoustical Society of America*, September 1956, pages 859-860.
- <sup>22</sup> Zwislocki and Feldman, "Just Noticeable Differences in Dichotic Phase," *The Journal of the Acoustical Society of America*, September 1956, pages 860-864.
- <sup>23</sup> Moir, *op. cit.*, page 568.
- <sup>24</sup> *Ibid.*
- <sup>25</sup> Rayleigh, *Sound*, II, p. 440. Cited in Wood, *op. cit.*, page 359.
- <sup>26</sup> Geiger and Scheele, *Handbuk der Physik*, page 538. Cited in Wood, *op. cit.*, page 359.
- <sup>27</sup> Donald R. Griffin, *Listening in the Dark: The Acoustic Orientation of Bats and Men* (New Haven: Yale University Press, 1958).
- <sup>28</sup> David Hall, "Stereo: Genuine and Simulated," *Hi-Fi Music at Home*, October 1957, page 168.
- <sup>29</sup> Crowhurst, *op. cit.*, pages 7-8.
- <sup>30</sup> Moir, *op. cit.*, page 479.
- <sup>31</sup> Robert Oakes Jordan and James Cunningham, "Industrial Uses for Stereo Sound," *Tape Recording*, October 1958, pages 22-23.
- <sup>32</sup> John H. Newitt, *High Fidelity Techniques* (New York: Rinehart Books, Inc., 1953), page 6.
- <sup>33</sup> Jordan and Cunningham, *op. cit.*, page 23.
- <sup>34</sup> Harry F. Olson, "Sound Reproducing Systems," *Audio*, September 1958, page 28.
- <sup>35</sup> *Ibid.*, page 28.
- <sup>36</sup> Hoefler, "Ready for Stereo?," *op. cit.*, page 37.

- <sup>37</sup> Crowhurst, *op. cit.*, page 10.
- <sup>38</sup> Moir, *op. cit.*, page 553.
- <sup>39</sup> Louis E. Garner, Jr., "Stereo Then and Now," *RADIO-ELECTRONICS Magazine*, March 1959, page 53.
- <sup>40</sup> Crowhurst, *op. cit.*, pages 34–35.
- <sup>41</sup> Charles Tepfer, "Stereo in the Home," *Hi-Fi Guide & Yearbook*, 1958, page 135.
- <sup>42</sup> Hoefler, *op. cit.*, page 37.
- <sup>43</sup> Crowhurst, *op. cit.*, page 34.
- <sup>44</sup> *Infra*, page 56.
- <sup>45</sup> Newitt, *op. cit.*, page 138.
- <sup>46</sup> Moir, *op. cit.*, page 557.
- <sup>47</sup> *Ibid.*, page 558.
- <sup>48</sup> *Ibid.*, page 559.
- <sup>49</sup> *Ibid.*, pages 558–559.
- <sup>50</sup> *Supra*, pages 10, 13.
- <sup>51</sup> Moir, *op. cit.*, pages 555–556.
- <sup>52</sup> Crowhurst, *op. cit.*, page 45.
- <sup>53</sup> Moir, *op. cit.*, page 556.
- <sup>54</sup> *Ibid.*

## early developments

**T**HE idea of stereophonic reproduction is not new. It is actually about five years younger than the invention of the telephone.

### Ader's experiment

On Aug. 30, 1881, the German Imperial Patent Office granted a patent to the Parisian engineer, Clement Ader, covering "Improvements of Telephone Equipments for Theatres." This patent gave full details for a method of direct transmission of operas, plays and other productions from the stage to the telephone subscriber. These lines were permanently connected direct to the subscriber.<sup>1</sup> To quote Ader's patent:

The transmitters are distributed in two groups on the stage, a left and a right one. The subscriber has likewise two receivers, one of them connected to the right group of microphones and the other to the left. Thus, the listener is able to follow the variations in intensity and intonation corresponding to the movements of the actors on the stage. This double listening to sound, received and transmitted by two different sets of apparatus, produces the same effects on the ear that the stereoscope produces on the eye.<sup>2</sup>

Ader's device received notable attention when it was used at the 1881 Paris Exposition to "broadcast" presentations from the stage of the Paris Opera.<sup>3</sup> We may be sure that Ader was completely aware of what he was doing and did not hit upon his arrangement merely by chance. This fact is substantiated by the patent drawings.<sup>4</sup>

From Ader, the invention's life leads to another inventor named Ohnesorge, who installed similar apparatus in the music hall of

the Crown Prince's palace (evidently the Crown Prince of Prussia). In a European magazine, Manfred von Ardenne wrote on the subject, and later a commercial venture called "Steidel's Stereophony" also made its appearance.<sup>5</sup>

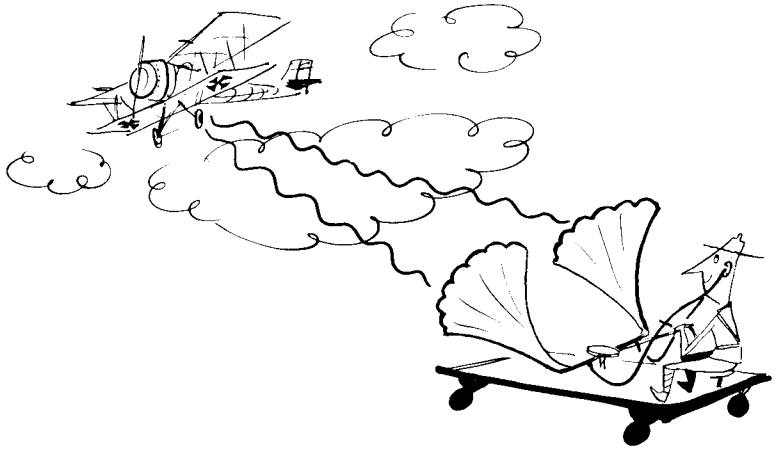

Fig. 201. Binaural receiving trumpets used during World War I to aid in locating enemy airplanes.

Most of the textbooks on sound written during this time ignore the refinements of binaural audition. The next mention of stereophony came during the First World War, when the theory was put to grim practical use in the construction of various instruments of war. Binaural receiving trumpets (Fig. 201) were used to locate enemy airplanes. The large horns, a sort of overgrown version of the Victrola's "Morning Glory Horn," were supported on movable stands. The small ends of the trumpets were connected with rubber tubing to the operator's two ears. His hearing was thereby extended greatly in its directional sensitivity.<sup>6</sup> A device operating in much the same manner and called a geophone was used to determine the direction of sound underground. This proved useful in locating enemy trenching and mining operations.<sup>7</sup> To jump ahead to World War II, the use of binaural sound in the underwater detection of submarines, which had been pioneered in World War I, became an important aid to the Navy.

### **Stereo broadcasting in the 1920's**

In a March, 1924, journal, engineers Harvey Fletcher and W. H. Martin had some prophetic things to say about stereophony:

In considering the pickup of material for broadcasting it should be noted . . . that it corresponds to listening with one ear, that is, the binaural sense of direction which is normally obtained in hearing the sounds directly, is lacking. With binaural audition, it is possible to concentrate on one sound source and to disregard somewhat the effect of other sounds coming from different directions or distances. Because of the monaural character of broadcasting it is necessary, therefore, to go even further in reducing noises and reverberation at the transmitter than would be the case for an observer using two ears at the same location. . . .

In broadcasting . . . Those who make use of the system are . . . becoming more critical of the service which it renders and the quality of reproduction will be of increasing importance in the future.<sup>8</sup>

The following year, Kapeller made a considerable improvement upon the Ader system. He called the stereophonic effect "plastic tone reproduction," explaining:

Suppose we place two microphones in front of a sound producer and at distances from each other corresponding to the distance between the human ears. Receivers connected to this system of microphone will give a "plastic" impression. This procedure is called stereophony.<sup>9</sup>

In his installation at the Berlin Opera House (Fig. 202) Kapeller placed six microphones at the edge of the stage in this order: AA, BB, CC. Three of these, the first A, B and C, were connected to one pair of wires, and the other three, the second A, B and C, were connected to the other pair of wires. From each pair of wires cable led to the receivers, where one supplied the receiver on the left ear and the other supplied the receiver on the right ear. According to the inventor:

Whoever has an opportunity to hear this stereophonic transmission is surprised by the effect. The sound seems much fuller and sharper in every detail. The different voices of a chorus become notably more distinguishable from each other and from the orchestra.<sup>10</sup>

One of the difficulties of the system was that it was impossible to furnish every hearer two separate cables to his home. Kapeller saw the possibility of improving radio service by stereophony. He found the difficulties of the process numerous but not insurmountable. He cited the Berlin broadcasting station as an example, for they had already been broadcasting stereophonically on waves of 430 and 505 meters.<sup>11</sup>

An American radio station was experimenting in stereophonic broadcasting at this time also. F. M. Doolittle describes the work, which took place in 1925:

Considering the fidelity with which the present broadcasting apparatus transmits the frequencies employed in music, it may not appear reasonable to expect that any marked improvement is either necessary or possible. [Sic!] Certain factors besides tone values must, however, be taken into consideration. The phonograph and the radio loudspeaker have educated the ear to believe that a close approximation to true tone values is really all that can be expected, and hence the listener does not expect an exact reproduction. Reproduction, using the word in its strict sense, would, of course, mean a rendition so nearly identical with the original that one would be unable to tell, without bringing into play other faculties than that of hearing, whether or not he is present at and listening to the original performance. A close approximation to such reproduction is possible with the method here to be described.<sup>12</sup>

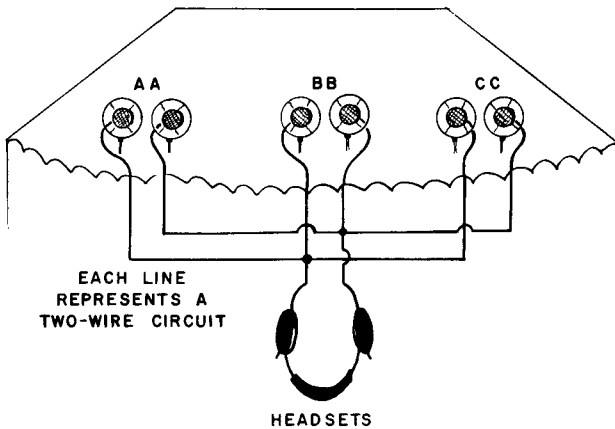

Fig. 202. Diagram of the stereophonic pickup system used at the Berlin Opera House in 1925.

The station was WPAJ, at New Haven, Conn. (See Fig. 203). Since it was already broadcasting on 227 meters (1320 kilocycles), an additional wavelength assignment of 270 meters (1110 kc) was secured in order that binaural transmission might be possible. Duplicate transmitters were installed. Two standard broadcast microphones of the time were connected, one to each channel, with a seven-inch separation between their centers. The transmission was not impaired for ordinary reception since the same program was heard on each wavelength. If binaural listening equipment was used, the naturalness of reproduction was reportedly startling. Headphones were found to be essential, since loudspeakers mixed up the sound from the two separate channels and impaired the effect. Although little publicity resulted from

the project, Doolittle says that a number of experimenters were told how to install equipment for binaural reception. He found the new listeners were, without exception, enthusiastic in their acceptance of the new method of broadcasting.<sup>13</sup>

An amazing description of a multiplexing system (see page 119 for a description of this technique) which was not used for stereophonic broadcasting until 1958, is found in this 1925 article:

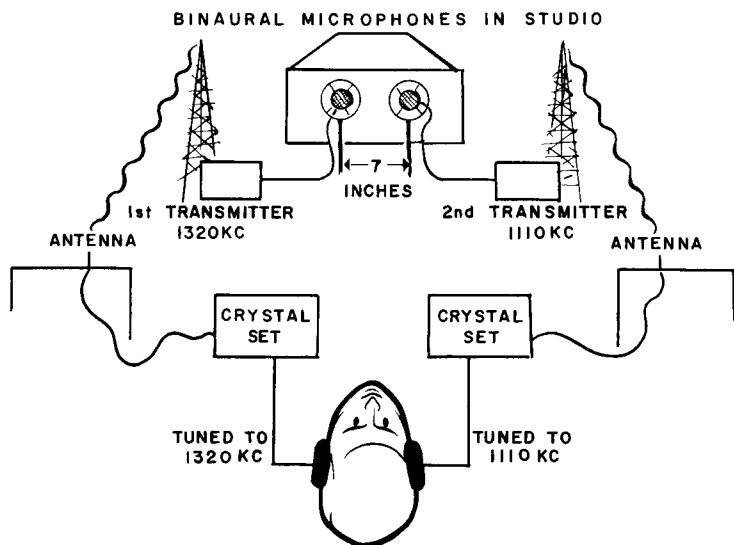

Fig. 203. The binaural broadcasting method of station WPAJ in 1925.

There are other methods which it would be possible to use, for example, the double modulation of the carrier at two super-audible frequencies with audio-frequency variations applied to the modulation frequencies. This method would have the advantage that but one wave band would be necessary in the broadcasting spectrum, although, on account of the considerable difference in sideband and carrier frequencies, greater width than usual would be required. With such a scheme one tuning adjustment would suffice for tuning in various stations . . . For immediate adoption this scheme is not, however, particularly adapted, since the ordinary type of receiver would receive inarticulate sounds . . . For the present, therefore, a method is being employed which does not interfere with ordinary reception.<sup>14</sup>

Doolittle used a single antenna to radiate the two waves. He said it was possible to operate the receivers from a single antenna also. The major difference was the use of two tuning adjustments



and two detectors instead of just one of each. Further experimentation showed interesting effects. If the microphones were placed 6 or 7 inches apart, a normal impression of the size of the studio and location of performers was gained. If the microphones were moved farther apart, an impression of greater depth was obtained and the performers seemed to recede. However, if the microphones were moved still farther apart, the binaural impression became very vague and was eventually lost altogether.<sup>15</sup>

Binaural transmission also produces an apparent increase in volume. If switching arrangements are provided so that the headset may be quickly shifted from the usual or monaural reception to binaural reception, sounds which are heard will appear to jump to their respective locations in three dimensions, and simultaneously there occurs an increase in volume . . . it is not difficult to imagine that an interference effect of some kind is produced by subjection to abnormal phase relations.<sup>16</sup>

Doolittle also discovered some of the advantages that stereocasting provided the performers. He described the many phase relations that exist in a complex musical performance, some direct and some reflected. In monaural broadcasting, the reflected sounds create unpleasant hollow effects and the studio must be draped to prevent reflections. The resultant deadness confuses the performers. With binaural broadcasting, the reflected sounds convey an impression of the general surroundings. It is then unnecessary to provide damping and the performers like the more natural room tone, finding it much easier to perform.<sup>17</sup> (See Fig. 204.)

A few American radio stations conducted experimental two-channel broadcasts at this time. Radio was in its infancy and not many people owned the two sets necessary for listening to stereocasts. So the pioneering work of WPAJ was almost forgotten and stereophonic broadcasting lay dormant for many years.<sup>18</sup>

### **The early 1930's — Blumlein and Fletcher**

Notice of more activity is found in the recording field. Audio engineers recognized that simultaneous two-channel recordings were essential to realistic sound reproduction. In 1930, A.D. Blumlein, a designer employed by Electrical & Musical Industries, Ltd., demonstrated a complete two-channel stereophonic system which included a single-groove disc recording of the two-channel signal. The following year Blumlein filed and received British patent No. 394,325 on his system,<sup>19</sup> which forms the basis for the present EMI Stereosonic recording system (Fig. 205). This system employed a microphone placement designed to eliminate time and

phase differences, and to accentuate amplitude and energy spectrum differences. The two microphones (Fig. 206) are mounted

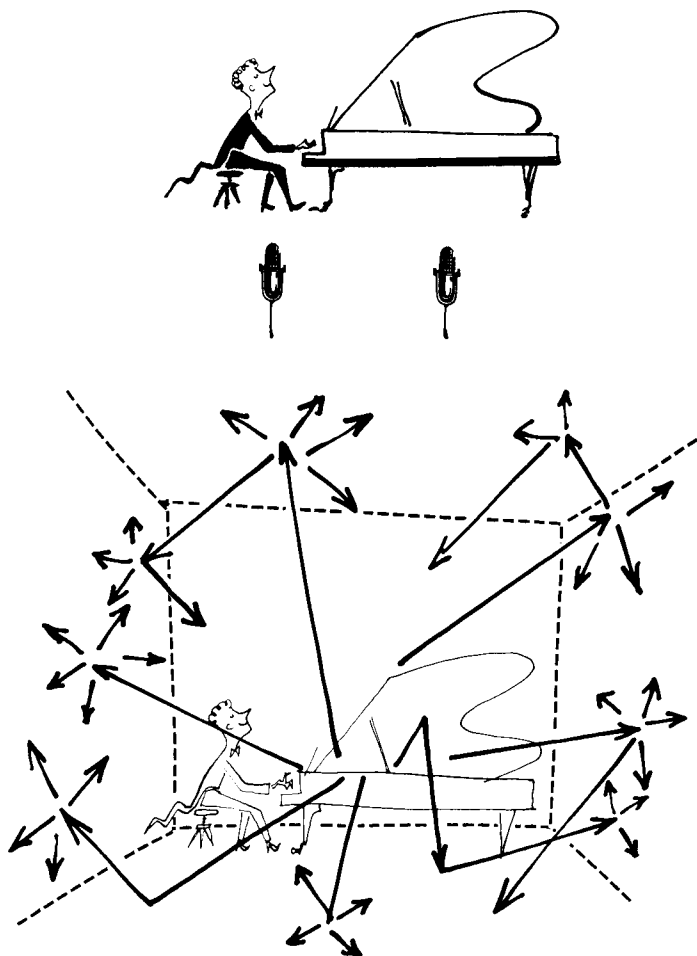

Fig. 204. A musical performance produces complex phase relationships between direct and reflected sound.

as close together as possible and angled out toward left and right sides of the performing group. The coded “sum-and-difference” method can then be applied in the transmission of the two channels.<sup>20</sup>

During 1932, Blumlein perfected his recording system and worked out two alternate methods of cutting the discs. One used the vertical-lateral method — one signal being recorded by ver-

tical stylus motion and the other by lateral motion — and the other used the 45/45 system, employed for modern-day stereo discs.



Fig. 205. First patent on stereo disc recording was held by A. D. Blumlein. Application for the British patent was filed in 1931.

Either method could use the “sum-and-difference” process. Records were made by both methods, at 78 rpm, and satisfactory stereo reproduction was achieved.<sup>21</sup>

In the winter of 1932, “Oscar,” a tailor’s dummy (Fig. 207) with “live” ears, took up residence in the American Academy of Music in Philadelphia. Just in front of his wooden ears, sensitive microphones were set in his cheekbones. He was used for testing sound reproduction with the aid of Leopold Stokowski and the Bell Telephone Laboratories. Oscar duplicated the conditions of normal hearing as closely as possible, not only by modifying the sound field near the two microphones just as human features modify sound, but also by supporting the microphones (see Fig. 208) the same distance apart as human ears.<sup>22</sup>

Harvey Fletcher of the Bell Laboratories classified the types of transmission in a somewhat different manner than RCA’s Olson had done. The four types consisted of, first, the aforementioned monaural and binaural. When more than one receiver reproduced sound from a single-channel pickup, the transmission was classed as “diotic.” When there was also more than one microphone pickup (Fig. 209) but the signal was still transmitted from pickup to reproduction over a single channel, the transmission was called “mixed.”

The advantage of using Oscar was shown to be confined to cases where the source of sound was near the microphones. The public visiting the American Academy of Music was asked to note preference between full-range monaural sound and limited-range binaural sound through Oscar. They all preferred binaural reproduction even when all frequencies above 2,800 cycles were cut off by a filter. After his tenure at the Academy, Oscar was installed

at the Century of Progress Exhibition in Chicago, where he continued to amaze visitors.<sup>23</sup>

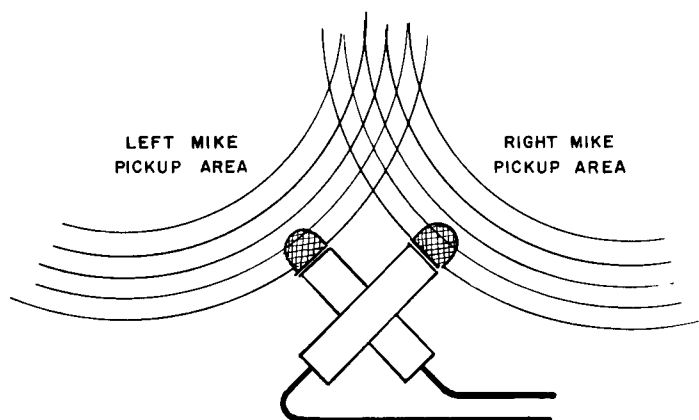

Fig. 206. *Arrangement of the microphones in Blumlein's stereophonic recording system.*

### The 1933 Bell Experiment

The work with Oscar laid the foundation for the most successful and most highly publicized stereophonic experiment up to this time. According to a Bell Laboratories spokesman:

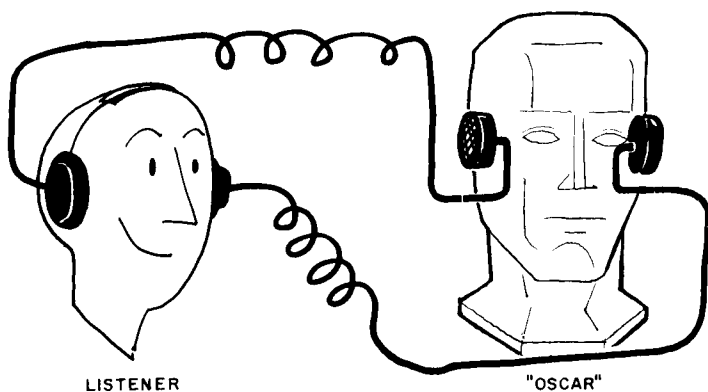
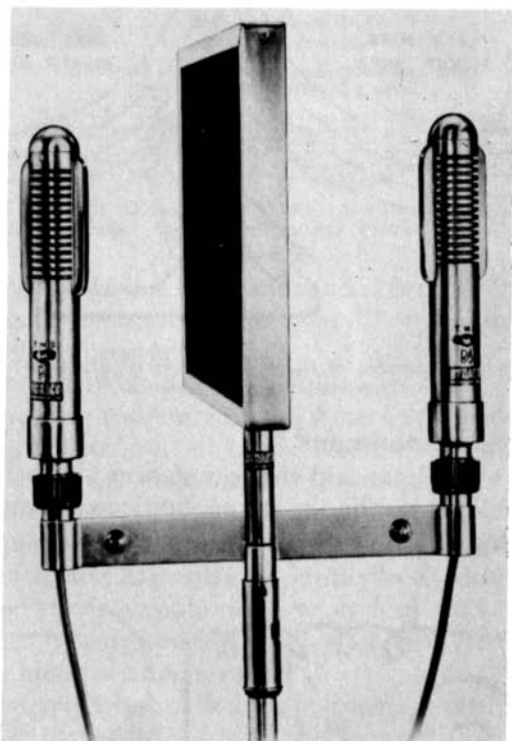

Fig. 207. *A visitor to the American Academy listening to "Oscar".*

... telephonic research has laid a foundation for what may be one of the greatest advances in musical aesthetics of the present scientific era.<sup>24</sup>

The experiment's high point took place on April 27, 1933, and

consisted of a stereophonic transmission by telephone lines of a performance given by the Philadelphia Orchestra, in Philadelphia, to Washington, D. C. The demonstration was preceded by an earlier one on April 12 when the signal was carried only as far as



*Fig. 208. This arrangement of microphones is still sometimes used today, with a baffle to simulate the acoustic effect of the human head. However, the figure-eight pickup pattern of these special microphones results in an apparent separation of as much as 10 feet.*  
(Dynaco, Inc.)

another room in the Academy building in Philadelphia. The demonstrations were attended by many guests from the fields of science and music.<sup>25</sup> (A photo of another demonstration in New York is shown in Fig. 210.)

In a 1934 symposium on stereophony, then called "auditory perspective" by the Bell engineers, Harvey Fletcher explained some of the reasons why correct auditory perspective is needed for maximum fidelity. He described the continually changing

vibrations produced in the air of a hall when an orchestra is playing:

An ideal transmission and reproducing system may be considered as one that produces a similar set of vibrations in a distant hall in which is executed the same time sequence of changes that takes place in the original hall. Since such changes are different at different positions in the hall, the use of an ideal system implies that at corresponding positions in the two halls this time sequence should be the same. Obviously, this never can be true at every position unless the halls are the same size and shape; corresponding positions would not otherwise exist.<sup>26</sup>

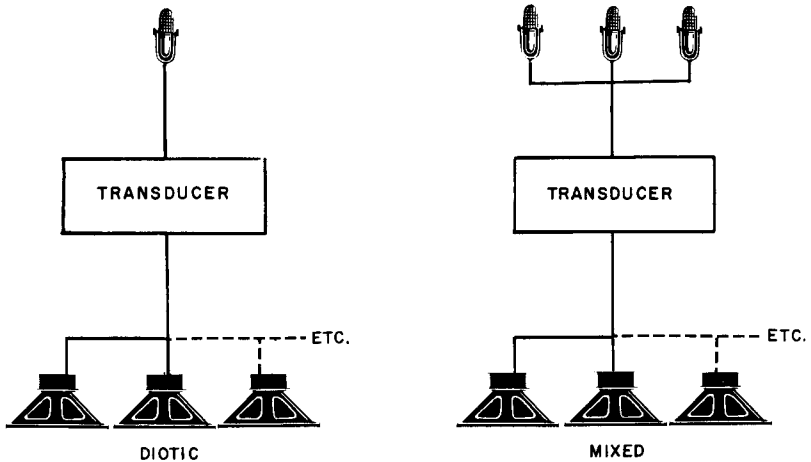

Fig. 209. Representation of diotic and mixed sound transmission.

If both halls could be the same size and shape, the problem would be to obtain such perfect reproduction that any listener in any part of the second hall would receive the same sound effects as if he were in a corresponding position in the first hall. Fletcher went on to describe the perfect transmission line. It should deliver to the loudspeaker electrical energy equal both in form and magnitude to that which it receives from the microphone. He then considered the aforementioned "electronic orchestra," with an infinite number of microphones and speakers. He said only a few channels are really needed to give depth and a sense of extensiveness to the source of the music.<sup>27</sup>

Fletcher stressed the importance of knowing how far from the ideal requirements one may go before the listener will be aware that there has been any degradation from the ideal. He considered good transient response as important. (The frequency band needed to transmit faithfully whenever a sound is suddenly

stopped or started is extremely wide.) The range of frequencies should be determined, according to Fletcher, by the range of human hearing rather than by the kind of sound being reproduced.<sup>28</sup>

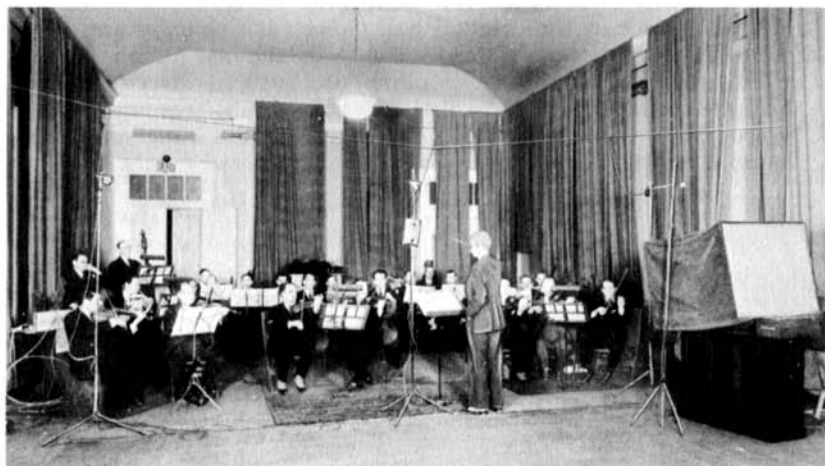

Fig. 210. *Early Bell Telephone Laboratories stereo experiments (1933) included this demonstration where the orchestra was in a room two floors above the auditorium. Three microphones were spaced across the room in line with the conductor.*

The system used in the Bell experiment fulfilled all of Fletcher's requirements for proper auditory perspective. The demonstration was given, on the receiving end, at Constitution Hall in Washington, D. C., under the auspices of the National Academy of Sciences. Leopold Stokowski, long-time champion of advanced sound-reproduction techniques, controlled the Philadelphia Orchestra electronically by manipulating three controls in Constitution Hall while associate conductor Alexander Smallens actually conducted the orchestra in the Academy of Music in Philadelphia. Three microphones were placed before the orchestra (Fig. 211) one on each side and one on the center line at about 20 feet in front of and 10 feet above the first row of instruments in the orchestra.<sup>29</sup>

These microphones were a moving-coil directional type. The frequency response dropped off as the sound moved toward a greater angle of incidence from the microphones. In general, this was not considered desirable but, in the Bell experiment, the sounds observed as coming from each loudspeaker were mainly those which were picked up directly in front of each microphone; sound waves incident at a large angle did not matter much. At some times, the sound delivered by the orchestra was extremely

low. Since the stereophonic effect falls off as audibility becomes difficult, the microphones had to be of great sensitivity.<sup>30</sup>

The electrical vibrations from the microphones were amplified by voltage amplifiers and then fed into a transmission line which was extended to Washington by telephone cable. There were some amazing similarities between this demonstration and the one at the Paris Exposition 52 years earlier.<sup>31</sup> The Paris group wanted to give the on-stage orchestral forces the "character of relief and localization"<sup>32</sup> in the same way the Bell engineers did. Of course, the main problem of the Paris experiment was that audio ampli-

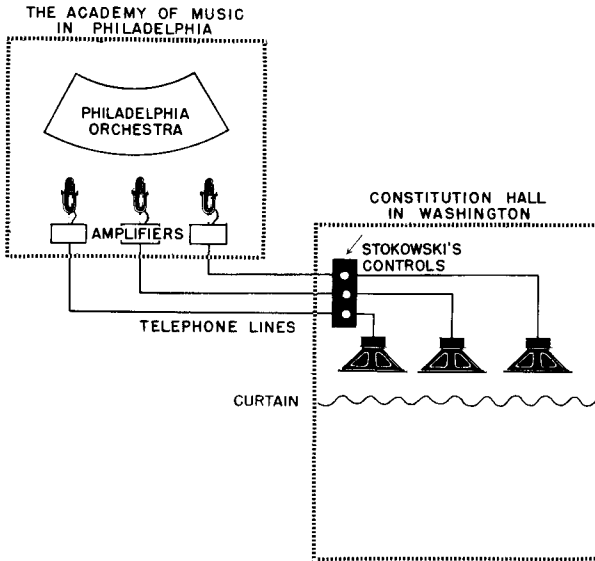

Fig. 211. Simplified diagram of the Bell Telephone Laboratories three-channel "broadcast".

fiers had not yet been invented. That invention waited upon the creation of the Audion tube of de Forest. Therefore, no loudspeakers were possible. With the headphones used, it was necessary to generate only enough sound of audible intensity to fill a volume of space enclosed between the head receiver and the human ears.<sup>33</sup>

The transmission lines used in the Bell experiments had to be so perfect in their characteristics that reproduction 100 or 200 miles away would not suffer in comparison with reproduction 100 or 200 feet away. Affel, Chesnut and Mills described some of the distortion found in telephone lines, such as noise, crosstalk and



frequency-amplitude distortion. Ordinary telephone lines do not exceed 200 to 3,000 cycles in frequency response, and most AM radio, even at present covers only 100 to 5,000 cycles. These lines had to transmit at least 40 to 15,000 cycles. It is easy to see the difficulty of the undertaking. Additional amplifiers manned by engineers along the line between the two cities kept the output constant along the entire length.<sup>34</sup>

The output of the three lines was fed into special 120-watt audio amplifiers and then into the three sets of loudspeakers. They were placed in position on the stage of Constitution Hall according to the microphone placements in the hall of the Academy of Music in Philadelphia. Maestro Stokowski had one control for each channel, to blend according to his wishes. Fletcher's conclusion was:

Judging from the expression of those who heard this concert, the development of this system has opened many new possibilities for the reproduction and transmission of music that will create even greater emotional appeal than that obtained when listening to the music coming directly from the orchestra through the air.<sup>35</sup>

Two other Bell engineers, Bedell and Kerney, described in the symposium some of the problems in adapting the system to various acoustic environments. Remember that these remarks apply only to large auditorium or theater-type stereophonic systems. The engineers found that the system:

. . . must be designed properly with respect to the acoustics of the pickup auditorium and the concert hall involved. The reverberation times and sound distribution in the two auditoriums, and the location of the microphones and loudspeakers, and the response-frequency calibration of the system and its equalization are considered.<sup>36</sup>

The acoustics of the halls are important because the sound reaching the listener may be as much as 90% reflected from the various room surfaces. When listening to reproduced sound in a concert hall, the acoustics are even more important because the audience doesn't see anyone on the stage and is forced to rely entirely upon the auditory effect to create the illusion of stage presence.

In some types of presentation, such as radio broadcasts, where the reproduction normally takes place in a small room, the attempt is made to create the illusion that the listener is present at the source. In the case of the auditorium system, however, the ideal is to create the illusion that the entire orchestra is present

on the stage of the auditorium in front of the audience. Since the orchestra is playing in one large room and the music is heard in another, the acoustical conditions prevailing in both spaces have to be considered. The auditorium of the Academy of Music had a volume of 700,000 cubic feet and a capacity of 3,000 seats. Constitution Hall was slightly larger.<sup>37</sup>

The microphone positions, selected only after careful tests using several locations, were much nearer to the orchestra than they would have been for single-channel pickup. A high ratio of direct to reverberant sound reduced the effect of reverberation in the source room upon the reproduced music. This high ratio was needed with the three-channel system because the perspective effect was dependent on the relative intensity at the three microphones. The change in intensity with increasing distance from the source is marked for direct sound only, so there would be a loss of perspective effect if the microphones were placed farther back.<sup>38</sup>

The application of acoustic perspective to orchestral reproduction in large auditoriums gives more satisfactory performance than probably would be suggested by the foregoing discussions. The instruments near the front are localized by everyone near their correct positions. In the ordinary orchestral arrangement, the rear instruments will be displaced in the reproduction depending upon the listener's position, but the important aspect is that every auditor hears differing sounds from differing places on the stage and is not particularly critical of the exact apparent positions of the sounds so long as he receives a spatial impression. Consequently two-channel reproduction of orchestral music gives good satisfaction and the difference between it and three-channel reproduction for music probably is less than for speech reproduction or the reproduction of sounds from moving sources.<sup>39</sup>

The six papers making up the symposium were presented as part of the winter convention in New York City of the American Institute of Electrical Engineers, on Jan. 24, 1934. Harvey Fletcher was in charge of the demonstration given at that time in the auditorium of the Engineering Societies Building at 29 W. 39th St. He illustrated the character and range of effects that could be produced with the system. It was also briefly reported to the National Academy of Sciences in April, 1933, in a paper by Dr. F. B. Jewett, vice president of American Telephone & Telegraph Co. and president of the Bell Telephone Laboratories.<sup>40</sup>

In a recent pro and con discussion of stereo, Fritz A. Kuttner, a noted musicologist and electro-acoustician had this to say about the Bell experiments:

In the middle of the Nineteen Thirties, after many years of thorough and successful experimentation, the scientists of the Bell Laboratories had abandoned the stereo idea as having too little musical value and aesthetical potential. Apart from a few sporadic reappearances, stereo remained dormant until about 1954, when manufacturers of loudspeakers and pre-recorded tape revived the principle, obviously for purely commercial reasons, because at that time nobody had any experience with the medium beyond what the Bell scientists had found 20 years earlier.<sup>41</sup>

Donald J. Plunkett, president of the Audio Engineering Society, answered these accusations by saying that Kuttner had his information turned around. The Bell demonstrations, for example, the one with "Oscar," showed that listeners liked stereo much better than monaural reproduction. Stereo stayed dormant in the pre-war period, according to Plunkett, because the phonograph industry was financially weak due to the advance of radio and the depression. It was the belief of Blumlein and his associates that stereo, if it could be commercialized, would greatly enhance the effectiveness of reproduced sound.<sup>42</sup>

### **Developments following the Bell experiment**

Stereo was by no means dead during these 25 years. English and American companies continued to experiment actively.<sup>43</sup> Leopold Stokowski continued his work in music and sound reproduction with his article "New Vistas in Radio" in 1935.<sup>44</sup> He proposed double circuits for auditory perspective which would correspond to our two ears. He saw the Bell demonstration as an argument for wired radio. This would solve all the problems of space radio (regular broadcasts)—such as the restricted range, static and fading. (See Fig. 212.) He found that:

It is an amazing thing that this possibility has existed now for 2 years and that no use has been made of it . . . Through it, by a selective process, it is possible so to enrich certain parts of the tapestry of sound, bringing them out in relief, that the three-dimensional character of the music is greatly emphasized.<sup>45</sup>

Stokowski continued with some rather remarkable suggestions for giant "recreation centers" of parks and gardens featuring stereophonic concerts, both indoors and out. The outdoor installations would utilize high towers with speakers mounted so as to focus the sound in certain areas; those not wishing to listen to the music or wanting other sorts of music would be able to remain close by and not be bothered.<sup>46</sup>

In 1936, Bell engineers Rafuse and Keller patented a vertical-lateral cutter for stereophonic discs that could also cut today's

45/45 type discs. The US patent was No. 2,114,471.<sup>47</sup> The next year brought another development from the Bell Laboratories as they demonstrated the first stereophonic tape recorder at the World's Fair. The machine used steel tape, as did most of the early tape recorders.<sup>48</sup> By the time of the 1939 Fair, the machine had been improved with the use of the distortion-cutting ac bias, the first known use of the device in tape recording.<sup>49</sup>

A stereophonic sound film was first seen by a large number of Americans in 1941. The "entirely new type of motion picture sound" accompanied Walt Disney's film "Fantasia," and once again Leopold Stokowski worked on the project. The process and the developments in the motion picture industry leading up to it and following it will be discussed in Chapter 3.<sup>50</sup>

A system of stereophonic disc recording with conventional 78-rpm records was introduced by a Dutch engineer, De Boer, in 1940. Two grooves were cut on the record, each one modulated by one of the two channels. One groove occupied the outer portion of the disc, while the other occupied the smaller-diameter inner portion. (See Fig. 213.) This caused some difficulty because of the use of grooves of different radii.

The recording cutters were mounted on a shaft in a straight line along the radius of the disc, while the playback arms followed a curve. The two pickup heads were fastened to the end of a rotating arm and thus described an arc on the disc. (See Fig. 214.) De Boer also considered the problems of placing the styli in the proper grooves, and the effects of eccentricity of the record axis on the resultant sound.<sup>51</sup>

### **Post-war developments**

The Germans did not limit their well-known pioneering in magnetic tape recording to single-channel reproduction. Work during the war resulted in a paper published only a few months after peace, titled "Stereophony."<sup>52</sup> The German high-fidelity stereophonic film system, called the Stereophon, had three channels, a frequency range of 23 to 10,000 cycles, and a dynamic range of 60 decibels. The sound track was only 2.65 millimeters wide. In appearance, the system resembled regular motion-picture sound-film units. It used Kerr photoelectric cells and a method of polarizing the light falling on the sensitized film in such a way as to transmit the information from the three channels.<sup>53</sup>

In 1946, in the United States, stereophonic sound reinforcement was bringing new sound quality to outdoor operetta presentations.<sup>54</sup> Electrical & Musical Industries in England was engaged

in a major study of stereo, both at the fundamental level and in practical form with magnetic tape, extending the work of Blumlein already described.<sup>55</sup> English Decca, in collaboration with the

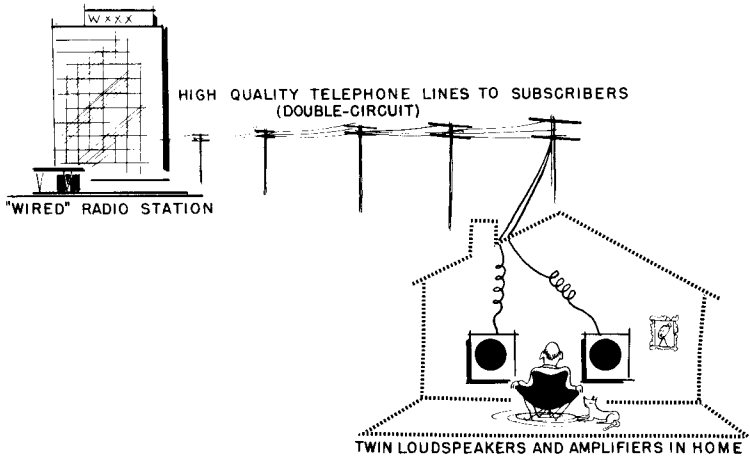

Fig. 212. *Diagram of wired stereophonic radio as proposed by Stokowski.*

German Telefunken Co., continued to work on stereophonic disc recording.<sup>56</sup>

### The Cook stereo disc

It was the great post-war refinement of record playback equipment, including the vinyl plastic long-play record with its quiet surface and light tracking force, that brought the state of the art closer to practical stereophonic discs for the home.<sup>57</sup> The person to make the first step was audio engineer Emory Cook of Stamford, Conn. Drawing freely on the work of De Boer in 1942, Cook triumphantly announced:

. . . the perfection of a technique for producing binaural sound on 12-inch long-play records which is expected to make as great a difference in listening as Cinerama is making in viewing movies.<sup>58</sup>

Aside from the use of the new LP discs as recording surfaces, the method differed little from De Boer's. The two bands of grooves, one outside and one inside, were played either by a two-headed pickup arm, such as one sold by Livingston Audio, or by an ordinary tone arm with the Cook Binaural Clip Conversion attached. This clip-on cartridge carrier allowed a second cartridge similar to the one in the regular tone arm to track the inside

grooves (Fig. 215). The record then delivered simultaneous output from the two cartridges to the two-channel amplifier and the two speakers, spaced, according to Cook, 10 feet apart. Cook claimed that binaural sound seemed louder for the same power level than monophonic sound. There was also less hiss noise level.<sup>59</sup>

Cook and one or two other small record companies produced a small number of recordings by this method. Cook called them "Duplex Recordings" since they could be played on an ordinary

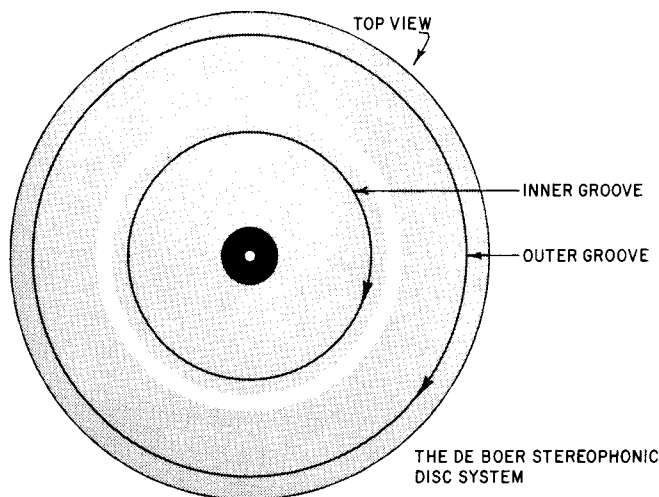

Fig. 213. *Early system of stereophonic disc recording.*

phonograph by using just the outside and ignoring the inside one. Naturally the playing time was approximately half of a regular LP record, since the space had to be divided between the two bands for the two pickups. The biggest problem, however, was the nearly impossible task of getting the two cartridge styli into the correct grooves at points other than the beginning of the records. It was difficult enough at the beginning. Modern microgroove records have the grooves very close together and some latitude has to be allowed for the stylus to adjust itself and compensate for slight variations in tracking at different positions of the arm. This meant that the stylus following one groove of the Cook stereo disc might be one or two grooves away from the grooves corresponding to the groove that the other stylus is playing. This fault doomed the Cook system.<sup>60</sup>

## First commercial stereo tape

While the disc recording industry was still waiting for a practical method of commercializing stereo, the tape manufacturers forged ahead. In 1949, the Magnecord Co. had demonstrated the first stereophonic home tape recorder at the Audio Fair. The Brush Development Co., which had brought out the first standard home tape recorder in the US, in 1947, followed in 1950 with a multi-channel machine. Soon several companies were producing stereophonic home tape recorders and playback machines.<sup>61</sup>

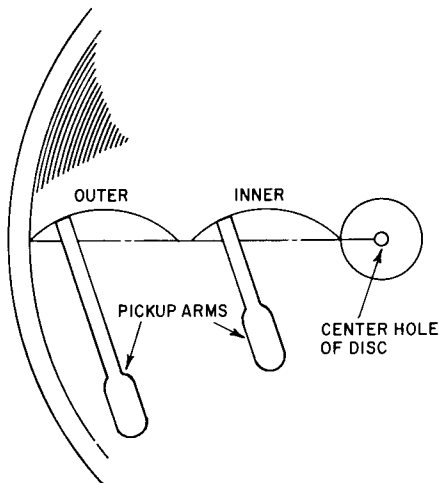

Fig. 214. *The De Boer disc required two pickup arms.*

In 1953, the Pentron Co. demonstrated their six-channel “electronic orchestra.” The separate channels, one for each instrument in the band, were recorded on a standard  $\frac{1}{4}$ -inch magnetic tape. The first commercial stereo tapes were offered to the public in May, 1954, by C. F. Smiley of Livingston Audio. Released on the Audiosphere label, they contained concert music recorded at the May Festival in Florence, Italy, conducted by Vittorio Gui. There were also two tapes by a Viennese choral group. The public had no tape players to listen to these eight tapes, so Livingston sold a tape player at the same time. This prevented the expensive tape from being accidentally erased, as might happen with one of the recorder–playback machines.<sup>62</sup>

The first two years of Livingston’s hectic beginning were dominated by solving the problems encountered in their role as lone

missionary for home stereo. This included endless demonstrations all over the country at audio fairs, dealers, representatives, distributors and just anybody who would listen. Techniques in stereo recording, duplicating and processing had to be developed. Also, the library had to be expanded and once again Livingston found itself in the role of a missionary essentially exhorting the flock to climb on the stereo bandwagon.<sup>63</sup>



Fig. 215. *Double tone arm system used a clip-on device for the second cartridge. (Cook Laboratories, Inc.)*

It took a few years to do it, but these early efforts finally bore fruit. In 1955, the V-M Corp. offered for sale a kit to convert their tape recorders to stereophonic playback, bringing stereophony into the low-priced field. Record companies both large and small began producing stereo tapes and, by 1957, 39 of them were offering more than 650 tapes.<sup>64</sup>

Stereophonics in the home had finally arrived, a very long time after the Paris demonstrations of 1881. The president of the Audio Engineering Society has said,

Far from being a "fad," stereo is the most fundamental advance in sound reproduction since electrical recording came in 1926. . . . Ten years from now . . . every reproducing system will include stereo in some form.<sup>65</sup>



## Bibliography and References

- <sup>1</sup> Ludwig Kapeller, "Radio Stereophony," *Radio News*, October 1925, page 416.
- <sup>2</sup> *Ibid.* English translation from patent.
- <sup>3</sup> Herbert Reid, "History in a Hurry," *Hi Fi & Music Review*, October 1958, page 66.
- <sup>4</sup> Kapeller, *op. cit.*, page 416.
- <sup>5</sup> Cited in Kapeller, page 416, Periodical not available.
- <sup>6</sup> Albert B. Wood, *A Textbook of Sound*, (New York: Macmillan Co., 1930), page 415.
- <sup>7</sup> *Ibid.*
- <sup>8</sup> W. H. Martin and Harvey Fletcher, "High Quality Transmission and Reproduction of Speech and Music," *Journal of the AIEE*, March 1924, pages 233, 238.
- <sup>9</sup> Kapeller, *op. cit.*, page 545.
- <sup>10</sup> *Ibid.*, page 546.
- <sup>11</sup> *Ibid.*
- <sup>12</sup> F. M. Doolittle, "Binaural Broadcasting," *Electrical World*, April 25, 1925, page 867.
- <sup>13</sup> *Ibid.*, page 868.
- <sup>14</sup> *Ibid.*
- <sup>15</sup> *Ibid.*, page 869.
- <sup>16</sup> *Ibid.*, page 870.
- <sup>17</sup> *Ibid.*
- <sup>18</sup> Louis E. Garner, Jr., "Stereo Then and Now," *RADIO-ELECTRONICS Magazine*, March 1959, page 53.
- <sup>19</sup> Jerry B. Minter, "Stereo Disc Recording Methods," *Radio & TV News*, October 1958, page 66.
- <sup>20</sup> *Ibid.*, page 53; also Moir, *op. cit.*, page 570; *infra*, page 146.
- <sup>21</sup> H. A. M. Clark, "Stereophony on Disc," *Engineering*, April 4, 1958, page 448.
- <sup>22</sup> Harvey Fletcher, "An Acoustic Illusion Telephonically Achieved," *Bell Laboratories Record*, June 1933, page 28.
- <sup>23</sup> *Ibid.*, pages 28, 289.
- <sup>24</sup> "The Reproduction of Orchestral Music in Auditory Perspective," *Bell Laboratories Record*, May 1933, page 259.
- <sup>25</sup> Ernest La Prade, *Broadcasting Music* (New York: Rhinehardt & Co., Inc., 1947), page 24.
- <sup>26</sup> Harvey Fletcher, "Auditory Perspective—Basic Requirements," *Electrical Engineering*, January 1934, page 9.
- <sup>27</sup> *Ibid.*, pages 9, 10.
- <sup>28</sup> *Ibid.*, page 10.

- <sup>29</sup> *Ibid.*, page 11.
- <sup>30</sup> E. C. Wentz and A. L. Thures, "Auditory Perspective—Loud Speakers and Microphones," *Electrical Engineering*, January 1934, page 24.
- <sup>31</sup> *Supra*, page 27.
- <sup>32</sup> *Ibid.*, page 17.
- <sup>33</sup> *Ibid.*
- <sup>34</sup> H. A. Affel, R. W. Chesnut, and H. H. Mills, "Auditory Perspective—Transmission Lines," *Electrical Engineering*, January 1934, page 28.
- <sup>35</sup> H. Fletcher, "An Acoustic Illusion Telephonically Achieved," *op. cit.*, page 11.
- <sup>36</sup> E. H. Bedell and Iden Kerney, "Auditory Perspective—System Adaptation," *Electrical Engineering*, January 1934, page 216.
- <sup>37</sup> *Ibid.*, page 217.
- <sup>38</sup> *Ibid.*
- <sup>39</sup> J. C. Steinberg and W. B. Snow, "Auditory Perspective — Physical Factors," *Electrical Engineering*, January 1934, page 17.
- <sup>40</sup> "News of Institute and Related Activities," *Electrical Engineering*, January 1934, page 17.
- <sup>41</sup> Fritz A. Kuttner and Donald J. Plunkett, "The Two Sides of the Stereophonic Disc," *The New York times*, Sunday, March 15, 1959, Section M, page 1.
- <sup>42</sup> *Ibid.*, pages 1, 9.
- <sup>43</sup> *Ibid.*, page 9.
- <sup>44</sup> Leopold Stokowski, "New Vistas in Radio," *Atlantic Monthly*, January 1935, pages 2, 6–7.
- <sup>45</sup> *Supra*, page 6.
- <sup>46</sup> *Ibid.*, page 15.
- <sup>47</sup> Minter, *op. cit.*, page 66.
- <sup>48</sup> "Chronology of Magnetic Recording," *Tape Recording*, February 1958, page 26.
- <sup>49</sup> Joel Tall, *Techniques of Magnetic Recording* (New York: Macmillan Co., 1958), page 17.
- <sup>50</sup> "Fantasound for Disney Picture," *Science Digest*, January 1941, pages 92–93.
- <sup>51</sup> A. de Boer, "Experiments with Stereophonic Records," *Philips Technical Review*, June, 1940, as quoted in "Stereophonic Recording With Conventional Disk Records," *Electronics*, April 1941, pages 101–102.
- <sup>52</sup> "Stereophony," Klangfilm G.M.B.H., Halstead. Exploiting Center Report 10333 PB 30962, 3 mimeographed pages, released by the Office of Technical Services, Department of Commerce, Washington, D. C.
- <sup>53</sup> Report PB 338, Office of Technical Services, Department of Commerce, Washington, D. C. Cited in "Sound Recording Systems," *Mechanical Engineering*, July 1947, page 604.

- <sup>54</sup> A. W. Colledge, "Stereophonic Sound Reinforcement," *Western Electric Oscillator*, July 1946, pages 40–41.
- <sup>55</sup> *Supra*, page 36.
- <sup>56</sup> Kuttner and Plunkett, *op. cit.*, page 10.
- <sup>57</sup> *Ibid.*, page 1.
- <sup>58</sup> "Binaural Recordings Add New Dimension to Recorded Music," *Electrical Engineering*, December 1952, page 1156.
- <sup>59</sup> Cook's semantics are incorrect according to Olson's definitions; *supra*, page 19.
- <sup>60</sup> Norman R. Crowhurst, *Stereophonic Sound* (New York: John F. Rider Publisher, Inc., 1957), pages 62–63.
- <sup>61</sup> "Chronology of Magnetic Recording," *op. cit.*, page 26.
- <sup>62</sup> Mark Mooney, Jr., "The History of Magnetic Recording," *Tape Recording*, February 1958, page 35.
- <sup>63</sup> C. E. Smiley, quoted in *ibid.*, pages 35–36.
- <sup>64</sup> *Ibid.*, page 36.
- <sup>65</sup> Kuttner and Plunkett, *op. cit.*, page 10.

## stereophonic sound on film

**T**HE first public demonstration of stereophonic sound in conjunction with motion pictures was at the fall, 1937, convention of the Society of Motion Picture Engineers in New York City. The demonstration was given in the auditorium of the Bell Telephone Laboratories. A special motion picture had been shot and recorded with twin audio tracks located side by side (Fig. 301), which were reproduced through separate channels by loudspeakers located at the sides of the screen.<sup>1</sup>

All motion pictures since the advent of sound had been equipped with a single sound source, usually a speaker in the center of the screen and behind it on the stage. There was no acoustic illusion of sound movement from one side of the screen to the other. As a result, the ears of the listener became trained to “pull” the sound the necessary distance sidwise, to make it appear to come from the visual image of its source. With stereophonic reproduction, this mental strain was relieved, since the sound of its own accord moved to follow the image of its source. Stereo implies localization and depth. It also gives a marked improvement in quality and in the sense of direction. From a commercial standpoint, the Bell engineers thought the latter property at least as important as the first.<sup>2</sup>

Some interesting notes on the use of the equipment were given by engineer Maxfield:

This development of stereophonic recording has formed a natural part of the general developmental work carried on for the purpose of improving the quality of talking pictures. Whether or not it will ever be adopted by the motion-picture industry depends upon the motion picture producers. It is certain, however, that to obtain the full, ultimate illusion of reality it will be necessary to combine with a colored stereoscopic picture, stereophonic sound.<sup>3</sup>

The film recording was done with a four-ribbon light valve, one pair of ribbons being actuated by current from the microphone at one side of the stage, and the other pair by current from the other microphone. The loudspeakers were located behind the screen at either side of the center.<sup>4</sup>

The first scene of the experimental film showed a symphony orchestra of about 40 or 50 players. The nature of the musical selection was such as to permit noting from which section of the orchestra the sound emanated. The next scene was a ping-pong game, with the ball easily placed even with the eyes shut. It was reported that at one point, when the ball bounced from table to floor and out of the picture, the ball could still be followed as it bounced repeatedly upon the floor.

The final scene of the film began in an almost pitch-dark room. The sounds of an actor entering the room and moving about in it, colliding with furniture, could be heard. His conversation with a companion sounded from various parts of the room as the two moved about. Toward the end of the scene, a third actor entered the room, turned on the lights, and permitted the audience to correlate positions of images on the screen with their previous sounds.<sup>5</sup>

J. I. Crabtree, engineer from Kodak Park, Rochester, N. Y., had this comment on the film showing:

The industry owes a debt of gratitude to the Electrical Research Products, Inc., and particularly to vice president Knox for his pioneering experiment. It was more than 10 years ago that Dr. Steinberg demonstrated to me in the Bell Laboratories the astonishing dramatic effects attainable by binaural sound reproduction. Ever since, I have been looking forward to the time when such effects would be applied to the motion picture. . . . Novelty is what the film industry is lacking at the present time. . . . It would seem as if the large exhibitor should be looking for some novelty that would enable him to put on a better show than the little fellow.<sup>6</sup>

Crabtree's final statement could not be more fitting today. In reference to the need for higher-fidelity reproducing equipment in the theaters along with the stereophonic systems, Crabtree

mentioned the opinions of the Bell engineers about lower-fidelity stereo being better than highest-fidelity mono. He said the frequency range in theaters should not have to be increased to gain a rather large dramatic improvement with stereo reproduction.<sup>7</sup>

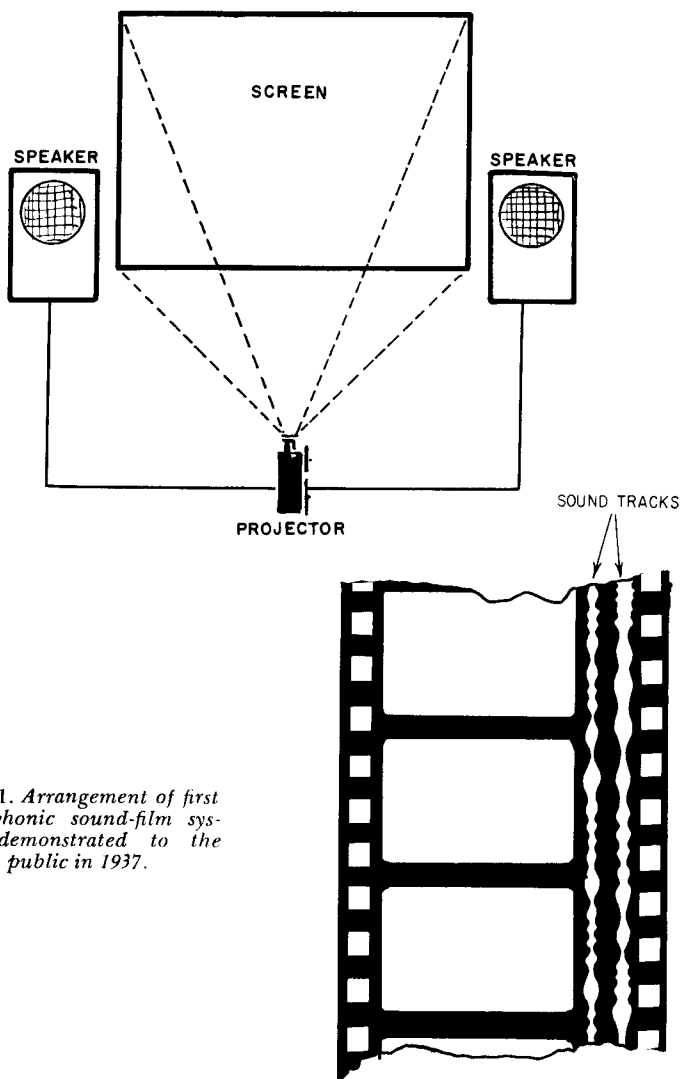

Fig. 301. Arrangement of first stereophonic sound-film system, demonstrated to the public in 1937.

The references to stereoscopic motion pictures made by Maxfield may be explained by the work being done on this method of motion pictures, along with the work on stereophonic sound for film. The first large-scale public exhibition of a 35-mm stereo-

scopic motion picture with excellent picture quality took place at the 1939 New York World's Fair. Five million people saw a stereoscopic film produced by John A. Norling.<sup>8</sup> The interests in stereo sight and sound supported one another.

### **The Bell Stereo Film System**

The Bell Laboratories' Stereo Sound Film System, or SSFS, resulted from years of Bell research going back to the 1920's. According to Harvey Fletcher, who played an important role in the development of SSFS:

If we design the system to handle any kind of sounds that the ear can hear and tolerate, then the limits of frequency and intensity are set by the hearing characteristics of a typical group of listeners. It was this ambitious objective that was set for the SSFS.<sup>9</sup>

During 1939 and 1940, the Bell engineers made a survey of the hearing capabilities of persons in a typical population as they visited the Bell System exhibits at the World's Fairs in San Francisco and New York. Records of the hearing of more than a half-million persons were analyzed. The record was expressed as a relative hearing loss or gain with respect to an arbitrary reference. The results indicated it was undesirable to reproduce sounds of greater than 120 db intensity for a general audience. When the frequencies were below 200 or above 6,000 cycles, the lowest levels that could be heard by the average person in a group were determined by the hearing mechanism, but when the sounds were between 200 and 6,000 cycles, the primary factor was the room noise.<sup>10</sup>

The previous experiments in long-distance stereophonic hook-up between Philadelphia and Washington in 1933<sup>11</sup> were used as the basis for the new film stereophonic system. The main difference was that the transmission line was replaced by a time-delay or storage system. The amplified microphone current, instead of flowing into the transmission line, was translated into a physical record which could later be retranslated into a facsimile of the original recording current. Film was used because at that time the photographic sound film was further advanced in its development than were other media.<sup>12</sup>

The amplified current from each microphone was led to a variable-area sound track on a 35-mm sound-picture film having four such tracks. (See Fig. 302.) A variable-area sound track was used because it gave greater volume range than the other process, variable-density. However, the maximum signal-to-noise ratio on the variable-area track was still only 50 db, whereas the range

called for was 80 db. This was based on measurements of the maximum intensity level of a full symphony orchestra, which proved to be on the order of 78 db. The 80-db signal which might arrive during loud sections was compressed to fit the 50-db limit of the track, and then it was expanded an equal amount in reproduction.<sup>13</sup>

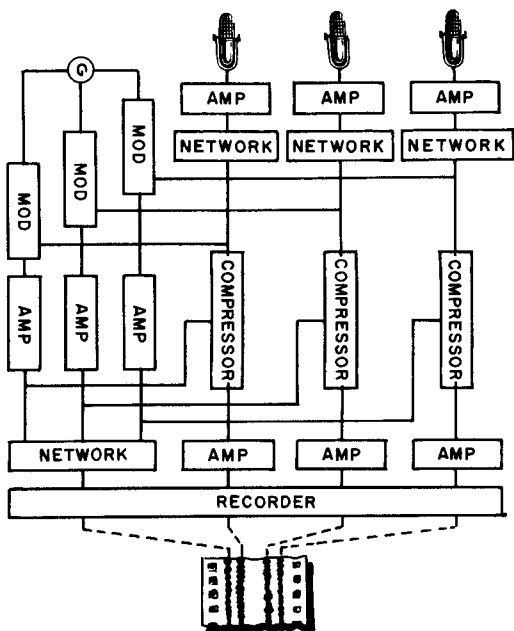

Fig. 302. Schematic diagram of stereophonic recording circuits. (Journal of the SMPE.)

The desired result was achieved in this way: When the signal which was to be recorded exceeded the range of the film, it generated a control current at a generator (Fig. 302) which increased in amount as the excess value of the signal above 50 db increased. The signal recorded on the sound track was kept at the maximum value which the sound track could take, and the control current was modulated with a carrier frequency and recorded on the fourth sound track. The other two channels had different carrier frequencies. When the film was reproduced, the control currents were selected by suitable filters (Fig. 303) and applied to the reproducing amplifiers, where they controlled the output in such a manner that the loudspeakers reproduced the sound at the microphones.<sup>14</sup>

This compressor-expandor device was dubbed the "compan-



dor." Selected oscillator tones were used on the pilot or fourth track to carry the gain-adjusting information.<sup>15</sup> Noise was a great problem, and practically every piece used in the SSFS had to be redesigned to reduce noise and distortion. This was necessary because the stereophonic system's frequency range was nearly twice that of the standard motion-picture sound track range (8,000 cycles) of the time.<sup>16</sup>

It was considered desirable to include the previously used "enhancement" feature again so that the music, upon re-recording, could have additional interpretations added by modifying the intensity or frequency composition, or both, of any or all channels. A control box was incorporated for the musical director to use, and the dynamics could be raised or lowered by him as desired.<sup>17</sup>

Naturally, as the music level was raised and lowered, the noise level on the film was also raised and lowered with it. To cut down the noise, a predistorting network was introduced into each channel which made it possible to record high frequencies at greater amplitudes than normal to overcome noise. When the film was reproduced, restoring networks cut the intensity of these high frequencies by the same amount they were raised in recording, thus at the same time lowering the film noise in these high-frequency regions.<sup>18</sup>

The completed experimental SSFS covered the frequency range of 20 to 14,000 cycles without the introduction of any audible amount of distortion.<sup>19</sup> The demonstration of the finished system was given on April 9, 1940.<sup>20</sup> During the summer of 1941 another complete SSFS was built for Electrical Research Products, Inc., by Bell Laboratories. Commercial equipment was used throughout this system except for the pilot and compandor devices, which were not available as standard articles. Even better specifications than the first system were the result.<sup>21</sup>

## **Fantasound**

At the same time that Bell Laboratories were working on their experimental system of stereophonic film sound, Hollywood technicians were busy with a commercial application of almost the same sort. Walt Disney Studios and the Radio Corporation of America worked 3 years at their system, which was called "Fantasound." It was developed to accompany the new Disney film, "Fantasia."<sup>22</sup> William E. Garity and J. N. A. Hawkins, two of the engineers, gave their reasons for the development of Fantasound:

. . . we must take large steps forward, rather than small ones, if we are to inveigle the public away from softball games, bowling alleys, nightspots, or rapidly improving radio reproduction.

The public has to *hear* the difference and be *thrilled* by it, if our efforts toward the improvement of sound-picture quality are to be reflected at the box office. Improvements perceptible only through direct A-B comparisons have little box-office value.

. . . some deficiencies of conventional sound-picture reproduction may be summarized:

- (a) Limited volume range . . .
- (b) Point-source of sound . . .
- (c) Fixed localization of the sound source at screen center . . .
- (d) Fixed source of sound . . .

It is felt that Fantasound provides a desirable alternative to the four major deficiencies.<sup>23</sup>

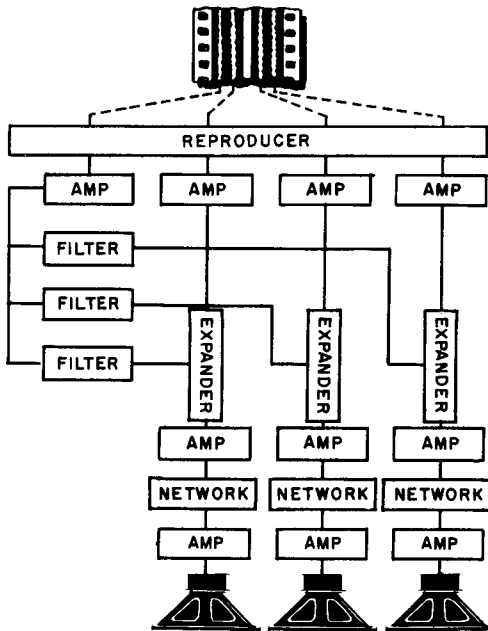

Fig. 303. Schematic diagram of the stereophonic reproducing circuits. (Journal of the SMPE.)

During the work leading up to Fantasound, 10 systems were actually constructed and tried out, and development did not stop with the release of "Fantasia." All numbers in the film except the *The Sorcerer's Apprentice* and the choral section of *Ave Maria*, were scored at the Philadelphia Academy of Music, by now traditional home of stereophonics. The Philadelphia

Orchestra, conducted by Leopold Stokowski, was recorded by eight separate film-sound channels. The first six channels (Fig. 304) recorded close microphone pickups of various sections of the orchestra. The seventh channel recorded a mixture of the first six, and the eighth channel recorded the entire orchestra with distant microphoning.<sup>24</sup>

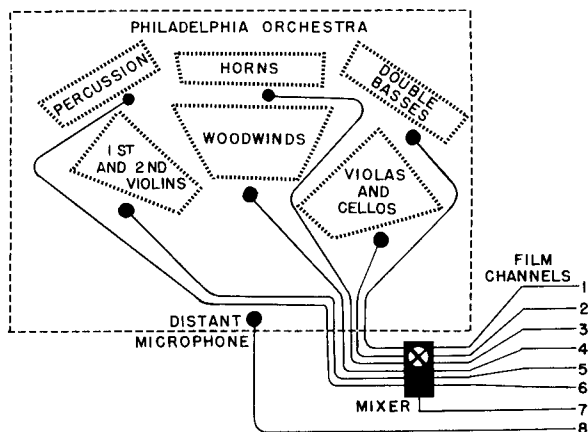

Fig. 304. The stereophonic recording arrangement used for "Fantasia".

The roadshow of "Fantasia" used eleven 62-inch racks of amplifiers, plus the power supplies and associated equipment. It packed into 45 cases weighing an average of 330 lbs a case, and took up half of a standard freight car.<sup>25</sup> At first, a mixing engineer went along with the film and operated manually the volume range expansion equipment as well as controlled the perspective effects. But the five controls became rather complex for one-man operation and, due to the human element, it was difficult to keep all the shows exactly alike. "Togad" came about to solve these problems. The word stands for "tone-operated gain-adjusting device." Just as in the Bell system, it was operated by tones on a fourth track of the film.<sup>26</sup>

For each group of loudspeakers there was a separate source of sound synchronized with the picture on the screen. When Mickey Mouse, for example, in *The Sorcerer's Apprentice*, appeared on the right, Togad switched on the loudspeaker directly behind him and veered the sound to another speaker when he moved. During recording, an extra track was dubbed on phonograph records to give the beat, entrance cues and other effects to guide

SPEAKERS OPERATED BY STANDARD SOUND TRACK

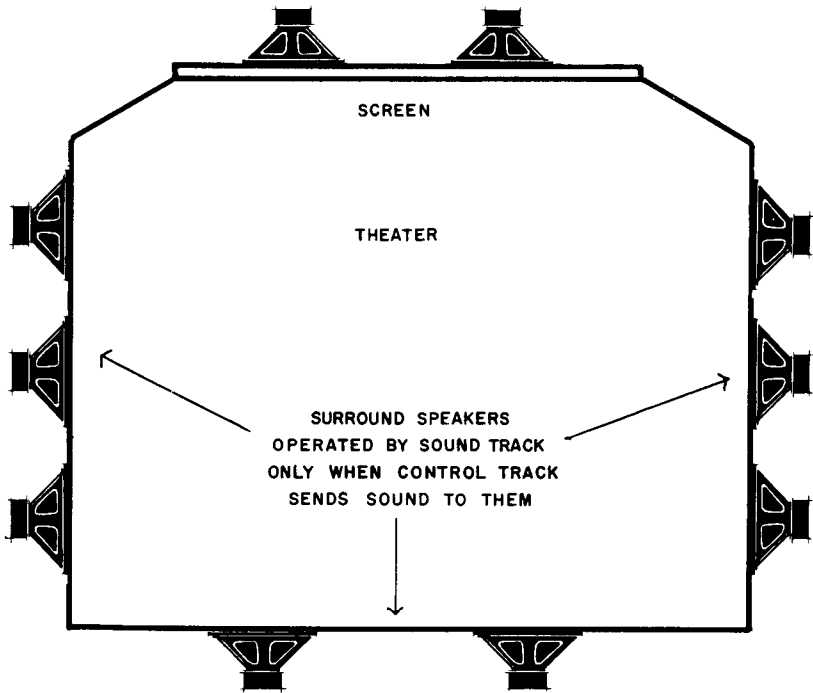
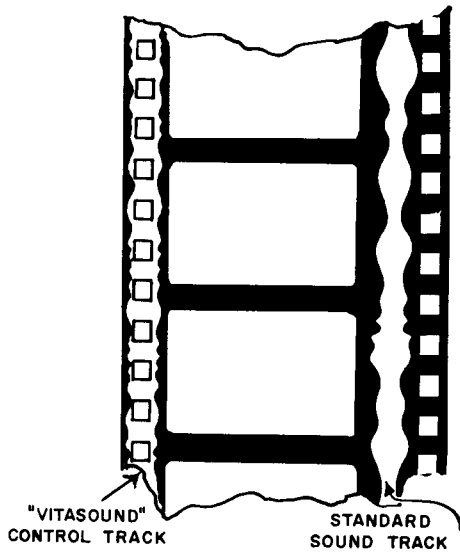

Fig. 305. The "Vitasound" system developed by Warner Brothers.



the animation cartoonists. Each sound track could be blended in any way with any other track. According to its inventors, the process of Fantasound succeeded "in taking music and sound out of its customary accessory role in the theater and elevating it to a position as an important tool in the hands of a dramatist."<sup>27</sup>

### **Other new film-sound processes**

Other processes for more realistic film sound were being experimented with at this time. A committee comprised of members of the various Hollywood studios had been set up under the Academy of Motion Picture Arts and Sciences and was studying the various systems with a view to standardizing one of them for general industry use.<sup>28</sup> Two of the most important features that would be needed for more enjoyment and realism in the sound were thought to be an increased volume range and a more widespread source of sound for music and effects reproduction.<sup>29</sup>

There are generally two types of material on the sound track: dialogue and music effects. The first is produced by approximately a point source, while the second is of a much larger area. The orchestra and effects sound "squeezed" when reproduced through the single theater loudspeaker. Warner Brothers' solution to this was heard in the 1937 film *The Eternal Road*. There were individual channels for the orchestra, choruses and soloists. The orchestra sections had no localization, but they were reproduced through a number of loudspeakers extending across the screen and the "spread" gave the impression that the orchestra actually filled the auditorium.<sup>30</sup>

A simpler version of this arrangement was called "Vitasound" and consisted simply of a control-track printed in the sprocket-hole area of the release print, which operated a variable-gain amplifier and loudspeakers (Fig. 305) spaced strategically around the theater.<sup>31</sup> This was particularly effective for spectacular sound-effects scenes, and was used for the earthquake in *San Francisco*, the avalanche in *Lost Horizon* and the battle in *The Sea Hawk*.<sup>32</sup> This process is not stereophonic, for it makes no attempt to provide sound motion within the screen area, or localization of the sections of the orchestra. Several Warner Brothers' pictures were released as standard type prints with the sprocket-hole track providing the multi-speaker reproduction. Of course, if the theater did not have the Vitasound equipment, the regular film track would still be reproduced in the standard manner.<sup>33</sup>

In "Fantasia," this method was combined with stereophony.

Either effect was used for a particular number, depending on the effect desired. In the *Ave Maria* selection, multiple speakers were installed along the sides and back of the New York theater, and the sound from each of the side-screen sound tracks was reproduced along the entire corresponding side of the theater rather than from the stage alone.<sup>34</sup>

These early attempts at stereophonic presentation in the theater were made before the advent of magnetic recording, or at least before modern adaptation of it by use of magnetic oxides on an acetate base. Consequently, the only way to record the extra sound tracks was to use the optical means mentioned earlier.<sup>35</sup>

These optical tracks could reproduce the desired range of sounds only with the aid of the complex compandor equipment and pilot track. Due partly to this complexity, Fletcher's system and Fantasound never achieved success at this time. Also, the motion-picture industry was apathetic about changing over to an entirely new medium of sound presentation in theaters.<sup>36</sup> The exhibitor's problems with the multi-track optical sound were many. The projectors installed in the average theater had sound heads located in the correct position for standard tracks. Presenting the stereophonic material, which had additional sound tracks located somewhere else on the strip of film, required the addition of extra sound heads in the projector. Usually this meant the installation of a new section of the projector to replace the old sound-head section, an expensive operation.<sup>37</sup>

The advent of magnetic tape recording after the war made possible the application of the magnetic oxide to the actual movie film. This was done after the printing of the picture on the film by a process called "striping." Then the sound, which could have been originally recorded on either tape, magnetic film or optical film, was "printed" on the stripe by a magnetic-recording process. By analogy with the older optical method, the word "printing" has continued in use, although it does not apply in a literal sense. The striping process has its problems. It is difficult to get one reliable magnetic stripe on the film, let alone four. They are likely to flake off or wear easily, because they are very narrow compared to the regular 1/4-inch tape used for home recording.<sup>38</sup>

Due to the narrow tracks, the dynamic range is not great. It can sound deceptively good in a stereo system by keeping the volume level as constant as possible. The compatibility problem here is solved easily, for the magnetic section simply clamps on the top of the standard projector. In this position it does not

interfere with the regular functioning of the projector on optical tracks, and the switchover is accomplished by electrical means. The pickup section is called a "penthouse," because of its position on top of the projector.

When the film is new and oxide tracks are in good operating condition, and the heads in the penthouse are new also, the quality is excellent. Unfortunately, this quality does not maintain well. The heads are worn by the crocus-cloth action of the stripping oxide, the oxide wears off the film and the quality goes down. This defect occurs to a much smaller extent with optical tracks. Regular replacement of the penthouse heads is recommended by the manufacturer but many exhibitors overlook this, and the magnetic stereophonic systems continue operating under inferior conditions and the excellent technical resources put into the original film sound track in Hollywood are not heard by the audience.<sup>39</sup>

The new interest in stereoscopic motion pictures which began with *Bwana Devil* in the early 1950's aroused interest in a matching stereophonic sound track. In Norman McLaren's stereoscopic film, *Around Is Around*, it was decided to give the sound direction to match the added depth of the picture. The designers of the Telecinema, Great Britain, introduced stereophonic sound to complement stereo sight. Four magnetic sound tracks on a separate piece of 35-mm film were synchronized with the projector and fed to four groups of loudspeakers, one behind the screen, one each at left and right corners of the screen, and one at the back of the auditorium. A stereophonic mixing console right in the auditorium controlled the presentation. It required "the skill of a virtuoso pianist playing a Liszt concerto." Louis Applebaum, who wrote the music for the film, was impressed by the new medium:

Stereophonic sound . . . becomes a valid and useful dramatic device, and orchestral balance can be achieved through space, as well as by tonal weight. . . . The more I think of it the more numerous are the possibilities.<sup>40</sup>

However, it took a strong attack upon the movie industry by another medium to bring stereophonic sound to the film-going public. According to Julius Postal of the Audio Engineering Society:

It is well known that the motion-picture industry became actively interested in these [stereo] systems and devices only with the advent of widespread home television.<sup>41</sup>

## **Cinerama and CinemaScope sound**

The first Cinerama film in 1952 began the new interest in stereo film-sound tracks. Five (and later seven) magnetic tracks were used on a separate 35-mm film to produce the stereo effect. In 1953, a three-channel stereo system, also on separate film, was used as an adjunct to the new 3-D movies. Often the effect was no more than a pseudo-stereophonic one, because the studios didn't have time to develop the techniques of on-stage stereo recording, and most of the dialogue was moved across the screen (Fig. 306) by pan-potting<sup>42</sup> an original single-channel sound track. The music pickup was often better than this, but even there "enhanced" monaural recordings were sometimes used.<sup>43</sup>

The first attempt at stereophonic sound on a composite 35-mm film for commercial use was the new CinemaScope process introduced in 1953 at 20th-Century Fox studios. Four magnetic stripes were put on the composite release print, three of them for the stereo effect at the screen and the fourth for auditorium sound effects.<sup>44</sup> The entire production of the film *The Robe* was recorded on a true stereophonic basis.<sup>45</sup>

In the meantime, other motion-picture studios have produced many pictures in CinemaScope, but in most cases the dialogue cannot be classed as stereophonic since it was mainly derived by pan-potting the original single monaural track.<sup>46</sup>

## **Perspecta**

The Cinerama and CinemaScope systems are noncompatible. (For a definition and description of compatibility see page 121.) The Perspecta sound system, introduced in 1954, is compatible. A single monaural sound track contains three subaudible control frequencies which make it possible to move sounds across the screen in much the same manner as pan-potting with the CinemaScope system.<sup>47</sup> The channels not in use during a solo performance on one speaker are reduced to a level sufficiently below the one being used not to be heard at all. On other occasions the single-channel sound track can be applied to the other speakers in varying combinations of intensity so as to achieve many special effects. The control frequencies of 30, 35 and 40 cycles are recorded at a level 20 db below the peak audio level so that they will not be audible when the film is played on an ordinary system. When played on a Perspecta-equipped system, special filters remove these frequencies from the reproduction train. They are separated, amplified, rectified and then used to control variable-gain stages feeding the three separate-channel speakers. A great deal of



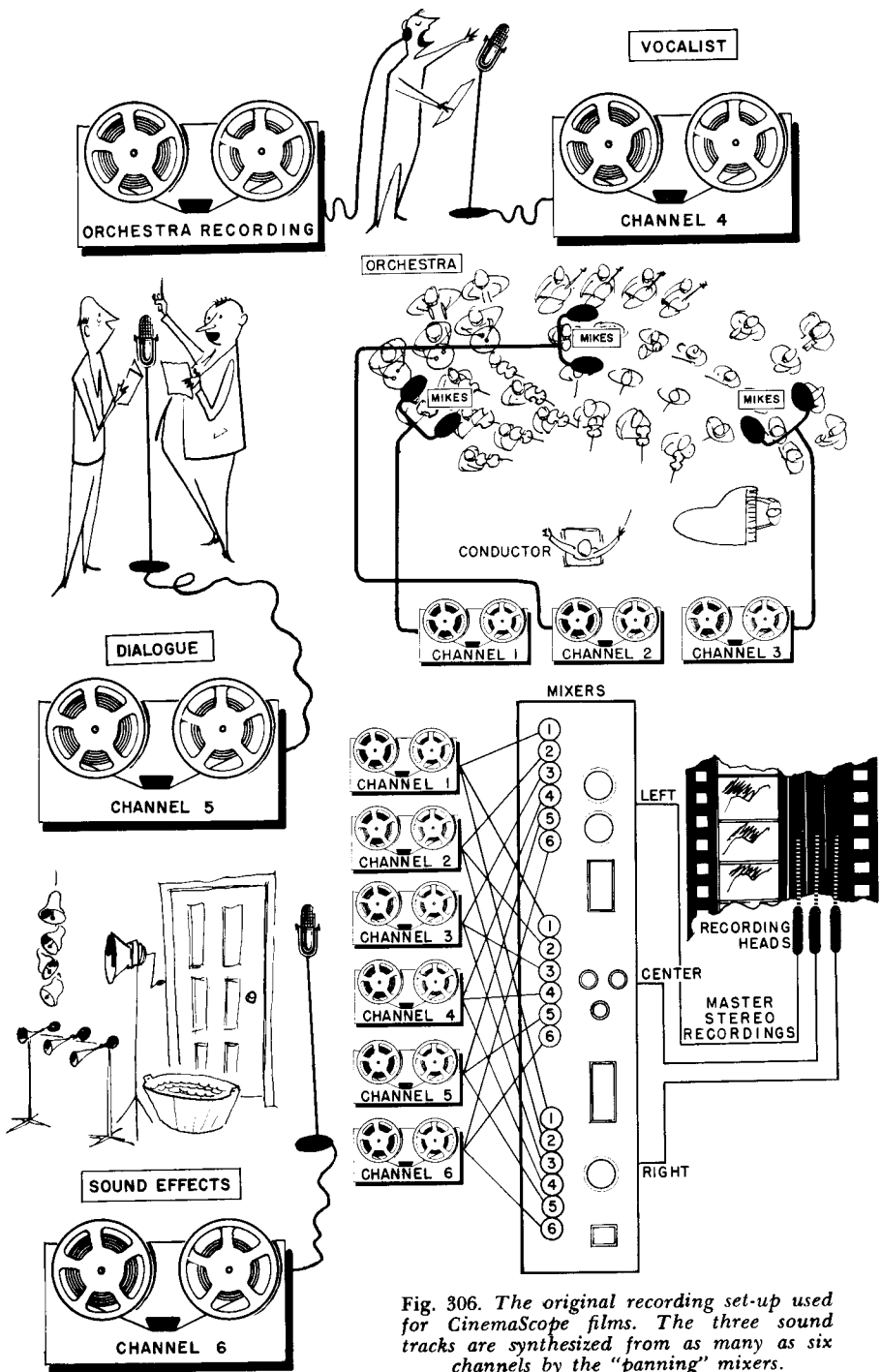

Fig. 306. The original recording set-up used for CinemaScope films. The three sound tracks are synthesized from as many as six channels by the "panning" mixers.

expense in recording is saved with Perspecta, because only one channel is used.<sup>48</sup>

The system even includes a relay that automatically switches from single-channel presentation over the single center speaker to three-channel presentation over three separate speakers, when the Perspecta coding signal comes on. This relieves the projectionists of responsibility for changing over connections according to what sort of film is being run. It is even possible to splice sections of film having single-channel and Perspecta sound tracks into the same reel, and the system will automatically switch from one to the other as soon as the sound track changes.<sup>49</sup>

Perspecta has its limitations, however, because it is not true stereophonic reproduction. It cannot give simultaneous directional identity. It functions for one sound for one position at a time, and therefore all sounds that occur simultaneously move together to whatever position for which the controls are set at the particular time.<sup>50</sup> Since in a large theater all sense of direction is more dependent upon relative intensity from the different channels than it is upon phase differences, Perspecta still gives a fairly realistic effect. As the coded stereo system depends entirely upon intensity variations, this enables it to exploit this difference to at least as good advantage as the regular multichannel stereo.<sup>51</sup>

Another advantage is the fact that the system enables further noise reduction by use of the coding frequencies. The three channels can be turned down to lower levels when not being used, or turned completely off. Therefore, the background noise is turned down along with the program sound and better quality results.<sup>52</sup>

### **An optical-track system**

Another compatible stereophonic system for films is described by John Frayne, its inventor. Called the Photo-Stereo process, it uses only two separate tracks, which are optical instead of the prevalent magnetic type. The two tracks, which may be either variable-density or variable-area, are placed side by side in the normal position for a standard 100-mil sound track. The optical tracks are separated by a 4-mil space and reproduced by an optical sound head similar to the standard push-pull type with the exception of the lens, which in Frayne's process operates the component light beams through a split lens. On wide-screen presentations, a third bridged or "phantom" channel may be added easily.<sup>53</sup>

Satisfactory reproduction can be obtained from Photo-Stereo

with the two tracks in the standard track position and played on a standard projector. During the film demonstration before the Society of Motion Picture and Television Engineers, a re-enacted scene from Samuel Goldwyn's *Best Years of Our Lives* and an orchestral rendition of the overture to *The Barber of Seville* were presented.<sup>54</sup> Attending engineers complained of the noise level. Frayne said that it was due to the narrowness of the optical tracks on the release print. He went on to suggest that high-quality optical tracks would be possible only if the industry was really interested in improving them:

(Let us) first analyze the difference between magnetic and photographic recording. Magnetic tracks are considerably quieter than photographic and they have a somewhat better high-frequency response for the same film velocity. When it comes to flutter, photographic has at least a theoretical advantage in that the problem of pulling a film over a fixed gate is eliminated. One of the big advantages in magnetic is that each print is an electric transfer from a master. In photographic, the positive sound track is made by contact printing from a negative — a process which is known to result in high-frequency losses, in increased flutter and amplitude modulation. If each print were made by a direct-positive transfer, then we should have a much improved optical print. . . .

The original reason for using magnetic on CinemaScope was not because it was magnetic but because it enables you to record and reproduce more tracks. . . . it seemed extremely difficult to put four optical tracks on a film and reproduce them in the theater. . . . It would be difficult to modify all of the various types of sound heads in the world and it would be extremely difficult to agree on a standard.<sup>55</sup>

## **Recording film sound**

Regardless of which of the systems is used to carry the stereophonic sound in the final release print, the method of producing the ultimate program that will be heard from the film is very much the same. The studios usually make at least six separate master sound tracks from which the composite final result is made. This is done even with nonstereo motion pictures for better control of sound. The musical track is usually recorded with three separate channels. This enables balances to be adjusted during a re-recording according to the effect the director desires to be associated with a certain image on the screen.<sup>56</sup>

If there is a soloist in the musical score, this will require another track. Then, adjustment of volume and spacing between orchestra and soloist can be adjusted to match the changes of viewpoint presented by editing the camera's views. Another track is

needed for dialogue. Finally, all sorts of special effects are needed, and these require at least another sound track.

In making the final composite for stereophonic release, all the tracks are mixed in different proportions onto the separate final tracks, and sounds may be moved around by the pan-potting process.<sup>57</sup> A device has been patented which allows complete control of the apparent direction of a sound in the track of a stereo motion picture. The direction may be different in the final release print from that in the original recording. The device uses a pan-pot with movable output taps.<sup>58</sup> (See Fig. 306.)

### **Stereo sound and the exhibitor's problem**

The film industry's acceptance of the stereophonic systems has not been overwhelming. At the 1956 SMPTE convention in Los Angeles, Fred R. Wilson of Samuel Goldwyn Studios said:

In view of the latest developments in sound such as stereophonic recordings losing favor with the exhibitors and passing over other technological methods at our disposal to improve the quality of sound, it seems to me that the only future progress is in a method or means of producing sound more cheaply. . . .<sup>59</sup>

Loren L. Ryder developed this point in regard to stereo:

In my opinion there are two things wrong with this process — first, the cost has been too great and, secondly, stereophonic sound handling either limits or accentuates editing. Editing in motion pictures is used as a system of gaining story progression and a good editor is a man who can edit the picture in a manner so that the audience is not conscious of the cuts. In my opinion, the use of stereophonic sound as it has been handled largely tends to punctuate the cuts — it tends to emphasize the very thing that the experienced editor is trying to eliminate . . . this is one of the reasons, in addition to the economic reason, that we at Paramount have not used stereophonic sound.<sup>60</sup>

However, many improvements are being made, and the added attraction of being able to offer stereophonic sound to its patrons usually seems worth the effort to larger exhibitors. The drive-in theater audience can even share the effect with a recent loudspeaker assembly. In this stereophonic loudspeaker for automobile use, one speaker aims straight out to provide the center channel, while speakers at the sides aim at the curved inside surface of the windshield to provide the side channels.<sup>61</sup>

A development of engineer Bruce P. Bogert makes it possible, by inserting a small time delay in one channel of the stereo system, to reduce the power capability of the other sound-producing channels. This enhancement is a result of the Haas effect.<sup>62</sup> Haas'

studies concerned the intelligibility of speech with various time delays between the direct sound and an echo. When the delay was small, the apparent source was the direct one, and the delayed source did not appear to be operating, except that it contributed to the overall loudness. The delayed source (Fig. 307) was found by Haas to be capable of being increased to as much as 10 db more than the direct source before the delayed source was perceptible as such.<sup>63</sup>

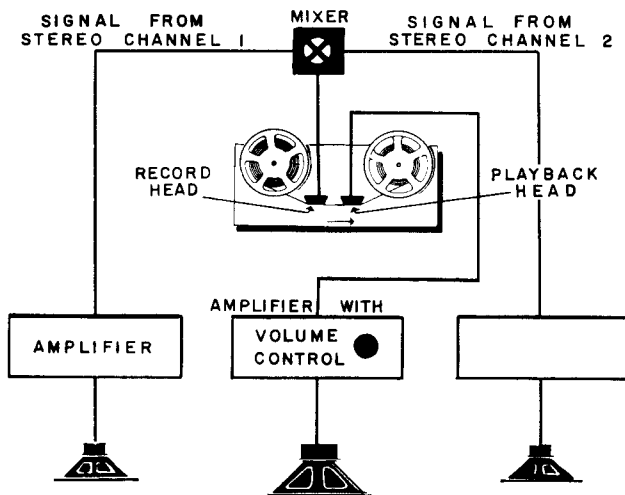

Fig. 307. The Bogert system, using time-delay to reduce the power requirements of the side channels in relation to the center channel.

Bogert used a two-channel stereo system. The signals of the left and right channels were combined, delayed from 10 to 35 milliseconds and fed to a central loudspeaker with this delayed composite signal, all in addition to the regular stereophonic channels on either side. The effect of the additional centrally located source increased the sound level in the auditorium without greatly altering the spatial localization due to the stereophonic effect.

A two-track magnetic tape recorder was used as the source, fed to speakers on the left and right, with the combined signal fed to another tape recorder for the delay. This machine operated at a speed of 60 inches per second, recorded on one magnetic head and reproduced from another head 34.5 milliseconds later. The delayed output was then fed to the power amplifier driving the center speaker. The level of this center channel could be increased

up to 8 db more than the left and right speakers before it was noticed. When the delay was increased greatly or the volume of the center speaker turned higher, the sound appeared to come from the center speaker only.<sup>64</sup>

The greatest usefulness of this device would be in theaters where centrally located speaker systems of adequate power capacity already existed. To add two-channel stereo, right- and left-hand speakers and amplifiers of smaller power-handling capacity, and therefore lower cost, could be added. Then only a method of delay for the center signal would be needed to complete the low-budget system. The compatibility of the plan is stressed by Bogert:

If . . . the film used two sound tracks, side by side, then a sound pickup unit could contain the two photocells for the right and left tracks, and a third photocell, which scanned both tracks, spaced sufficiently far behind the other two to provide the required delay. If a standard sound track were played, the third photocell would act as the regular sound pickup means, and the right and left speakers would not change the illusion that the sound was centrally located as in an ordinary system.<sup>65</sup>

Stereophonic equipment is slowly being standardized, and the Motion Picture Research Council has specified such things as sound-track dimensions and positions, loudspeaker locations relative to the screen and the mounting of reproducing heads. The standardization of drive mechanisms is in sight, and several types of Altec-Lansing theater loudspeakers are already standard for stereophonic reproduction.<sup>66</sup> The use of stereophonic tracks on the same film as the picture seems destined to become the standard. New methods of constructing multiple-track magnetic heads have resulted in improved crosstalk reduction and in greater sensitivity.<sup>67</sup>

The understanding of how the film industry achieves stereophonic reproduction will be of use in the next chapters dealing with the home music systems. The problems associated with reproduction in large places, such as theaters and auditoriums, are often just the opposite of those encountered in reproducing sound in small spaces, such as the home.

### **Other stereo mediums**

Before continuing, let us consider here, between discussion of stereophony on film and stereophony on tape, two other possible stereo mediums. The first of these is wire recording. This form of magnetic recording was very popular before magnetic tape took its place. Its only use today is in ultra-miniature pocket recorders.

Tape is so much more manageable and of so much better quality that wire has become all but obsolete. It is much too difficult to handle, and recording two stereo tracks on it would be next to impossible.<sup>68</sup>

The second medium employs optical sound-track playback, but not optical recording. The recording is achieved by means of a wide-angle diamond cutter closely resembling a "hill-and-dale" disc cutter. The film base is transparent plastic acetate coated with a black layer. The wide-wedge cutter plows into the plastic and removes a variable area of the black layer. It can be clearly seen and reproduced. With this system, photographic processing is unnecessary, and the cost of the cutter head is lower than the complete optical system necessary to produce optical recordings. If used for a home system, standard optical recordings could be played equally well by the playback machine. This engraving system was used regularly by Glen Glenn Sound Studios in Hollywood for the Desilu Production TV films *I Love Lucy* and *Our Miss Brooks*.<sup>69</sup>

## Bibliography and References

- <sup>1</sup> J. P. Maxfield, "Demonstration of Stereophonic Recording with Motion Pictures," *Journal of the SMPE*, February 1938, page 131.
- <sup>2</sup> *Ibid.*
- <sup>3</sup> *Ibid.*, page 132.
- <sup>4</sup> *Ibid.*, page 133.
- <sup>5</sup> *Ibid.*
- <sup>6</sup> Cited in Maxfield, *ibid.*, page 134.
- <sup>7</sup> *Ibid.*, page 135.
- <sup>8</sup> John A. Norling, "The Stereoscopic Art," *Journal of the SMPTE*, March 1953, page 287.
- <sup>9</sup> Harvey Fletcher, "Stereophonic Sound Film System — General Theory," *Journal of the SMPE*, October 1941, page 334.
- <sup>10</sup> *Ibid.*, pages 335, 336.
- <sup>11</sup> *Supra*, page 38.
- <sup>12</sup> Fletcher, "Stereophonic Sound-Film System — General Theory," *op. cit.*, page 337.
- <sup>13</sup> *Ibid.*, page 338.
- <sup>14</sup> "Stereophonic Sound Film System," *Journal of Applied Physics*, January 1942, pages 32–33.
- <sup>15</sup> Harvey Fletcher, "Stereophonic Sound Film System — General Theory," *Journal of the SMPE*, October 1941, pages 341, 344.
- <sup>16</sup> Harvey Fletcher, "Stereophonic Reproduction from Film," *The Bell Laboratories Record*, May 1940, pages 262, 265.
- <sup>17</sup> Fletcher, "Stereophonic Sound Film System — General Theory," *op. cit.*, page 349.
- <sup>18</sup> *Ibid.*, page 350.
- <sup>19</sup> *Ibid.*, pages 352.
- <sup>20</sup> Fletcher, "Stereophonic Reproduction from Film," *Bell Laboratories Record*, May 1940, page 361.
- <sup>21</sup> W. B. Snow and A. R. Soffel, "Electrical Equipment for the Stereophonic Sound Film System," *Journal of the SMPE*, October 1941, page 395.
- <sup>22</sup> "Fantasound for Disney Picture," *Science Digest*, January 1941, pages 92–93.
- <sup>23</sup> William E. Garity and J. H. A. Hawkins, "Fantasound," *Journal of the SMPE*, August 1941, page 127.
- <sup>24</sup> *Ibid.*, page 143.
- <sup>25</sup> A. A. McK., "Stereophonic Sound: Magnetic Tape Carrying Three Simultaneous Channels Gives a Striking Illusion," *Electronics*, August 1948, page 88.
- <sup>26</sup> Garity and Hawkins, *op. cit.*, pages 140, 143, 131.
- <sup>27</sup> "Fantasound for Disney Picture," *op. cit.*, pages 92–93.
- <sup>28</sup> H. I. Reiskind, "Multiple-Speaker Reproducing Systems for Motion Pictures," *Journal of the SMPE*, August 1941, page 155.
- <sup>29</sup> Nathan Levinson and L. T. Goldsmith, "Vistasound," *Journal of the SMPE*, August 1941, page 147.
- <sup>30</sup> Reiskind, *op. cit.*, page 155.
- <sup>31</sup> Levinson and Goldsmith, *op. cit.*, page 147.
- <sup>32</sup> Reiskind, *op. cit.*, page 156.
- <sup>33</sup> *Ibid.*, pages 154–156.
- <sup>34</sup> *Ibid.*, page 158.



- <sup>35</sup> Crowhurst, *op. cit.*, page 108.
- <sup>36</sup> John G. Frayne and E. W. Templin, "Stereophonic Recording and Reproducing Equipment," *Journal of the SMPTE*, September 1953, page 395.
- <sup>37</sup> Crowhurst, *op. cit.*, page 108.
- <sup>38</sup> *Ibid.*, page 110.
- <sup>39</sup> *Ibid.*, page 111.
- <sup>40</sup> Gerald Pratley, "The Latest 3-Dimensional Films," *Films in Review*, April 1952, pages 172-174.
- <sup>41</sup> Julius Postal, "Audio Aspects of the SMPTE 74th Convention," *Journal of the AFS*, April 1954, page 122.
- <sup>42</sup> Pan-potting: a single-channel signal is fed into multiple mixing panels leading to the stereo sound tracks; the signal then may be "moved" by manipulating the volume of the various controls.
- <sup>43</sup> John G. Frayne, "Compatible Photographic Stereophonic Sound System," *Journal of the SMPTE*, June 1955, page 303.
- <sup>44</sup> *Ibid.*
- <sup>45</sup> George R. Grovers, "Progress Committee Report," *Journal of the SMPTE*, May 1953, page 536.
- <sup>46</sup> Frayne, *op. cit.*, page 303.
- <sup>47</sup> *Ibid.*
- <sup>48</sup> Norman H. Crowhurst, "New Approach to Hi-Fi Stereophonics," *Radio & Television News*, August 1956, page 37.
- <sup>49</sup> Crowhurst, *Stereophonic Sound, op. cit.*, page 111.
- <sup>50</sup> Frayne, *op. cit.*, page 303.
- <sup>51</sup> Crowhurst, *Stereophonic Sound, op. cit.*, pages 111-112.
- <sup>52</sup> *Ibid.*, page 112.
- <sup>53</sup> Frayne, *op. cit.*, page 304.
- <sup>54</sup> *Ibid.*, page 308.
- <sup>55</sup> *Ibid.*, page 308.
- <sup>56</sup> Crowhurst, *Stereophonic Sound, op. cit.*, page 112.
- <sup>57</sup> *Ibid.*, page 114.
- <sup>58</sup> Robert W. Young, "Review of Acoustical Patents," *Journal of the Acoustical Society of America*, May 1958, page 498.
- <sup>59</sup> Loren L. Ryder, "Looking to the Future in Sound," *Journal of the SMPTE*, November 1956, page 584.
- <sup>60</sup> *Ibid.*
- <sup>61</sup> Young, *op. cit.*, page 497.
- <sup>62</sup> Karl Haas, "Uder den Hinflus eines Einfachechos auf die Horsaamkeit von Sprache," *Acustica*, I, 1951, pages 49-58.
- <sup>63</sup> Bruce P. Bogert, "Stereophonic Sound Reproduction Enhancement Utilizing the Haas Effect," *Journal of the SMPTE*, June 1955, page 308.
- <sup>64</sup> *Ibid.*, pages 308-309.
- <sup>65</sup> *Ibid.*, page 309.
- <sup>66</sup> John K. Hilliard, "Loudspeakers and Amplifiers for Use With Stereophonic Reproduction in the Theater," *Journal of the SMPTE*, September 1953, pages 380-389, *passim*.
- <sup>67</sup> Kurt Singer and Michael Rettinger, "Multiple-Track Magnetic Heads," *Journal of the SMPTE*, September 1953, page 390.
- <sup>68</sup> Crowhurst, *Stereophonic Sound, op. cit.*, page 69.
- <sup>69</sup> George R. Grovers, "Progress Committee Report," *Journal of the SMPTE*, May 1953, page 537. Cf. Crowhurst, *Stereophonic Sound, loc. cit.*

# stereophonic sound on tape

**T**HE second program medium we shall consider is magnetic tape. Of all media of recording, it is by far the simplest for multichannel work. It is possible to put as many tracks as wanted on the tape. All that is necessary is to record the individual channels in adjacent and parallel tracks across the tape, with pickup heads to match. One Air Force tape recorder has 28 channels for telemetering use.<sup>1</sup>

## Early stereo on tape

Early stereo tapes (Fig. 401) were recorded with “staggered heads.” This made it possible to convert an older machine to stereophonic reproduction merely by adding a second head spaced about 1–11/16 inches away from the first. The two channels were recorded on parallel tracks along the tape, with corresponding parts of the material staggered to correspond to the physical displacement of the two heads.<sup>2</sup>

The complexity and cost of theater and concert-hall stereophonic systems presented great problems when efforts were made to bring them into the home. The three main problems were:

- (1) The home listening room is much smaller.
- (2) The unit should be adaptable to various layouts of rooms, and
- (3) The cost of the home unit should be in the price range of an adequate number of consumers, and the tapes must likewise be priced within certain limits, so that demand will be adequate.

In 1958, tape and wire recorder specialist Marvin Camras was

already demonstrating an experimental system before the New York IRE convention that he said solved these problems. The three-channel stereophonic tape system claimed flat response within 5 db from 50 to 10,000 cycles, and a dynamic range of 60 db. The tape ran at a speed of 12 inches per second with less than 0.1% wow and flutter. All three of the heads were staggered. However, Camras said that comparisons between two- and three-channel reproduction indicated that two-channel gave a satisfactory simulation of realism.<sup>3</sup>

In August, 1952, General Electric Ltd. of Britain gave a demonstration of three-dimensional sound remarkably free from distortion. At the company's research laboratories at Wembley, the demonstration included high-fidelity stereophonic sound reproduced from "live" as well as multi-channel tape. According to observers, "it was evident from the demonstration that the quality of sound reproduction has been raised to a new level of realism. . . ."<sup>4</sup>

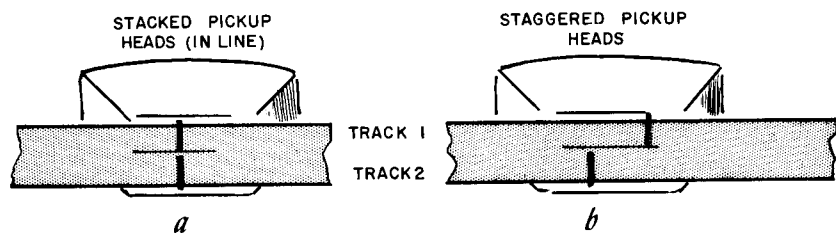

Fig. 401. (a) Stacked and (b) staggered stereo pickup heads. The staggered arrangement was used to facilitate conversion of mono tape recorders to stereo playback, but improved equipment and methods have made this system unpopular. Staggered tapes are no longer being manufactured.

The development of tape recording had finally reached the point where it provided the ideal medium for stereophonic recording, and many of the inexpensive dual-track recorders then available were easily adapted for two-track playback and in some cases, two-track recording. A separate new record and playback amplifier was added (Fig. 402) along with the extra pickup head.<sup>5</sup> In 1956, the V-M Corp. followed its previous introduction of a stereo conversion kit with built-in stereo playback for their new machines. Nortronics also made the first nonencapsulated stereophonic head, and RCA Victor offered stereophonic playback equipment and tapes, adding to the library already building up<sup>6</sup> from such companies as Magnecord, Audio-Visual and Audio Master Corp., in addition to Livingston Audio<sup>7</sup>

The disadvantages of records and film in difficulty of use and

expense were solved now, according to tape enthusiasts. James Moir thought that "the overall results obtained from two-channel stereophonic recording on tape are a greater step forward than was taken in introducing the LP record."<sup>8</sup> Two-channel tape recording

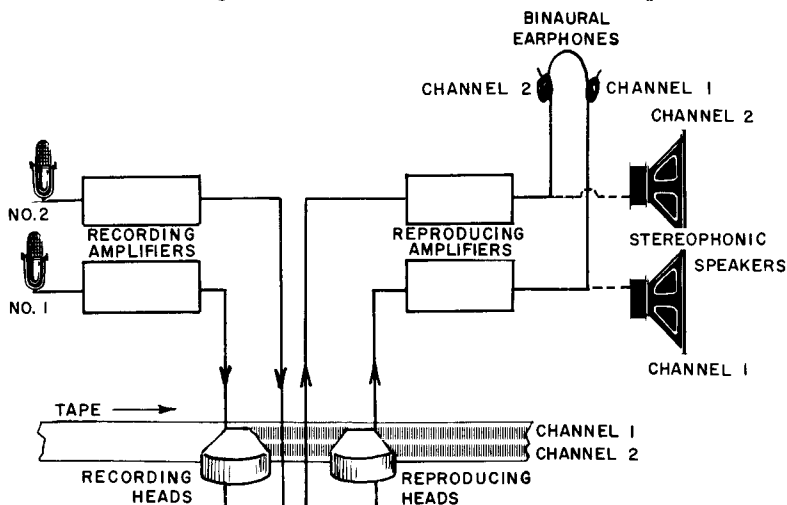

Fig. 402. A two-track stereo tape recorder using stacked recording and pickup heads. The stacked heads are shown as single units in this simplified diagram.

was found to have many advantages even for monophonic recording uses:

(1) The microphones may be widely spaced and later, in the studio, the two tracks mixed for the best possible balance of monophonic sound.

(2) Dubbing can be done on one machine.

(3) An extra recording may be made on track 2 in case track 1 does not turn out.

(4) The two-channel system may be used for experiments in distance perspective by placing both microphones and playback speakers in a straight line with the listener.<sup>9</sup>

Southwath found the two-channel reproduction to produce less intermodulation and other distortion than monophonic reproduction due to the somewhat greater simplicity of the waveforms handled, and therefore permitted the achievement of effects not readily obtainable with single-channel equipment. The best results were obtained in playback when the two sound sources were somewhat diffused, as this tended to give a better illusion of spatial perspective. Southwath suggested that a third speaker could be

bridged across both outputs and placed in a central position to aid in spreading the sound wall evenly.<sup>10</sup>

Tapes recorded for staggered-head playback cannot be played on machines with stacked heads. The staggered-head arrangement has now become obsolete, although for some time both stacked and staggered versions of most stereophonic tapes were offered.<sup>11</sup>

A third arrangement of the two channels (Fig. 403) has been suggested. Known as the coded stereophonic tape system, it was never adopted, however. The system using one coded track only would leave the other side of the tape free for another recording, just as in monaural dual-track recording. The system using two tracks of different width would give much superior quality with the wider audio track.

Another possibility in putting both stereo signals on one track would separate the heads, as with staggered, but line them over the same track on the tape, one head angled in one direction by  $45^\circ$

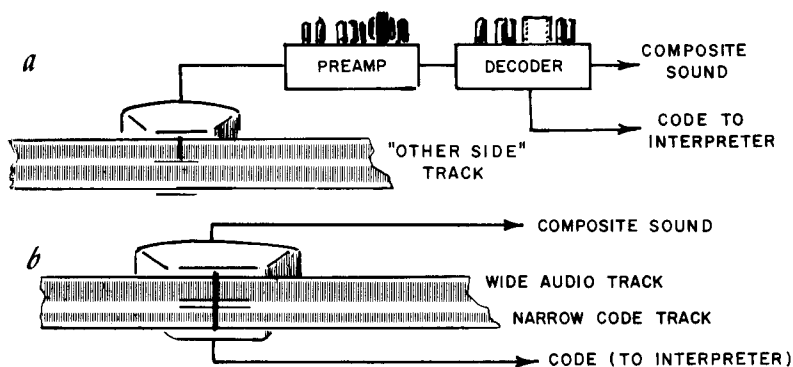

Fig. 403. Coded stereo can be reproduced by using a single coded track (a) or a wide audio track and an accompanying narrow code track (b).

and the other angled in the opposite direction. Thus the two signals could be placed on the same track.<sup>12</sup>

### Stereo tapes in the home

The first complete stereophonic home music system was unveiled by Ampex early in the fall of 1955. Designed by Phillip L. Gundy, manager of the company, as "the next logical step" in the realistic reproduction of recorded music, the unit was called the model 612 tape phonograph. It was, as the name indicates, for playback only. New combination speaker-amplifier systems, the model 630, went with it to achieve maximum realism by their

identical construction.<sup>13</sup> One of its many successors, the model 910, is shown in Fig. 404.

As more and more audiophiles became aware of the advantages of stereophonic sound on tape, the popularity of the medium increased rapidly. There was available a small but representative group of popular and classical selections as well as the ever-popular "demonstration" tapes.<sup>14</sup> Only RCA Victor, however, among the big companies, had issued classical stereophonic tapes by the middle of 1957, and only a modest quantity was coming from them. The Livingston Tape Club Plan, started in 1955, gave members a 25% discount on the labels distributed by Livingston. The tapes were available in either staggered-head or stacked-head

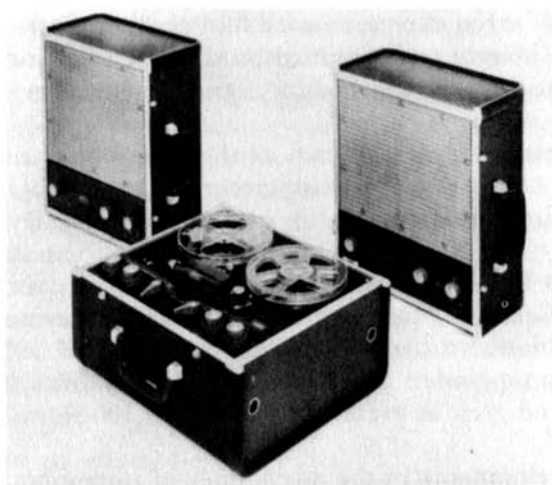

Fig. 404. *A complete stereo tape system can come in a small package. Separate amplifiers are mounted in the two speaker cabinets. (Ampex)*

stereo versions in addition to single-track or dual-track monophonic versions.<sup>15</sup>

Other large companies began producing stereo tapes after the battle of staggered vs stacked appeared to be settled by RCA Victor, who stopped releasing staggered tapes. Sonotape, using original recordings from Westminster Records, entered the field of stereo tape manufacture, followed by Mercury Records. Mercury was recording everything in three-channel stereophony. The middle channel was blended into the other two in the final version to achieve a "phantom" center channel.<sup>16</sup> In a review of Mercury's release of the *Harry Janos Suite* the reviewer said:

. . . anyone who still entertains a doubt as to the more substantial efficacy of stereo is cordially invited to compare (the monophonic version) with this first of Mercury's long-awaited releases."<sup>17</sup>

One reviewer suggested that super-perfectionists could "be heartened by the fact that many forces are at work on the three-channel problems. Something will surely break by the end of this year. One fascinating possibility . . . a 'do-it-yourself' three-channel head!"<sup>18</sup>

The three-channel head, minus the do-it-yourself feature, was sold for a time by a Japanese company, Sony, but no commercial tapes were forthcoming. However, one thing useful about tape is that it has excellent possibilities for doing experimental work which would be too expensive with film or discs. Extra tape heads can easily be bought and mounted on the machine, and electronic equipment to decode the channels can be built by the audiophile.<sup>19</sup>

A "universal" adapter, known as the Dactron, was next made available to convert any existing recorder to stereophonic playback. Separate heads were also made by Shure, Dynamu and Brush.<sup>20</sup> Late in 1957, Capitol Records entered the stereophonic tape field, to be followed by Columbia and finally, in 1958, Angel.<sup>21</sup> *Tape Recording* published the first catalog devoted to stereo listening, with more than 650 titles.<sup>22</sup> The fall of 1957 was the high point in tape sales. The whole recording industry had joined in and demand grew so great that more than 100 releases a month came out.<sup>23</sup>

Other developments in the ascendancy of stereophonic tape included formation of the Stereophonic Music Society for mail-order stereo tapes at a discount. The first stereo tape rental library was started. Most of the smaller tape recorder manufacturers brought out stereophonic playback models. The lower-priced Ampex model 122 machines brought fine-quality stereophonic playback within the range of more people.<sup>24</sup>

### **Advantages and disadvantages of tape**

The greatest disadvantage of 2-track stereophonic tape is the cost. For the amount of music contained on a standard LP record, the stereophonic tape addict pays about three times as much. This makes the medium strictly a carriage-trade item. When the first stereophonic discs began appearing, at a price only slightly higher than regular discs, the tape industry was profoundly affected. In England, this only stimulated interest in stereophonic tape and

sale of stereophonic recording and playback units. Audio fans heard the first stereophonic discs, which arrived in England before the United States, and rightly appraised the quality as poor. They then turned to the high-quality tape medium. Most of the classical stereophonic tapes came from England while the American companies cut monthly releases to almost nothing.<sup>25</sup> The difficulties of mass-producing pre-recorded tape further aggravated the situation (Fig. 405).

The tape clubs were not enough to lower the fantastic prices of 2-track stereo recordings. Some tried recording at slower speeds than 7½-ips, with consequent economy of tape. In the late fall of 1958, Livingston Audio announced that their entire library of 7½-ips tapes would also be available at a speed of 3¾ ips. This cut the price but also cut the quality along with it, for slower speeds lack wide frequency response and accentuate wow and flutter.<sup>26</sup>

The tape enthusiasts claim highest quality because the magnetic playback heads have no moving parts. Of course, they have magnetic circuits which can lead to their own difficulties, but the point is well taken. The stereophonic disc cutter and playback cartridge are mechanical and suffer from mechanical distortions. Therefore, tape stereophony offers the best possibility for those really interested in top quality — a view underscored by the fact that all master recordings today are first made on tape, then transferred to disc.<sup>27</sup> The steps in preparation of master tapes either for duplication or transfer to discs are illustrated in Figs. 406 and 407.

### **Advantage of discs**

The biggest advantage of discs, in addition to their lower cost, is the ease of handling. A passage can be quickly picked out simply by looking at the grooves. Also, loading onto the machine is very simple with discs. RCA Victor designed a tape cartridge which would simplify the handling problems. The idea of a cartridge designed to hold the tape instead of the standard open plastic reel is not a new one. Such magazines as the Fidelipac have done good service in many specialized applications. Most of these cartridges needed special playback machines, although several operated on home machines.<sup>28</sup>

### **The tape cartridge**

The RCA tape cartridge was first officially announced in February, 1958, timed to coincide with the stereo disc. However, it did not actually make an appearance until the end of that year.



The development of this cartridge had to await the development of a tough magnetic tape base which could withstand friction (engendered by the guides inside the cartridge) and not break or tear. If the tape should break, however, the solution with the cartridge is the same as for reel tape — the cartridge case comes apart easily and the broken tape can be spliced together again (Fig. 408) using splicing tape.<sup>29</sup>



Fig. 405. Duplication of tapes for commercial release is cumbersome and time-consuming, resulting in high retail prices. The master unit at the far right feeds a maximum of ten "slave" recorders, running at 60 ips, and takes four minutes to duplicate a standard 1200-foot reel of tape. (Ampex)

The cartridge itself is about 5 by 7 inches in size and  $\frac{1}{2}$  inch thick. It is made of a styrene-like plastic, probably breakable if dropped. Instead of the normal two stereo tracks, there are four tracks (Fig. 409) on the tape. One stereo set, consisting of two tracks for the two channels, is reproduced as the tape travels in one direction. The second stereo set is played upon reversing the tape. Thus, this is in effect a double-track stereo tape (Fig. 410) and the same amount of material could be contained on it as on a double-track monaural tape at the same speed.<sup>30</sup> However, the speed is not the same.

The RCA cartridge differs from the continuous types in that it

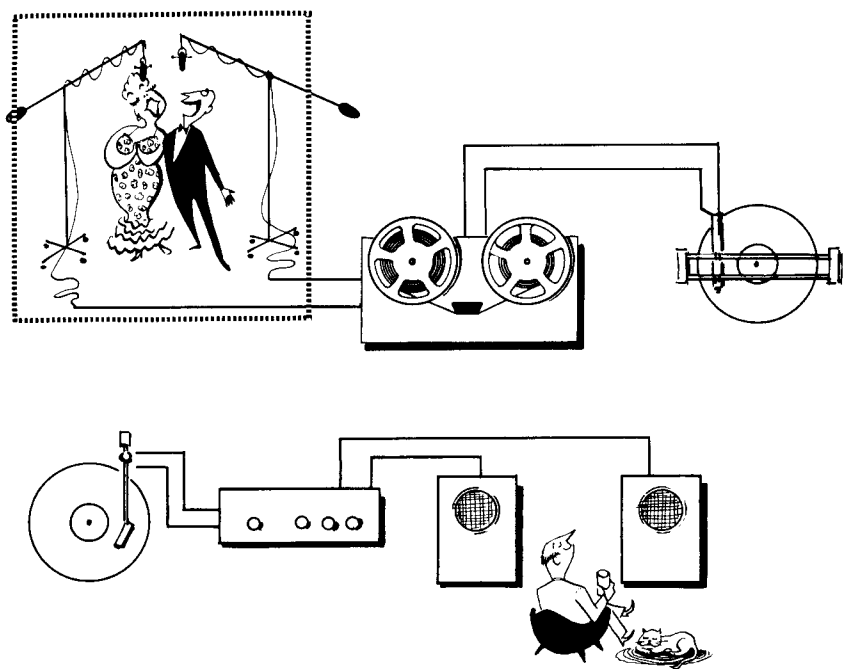

Fig. 406. *The basic steps in making and reproducing a stereo disc. A master tape, made at the recording session, is transferred to a disc. Duplicate discs are then played back in the home.*

has two spools. The continuous types are loaded with a special friction-free tape (often lubricated with graphite) since the tape must rub against itself as the reel revolves, and also pass through a twist or Moebius loop. (A Moebius loop is shown in Fig. 411.) The tape is fed from the center of the spool on continuous cartridges and, in pulling away from the reel hub, imparts a rotating motion which winds it up on the outside of the reel. As the tape is continually pulled from the center and wound up on the outside, any one spot on it will gradually work its way from the outside to the center where it leaves the reel, passes across the pickup heads and then is again wound on the reel. This continues endlessly.<sup>31</sup>

The slower speed used in tape cartridges ( $3\frac{3}{4}$ -ips) not only reduces the loudness of the music relative to the attendant noise (signal-to-noise ratio), it also tends to curtail the high-frequency response, making it difficult to get strong, clean high frequencies.<sup>32</sup>

The main problems in the development of a 4-track system hinged on improvement of this signal-to-noise ratio as was pointed out when the system was still in the development stage.

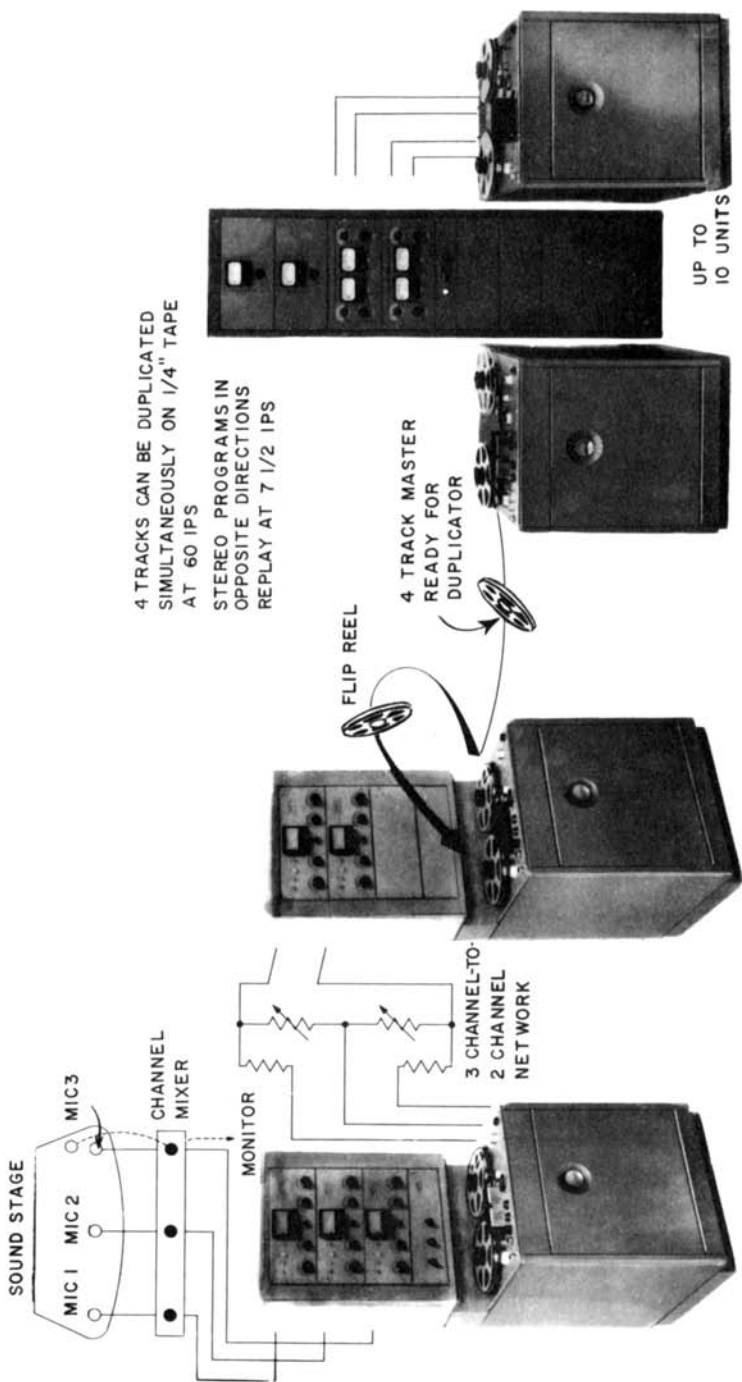
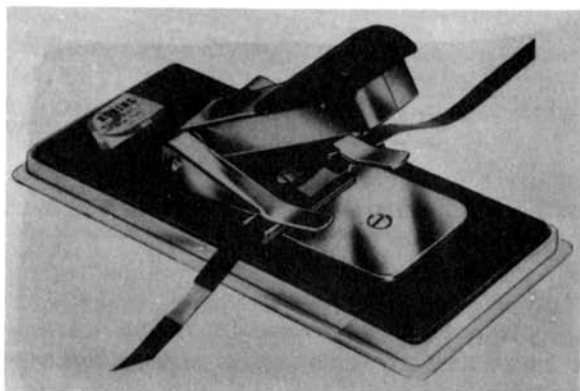

Fig. 407. The actual steps in preparing a master tape start with a multi-channel first master. This tape is then fed through a mixer to reduce the signals to two channels and recorded on a four-track tape. The new tape is flipped, two more channels dubbed on the other two tracks, and the new master is ready for duplication. (Ampex)

Reduction of the width of each track to about one-third of that in a one-way system results in an appreciable reduction in signal-to-noise ratio . . . some of this loss . . . can be recouped . . . But there are limits to this . . .<sup>33</sup>

There are indications that improved tapes and heads may eventually bring the quality of reproduction to the  $3\frac{3}{4}$ -ips speed that now can only be obtained with higher tape speeds, but some major improvements must still be made in this area.<sup>34</sup>



*Fig. 408. A popular tape splicer which cuts slightly into finished splice for a "wasp-waist" effect. The splice made this way will pass smoothly and quietly over the tape heads. (Robins Industries, Inc.)*

If the range of frequencies were restricted to a top of 10,000 cycles, the music could be recorded at a higher volume before the tape overloaded and became distorted. This would solve the noise problem and produce tapes that are excellently fitted to succeed as a medium for popular music and on less expensive home systems which are not strong in the high frequencies. This is not an acceptance of mediocrity. Music with such a range can sound quite good, if distortion and noise are held down and the balance of highs and lows is good.<sup>35</sup>

### **The high frequencies**

Only on top-fidelity systems does the last band of overtones, from 10,000 cycles on up, have any significance. They add some clarity and "bite" but, even here, if the tweeter speaker is not completely free of distortion and peaks, those super-high frequencies can become very harsh. Some experts, such as Bell Laboratory engineers, have found that stereophonic reproduction with a somewhat restricted top range can be as good or better than wide-range monophonic reproduction.<sup>36</sup>

Few home type tape recorders achieve really first-rate performance at  $3\frac{3}{4}$  ips. This is often due to the increased wow and flutter accentuated by the slower speed. However, the  $7\frac{1}{2}$ -ips speed was once regarded much as  $3\frac{3}{4}$  ips is today. This was when the standard

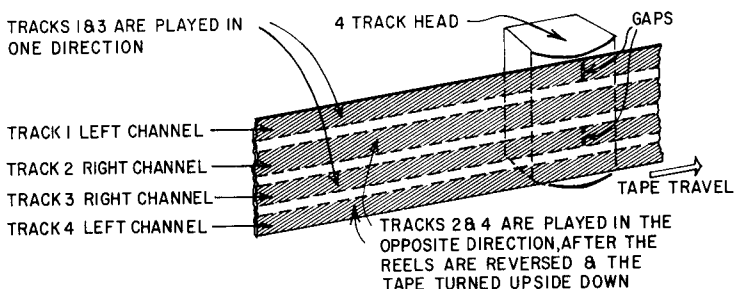

Fig. 409. Four-track stereo tapes have become the industry's standard because of their doubled playing time. The actual arrangement of the four tracks is shown here.

speed was 15 ips, but improvements in magnetic heads with narrower gaps, more efficient equalization and smoother tape drives made a flutter-free response of 30 to 15,000 cycles possible at  $7\frac{1}{2}$ , and now the faster speed is used mainly in commercial recording.

After hearing the new RCA cartridge at the convention of the

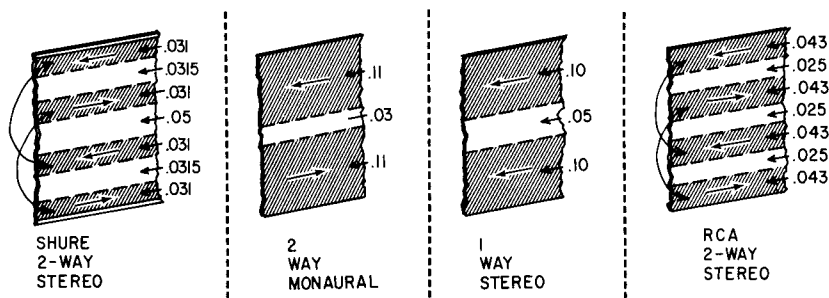

Fig. 410. Diagrammatic comparison of monophonic and two-track stereo tapes with the four-track system which was not adopted by the industry, and the RCA system, which was.

National Association of Music Merchants in Chicago in July, 1958, Bert Whyte had this opinion:

Looking to the future, I can see where  $3\frac{3}{4}$ -ips 4-channel tape properly recorded and with all technical resources fully exploited in its reproduction, will certainly be big competition to the stereo disc. The argument of handling put forth as a particularly attractive aspect of the stereo disc does not have much weight in the

face of the equally easy handling of the cartridge form of this new tape, which can be likened to magazine-loading movie cameras.<sup>37</sup>

The frequency response was found by Whyte to be "not a squeak past 5,000 cycles." Victor did not have its machine ready for the convention showing, but Motorola had one. The Achilles'

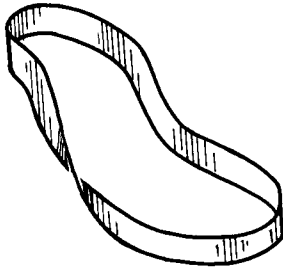

Fig. 411. *A Moebius loop is used in continuous-tape cartridges and players. The half-twist in the tape permits the beginning to be attached to the end, giving completely continuous operation.*

heel of the matter is the duplication problem. It is difficult enough to duplicate two-track stereophonic tapes, compared to the ease of pressing out thousands of LP records from stampers. However, the four-track tape presents even more duplication problems. Ampex also announced that they were working on the dubbing equipment.<sup>38</sup>

The price of the cartridge was designed to compete with stereo discs. Thirty-two new releases were forthcoming from RCA Victor, with its enormous stable of top-name musicians.<sup>39</sup>

Pentron announced a tape cartridge machine in October, 1958. It worked at both  $7\frac{1}{2}$  and  $3\frac{3}{4}$  ips, and played standard reel tapes in either monaural or stereo. Five pushbutton controls operated it and a VU meter showed recording levels. All Pentron machines made since August, 1958, handle both  $3\frac{3}{4}$  four-track stereo tapes and  $7\frac{1}{2}$  two-track tapes.<sup>40</sup>

The four-track Ampex Universal A 900 machine next came on the market. It played the two-track and four-track stereo tapes and had an automatic shutoff at the end of the reel. However, it did not handle cartridges, only tape on reels. A demonstration tape included with the machine sampled various sound effects and musical selections at the slower speed. The writer found the reproduction lacking greatly in the high frequencies, but otherwise good. Hi-Fi Recordings Inc. brought out many of their albums on  $3\frac{3}{4}$  four-track reels at about half the price for the  $7\frac{1}{2}$  speed. This was the only company with four-track tapes to demonstrate at the fall 1958 New England Hi-Fi Show in Boston's Hotel Touraine. Music released included percussion music and Dixieland — program material capable of good reproduction even without freedom

from flutter and a complete high end. The writer found the absence of such material as piano music or full symphony orchestra an admission of the fidelity problems at  $3\frac{3}{4}$  ips.

Dissension was created among the four-channel tape manufacturing companies regarding the adoption of a standard four-channel magnetic-head configuration. The issue of "compatibility" was again discussed. One of the parties involved had made an error in some measurements of the proposed heads, and it turned out that there could be at least partial compatibility: the new four-track tape machines would also play regular two-track tapes, but there seemed to be no way of converting stereophonic machines to play the cartridges, aside from simply removing the tape from the cartridge after purchase and putting it on a regular reel.<sup>41</sup> The Shure Co. also marketed a four-track playback head, and Ampex announced an adapter kit for playing the  $3\frac{3}{4}$  ips reels.<sup>42</sup>

### **The tape enthusiasts' problem**

By December, 1958, owners of tape machines were becoming worried about the obsolescence of equipment and the lack of new stereo tapes at the  $7\frac{1}{2}$ -ips speed. A few months prior to that time, some 40 or 50 tapes a month were being released; now the stream had dried up to a mere trickle of a few tapes a month. Audio enthusiasts were beginning to wonder where the four-track tapes and machines were. It seemed to be the familiar "chicken and the egg" situation: release of tapes depended on the sale of machines to play them, and the sale of machines depended on the release of tapes. Interest in the  $7\frac{1}{2}$  ips speed was still strong. Whyte believed it would go on existing indefinitely side by side with four-track  $3\frac{3}{4}$  ips tape.<sup>43</sup>

The same four-track stereo system used in cartridges is also used in the more conventional reel-to-reel tapes that are currently being issued, and many of the new tape recorders are equipped to both record and play back four-track stereo. Signal-to-noise ratio is still a problem, however, due to the narrowed track width in these new tapes. A solution to the problem of noise levels on  $3\frac{3}{4}$  ips tapes is the release of four-track stereo tapes at the  $7\frac{1}{2}$  ips speed on reels. Perhaps the decision to bring out this product was prompted by an announcement made in the early spring by Ampex. No cartridge machine would be produced in 1959, according to the official announcement. Ampex engineers felt further developments were necessary before satisfactory quality would be achieved. So far, they found the quality of cartridge reproduction below that of stereo discs, with which it was to compete.<sup>44</sup>

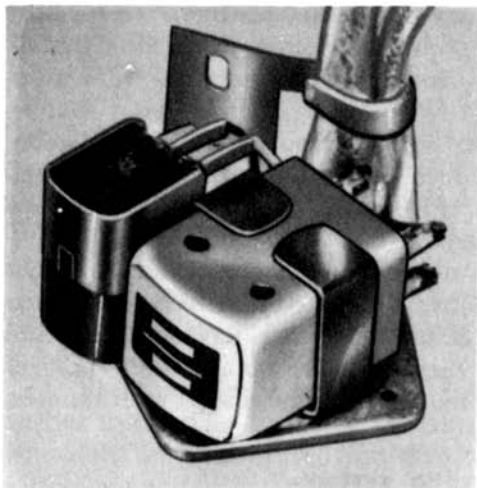

The basic conversion kit (left) consists of two stacked 4-track record/playback heads and a separate erase head. With different kinds of mounting hardware, the same basic conversion heads can be used in many different tape recorders as exact replacements for the existing heads.

(Right) Typical installation of the conversion kit in a monophonic tape recorder. Original equipment in this unit is a single head with two gaps easily replaceable by the new heads.

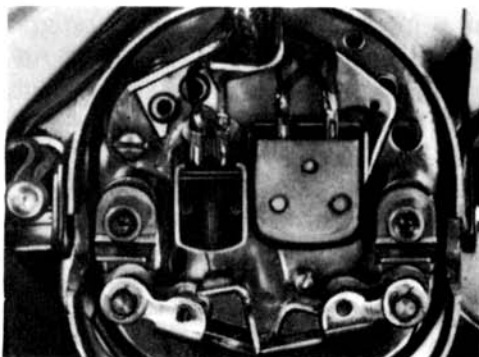

(Below) In this conversion, the original heads are retained while the stereo heads are added on the right. Precise positioning of heads is accomplished by a knob that raises and lowers them for shifting from 2-track to 4-track operation.



Fig. 412. Four-track conversion kits are adaptable for most commercial tape recorders. (The Nortronics Co., Inc.)



Many manufacturers are convinced that four-track stereo tapes at the  $7\frac{1}{2}$ -ips speed will be popular. It offers excellent dynamic range and superior frequency response characteristics when compared to  $3\frac{3}{4}$  ips. In line with this reasoning, by the spring of 1960, Ampex had started recording and distributing four-track stereo tapes on reels at the  $7\frac{1}{2}$  ips speed. Using the name United Stereo Tapes, they have undertaken this program for a number of both small and large recording companies.

Monophonic and two-track stereo tape recorders can be brought up to date with four-track conversion kits of the type illustrated in Fig. 412. The kit consists of stacked record-playback heads and an erase head. In general, these kits are compatible — that is, mono tapes and two-track stereo tapes can be played with the new playback heads.

### **A $1\frac{7}{8}$ ips magnetic recording system**

The next logical step in the development of “convenience” devices for home use is a tape cartridge using a  $1\frac{7}{8}$  ips speed. As part of a long-range development program in the field of magnetic recording which CBS Laboratories undertook on behalf of Minnesota Mining and Manufacturing Company, pre-recorded tape systems for the home have been under study over a period of several years.

In the course of their study, CBS Laboratories drew up a list of what they believed to be the important attributes of a general home tape player-recorder. The project's goal is to gain for pre-recorded tape a position of pre-eminence in the field of home entertainment, but many of the requirements are not easily met. These include:

1. The tape must be contained in a compact cartridge in such a way that no part of the tape is exposed.
2. The amount of tape must be small and the cost of the cartridge low so that the price of the final product can approach that of the record.
3. The sound should be stereophonic with provision for three tracks for maximum flexibility.
4. A complete musical composition should be played without interruptions; that is without reversing the cartridge or tape.
5. The quality of sound should be at least as good as the best of existing pre-recorded media.
6. The durability of the tape and cartridge must be high enough so that after several hundred plays, the sound remains unchanged.
7. It should be possible to place a number of cartridges on a

tape machine equipped with a changer-type mechanism so that one can provide music for several hours.

In the late fall of 1959 the new pre-recorded system was in a sufficiently advanced stage to demonstrate it to most members of this industry. 3M had, at that time, stated that the Zenith Radio Corporation had joined this effort and entered the design of commercial equipment based on these developments.

Some of the important features and parameters of the new tape cartridge system are as follows:

1. Tape speed is  $1\frac{7}{8}$  inches per second. The width of the tape is 150 mils; the thickness 1 mil, and there is provision for three tracks. Each track is 40 mils wide.

2. The cartridge is approximately  $3\frac{1}{2}$  inches square and  $\frac{5}{16}$  inches thick. The cartridge contains sufficient tape to play continuously for 64 minutes, and thus will carry more than 98% of music compositions without interruption. The space occupied by the cartridge in its container is approximately 4 cubic inches as compared with an LP record in its envelope with approximately 20 cubic inches.

3. The tape machine can take five cartridges and play them automatically one after the other. One can reject a cartridge during any part of its play similar to a record changer. The production versions of this machine now under development by Zenith will have fast forward and reverse speeds. The same instruments will also serve as a home recorder using the new cartridges with blank tape.

The unit that was demonstrated was not a mass-manufactured item. It remains to be seen whether a factory-produced unit will maintain the quality standard of the original.

### **Competing systems**

Of the several four-track stereo systems that have been proposed or tested, only two are currently being produced in commercial quantities. Reel-to-reel tapes at  $7\frac{1}{2}$  ips were being produced by virtually every recording company except Columbia by the end of 1960. The RCA cartridge system, while affording greater ease of handling than the conventional reels, seemed to be losing ground, while sales and general acceptance were still rising for  $7\frac{1}{2}$  ips reel-to-reel four-track stereo tapes. Columbia, in the meantime, was holding out for the ultimate perfection of its proposed  $1\frac{7}{8}$  ips tape cartridge.

### **Bibliography and References**

<sup>1</sup> *Electronic Industries*, July 1958, page 22.

- <sup>2</sup> Louis E. Garner, Jr., "Adding Channel Two," *High Fidelity* November 1958, page 47.
- <sup>3</sup> A. A. McK., "Stereophonic Sound: Magnetic Tape Carrying Three Simultaneous Channels Gives a Striking Illusion," *Electronics*, August 1948, pages 88, 89.
- <sup>4</sup> "Sound Reproduction; Demonstration of Three-Dimensional Technique," *The Electrician*, Aug. 29, 1952, page 626.
- <sup>5</sup> Garner, "Adding Channel Two," *op. cit.*, page 47.
- <sup>6</sup> Mark Mooney, Jr., "The History of Magnetic Recording," *Tape Recording*, February 1958, page 36.
- <sup>7</sup> Albert J. Forman, "New Multiplex System for Three-Dimensional Sound: Stereo-sonic System," *Tele-Tech*, April 1953, page 188.
- <sup>8</sup> James Moir, *High Quality Sound Reproduction* (London: Chapman & Hall, Ltd., 1953), page 573.
- <sup>9</sup> G. Southworth, "Binaural Sound Reproduction," *Radio & Television News*, March 1953, page 72.
- <sup>10</sup> *Ibid.*, pages 101, 100.
- <sup>11</sup> Garner, "Adding Channel Two," *op. cit.*, page 47.
- <sup>12</sup> Norman H. Crowhurst, "Single-Groove Stereodiscs," *RADIO-ELECTRONICS Magazine*, January 1958, page 55.
- <sup>13</sup> "Stereophonic Music for Homes," *The Journal of the Franklin Institute*, October 1955, page 347.
- <sup>14</sup> "Stereophonic Sound for the Home," *Radio & Television News*, November 1955, pages 42-43.
- <sup>15</sup> Catalog from Livingston Electronic Corp., January 1956.
- <sup>16</sup> Bert Whyte, "Certified Record Revue," *Radio & TV News*, April 1957, page 60.
- <sup>17</sup> Review by "J. L.," in *American Record Guide*, September, 1957, page 29.
- <sup>18</sup> Whyte, *op. cit.*, page 60.
- <sup>19</sup> Crowhurst, *Stereophonic Sound*, *op. cit.*, page 68.
- <sup>20</sup> Norman Eisenberg, "Going Stereo?," *Popular Electronics Hi-Fi Guide & Yearbook*, New York: Ziff-Davis Publishing Co., 1958, page 123.
- <sup>21</sup> Whyte, *op. cit.*, page 60.
- <sup>22</sup> Mark Mooney, Jr., "The History of Magnetic Recording," *Tape Recording*, February 1958, page 36.
- <sup>23</sup> Fritz A. Kuttner, and Donald J. Plunkett, "The Two Sides of the Stereophonic Disc," *The New York Times*, Sunday, March 15, 1959, Section N, page 10.
- <sup>24</sup> Mooney, *op. cit.*, page 27.
- <sup>25</sup> Bert Whyte, "Sound on Tape," *Radio & TV News*, November 1958, pages 122-123.
- <sup>26</sup> "Crosstalk," *Tape Recording*, November 1958, page 10.
- <sup>27</sup> Crowhurst, "Single-Groove Stereodiscs," *op. cit.*, page 56.
- <sup>28</sup> "Tape Cartridge Developments," *Tape Recording*, February 1959, page 26.
- <sup>29</sup> *Ibid.*
- <sup>30</sup> Larry Zide, "Sound Ideas," *American Record Guide*, September 1958, page 83.
- <sup>31</sup> "Tape Cartridge Developments," *op. cit.*, pages 26-27.
- <sup>32</sup> *Ibid.*, page 27.
- <sup>33</sup> Herman Burstein, *Stereo . . . How it Works* (New York: Gernsback Library, Inc., 1959), pages 119-120.
- <sup>34</sup> Burstein, *op. cit.*, page 121.
- <sup>35</sup> Lanier, *op. cit.*
- <sup>36</sup> *Ibid.*
- <sup>37</sup> Bert Whyte, "Sound on Tape," *Radio & TV News*, October 1958, page 136.
- <sup>38</sup> *Ibid.*
- <sup>39</sup> "RCA's 4-Track Stereo Cartridge," *op. cit.*, page 80.
- <sup>40</sup> "Hi-Fi Audio Product Review," *Radio & TV News*, October 1958, page 90.
- <sup>41</sup> Bert Whyte, "Sound on Tape," *Radio & TV News*, August 1958, page 104.
- <sup>42</sup> *Ibid.*, July 1958, page 102.
- <sup>43</sup> *Ibid.*, September 1958, page 94. Also October 1958, page 138, and December 1958, page 133.
- <sup>44</sup> "Crosstalk," *Tape Recording*, April 1959, page 10.

# stereophonic sound on discs

**W**HEN magnetic tape recording appeared as a practical medium, many experts predicted that it would eventually replace discs. However, this has not happened yet and probably will not. The early tape recorders could produce a dynamic range far better than the disc records of that time, the early long-playing type. However, modern development of the LP has brought us to the stage where a good disc can produce at least as great a dynamic range as the best tape.

The dynamic range of either tape or disc can be improved: on discs, by having a greater modulation width of the recording groove; on tapes, by having a greater maximum magnetic density by increasing tape width or speed. Therefore, the argument that bases itself on considerations of dynamic range proves inconclusive without taking into account the other factors aside from the simple choice of tape or disc.<sup>1</sup>

## **An advantage of tape**

A big advantage of tape is its long playing time. By using the 1/2-mil tape now available, 2 hours of top-fidelity music at a speed of 7 1/2 ips can be contained on a single 7-inch diameter four-track stereo tape reel (Fig. 501). The most material that can be contained on a 12-inch stereo disc is limited to about 1 hour, and few companies relish the technical problems of squeezing so many grooves onto a disc, preferring to limit the length to about 20 minutes a side.

## An advantage of discs

The advantage of disc recording is the readiness with which a certain passage may be selected. The run-on grooves between selections on a disc enable it to play continuously until the end, yet it is simple to pick out a particular section at a moment's

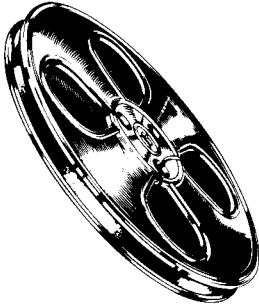

*Fig. 501. Standard 1200-foot reel of tape plays ½-hour of two-track stereo at 7½ ips. On four-track operation at 3¾ ips, the same reel of tape plays for a total of two hours.*

notice. Simplicity of use goes along with the ease in selection of music. At the present writing, even the most conveniently arranged reel type tape machines present more loading problems than a phonograph.<sup>2</sup>

## Experimental stereo disc systems

La Prade discussed in 1947 the possibility of stereo recording on disc:

Always a possibility, though not, apparently, very imminent, is the stereophonic phonograph recording. It has been produced in the laboratory, but it seems unlikely to progress much further until there is some demand for it on the part of the public. Stereophonic recording, like stereophonic broadcasting, is caught in a vicious circle; it cannot be justified economically until the public wants it, and the public cannot be expected to want it until it has had a chance to try it.<sup>3</sup>

## Cook stereo discs

The public did have a chance with the Cook stereo discs, and found them hardly worth the effort it took to play them. Interest in this process did not fall off suddenly, however. By 1956, about 75 of the "binaural" discs were still available, produced by several small companies.

Other reasons for the lack of acceptance besides the difficulty of use were offered by Kendall. The expense of duplication, much as with tapes, was thought to be a reason. He wondered whether enough people considered the benefits worth the added expense. Also, the repertory of binaural recordings was limited until sufficient demand should arise.<sup>4</sup>

Emory Cook had experimented with other types of binaural recording before bringing out his two-groove binaural disc. Among the designs he bypassed were:

- (1) Recording on opposite sides of the disc (Fig. 502). This

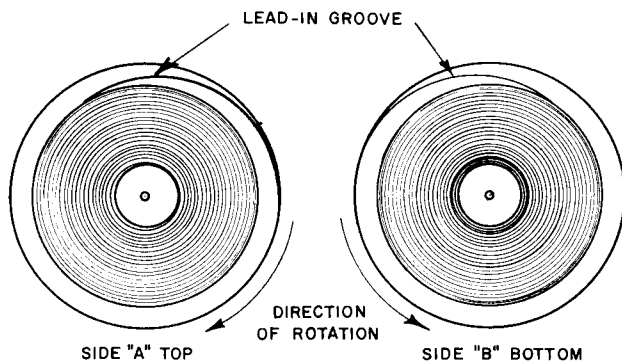

Fig. 502. Stereo recording on opposite sides of the disc.

was not considered practical because the record stampers were difficult to center and align in the presses, and a wholesale redesign of the playback turntables would have been necessary.

- (2) Recording with interleaved grooves. This would have been costly to record and play back, and would have needed special equipment.

- (3) The single-sideband carrier system. This system had such a restricted frequency range in each channel at this stage of development that it was not acceptable from a fidelity standpoint.<sup>5</sup>

## EMI

By 1957, it was said Electrical & Musical Industries of London had solved the stereo disc problem. Two styli of very small radii were used but, instead of following separate grooves, as in the Cook system, they picked up modulations on either side of a single groove, at right angles to each other. A speed of 16 rpm was used so that it would give an adequate amount of time on one side of the disc. This was called for because the two-styli system needed much wider grooves, which took up more room. Evidently publicization of this development was premature, for no mention of it was heard again in the ensuing rush for a standard stereo disc method.<sup>6</sup>

## VL

An engineer from Bing Crosby Enterprises Inc. described a single-groove system of stereophonic disc recording similar to

Blumlein's method, in October, 1954. The system was called VL, the letters standing for Vertical and Lateral, since the single groove contained both of these components in it (Fig. 503).

In the late 1930's the vertical-cut system became popular, especially for radio transcriptions. Higher quality and longer playing time could be had by inscribing the grooves with a "hill-and-dale" pattern rather than motion from side to side. The old Edison heavy disc recordings were also of the vertical type.

The new stereophonic cutter inscribed vertically for the first-channel signal and laterally for the second channel. Two varieties of universal type phonograph pickups used in broadcasting

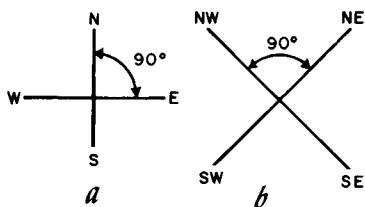

Fig. 503. Comparison of stylus motion in the "VL" (vertical-lateral) system (a) with stylus motion in the 45/45 system (b).

studios could be easily rewired to play the VL recordings, and an inexpensive home pickup could be designed also. There was some crosstalk in the system, but undistorted crosstalk would not be objectionable since it would reduce only the apparent separation of the speakers. The system was automatically compatible.<sup>7</sup>

## MSD

Jerry B. Minter, president of Components Corp., announced his own stereophonic disc method in November, 1957, and demonstrated a model in January, 1958.<sup>8</sup> Called the Minter Stereo Disc, or MSD, it required no mechanical changes in the stylus or the record groove. Instead it

. . . utilizes carrier multiplex above the audible spectrum to record the "difference" information which results when the two stereo channels are subtracted vectorially. The vector sum is recorded normally and simultaneously with the FM carrier. Of course, the resulting groove resembles a normal lateral recording except that there is a superimposed 25-kc carrier of moderate level . . .

Since the vector sum of two stereo channels is the normal monaural "mix" — the audible lateral groove modulation of the MSD system is fully compatible with existing monaural records. The

MSD can be played monaurally with any LP pickup in good working order without damage. It can be played stereophonically with wide-range monaural pickups with the aid of an auxiliary converter. . . .<sup>9</sup>

The converter, known as the Stereo-Vertor, was available from Components Corp. at time of writing, but the system was bypassed in favor of another, probably because of the added expense of the converter, which certainly would not allow the manufacture of inexpensive phonographs such as exist now with the 45/45 system.

### **CBS**

March, 1958, saw the introduction of the Columbia system of stereo disc recording invented by Dr. Peter Goldmark, creator of the modern long-play record. It was basically a variation of the vertical-lateral system.

CBS claimed complete compatibility with standard pickups because the vertical component was limited by a high-pass filter in the "difference" channel to one-tenth the lateral movement. This also cut the vertical rumble.<sup>10</sup>

### **The 45/45 system**

At the Audio Engineering Society convention in October, 1957, the Westrex 45/45 stereo cutter made its debut and launched interest in the system destined to win over all others. The Westrex 3C cutter (Fig. 504) was the result of a crash program put through by the company after RCA had noted the European work on stereo disc cutters and had told Westrex point-blank to get a cutter fast or abandon the cutter business. The final result was unveiled in October, but could not erase the European lead. The Connoisseur stereo system was being demonstrated in London, the Ortofon stereo recorder in Copenhagen and in Hanover, Germany, the Teldec (Telefunken-Decca) system was exciting engineers and music people.<sup>11</sup>

The stereophonic disc cutter consists essentially of two electric motors mounted at right angles to each other, each trying to push around the same sharp engraving stylus. Where the stylus tip will end at a given instant in the recording is dependent upon the forces of the two motors, each of which is controlled by a separate input. Since the groove motion of the 45/45 disc is at a 45° angle with respect to the surface of the disc, the driving motors of the cutter may also be mounted at 45°. Some cutters, such as the Teldec, have their drive elements mounted vertically and laterally. They then use electronic modification of the audio signals to produce an effective 45° modulation of the groove. This cutter is used



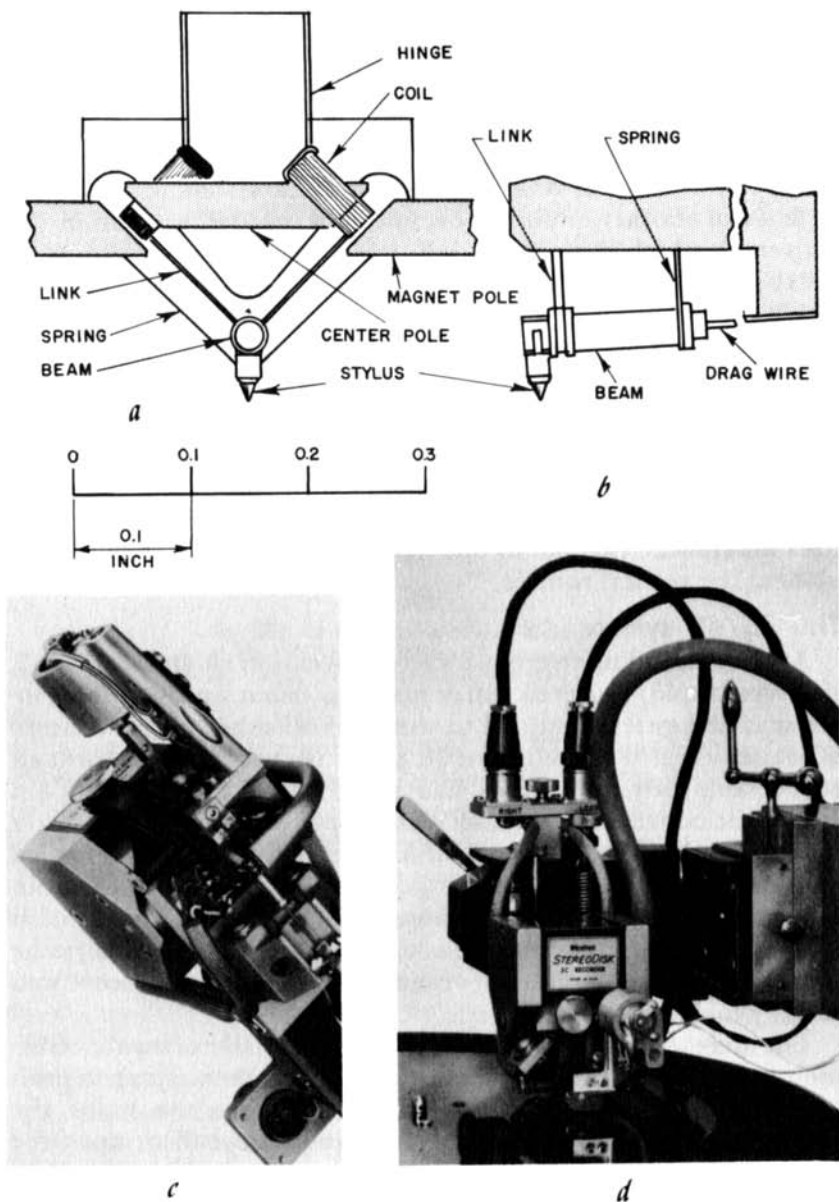

Fig. 504. (a) Cross-sectional view of the 45/45 cutting head. (b) Detail of the stylus mounting assembly. (c) Bottom view of the 3C cutter with automatic depth control. (d) 3C cutter mounted on a Scully lathe. (Westrex Corp.)

for all London stereo discs, and has produced consistently the best stereo discs thus far. Other American engineers who have devel-

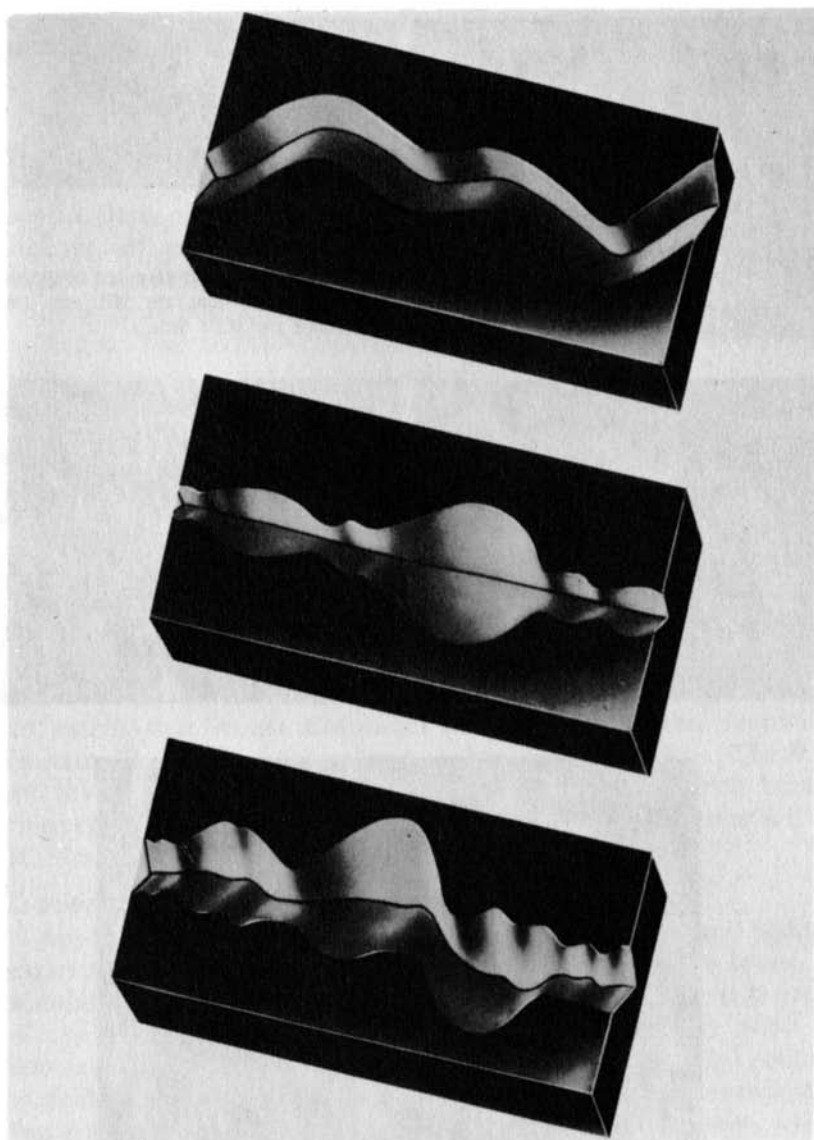
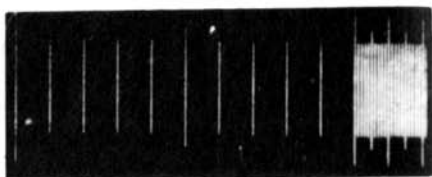

Fig. 505. Record groove modulation; (a) lateral cut, (b) vertical cut and (c) vertical-lateral combined in a stereo disc. (Telefunken G. M. B. H.)

oped stereophonic cutters for the 45/45 system include Emory Cook, Rein Narma of Fairchild, and Peter Bartok.<sup>12</sup>

The heart of the reproduction system is the stereophonic cartridge. It has a double function in receiving two sets of move-



Scale for the top three microphotographs:  
large-scale divisions are .001 inch;  
small divisions are .0001 inch.

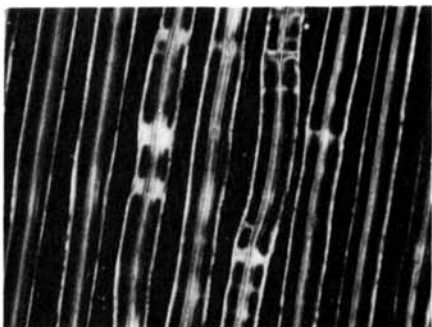
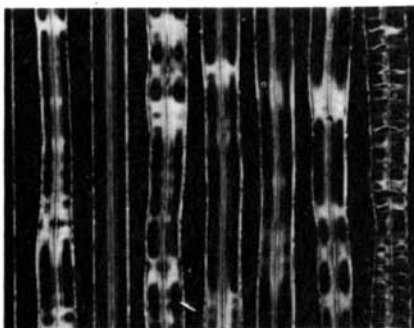

Fig. 506. Microphotographs of grooves in 45/45 stereo records. (Westrex Corp.)

ments at once from the single record groove. These it must unscramble and direct as two separate signals into separate amplifier

circuits. Because of the complex nature of the groove (Figs. 505 and 506), the armature that holds the stylus must be extremely flexible.<sup>13</sup> This is called compliance. It is also extremely important in the problem of compatibility, because a stereo disc may be damaged if the monophonic cartridge used to play it is not very compliant.<sup>14</sup> For this reason, Crowhurst thinks it would be better not to claim the second form of compatibility — that standard pickups will play stereo discs monophonically without harm. He suggests that record companies should, in their own interest, continue to issue both types of recordings whichever recording system is chosen. The recommendation that stereo discs be played only with a stereo cartridge is a good solution.<sup>15</sup>

The radius of the stylus tip used to play monophonic LP records is 1 mil. The radius of the stereo stylus tip is smaller — usually 0.7 mil. The smaller size is necessary to get full response of the higher frequencies in the stereo groove.<sup>16</sup> Another reason is the space factor. The cutter has to go deeper into the record to record the vertical component properly. Since it is chisel-shaped, it widens the groove as it goes deeper.<sup>17</sup> Then the grooves must be spaced farther apart to avoid overcutting or having the playback stylus reproduce the sound of grooves adjacent to the one it is tracking. The 0.7-mil stylus has solved these problems to such an extent that recent Columbia classical stereo discs regularly contain 32 minutes of excellent-quality music per side. The 0.7-mil stylus plays monophonic records perfectly, often with better frequency response than the 1-mil tip. The only difference is that it rides slightly lower in the V-shaped groove.

### **Tracking weight**

Another difference between mono and stereophonic pickup cartridges is the generally lower tracking weight of the latter. A standard stylus with a normal 7 grams of pressure exerts a force of approximately 20,000 pounds per square inch at the point of contact with the record. With a 0.7-mil stylus, the point of contact is smaller and the force consequently even greater. To keep this force down and to prevent wearing of the record grooves, stylus pressure must be reduced. Most high-fidelity stereo cartridge manufacturers recommend a force of about 3 grams, some going as low as 1/2 gram. Package-set designers have attempted to hold the force down to about 4 or 5 grams<sup>18</sup> but, to make the record-changing mechanism operate properly, the pressure is usually increased above this amount, with resultant wearing of the delicate stereo discs.

In a talk to the radio and telecommunications section of the Institution of Electrical Engineers, in Britain, H. A. M. Clark described disc stereophony and expressed the hope that the 45/45 system would be chosen as standard because noise and distortion were averaged between the final left and right channels, a situation not found in the VL system.<sup>19</sup> Crowhurst said that with better cutting methods and rumble-free turntables and record changers, there need be no distortion.<sup>20</sup>

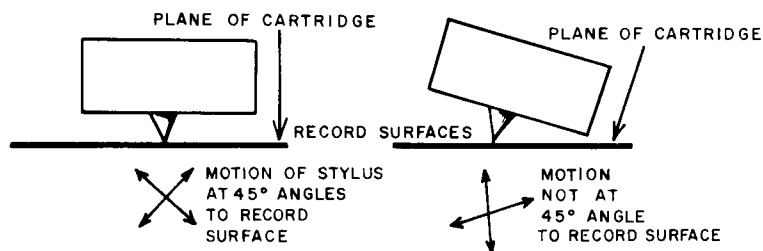

Fig. 507. Crosstalk can be due to misalignment of stereo pickup.

## Crosstalk

Another problem in making the stereo disc is crosstalk, the undesired reproduction on one channel of audio information intended for the other channel. On good stereophonic tape heads, it is on the order of about 40 db. Record cartridges are not as good, with a rating of 20 to 25 db about the best thus far. However, more separation is really not needed to give the stereophonic effect.<sup>21</sup>

Crosstalk depends on two things: the way the original tapes were made (the kinds of microphones, their placement and combination) and future cutter and pickup development. Any deviation from the 45° angle either way increases crosstalk, so cutter and pickup must be carefully aligned (Fig. 507). The crystal and ceramic cartridges which have become popular for lower-cost stereo systems are not as good in separation of the two channels as the magnetic types.<sup>22</sup> (Fig. 508 shows the difference between monophonic and stereo grooves.)

The mechanical moving parts of the stereo pickup (Fig. 509) make it difficult to produce a uniform frequency characteristic. The supporters of stereo tape claim it achieves higher quality because the playback heads have no moving parts. Some of the disheartening early work on the 45/45 system led some to suggest other systems. Weil, a pioneer in phono pickups, found the quality of

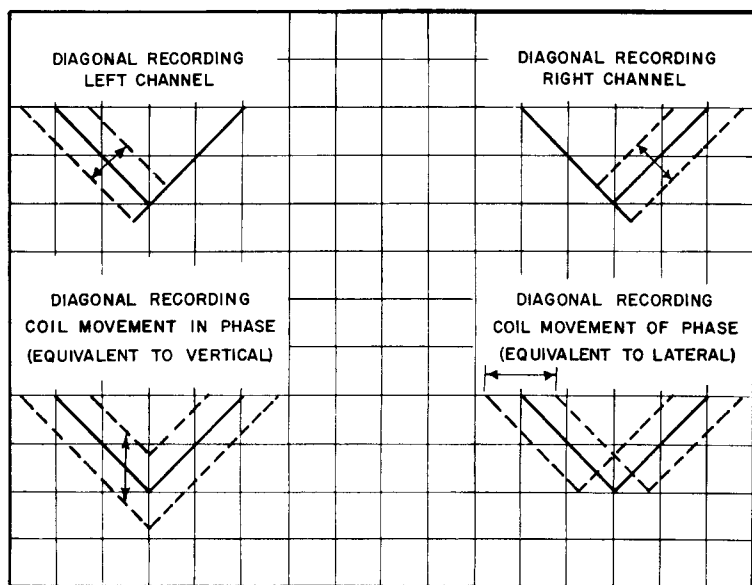
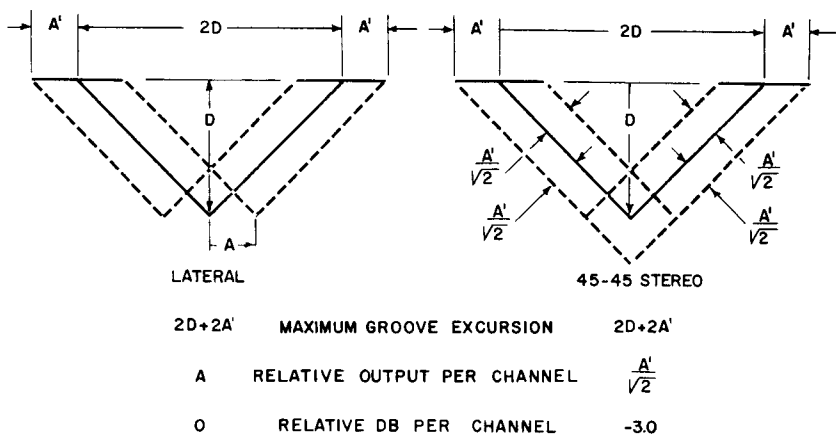

Fig. 508. (a) Comparison between laterally-cut groove (monophonic) and 45/45 stereo groove. (b) Stylus motion in stereo recording. (Westrex Corp.)

the first 45/45 discs usually bad, and considered them a retrogression from the fine quality of long-play records. He suggested a system in which the two channels would be recorded on opposite sides of the disc, an idea also mentioned by Cook,<sup>23</sup> but neglected the problem of playback of the discs<sup>24</sup> which Cook had considered and found impractical.

Columbia Records' president Goddard Lieberson stated in April, 1958:

. . . CBS Labs recently demonstrated a brilliant technical breakthrough in the achievement of a compatible stereophonic disc. It should be borne in mind that the stereophonic effect is by no means an absolute quality with rigidly specified characteristics. Much remains to be investigated in the area of artistic taste and public acceptance.<sup>25</sup>

### **First 45/45 discs**

After the demonstration of the Westrex 45/45 stereo disc system at the AES convention, engineers of all major US recording companies began planning for stereo. Had everything gone according to normal procedure, interest in stereo would have developed slowly and logically. However, Sidney Frey, president of Audio Fidelity Records, saw to it that the floodgates of stereo were opened.<sup>26</sup>

Mr. Frey had decided that stereo was just what his company, already built upon super-high-fidelity recording standards, needed to make sales rise. He asked Westrex to cut a stereo-disc master using pre-recorded stereo tapes from his company's library — train sounds, Dixieland and other noisy subjects. The discs were to be used only for experimental purposes, and Westrex assured this — so they thought — by inserting bands of noise and silence in the selections. But this did not stop Mr. Frey. He took the Westrex master disc, pressed commercial copies and issued them to equipment manufacturers for tests.<sup>27</sup>

Next Mr. Frey advertised four Audio-Fidelity "Stereo-Discs" (brand name) in the high-fidelity magazines as being available to the public. The editor of *Audio* was not angered by Mr. Frey's action. On the contrary, he complimented Audio Fidelity for the step it had taken, and said that no one else, as of April 1958, seemed willing to do anything:

On the whole, the entire story of stereo discs has been handled with as little finesse and as little sense of good merchandising as possible. If the intention had been to confuse everyone, discourage sales, and put the entire industry into a tailspin, it would seem that no better method could have been worked out . . . The consumer hears all about stereo discs but finds out he can't buy any, so he just doesn't buy anything. . . . Here's hoping the small record companies have themselves a ball and press — and release — stereo records like crazy.<sup>28</sup>

At an industry exhibit in New York's Astor Hotel on April 17, 1958, Hallmark stereo phonographs and recordings were demonstrated. The system was not explained, but the discs were said to

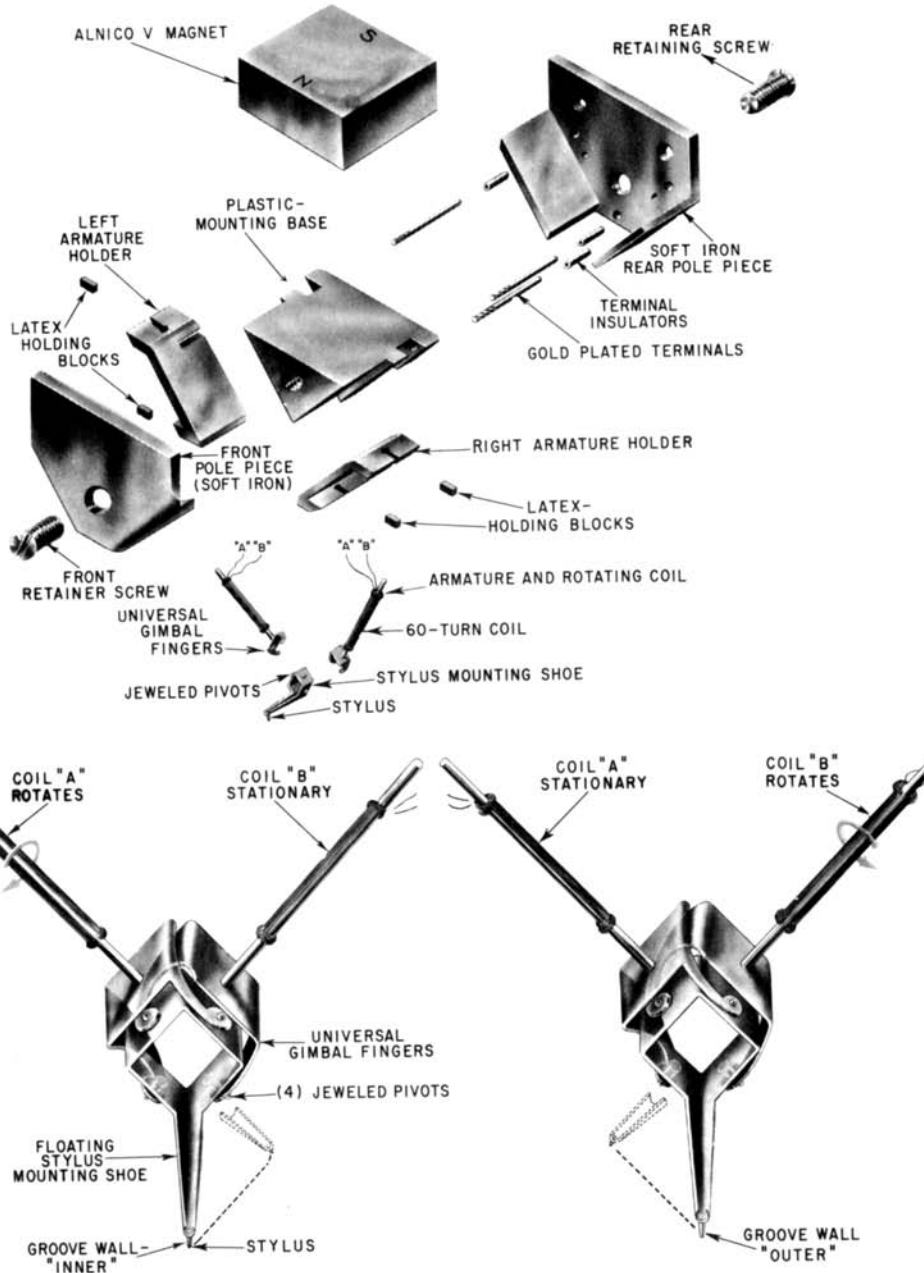

Fig. 509. (Top) Exploded view of magnetic stereo cartridge shows how the two independent rotating coils move in the field of a single Alnico magnet. Lower drawings show magnified detail of the stylus mounting and coil assemblies. Gimbal fingers allow maximum rotation in all directions resulting in high compliance.



be noncompatible. At the same time, Magnavox unveiled new component kits to convert Magnavox equipment to stereo. Sonotone Corp. began tooling up for production of single-stylus ceramic stereo cartridges. Other companies were reportedly working on the twin-styli method.<sup>29</sup>

For a time, it looked as if the confusion of the 45-rpm vs 33 $\frac{1}{3}$ -rpm discs would be repeated with a fight over the standard stereo recording system. However, the industry remembered the loss of public confidence resulting from earlier disagreements. Industry historians commented on the similarity of the situation to the battle for color television in regard to the use of the words "compatible" and "non-compatible." Complete compatibility was seen by the record dealers as an economic threat because it would depress the value of their stock of monophonic LP's.<sup>30</sup>

Which of these reasons played the biggest part is not known, but the Westrex 45/45 stereo disc was adopted as the industry standard.<sup>31</sup> The Record Industry of America, previously limited in a definition of high fidelity due to that term's subjective values, now found and proclaimed a concise definition of stereo:

A true stereophonic disc record has two distinct orthogonal modulations derived from an original live recording in which a minimum of two separate channels were employed.<sup>32</sup>

Events now moved swiftly. The British took the first big step in making stereo discs available to the public. The PYE group of companies put out stereo discs in May, 1958. The BBC cooperated during Radio Week that same month by doing several stereophonic broadcasts. The discs, cut with the 45/45 system, were available in 10- and 12-inch size at 33 $\frac{1}{3}$ , and in 7-inch at 45 rpm. They cost about 25% more than monophonic records. Two "package" stereo systems were placed on the market at the same time by members of the PYE group.<sup>33</sup>

At a New York news conference in June, 1958, RCA Victor showed a full stereo line of merchandise including 55 discs, 15 phonographs and 7 auxiliary speaker systems. George R. Marek, vice president and general manager of RCA Victor Records, predicted that stereo disc sales alone might add 20% to record sales volume for the entire industry in another year.<sup>34</sup> That year has passed and Marek's prediction has proved almost exactly right.

Other companies showing in June, 1958, included Zenith, Ampex and Admiral. The Admiral line included both one- and two-unit consoles, and also a stereo portable. Admiral spokesmen predicted a 25% increase in sales for the high-fidelity industry,

adding that, since only 4% of U.S. homes were equipped with monophonic hi-fi, there was an unlimited sales potential.<sup>35</sup>

At the July, 1958, convention of the National Association of Music Merchants in Chicago, the stereo disc was more or less officially launched. One reviewer refused to review any of the new stereo discs in September because he felt that what he had heard was not representative of what would be offered in a short time. He stressed that this statement was not to be construed as derogatory of the new discs. On the contrary, some of them, being almost "hand-made," with a lot of time and patience, may have sounded better than production copies, he said.<sup>36</sup>

More than a fourth of the 235 exhibitors at the NAMM convention had stereo equipment on display. In general, convention opinion did not agree with sales information. The short span of time that stereo had been on the market was not enough for all manufacturers to determine whether their fall sales would be heavier in one-unit package sets or in component systems.<sup>37</sup>

### **Stereo problems**

The launching of the stereo disc was criticized by some writers. One reported that, as the prime feature of the convention, the stereo disc met with unqualified acceptance and was seen as a sort of merchandising panacea, the new Pied Piper that could lead the industry into another boom. Many of the phonographs on display were found to have characteristics that would not be tolerated in monophonic sets; the speakers were too close together to gain any directional effects. The mysteries of the new Westrex cutter were far from solved, and the new discs had much lower volume levels than monophonic discs and therefore reproduced more noise and distortion when the volume was increased.

Other problems, while noticeable in monophonic reproduction, now became gross exaggerations with stereo. These included rumble, which the vertically sensitive pickups produced from the less-than-silent record-changer motors; a swishing sound caused by off-center spindle holes on the discs, and a cyclic type of sound, which was due to slight warpage of the discs. However, there were some excellent discs. London Records were consistently the best quality, due probably to their head start in stereo disc development.<sup>38</sup>

### **Suggested cures**

Cures were suggested for some of these ailments, which were not always due to the recordings. B. B. Bauer found the difference

in true high-fidelity performances between monophonic and equal stereophonic equipment not nearly as great as might be expected. He suggested, to minimize rumble, elimination of mechanical feedback to the pickup cartridge, and good cushioning of the motorboard. To assure a minimum of noise, hiss and record scratch, the pickup should have a smooth, uniform frequency response, and the loudspeakers should match it. He believed that if these suggestions were followed, the hiss level on good stereo discs would generally be inaudible or, in any event, limited only by the hiss level of the original master tape.<sup>39</sup>

With the latest advancement in the recording and processing techniques for stereophonic records, the surface noise is found to be equal to that of the best LP's . . .

Stereophonic disc reproduction today offers the intrinsic quality of LP record reproduction with the added realism of three-dimensional sound. To achieve its full potentialities, the playback equipment should be designed using good engineering practices . . . The reward for these simple precautions will be an unsurpassed new experience in sound reproduction.<sup>40</sup>

### **Stereo disc popularity**

*Consumer Reports* offered support to stereo, but urged caution concerning the welter of claims. Decisions on equipment were found to be difficult due to the great variation in quality and price. More than 60 manufacturers were offering stereo players in several times as many brands, models and degrees of completeness, as of October, 1958. None of the many consumers who spent close to \$400,000,000 a year for records were expected to escape the word stereo. The magazine continued with a prediction that stereo might push into obsolescence the better than 10,000,000 comparatively new phonographs bought in the past few years.<sup>41</sup>

Advice was offered educational institutions for converting their phonographs to stereo with one of the numerous package units available for that purpose (Fig. 510). Some of the existing school equipment was found to meet the stereo requirements and converted easily:

Schools and colleges with courses in music listening, or appreciation, should also consider the possibility of equipping at least the "music room" with a stereophonic phonograph.<sup>42</sup>

To compete with the package-set manufacturers, makers of better-quality high-fidelity components, such as Fisher and Pilot, brought out smaller packages at low cost that delivered higher-quality stereo in cabinetry that was still pleasing in design. They

tried to show that a stereo phonograph needn't cost anywhere near twice as much as a monophonic phonograph.<sup>43</sup>

Stereo was moving ahead in Britain too. The fourth Audio Fair in January, 1959, attracted 30,000 visitors in 3 days, mainly to see and hear stereo. It was reported that "nearly every manufacturer showed stereophonic equipment — all new units specifically designed for making the best of stereo."<sup>44</sup>

With no abatement of the stereo boom, Bert Whyte was moved by February to say, "Stereo has arrived at last and it is only a question of time before it completely supplants monophonic sound."<sup>45</sup> Harold Schonberg felt that it shouldn't be long before all the recording problems were ironed out. He found remarkable improvement in the early spring releases of 1959. It must not be

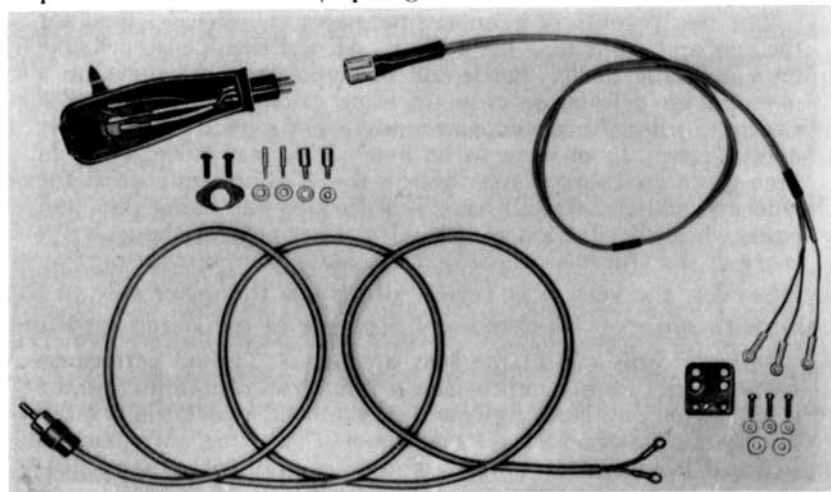

Fig. 510. This kit, together with stereo cartridge, converts record changers to stereo. (British Industries Corp.)

forgotten, he warned, that most of the master tapes used in recording the early stereo discs were actually recorded in the first place with release on stereo tape in mind, not stereo discs. The disc posed entirely different problems from tape, and the engineers did not have long to work on the disc's specific problems, which Schonberg saw as: (1) rumble, (2) surface noise, (3) low-frequency response and (4) lack of separation. The early Westrex cutters were filtered off in the high end because of distortion resulting when it was attempted to etch these frequencies on the record. Schonberg thought the frequency response was not as important as other values, and found the sound brilliant even when cut off at 10,000 cycles. He predicted that stereo was now

here to stay, with nothing new appearing on the horizon.<sup>46</sup>

Some recording companies were better prepared to release stereo discs, with a large backlog of stereo tapes in their libraries. Columbia Records, for example, had been recording on triple-track stereo tape since 1957, and all material recorded since then can now be released on disc.<sup>47</sup> Even smaller companies, such as Jubilee Records,<sup>48</sup> were often lucky enough to have recorded material in stereo some years ago, even though they did not manufacture stereophonic tapes. When the stereo disc hit, they released five albums immediately.

Record reviews waxed enthusiastic over the many excellent stereo discs appearing on the market. Here are excerpts referring to a London stereo disc set of *Alice in Wonderland*:

The results couldn't be more impressive . . . (It) is a treat for the ears and — almost — the eyes . . . All the familiar scenes take on a dramatic clarity that would be impossible to achieve on a monophonic release, or even, in some cases, on the stage. For example, when Alice swims around in her own tears, not only does the very room seem to be flooded but her voice has even been given an appropriately hollow sound. The sequence at the Duchess' house may well have you ducking the flying pots and pans, while the illusion of actually taking part in the mad tea party or the Queen's croquet game is little short of startling.<sup>49</sup>

However, the very next review illustrates the other side of the coin, with some of the extremely poor use of the stereo medium:

Mike Nichols and Elaine May are two . . . gifted performers whose special forte is improvising a humorous situation around a given theme . . . Nothing is added, however, and quite a bit is lost by the use of a sort of "spurio stereo" in which Mr. Nichols is heard from the left speaker and Miss May from the right — even, as in one routine, when they are supposed to be dancing together! The monophonic release is certainly the preferred one here. . . .<sup>50</sup>

In May, 1959, Peter C. Pfunke, writing in *The American Record Guide*, praised the fine quality of nearly all new jazz stereo discs and wondered why stereo classical releases did not have such good surfaces and quality of sound. He deduced that jazz discs (because the market for them is considerably larger) get consistently better treatment in production. He wished the same were true for classical discs.<sup>51</sup>

The sale of stereo recordings for background music galled Mr. Pfunke, who found them ill suited for that use because of the amount of listening attention they draw. Stressing directional characteristics was wrong also. He felt the main satisfactions of stereo were clarity and naturalness of timbre. He continued:

Stereo, in the past year, has shown itself to be coming of age, technically, to the point where we need no longer regard it with a large question mark – quandaries over four-track vs. two-track tape and methods of FM multiplex operation notwithstanding. Stereo has shown itself to be a major step forward in the audio art. Most significantly, stereo has shown itself to be a boon to lovers of no noise, but music.<sup>52</sup>

A “Year I Report” on 45/45 stereo discs by David Hall listed what his magazine’s staff considered the 99 best stereo discs.<sup>53</sup> The writer heartily agrees with their choices on all the discs on the list that he has bought or auditioned for radio broadcast. The staff was also asked what labels, if any, were producing stereo recordings of consistently high quality. The ratings were extremely variable, with London Records the unanimous choice for top quality. Capitol, Audio Fidelity, Epic and Everest received merit citations also. According to Hall, the most persistent faults in the new stereo discs were:

1. Excessive volume levels on some discs with resultant high-frequency distortion and “breakup”;
2. Insufficient volume levels with resulting high surface noises;
3. Distortion toward the center of the record where complex, high-level music is involved;
4. Unnatural sonics, resulting from exaggerated ping-pong effects or from too close and shallow microphoning.<sup>54</sup>

Hall went on to say that they had every reason to believe that most of these deficiencies were in the course of being remedied, and enough absolutely first-rate stereo discs had been produced during the 12 hectic months from July, 1958 to July, 1959 to warrant a considerably larger check list than 99 discs.<sup>55</sup>

While all this was going on, pickup manufacturers were engaged in crash programs to develop their own stereo cartridges and to outdo their competitors. Once the dust cleared, there were a large number of stereo pickups on the market. They appeared in all sizes, shapes, descriptions and prices. Some are shown in Fig. 511.

### **Stereo 45-rpm discs**

All the stereo disc activity was not confined to 33 $\frac{1}{3}$  LP discs: the English<sup>56</sup> had issued 45-rpm stereo discs in the standard large-hole 7-inch size, mainly because this enabled more people to enjoy stereo discs. In May, 1959, the V-M Co. advertised the first automatic portable “45” stereo phonograph on the US market. It had a 6-inch speaker in its case, and a duplicate in the lid to the case, which was removed and placed several feet to one side for the

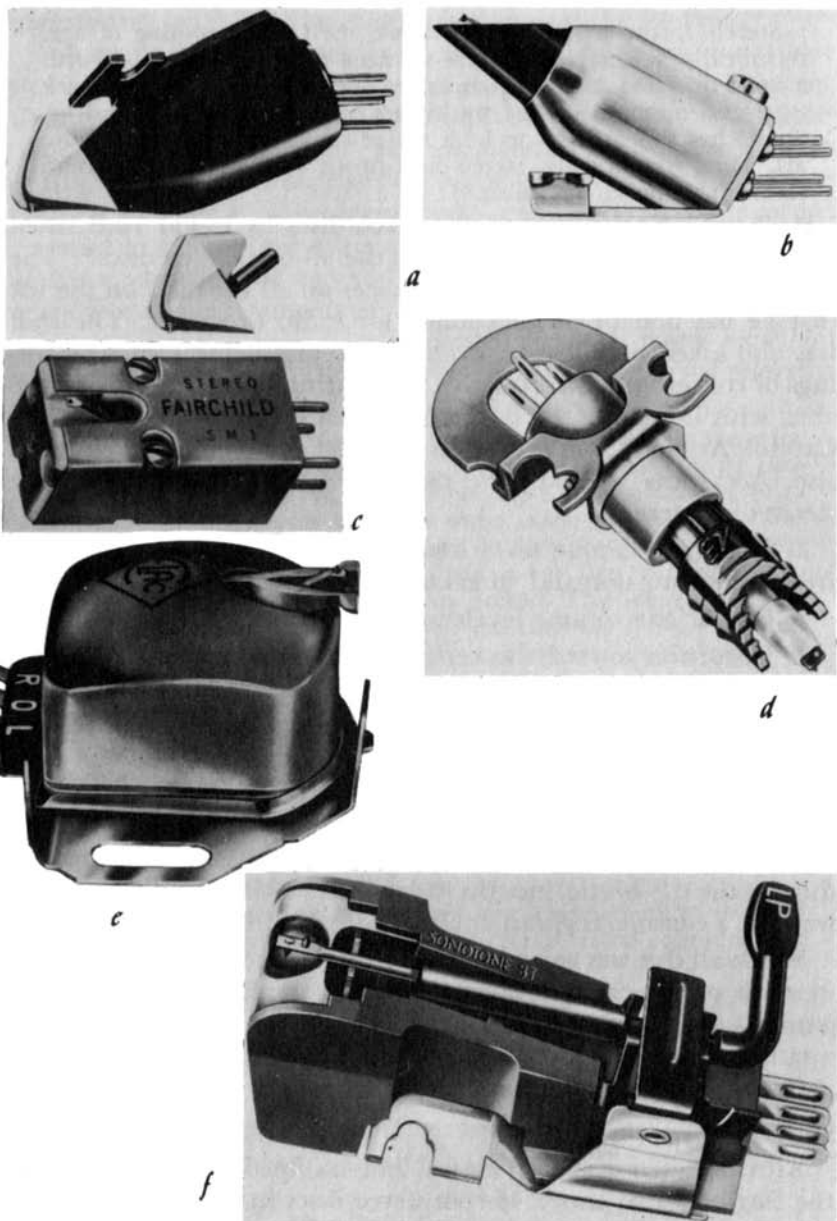

Fig. 511. Some examples of the many stereo cartridges available. (a) Moving-magnet type. (Pickering & Co., Inc.) (b) This variable-reluctance type uses four magnetic poles with a rotating x-shaped multiple pole piece. (Dynaco Corp.) (c) Rotating spherical magnet-type cartridge. (Fairchild Recording Equipment Co.) (d) Ceramic-type replaceable by identical plug-in cartridges. (Electro-Voice, Inc.) (e) Variable-reluctance type. (Audiogersh Corp.) (f) Ceramic pickup with turnover stylus. (Sonotone Corp.)

stereo effect. The two-speed phonograph also played the 16-rpm "talking-book" records.<sup>57</sup>

However, the main reason for the existence of stereo 45-rpm records was to feed the nation's jukeboxes.

### Bibliography and References

- <sup>1</sup> Norman H. Crowhurst, *Stereophonic Sound*, (New York: John F. Rider Publisher, Inc., 1958), pages 60-61.
- <sup>2</sup> *Ibid.*, page 61.
- <sup>3</sup> Ernest La Prade, *Broadcasting Music*, (New York: Rhinehardt & Co., Inc., 1944), pages 216-217.
- <sup>4</sup> William J. Kendall, *Hi-Fi Handbook* (New York: Thomas Y. Crowell Co., 1956), page 151.
- <sup>5</sup> Emory Cook, "Recording Binaural Sound on Discs," *Tele-Tech*, November 1952, page 50.
- <sup>6</sup> Bert Whyte, "Certified Record Review," *Radio & Television News*, March 1957, page 48.
- <sup>7</sup> John T. Mullin, "Monogroove Stereophonic Disc Recording," *Journal of the AES*, October 1954, pages 249-251.
- <sup>8</sup> Jerry B. Minter, "Stereo Disc Recording Methods," *Radio & TV News*, October 1958, page 66.
- <sup>9</sup> *Ibid.*, page 112.
- <sup>10</sup> Minter, *op. cit.*, page 112.
- <sup>11</sup> Donald Carl Hoefler, "Heart of Stereo," *Modern Hi-Fi*, Summer 1959, page 66.
- <sup>12</sup> *Ibid.*, pages 67, 78.
- <sup>13</sup> "The Stereo Record and Its Player," *Audition*, Section 2, September 1958, page 9.
- <sup>14</sup> Minter, *op. cit.*, page 66.
- <sup>15</sup> Crowhurst, "Single-Groove Stereodiscs," *RADIO-ELECTRONICS Magazine*, January 1958, page 56.
- <sup>16</sup> "The Stereo Record and Its Player," *op. cit.*, page 9.
- <sup>17</sup> Crowhurst, "Single-Groove Stereodisc," *op. cit.*, page 56.
- <sup>18</sup> "The Stereo Record and Its Player," *op. cit.*, page 56
- <sup>19</sup> H. A. M. Clark, "Stereophony on Disc," *Engineering*, April 4, 1958, page 448.
- <sup>20</sup> Crowhurst, "Single-Groove Stereodiscs," *op. cit.*, page 56.
- <sup>21</sup> Herman Burstein, "Stereo Glossary," *Radio & TV News*, October 1958, page 70.
- <sup>22</sup> Crowhurst, "Single-Groove Stereodiscs," *op. cit.*, page 56
- <sup>23</sup> *Supra*, page 109.
- <sup>24</sup> Maximillian Weil, "New Approach to Stereo Records," *Audio*, June 1958, pages 28, 59.
- <sup>25</sup> "Stereo Race Adopts Color TV Semantics," *Broadcasting*, April 21, 1958, page 72.
- <sup>26</sup> Louis E. Garner, Jr., "Stereo Then and Now," *RADIO-ELECTRONICS Magazine*, March 1959, page 54.
- <sup>27</sup> *Ibid.*, page 55.
- <sup>28</sup> C. G. McProud, "Editor's Review," *Audio*, April 1958, page 16.
- <sup>29</sup> "Stereo Race Adopts Color TV Semantics," *op. cit.*, pages 72-73.
- <sup>30</sup> *Ibid.*, page 72.
- <sup>31</sup> Garner, *op. cit.*, page 54.



- <sup>82</sup> From liner notes to Kapp LP stereo "sampler" disc, "The World's Great Music in Stereophonic 'Total Sound,'" KC-9081-S.
- <sup>83</sup> "Available Stereophony," *Engineering*, May 2, 1958, page 576.
- <sup>84</sup> "Stereo Gear Takes Industry Spotlight," *Broadcasting*, June 9, 1958, page 89.
- <sup>85</sup> *Ibid.*
- <sup>86</sup> Bert White, "Certified Record Review," *Radio & TV News*, September 1958, page 134.
- <sup>87</sup> "Big Stereo Push Coming," *Electronics*, Aug. 15, 1958, page 14.
- <sup>88</sup> Bert Whyte, "Certified Record Review," *Radio & TV News*, October 1958, page 106.
- <sup>89</sup> B. B. Bauer, "Improving Performance of Stereophonic Disc Playback Systems," *Audio*, August 1958, page 36.
- <sup>90</sup> *Ibid.*, pages 36, 93.
- <sup>91</sup> "The Big Push Behind Stereo," *Consumers Reports*, October 1958, pages 520-521.
- <sup>92</sup> Sidney Fox, "Stereo," *Film World and A-V News Magazine*, October 1958, page 527.
- <sup>93</sup> Fritz A. Kuttner and Donald J. Plunkett, "The Two Sides of the Stereophonic Disc," *The New York Times*, Sunday, March 15, 1959, Section M, page 10.
- <sup>94</sup> L. A. Mannheim, "A Hi-Fi Fair in England," *Radio & TV News*, February 1959, page 132.
- <sup>95</sup> Bert Whyte, "Certified Record Review," *Radio & TV News*, February 1959, page 122.
- <sup>96</sup> Harold C. Schonberg, "An Interim Period," *The New York Times*, Sunday, March 15, 1959, Section M, pages 1, 7.
- <sup>97</sup> Personal interview with Peter Munves, Columbia Records Sales and Publicity Dept., New York, May 18, 1959.
- <sup>98</sup> Personal interview with Joseph H. Caro, Jubilee Records Album Sales and Promotion, New York, May 18, 1959.
- <sup>99</sup> Stanley Green, "Spoken Word," *HiFi Review*, May 1959, page 78.
- <sup>100</sup> *Ibid.*
- <sup>101</sup> Peter C. Pfunke, "A Strictly Sonic Survey of Stereo Jazz," *The American Record Guide*, May 1959, page 696.
- <sup>102</sup> *Ibid.*, "Stereo is for Music," page 571.
- <sup>103</sup> "99 Best Stereo Disc Buys," *HiFi Review*, July 1959, pages 34-35.
- <sup>104</sup> David Hall, "HiFi Soundings," *HiFi Review*, July 1959, page 6.
- <sup>105</sup> *Ibid.*
- <sup>106</sup> *Supra*, page 123.
- <sup>107</sup> "A One-Two Punch for Knockout Stereo Sales This Spring!" *The Billboard*, May 11, 1959, page 15.

# stereophonic broadcasting

**T**HE fourth medium to be considered in this study, broadcasting, will bring stereophonic sound to more people than ever before when the radio industry goes stereo.

## **Types of stereo broadcasting**

Various types of transmission have been used for stereo broadcasting, although each has inherent disadvantages.

### **AM-AM**

This system was described in Chapter II. It has not been popular in this country since the 1920's, due to its poor use of the spectrum. The system needs two entirely separate AM radio channels or, in other words, two separate radio stations. Since the AM band is already so crowded and spectrum space at a premium, this is wasteful. Also, FCC regulations forbid the owner of one AM station to own another AM station in the same locality. The cooperation of two separate AM stations brings up many problems of a commercial nature.

### **AM-FM**

This system employs two stations, as does the AM-AM type, but it is considerably more economical because many AM radio stations also broadcast simultaneously on FM. The job of feeding one audio channel to the AM transmitter and the other channel to the FM transmitter is quite easy. The listener places his FM receiver on the left, tuning it to the FM channel, and his AM receiver on the right,<sup>1</sup> tuning it to the AM channel, and after

placing himself about  $1\frac{1}{2}$  times the distance of the separation of the two radios, enjoys stereo sound (Fig. 601).

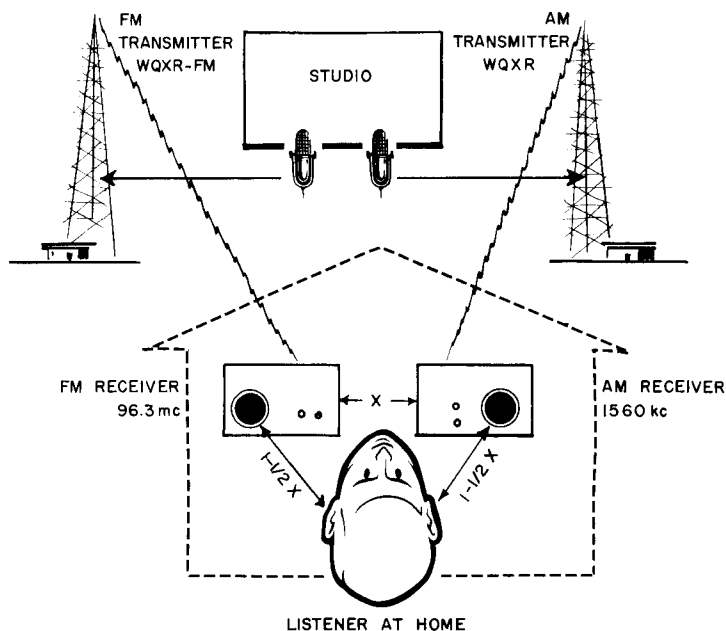

Fig. 601. AM-FM stereocasting system used by stations WQXR and WQXR-FM in New York City. The FM channel carries the left-channel signal, while the right channel goes out via AM.

Many AM-FM stations have been experimentally broadcasting stereo programs by this method since shortly after the World War II, when FM came into new prominence. More than 100 stations in the country now use it intermittently.<sup>2</sup> A typical pair (one AM and one FM receiver) is shown in Fig. 602.

### Disadvantage of AM-FM

The biggest disadvantage of this method is the widely different quality of sound of the two channels. FM reception is clear, wide-range and undistorted, while AM reception is muddy, noisy and of greatly limited frequency range (Fig. 603). It is as though one were listening to a stereo record on which the left side of the groove was a modern LP disc with a quiet surface, and the right side was a worn, ancient shellac 78-rpm record.<sup>3</sup>

### FM-FM

This method is a step in the direction of higher-quality stereocasting, but still contravenes the FCC requirement that the fre-

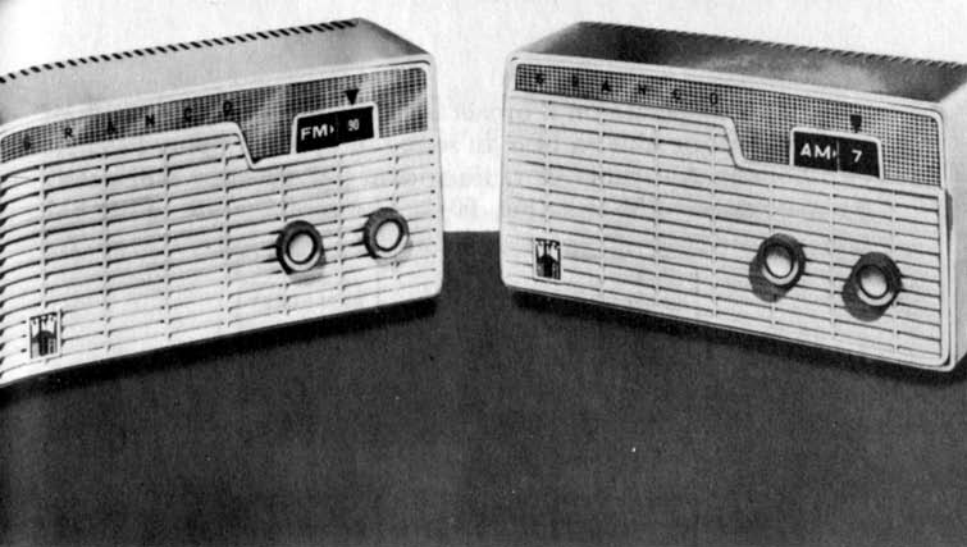

Fig. 602. Stereo "twins", are matched in components and quality and are thus suited for receiving AM-FM stereocasts. (Granco Products, Inc.)

quency spectrum be used in the most efficient manner possible. The sound quality it produces, when the two FM stations which have cooperated for the broadcast are of similar power and characteristics, is superb. Even the best of the multiplex systems<sup>4</sup> fails to achieve the frequency and dynamic range of this method. However, it is very difficult to arrange for two entirely separate FM

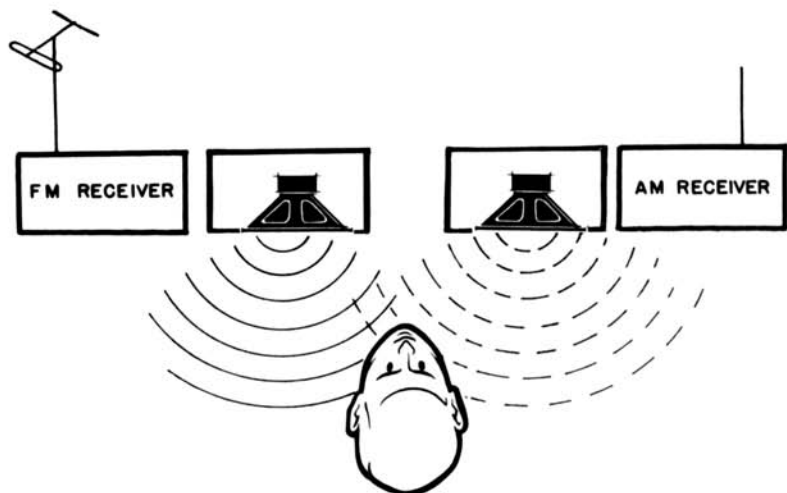

Fig. 603. Diagram showing the difference in quality between AM and FM channels in an AM-FM stereocast. The FM channel is wide-range, noise-free high fidelity. The AM channel is not.

stations to cooperate on a broadcast that only a tiny minority of listeners will be able to hear in stereo. For, while many listeners own both an AM tuner or radio and an FM tuner or radio, very few possess two FM sets (Fig. 604). The combination of an FM

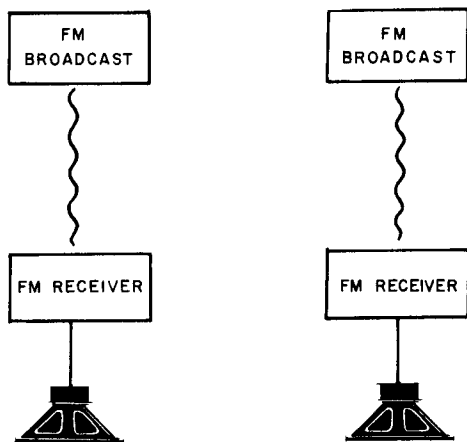

Fig. 604. Simultaneous broadcasting (simulcasting) by FM requires coordination of two FM stations and two FM receivers on the listening end.

table-model radio with an FM tuner and hi-fi system is as unbalanced as the AM-FM setup, and the second matched FM tuner or receiver could be expensive. Therefore, an extremely limited number of FM stations cooperate for this venture at stereocasting.

#### **TV-AM or TV-FM**

This method has so many disadvantages that it is difficult to understand why even a small number of stations and two of the TV networks have attempted it. The sound channel of the television station, which is really also FM, carries one of the two audio signals. The other signal is carried either on a separate FM or a separate AM station (Fig. 605). The listener then places the radio set 8 or 10 feet to one side of the TV set and tries to balance the sound coming from the two sources. Even with the TV-FM method, this is difficult, for TV sound is notoriously bad.

The most annoying part of this type of stereocasting is that, if TV alone is desired, the sound heard is only one half of the program (Fig. 606) unless the listener goes to the bother of setting up an AM or FM radio on one side to receive the second channel. In addition, the television viewer not owning an AM or FM

set would be forced to accept only about half the sound of a program that he wanted to both see *and* hear.<sup>5</sup>

### Three-channel TV and FM radio

A solution to the last problem has been tried by several groups. WGBH-TV, Boston's educational channel 2, presented several

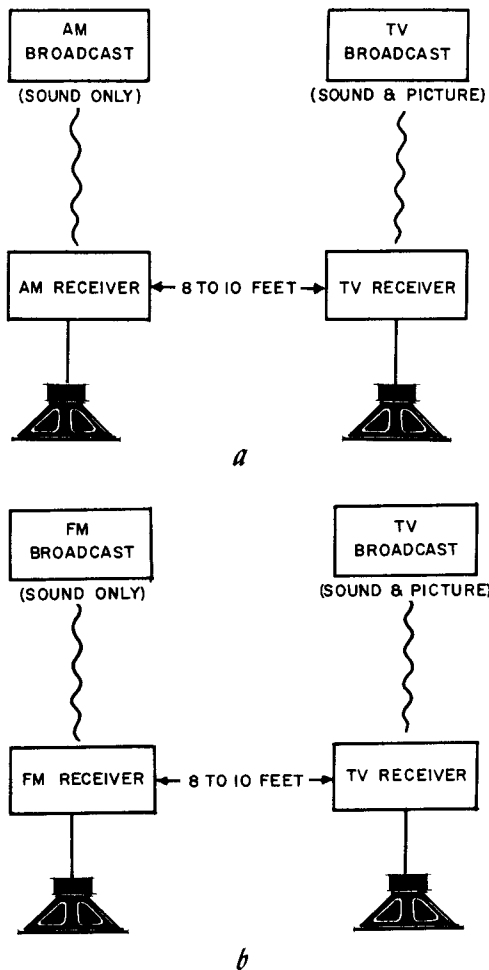

Fig. 605. Other methods of simulcasting use a television-station sound system for the right channel while an AM or FM station broadcasts the left.

three-channel sound transmissions beginning on April 4, 1958. Boston University's station WBUR-FM broadcast the left micro-

phone signal, WGBH-FM broadcast the right, and the television sound carried the pickup of the center microphone (Fig. 607). When the placement of the three channels, two FM and one TV,



Fig. 606. The TV-radio stereocasting method forces the listener who uses one medium only to accept what is virtually half the program. This is avoided to some degree by feeding small amounts of each signal into the other channel.

was duplicated in the listener's home, the stereophonic reproduction was better than with two-channel methods. Since the center microphone picked up a balanced overall sound from the musical groups, a viewer listening to only the television broadcast received a high-quality monophonic signal.<sup>6</sup>

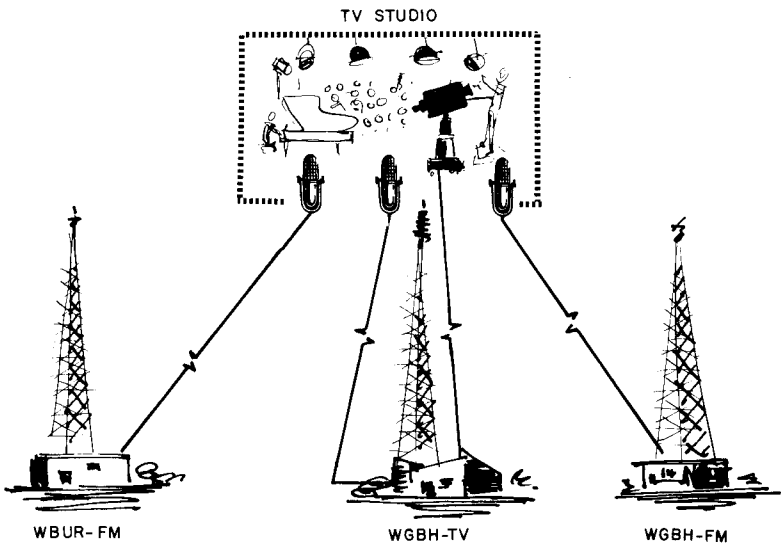

Fig. 607. Three-channel TV-FM-FM stereocasts made in Boston in 1958.

WCRB, in Waltham, Mass., cooperated with television station WHDH in Boston for another three-channel TV and radio program. The program was a special Disneyland show on the life of

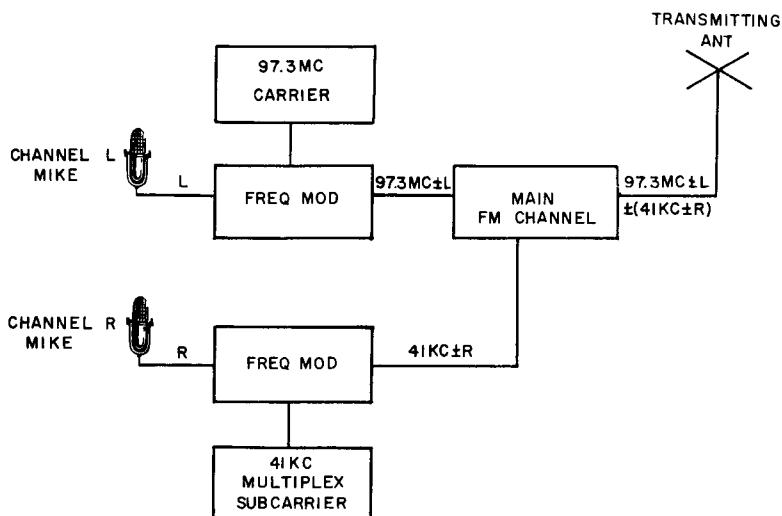

Fig. 608. In FM multiplexing, a principal channel is carried conventionally by the carrier, while a second channel modulates a subcarrier of 41 kc. The modulated subcarrier in turn modulates the main rf carrier.

Tchaikovsky, with scenes from Walt Disney's film "Sleeping Beauty." A three-channel feed was provided by the ABC network. WCRB-FM carried the left-hand signal, WHDH-TV carried the center, and WCRB (AM) the right-hand signal. The picture was seen on WHDH-TV.<sup>7</sup>

## Multiplexing

Radio multiplexing is the practice of transmitting two or more separate messages simultaneously (Fig. 608) from one transmitter, and then, at one receiver, separating the messages so that each can be heard without interference from the other or others.<sup>8</sup>

Multiplexing originated as a way of sending several telephone messages over the same pair of wires without interference. The system was called carrier telephony. One message was sent "as is"; the others were used to modulate carriers of successively higher frequencies. Provided there is no distortion in transmission, the individual carriers can be demodulated at the receiving end, separated and delivered to the appropriate circuits, without interference between them.<sup>9</sup>

Major Edwin H. Armstrong, the inventor of FM, carried on a



series of experiments during 1934, 1939 and 1940. This work produced basic concepts concerning modulation that are reflected in today's multiplex equipment.<sup>10</sup> Much of his investigation of multiplex operation was carried out by John Bose, the major's assistant. The Serrasoid modulator used in multiplex FM broadcast transmitters was invented by James Day, vice president of engineering at Radio Engineering Laboratories.<sup>11</sup>

Applying multiplex to standard radio broadcasting is not exactly new. Eastman and Woodward<sup>12</sup> described a binaural transmission system in 1941 which would permit both audio channels to be carried over the same carrier frequency, thus using only one radio channel and reducing the additional investment required to convert a monaural transmitter to binaural. A combination of a conventional amplitude modulator and a balanced modulator with a 90° phase-shifting network was used to combine the two signals over the single carrier frequency. It worked on the principle that an AM wave which has had the carrier shifted 90° is a good approximation of an FM wave in which the frequency swing is small compared with the applied audio frequency and is proportional to the audio frequency. The transmitter may then be thought of as one in which the signal from the left microphone is transmitted via FM while that of the right microphone is transmitted via AM, both on the same carrier with the bandwidth being no greater than that of a conventional transmitter.<sup>13</sup>

To receive the binaural signal required a device to shift the phase of the carrier by 90° and then apply ordinary detection methods to the signals. Tests using the outputs of two phonographs for the two separate channels showed crosstalk to be 30 db down, more than sufficient for broadcasting good stereo.<sup>14</sup>

## **Musicasting**

Two radio engineers combined the multiplex method with ultra-short-wave radio in 1945 to transmit phone messages across the water separating Cape Charles and Norfolk, Va.,<sup>15</sup> but the first important use of multiplex in radio came in 1955 with the growth of a new radio industry, FM musicasting (Fig. 609). On March 28, 1955, the FCC authorized multiplexing for FM stations.<sup>16</sup> In many American cities, salesmen ventured out to tell businessmen about the psychological need for pleasant background music in factories, stores, etc., and how the service would benefit them.<sup>17</sup>

## **Simplex**

Prior to this time, musicasting had been carried out on a dif-

ferent system — simplex. This method feeds the FM station's regular music programs into restaurants, shops and factories. A sub- or super-audible "beep" blanks the station's announcements and commercials by triggering a special relay on the store-owner's receiver. This method was theoretically banned by the FCC's 1955 decision, but has been allowed a slow death due to inherent technical problems in setting up for multiplex.<sup>18</sup>

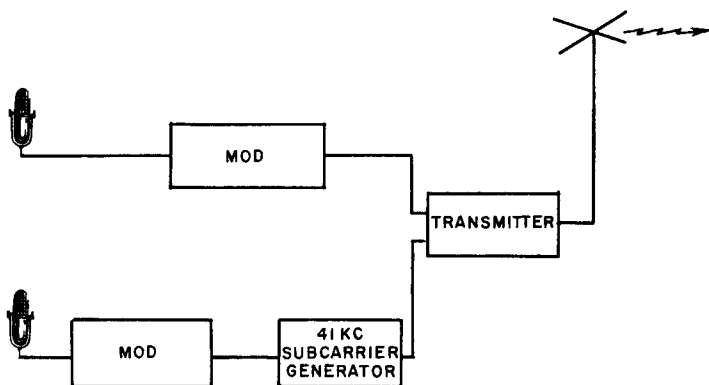

Fig. 609. Schematic diagram of the multiplex method used in musiccasting. The subcarrier signal is added at the transmitter.

On Oct. 1, 1958, the FCC issued an order denying requests for continued simplex operation and ordering stations to convert their musiccasting to multiplex. Station WBFM appealed to the US Court of Appeals for the District of Columbia, to gain an injunction against compliance with the FCC order and received a one-month stay of execution. The station said that it made most of its revenue from musiccasting, but felt that multiplex had not yet reached a stage suitable for WBFM's purposes.<sup>19</sup> A Chicago station, WFME, gained freedom to continue simplexing from the Court of Appeals. They said that the FCC's determination that functional music (musiccasting) was not broadcasting didn't agree with the Communications Act.<sup>20</sup>

### Compatibility

The primary reason for using multiplex to broadcast stereo programs is to gain that quality that engineers attempted to gain with film, tape and stereo discs — compatibility.<sup>21</sup> The only way stereocasting can come into general use is with a system that is electronically compatible. The person viewing a color television program on a black-and-white receiver is seeing electronic compatibility in action. The viewers equipped with color TV sets

see the program in full color. The viewers equipped with black-and-white receivers see the whole picture, not just the left or right half. In other words, everyone has a chance to enjoy the entire program without having his present receiver made obsolete and without losing any detail. This is not true of the "double-transmission" systems we have just discussed (AM-FM, FM-FM, etc.).<sup>22</sup>

Compatibility is also not found in ordinary stereo multiplex. The system must be modified by applying the "sum and difference" theory in order to be compatible.<sup>23</sup> First, however, let us look at an ordinary FM system.

The FM station's bandwidth is quite large — 0.2 mc. This allows room for at least two audio channels with a 15,000-cycle range. To understand how this is done, we must remember that radio waves consist of electromagnetic energy at inaudible frequencies — in the case of FM, 88.1 to 107.9 mc. You can receive the frequency of a station operating in this band, amplify it and connect it to a speaker, but no sound will be heard because the frequency will be far above the human hearing range.<sup>24</sup>

But at the transmitter you can regulate or modulate that energy transmission by applying audible signals to it (Fig. 610). Then, at the receiving end, you can pick up and amplify the inaudible frequency, put it through a detector or demodulator to take off and amplify the voice frequencies, and feed them to a loudspeaker. This is the system of conventional FM broadcasting.

### **The subcarrier**

A super-audible frequency can be modulated at audio frequencies, and an audio-modulated super-audible frequency can be used to modulate a still higher frequency. This is the basis of ordinary FM multiplex transmission.<sup>25</sup>

In musicasting, frequencies of either 41 or 67 kc seem to have come into general use for the supersonic "carrier" frequency. To avoid confusion with the transmitted carrier, this frequency has been called the subcarrier. The extra channel carried on this subcarrier needs a multiplex adapter to recover it (Fig. 611). The regular receiver may reproduce the subcarrier but, being ultrasonic, it is inaudible. However, the regular equalization or de-emphasis in the receiver will tend to eliminate it from the final output of the speaker. To recover the subcarrier's program, whether background music service or the second channel of a stereo presentation, the subcarrier is taken out of the circuit before de-emphasis and fed into an adapter.<sup>26</sup>

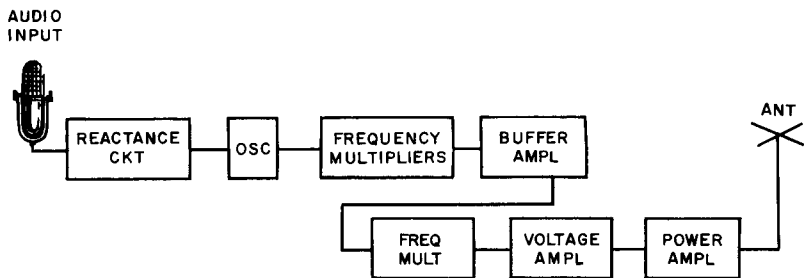

Fig. 610. Block diagram of FM transmitter used in commercial broadcasting.

### Multiplex adapter

In musicasting, the adapter is a simple receiver with no moving parts. It is connected to a standard amplifier and speakers, pro-

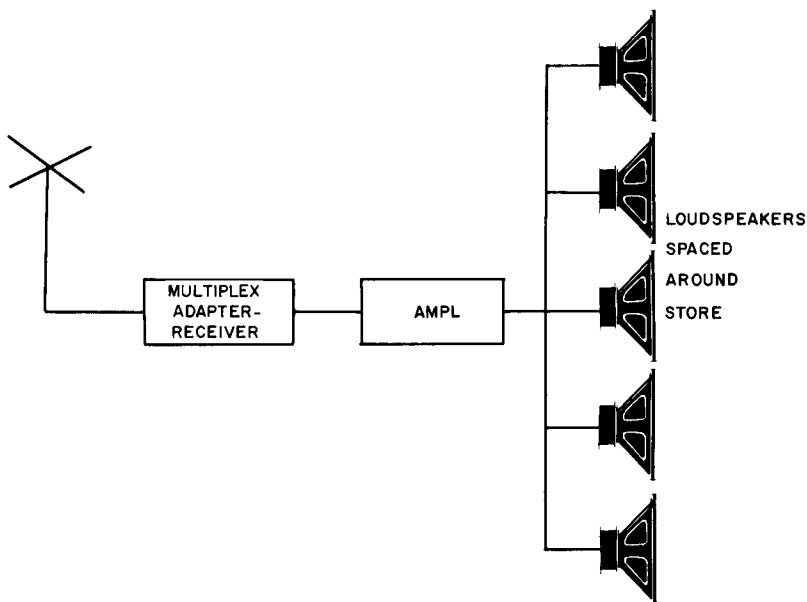

Fig. 611. Diagram of the multiplex method used in musicasting. At the receiving end the subcarrier signal is subtracted and the remaining audio signal is fed to amplifiers and speakers.

viding continuous background music, usually 19 hours per day, to the user. There are no phone charges, which are very steep for lines of good enough quality to reproduce music clearly. There is also no expensive tape recorder or record player to buy and maintain. The musical variety is limited only by the recordings at the radio station.<sup>27</sup>

## Systems of compatible stereo FM multiplex

By the spring of 1959 a total of 17 systems of this genre had been suggested. This naturally caused a more heated discussion of the best system than was the case with the stereo disc, where the number of choices was fewer. Before the manufacturer can start

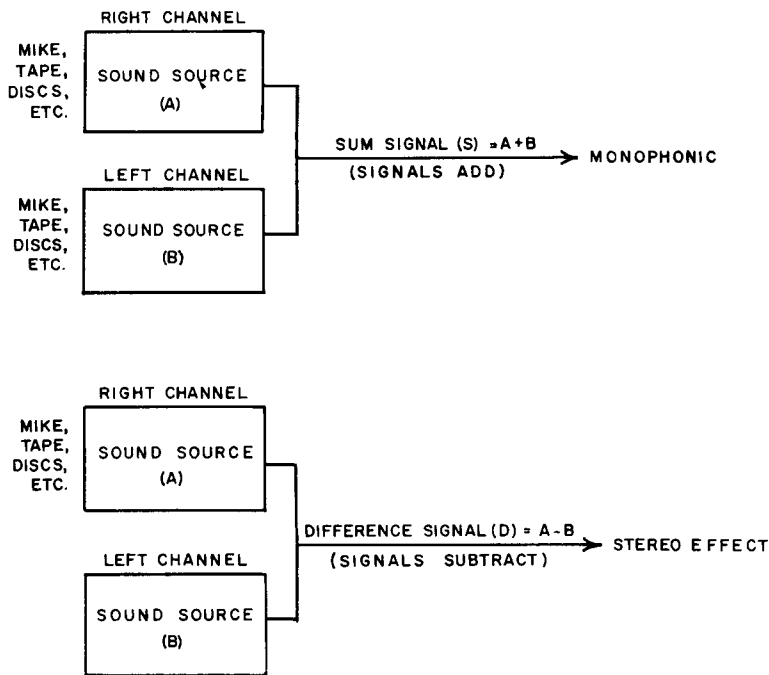

Fig. 612. Monophonic and stereophonic reception of a matrixed stereo-cast by multiplex.

production of multiplex receivers and adapters, he must know what system of multiplex will be used. It is essential that a standard system be chosen so that confusion of the consumer and early obsolescence of the receivers may be avoided.<sup>28</sup>

All the systems are slightly different and all claim to be superior to any other system. To solve this dilemma, the Electronics Industries Association set up the National Stereophonic Radio Committee (NSRC), which held its first panel meeting on March 4, 1958. Panel committees considered the following aspects of the multiplex question:

1. System specifications
2. Interconnecting facilities

3. Transmitters
4. Receivers
5. Field testing
6. Subjective aspects<sup>29</sup>

The committee completed its report at the end of the summer of 1960 and submitted it to the Federal Communications Commission. The decision of the FCC is expected before the beginning of 1961.

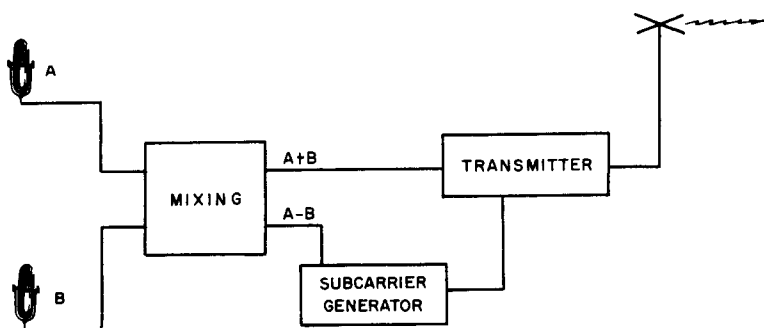

Fig. 613. *The sum-and-difference method in transmission. The transmitter is modulated directly by both channels A and B, and also by a subcarrier generator modulated by frequencies which are the difference between the two audio channels.*

In Canada, a subcommittee of the Canadian Radio Technical Planning Board, with wide representation from industry organizations, is carrying out a similar study of the different systems. Recommendations will be made to the Department of Transport, which will then decide what standards should be used in Canada.<sup>30</sup>

### **Sum and difference signals**

Although not all systems use it, a basic approach to the understanding of a compatible stereo signal is that of "sum and difference." The sum signal (Fig. 612) is simply the electrical addition of the two separate signals from the two stereophonic microphones, tape tracks or sides of the stereo-disc groove. The difference signal is reproduced by subtracting, in an electrical circuit, the signal of one channel from that of the other.

The sum signal consists of all the sound picked up by both channels, and may be used for ordinary monophonic broadcasting. The difference signal contains only the stereophonic information — telling the spatial relationships of the sounds contained in the sum signal. This signal may be used to provide the stereo effect in broadcasting.<sup>31</sup>

To illustrate algebraically, suppose we call the signal from the right channel A and that from the left channel B.

$$\text{Then the sum signal } S = A + B$$

$$\text{The difference signal } D = A - B$$

If we wish to receive the right channel A, we simply add the sum and difference signals:

$$\begin{array}{r} S = A + B \\ D = A - B \\ \hline S + D = 2A \end{array}$$

To receive the left channel B, we simple subtract:

$$\begin{array}{r} S = A + B \\ D = A - B \\ \hline S - D = 2B \end{array}$$

The figure 2 is ignored as this merely indicates the relative volume which would be heard. Now the FM transmitter puts out the sum signal (Fig. 613) in the normal manner, except for a very slight reduction in level. This is received as a normal well-balanced signal on an ordinary FM receiver. The difference signal is then transmitted on the subcarrier, which would not be heard on the standard FM receiver. However, the multiplex adapter would pick out the subcarrier (Fig. 614) with its difference signal and, by performing the algebra outlined here, reconstitute the right- and left-hand channels, feeding them to the separate loudspeakers for the full stereo effect.

Let us now consider several of the suggested plans of compatible FM stereo multiplex.

### **Stereosonic**

One of the earliest on the scene, this system came into use in 1948 as a method for carrying facsimile information on regular FM broadcasts of the New York State Rural Radio Network without interfering with the main programs. William S. Halstead and Murray G. Crosby developed the system, which saw its initial field tests for stereo in 1950, when the Multiplex Development Corp. used standard commercial FM transmitting equipment (formerly used by Station WGYN, New York City). Under the call letters of KE2XKH, the multiplex station supplied multiple-program and stereo transmissions at 97.9 mc with a power of 4,000 watts. At that time, the main channel was modulated to 90% of full frequency modulation and modulation of the main carrier by the 35-kc subcarrier was 10%. In these pioneering tests,

the subcarrier's frequency response was limited to only 8,000 cycles.<sup>32</sup>

In September, 1950, test stereocasts were made from the Reeves Sound Studios in New York City, and, in December, fringe-area listening tests were made at a distance of 45 miles from the station. Two multiplex programs in addition to the main channel program were broadcast with no interference and in compliance with all FCC requirements. Listeners with conventional sets received only the main channel with no trace of the subcarriers. The multiplex signal actually took up less bandwidth than the regular full main channel. This certainly satisfied the economy criterion of best utilizing the radio spectrum. The name of the system, Stereosonic,<sup>33</sup> was chosen to stand for "stereo using an ultrasonic subcarrier."<sup>34</sup>

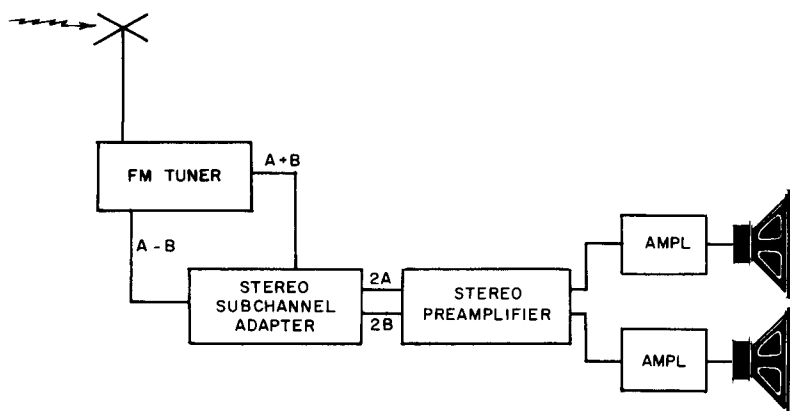

Fig. 614. In the reception of the matrixed stereo signals, the main carrier and subcarrier are separated at the discriminator and fed to adder and subtractor circuits. The resulting 2A and 2B signals then go to the stereo preamp and amplifiers.

In 1953, Major Armstrong and his research group at Columbia University demonstrated his multiplex system before the Radio Club of America. A disadvantage of the system was that it was noncompatible.<sup>35</sup>

### Crosby

This is the best known of the experimental methods and the one that shows the greatest promise of being chosen by the NSRC. It is the creation of Murray Crosby, mentioned in connection with the earlier Stereosonic system. On Sept. 8, 1958, Mr. Crosby and



his Crosby Laboratories, (Syosset, N.Y.) received the patent on the system, which is based on the use of the sum-and-difference theory.<sup>36</sup>

At the transmitter the two channels are fed simultaneously to the main carrier in phase, and to the subcarrier generator out of phase (Fig. 615). At the receiving end the phase-inverter stage in the multiplex adapter separates the signals and feeds them to their respective amplifiers and speakers (see Fig. 616). It is claimed to possess four advantages over other systems:

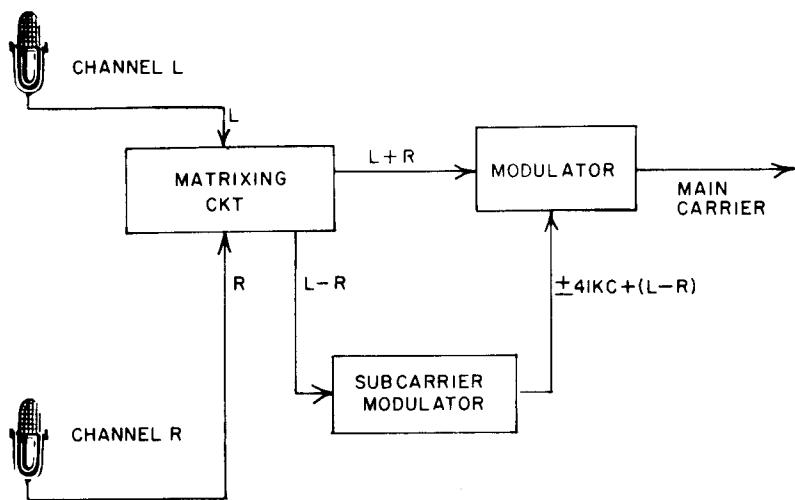
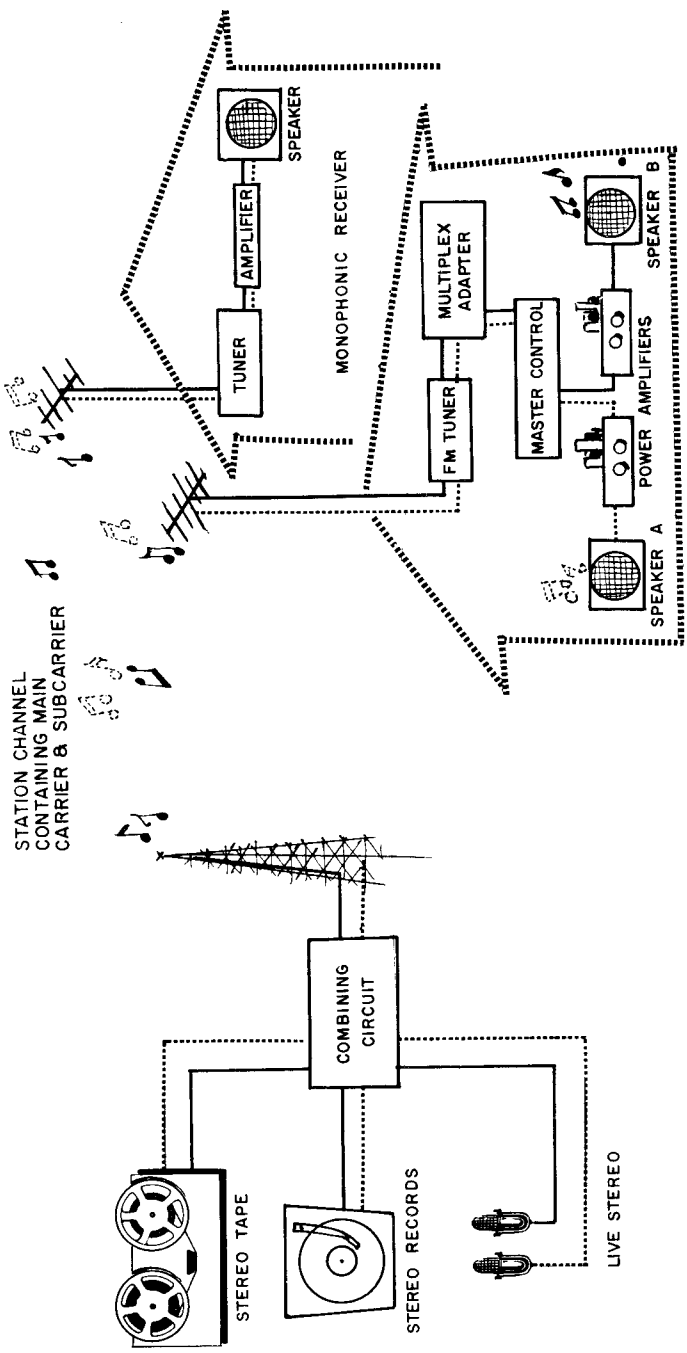

Fig. 615. Block diagram of Crosby method of modulation.

1. Complete compatibility.
2. Full 15,000-cycle audio on both channels, resulting in full fidelity. Both channels are equal in sound quality for a balanced result.
3. The signal-to-noise ratio of each channel is identical, and therefore no annoying "one-sidedness" is noticed.
4. The improvement in signal-to-noise ratio of 6 db is equal to an increase of 4 to 1 in the power obtained. This increases the distance for fringe area stereocasts.<sup>37</sup>

One station, WBAL,<sup>38</sup> in New York City, was on the air with Crosby multiplex stereo from 4 to 5 pm 6 days a week and from 11:00 to 12:00 midnight on Sundays. The station received FCC approval to make the broadcasts, but under stringent rules of operation. After beginning the stereocasting on Sept. 12, 1958, new experimental call letters had to be used — KE2XXT. The only



BROADCAST STATION

STEREOPHONIC RECEIVER

Fig. 616. The Crosby compatible sum-and-difference system permits the monophonic listener to receive both channels, hearing the program as he would any normal FM broadcast. The stereophonic listener unscrambles the signals he receives and feeds them to separate amplifiers and speakers for the stereo effect.

time unlimited multiplex experimenting was permitted was between the hours of midnight and noon.<sup>39</sup>

KDKA, Pittsburgh, used the Crosby system in the fall of 1958. WJER, Wilmington, Del., also began multiplexing with the Crosby system early in October. The NBC FM station in New York City, WRCA-FM, got FCC approval to install Crosby equipment. Stations engaged in FM broadcasting in Seattle, Chicago, Cleveland, Baltimore, Houston, San Francisco and Sacramento were in touch with Crosby about converting their transmitters to his system.<sup>40</sup> At the time of writing (1959), the only station making regular multiplex broadcasts in stereo was WBAI from the Hotel Pierre in New York City.<sup>41</sup> However, by the fall of 1960, no multiplex broadcasts were being made pending the decision of the FCC as to the system to be used.

### **Halstead**

The other developer of the Stereosonic multiplex method is the creator of the Halstead system that was in direct competition with Crosby's system for FCC approval. William Halstead's first system was basically the same as Crosby's, without the use of the sum-and-difference theory. The left channel went directly to the main FM channel and the right went to the multiplex subcarrier. Some of the Crosby stereo system adapters provide for receiving this type of stereocast by a switch which bridges out a circuit needed in the Crosby receiver, but not in the Halstead. The original Halstead proposal was for a right channel restricted to 8,000 cycles, so as to use a subcarrier of similarly restricted width. Otherwise, the right and left channels would be far from identical in quality.<sup>42</sup>

### **Burden**

The successor to the original Halstead proposal, this suggestion aims at overcoming its disadvantages by using the sum-and-difference method in transmission but no counterpart in receiving. Instead, it depends on so-called acoustical matrixing to occur in the listening room. The difference signals are supposed to mix in the room and cancel each other, leaving an audible left and right, respectively. Crowhurst comments that, if such mixing does occur, then there is nothing to stop the left and right channels remaining from mixing also and producing monophonic sound. In short, the stereo effect cannot work.<sup>43</sup>

### **Phantodyne**

As an additional refinement, or perhaps as another change of mind, Halstead proposed the transmission of mixed high frequen-

cies from both channels and the use of a so-called "phantodyne" circuit to mix the channels out of phase with one another.<sup>44</sup> A California station, KCBH, tried using this system of compatible stereocasting<sup>45</sup> while WGHF, Brookfield, Conn., and WASH, Washington, D.C., worked with the older Halstead systems.<sup>46</sup>

The only real advantage of Halstead's various systems seems to be the availability of a *second* subcarrier at about 67 kc, in addition to the one used for stereo transmission of the right-hand channel, at 41 kc. This second subcarrier could be used for musicasting or other restricted-use transmission at the same time that stereocasting is being carried on.<sup>47</sup>

### **Calbest**

Strangely enough, the only receiving equipment for Halstead's system on the market was manufactured and sold by Calbest Electronics, the proponents of still another system of multiplex. At a meeting of the FM Association of Broadcasters, Calbest's representative outlined their system.<sup>48</sup> It goes a step further than Halstead, who claimed the frequencies above 8000 cycles did not contribute to the stereo effect. The Calbest system claims no stereo illusion above 3,500 cycles and uses this to restrict the bandwidth even more.

The main channel is treated much the same as the Crosby system, with the left and right mixed together to give a sum. But for the subcarrier, the right channel is transmitted with everything above 3,500 cycles cut off by a filter. At the receiver, after detection of the subcarrier, it is phase-reversed and combined with the main carrier output to cancel the right component there (below 3,500 cycles). At the same time, a filter takes everything above 3,500 and combines it with the subcarrier to get a right channel complete with highs.<sup>49</sup> The Calbest system gives the same sort of compatibility as the Crosby, but it would allow the broadcaster even more additional multiplex channels than the Halstead. These could be used for numerous special and profitable services.<sup>50</sup>

### **EMI-Percival**

This system, now being used experimentally by the BBC in Britain, is similar to the Crosby system in that the second channel is transmitted on a sideband of the main frequency, above the audio band. It is also somewhat similar in that the main carrier frequency is modulated by a combination of the left and right stereophonic channels ("sum"). In both systems, the main frequency thus carries the compatible monophonic signal while the subcarrier carries all directional information.

The difference comes in the division of transmitter power between the main channel and the subcarrier and between the left and right channels of the stereo. In the Crosby, there is a loss of 6 db in effective power but in the Percival system a narrow subcarrier — 100 cycles — handles the directional information, keeping the loss to only 2 db.<sup>51</sup>

### **Matting system**

Station WFUV-FM situated at Fordham University in the Bronx, N.Y., had its own multiplex system on the air under the guidance of its engineering consultant, Harold Michaels. He designed a "matting system" which combines and mixes both stereo sources at the transmitter in such a way that monophonic reception is assured. Michaels also assisted in the development of a high-fidelity multiplex receiver which breaks up the combination of the stereo sources and separates them to achieve stereo-phony. According to Michaels:

Matting mixes the two stereo sources for full monophonic reception; the multiplex adapter separates them for the desired stereo effect. Thus Fordham University's system is compatible for either monophonic or stereophonic reception.<sup>52</sup>

Other systems which are not multiplex in nature could conceivably be applied to FM multiplex. One of these is the Bell system (Fig. 617) used thus far only on TV-AM and TV-FM.<sup>53</sup> Other multiplex systems could be applied to AM or TV as well as FM. One of these is the Halstead system, in which the AM channel of an AM-FM stereocast could be duplicated on the 41-kc subchannel.<sup>54</sup> Another is the Motorola multiplex system demonstrated on WGN-TV, Chicago.<sup>55</sup>

Hines believes that subscription multiplex is the solution to provide both more money for the station and finer programming for the listener. Programming would not have to be limited to stereo. The subscription listener could also receive straight uninterrupted background music, or news and sports, or just the news and time breaks at intervals. Hines feels multiplex stereo on FM is worth a great deal to the listener:

It must be further considered that any new art requires time to achieve a substantial measure of its ultimate potential. There is no reason to believe that this principle fails to apply to stereophonic reproduction, which is a mere fledgling. Improved techniques . . . yet unforeseen will very likely enable stereophonic sound to substantially increase its present superiority over single-channel sound. Under these circumstances, FM stereophonic reproduction should be a "natural" for which the public is willing to pay in one form or another.<sup>56</sup>

Support for Hines' views comes from the editor of *HiFi Review*, who points out that, in sharp contrast to color TV, stereo broadcasting is more desired by the listeners than by the stations themselves. Most broadcasting stations are still dubious about the uneven quality of many stereo discs, and stereo presents many production problems in other details.

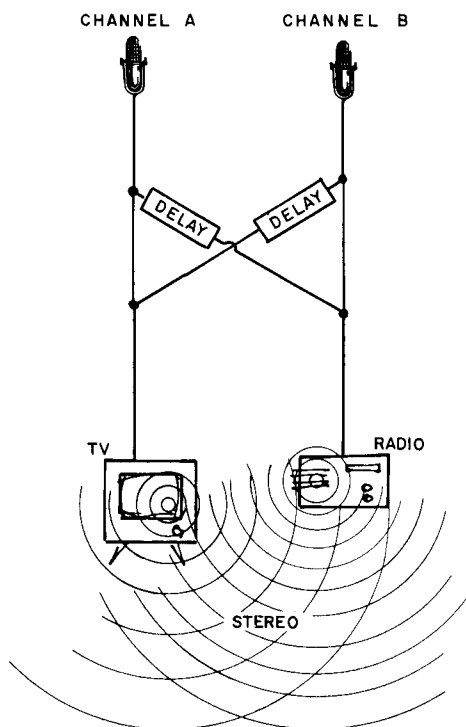

Fig. 617. Bell Laboratories stereocasting system which may be used with any two broadcasting mediums, and is compatible.

FM multiplex enthusiasts privately admit that the FCC has good reason for dragging its feet and not making a hasty decision. Simultaneously, it is even more doubtful that it will approve various "compatible" AM methods now being offered to the public as being as good as straight FM multiplex.<sup>57</sup>

### **AM stereocasting systems**

While some of the FM multiplex systems can be applied to AM radio, the characteristics of the two methods of transmission differ so greatly that it is possible the NSRC will choose one sys-

tem for FM and another for AM.<sup>58</sup> Let us now investigate some of the AM methods that have been called "doubtful."

## **RCA**

The RCA method of AM stereocasting, probably the best known at the present time, was disclosed on Oct. 23, 1958. It was described as "perhaps the longest forward stride in the standard radio broadcast field in nearly 30 years." During a demonstration early in 1959 at the David Sarnoff Research Center in Princeton, N.J., Dr. Hillier said:

Until now, there has been no stereo system that operates entirely in the AM range. This has left a gap in the pattern of stereophonic sound reproduction, since the bulk of commercial broadcasting and listening in . . . this country, including all automobile radios,<sup>59</sup> is in the AM band. With the closing of this gap we can look forward to the ever more extensive use of stereophonic techniques in our radio programming and listening.<sup>60</sup>

In the RCA stereo system the signals from the two microphones are amplified and then modulated, the carrier frequency being supplied by the transmitter's oscillator. In each case this gives us an upper and lower sideband; in other words, two left and two right sidebands. These are reduced to a single left and right sideband after passing through a bandpass filter and each going to an adding component before being amplified at the radio frequency and going to the antenna.

In the stereo receiver, the two sidebands are separated and fed to left and right speakers to reproduce the stereo effect picked up at the studio. Both sidebands pass through standard detection and amplification. Then a sideband filter takes out the unwanted sideband in each case, and the two sidebands and their carriers pass through a pair of second detectors after which the separate sidebands are amplified and go to their respective speakers.<sup>61</sup>

The advantages are reported to be:

1. Stereo music and other program material can be sent from a single transmitter operating within the present AM frequency of a station.

2. Stereo reception is accomplished with a single receiver feeding into matched loudspeakers that can be brought into desired balance with a single control.

3. Since the system operates on AM, it can be used in auto radios, of which the greatest number are AM.

4. The stereophonic system is adapted to present AM broadcasting techniques, so that it could be introduced without causing obsolescence of present receivers.<sup>62</sup>

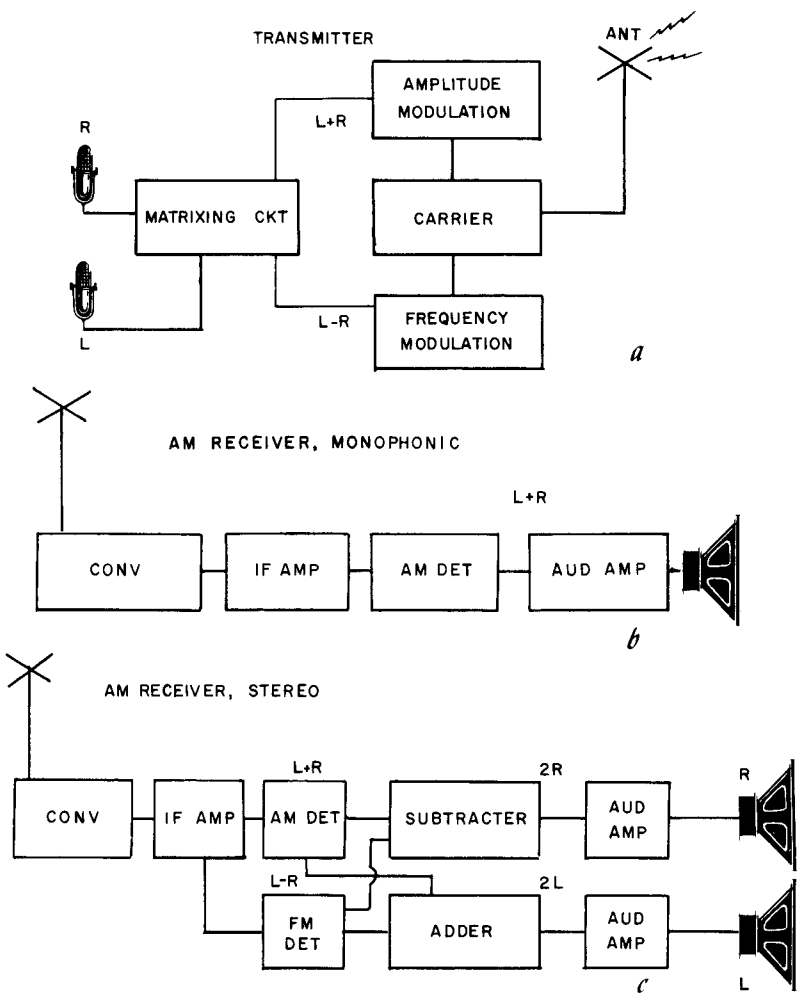

Fig. 618. The Westinghouse AM stereocasting system uses a matrixed signal similar to that of the Crosby system. The  $L + R$  signal amplitude-modulates the rf carrier in conventional fashion. The  $L - R$  signal frequency modulates the carrier (a). For monophonic reception (b), the  $L + R$  signal is conventionally received and detected by any AM radio. For stereo reception (c) a special receiver or an adapter attached to a conventional radio must be used.

Another "advantage," which seems a rather odd argument was expounded by O. B. Hanson:

5. AM radio lacks high fidelity. Women have greater sensitivity in the high frequencies of hearing and many find it uncomfortable to attend a live concert because the extremely high notes hurt their ears. Hanson said FM radio has the same disadvantage because it reproduces sounds even beyond the range of human



hearing. RCA's system, because of the use of AM, would automatically "screen out" the high notes that bother some persons.<sup>63</sup>

### **Westinghouse**

This company's Television-Radio Div. demonstrated its single-channel AM system (Fig. 618) in New York in March, 1959. The double signal is transmitted by simultaneous amplitude and frequency modulation of the carrier. Owners of two AM radios can have mediocre stereo sound by tuning one set somewhat below and the other somewhat above the station's number on the dial. Reception for the single-set listener is unaffected. If demand warrants, Westinghouse will produce a small receiver designed for the system, with separate circuits and multiple speakers. The principle of varying the carrier frequency to carry the stereophonic information is based on the company's conclusion that all the stereophonic information is contained in the band from 300 to 3,000 cycles. Therefore, frequency modulation can be used for the stereo information without interfering with adjacent AM stations on the dial. The transmitter conversion for this system would cost more than with the RCA method.<sup>64</sup> The new system is reported to resemble closely a duplex radio transmission system pioneered by Dr. Frank Conrad of Westinghouse in the 1920's.<sup>65</sup>

Another rather similar system based on the sum-and-difference theory was demonstrated in March 1959, over KDKA, Pittsburgh. Developed by C. W. Baugh Jr. and Harold F. Sweeney, the receiver for the system consists of an FM detector, adder and subtractor, plus a speaker. When this is added to a standard AM receiver, it converts it into an AM compatible stereo receiver.<sup>66</sup>

### **Philco**

Philco Corp. claims its system will bring stereophonic sound into every American home. Details are not presently available, but the system seems to resemble the RCA plan in that it doesn't affect present AM transmission to monophonic receivers, new frequencies are not needed and stations can switch from monophonic to stereophonic transmission and back again at will. Philco has started field testing and, when it is completed, will cooperate with any licensed broadcaster and with the NSRC.<sup>67</sup>

### **Bell**

The Bell Telephone AM system has resulted from years of stereophonic research by their laboratories. The patent, given to Floyd K. Becker, describes a system based on the Haas effect.<sup>68</sup> It has not yet been used for multiplex, but could be.<sup>69</sup> The Perry

Como television show has seen demonstrations of this system, which was designed to allow a listener restricted to one channel only to receive the contribution of the other channel's sound monophonically.<sup>70</sup>

The system has a certain similarity to the Burden system in the division of the channels, but depends for success on the Haas effect, called by the Bell engineers the "precedence effect." The two lines to the transmitters, which may be any combination of TV, FM or AM or multiplex, are cross-connected. Sounds coming from the left microphone are fed to the left speaker in the listener's home, while the same signal is delayed from 5 to 30 milliseconds before reaching the right speaker. As a result of the precedence effect, the sound seems to come only from the left speaker. The same thing takes place with the right channel. The listener's brain localizes the sound he hears as coming directly from each of his two speakers and the full stereo effect is maintained.

Since a listener to each single channel hears the total sound from *both* microphones in a balanced reproduction, monophonic reception is completely compatible. The slight delay, typically about 10 milliseconds, with the delayed channel volume about 1½ db softer, does not affect the reception at all, according to Becker.<sup>71</sup>

Not unlike the Bell system in concept, the system proposed by Becker (Figs. 619 and 620) also depends on slight time delays in separate-channel transmission. The delay is small enough so that nearly complete compatibility is possible with this method. In addition, the system is so flexible that FM multiplexing can be used for the second channel without affecting monophonic listening quality.

Two systems about which little detailed information is available at the present time bring to a close this survey of stereocasting systems. The first was an imaginative suggestion from W. H. Collins of the Electroplex Corp. He suggested using the TV channel audio on "dark channels" for the transmission of a second stereo channel along with a regular FM station.<sup>72</sup> This would, while still employing two entire broadcast channels, still be economical since no station in a particular locale would or could be using the unoccupied TV channels.

The second idea, put forth by Leonard Kahn of Kahn Research Laboratories, was a variation on the single-sideband system which would enable a single AM station to stereocast.<sup>73</sup>

June 10, 1959, was the deadline for comments on stereocasting

systems to be filed with the FCC. The comments that the NSRC considered include:

(a) Should stereo broadcasting be permitted on a regular basis and, if so, should it be a broadcast service to the general public or available only on a subscription basis?

(b) What quality and performance standards, if any, should be applied to stereo multiplexing?

(c) Should specific subcarrier frequencies be allocated to stereo?

(d) Should present main-channel quality and performance standards be relaxed beyond that already permitted for subsidiary communications (non-broadcast) operations to accommodate stereo?

(e) What transmission standards should be adopted regarding crosstalk between the main channel and stereophonic subchannel?

(f) Should FM broadcast stations airing stereo be required to use a compatible system which allows listeners tuned to the main channel to hear an aurally balanced program?<sup>74</sup>

A view opposed to that of the high-fidelity fans in regard to AM stereo is heard from CBS' Dr. Frank Stanton. He believes stereocasting will definitely come into general use but on AM rather than FM, "because there aren't enough FM outlets." Even if the FCC does license more FM than AM stereo outlets, Stanton believes FM will be too late and an AM stereo system will already be on the market.<sup>75</sup>

### **Survey of stereocasting activity**

While the alterations over multiplexing continued, broadcasting stations around the world merrily devoted thousands of hours to stereophonic broadcasting of the two-separate-channel variety, until something better came along.

World leader, as far as amount of stereocasting goes, seems to have been Boston's WCRB. The station programmed 40 hours of AM-FM stereo per week over its twin transmitters. Station president Theodore Jones believes that "FM's future lies with the AM-FM stereo operator,"<sup>76</sup> and the station certainly demonstrated what it preached. Stereocasting began in 1954 for about 4 hours per week. The stereo tapes used were mostly produced by WCRB, beginning with *Choruses of New England*. The early Cook stereo discs were also used.

The library at WCRB included some 400 classical commercial stereo tapes, 200 WCRB-produced tapes and hundreds of the latest stereo discs. Regular live stereophonic concerts began with the 1957-58 Saturday evening stereocasts of the Boston Symphony Orchestra, and continued with the following season of Boston Pops concerts. These were followed with delay stereocasts of the

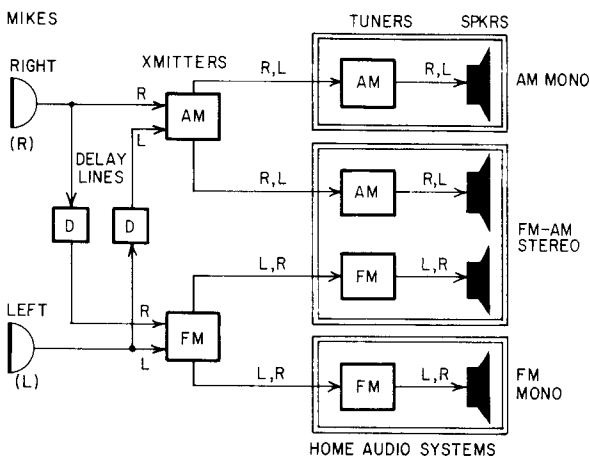

Fig. 619. Similar to the Bell simulcasting system, the Becker method also utilizes time delay circuitry and can be used in several combinations of transmitting media, including FM multiplex.

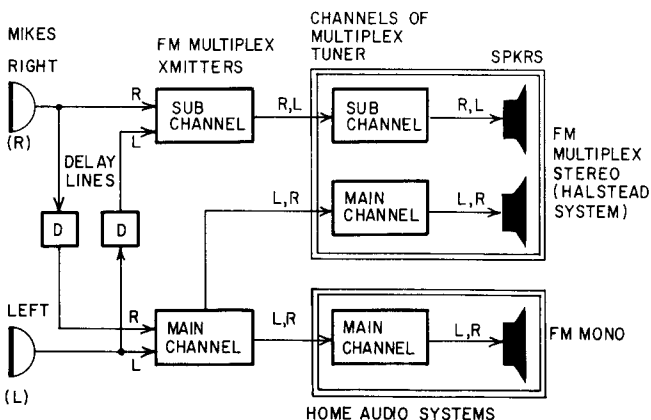

Fig. 620. Reception of stereocasts by the Becker method can utilize several possible combinations of broadcasting media including all-FM by multiplex, using the Halstead system.

1958 Berkshire Music Festival at Tanglewood, Mass. Among the other stereocasting "firsts" at WCRB have been these:

- (1) First in New England to broadcast stereo discs.
- (2) First to present a regular series from stereo tape.
- (3) First to present opera in stereo.
- (4) First radio station to combine with TV for stereocasting in New England.<sup>77</sup>

## AM-FM problems

But to give the other side of the situation, all is not perfect with the AM-FM arrangement. First, control-room operation, which is usually a combination type, is difficult beyond explanation. Each time a record or tape is played, the following steps must be taken:

(1) Cue up disc or tape.

(2) Throw switches feeding left-hand channel to FM transmitter and right-hand channel to AM transmitter.

(3) Tie the two transmitters together by more switching, so that the voice announcements, spoken into one microphone, will be heard on both channels. This constitutes a multitude of switching, producing a lot of noise in a combo studio that can be heard over the air. Therefore, potentiometers are used instead of the microphone switches because they are quieter.

The FM transmitter has only 3,000 watts' power at the transmitter, and the AM transmitter, which puts out a healthy 5,000 watts in the daytime, must cut to 1,000 at night. This allows stations in Brooklyn and Troy, N.Y. situated on the same frequency, to interfere.<sup>78</sup> In a survey of the station's audience, the difficulty of gaining good AM reception was found to cut down the interest in WCRB's stereocasts. About 18% of the listeners included in the survey complained of poor AM reception. Only 35.5% of the respondents had AM-FM stereo equipment, and only 5.5% had equipment for FM-FM broadcasts.

There was also some indication that some people have the necessary AM-FM combination, but do not realize it represents a stereo combination. Both the large number of "no answers" to this question and an occasional inconsistency . . . showed some lack of knowledge concerning stereo . . . among WCRB's listeners.

. . .<sup>79</sup>

The survey also indicates that the great potential of stereo is yet to be realized . . . Before extending its stereo programming farther, the station should probably investigate why 29% of the 35.5% having stereo equipment don't listen to WCRB stereo, whether it is primarily the result of "too much trouble," poor reception, a combination of these factors or some other unsuspected cause.

. . . the station should probably devote more attention to the problem of future stereophonic transmission — which is still in an early, but fast-growing stage of development.<sup>80</sup>

Another of the more than 125 stations that did stereocasting<sup>81</sup> was WQXR in New York City, owned by the *New York Times*. Long known as the "Good Music Station," its chief engineer claims

WQXR's AM signal reaches 15,000 cycles if the receiver is good enough to pick it up. This results in a much better balance with the FM channel in stereocast.<sup>82</sup>

WQXR's interest in stereocasting goes back to Oct. 29 and 30, 1952, when the first broadcasts of stereo tape and live music were made in connection with WQXR-FM. As with most of the AM-FM methods, the FM station broadcast the left channel at 96.3 mc, while the AM station broadcast the right channel at 1560 kc. A year later, WQXR was broadcasting nearly all of its live programs stereophonically.<sup>83</sup> To guard against the two channels being too dissimilar and spoiling single-channel reception, tapes and discs are carefully auditioned beforehand. The station had a permit for multiplexing before the FCC<sup>84</sup> by AM-FM simulcasting (see Fig. 601).<sup>85</sup>

The stations of the State University of Iowa in Iowa City did some of the earliest stereocasting in the United States. The first live stereo broadcasts were made in 1948, shortly after the installation of FM station, KSUI. The new transmitter was paired with AM station, WSUI, for the stereo broadcasts.<sup>86</sup> Live concerts are now being recorded in stereo for future broadcast on WSUI-KSUI. Choral music has been wisely chosen for the first tape-recorded stereocasts due to the thrilling stereophonic effects possible with human voices in chorus.<sup>87</sup>

WCBS in New York City broadcast the 1958 Newport Jazz Festival in AM-FM stereo during July, but they compromised the signal so greatly for the benefit of single-channel listeners that it was difficult to tell if the broadcasts actually were two-channel.<sup>88</sup>

Another FM-AM station situated in Iowa has been broadcasting in stereo regularly for almost 4 years. The first stereocasting activities of WOI and WOI-FM took place in December, 1955. The occasion was the Christmas presentation of the *Messiah* by the Iowa State College Orchestra and Chorus. The microphones were spaced about 30 feet apart in front of the orchestra, dividing the stage approximately into thirds. A second pair of microphones stood about 3 feet apart directly in front of the soloists in the chorus. The results were gratifying and obtained the enthusiastic cooperation of members of the Music Department faculty who had objected to the presence of two "unsightly" microphones where one had stood before.

Two Minneapolis stations, KUOM (AM) and WLOL-FM, engaged in stereocasts each Saturday afternoon for an hour and a half.<sup>89</sup> WUOM, University of Michigan, offered an explanation

for the absence of stereo programming in their program guide. It typifies the attitude of many stations not entering stereocasting at this time:

. . . why is it that more stations have not converted to stereo broadcasting? . . . First, the stereo techniques applied to recording are new, and many years have been spent in perfecting this process. Second, there is still considerable disagreement among broadcasters and engineers as to the best method of stereo broadcasting. Third, the Federal Communications Commission has not yet approved, except experimentally, any system of FM stereo broadcasting. . . .

To achieve . . . compatibility, WUOM engineers have been studying the (Crosby system). This system is now being experimentally used. . . . WUOM has, in addition, studied some of the other methods for stereo broadcasting, and found them wanting, particularly as to compatibility. . . .

And where does WUOM stand? Conversion of its transmitter and audio facilities will be an expensive procedure, and necessitate careful planning and experimentation. Until we are satisfied that we will not sacrifice quality to our many listeners with their present equipment and still offer good stereo quality, we will not convert the station. . . .<sup>90</sup>

### **Stereocasting activity abroad**

Around the world, stereo radio has made as much headway as in the United States. One of Europe's most important radio stations, Radio Geneva (Switzerland), is making great efforts in the field of stereocasting.<sup>91</sup> The West Germans reportedly "have perfected FM radio and FM stereo to quite a remarkable extent." Broadcasting in West Germany is 80% FM, and broadcasts to the Soviet Zone get through the Russian jamming that would stop ordinary AM signals most of the time.<sup>92</sup> The Japanese government is making weekly stereocasts on two AM channels that are very popular.<sup>93</sup>

The British Broadcasting Corp. began stereocasts in January, 1957. Their system was based on the realization that many British homes have both television and radio sets. This provides two loudspeakers and associated amplifiers (Fig. 621) which can be knit together to give the listener a sense of sound in perspective.<sup>94</sup> Stereocasting was not new to the BBC, for they had carried out stereo experiments in 1926 using AM transmitters.<sup>95</sup>

For the recent stereocasts, a number of transmitter tieups were used. Usually the Third Programme transmitters and all the television sound transmitters throughout the country broadcast the right-hand channel's sound, while the Home Service or light Pro-

gramme transmitters broadcast the lefthand channel. After the first stereocast, more than 100 people wrote the BBC telling how it had sounded. About half complained of difficulty in adjusting the receivers. This was due to the different time lengths in the signals' travel from speakers to listener over different paths and to the differing qualities of sound from mismatched speakers.

Phasing was said to cause difficulty also. Both speakers should move in and out at the same time, since the stereo effect depends on phasing differences at the ears, and the unequal phasing of speakers would affect this. Random phasing of the speakers held a 50-50 chance that the sound would be balanced.<sup>96</sup> When more stereo transmissions were made in May, 1958, the phase was reversed by the BBC halfway through the broadcasts. In this typically British solution, listeners were assured that they would have the proper conditions for at least half of the time. Listeners in the London area got a more pronounced effect than those in outlying areas, due to modification of the signals by the landlines connecting the London studios to various transmitters around the rest of the country.

The programs were assembled from stereophonic tapes and stereo discs. Later, it was intended to use stereo tape recordings made by the BBC engineers, as well as live presentations. Since the system used is not compatible, the experiments in Britain are made outside normal broadcast hours, but the BBC is studying multiplexing methods with a view to introducing this system soon on the vhf- (FM) band transmitters.<sup>97</sup>

Obviously many stations are interested in multiplex but cannot go ahead until a decision on a standard system is made. In the meantime, the FCC banned any new public experiments along these lines until they digested a report on the various multiplexing systems submitted to them by the NSRC. By the time this book is off the press, they will probably have made a ruling on the issue.

Even if it is slow in coming, the final decision on a standard system by the National Stereophonic Radio Committee and the rule making of the FCC will be worth the wait and anxiety. It will permit stereocasting to proceed without confusion and to take its place beside other media as the most important purveyor of stereo sound.



## Bibliography and References

- <sup>1</sup> The placing of FM on left and AM on right does not have to be, but this arrangement seems to be standard for these broadcasts.
- <sup>2</sup> Richard Kaye, "Stereo Broadcasting: Which and When?," *High Fidelity*, June 1959, page 97.
- <sup>3</sup> "Stereophonic Radio Reception," printed booklet from Crosby Laboratories, Inc., distributed by WBAI, New York, 1958.
- <sup>4</sup> *Infra*, pages 149–150.
- <sup>5</sup> *Ibid.*
- <sup>6</sup> WGHM Monthly Program Guide, issued by the Lowell Institute Cooperative Broadcasting Council, April 1958.
- <sup>7</sup> Personal interview with Robert Stuart-Vail, chief announcer, WCRB, March 24, 1959.
- <sup>8</sup> Milton B. Sleeper, "We Can Have Hi-Fi FM Stereo," *Hi-Fi Music at Home*, October, 1958, page 119.
- <sup>9</sup> Norman H. Crowhurst, "What Is Compatible Stereo FM Multiplex?," *RADIO-ELECTRONICS Magazine*, March 1959, page 91.
- <sup>10</sup> B. Hines, "FM Multiplexing; a new approach to stereophonic sound," *Radio & Television News*, November 1955, page 55.
- <sup>11</sup> Sleeper, "We Can Have Hi-Fi FM Stereo," *op. cit.*, page 127.
- <sup>12</sup> Austin V. Eastman and John R. Woodward, "Binaural Transmission on a Single Channel," *Electronics*, February 1941, pages 34–36.
- <sup>13</sup> *Ibid.*
- <sup>14</sup> *Ibid.*
- <sup>15</sup> N. F. Schlaack and A. C. Dickieson, "Cape Charles—Norfolk Ultra-Short-Wave Multiplex System," *Proceedings of the IRE*, February 1945, page 78.
- <sup>16</sup> So many multiplex systems were proposed that the FCC became concerned about standards. See the last page of this chapter.
- <sup>17</sup> Walton N. Hershfield, "FM Musicasting, a New Industry," *Radio & TV News*, June 1957, page 128.
- <sup>18</sup> "Have Audience, Can Sell—FM," *Broadcasting*, Feb. 9, 1959, page 131.
- <sup>19</sup> "Muzak's N.Y. FM Fights Order Against Simplex," *Broadcasting*, Oct. 13, 1958, page 108.
- <sup>20</sup> "FCC Appeals Multiplex Decision on Grounds Court Not Informed," *Broadcasting*, Dec. 8, 1958, page 10.
- <sup>21</sup> This was one of the problems raised by multiplexing submitted to the National Stereophonic Radio Committee in 1958.
- <sup>22</sup> "Stereophonic Radio Reception," booklet, *op. cit.*
- <sup>23</sup> Crowhurst, "What Is Compatible Stereo FM Multiplex?" *op. cit.*, page 92.
- <sup>24</sup> Sleeper, "We Can Have Hi-Fi FM Stereo," *op. cit.*, pages 119–120.
- <sup>25</sup> *Ibid.*, page 120.
- <sup>26</sup> Crowhurst, "What Is Compatible Stereo FM Multiplex?" *op. cit.*, page 91.
- <sup>27</sup> Hershfield, *op. cit.*, pages 128–129.
- <sup>28</sup> J. E. Hayes, "Stereophonic Broadcasting," *CBC Times*, May 30–June 5, 1959, page 6.
- <sup>29</sup> "Standardizing Stereo," *Electronic Industries*, March 1959, page 106.
- <sup>30</sup> Hayes, *op. cit.*, page 6.
- <sup>31</sup> *Ibid.*, page 7.
- <sup>32</sup> Albert J. Forman, "New Multiplex System for Three-Dimensional Sound: Stereoscopic System," *Tele-Tech*, April 19, 1953, page 92.
- <sup>33</sup> Not to be confused with the EMI Stereosonic recording system.
- <sup>34</sup> *Ibid.*, Forman, pages 93, 188.
- <sup>35</sup> Hines, *op. cit.*, page 55.
- <sup>36</sup> "Stereophonic Broadcasting: What Does It Mean to Advertising?," *Printer's Ink*, Oct. 24, 1958, page 23.

- <sup>37</sup> "Stereophonic Radio Reception," booklet, *op. cit.*
- <sup>38</sup> "Stereophonic Broadcasting: What Does It Mean to Advertising?," *op. cit.*, page 23.
- <sup>39</sup> Personal interview with Robert Silverman, WBAI Sales Dept., New York City, Feb. 3, 1959.
- <sup>40</sup> "Stereophonic broadcasting: What Does It Mean to Advertising?," *op. cit.*, page 23.
- <sup>41</sup> Silverman interview, *op. cit.*
- <sup>42</sup> Norman H. Crowhurst, "More About Multiplexing for Stereo," *Audio*, July 1959, page 74.
- <sup>43</sup> *Ibid.*
- <sup>44</sup> Kaye, *op. cit.*, page 112.
- <sup>45</sup> *Hi-Fi Review*, July 1959, page 25.
- <sup>46</sup> "Stereophonic Broadcasting: What Does It Mean to Advertising?," *op. cit.*, page 23.
- <sup>47</sup> Kaye, *op. cit.*
- <sup>48</sup> *Ibid.*, pages 97, 112.
- <sup>49</sup> Crowhurst, "More About Multiplexing for Stereo," *op. cit.*, page 75.
- <sup>50</sup> Kaye, *op. cit.*, page 112.
- <sup>51</sup> "Stereophonic Broadcasting; Percival System; Two Channels from a Single Transmitter," *Wireless World*, November 1958, page 521.
- <sup>52</sup> Quoted in Richard F. Vogl, "Three Years of Stereophonic Broadcasting at WOI," NAEB Engineering Service Bulletin, 1959, page 4.
- <sup>53</sup> *Ibid.* Cf. *infra*, pages 161-162.
- <sup>54</sup> Kaye, *op. cit.*, page 112.
- <sup>55</sup> Crowhurst, "What Is Compatible Stereo FM Multiplex?," *op. cit.*, page 96.
- <sup>56</sup> Hines, *op. cit.*, page 189.
- <sup>57</sup> Oliver P. Ferrell, "The Flip Side," *HiFi Review*, May 1959, page 90.
- <sup>58</sup> Hayes, *op. cit.*, pages 6-7.
- <sup>59</sup> Hillier's statement needs modification. Cadillac and Lincoln have produced a number of cars with built-in FM auto radios, and several companies produce FM auto radios.
- <sup>60</sup> J. Hillier, "Stereophonic Sound Broadcast in AM Band," *Electrical Engineering*, February 1959, page 193.
- <sup>61</sup> *Ibid.*
- <sup>62</sup> *Ibid.*
- <sup>63</sup> "Stereo Broadcasting: What Does It Mean to Advertising?," *op. cit.*, page 22.
- <sup>64</sup> "Westinghouse, RCA Show AM Stereo Plans," *Broadcasting*, March 9, 1959, page 126.
- <sup>65</sup> "Standardizing Stereo," *op. cit.*, page 116.
- <sup>66</sup> *Ibid.*, page 117.
- <sup>67</sup> *Ibid.*, page 116.
- <sup>68</sup> *Supra*, page 80.
- <sup>69</sup> Robert W. Young, "Review of Acoustical Patents," *Journal of the Acoustical Society of America*, May 1958, page 497.
- <sup>70</sup> Crowhurst, "More About Multiplexing For Stereo," *op. cit.*, page 74.
- <sup>71</sup> "Standardizing Stereo," *op. cit.*, pages 107, 116.
- <sup>72</sup> Kaye, *op. cit.*, page 112.
- <sup>73</sup> *Ibid.*
- <sup>74</sup> "FCC's FM Probe Gets Stereo Issue," *Broadcasting*, March 16, 1959, page 97.
- <sup>75</sup> "CBS's Dr. Frank Stanton," *Printer's Ink*, Dec. 5, 1958, page 58.
- <sup>76</sup> "The FM Enigma: Valuable Plus or Basic Medium?," *U. S. Radio*, August 1958, pages 35-37.
- <sup>77</sup> Leonard Zola, "WCRB and Stereo," mimeographed booklet released at press conference in Sheraton-Plaza, Boston, Oct. 7, 1958, page 4.
- <sup>78</sup> *Ibid.*

- <sup>79</sup> Peter J. Fernald, John P. Figh, Robert W. Ganger and William D. George, "The Audience of Station WCRB." Unpublished report submitted to market-research seminar conducted by Prof. Edward C. Bursk at the Harvard Graduate School of Business Administration, January 1959, page 28.
- <sup>80</sup> *Ibid.*, pages 44-45.
- <sup>81</sup> Richard F. Shepard, "Stereophony on the Radio Front," *The New York Times*, Sunday, Jan. 25, 1959, Section X, page 11.
- <sup>82</sup> Louis J. Kleinklaus, "Q and A on Stereo and M/X," *Audio*, August 1958, page 92.
- <sup>83</sup> "A Short Guide to Hi-Fi and Stereo Broadcasting," printed booklet published by WQXR.
- <sup>84</sup> Kleinklaus, *op. cit.*, page 20.
- <sup>85</sup> "Stereo Music on WQXR," advertisement in radio section of *The New York Times*, Sunday, Nov. 2, 1958.
- <sup>86</sup> Personal Interview with Carl Menzer, director of WSUI, Iowa City, Dec. 26, 1958.
- <sup>87</sup> "WSUI to Broadcast Stereo," *Iowa City Press-Citizen*, Friday, Dec. 12, 1958.
- <sup>88</sup> C. G. McProud, "Editor's Review," *Audio*, August 1958, page 16.
- <sup>89</sup> "KUOM Music Highlights," article in *KUOM Monthly Program Guide*, Spring 1959.
- <sup>90</sup> "Behind the Scenes," Article in *WUOM Monthly Program Guide*, University of Michigan Broadcasting Service, Ann Arbor, Mich., November 1958.
- <sup>91</sup> Karl Haas, "The Role of Music in European Broadcasting," *NAEB Journal*, February 1959, page 21.
- <sup>92</sup> Otto Zausmer, "American-Sponsored Radio Has Reds Buffaloeed," *Boston Globe*, March 18, 1959.
- <sup>93</sup> Ed Snape, "Hi-Fi With That Coffee Aroma," *Audio*, December 1958, page 21.
- <sup>94</sup> "Sounds for Two Ears," *Engineering*, February 1958, page 224.
- <sup>95</sup> H. T. Greatorex, "Stereophonic Broadcasting," *Listener*, Oct. 16, 1958, page 605.
- <sup>96</sup> "Sound for Two Ears," *op cit.*
- <sup>97</sup> Greatorex, *op cit.*; also "Available Stereophony," *Engineering*, May 2, 1958, page 576.

## stereo techniques

**T**HE process of creating stereo begins with microphone placement in the studio. There are two predominant methods (Fig. 701) of setting up the microphone, the “American” (US) and the “European.”

The American system simply places the two (or three) microphones in a line parallel to the edge of the stage or performing group. The spacing is often very wide (as much as 30 feet for special effects), especially when three-channel recording is used to provide a center-microphone and “phantom” channel on the final recording. The European (or “Stereosonic”) system uses two microphones close together, often in the same case. The microphones point out at 45° angles to the sound sources and each has a bidirectional (figure-8) pickup pattern. There is no phase difference in the resultant recording, only intensity differences.

Another European system is called “middle-side stereophony”. In this, one semidirectional and one bidirectional microphone are used. The semidirectional unit is pointed directly at the sound source from a position similar to that used for making a monaural recording with a single microphone (Fig. 701-b). The bidirectional microphone is placed just behind it and at right angles to it in a pattern, so that primarily it picks up the right and left sides of the sound sources out of phase by 180°. When combined by the sum-and-difference method, one channel has all the left-side sound and the other has all the right-side, while both have an equal and generous balance of center information.<sup>1</sup>

A review of an Angel stereo tape recording of the Brahms’ *Double Concerto* illustrates the subtler viewpoint with regard to

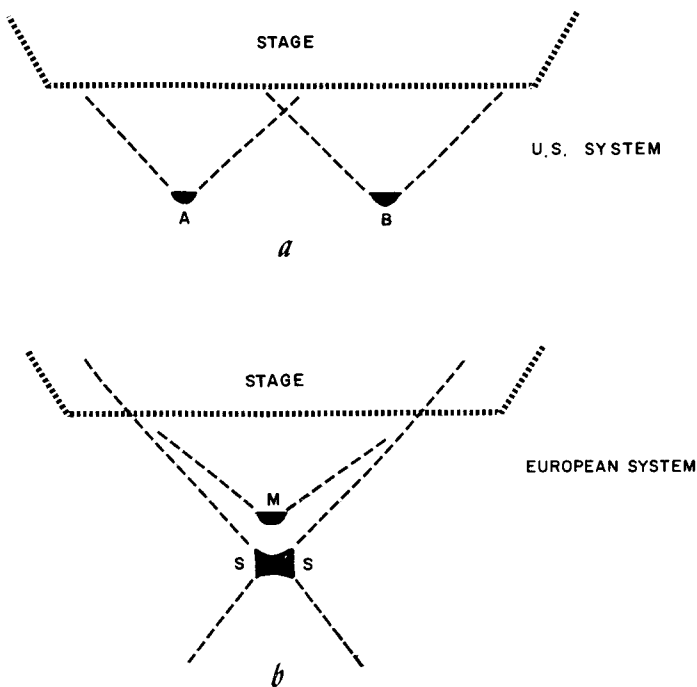

Fig. 701. Domestic and foreign methods of microphone placement.

the qualities stressed in the European system of recording:

The whole thing seems to come down to a choice of values.

Whereas the usual goal here is textural transparency and brilliance, sharpness of separation, and the illusion of sitting in the very center of complex sound, Angel's British engineers appear to be trying for a less spectacular, more homogeneous overall effect.

### Pseudo-stereo

The advent of stereophonic broadcasting in the 1920's led some engineers and radio experimenters to wonder if the realistic effects of stereo could not be achieved through some simpler and less expensive method. It was suggested that, since the binaural effect depends primarily on the phase relation of the sound waves arriving at the two ears, it might be produced artificially by introducing either a slight lag in the time of arrival of sound at one of the ears by electrical or acoustical means (Fig. 702-a). Doolittle suggested two other ways: (b) A stethoscope could be used as a substitute for the headset used in listening to binaural broadcasts. The tubes of the stethoscope could be connected to the monaural

receiver by different lengths of rubber tubing. This mellowed the sound but, of course, gave no directional effects. (c) The two microphones in the radio studio could be connected to modulate a single transmitter instead of two separate ones. When the monaural signal is heard, “both ears hear what each ear should hear but no sense of location is obtained”.<sup>2</sup>

### Kluth System

The “Kluth system” was used for pseudo stereo in Berlin, Germany. The stereophonic effect is produced at the receiving end,

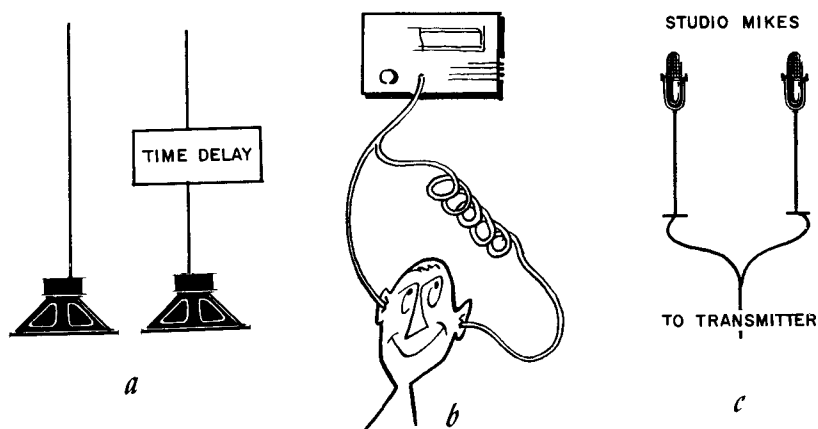

Fig. 702. Three early suggestions for achieving a pseudo-stereo effect from a monophonic source.

not at the transmitting end, where a certain difference in phase between the currents in the two telephone earpieces is caused to produce the binaural effect. This is done in a simple manner by use of a special variometer of very high inductance:

“That even our sense of hearing is connected with conceptions of space has so far been mostly left out of account, though the mutual distance of the two ears, which is about  $8\frac{1}{2}$  inches, is bound to bring a sound coming from the left, for instance, a little later to the right than to the left ear, so that the acoustic perceptions corresponding to the two ears, in spite of our remaining unconscious of the slight difference in time, are bound to differ from one another . . . hearing amalgamates the acoustic perceptions corresponding to the left and right ears, respectively, into a single plastic conception, which is further accentuated by individual sound differences.

Broadcasting, on the other hand, will convey to our left and right ears, respectively . . . perfectly identical oral impressions,

resulting in a . . . sound picture devoid of any plastic perception. Endeavors have therefore been made to devise some means by which the left and right ears might receive slightly different acoustic impressions . . .”<sup>3</sup>

The arrival of stereo tapes and discs on the recording scene raised an important question regarding previous recordings which were not stereo. What will happen now to the musical treasures of the past “monaural age”?

Stereo is a far greater upheaval than other developments in sound reproduction along the way. Any great musical material, whether it existed on cylinder records, acoustical discs, or electrical discs, could be transferred to the new long-play records. Many series now in the LP catalog, such as RCA’s Camden, Columbia’s Harmony and Angel’s Great Recordings of the Century, offer proof of the unusualness of those performances, given a new life on modern LP discs. But the barrier between monaural recordings and the stereo future is more formidable.

“Sound enhancement” has been used to clean up recordings even as recent as Toscanini’s by adding certain acoustical factors that were not present in the original recordings, and by removing others. However, the difficulties of “enhancing” a monaural recording to sound like stereo are tremendous. Such enhancement can be applied either at the recording studio, to make pseudo-stereo versions of existing single-channel recordings, or in the home, as a component for adding stereo’s dimensions to playback of monaural tapes, discs or film.<sup>4</sup>

The disadvantages of pseudo-stereo in motion-picture work were described as:

“Pseudo-stereophonic methods can indeed be used if the producer is willing to sacrifice the lifelike perspective effects, the showmanship of off-screen dialogue, music or other sounds and the improved fidelity, particularly in sets described as ‘boomy,’ all of which are provided by true stereophonic methods.

Should the producer decide to accept pseudo-stereophonic sound, he must also accept certain restrictions among which are: (1) there cannot be overlapping dialogue or sounds in a scene from more than one source which have visually different placement; (2) there cannot be moving sounds in the original scene simultaneous with fixed or differently moving sounds; and (3) if the dialogue or sounds from separated sources follow one another with very little interval, it may be necessary to cut the original sound into the two or more master sound tracks so that more than one re-recording mixer may handle only that part of which each is capable.”<sup>5</sup>

The synthetic stereo system outlined above probably is released

on regular CinemaScope sound tracks. Another type of film pseudo-stereo would be the Perspecta system discussed previously, which Crowhurst<sup>6</sup> suggested in a simplified version for the home. It would be subject, however, to exactly the same restrictions as mentioned by Grignon. Only one sound could be moved at a time.

Crowhurst also mentioned a simpler pseudo-stereo idea he calls "single-channel stereo." This injects artificial reverberation electronically, 10 milliseconds late, into a single-channel source. This causes electronic reverberation and makes the material sound more "alive". It sometimes may appear to improve reproduction, but Crowhurst says that more often it produces a repeated resonance that can become annoying.

Still another pseudo-stereo device consists of dividing the frequency spectrum and delivering different parts or different response characteristics to each speaker. The difficulty with this is that an arrangement that improves the presentation of one segment of the program material is detrimental to another.<sup>7</sup> However, the plan can be experimented with by anyone possessing a two-channel amplifier with individual tone controls.

Chernof designed a "3D converter" to provide the audio experimenter with a means of capturing the illusion of depth and liveness associated with stereo, at a fraction of the cost. It converts monaural sound from phono or tape to "simulated" stereo by separating electronically the single sound channel into two separate output channels sufficiently different in phase and frequency structure from each other to simulate, say, the sound of a symphony orchestra as picked up by two separate microphones. No claims are made that it is anything but a simulated stereo system.<sup>8</sup>

Interest in the pseudo-stereophonic illusion has been building ever since the Bell Laboratories began their stereo work. Hobbyists couldn't afford anything like three-channel arrangements, so they began experimenting with dispersed multiple-speaker arrangements, as well as with the "volume expander", which increased the limited dynamic range of the old shellac 78-rpm recordings.

Next came the added gimmicks of frequency separation, mechanical artificial reverberation and, finally, directionality as in the Perspecta system. Work was done with "phase-differential" enhancing devices, such as "Stereo by Holt". This device consists of an auxiliary amplifier with a volume control and separate bass and treble controls, together with a series of phase-shifting networks.<sup>9</sup>



A variation of this phase-differential approach has been worked on by Holger Lauridsen of the Danish National Broadcasting System. During this work, begun in 1954, Lauridsen combined the single channel, delayed by from 50 to 150 milliseconds and fed so as to produce opposite phases but equal amplitudes at the ears, with the undelayed single channel fed with the same phase and amplitude to each ear.

This principle was also applied to loudspeaker operation. One speaker, fed with undelayed single, faced the listener and thus formed the point source, while the other speaker, fed by the delayed signal, was at right angles to the first and thus formed a dipole source. This was equivalent to feeding the undelayed single channel with a different frequency range and phase response in the path to each ear. Different frequency responses were found to be more important factors than phasing in providing the spatial illusions.<sup>10</sup>

Simulated stereophonic sound was obtained from a single-channel sound source in a commercial sound system by using separate amplifiers for bass and treble frequencies and corresponding speakers.<sup>11</sup>

The "Xophonic", made by Radio Craftsmen Co., is a miniature reverberation chamber in principle (Fig. 703). The music is played through a small speaker into a coiled pipe and, at the end of the pipe, a second miniature speaker acting as a microphone picks up the sound, amplifying it and feeding it to a built-in third speaker. The last speaker is employed as the "second speaker" in the simulated stereo system. The sound is delayed about 1/20 second. Since the two speakers and the speaker acting as a microphone are housed in the same cabinet, there are serious feedback problems, and the coiled pipe adds spurious resonances. Ferrell calls it "an interesting pseudo-stereo effect which is neither mediumly decent stereo nor enhanced monaural programming."<sup>12</sup>

Two more hopeful solutions to the pseudo-stereo illusion are being tested now. The first is a creation of Paul Weathers which combines the three most important enhancing principles now known: (1) Time differential between the listener's two ears; (2) different sound reflection patterns, resulting in phase configurations of the instantaneous sound spectrum, and (3) variable method of controlling amplitude, particularly with regard to "attack" in musical instruments.

The Weathers device reportedly even renders an illusion of apparent motion. Three speakers are required, but it is not

scheduled for production until the stereo disc dust has settled.<sup>13</sup>

Another hopeful solution is being found in what is described as "the most advanced electroacoustical experimental studios in the world," high in the Swiss Alps. There, Dr. Hermann Scherchen was developing (between concert tours with Europe's best symphony orchestras), his own pseudo-stereo device, called the "Stereophoner".<sup>14</sup> The actual instrument was not constructed until Dr. Scherchen had carefully isolated and defined the various



Fig. 703. *The Xophonic was one of the early attempts at pseudo-stereo.* (Radio Craftsmen Co.)

elements of the stereo effect. Then, he began work on the "hardware" of the Stereophoner. The instrument requires only two speakers but, played from an ordinary monaural sound source, it is said to provide a highly effective illusion of stereophonic depth and directionality.

Both the Weathers and Scherchen devices might show a way to salvage our heritage of priceless single-channel recordings for the future<sup>15</sup> — a better way than recent "enhanced for stereo" stereo disc releases, which merely roll off the base frequencies on one channel and the treble on the other to arrive at a primitively simple pseudo stereo effect.<sup>16</sup> Yet remember that *no enhancing device, no matter how perfect, is a substitute for genuine multi-channel stereophony.*

### **Stereo in business and industry**

In business and industry, stereophony has become more and more important. Multiple reproducer techniques in business hold the promise of clearer, more intelligible records.<sup>17</sup> Ampex Co.

began commercial production of multi-track tape recorders in 1949 and 1950, not for stereo fans, but for those interested in recording telemetered information from guided missiles and associated equipment. Ordinary two-track stereo machines are used in the industrial field for localizing and analyzing subjective sound sources, or making sounds appear subjectively more realistic. Two headphones, rather than speakers, are used.<sup>18</sup>

Acoustical consultants Bolt, Beranek & Newman, Inc. (Cambridge, Mass.) have used stereophony for many purposes. An electronic reverberation system was installed at Christ Church, Cambridge, after considerable experimentation with a model in the company's laboratories. Acoustics were very poor in the small church, with persons in some sections unable to hear anything. The system consists of 12 reverberation speakers concealed around the church near ceiling height, all connected to the Aeolian-Skinner organ and to a microphone setup that picks up the sound of choir and minister. The sounds first are sent to a reverberation chamber in the basement of the church; then, the information is selected as to time and origin before being sent to the various speakers. The result is an excellent acoustical environment in which everything can be heard clearly, yet one in which a listener is completely unaware of the speakers around the room. The reverberation system can be used in any auditorium or theater with poor acoustics but, of course, has to be custom built.<sup>19</sup>

Another device developed by the same company, in cooperation with Dr. W. J. Gardner, is the "Audio-Analgesiac". This device, using stereophonic tapes, is installed in dental operating rooms and replaces all but the heaviest anesthetics. A tape transport playing stereo music is connected in parallel with a noise channel presenting a shaped noise spectrum. The noise and music are heard through the headphones on the patient's ears. The patient turns knobs to control music and noise. Prior to a dental operation, only music is used. However, when pain becomes great, the patient can bring in the noise over the music and the pain seems to subside.

The principle behind the device is the control of two types of pain — core pain and reaction to pain. The nerves running to the brain carry the core pain. When the noise is inserted, it "jams" these lines and cuts out the pain. The reaction to pain is caused by the patient becoming tense and worrying about the operation. The stereophonic music "transports" him aurally to an entirely different location — that of the concert hall or studio where the

music was recorded in stereo. The music takes away the tenseness and gives the patient a feeling of relief. The selection of music is important — it must be what the patient enjoys.<sup>20</sup>

Finally, the Cambridge company uses binaural recordings to help them evaluate room acoustics in concert halls. They want to learn why certain halls are considered so much better acoustically than others. Using a set of “dummy” heads with microphones in the ears, recordings are made in the halls under inspection. The wooden heads are covered with about an inch of rubber coating to stimulate the human skin texture. The heads, of which the company owns four, are placed in various spots in the audience and used to record musical performances on stage. All four are recorded simultaneously on separate tape machines, synchronized by a generator tone.

Then, in the quiet of the laboratory, the recordings can be listened to at length through headsets. Instruments are used to plot the noise spectrum from each channel of the stereo tapes and comparisons are made. Reverberation and decay are studied. The recordings are kept on file for future reference. One hall then can be compared to another without making a trip there. Halls throughout the world can be compared and studied easily. Without stereophonic recording, the acoustic perspective would not be reproduced and few judgments on the halls’ qualities could be made.<sup>21</sup>

### Bibliography and References

- <sup>1</sup> Herman Burstein, “Stereo Glossary”, *Radio & TV News*, October 1958, page 70.
- <sup>2</sup> F. M. Doolittle, “Binaural Broadcasting,” *Electrical World*, April 25, 1925, page 867.
- <sup>3</sup> Dr. Alfred Gradenwits, “Plastic Radio by the Kluth System”, *Radio News*, November 1925, pages 720, 722.
- <sup>4</sup> Oliver P. Ferrell, “Semi-Stereo: . . . Now or Never”?, *Hi-Fi and Music Review*, October 1958, page 55.
- <sup>5</sup> Lorin D. Grignon, “Experiment in Stereophonic Sound,” *Journal of SMPTE*, September 1953, page 375.
- <sup>6</sup> Crowhurst, “New Approach to Hi-Fi Stereophonics,” *Radio and Television News*, August, 1956, pages 35–38.
- <sup>7</sup> *Ibid.*
- <sup>8</sup> J. Chernof, “Improved 3D Converter,” *Radio and Television News*, January 1956, page 56–57.
- <sup>9</sup> David Hall, “Stereo: Genuine and Simulated,” *Hi-Fi Music at Home*, October 1957, pages 169–70.
- <sup>10</sup> Manfred R. Schroeder, “Single-Channel Pseudo-Stereophony,” (abstract), *Wireless World*, December 1958, page 597.
- <sup>11</sup> Charles D. Lindridge, “Multidirectional Reproduction and Re-recording of Music from a Single Sound Source,” *Journal of the AFS*, October 1954, pages 244–48.

<sup>12</sup> Ferrell, "Semi-Stereo . . . Now or Never"?, *op. cit.*, page 56.

<sup>13</sup> *Ibid.*

<sup>14</sup> "Timpani-Tempered Tyrant", *Time*, Jan. 5, 1959, page 52.

<sup>15</sup> Ferrell, "Semi-Stereo . . . Now or Never"?, *op. cit.*, page 56.

<sup>16</sup> A good example of the latter is the disc *The Man With The Golden Arm*", Decca 78257. According to the liner notes, "This unique performance, a recording masterpiece of our time, has been specially enhanced for STEREO listening".

<sup>17</sup> G. Southworth, "Binaural Sound Reproduction", *Radio and Television News*, March 1953, page 71.

<sup>18</sup> Russell J. Tinkham, "Stereophonic Tape Recording Reproducing Equipment", *Journal of SMPTE*, January 1954, page 71.

<sup>19</sup> Personal interview with John Kellner, of Bolt, Beranek & Newman, March 27, 1959.

<sup>20</sup> Personal interview with Samuel Labate of Bolt, Beranek & Newman, March 25, 1959.

<sup>21</sup> *Ibid.*

# index

## A

Acoustical Matrixing .....	130
Acoustics, Binaural Recordings to Evaluate Room .....	155
Adapter for Stereophonic Playback .....	78
Adapter, Multiplex .....	122
Ader's Experiment .....	27
Advantages of Discs .....	79
Advantages of Tape .....	78
American Method of Microphone Placement .....	147
AM:	
-AM Broadcasting .....	113
and FM channels .....	115
and FM Quality, Differences in .....	115
-FM Broadcasting .....	113
-FM Disadvantage of .....	114
-FM Problems .....	140
Radio Channels, Separate .....	113
Stereocast, Single-Station .....	138
Stereocasting, Single-Channel .....	136
AM Stereocasting System:	
Bell .....	137
Philco .....	136
RCA .....	134
Westinghouse .....	136
Artificial Reverberation .....	151
Audio-Analgesiac .....	154
Auditorium Effect, Shifting .....	19

## B

Bandwidth, FM .....	122
Beats .....	10
Becker Stereo Multiplex System .....	139
Bell AM Stereocasting System .....	137
Bell Experiment, 1933 .....	35
Bell Stereo Film-System .....	54
Binaural:	
Beats .....	10
Broadcasts, Listening to .....	148
Discs .....	92
Fusion .....	11
Receiving Trumpets .....	28
Transmission System .....	120
Blumlein and Fletcher .....	32
Bogert System .....	68
Broadcasting:	
AM-AM .....	113
AM-FM .....	113
Disadvantage of AM-FM .....	114
FM-FM .....	114
Simultaneous .....	116
Stereophonic .....	113
TV-AM .....	116
TV-FM .....	116
Types of Stereo .....	113

Burden Stereo Multiplex System .....	130
Business and Industry, Stereo in .....	153

## C

Calbest Stereo Multiplex System .....	131
Carrier Frequency, Supersonic .....	122
Carrier Telephony .....	119
Cartridge:	
Ceramic-Type Stereo .....	110
Monophonic Pickup .....	99
Moving-Magnet Stereo .....	110
Stereo Magnetic .....	103
Tape .....	79
Variable-Reluctance Stereo .....	110
Cartridges, Stereo .....	110
CBS Stereo Disc .....	95
Ceramic Stereo Pickup with Turnover Stylus .....	110
Ceramic-Type Stereo Cartridge .....	110
Channel:	
Left .....	126
Phantom .....	65
Right .....	126
Channels:	
Dark .....	138
FM and AM .....	115
Number of .....	21
Separate AM Radio .....	113
Cinema-Scope Sound .....	63
Cinerama Sound .....	63
Cocktail Party Effect .....	12
Coded Stereo .....	76
Coil Assembly, Stereo Pickup .....	103
Comporator .....	55
Compatibility .....	104, 121
Compatible:	
FM Stereo Multiplex .....	126
Stereo FM Multiplex, Systems of .....	124
Stereophonic Disc .....	102
Compliance of Stereo Pickup .....	103
Compressor-Expander .....	55
Connoisseur Stereo System .....	95
Conversion Kits:	
Four-Track .....	87
Stereo .....	107
Tape .....	83
Converter, 3D .....	151
Cook Stereo Discs .....	44, 92
Crosby System .....	127
Crosstalk .....	100
Cutting Head, Westrex .....	96

## D

Dark Channels .....	138
De Boer Disc .....	46
De-Emphasis .....	122

Definitions, System .....	16
Delay, Sound .....	137
Difference Signal .....	125
Diotic Transmission .....	34
Direct and Reflected Sound .....	33
Directional Accuracy of the Ears .....	13
Disadvantage of Tape .....	78
Discs:	
45/45 Stereo .....	95
CBS Stereo .....	95
Compatible Stereophonic .....	102
De Boer .....	46
Making and Reproducing a Stereo Minter Stereo .....	81 94
Requirements, Stereo .....	106
Systems, Experimental Stereo .....	92
Discs:	
Advantages of .....	79, 92
Binaural .....	92
Cook Stereo .....	92
EMI Stereo .....	93
Excessive Volume Level on Stereo Faults in Stereo .....	109 109
First 45/45 .....	102
Frequency Response of Stereo .....	107
Improving Dynamic Range of .....	91
Insufficient Volume Level on Stereo Stereo 45-RPM .....	109 109
Stereophonic Sound on .....	91
Surface Noise of Stereo .....	109
Talking-Book .....	111
VL-Stereo .....	93
Distortion in Stereo Discs .....	109
Double Tone-Arm System .....	47
Double Transmission Systems .....	113
Duplication of Tapes .....	80
Dynamic Range of Tape or Discs, Im- proving .....	91

<b>E</b>	
Ears:	
Directional Accuracy of the .....	13
Hearing With Two .....	8
Phase of Sound Arriving at the ...	148
Echolocation .....	14
Electronic Reverberation .....	151
EMI:	
Percival Stereo Multiplex System ..	132
Stereo Discs .....	93
Stereosonic Recording System .....	32
Enhancement of Sound .....	150
European Method of Microphone Place- ment .....	147
Excessive Volume Level on Stereo Discs	109
Expander, Volume .....	151

<b>F</b>	
Fantasound .....	56
Film Sound, Recording .....	66
First Commercial Stereo Tape .....	46
Fletcher and Blumlein .....	32
Flutter .....	84
FM:	
-AM Problems .....	140
and AM Channels .....	115
and AM Quality, Differences in ...	115
and TV Radio, Three-Channel .....	117
Bandwidth .....	122
-FM Broadcasting .....	114
Frequencies .....	122
Multiplex, Systems of Compatible Multiplexing .....	119 124
Stereo .....	124
Stereo Multiplex, Compatible .....	126
Four-Track Conversion Kits .....	87
Four-Track Stereo Tapes .....	84
Frequencies, FM .....	122
Frequencies, High .....	83
Frequency Response of Stereo Discs .....	107
Fusion, Binaural .....	11

## G

Grooves:	
Laterally-Cut .....	101
Monophonic .....	101
Stereo .....	101

## H

Haas Effect .....	137
Halstead Stereo Multiplex System .....	130
Hearing With Two Ears .....	8
High Frequencies .....	84
Hiss Level of Stereo Discs .....	106

## I

Industry and Business, Stereo in .....	153
Insufficient Volume Level on Stereo Discs	109
Intensity and Phase .....	10
Intensity, Sound .....	23
Interaction, Binaural .....	11

## K

Kits, Tape Conversion .....	83
Kluth System .....	149

## L

Lateral Cut .....	97
Laterally-Cut Grooves .....	101
Left Channel .....	126
Limitations of Monophonic Sound .....	15
Loop, Moebius .....	81
Low-Frequency Response .....	107

## M

Magnetic:	
Recording System, 1-7/8 IPS .....	88
Stereo Cartridge .....	103
Tape, Advantages and Disadvantages of .....	78
Matrixed Stereo Signals, Reception of	127
Matrixed Stereocast by Multiplex .....	124
Matrixing, Acoustical .....	130
Mating Stereo Multiplex System .....	132
Microphone Placement:	
American Method of .....	147
Domestic and Foreign Methods of ..	147
European Method of .....	147
Middle-Side Stereophony Method of	147
Stereosonic System of .....	147
Middle-Side Stereophony .....	147
Minter Stereo Disc .....	94
Misalignment of Stereo Pickup, Cross- talk Due to .....	100
Mixed Transmission .....	34
Mixers, Panning .....	64
Modulated Subcarrier .....	119
Modulation of Record Groove .....	97
Modulator, Serrasoid .....	120
Moebius Loop .....	81
Monaural .....	16
Monophonic:	
and Stereo Compatibility .....	104
Grooves .....	101
Pickup Cartridge .....	99
Pickup, Pressure of .....	99
Reception of Matrixed Stereocast by Multiplex .....	124
Records, Radius of Stylus Tip for ..	99
Sound, Limitations of .....	15
Tapes .....	84
Moving-Magnet Stereo Cartridge .....	110
Multiplex:	
Adapter .....	122
Compatible FM Stereo .....	126
Crosby .....	127
Method Used in Musicasting .....	123
Monophonic and Stereophonic Re- ception of a Stereocast .....	124

Stereosonic .....	130
Transmission, FM .....	122
Multiplex System:	
Becker .....	139
Burden .....	130
Calbest .....	131
EMI-Perival .....	132
Halstead .....	130
Matting .....	132
Phantodyne .....	131
Multiplexing .....	119
Musicaasting .....	120
Musicaasting, Multiplex Method Used in ..	123

<b>N</b>	
National Stereophonic Radio Committee ..	124
Noise, Surface .....	107
NSRC .....	124
Number of Channels .....	21

<b>O</b>	
Optical-Track System .....	65
Ortofon Stereo Recorder .....	95
Oscar .....	34

<b>P</b>	
Panning Mixers .....	64
Penthouse .....	62
Perspecta .....	63
Phantodyne Stereo Multiplex System .....	131
Phantom Channel .....	65
Phase and Intensity .....	10
Phase-Differential Device .....	151
Phase of Sound at the Ears .....	148
Philco AM Stereocasting System .....	136
Photo-Stereo Process .....	65
Pickup Cartridge, Monophonic .....	99
Pickup Heads, Stacked Stereo .....	74
Pickup Heads, Staggered Stereo .....	74
Pickups, Stereo .....	110
Ping-Pong Effect .....	109
Placement of Microphones .....	147
Precedence Effect .....	137
Pressure:	
of Monophonic Pickup .....	99
of Stereophonic Pickup .....	99
Sound .....	10
Problems of Stereo .....	105
Program, Recovering the Subcarrier's .....	122

Pseudo-Stereo:	
in Motion-Picture Work, Disadvantages of ..	150
Kluth System of .....	149
the Stereophoner .....	153
the Xophonic .....	152

<b>R</b>	
Radio:	
Multiplexing .....	119
Three-Channel TV and FM .....	117
TV Stereocasting .....	118
Radius of Stereo Stylus Tip .....	99
Radius of Stylus Tip for Monophonic Records .....	99
RCA Stereocasting System .....	134
Realism, Illusion of .....	24
Record Groove Modulation .....	97
Recording Film Sound .....	66
Recording System, 1-7/8 IPS Magnetic ..	88
Records (see also Discs):	
Advantages of .....	79
Making and Reproducing Stereo .....	81
Talking-Book .....	111
Reflected and Direct Sound .....	33
Response, Low-Frequency .....	107
Reverberation .....	15
Reverberation, Artificial .....	151
Reverberation, Electronic .....	151
Right Channel .....	126
Room Acoustics, Binaural Recordings to Evaluate .....	155

Rotating Spherical Magnet-Type Stereo Cartridge .....	110
Rumble .....	105, 107

<b>S</b>	
Separation, Lack of .....	107
Serrasoid Modulator .....	120
Shadow, Sound .....	13
Shifting Auditorium Effect .....	19
Signal, Difference .....	125
Signal, Sum .....	125
Signals, Sum and Difference .....	125
Simplex .....	120
Simulated Stereo .....	151
Simulcasting .....	116
Simultaneous Broadcasting .....	116
Single:	
Channel AM Stereocasting .....	136
Channel Stereo .....	151
Sideband System, Variation of .....	138

Sonics, Unnatural .....	109
Sound:	
and the Exhibitor's Problem, Stereo ..	67
Cinema-Scope .....	63
Cinerama .....	63
Delay .....	137
Direct and Reflected .....	33
Enhancement .....	150
Intensity .....	23
on Film, Stereophonic .....	51
on Tape, Stereophonic .....	73
Pressure .....	10
Recording Film .....	66
Shadow .....	13
Stereophonic .....	7
Time Lag in .....	148
Spherical Magnet-Type Stereo Cartridge, Rotating .....	110
Spindle Holes, Off-Center in Stereo Discs ..	105
Splicing Tape .....	83
SSFS .....	54
Stacked Stereo Pickup Heads .....	74
Staggered Stereo Pickup Heads .....	74

Stereo:	
and Monophonic Compatibility .....	104
Cartridges .....	110
Coded .....	76
Conversion Kits .....	107
Crosby Multiplex .....	128
Film System, Bell .....	54
FM Multiplex, Systems of Compatible .....	124
Grooves .....	101
in Business and Industry .....	153
in Dentistry .....	154
Kluth System of Pseudo- .....	149
on Tape, Early .....	73
Problems .....	105
Pseudo .....	148
Recorder, Ortofon .....	95
Recording, Stylus Motion in .....	101
Signals, Reception of Matrixed .....	127
Simulated .....	151
Single-Channel .....	151
System, Connoisseur .....	95
System, Teldec .....	95
Tapes, Four-Track .....	84
Tapes in the Home .....	76
Tapes, Two-Track .....	84
Techniques .....	147

Stereo Broadcasting:	
AM-AM .....	113
AM-FM .....	113
Disadvantage of AM-FM .....	114
FM-FM .....	114
in the 1920's .....	28
Simultaneous .....	116
TV-AM .....	116
TV-FM .....	116
Types of .....	113
Stereo Cartridge:	
Ceramic-Type .....	110



Magnetic .....	103
Moving-Magnet .....	110
Rotating Spherical Magnet-Type .....	110
Variable-Reluctance .....	110
Stereo Disc (see also Records):	
45/45 .....	95
CBS .....	95
Cook .....	44
Minter .....	94
Popularity .....	106
Recording, First Patent on .....	34
Requirements .....	106
Systems, Experimental .....	92
Vertical-Lateral Cut on .....	97
Stereo Discs:	
Distortion in .....	109
EMI .....	93
Faults in .....	109
Frequency Response of .....	107
Hiss Level .....	106
Insufficient Volume Level on .....	109
Making and Reproducing .....	81
Off-Center Spindle Holes .....	105
Playing Time of .....	91
Surface Noise of .....	106, 109
Swishing Sound Caused by .....	105
VL .....	93
Warpage of .....	105
Stereo Multiplex System:	
Becker .....	139
Burden .....	130
Calbest .....	131
EMI-Percival .....	132
Halstead .....	130
Matting .....	132
Phantodnye .....	131
Stereocasting:	
Activity Abroad .....	142
Activity, Survey of .....	138
Single-Channel AM .....	136
TV-Radio .....	118
Stereocasting System:	
AM .....	134
Bell AM .....	137
Philco AM .....	136
RCA .....	134
Westinghouse AM .....	136
Stereophoner .....	153
Stereophonic:	
Broadcasting .....	113
Disc, Compatible .....	102
Disc Recording, Early System of .....	45
Hearing, Theories of .....	10
Pickup, Pressure of .....	99
Reception of Matrixed Stereocast by Multiplex .....	124
Reproduction, Advantages of .....	24
Sound .....	7
Sound on Discs .....	91
Sound on Film .....	51
Sound on Tape .....	73
Stereophony, Ideal and Practical .....	20
Stereophony, Middle-Side .....	147
Stereoasonic Multiplex .....	130
Stereoasonic System of Microphone Place- ment .....	147
Stethoscope, Use of .....	148
Stripping .....	61
Styli, Twin .....	104
Stylus:	
1 Mil .....	99
0.7 Mil .....	99
Ceramic Stereo Pickup With Turn- over .....	110
Motion in Stereo Recording .....	101
Tip, Radius of for Monophonic Records .....	99
Tip, Radius of Stereo .....	99
Subcarrier .....	122
Subcarrier's Program, Recovering .....	122
Sum:	
and Difference Signals .....	125
and Difference Theory .....	122
Signal .....	125
Supersonic Carrier Frequency .....	122
Surface Noise .....	107
Surface Noise of Stereo Discs .....	106, 109
Synthetic Stereo .....	148
System Definitions .....	16
System, Optical-Track .....	65
Systems of Compatible Stereo FM Multiplex .....	124
<b>T</b>	
Talking-Book Records .....	111
Tape:	
Advantages and Disadvantages of .....	78
An Advantage of .....	79
Cartridge .....	91
Conversion Kits .....	83
Improving Dynamic Range of .....	91
Playing Time of .....	91
Splicing .....	83
Stereophonic Sound on .....	73
System, 3-M .....	89
System, Coded Stereophonic .....	76
Tapes:	
Duplication of .....	80
Four-Track Stereo .....	84
in the Home, Stereo .....	76
Monophonic .....	84
Two-Track Stereo .....	84
Teldec Stereo System .....	95
Telephony, Carrier .....	119
Three-Channel Broadcast, Bell Telephone Laboratories .....	39
Three-Channel TV and FM Radio .....	117
Three-M Tape System .....	89
Tracking Weight .....	99
Transmission:	
Diotic .....	34
System, Binaural .....	120
Systems, Double .....	113
Turnover Stylus, Ceramic Stereo Pickup With .....	110
TV:	
-AM Broadcasting .....	116
and FM Radio, Three-Channel .....	117
-FM Broadcasting .....	116
Radio Stereocasting .....	118
Twin-Styli Method .....	104
Two-Channel Limitations .....	22
Two-Channel Stereo System .....	68
Two-Track Stereo Tapes .....	84
<b>V</b>	
Variable-Reluctance Stereo Cartridge ....	110
Vertical:	
and Lateral .....	94
Cut .....	97
-Cut System .....	94
-Lateral Cut on Stereo Disc .....	97
Vitasound .....	59
VL Stereo Discs .....	93
Volume:	
Expander .....	151
Level on Stereo Discs, Excessive ....	109
Level on Stereo Discs, Insufficient ..	109
<b>W</b>	
Warpage of Stereo Discs .....	105
Weight, Tracking .....	99
Westinghouse AM Stereocasting System	136
Westrex Cutting Head .....	96
Wired Stereophonic Radio .....	44
Wow .....	84
<b>X</b>	
Xophonic .....	152