

DEVELOPMENTS THAT WILL AFFECT YOU

# Amateur Wireless

And Electrics

Every Thursday 3<sup>d</sup>

Vol. XIII. No. 327

Saturday, September 15, 1928



*The* **BEGINNER'S ONE-VALVER**

**ALSO IN THIS ISSUE**  
**THE**  
**"ADAPTABLE**  
**THREE"**  
**IMPROVEMENTS IN**  
**L.F. AMPLIFIERS**

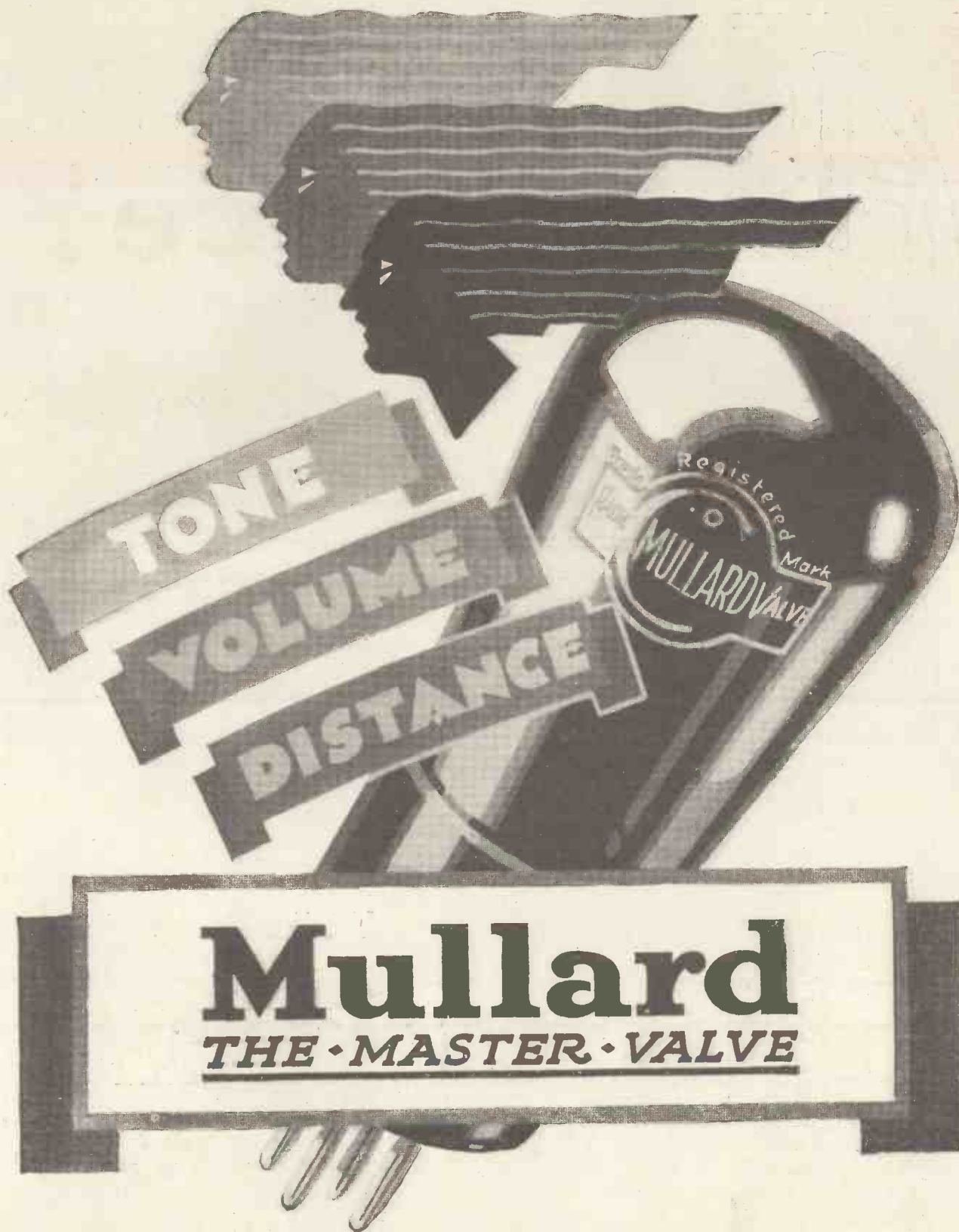

# Mullard

**THE · MASTER · VALVE**

**NATIONAL RADIO EXHIBITION, OLYMPIA, SEPT. 22-29**  
**STANDS 88, 89, 90, 97, 98, 99, 133**

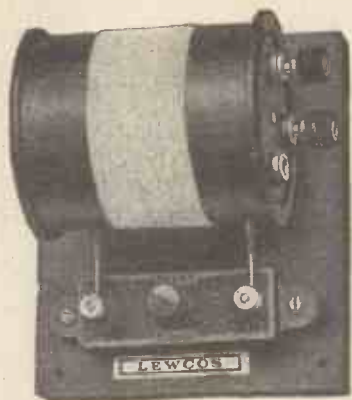

# Interference?

*—here's the remedy!*

Does your Local Station worry you when you wish to receive an alternative programme? If so, the Lewcos Wavetrap will solve your troubles. The results are astounding. Fitted in a few seconds without any alteration to your set.

Obtainable through all Radio dealers. Full particulars with each unit.

PRICE 13/6 EACH

# LEWCOS

REGD.

# Wavetrap

WE ARE EXHIBITING AT



**STAND  
110**

THE LONDON ELECTRIC WIRE COMPANY  
AND SMITHS LIMITED  
Church Road, Leyton, London, E.10

\*Phone : Walthamstow 2531    †Grams : "Lewcos, Phone, London"

**WEARITE** **WRIGHT & WEAIRE, Ltd.**  
 COMPONENTS 740, HIGH ROAD, TOTTENHAM, N.17.

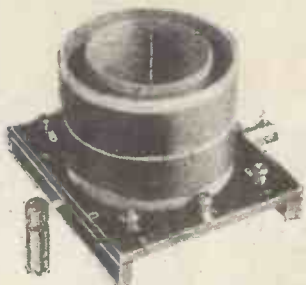

**"Q" COILS**

- Aerial Coil - 15/-
- H.F. Transformer 21/-
- Reinartz Coil - 21/-

SPECIFIED IN "BEST-YET PORTABLE"

**WEARITE H.F. CHOKE - 6/6**

**WEARITE CHOKE (SHORT-WAVE) 4/6**

**WEARITE CHOKE 10/6 (HEAVY-DUTY)**

**A.C. SWITCH (2-way) - 6/-**

**VALVE HOLDER (A/M) 2/6**

WRITE FOR LISTS

STAND Nos. 251 and 252 at Olympia

Telephone: Tottenham 3847 and 3848.

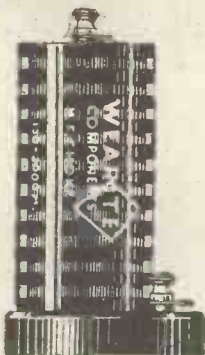

SEPT. 22<sup>ND</sup> TO 29<sup>TH</sup>

THE NATIONAL **RADIO EXHIBITION OLYMPIA**  
 11 A.M. TO 10 P.M. DANCING

ADMISSION 1/6 DAILY  
 TUESDAY SEPT. 23, UP TO 5 P.M. 2/6

Keep plugging away with—

**CLIX PARALLEL PLUGS**



Look out for this Showcase  
 STAND No. 236 OLYMPIA

These well designed Parallel Plugs embody the "Clix" patent resilient principle which ensures quick yet sure contact with all valve sockets and the "Clix" Parallel Sockets.

Price 2d. each

This Parallel Plug is one of the eight positive contact aids in THE "CLIX" SHOWCASE ON YOUR DEALER'S COUNTER

The Showcase includes—

- CLIX PARALLEL PLUGS - 2d.
- CLIX COIL PINS - 2d.
- CLIX SPIRAL WANDER PLUGS 2d.
- CLIX SPADE TERMINALS - 2d.
- CLIX PARALLEL SOCKETS 1d. and 1½d.
- CLIX PIN TERMINALS - 2d.
- CLIX LOX WANDER PLUGS 2d.
- CLIX TERMINAL BRACKETS 1d.

Supplies and illustrated catalogues obtainable from all dealers.

**LECTRO LINX, LTD.**

254 VAUXHALL BRIDGE ROAD, LONDON, S.W.1

See all that is  
**Modern in**  
 ~~~~~ **Radio** ~~~~~  
 at  
**OLYMPIA**  
**Sept. 22nd to 29th**



Organised by The Radio Manufacturers' Association

211

# WHAT IS SLOPE ?



Sergeant Nickel says:  
"It's slope that matters"

**SLOPE** is the greatest factor in valve efficiency  
**THE STEEPER  
THE SLOPE . . . . .  
. . . . . THE GREATER  
THE GOODNESS**

The nickel filament employed in these new Mazda valves gives a steeper slope figure than is possessed by any other valves of corresponding types. Slope is the resultant of a number of other single characteristics, and is the only measure of essential goodness.

No other valves employ nickel filaments and no other valves possess the qualities which result from the use of this material.

*Ask for the valves with the nickel filament  
They cost no more than ordinary valves*

MADE IN 16 TYPES—2, 4 & 6 VOLTS

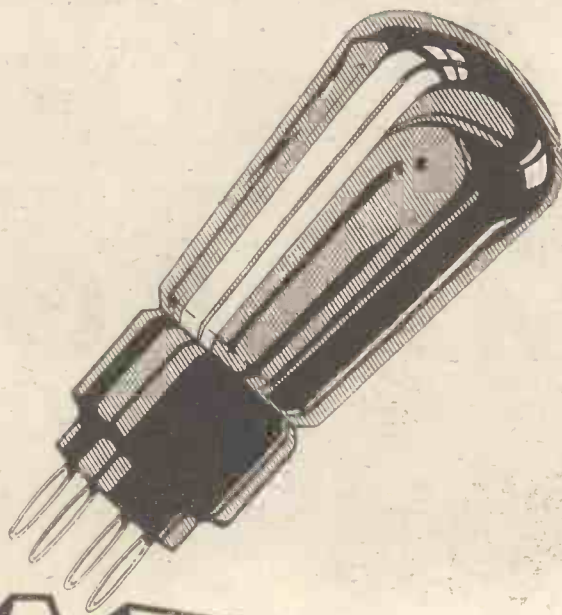

# MAZDA

*Steep Slope*  
**NICKEL FILAMENT  
VALVES**

See these valves at  
STANDS 86 & 101  
The National Radio Exhibition  
Olympia, Sept. 22nd to 29th

3036

The British Thomson-Houston Co., Ltd.

Don't Forget to Say That You Saw it in "A.W."

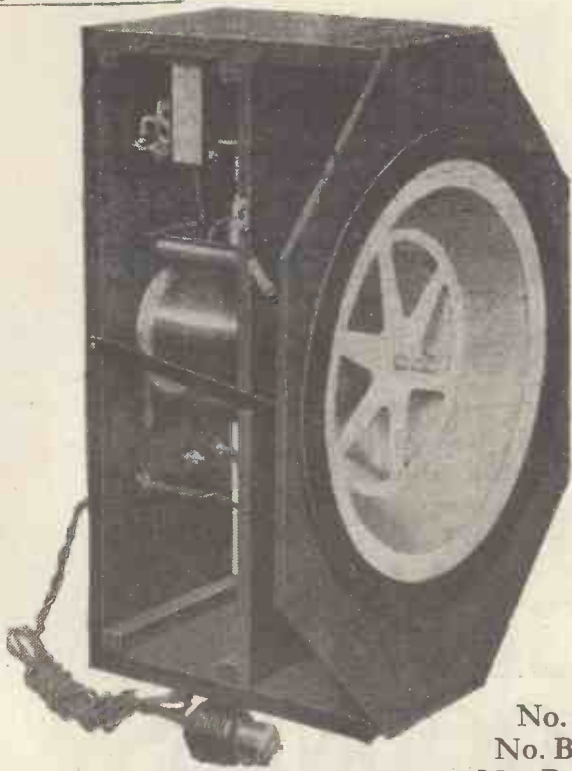

This new Marconiphone Unit represents an enormous advance in moving coil loud speaker design. The entirely new system of double suspension obviates resonances and gives a remarkably even response to all frequencies. Furthermore, it completely eliminates side-play and tendency to sag. Absolutely parallel motion is assured and the smaller air gap makes possible a reduction of the magnet system. Thus not only does this new construction offer markedly superior reproduction but does so at definitely moderate prices. Astonishingly good results can be obtained on any average receiver using an ordinary power valve. The complete unit, assembled, needing only a baffle for immediate use, costs

**only 6 Gns.**

Marconiphone Moving Coil Unit.

No. B. 1289 for operation from A.C. mains.

No. B. 1290 for operation from D.C. mains.

No. B. 1291 for operation from 6-10 volts Accumulator.

Price, all three types, £6 6 0.

D.C. Mains Speakers and Units are easily converted for operation from A.C. Mains by the addition of a rectifying unit.

## THE NEW MARCONIPHONE MOVING COIL UNIT

The Moving Coil Unit is also available completely assembled in singularly attractive cabinets—well built and of pleasing proportions. Marketed in the following assemblies:—

- |          |                                   |             |
|----------|-----------------------------------|-------------|
| B. 1324. | In Oak Cabinet.                   | 6-10 volts. |
|          |                                   | £10 10 0.   |
| B. 1325. | In Oak Cabinet.                   | D.C. Mains. |
|          |                                   | £10 10 0.   |
| B. 1327. | In Oak Cabinet.                   | A.C. Mains. |
|          |                                   | £16 16 0.   |
|          | (Including U.8 valve and Royalty) |             |
| B. 1328. | In Mahogany Cabinet.              | 6-10 volts. |
|          |                                   | £11 11 0.   |
| B. 1329. | In Mahogany Cabinet.              | D.C. Mains. |
|          |                                   | £11 11 0.   |
| B. 1331. | In Mahogany Cabinet.              | A.C. Mains. |
|          |                                   | £17 17 0.   |
|          | (Including U.8 valve and Royalty) |             |

Full particulars on request

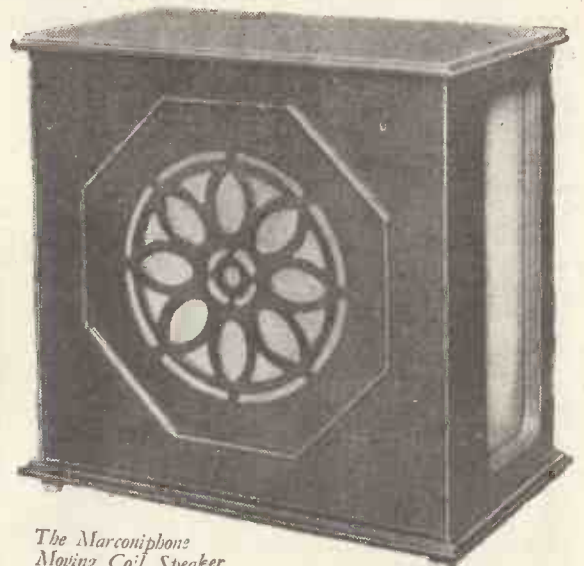

The Marconiphone  
Moving Coil Speaker

**THE MARCONIPHONE COMPANY, LIMITED**

(Dept. P), 210-212 Tottenham Court Road, London, W.1

Showrooms; 210 Tottenham Court Road, and Marconi House, Strand, London, W.C.2

# Amateur Wireless

## and Electrics

The Leading Radio Weekly for the Constructor, Listener and Experimenter

Vol. XIII. No. 327

Edited by BERNARD E. JONES  
 Technical Editor: J. H. REYNER, B.Sc.(Hons.), A.M.I.E.E.

SEPTEMBER 15, 1928

### Our Exhibition Number—Earlier News Bulletins—Atlantic Fliers' SOS— The "A.W." Ace—Wilkie Bard from 2LO—5GB's Dance Music

**Our Olympia Number**—Olympia Week next week! Ours will be an Olympia Number—the first of Two Big Special Exhibition Issues. By the way, there may be difficulty in getting your copy unless you place your order forthwith. Our Comprehensive Show Guide will mention every stand. Our constructional features next week are some of the finest we have ever presented. A special word must be given to a new feature by Mr. W. James, an extremely successful set designer and wireless journalist, about whom the Editor has a personal word on page 309. Turn to that page now, if you don't mind, and see what the Editor says.

**Earlier News Bulletins**—On and from September 24, writes our own B.B.C. correspondent, the first general news bulletin will be read at 6.15 instead of 6.30, and an additional five minutes will be allotted to the popular Foundations of Music series. The new times will be as follows: 6.15 p.m., first general news bulletin; 6.30 p.m., musical interlude; 6.45 p.m., Foundations of Music; 7.0 p.m., talk; 7.15 p.m., musical interlude; 7.25 p.m., talk.

**The Admiral Speaks**—"No broadcasting service," said Admiral Corpendale at the recent dinner on the occasion of the International Broadcasting Conference. "can endure on a foundation of jazz and ephemeral entertainment. These should be present in their correct proportions, with contributions to the intellectual and social life of the community."

**5GB's Dance Music**—Although the B.B.C. officials have to admit that at present there is an "S.B." from 2LO, 5XX, and 5GB of dance music twice a week (as we pointed out last week), they hint at a remedy in the near future, when the new system of "grouped programmes" comes into operation. Can they also see their way to making a rather better contrast between 2LO and 5GB than is provided by a military band concert with two vocalists from the one



An engineer making adjustments outside the French Foreign Office to the apparatus with which a movie-tone film was made of the recent signing of the Anti-war Pact.

and an orchestral concert and two vocalists from the other? Quite often we seek relief from one lady's efforts only to find that someone at the "alternative" station is having the same difficulty with *her* top notes! We make the suggestion that a special alternative pro-

gramme "watch" committee be instituted.

**Wilkie Bard from 2LO**—In the vaudeville programme from 2LO on September 22, the celebrated comedian Wilkie Bard will take part, the title of his turn being "In the Beauty Parlour." This evening is also noteworthy for the appearance of Betty Fields (comedienne) and Jack Strachey pianist, who was part composer of *So This Is Love* and *Lady Luck*. *Experts*, a sketch written by Edgar Middleton and played by Ruby Miller, ought also to be good.

**Atlantic-flyers' SOS**—When Messrs. Hassel and Cramel, who left Canada for Greenland *en route* for Stockholm, were forced to descend on the icy wastes, they sent out wireless messages calling for assistance. As is now known the airmen were rescued, but it is interesting to know that a Mr. T. J. Brian, of Tipperary, Ireland, picked up the following message on a short wavelength about one o'clock on a recent Friday morning: "Hallo! Hallo! Can anyone hear us? We are stranded north of Newfoundland."

**The "New-style Baffle Three"**—This is the name given to next week's big set—which is something entirely new in design. Our technical staff have been working on it for several weeks past, and have now completed their final tests ready for the appearance of the finished model in time for the exhibition. A moving-coil and a push-pull amplifier are ingredients of this intriguing set—full details *next week*—the Show Number.

**The "Ace of Two's"**—A simple two-valver, easy to construct, which gives results equal to an ordinary three-valve set, will also be described. It receives on all waves from 20 to 2,000 metres, there being no coil changing on the broadcast band (250-2,000 metres), while with a short-wave coil several American stations can be put on the loud-speaker. Look out for "The two-valver with the three-valve punch!"

### PRINCIPAL CONTENTS

|                                                  |     |
|--------------------------------------------------|-----|
| Current Topics .. .. .                           | 301 |
| Piezo Peculiarities .. .. .                      | 302 |
| The Beginner's One-valver .. .. .                | 303 |
| What the Exhibition will Reveal .. .. .          | 305 |
| Practical Odds and Ends .. .. .                  | 306 |
| On Your Wavelength .. .. .                       | 309 |
| What Happens When a Switch Closes? .. .. .       | 311 |
| Loud-speaking on Wheels! .. .. .                 | 312 |
| Improvements in Low-frequency Amplifiers .. .. . | 313 |
| For the Newcomer .. .. .                         | 314 |
| Without Fear or Favour .. .. .                   | 315 |
| The Adaptable Three .. .. .                      | 316 |
| "A.W." Tests of Apparatus .. .. .                | 320 |



# Piezo Peculiarities



By MORTON BARR

ALTHOUGH it has been known for nearly half a century that quartz and certain other crystals possessed the peculiar property of reacting electrically to applied pressure, it is only within the last few years that the effect has been turned to practical account. The application of piezo-electricity to wireless is due to the later discovery that such crystals are capable of vibrating bodily or mechanically at a frequency which may vary between 40,000 and 15,000,000 cycles per second.

### Fairyland of Science

Mechanical vibrations of this order are unique in physical science, so that they afford the wireless engineer a valuable means for directly stabilising the output frequency of broadcast transmitters. Piezo crystals have also found a useful purpose in heterodyne reception, and in the standardising and control of high-frequencies in general. This sudden revival in what was originally, at all events, a mere laboratory curiosity, and its useful application to the growing needs of modern wireless technique illustrates in a striking fashion the rich possibilities that are still to be found in the "fairyland of science."

### Pyro and Piezo Electricity

In point of fact, changes both in temperature and pressure will create electrical effects in certain classes of crystal. When the production of an electrical voltage across the crystal is the outcome of an applied temperature change the effect is called pyro-electricity. When the crystal E.M.F. is the result of an applied mechanical pressure, it is termed piezo-electricity. The latter effect was first discovered in 1880 by the brothers Curie.

Fig. 1 shows a transverse section of a natural quartz crystal cut in a plane perpendicular to the optical axis, along which the special light-refracting properties of the crystal are manifested. The section is hexagonal in shape, and the three dotted lines *ad* parallel to the face *fe*; *fc* parallel to the face *ed*; and *be* parallel to the face *cd* indicate the three electrical axes.

### The Piezo Effect

The piezo-electric effect is best illustrated by using a slab such as *xy* cut with its length perpendicular to one of the electric

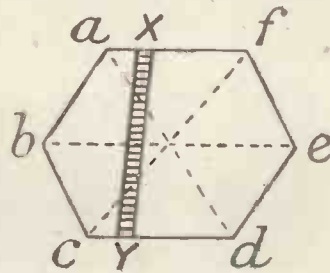

Fig. 1.—Section through Quartz Crystal

axes such as *bc*.

By placing such a slice of crystal between two sheets of tinfoil, and subjecting the

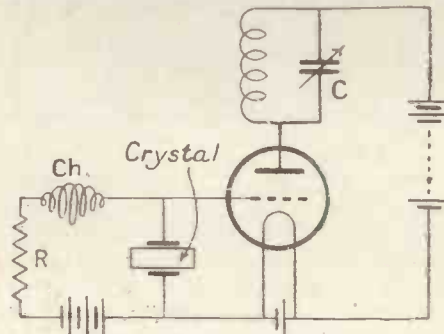

Fig. 2.—Crystal-controlled Oscillator

whole to pressure, the Curies found that an electric charge was produced across the crystal as indicated by a quadrant electrometer connected to one of the tinfoil sheets. When the pressure is removed the first charge is replaced by another charge of

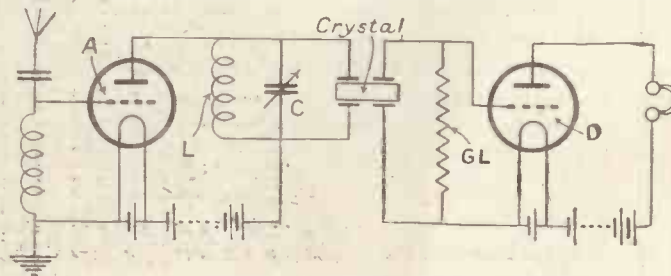

Fig. 3.—Piezo-crystal Coupling for Selective Reception

opposite sign.

A little later, in 1881, Lippman noted

that the reverse of this experiment, held good. In other words a potential difference applied across two faces of the crystal gave rise to a bodily expansion along one axis and a corresponding contraction in length along the other, or vice versa, according to the sign of the applied E.M.F.

To be precise, if a slab of crystal such as *xy* in Fig. 1 is placed in an electric field applied transversely to its length, i.e., in the direction of the electric axis *bc*, the slab *xy* expands along its length and contracts sideways to a corresponding degree, so that its total volume remains constant. If the sign of the applied field is reversed, the axes of expansion and contraction follow suit.

Obviously, therefore, when an alternating current is applied, the crystal will be set into bodily vibration. The amplitude of this vibration and its rate of change with frequency will depend upon the mechanical damping and upon the piezo-electric reaction on the applied field.

### Radio-frequency Vibrations

At first it was thought that these changes in volume on electrification were instantaneous. However, as a result of investigations made by Professor W. G. Cady in 1922, it was definitely ascertained that although taking place with almost inconceivable rapidity they were actually periodic.

It was in fact discovered that each crystal, according to its size, thickness, and certain other factors, possessed an inherent or characteristic vibration of a frequency far exceeding any other known mechanical vibration. As previously stated this fundamental oscillation may reach the extraordinary value of many millions per second.

One method in which the frequency of the oscillations produced by a valve generator can be directly controlled by the inherent frequency of a piezo crystal is shown in Fig. 2. In this case the valve tends to produce sustained oscillations through the capacity-coupling across the internal electrodes due to the tuned anode circuit.

The crystal is shunted directly across grid  
(Continued on page 322)





# The Beginner's ONE-VALVER

*A Particularly Simple Receiver*  
By ARTHUR YORKE

IF you are a new recruit to the army of wireless amateurs, you ought to start with a simple receiver, learn something about its assembly and operation and so gain valuable experience with which to prepare yourself for more ambitious endeavours later on. Some of you newcomers will probably want to skip the crystal stage altogether and to start right

The addition of a one- or two-valve amplifier will convert your one-valver into a serviceable loud-speaker receiver that you really know something about.

### The Hartley Circuit

But enough generalities—let us make a start on this one-valver. From the various illustrations you can see what the finished receiver looks like. From the circuit diagram or the reduced reproduction of the blueprint you may be able to understand the type of circuit in use. If you are not yet *au fait* with theoretical diagrams you are practically working in the dark and you should worry a friend until you can follow such diagrams with perfect ease.

Cross references between the theoretical diagram, the blueprint and the photographic views will show that there are eight separate parts to be considered. I have numbered these in the theoretical diagram for identification purposes.

No. 1 is the tuning coil, shown in the blueprint as a single-coil holder. No. 2 is the tuning condenser, shown in the blueprint as a .0005-microfarad Igranite model mounted centrally on the ebonite panel. No. 3 is a fixed condenser which, with No. 4, the grid leak, is required for rectification. No. 5 is the reaction condenser, shown in the blueprint as a Bowyer-Lowe .0001-microfarad variable condenser, on the right of the tuning condenser. No. 6 is the valve, shown in the blueprint by the valve holder mounted on about the middle of the baseboard. No. 7 is a high-frequency choke, shown on the left of the baseboard. No. 8 is a filament rheostat, shown

in the blueprint on the left of the panel. Having cleared the ground a little for the beginner I will now give a few details of the theory side of the business. Take, first, the tuning coil. This is centre-tapped, so that three coil connections are available—the two ends and the middle. The tuning condenser is connected across the two ends of the coil. The aerial goes to the "top" end (as viewed from the theoretical diagram) and the earth to the centre, leaving the bottom end free. This free end is connected to one side of the reaction condenser, the other side of which is taken to the anode of the valve.

It can now be seen that the one coil serves two purposes. Together with the tuning condenser and aerial and earth it provides the tuning system. Together with the reaction condenser it also provides the reaction system.

### Reaction

I chose the Hartley system, as it is known, because of the simplicity with which both tuning and reaction are obtained. On practice we use an ordinary plug-in coil with a terminal mounted on the side. The earth connection is then made with a length of flex ending in a spade tag which is clamped under the terminal.

To make the valve rectify the signals

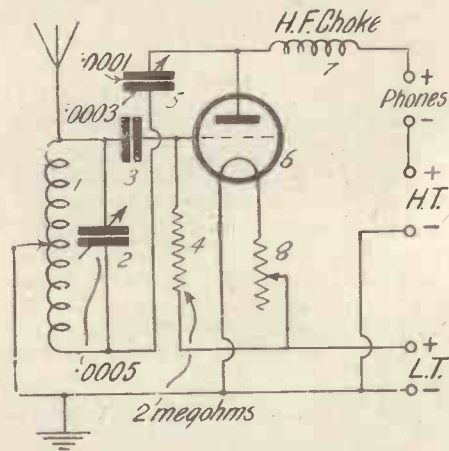

The Circuit Diagram

away with the construction of a valve receiver. If so, take my advice and let your first valve set be a one-valver. Never to have listened with headphones is to have missed part of your education in the gentle art of tuning. If you embark on the assembly of a loud-speaker receiver without any previous knowledge of tuning you will not grasp the essential operating points nearly so easily, and consequently you will find some difficulty in emulating your more expert friends who tune in a long distance station on the loud-speaker just as accurately as they tune in the local station.

With a one-valver, wearing headphones, you will be able to note just what effects are produced as you alter the tuning, reaction and filament controls. You will be able to accustom yourself to fine adjustments of each of these variables to note their modifying effects upon each other and, generally speaking, "get the

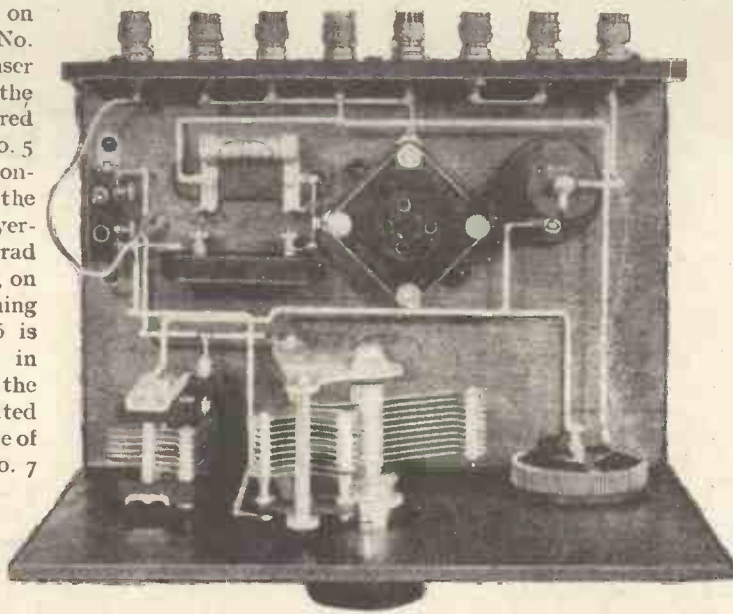

A Plan View of the One-valver

“THE BEGINNER’S ONE-VALVER” (Continued)

we provide a .0003-microfarad fixed condenser, connected between the aerial and the grid, and a 2-megohm grid leak, con-

(Bowyer-Lowe “Elfin,” Lissen, Igranic, Cyldon).

7-ohm panel mounting rheostat (Lissen, Igranic, G.E.C.).

Single-coil holder (Lotus, Lissen).

.0003-microfarad fixed condenser and grid leak holder (Lissen, Dubilier, Graham-Farish, Mullard).

2-megohm grid leak (Lissen, Dubilier, Graham-Farish, Mullard).

Anti-microphonic valve holder (Benjamin, Trix, Igranic, W.B.).

High-frequency choke (Wearite, R.I. and Varley, Watmel, Burndept, Trix).

Eight terminals marked Aerial, Earth, L.T.—, H.T.—, L.T.+, H.T.+, Phones+, Phones— (Bell-Lee, Ealex, Igranic).

Connecting wire (Glazite.) Baseboard, 9 in. by 6 in. by 3/8 in. (Camco).

Dial indicator (Bulgin).

When ordering these components write also to

Start by drilling the terminal strip and ebonite panel. Remember the blueprint can be used as a panel drilling template by placing it fair and square on the panel and pricking through the holes for the filament rheostat, tuning condenser and reaction condenser. Mount the components and screw the terminals to the strip in the order shown. Then with substantial wood-screws fit the panel and strip to the back and front of the baseboard.

By now the little receiver will be looking something like the illustrations. The remaining five components—the high-frequency choke, valve holder, grid leak and condenser and coil holder are screwed to the baseboard from left to right in that order.

Then comes the final process—wiring together the components. Here the blueprint is invaluable, for it gives clear and concise wiring details, which the veriest tyro can follow. You will see that each wire is lettered. All those marked *a* should first be joined together with one or as few wires as possible, then all those marked *b* and so on through the alphabet until every connection is made. Except for the flex lead from the earth terminal to the centre tap of the coil all leads are shaped lengths of Glazite wire, soldered together or to soldering tags on the components.

To test the finished receiver a 60-volt Lissen or Ever Ready H.T. battery, a 2-volt Oldham accumulator, a 2-volt “L.F.” type of valve, a No. 60 centre-tapped coil, a good aerial and earth and a pair of headphones are required.

Lewcos, Lissen, Atlas, Tunewell, D.X. or Igranic plug-in coils are recommended. Amongst the valves I have tried with success are the following: B.T.H. B210L, (Concluded in third column of page 312)

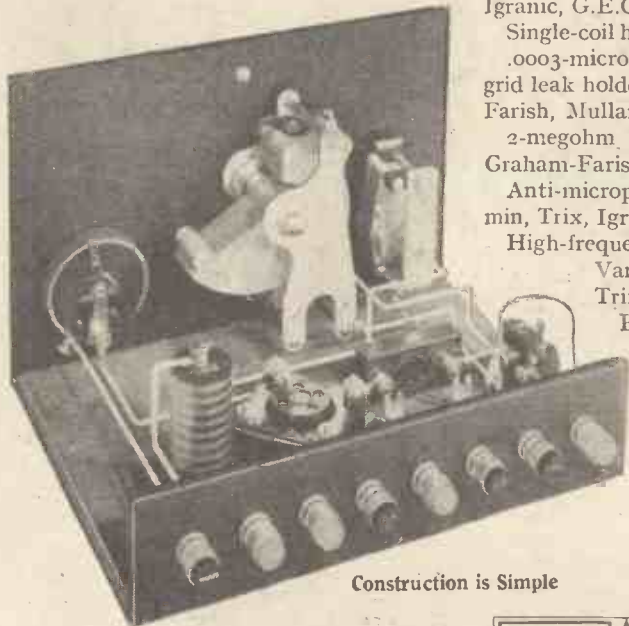

Construction is Simple

nected between the grid itself and the positive side of the accumulator.

To control the amount of current flowing through the filament from the low-tension battery, a 7-ohm filament rheostat is connected in series with one of the filament leads—actually the positive lead.

The high-frequency choke is an important part of the circuit. By its insertion in the anode circuit we divert the high-frequency energy (groups of high-frequency oscillation forming the rectified pulsés) through the reaction condenser and coil instead of allowing this energy to waste itself through the phones and H.T. battery to earth.

The amount of energy permitted to get back to the aerial circuit can be varied by rotation of the reaction control; the greater the capacity of the reaction condenser, the greater the energy diverted.

The high-frequency choke, while acting as a complete barrier to high-frequency energy permits the flow of the low-frequency pulsations that operate the headphones. There is, I realise, a lot more that might be explained about the mode of action of the complete circuit but space has to be considered and as all the essentials have been referred to I propose to carry on now with the constructional points.

Here is a complete list of components that will be required for the assembly.

List of Components

Ebonite or bakelite panel, 9 in. by 6 in., and strip, 9 in. by 2 in. (Paxolin, Radion, Becol, Pertinax).

.0005-microfarad variable condenser (Igranic “Lok-Vane,” Burndept, Lissen, J.B., Polar, Cyldon).

.0001-microfarad reaction condenser

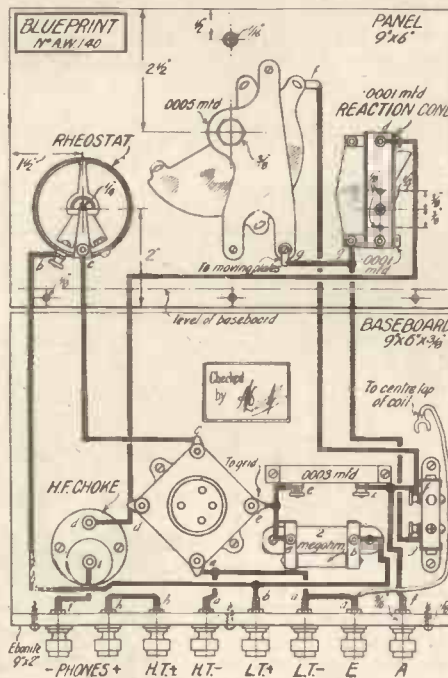

The Wiring Diagram. Blueprint available, price 1/-

the AMATEUR WIRELESS Blueprint Dept., for the full-size blueprint of the “Beginner’s One-valver.” It is one shilling post free and fine value for money. You have no idea, probably, how confidently you can tackle constructional work with a blueprint by your side!

From an examination of this you should be able to see your own way—but here are a few notes.

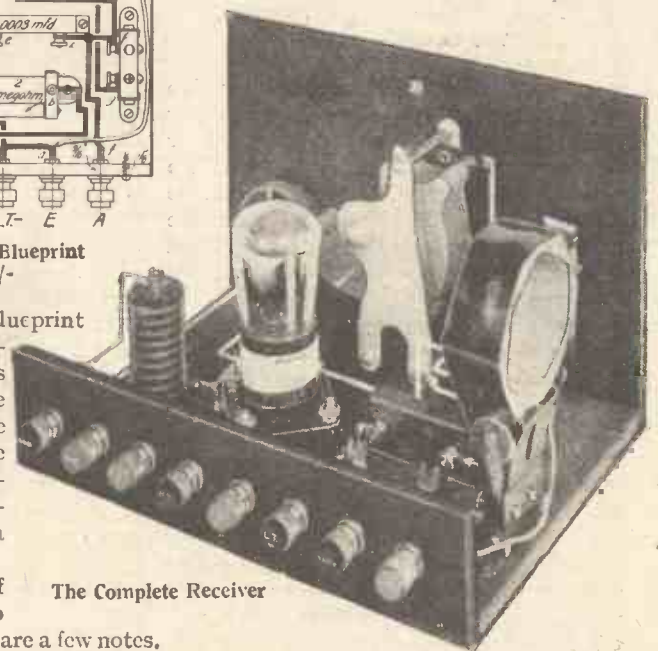

The Complete Receiver

# What the Exhibition Will Reveal



## DEVELOPMENTS THAT

WITH little more than a week to go before the opening of the Exhibition at Olympia, interest is running high concerning the changes which will have taken place since last year's show. "What's new or strange?" is the cry of the moment. Some forecast of new developments likely to be present can be made and this will serve to focus the attention of those readers

who intend to visit the show to see the novelties.

There can be little doubt that the most outstanding development of the past season has been in the matter of valves. The general improvements here have already been discussed in a recent issue of AMATEUR WIRELESS where I pointed out that the introduction of the single-ended type of screen-grid valve had resulted in a considerable improvement in the sensitivity at some sacrifice of the inherent stability of the older patterns. The principal valve manufacturers will have two- and four-volt models available, while it is understood that the Ediswan Company will be exhibiting a 6-volt screen-grid valve of the single-ended type.

### Pentodes

Pentodes will undoubtedly be present in considerable quantities, not only as components, but also in manufactured receivers. One of the most popular sets during the forthcoming season for the amateur who is prepared to take a certain amount of trouble and expense will be the three-valve combination utilising a screen-grid H.F. valve, a detector, and a pentode. Such a combination properly handled, will give very nearly the equivalent of 5-valve results.

Apart from these developments, however, an interesting new feature is to be found in the new Marconi and Osram directly-heated A.C. valve. These valves have filaments taking .8 ampere each, this current being supplied directly from alternating-current mains through a step-down transformer. The filaments are so designed that the heating is comparatively low and as the filaments are relatively massive, they retain their heat, irrespective of the variations in the current. The result is a steady emission of electrons quite free from ripple.

The indirectly-heated A.C. valve has, of course, been on the market for some time and in view of the extraordinarily good characteristics which are obtainable, as for example with the Metropolitan-Vickers A.C. valve, it is surprising that greater use has not been made of this class of valve in the past. New and improved valves of this

## WILL AFFECT YOU

type will be on show so that some interesting comparisons will be possible.

### Two Valves in One

Some reference should also be made to a new B.T.H. valve, which is probably to make its appearance quite shortly. This is a product having two distinct valves within

*(Continued on page 332)*



1. Dubilier Anti-interference Unit (Stands 102, 103). 2. Met-Vick Fixed Condenser (Stands 32, 41). 3. Met-Vick A.C. Valve-holder Adaptor (Stands 32, 41). 4. Ferranti Milliammeter (Stands 84, 85). 5. T.C.C. Fixed Condenser (Stand 121). 6. Eagle Engineering Reaction Tuner (Stand 139). 7. Igranic Drum-control Condenser. (Stands 53, 54, 75).

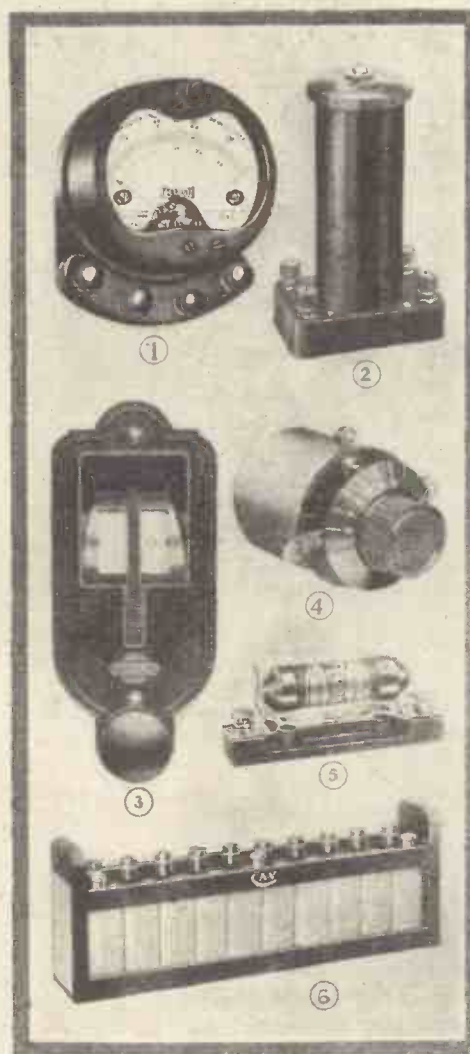

1. Ferranti Triple-range Meter (Stands 84, 85). 2. Igranic H.F. Choke (Stands 53, 54, 55). 3. Igranic Vernier Drum Control (see above). 4. Igranic Variable Resistance (see above). 5. Ferranti Wire-wound Resistance (Stands 84, 85). 6. C.A.V. 20-volt H.T. Accumulator (Stand 114).

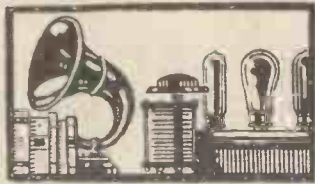

# PRACTICAL ODDS & ENDS

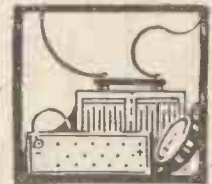

## Improving the Cone Speaker

THE reproduction of low notes from the type of cone loud-speaker which is not provided with a baffle can be considerably improved by standing the instrument inside a suitably-sized cabinet with the periphery of the diaphragm clamping-ring resting against a ring of soft rubber or felt packing.

A circular hole will be required, of course, in the front of the cabinet of a size to suit the speaker, while for security, it is advisable for a wood clamping piece to be fitted, so that the base of the speaker is held rigidly in position.

The back of the cabinet should not be covered, except, perhaps, by a piece of

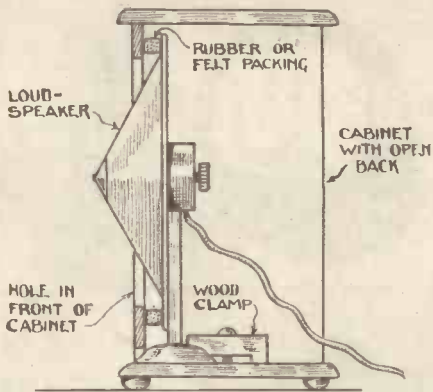

A Suggestion for Eringing out the Low Notes muslin which may be used to prevent the ingress of dust. T. S.

## Crystal Detector Tips

EVEN the best crystals in time become insensitive and seem useless. When this happens, amateurs usually discard them. This is unnecessary, however, for by chipping pieces off the crystal a new and sensitive surface will be exposed.

When the catswhisker breaks and another is not at hand, a new one can soon be made in the following manner. A piece of stranded copper wire is taken, and a strand about half an inch in length untwisted, and one end cut to a point by a pair of scissors. The other end is then gripped in the control arm and the catswhisker is ready for use. L. W.

## A Useful Coil Rack

IT helps the experimenter, if his coils are always kept neatly on a rack of some sort, so that he can immediately obtain the coils he requires. A useful coil rack may be made with the aid of the wooden stiffening rods which are supplied with the 2-ft.

lengths of Glazite wire. These stiffening pieces are about 1/4 in. in diameter and make excellent stakes if fitted into a suitable back.

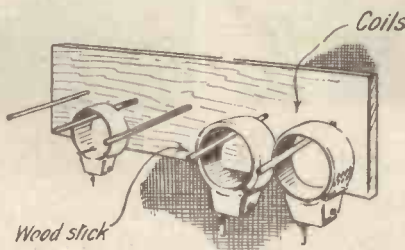

An Easily-made Coil Rack

To make the rack take a piece of wood, about 1 1/2 in. wide and 1 in. or 1 1/2 in. deep. The length should be determined by the number of coils to be carried. Holes should be drilled 4 in. apart in the wood, the diameter of those holes being just sufficient to make a tight fit for the Glazite rods.

The rods should then be cut into pieces 6 in. long, and driven into the holes. Small pieces of paper may be stuck immediately under the pin or slightly to one side, to indicate the number of the coil. H.

## Coil Winding

A VERY practical and useful suggestion is given in the drawing below.

At various "sixpenny" stores, small knife grinders with detachable emery wheels are obtainable. One of these will make an excellent coil winder. The emery wheel is simply removed and the coil

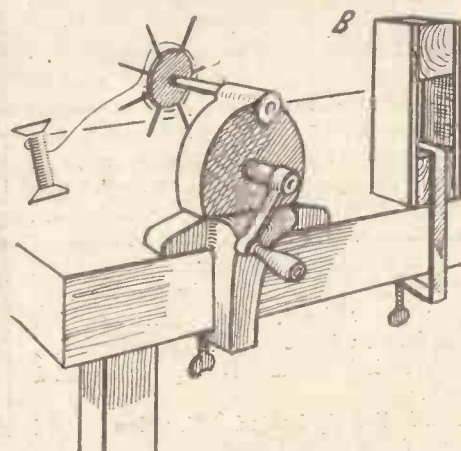

A Simple and Cheap Coil Winder

former, whether of the honey-comb type, indicated in the drawing, or of the cylindrical kind, mounted in its place. In the case of the latter former it will be necessary

to cut a circular piece of wood to fit its end.

When large coils are to be wound it may be found necessary to employ a block, as shown at B in order to obtain the required height.

Besides being easily wound, the coils will be neat in appearance. J. H. W.

## Supporting Flexibles

WHEN a long flexible wire is used for making connection to a battery, coil or valve in a receiving set, a support of the simple type shown in the illustration may be advantageously employed to keep the flex from hanging near to or touching other wires in the set.

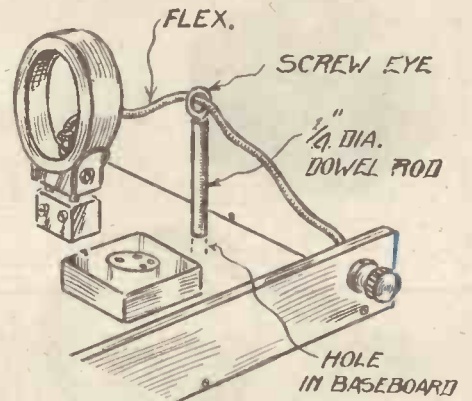

A Tip for Preventing Accidental Shorts

The support consists of a length of 1/4 in. diameter wood dowel rod, of suitable length, terminating at one end in a small screw-eye. The complete support is then stuck into a 1/4-in. hole drilled through the baseboard in a convenient position.

In the case of leads at low potential, such as grid-bias battery flexibles, the leads may be passed together through one screw-eye, but in the case of leads carrying H.F. currents, they should be kept well separated and clear of all other wires. P. N.

The General Electric Co., of New York, states that, with permission, it is intended to raise the power of WGY (Schnectady) to 200 k.w. this autumn.

There are four broadcasting stations now in operation in Africa and another in the process of erection; there are 16,000 licensed receiving sets.

KSL (Salt Lake City) has been granted permission to increase its power to 5,000 watts. A new station, costing about £40,000, with 250-ft. aerial towers, is to be erected six miles west of the city.



# Marvellous New Scientific Process for making Wireless Valves

*Better All-round Performance Guaranteed*

## **TENACIOUS COATING**

### *A Triumph for Osram Valves!*



**BADLY COATED FILAMENT**  
Reproduction from an untouched Micro-photograph of part of the filament of a badly coated valve before use, showing a serious gap in the coating. A gap such as this starts the valve off in its life with a poor performance, and may bring about a further portion of the coating falling away or peeling off. The valve then prematurely fails.

Good News for wireless enthusiasts! This season's Osram Valves represent a startling advance in valve manufacture.

*It's the coating on the filament, not the filament itself, that gives you results.* The better the coating adheres to the filament the longer the valve will last.

In the new process the coating is not merely pasted on to the filament. As a matter of fact the filament is *not* coated at all until the construction of the valve is completed and all the air has been exhausted from the bulb. Then in a vacuum atoms of the pure metal are deposited on the filament to form a solid "TENACIOUS COATING."

Think what this means! It means that the well-known enormous electron emission of Osram Valves is *maintained* throughout an exceptionally long life.

Change to Osram Valves immediately and get the benefit of "TENACIOUS COATING."



**OSRAM FILAMENT with "TENACIOUS COATING"**  
This reproduction shows the coating typical of all OSRAM VALVES. Notice the absolute evenness of the coating. There are no gaps, the coating clings, so that the full benefit of the coating is maintained. The secret is the startling new discovery of the scientific process of "TENACIOUS COATING."

## **CHANGE**

*to the latest improved*

# **Osram Valves**

and

## **CHANGE for the Better!**

*Scientifically made by Experts in England. Sold by all Wireless Dealers.*

**WRITE** for Booklet "OSRAM WIRELESS GUIDE," giving full particulars of "TENACIOUS COATING" and full range of OSRAM VALVES for 2v., 4v. and 6v. users, and users with A.C. Electricity Supply. Also helpful wireless information of importance to every listener. Sent POST FREE on request to THE GENERAL ELECTRIC CO., LTD., Publicity Organisation, Magnet House, Kingsway, London, W.C.2.

Advt. of The General Electric Co., Ltd., Magnet House, Kingsway, London, W.C.2.

Advertisers Like to Know that You Saw it in "A.W."

**FERRANTI**



**30/-**

The  
**A.F.5**  
**TRANSFORMER**

properly used will give results superior to any other coupling device available, and has been designed for the constructor who requires quality results above everything else.

IT IS  
**SUPERLATIVE**

FERRANTI LTD.  
HOLLINWOOD, LANCS.

**GREAT  
REDUCTION IN  
PRICES  
of  
BELLING-LEE  
TERMINALS**

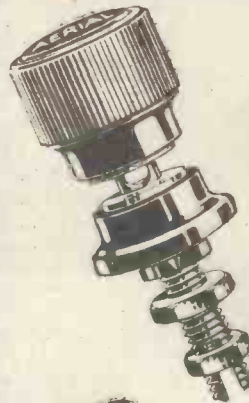

Last year, when Belling-Lee patented terminals enjoyed a popularity reached by no other terminals, we were obliged to extend our Factory premises in order to meet the overwhelming demand.

The result is that we have now increased our output by 50%.

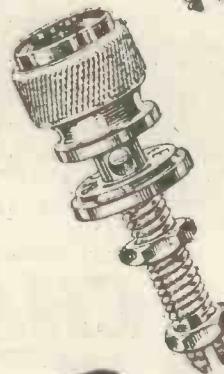

Increased efficiency and output and the sacrificing of profit to turnover, have enabled us to effect the following substantial reductions in price:—

Type 'B'—Standard large insulated model (polished black bakelite) 6d. each (formerly 9d.)

Type 'M'—Popular model, as type 'B', but not insulated, 4½d. each (formerly 6d.)

Type 'R'—Cheap competitive model with rotating name, 3d. each (formerly 3½d. each).

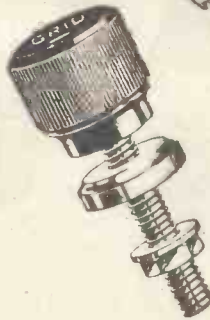

Send to-day for our new Season's Illustrated Catalogue.

STANDS 220 and 221  
AT OLYMPIA.

**BELLING-LEE  
TERMINALS**

BELLING & LEE, LTD.  
QUEENSWAY WORKS, PONDERS END, MIDDLESEX.

# On Your Wavelength!

## Speak Up!

I HAVE no need to make any excuse for returning this week to the subject of the "whispering announcer" nuisance. Savoy Hill has, indeed, spoken for itself on this subject during the last few days—in the form of giving us some perfect examples of this peculiar "chest tone" disease. At the end of almost every piece of music broadcast the announcer's voice has boomed out of our loud-speakers in a most unnatural manner, just because you and I, with our moving-coil loud-speakers, will not jump up and reduce the volume for speech. As I said before, the B.B.C. ought to insist that their announcers speak up or that volume be reduced for speech, especially for announcements during musical programmes. It seems a great pity that we can't shout a good old "speak up!" like the gallery-ites, who pay their good money to see and hear an almost inaudible play.

## Rule of Thumb

The fact of the matter is that the art of broadcasting just isn't. Except for some of the better plays and music, which are still accorded the assistance of a little imagination on the technical side, broadcasting is now being carried out with the precision of a well-oiled machine. The chief announcer's voice when reading the news bulletin is controlled to modulate, say, "two thousand." Very well; all other voices have to be controlled on the amplifiers in such a way that they modulate the transmitter "two thousand." Consequently, when a speaker with a very quiet voice is broadcasting or announcements are made between loud musical items, the relative strengths are not correctly broadcast. Jack Payne, for instance, is hardly intelligible when he speaks between "numbers" broadcast by his dance orchestra (you see I'm very careful not to call it a band!). Unless one reduces the strength of loud-speaker reproduction, his voice sounds boomy, husky, and "out of breathy," and not at all like what it really is. If the B.B.C. don't do something about it, Jack should speak a little more loudly himself.

## Black Tape

I must be a little bit "liverish" this week, for I'm going to indulge in another little grumble. This time it is not about over-modulation, atmospherics, or B.B.C. red tape. It concerns black tape, another variety of tape that is evidently used in great quantities by the B.B.C. I refer to our old trusty stand-by, the black adhesive insulation tape, splendid specimens of which may be viewed nightly on the microphone wires at the Queen's Hall. The microphones at this most important centre of broadcasting are tied up with string, old

bits of twin flex, and insulation tape, and are slung high for all the world to see. The fact that they function perfectly does not excuse the engineers from perpetrating a first-class "lash up," especially as the "Prom." transmissions are more or less permanent.

## High Time

Considering the fact that the microphones would be slung during the whole of the season, one would have thought that the powers that be would have indulged in the luxury of rather more permanent, or ornamental, wiring. Think of the hundreds of prospective wireless men who may have been led astray by this weird and wonderful wiring, reminiscent of the works of Heath

Robinson. Mind you, I haven't a word to say against the transmissions from the Queen's Hall. All the Promenade concerts that I have heard on my loud-speaker have been excellent from all points of view, and not the least virtue of the transmissions has been the fact that there are no announcements between the items.

## Sound Films

Sound films are with us with a vengeance. All the cinemas in the West End of London are now equipped with sound-film apparatus. There is the Vitaphone at the Piccadilly Theatre, the Movietone at the Plaza and the New Gallery, the British Acoustic at the Marble Arch Pavilion, Capitol, and Astoria, and the Phonofilm at the Rialto. All the processes, of course, use amplifiers and loud-speakers, and so will be of great interest to "wireless blokes."

## Man's Systems

The Vitaphone and the Movietone are American, the former recording the sound on a synchronised gramophone disc and the latter on the edge of the cinema film. In both cases the loud-speaker is of the large exponential horn type, and the amplifiers include one or two stages of push-pull transformer amplification. The British Acoustic process is really not British, but Danish, an invention of Poulsen (the same Poulsen, I believe, that invented the arc type of radio transmitter). This system uses a separate film for recording the sound, resistance-coupled amplifiers, and moving-coil loud-speakers. The Phonofilm, joint invention of Dr. de Forest and Mr. Elwell (and therefore of Anglo-American origin), is similar to the Movietone in that the sound is photographed on the edge of the movie film. Other processes, British, German, and American, have yet to be heard. And still other processes have been heard—and will never be heard again! Sound films will have to be standardised and interchangeable, and the puzzle at the moment is: Which is the best system? Cinema proprietors are naturally rather nervous of sinking large sums of money on the "wrong horse."

## Good Points

The great difficulty of the situation is that every system has its own specially good points and that the ideal would probably be a combination of these points. One system has a wonderful loud-speaker, another has perfect (and infallible) synchronisation, and yet another is the most perfect method of recording. There is one thing that is certain, however, and that is that sound films have come to stay.

## "Kaleidoscope"

Rather interesting, wasn't it? We seem

## MAY THE EDITOR SPEAK TO YOU?

MAY I have a personal word with every reader? It is about next week. The Great Exhibition opens at Olympia on Saturday, September 22, and on the Thursday before—that is NEXT Thursday, you know—I am publishing the Biggest Show Number that has ever been produced by me. It will be a very fine issue indeed, I think. It will contain a Complete Show Guide in which every stand will be mentioned, and amongst the constructional features will be "The New-style Baffle Three" on which my technical staff have long been busy; Mr. Reyner's very fine "Ace of Two's"; Capt. Round, another exclusive "A.W." and "Wireless Magazine" contributor, in a special article, will talk most helpfully about his "Ideal in Sets."

Next week's issue will be noteworthy for the first appearance of a brand new feature from the pen of

Mr. W. James, the designer of the well-known "Everyman Four," a set produced some time ago by an old and highly esteemed contemporary.

Mr. James, in his new feature, which will occupy a page in every issue from next week onwards, will give readers the fruit, as it were, of his own personal experience and will chat in a simple, practical and vivid manner on all sorts of interesting subjects that properly come within the province of the listener's den and wireless man's workshop. Mr. James is wireless editor of the "Morning Post" and "Sunday Express," and I should like readers especially to realise that the only wireless periodicals benefiting from his work in future will be those edited by me—"Amateur Wireless" and "Wireless Magazine."

This exclusive feature starts NEXT WEEK in our Big Exhibition Number, which is the first of two special exhibition issues. Please order it immediately and tell your friends to do the same!

Bernard Jones

## On Your Wavelength! (continued)

to be having versions of *Faust* dished out to us in many different forms lately—by the film (with Jannings), the opera, Arnold Bennett's modern play, and now via ether. We were informed beforehand that "Kaleidoscope" was an experiment, and if the experiment was to demonstrate the flexibility of the B.B.C. play control board, it may be considered to have been successful. The play control board, a rather complicated gadget for controlling, mixing, dissolving, and generally messing about with the outputs of many studios and outside broadcasts at the same time, is the invention of Baynham Honri, who has left the B.B.C. and is now developing a sound-film system. I was thoroughly entertained by "Kaleidoscope," and hope that the B.B.C. will be brave enough to try a few more experiments on us.

### The Matter of Quality

I was at one of the Proms. the other night, and I came away with the perturbing impression that even with the best quality of reproduction, as we know it to-day, we are short of the actual thing by a very measurable distance. It is really quite a healthy occupation attending a good concert of this nature, for one is apt to become satisfied with one's existing methods, turn round in a pleased manner and say, "By Jove, isn't that quality good?" and one's admiring audience burbles suitable soothing remarks. After this, a touch of the real thing comes as quite a rude shock, for one realises that we have still not conquered the problem. Perhaps this is fortunate, for it will be rather dull when we have no improvements to make.

### Light and Shade

What particularly struck me, however, was the light and shade in the transmission. In a particularly dramatic passage one might obtain a sudden fortissimo chord, the orchestra suddenly going "flat out" after a spell of pianissimo work. This would be completely lost in an ordinary broadcast reproduction. The range in a broadcast receiver is apparently by no means large enough. In an orchestral pianissimo, one can practically hear a pin drop. If you don't believe it, go and hear the Queen's Hall orchestra playing the "Death of Asa" from the *Peer Gynt* suite. At the other end of the scale we have the orchestral fortissimo which practically shakes the floor. To reproduce this on a broadcast receiver, of course, demands a really high-power amplifier and a moving-coil speaker, but surely one can obtain a similar range by going from the real pianissimo to something a little less drastic than the full fortissimo.

In the ordinary receiver and amplifier, there is not this range of volume. It, indeed, makes one wonder whether there is not something wrong in the amplifiers and

the loud-speakers which we are using at present. The dual-impedance enthusiasts, of course, claim that this is the case and that resistance and transformer methods are not adequate to cope with the varying strengths of transmission. They claim that the dual-impedance system gives a much more faithful reproduction of the light and shade, so that the range of sound is extended appreciably and the resultant transmission is nearer perfection than is obtainable with any other methods.

### B.B.C. Methods

If this is so, and the evidence to prove this contention appears to be quite definite, what of the B.B.C.? They have to employ amplifiers in their systems from the microphone to the transmitter, and it is well known that resistance-coupling is employed practically throughout. Is not this responsible for the relative flatness of the B.B.C. transmissions? Would it not be better to use dual impedance or some other improved form of coupling, at any rate in a portion of the amplifier? There is, of course, the control room watching the strength the whole time, but they can only look after gradual variations and cannot conceivably take account of sudden changes. The relative strengths in a transmission are under the control of the conductor of the orchestra, who alone knows what he is proposing to do. Therefore, one must have a really faithful system, and if resistance coupling does not amplify differing strengths of signal in the correct proportion, then it is about time that other methods were devised. Possibly dual-impedance coupling will prove a partial solution of the difficulty.

### Back To It

Well, you and I and all the rest of the world are back from our holidays once more ready to settle down to work and wireless. I am already planning new and special sets for the coming autumn—in fact one of them, a super-heterodyne of the superest kind, has even now got as far as being laid out on a board and wired up in the rather cat's-cradle way that we experts (said he with a modest blush) use in the privacy of our own laboratories or workshops. Myself, I always use No. 22 d.c.c. for these preliminary hook-ups, because when you are in a hurry it saves an immense amount of time. You just snip off what you want, pull back the insulation with the fingers of your left hand, what time those of the right make a small hook in the bared end. Then on goes the lead in the proverbial

two ticks. Later on when, after any alterations that may be necessary, the set is working to your satisfaction, you wire it up prettily and allow your friends to see it.

### Hook-up Boards

The hook-up board is a thing that every wireless enthusiast should possess, for it immensely simplifies the process of trying out any of the new circuits described in *AMATEUR WIRELESS* or *Wireless Magazine*. One that I make a lot of use of consists simply of a piece of white wood  $\frac{3}{4}$  in. thick. It is 10 in. wide and 24 in. long. Along the back edge is a row of terminals provided with milled nuts at both ends of their shanks. To the front edge one attaches by means of a couple of screws apiece vertical strips, 3 in. wide by 8 in. high, in which  $\frac{3}{8}$ -in. holes are drilled at two levels. On them variable condensers, rheostats, potentiometers, and so on, can be mounted in a moment.

The strips, with the components that they carry, can be moved one way or the other on the baseboard with the greatest ease simply by extracting their holding screws and putting them in again somewhere else. A tip that I find exceedingly handy is to rule off the baseboard into 1-in. squares. Then when you have got a particular circuit working to your liking, you can see at once just what the positions of the various components are as measured from the edges of the baseboard. The cost of such an outfit is trifling, and it is jolly well worth while, for it saves any amount of time and trouble.

### Valve Points

As I predicted at the beginning of the year, we are getting on pretty fast as regards progress in valves. The Exhibition of 1928 will see both the pentode and the new A.C. valves in being. The latter mark one of the biggest strides yet made by valve manufacturers. Some time ago we had valves fitted with indirectly-heated cathodes, which worked from the mains by means of a simple transformer, and these proved pretty good. The new models, however, are much better for a good many reasons. It has been found possible in them to produce a big variety of types and the bugbear of A.C. hum has been eliminated. The only drawback is that these valves cannot yet be used for rectification purposes.

The rectifier is always the most ticklish valve in the set, and no means has yet been found of getting rid entirely of the noise if its filament is heated by A.C. What, however, one can do is to fit A.C. valves in all other holders and to use one of the directly-heated type as rectifier. The new models are exceedingly economical of current, requiring only .64 watt apiece, an amount which is neither here nor there when it comes straight from the mains.

THERMION.

### NEXT WEEK:

## A COMPLETE GUIDE TO THE EXHIBITION





# What Happens When a Switch Closes?

Dr. Alfred Gradenwitz describes some Interesting Experiments

THE occurrences in extremely rapid electrical processes have for some years been investigated by Dr. W. Rogowski, Professor at the Aix-la-Chapelle Engineering College, who, in co-operation with his assistants, was successful in rendering such processes visible to the eye and recording them on the photographic plate, even though they were happening within such minute time intervals as one-millionth, one-hundredmillionth, nay even one-thousandmillionth of a second. The means used to this end was a highly improved cathode oscillograph, the prototype of which is the Braun tube.

### The Cathode-ray Oscillograph

The Braun tube is very appropriately likened to a machine gun shooting electrons: Assuming two electrodes  $\kappa$  and  $A$  (Fig. 1) to be inserted into a glass tube and connected up to a source of a continuous current high-tension potential of, say, about 30,000 volts, the air in this tube being exhausted to about one-hundredth millimetre mercury column, crowds of electrons will issue from the cathode  $\kappa$ . In fact, the whole will be functioning like an electrode gun, the projectiles of which pass through a minute bore in the anode  $A$ , striking, at some distance, a fluorescent zinc sulphide plate. The point of impact will be marked by a flashing, in the event of continuous "shooting," by a luminous point.

The possibility of recording any electric process by means of a "machine gun" such as this will be understood by reference to the case of an actual machine gun, the projectile of which has to pass through a hole, traversing on its way two wind zones at right angles to one another. The point of impact of the projectile will then be shifted so as to trace a given curve, by

controlling the intensity and direction of the wind. If, on the other hand, the wind in one direction be known, this curve will enable successive variations of the wind

each of these fields will displace the point of impact of the electrons, which will trace a luminous curve enabling the phenomena in one of the electric fields to be calculated if their successive course in the other field be known.

Previous experimenters had been photographing the luminous tracing of the electron impact from outside, thus investigating phenomena of a duration of one-thousandth of a second. According to a later development, however, the photographic plate was inserted into the vacuum, in the place of the fluorescent screen, exposing it direct to the impact of electrons. The Braun tube had to this effect to be fitted with special devices, ensuring a satisfactory vacuum, though plates were exchanged frequently and though atmospheric pressure was in such cases admitted to the tube. Provision had, moreover, to be made for alternately watching the phenomena on the fluorescent screen and recording them on the plate. This was achieved by Rogowski and other experimenters, enabling phenomena of about one-hundred-thousandth to one-millionth of a second to be registered.

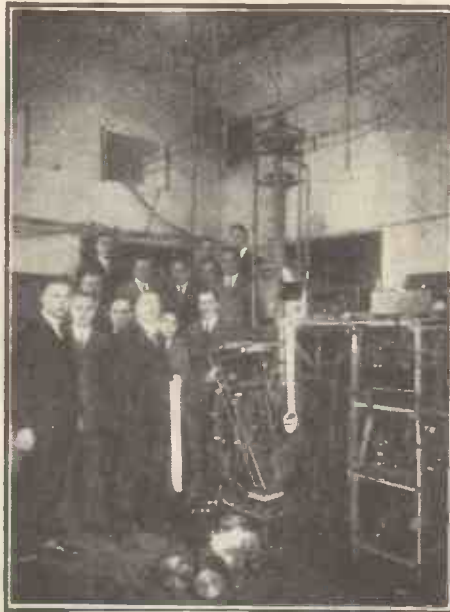

Prof. Rogowski and his apparatus for taking charging-wave records

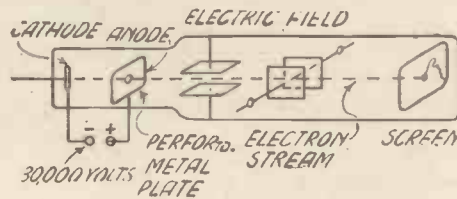

Fig. 1. Diagram of Braun tube

in the other direction to be calculated.

What the wind is to the actual machine gun, two electric fields are to the electron-shooting "machine gun" above referred to;

### Refined Methods

The latest development in cathode oscillographs, in accordance with the above, was based on a realisation of the fact that the usual electron-shooting guns have a very strong dispersion, most electrons striking the anode and glass walls, instead of traversing the hole, and thus completing their course without any useful effect.

This state of affairs was remedied by Prof. Rogowski and his assistants, any dispersion being done away with practically entirely. The change thus produced can be

(Continued on page 328)

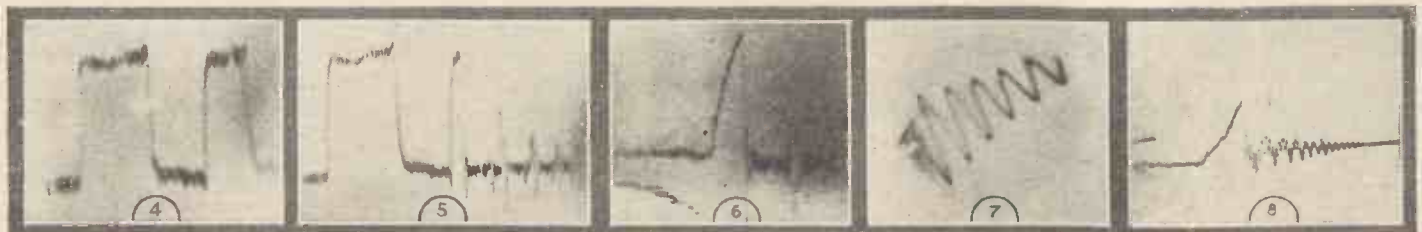

Fig. 4.—Charging at end of open double conductor line 60 metres long. First rise from zero to 10,000 volts in less than one-hundred-millionth of a second. Fig. 5.—Tension curve of point electrode spark-gap at end of conductor line 60 metres long. Fig. 6.—Mica sheet .025 cm. thick being punctured. Fig. 7.—Damped condenser discharge. Fig. 8.—Tension curve of spark-gap with flat tension rise.



The Siemens-Halske Musical Van

ON its way to Hastings, the *Evening News* loud-speaker van, which has been entertaining holiday-makers all round the coast, stopped for a "breather" at the White City, London, where I recently made its acquaintance. It is a monster van with a 24/75-h.p. Krupp engine, which is really worth a description of its own, although just now I must confine myself to telling you that it is a six-cylinder engine with overhead valves, a unique feature being that while running on five cylinders the sixth can be operated as a compressor for the purpose of inflating the huge pneumatic tyres fitted to all the wheels.

As one of the engineers explained, the interior of the van can be heated by hot air through a variable radiator, while large drop-down windows and plenty of "head room" ensure a cool temperature in warm weather.

#### Wireless Equipment

Now for the wireless side of the business, which is even more interesting. The whole idea is a mobile equipment capable of

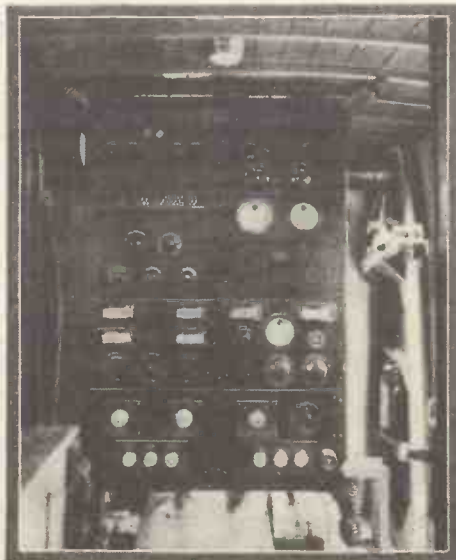

The Control Panel

transmitting speech and music over a large area from the giant loud-speaker, and this within a few minutes of the car coming to a standstill. Anyone who has seen the elaborate Siemens loud-speaking equipment, which I described some time ago as reminiscent of 2LO's transmitter, will agree that to put all this on wheels is no mean task; but it has been done, as I soon found out when I stepped into the main body of the car.

There I was confronted with the main amplifier, its two giant valves, and the generator switches and controls. Running fore and aft, mounted on an aluminium bed-plate, and coupled on a single shaft are the three generators, giving 30, 220, and 1,500 volts. These machines are driven through a separate gear-box and clutch from the engine.

#### Giant Loud-speakers

Two of the biggest Siemens loud-speakers are carried on the car, one of which can be raised by a most ingenious lifting gear through a sliding trap-door in the roof of the car. I was invited to clamber on to the roof to see this mechanism operate. The loud-speaker was rotated in a complete circle, and its angle with respect to the roof altered with the greatest of ease from the inside and the music projected in all directions. When I tell you that the loud-speaker weighs 4 cwts. you will better appreciate the clever design of this device.

Most of the music is provided by means of gramophone records played in a damped sound-proof transmitting-room in the front of the van, which also houses a two-valve long-range radio set, for use when suitable music is being broadcast, and a microphone

# LOUD-SPEAKING ON WHEELS!

*Music for the Multitude—  
"A.W.'s" Special Commissioner Tells How it is Provided*

with its attendant amplifier. I mustn't forget the electrically-driven gramophone.

When the loud-speaker is required in a position where the car cannot stand, a steel tripod 25 ft. high is erected on the roof of the car, and telephonic communication is provided between the control and wherever the loud-speaker happens to be placed. On either side of the car are fitted illuminated programme boards with interchangeable letters. In fact, nothing seems to have been forgotten.

When it is realised that speech or music can be transmitted over a distance of more than a mile from the equipment within three minutes of the car coming to a standstill, the value of this new mobile marvel will be readily appreciated.

#### "THE BEGINNER'S ONE-VALVER"

(Continued from page 304)

Cosmos SP16/G, Cossor 210L.F., Ediswan GP2, Marconi HL210, Mullard PM1LF, Osram HL210 and Six-Sixty SS210L.F.

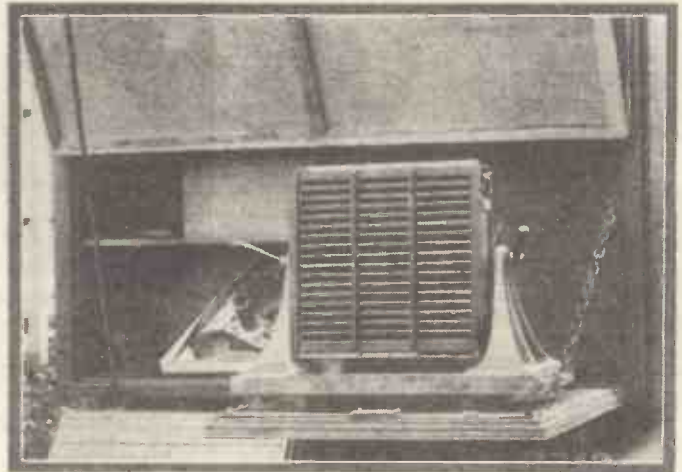

A View of the Siemens-Halske Loud-speaker

Having connected up the accessories, set the filament rheostat nearly full on and the reaction condenser at zero and slowly rotate the tuning condenser until the local station is heard. Then bring in the reaction condenser until signals are received at good strength. To search for a distant station increase reaction until the receiver is just oscillating, rotate the tuning knob until a squeak is heard. At once stop oscillating and re-adjust tuning. If the signal is worth hearing you should by careful tuning, be able to get audible results *without* oscillating again. A slight increase of reaction must be compensated by a slight re-adjustment of the tuning knob. If the signal fades on withdrawing your hand from the tuning control, increase the setting just a little beyond the point at which signals are heard with the hand near the control.

# Improvements in LOW-FREQUENCY AMPLIFIERS

The Third Article by our Technical Editor on Forthcoming Developments

THERE are quite a number of developments in the low-frequency portion of receivers which are worthy of some comment. Some of these are in the direction of improving the methods already known, while others are novel in character and represent methods which have not been used to any extent previously.

The resistance-capacity coupler has altered little, the principal development being in reduction of size. Several very compact R.C. couplers are now on the market, these being generally made in two types, one to suit medium-resistance valves and the other to suit high-resistance types. The importance of making the coupling condenser of adequate size is duly appreciated by the majority of manufacturers, and the result is quite a satisfactory article.

Transformer design shows signs of undergoing marked changes. It has been realised for some time that, in order to obtain satisfactory reproduction, a high primary inductance is essential and, moreover, this must be maintained when there is an appreciable steady anode current flowing. In achieving this result it has been necessary to use large quantities of both copper and iron. In other words, a large winding has to

upon the differential permeability of the iron used, and if this is high, so that a small change in the magnetising force produces a very large change in the magnetic field,

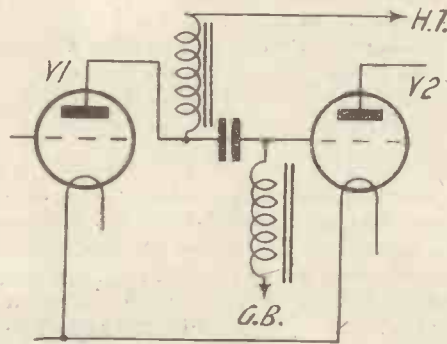

Fig. 1.—Circuit with Dual-impedance Coupling

then it is possible to obtain a high value of inductance with a comparatively small iron circuit and only a relatively small winding.

A number of transformers are available utilising special iron circuits of this description, as a result of which it is possible to obtain the necessary inductance of 40 to 50 henries, or even more, in a very compact space, resulting not only in a saving in bulk, but also in weight. This is a very promising line of development, and we can confidently look forward to an appreciable reduction in the size of low-frequency coupling arrangements generally as a result of the discovery.

### Dual-impedance Coupling

There also appear to have been developments during the past few months in other forms of coupling. Among the foremost of these developments is that of the dual-impedance coupler, a diagram of which is given in Fig. 1. It will be seen to be similar in character to a choke-coupled arrangement, but in place of the customary grid leak a second choke is employed. The anode and grid chokes are not coupled to each other. This type of coupler, indeed, made its appearance last season, but the good properties were not fully utilised.

The advantages of this arrangement are not immediately obvious. In fact, it appears and it has often been suggested, that the

two chokes are effectively in parallel and that the effective anode inductance is therefore considerably reduced, so that the response on the lower frequencies must of necessity be definitely poorer than with an ordinary choke-coupled arrangement. This, however, is quite fallacious, as will be seen shortly. The chokes are effectively in parallel only in the middle and upper frequencies where the effect of the coupling condenser is negligible. At such frequencies, however, the effective inductance of the two chokes in parallel is sufficiently high to give the full amplification from the valve, irrespective of the frequency.

On the lower frequencies, the reactance of the condenser becomes appreciable, and it is no longer correct to assume that the chokes are in parallel. In fact, what happens is an entirely different action. The current in the anode circuit of the first valve,  $V_1$ , develops voltages across the anode choke. These voltages are applied across the circuit consisting of the coupling condenser  $C$  and the grid choke in series, and if the values of the two components are correctly chosen it is possible to obtain a resonance effect. At the resonance point the voltage developed across the grid choke (which is the voltage actually applied to

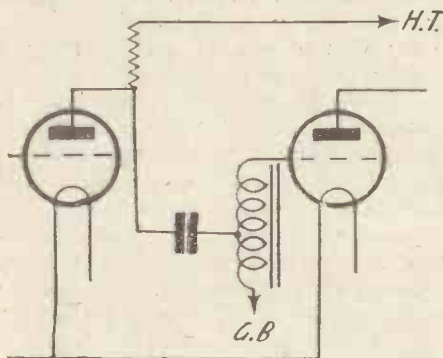

Fig. 2.—The Clough Arrangement

be employed with a generous iron circuit. The consequence has been a gradual increase in the size of low-frequency transformers.

Comparatively recently, however, it has been found possible to improve matters by utilising a much superior grade of iron. The inductance of the transformer depends

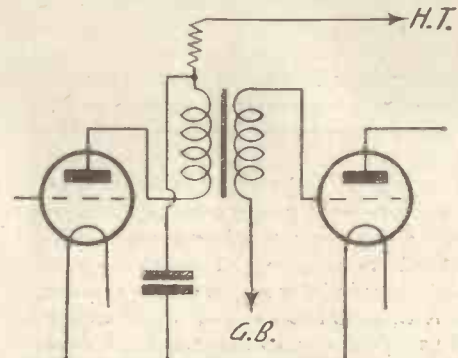

Fig. 3.—Diagram showing the use of Filters

the second valve) rises appreciably, and may even be greater than the ordinary voltage obtained from the preceding valve. In other words, instead of obtaining a falling-off in the amplification, we can obtain a rise or, if we choose to arrange the design suitably, we can maintain the

(Continued at foot of next page)

## For the Newcomer to Wireless: OHM'S LAW

I WONDER if you would mind telling me just what Ohm's Law is? I am always seeing it mentioned in articles.

Have you a pencil and a piece of paper on you? You have. Good. Now just draw a large capital "V," then a horizontal line under it and below that a capital "O" and a capital "A."

I have done that. Now what happens?

You know what volts, amperes, and ohms are?

I think so.

The volt is the electrical unit of pressure. If we return once more to our water analogy, then the volt represents the "head" or pressure of the water which issues from the tap.

And the ampere?

The ampere is the unit of the rate of flow. In water parlance it is equivalent to gallons per second. The ohm is the unit of resistance. We may regard it as roughly equivalent to the size of the opening in the tap.

I follow that. Volts drive electricity,

ohms impede its progress and amperes represent the amount which flows.

Just so, and each of these three factors depends upon one another. You can get the same amount of water from a little tap if the pressure is high as from a big one connected to a low-pressure supply. Similarly, if the pressure is the same in both cases the big tap will deliver more water than the little fellow.

In electricity the higher the voltage and the lower the resistance the greater the flow of current?

Yes; and if you know the values of any two of these you can always find the third in a moment.

How's that done?

Look at the very pretty little drawing that you have made. Let us suppose that we know that the voltage of a battery connected to a circuit is six and that the resistance in the circuit is two ohms. We know, that is to say, V and O and we want to find A. You have only to put your finger over the one that you want

to find and what is left of the diagram will show you how to do it.

I have covered up A and I am left with V and O.

Volts divided by ohms, eh?

Let's see. Six divided by two; that's three.

That is to say, the answer is three amperes. Take another example. The resistance is 22 ohms and the current .5 ampere. Find the voltage.

I cover up V, I suppose, and that leaves OA.

That means ohms multiplied by amperes.

Twenty-two multiplied by .5 is 11. That's the voltage I suppose?

Exactly. If we knew that 24 volts were driving 6 amperes through a circuit how could we find the resistance of the circuit?

Cover up O. That leaves V over A. Volts divided by amperes. Six into twenty-four goes four times. Answer, four ohms.

### "IMPROVEMENTS IN LOW-FREQUENCY AMPLIFIERS"

(Continued from preceding page)

amplification at a level figure.

I shall go into this matter in greater detail in a future article, where actual curves will be given to show the resonant effect occurring in the bass. With correct design, it is possible for the amplification to be maintained tolerably uniform (i.e., within 10 per cent. of the maximum value) over a range of frequencies extending from 40 to 10,000. As far as frequency response is concerned, therefore, there is no question as to the satisfactory operation of this form of coupling. It possesses the further advantage that it is less affected by the type of valve in the coupler than with other forms of low-frequency device.

These factors by themselves, however, would not recommend the dual-impedance coupler in preference to the comparatively simple resistance-coupled arrangement. It possesses several further important advantages, the first being that the amplification obtained from the valve is some 50 or 60 per cent. greater than would be obtainable with a resistance-coupling arrangement. A second advantage, of more particular usefulness in later stages of the receiver, is that there is little steady voltage drop on the anode choke, so that the valve receives its full anode voltage and can handle a larger grid swing. A third advantage, which appears somewhat nebulous, but can be definitely proved to exist, is that the dual-impedance form of coupling gives a more strictly proportional amplification on weak and strong signals than any other form of coupling device.

There are various developments of the

simple dual-impedance coupler just outlined. One such development utilises a step-up arrangement, either in the grid choke or in the anode choke, so that the amplification is increased over and above that given by the valve itself. A still further development, made with the idea of cheapening the production, is a resistance-coupled arrangement with an impedance leak. The anode circuit of the valve contains a simple resistance, while the grid circuit contains a choke instead of a grid leak; so making full use of the resonant effect in the bass, while saving the cost of the choke in the anode circuit. This latter system, particularly, can be combined with a step-up on the grid, as indicated in Fig. 2, this being an arrangement due to Clough, in America.

### Battery Eliminators

Turning now from actual coupling devices we come to a rather interesting development which should have a considerable vogue this season. The increasing use of battery eliminators has brought to the fore the parasitic oscillation often known as "motor-boating." This has been shown to be due to too high a resistance in the circuit of the eliminator or mains unit in use. Various methods have been adopted to overcome the trouble.

The investigations on this matter, however, have shown that this form of back-coupling is present in any receiver, whether it is battery-driven or mains-driven. The tendency of low-frequency amplifiers to squeal, particularly when the batteries are running down, has long been known; and it has often been thought that the trouble is due to interaction. It is now proved that battery resistance is the root of the evil and;

as was just remarked, this back-coupling is always present with a normally constituted circuit. It may not be sufficient in intensity to cause actual oscillation, in which case it will cause a strengthening of the signals or a reaction effect. This, however, gives rise to distortion, because the effect is different for different frequencies. On the other hand, the effect may be in the reverse direction and cause a definite weakening of the signal strength, which again is different at the various frequencies; so that it can be taken as an axiom that *distortion is always present with an ordinary amplifier.*

In order to overcome this, it is necessary to insert filters in the various stages of the receiver as indicated in Fig. 3. Instead of taking the H.T. terminal on the transformer or other coupling device directly to the H.T. battery, it is taken through a resistance. The junction point between the resistance and the transformer is shunted to L.T. with a large condenser. This device effectively overcomes all forms of back coupling, whether a battery or a mains unit is being employed.

Two interesting units have already made their appearance on the market, one manufactured by Messrs. R. I. and Varley and the other by Messrs. Wright and Weaire. These units contain a tapped resistance and a condenser. They can thus be inserted directly in the position indicated in Fig. 3 so obviating all troubles due to back-coupling.

Such a device as this can be added quite simply to an existing receiver or incorporated in making up a fresh one, and it will quite probably become a standard device in all low-frequency amplifiers.

# WITHOUT FEAR OR FAVOUR



## A Weekly Programme Criticism by Sydney A. Moseley

LATELY I have been listening to the poetry reading by male and female elocutionists. Pardon me, Ladies, but I must confess to preference for the men. The women somehow suggest a Sunday School treat. Poetry itself being sentimental it requires a suggestion of manliness to carry it over. I should like to know the name of the man who recited poems by Yeats and Southey. It made poetry reading sound quite tolerable. The line, 'And you will cut a stone for him?' was read with simple effect. Owing to oscillation, lately unhappily renewed, I could not catch the name either of the poem or of the author, and I confess that I have never heard the work before. I wonder how many listeners have?

When are we really going to have a full Sunday programme? I ask again, knowing full well that only by pegging away do we achieve things. The programme starts at 3.30. Too late, far too late. Let us have a Sunday programme to suit all tastes. It need not necessarily be Continental.

A cleverly written "number" is "Dirty Work." Uncle Andre in his farewell performance—really farewell this time—did well in including it in his programme.

"Any dirty work to-dye?"

Here we are, ready and willin'

To murder yer mother-in-law fer a shillin'."

Quite amusing, and goes with a swing. Who knows, the sentiment might even appeal to some men!

Was it Billie Barnes who was "particularly" announced as "specially" brought over from the Vaudeville to sing her enormous success, "To-morrow"? It turned out to be one more of those sickly sob-spasms delivered in that peculiarly earnest and sorrowful tone of voice which used to be associated with a cold. And another star of the evening, Beatrice Lilley "prior to going to America, etc. etc.," gave again that strange ditty—"Toot, the lawyer." No, Sir,—I am not taking on a wager it is "Toot" or that it is a lawyer. Lord knows what it is.

Mrs. Dugdale deputised for Mr. Vernon Bartlett in his, "The Way of the World" series, and did it well too, although she is

undoubtedly "quite reformed." She knew her subject and had no need to apologise or to suggest that Mr. Bartlett could tell us more of the technical side of the subject.

I am afraid Mr. Wilson Harris who deputised the previous week, was not quite so good and his attempts to be "light" fell somewhat flat.

In this connection I seem to sense that the instructions to speakers from the keen young men at Savoy Hill are to make these talks light. This led to the disaster of an ambitious writer on sports who imagined that lightness meant playing the buffoon. So he gave one talk—Heaven knows why they let him—and that was the end of him! One can talk brightly without being too brilliant or comic.

The listener gets into the habit of expecting all the Promenade Concerts to be popular. However, if he listened in the other evening he must now know that popularity is a wide term. Delius' First Dance Rhapsody, the Violoncello Concerto by Dittersdorf, and even Tchaikowsky's Fifth Symphony are not quite so easy to take in as Chopin, Wagner or Puccini. Still, there is nothing like a good mixture.

When Suzanne Bertin first came to the microphone I welcomed her as a singer of

exceptional accomplishment. Her singing at the Queen's Hall created quite a rhapsody among the audience. She gave us the Bell Song from *Lakme* (Delibes), and after the interval, two pretty little things by Schumann and Strauss. Such purity of tone and an excellent choice of songs, deserved the clamour she received. Harold Williams—well, he always goes down well—but lately his choice of songs has not been quite so popular as of yore.

By the way, in the violoncello solo by Arnold Trowell, the quick movement sounded rather a mix-up, and this is often the case in concertos. However, the slow movement made up for it.

I do hope the Roosters manage to make a hit as great as they did in their War reminiscences. They were a little better in their "Round London in the *Venture*," but I fear we shall never get quite the spontaneity and fun that we did in the War *Scena*. That is the worst of being too successful along a certain line.

That was an interesting talk by Mr. S. K. Ratcliffe on "Summer in America." The speeches were clear and although once more it was a lecture rather than a talk, it passed muster even on a Saturday night! I had some people just over from America in the room and they were sure thrilled.

Isn't "Cherry Ripe" out of season, over-ripe so to speak!

The Jersey City plant of the De Forest Radio Company, idle for some time due to reorganisation, has resumed operations.

Canada is as active as the United States in running down sources of radio interferences. Sixteen specially equipped "interference cars" are used for this purpose in the Dominion and are under the direction of Commander C. P. Edwards, head of the radio branch of the Department of Marine and Fisheries in Canada.

In the Royal train, which has recently been redecorated, Queen Mary has had a radio set installed so that she can enjoy London music to while away the tedium of the trip from Buckingham Palace to Balmoral Castle, in Scotland.

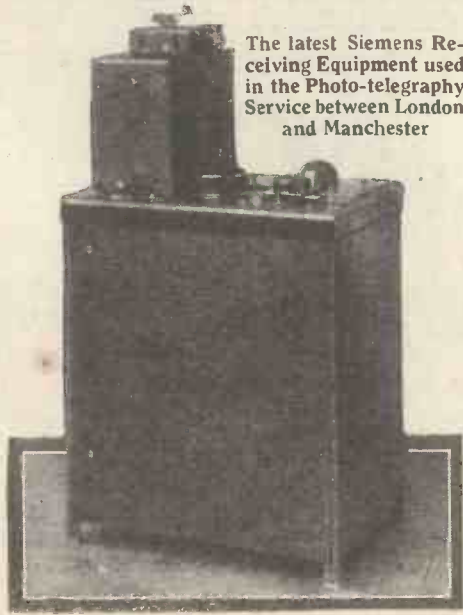

The latest Siemens Receiving Equipment used in the Photo-telegraphy Service between London and Manchester

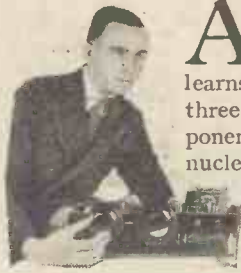

AS the "old hand" well knows, and the beginner soon learns, there are about three fundamental components that form the nucleus of nearly every simple wireless valve receiver. Whether we pin our faith to a detector and low-frequency amplifier type of circuit or whether we prefer a high-frequency, detector, and low-frequency amplifier arrangement makes little difference as far as these basic components are concerned. In either case, tuning coils, tuning condensers and high- or low-frequency coupling devices are the components that really matter.

With good quality examples of these components the beginner has a valuable nucleus around which, with such small sundries as fixed condensers and coils

gain valuable experience from its assembly and operation and then later, if desired, convert it to some other popular circuit. The layout and general design of this new receiver provide a simple means of trying out different circuits, without involving any great expense when alterations are made. This is due to the "skeleton" layout of the components, a system which makes for accessibility and is, therefore, particularly useful to experimenters.

The illustrations give a clear idea of the whole scheme. The tuning condensers and loud-speaker jacks are mounted on a strip of ebonite supported by stout angle-

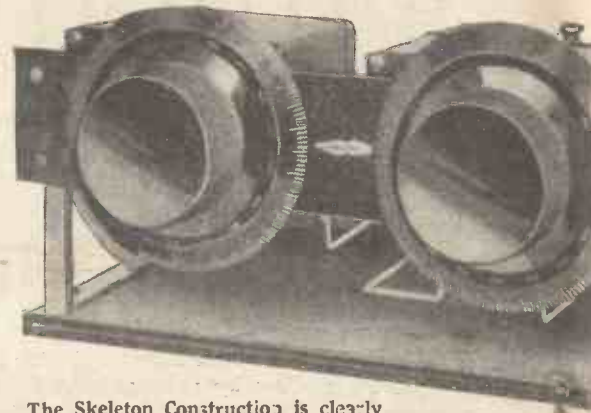

The Skeleton Construction is clearly shown in this photograph

# ADAPTAB

BY THE "A.W." TEAM

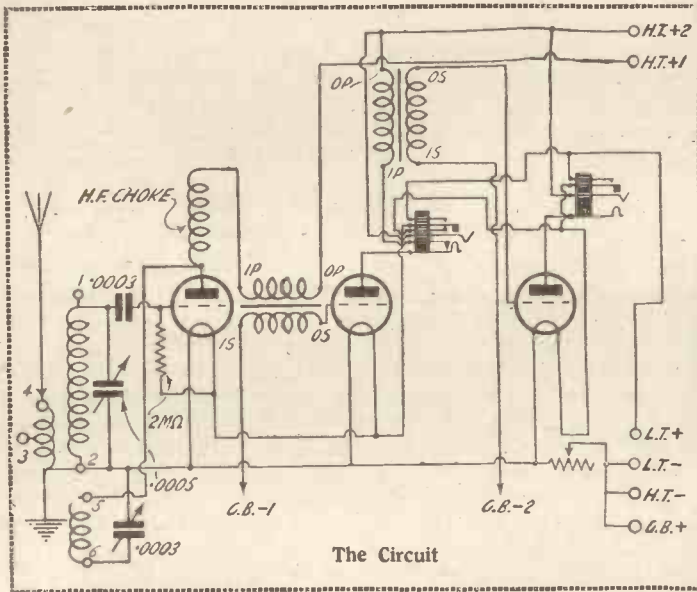

brackets fixed to a baseboard carrying the rest of the components. No panel or cabinet is required, so that the only material that might have to be scrapped in the event of an alteration would be the strip of ebonite and the baseboard. In the meantime, if the constructor decides to carry on with the original circuit, a full-size panel can be substituted for the present strip without upsetting the wiring.

### The Circuit

Before dealing with the constructional aspects, we will analyse the circuit arrangement and discuss its various points. Referring to the diagram it will be seen that three valves are arranged in the sequence of detector with reaction followed by two transformer-coupled low-frequency amplifiers. Such a combination, with good-quality parts, has much in its favour. Not only is the sensitivity quite good, but in addition the volume is, without exaggeration, tremendous. In fact, on nearby transmissions the low-frequency amplification from the last two valves is so great that a system of jack switching has been embodied so that when listening to strong signals the last valve can be out of circuit, and only two valves used. When, however, the volume from more distant stations is

and valve holders, he can build two or three entirely different types of receiver. Many newcomers to the experimental fraternity will be thinking of buying components for the coming season's activities and some will very likely be rather bewildered as to the most economical way of starting.

Readers in such a position cannot go far wrong if they acquire the "fundamentals" already referred to. Having done so they will want to know the most advantageous way of using them. Here is one way, to build the "Adaptable Three,"

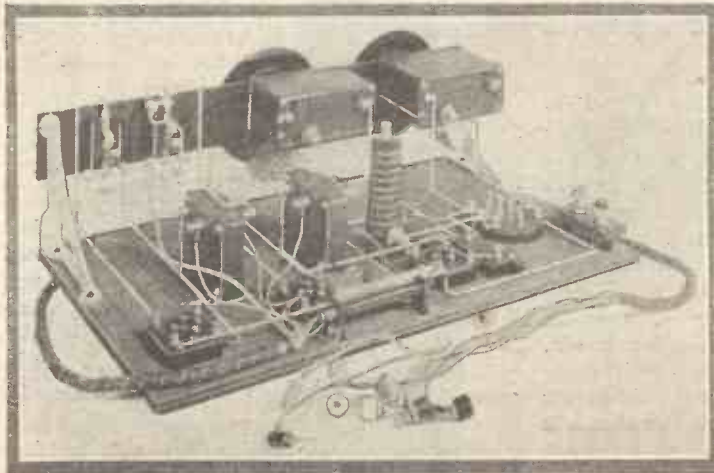

The Adaptable Three without Valves or Coils

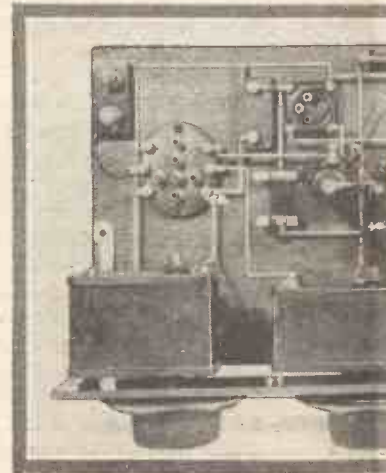

A Plan

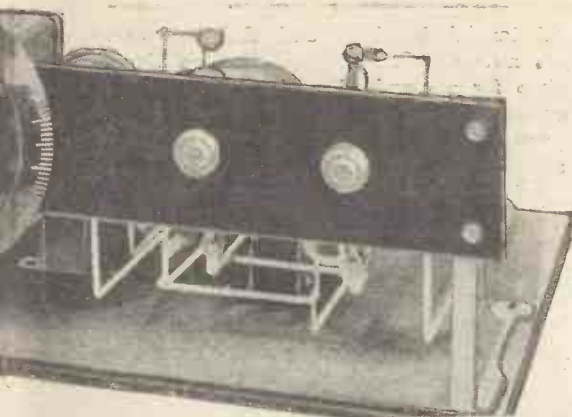

barrel of the plug itself. These two members, on insertion of the plug, make contact with (1) the jack connection going to the anode of the first low-frequency valve and (2) the jack connection going to the H.T.+2 terminal. Thus, the loud-speaker is connected directly in the anode circuit of the first low-frequency valve. But the insertion of the plug has broken a contact, that is the contact between the anode and the I.P. connection of the primary of the transformer, so that the transformer becomes inoperative.

plug automatically replaces the primary of the second transformer in the anode circuits of the second valve and at the same time cuts off the filament supply of all three valves.



Insertion of the loud-speaker plug in the more simple jack in the anode circuit of the third valve places the loud-speaker in circuit and completes the filament circuit of all three valves.

The advantage of this system of jacking is that when only two valves are used the third valve is cut out completely. Moreover, the filament circuits can only be completed by the insertion of the plug into one or other of the jacks, so that a separate L.T. switch is unnecessary.

A disadvantage is the necessity for changing the second valve for the third valve when only two valves are used.

At the same time another contact has been made, that is the contact between L.T.+ and

## LE THREE

### TECHNICAL STAFF

inadequate with two valves, the third valve can be brought into service by withdrawing the loud-speaker plug from one jack and inserting it in the other.

The two low-frequency valve connections are admittedly a little complicated by the inclusion of the jack switches, but we consider their convenience fully compensates for the extra trouble. To the beginner, the first jack, between the second and third valves may look just a little fearsome, but once its function is grasped it is quite simple.

The best way to explain its action is to see what happens when the loud-speaker plug to which is connected the loud-speaker winding is inserted into the jack. The plug, by the way, consists of two contact surfaces, one in the form of a small spherical tip at the end, and the other the

positive side of the filaments of the first two valves, whilst contact between the positive side of the third valve and L.T.+ has been broken. In effect, the insertion of the plug in this six-contact jack breaks the filament of the third valve and second low-frequency transformer circuit, and at the same time makes the circuits of the loud-speaker and filaments of the first two valves.

Withdrawal of the

### COMPONENTS REQUIRED

.0005-microfarad variable condenser (Burndept, J.B., Igranic, Lissen, Polar).

.0003-microfarad variable condenser (Burndept, J.B., Lissen, Igranic, Polar).

Two ebonite or bakelite strips, 16 in. by 2 in. and 2 in. by 1 in. (Raymond, Pertinax, Becol).

Double filament control jack (Lotus, Bowyer-Lowe, Igranic, Formo).

Single filament control jack (Lotus, Bowyer-Lowe, Igranic, Formo).

Three anti-microphonic valve holders (Bowyer-Lowe, Benjamin, W.B., Igranic).

Six-pin coil base (Tunewell, Lissen, Lewcos).

.0003-microfarad fixed condenser and grid leak holder (Lis-

sen, Dubilier, Graham-Farish, C.D.M.).

2-megohm grid leak (Lissen, Dubilier, Graham-Farish, C.D.M.).

High-frequency choke (Trix, R.I. and Varley, Burndept, Watmel).

Two low-frequency transformers (Marconiphone "Popular," Igranic, Lissen, Brownie).

Baseboard-mounting variable resistor, 6 ohms (Loriostat).

Two dial indicators (Bulgin).

Two terminals marked Aerial and Earth (Belling-Lec, Eclex, Igranic).

Connecting wire (Glazite).

Panel brackets (Magnum).

Baseboard 16 in. by 9 in. by 1/2 in. (Camco).

Eight-way battery cord (Lewcos).

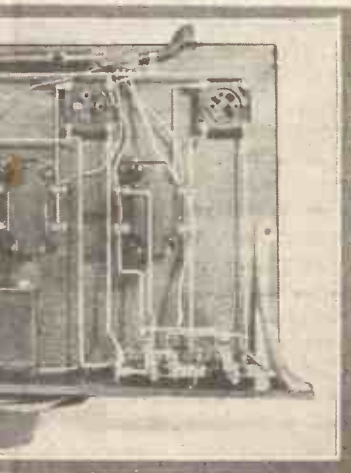

View

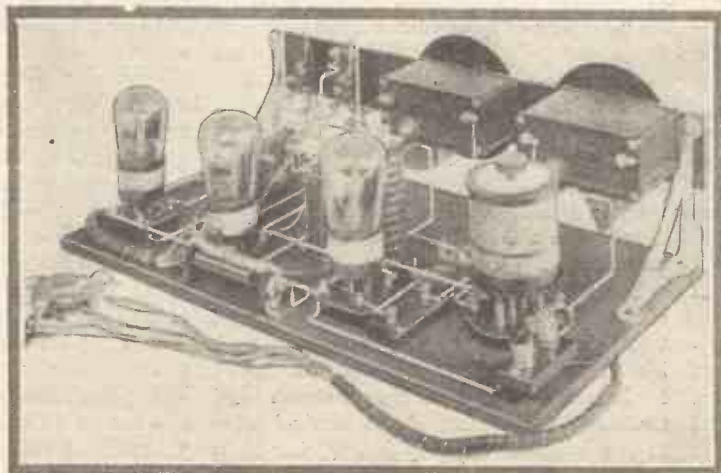

The Complete Receiver

Ordinarily the second valve is an L.F. type, whilst the third valve is a power type. When loud-speaker results on two valves are required the L.F. valve must, in the interests of quality and volume, be substituted for the power valve, which entails alteration of the G.B.—1 tapping. Even so, it must be conceded that the change over is not sufficiently frequent to make the process tedious, or incidentally to justify further elaborations in the switching to overcome the objection.

The elasticity of the low-frequency amplifying portion

## "THE ADAPTABLE THREE" (Continued)

of the receiver is reflected in the tuning and reaction system, which has universal applications. Here, it should be explained that by using a six-pin plug-in coil we can arrange aperiodic aerial tuning, consisting of a small untuned aerial coil tightly coupled to a tuned secondary coil, and efficient Reinartz reaction with separate reaction winding and earthed reaction condenser. True, we can do all this with ordinary plug-and-socket coils, but to change from one wavelength band to another it would be necessary to remove three separate coils and replace them with three more of different sizes. With a six-pin coil, however, the very short waves below 100 metres, the broadcast band and the long waves can all be covered

The corresponding types for the broadcast band and long waves are AM5 and AM20, giving wavelength ranges with a .0005-microfarad condenser of 250-550 metres and 1,000-2,000 metres respectively.

Each of the six pins on the coil is numbered to correspond with the theoretical circuit connections, as follows.

No. 1 to grid, No. 2 to L.T.—, No. 3 and No. 4 to aerial (alternatives giving variation in selectivity), No. 5 to anode, No. 6 to one side of reaction condenser.

The diagram shows how these coils are connected in circuit. The reaction condenser has its moving vanes connected to earth, a procedure that greatly minimises hand-capacity effects, specially noticeable

on short waves if this system is not adopted.

A .0003-microfarad grid condenser and 2-megohm grid leak give cumulative rectification, whilst a master rheostat in the low-tension minus lead controls the filament supply to all three valves. The on-off control is effected by the jack-switching.

Grid bias to each low-frequency amplifying valve, separate H.T. to the detector and common H.T. to the last two valves completes the specification after a careful study of which the reader will desire to know more about the constructional details.

substantial brackets and fixing screws and nuts are used. (The substitution of the strip for a standard 16 by 8 panel will convert the "skeleton" arrangement into a more orthodox affair that can be housed in a cabinet).

Of the "fundamentals" previously referred to, we still have left the coupling devices (in this case two transformers) and tuning coils, as well as the smaller parts, for disposal on the baseboard. From a back view of the receiver we have the three valve holders mounted in a line near the back of the baseboard, the two low-frequency transformers coming between them.

On the left is the six-pin coil holder, near it the grid condenser, grid leak in holder, and high-frequency choke. A small terminal strip mounted horizontally on two small "raisers" at the extreme right-hand end of the baseboard (still looking from the back) carries the aerial and earth terminals.

The single-way Loriostat (filament rheostat) is mounted longways behind the second valve holder. There is no battery-terminal strip, a neat substitute being an eight-way Lewcos battery cord.

The spade terminals usually clamped under the battery terminals are removed and the bare ends of the leads soldered to the components involved. The other end of the cord is provided with spade and wander plugs for the actual battery connections.

### Wiring

Wiring can be started as soon as the various parts have been screwed in position. Apart from the battery leads and a flexible lead from the aerial terminal to the spade tag giving alternative aerial connections, the wiring is carried out with shaped lengths of Glazite wire. The jack connections are provided with terminals for the constructor who wishes to avoid soldering where possible.

The receiver ends of the L.T.—, H.T.— and G.B.+ leads are soldered together and the single wire secured under the terminal of the Loriostat. The L.T.+ lead is soldered to one of the common jack connections, and the remaining leads, H.T.+1, H.T.+2 and G.B.—1 and G.B.—2 go to the corresponding transformer terminals.

In wiring, follow the blueprint order of connections; all those wires marked *a* should be joined together first, with one wire or as few wires as possible, then all those marked *b* and so on through the alphabet.

The final testing and operation of the receiver can then be proceeded with. Using the broadcast coil specified and one of the recommended combinations of valves (see valve table) the constructor will require a 120-volt H.T. battery of the medium-capacity type, a 2-volt accumulator, a 9- or 18-volt grid-bias battery,

(Continued on page 326)

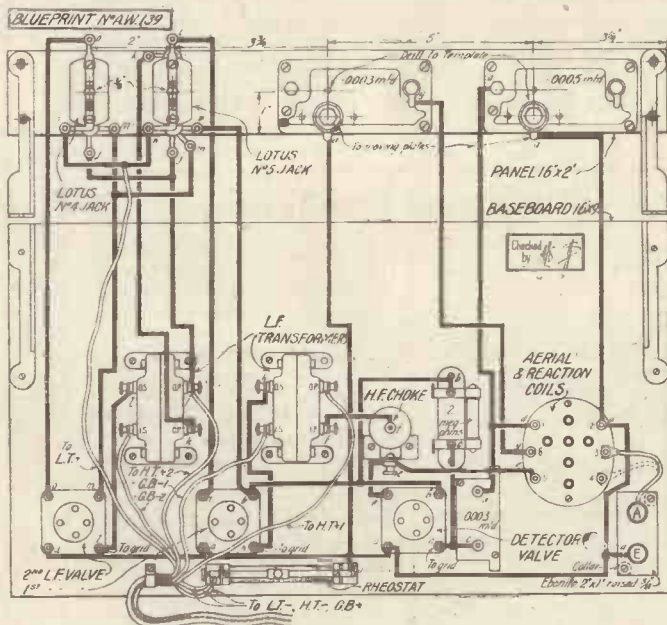

The Wiring Diagram. Blueprint available, price 1/-

with just three sizes and with a third of the trouble.

### Six-pin Coils

It is essential to order the types of six-pin coils specified, however, because in some varieties the aperiodic winding is a tapped portion of the main tuning coil, whilst the reaction coil is often a continuation of the tuning-coil instead of being an entirely separate coil. The coils recommended are the same as those used in the Mullard "Master Three." Two Lewcos short-wave coils are supplied by the London Electric Wire Company as follows:

AMS4, 20-45 metres with .00025-microfarad variable condenser, 20-75 metres with .0005-microfarad variable condenser. AMS9, 40-90 metres with .00025-microfarad variable condenser 40-130 metres with .0005-microfarad variable condenser. As we specify a .0005-microfarad tuning condenser the wavelengths covered by these two types will therefore be 20-130 metres.

### Constructional Details

As already mentioned, a "skeleton" layout has been adopted as can be seen from an examination of the reduced reproduction of the blueprint and of the various illustrations. The full-size blueprint is good value for money, giving as it does accurate details of the disposition of components and wiring. Price 1s. post free from Blueprint Dept., 58-61 Fetter Lane, this blueprint should be in every intending constructor's hands before the work is undertaken.

The long ebonite strip is drilled to take the tuning and reaction condensers and two jack switches; one large hole for each is required, and two small holes at each end for bracket fixing. With the condensers and switches in position and the vertical arms of the brackets securely bolted, the strip can be mounted on the baseboard by means of large wood screws passing through the horizontal arms of the brackets. Perfect rigidity is possible with this structure if



# LISSEN offer you an advance in two standard components

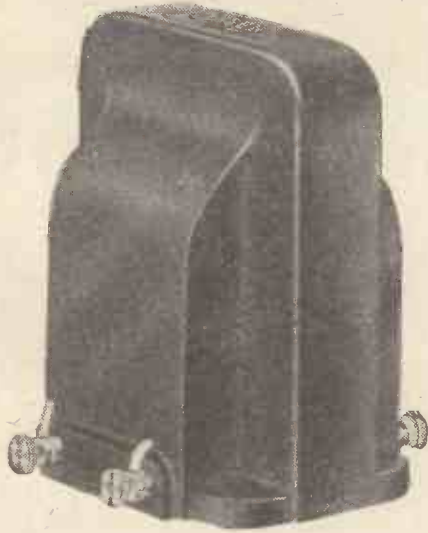

## LISSEN SUPER-TRANSFORMER

Lissen promised that if a better transformer than the famous Lissen 8/6 model could be obtained it would be added to the Lissen range.

And here it is—a transformer that gives crystal-clear reproduction of high notes and retains the deep sonority of the bass in a way that is startlingly true. A year ago this latest transformer could not have been made. It is incomparably better than any other transformer selling at any price at all. No transformer, however high in price, can even claim comparison with it unless that transformer has also been produced within the past few months.

For only now has the depth of radio technique yielded the knowledge which has made the latest Lissen Transformer possible. And in certain ways this latest Lissen Transformer will prove to have anticipated the advance experience of to-morrow. It represents value in high-priced transformers to the last degree. It represents a big saving in price to the transformer-buying public in comparison with every other high-priced transformer available.

PRICE **19/-** Ratio 3½ to 1.

## The long-awaited LISSEN VARIABLE CONDENSER

It has taken years for Lissen to make a condenser which at last satisfies every Lissen requirement, and at a price which is in keeping with the Lissen tradition for fine value. But now Lissen has produced a condenser which for fine and facile tuning, for low loss, for universal use, is surely without a rival.

You can use it as a standard condenser in any circuit.

You can gang it—two or three of them together.

You can use a drum control for it instead of a dial.

You can mount it on a panel, and it has feet for base-board mounting too.

One-hole fixing, of course.

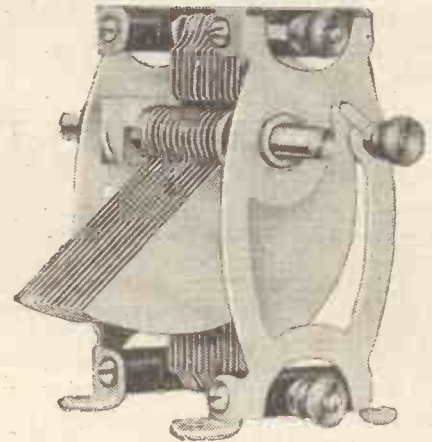

### LISSEN UNIVERSAL SLOW-MOTION DIAL

Made in Bakelite. An attractive slow-motion dial at a keen price. **3/6**

|        |               |     |     |     |
|--------|---------------|-----|-----|-----|
| .0001  | mfd. capacity | ... | ... | 5/9 |
| .0002  | "             | "   | ... | 5/9 |
| .0003  | "             | "   | ... | 6/- |
| .00035 | "             | "   | ... | 6/3 |
| .0005  | "             | "   | ... | 6/6 |

### 7 DAYS APPROVAL

You can get the new Lissen components from practically every radio dealer.

**LISSEN LIMITED, Friars Lane, Richmond, Surrey**

Managing Director: Thomas N. Cole

## "A.W." TESTS OF APPARATUS

Conducted by our Technical Editor, J. H. REYNER, B.Sc. (Hons.), A.M.I.E.E.

### Lamplugh Baseboard and Panel Units and Cabinet

We have received from S. A. Lamplugh, Ltd., of King's Road, Tysley, Birmingham, for report a panel tuner unit, a baseboard receiver unit and a cabinet which together make a complete receiver.

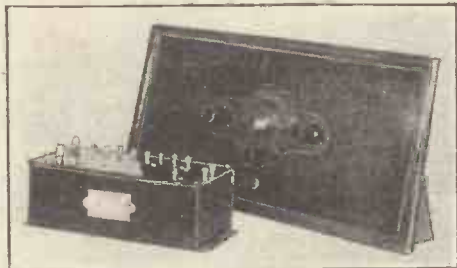

Lamplugh Baseboard and Panel Units

A report was given some time ago on the tuner, which is supplied with special ornamental panel fittings giving a very neat appearance. It has been further improved and the one we received was mounted on a dark-stained wood panel. The tuner consists of a tapped inductance with a reaction coil tuned by a slow-motion variable condenser. Part of the inductance can be short-circuited by a push-pull switch when it is desired to receive on the normal broadcast waveband, while with the full inductance in use, a long wavelength range is obtained. There is a push-pull switch for switching on and off the set.

The tuner was found to operate satisfactorily on both high- and low-wavelength ranges; the condenser action is smooth and pleasant to operate, and control is simple.

The baseboard unit consists of a detector valve followed by two transformer-coupled low-frequency stages. The components are mounted on a small insulated panel measuring 9 in. by 4 in. by 3 in. which rests on a metal case having a black crystalline finish.

The component parts are housed within the case except for a grid-leak holder; a row of eight battery-terminals are placed at the back of the panel, whilst the loud-speaker terminals are on the extreme right and the aerial and reaction terminals on the left, and three rigid valve holders are mounted almost flush with the panel. The unit is robustly constructed and the makers have sufficient confidence in their product to issue a twelve months' guarantee with it. It takes only a few moments to connect the unit to the tuner.

On test we obtained good results. The amplification is high, but at the same time, no noticeable distortion is present and reproduction from a good loud-speaker

appears to be reasonably uniform over a fairly wide band of audible frequencies.

The cabinet is strongly constructed of polished, dark-stained wood. It is collapsible and folds into a very small space. Full provision is made for battery leads, etc.

### W.A. and B.C. Volume Control

A VARIABLE high-resistance is always a useful component to have at hand and may be employed successfully for a number of purposes, particularly for controlling volume.

The volume control made by Wireless Apparatus and B.C. Co., Ltd., of 256 Narborough Road, Leicester, which we have received for test is a neat component designed for one-hole fixing on a panel. A rotating arm actuated by a black insulated knob makes friction contact with a length



W.A. and B.C. Volume Control

of resistance material which is housed in a neat and well-finished insulated case. A highly polished black insulated dial is supplied and this is fixed on the outside of the panel and is engraved with a circular arrow showing the direction for increasing the resistance.

Terminals mounted on the back of the case are connected to either side of the resistance element and a central terminal makes contact with the rotating arm; the component may therefore be used as a potentiometer if desired.

On test we found that the maximum resistance was approximately 380,000 ohms. The arm rotated over slightly more than 180 degrees and over half this movement the resistance dropped from 380,000 ohms to 100,000 ohms, whilst over the last half it dropped from 100,000 to 20,000 ohms, afterwards falling off suddenly to zero. When the component was connected across the primary or secondary of a low-frequency transformer, satisfactory control of volume was obtained and the adjustment was not over-critical. It can be recommended to readers.

### Cason Valve Holders

TWO new valve holders have recently been placed on the market by Cason

Mouldings, of Chiswick Road, Lower Edmonton, N.9, and samples of these have been submitted for test. Number 1 valve holder, which is priced at 1s. 6d., has a number of good features, including an effective manner of suspension which successfully preserves the valve holder from external shocks. The valve sockets are mounted on a thin circular insulated disc which is sufficiently flexible to bend slightly when a badly fitting valve is inserted. The electrodes in each socket comprise a coil of copper wire anchored at one end to a second insulating disc rigidly fixed to an outer insulated moulding. The wire coils in addition to forming a suitable contact for the valve disc, also spring the holder and have such a low natural vibration period that external shocks do not cause the valve electrodes to vibrate.

The copper wire springs are finally soldered to four tags connected to terminals on the outer moulding. Owing to the insulated covering on each socket, valves may be inserted without risk of contact with the wrong pins, whilst the metal form of socket, in addition to giving an excellent contact with the valve pins, allows the valve to be readily inserted and withdrawn. Precautions are taken to prevent excessive movement of the copper spring by suitable stops.

This is certainly a high-class holder which should give thoroughly reliable service.



Cason Valve Holder

The No. 2 valve holder has no spring device and is therefore suitable for use with amplifying valves. Terminals, shrouded sockets and soldering tags are also provided in this holder which is priced at 10d.

The Eiffel Tower transmitter is soon to become one of the most powerful stations in the world. Its wavelength, in accordance with the Washington agreement, will be 1,500 metres, and its power raised to 100 kilowatts. The most modern apparatus is being installed.

# OF INTEREST to all wireless users

**T**HE attention of all visitors to the National Radio Exhibition, which opens Saturday, September 22nd, at Olympia, is drawn to the striking exhibit which has been arranged on the Ediswan Stand. For example: everyone is familiar with the silvery coating inside the radio valve, but few have had an opportunity of seeing how it is produced. We are demonstrating this interesting operation at frequent intervals. A full range of the new EDISWAN Low Temperature valves will be seen by the public for the first time, which includes the following:

A.C. Mains Valves of special construction suitable for use in any type of Receiving Set.

Valves for all types of screen grid circuits.

Pentodes.

"Rectron" Rectifiers for use in Battery Charging and Battery Eliminating Devices.

Transmitting Valves capable of handling as high a power as 4 kilowatts as well as low power valves for amateur transmitters.

Constructors' models of the several new R.C. Threesome circuits and constructors' models incorporating the new Ediswan screen grid valves.

New ideas and designs in Components.

Complete range of Ediswan Accumulators and Dry Batteries including the newest types of the popular 100% British LOTEN Dry-Charged Accumulators.

## An Invitation

All the year round Ediswan is giving advice to constructors on the most suitable valves for various types of circuits. Bring your queries to the Ediswan Stand. The Company which made the FIRST Wireless Valve will give you advice really worth having, not only in regard to valves, but in all matters Wireless, and in the choice and maintenance of accumulators and batteries.

*A cordial welcome awaits you at the*

# EDISWAN STAND



**RULES.**—Please write distinctly and keep to the point. We reply promptly by post. Please give all necessary details. Ask one question at a time to ensure a prompt reply, and please put sketches, layouts, diagrams, etc., on separate sheets containing your name and address. See announcement below. Address Queries—AMATEUR WIRELESS Information Bureau, 58/61 Fetter Lane, London, E.C.4

#### Cossor Melody Maker

**Q.**—I have a Cossor Melody Maker receiver and wish to know if this will be suitable for the efficient operation of a moving-coil loud-speaker. If it is, then I would like to know of a suitable make or design of speaker.—A. H. L. (Liverpool).

**A.**—The receiver you mention is quite suitable for the operation of a moving-coil speaker provided that a super-power valve is used in the output stage of the set. This will entail applying as much as 200 volts or more H.T. to the anode of the last valve and adding grid-bias accordingly. For suitable design of moving-coil loud-speaker we would refer you to blueprint WM 58, a copy of which costs 1s. post free, from this office.—C. L.

#### "Hartley DX Three"

**Q.**—I have made up the above set and get very good results on the ordinary broadcast wavelengths. Not knowing the size of coils required for reception on the Daventry 5XX waveband, I have been unable to try my hand at receiving any of the long-wave stations. Can you assist me in this respect?—W. L. A. (Manchester).

**A.**—For the reception of long-wave stations such as Daventry 5XX, we advise the use of a No. 200 centre-tapped coil. Such a coil should enable you to get very satisfactory results on other long-wave stations also.—C. L.

#### "Town and Country Four"

**Q.**—I have built up the above receiver and find that although I can receive quite a number of stations each signal is accompanied by a high-

pitched whistle which I have been unable to eliminate. Can you suggest how this may be eliminated without reducing signal strength or reception efficiency?—P. B. (Barnes).

## When Asking Technical Queries

PLEASE write briefly and to the point

A Fee of One Shilling (postal order for preference) must accompany each question and also a stamped, addressed envelope and the coupon which will be found on the last page.

Rough sketches and circuit diagrams can be provided, but it will be necessary to charge a special fee (which will be quoted upon request) for detail layouts and designs.

Rough sketches and circuit diagrams can be provided, but it will be necessary to charge a special fee (which will be quoted upon request) for detail layouts and designs.

**A.**—Reversing the connections to the primary winding of the L.F. transformer has, in most cases, effected a cure of this trouble, but in a few cases the use of an entirely different valve for the detector or first L.F. position has also afforded a cure.—A. L.

#### Valves and Transformers.

**Q.**—I have recently been conducting tests with the new L.F. transformers now on the market. These include the Mullard, Igranic, Phillips, and Marconiphone. I notice that whereas with the older types of transformer everything appears to be quite satisfactory, with many, if not all, of the new transformers a high-pitched whistle or other form of oscillation makes itself apparent. Can you explain why this should be?—G. H. (London).

**A.**—We have experienced this trouble and by carefully choosing valves with impedances to match the impedance of the transformers we have effectively cured the tendency to howl. A temporary remedy is to use a somewhat lower H.T. voltage on the detector valve than would normally be used, but the remedy is to use a valve that matches the transformer as far as its impedance is concerned. This requirement is not new, but with the latest instruments the efficiency and sensitivity is so marked, that unless the amplifier is matched trouble will result.—A. C.

## "PIEZO PECULIARITIES" (Continued from page 302)

and filament in parallel with a choke coil  $c h$  and leak resistance  $R$ .

#### Crystal Control

The action of the crystal may be explained as follows. As soon as the plate circuit of the valve is closed, a surge of current flows through the plate inductance, and is impressed upon the crystal owing to the capacity coupling between the plate and grid electrodes inside the valve.

Under the influence of the applied voltage the crystal first contracts, and then, owing to its natural elasticity, immediately expands, so that it slightly over-shoots its original size. The latter effect is the same as if it had been subjected to a lateral squeeze, and the consequence is that a piezo voltage is developed and applied across the grid and filament of the valve.

This in turn affects the plate current, and so the process goes on, the grid being automatically impulsed at a frequency corresponding to the characteristic or inherent frequency of the crystal. The oscillations produced in the plate circuit of the valve therefore correspond exactly to the crystal frequency and can be used as a master control to stabilise the carrier-wave of a broadcasting station.

The grid circuit of Fig. 2 may also be

tuned as well as the plate circuit. The condenser  $c$  must be adjusted to approximately the known frequency of the crystal and then varied until the exact setting is found which throws the crystal voltage into correct phase and allows the oscillations to build up. Unless this is done the crystal may operate simply as a condenser and not as a piezo control device.

A crystal oscillator will maintain its natural frequency constant to within ten or twenty cycles when vibrating at a million cycles per second, even though slight variations are made in the high- and low-tension supplies to the valve circuits.

#### Selective Reception

Another application is shown in Fig. 3 in which a piezo-electric coupling is inserted between a high-frequency amplifier  $A$  and a detector valve  $D$  for the purpose of cutting out undesired frequencies and so securing highly selective reception. The crystal in this case acts as a filter to prevent any oscillations other than those it is desired to receive from passing on to the detector grid.

Under normal circumstances the selective action of the crystal might be too pronounced to give satisfactory results in telephony reception, because most of the side-band

frequencies which carry the signal modulation would be cut off. This can, however, be compensated by deliberately introducing a certain amount of frictional damping between the crystal and its supporting electrodes. This will broaden the selective action sufficiently to admit the side-bands, and will therefore give good-quality reception.

#### Luminous Crystals

Messrs. Gieve and Scheibe have recently discovered that piezo-electric crystals can be made to produce a luminous glow when set in vibration. A piece of quartz, eight centimetres long and a few millimetres in cross section, is placed between two electrodes so as to leave a very small air gap. The crystal is then subjected to an applied E.M.F. of the fundamental crystal frequency or a multiple thereof.

When the fundamental frequency is used the crystal radiates a distributed luminous effect. If a harmonic of the fundamental frequency is applied, stationary waves are set up, and the glow splits up into definite bands separated by dark zones. This effect has been used to give a convenient and visible indication of any accidental fluctuation in the carrier-wave frequency allotted to a particular broadcasting station.

Four of the Factors in the Success  
of this year's Radio Exhibition  
*4 of the new*  
**DUBILIER COMPONENTS**



DUBILIER FILTER UNITS  
Made in four types  
47/6, 72/6, 142/6 28/6.

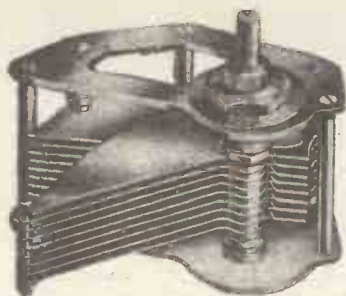

DUBILIER  
K.C. CONDENSER  
Without Knob, Dial or Slow-  
motion device  
.0003 or .0005, 8/-.

See them and  
the other new  
**Dubilier  
Products**

at

**STANDS  
102/103**



DUBILIER  
MIDGET CONDENSER  
Made in two capacities  
.0001 or .0002,  
complete with Knob 5/6.



DUBILIER H.F. CHOKE  
Finely moulded case protects  
windings and gives it  
a neat appearance. 4/6.

*Dubilier built is better built*

Adv. of Dubilier Condenser Co. (1925), Ltd., Ducon Works, Victoria Road, North Acton, W.3.

©177

Advertisers Appreciate Mention of "A.W." with Your Order

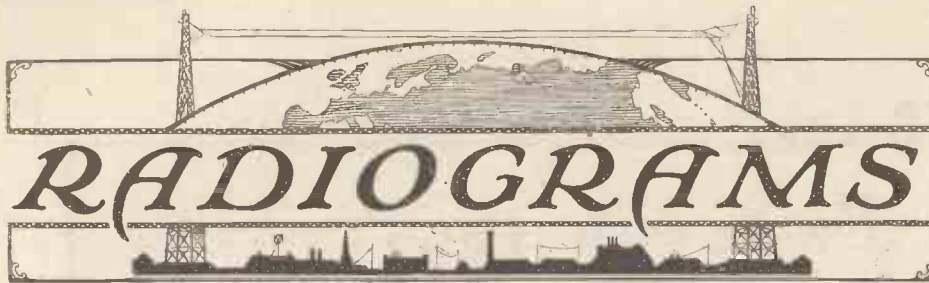

"OLD Wives' Tales" is the title of a series of talks, the first of which will be given by Miss Elsie Wright from Sheffield on September 14. These talks will deal mostly with local folk-lore and superstition.

Edith Penville will give a flute recital of French music from 2LO on September 17, including items by Rameau, Duvernoy, Saint-Saens, and Pessard.

The vaudeville programme to be given from the 5GB studio on September 17 will include the following artistes: Albert Daniels, in child impressions, Lawrence Baskcomb (comedian), Dorothy McBlain (*si ffeuse*), the "Two M's" (entertainers at the piano), and Will Evans and Nora Emerald in *The Lost Umbrella*.

An interesting talk entitled "Old Wessex Superstitions and Customs," will be given by C. F. Carr from the Bournemouth studio on September 18. Mr. Carr's talk will not only deal with present-day beliefs and habits of these people, but with those which have long since been forgotten.

On September 19, 2LO will broadcast a musical comedy entitled *The Great Dressing-gown Problem*, by Lance Sieveking. The music is by Scott Goddard.

Listeners will remember the popular "My Programme" series broadcast by the

London station some time ago. The Newcastle studio is to give a similar series, the first broadcast of which will take place on September 19, and will be arranged by the Countess of Tankerville.

A song-cycle for four voices, "A Branch of Arbutus," by Alicia Needham, will be relayed from the Birmingham studio by 5GB on September 22. The singers will be Emilie Waldron (soprano), Alice Vaughan (contralto), Geoffrey Dams (tenor), and James Howell (baritone).

The "Foundations of Music" series for the week, September 24 to 29 will be of Kriesler's violin works, and will be played by William Primrose.

Wireless classes (both sexes) will be given during the coming winter by Capt. Jack Frost at the following times and places: Mondays, Holloway Secondary School,

### NEXT WEEK: COMPLETE GUIDE TO THE EXHIBITION—OUR LARGEST ISSUE YET

Hilldrop Road, Camden Road, N.; Tuesdays, Tooting Bec Secondary School, Beechcroft Road, S.W.17; Wednesdays, Putney Secondary School, West Hill, S.W.18; Thursdays, Peckham Secondary School, Peckham Road, S.E.15; Fridays, John Woolman Institute, Islington, E.

All meetings begin at 7.30 p.m. The first meetings will be held during the week commencing September 24. Many practical demonstrations, besides visits to B.B.C. stations and studios, are being arranged.

An episode in one act entitled *The House Agent*, by Gerald Grace, is down for broadcast from 2LO on September 27. The variety concert to be given on the same evening will include the artistes: A. J. Alan, Derek Oldham, Winnie Melville, and the Gershom Parkington Quintet.

The London station on September 29 will relay a concert given by the band of the Royal Air Force, from the Wireless Exhibition at Olympia.

A debate on "Should Boys and Girls have the same Education?" given by Mr. R. F. Cholmeley and Miss L. M. Faithfull, will be broadcast from 2LO on Sept. 25.

A Liza Lehmann programme is to be broadcast from 2LO on September 27. The concert will include *The Golden Threshold*, an Indian song-cycle, of which the principals will be Kate Winter (soprano), Esther Coleman (contralto), Eric Greene (tenor), and Frank Philips (baritone). The wireless chorus and orchestra are to be conducted by Joseph Lewis, the well-known musical director of Birmingham.

2LO and 5XX will relay a popular programme from the Kingsway Hall on September 29. This concert includes many well-known artistes who have not been heard by London listeners for some time. They are Helena Maillais, Robert Pitt, and Langton Marks. The band of the Life Guards, conducted by Lieut. W. J. Gibson, will also take part in this entertainment.

Radio Toulouse (France) has abandoned its metronome interval signal for an automatic bell striking once every second.

## 2LO SHOCKS THE BUILDERS *(Exclusive to "A.W.")*

WORKMEN erecting a block of flats just off Oxford Street, in the vicinity of Orchard Street, had the shock of their lives recently. One day when the mortar-carrying bucket was being hauled up by the wire hawser fixed to the crane, a workman touched the bucket as it passed and received a nasty jolt in the form of a 200-volt shock. Similar experiences of other workmen naturally led to the conviction that in some mysterious way the bucket was acquiring a high electrical charge.

Fortunately, no serious accidents occurred. Investigations followed; it became apparent that the vertical wire suspension used to haul up the bucket was acting as a collector of energy, whose only path to earth was through the poor workmen, a fact which was learnt when it was

found that the shocks were only experienced when 2LO was transmitting. The big transmitting aerial on the top of Selfridges nearby at once came under suspicion and there is no doubt whatsoever now that the powerful field caused by 2LO's radiations was responsible.

Things got so bad that at one time the crane could not be used at all. Then the workmen were served out with thick rubber gloves, which were hardly a success, for the shocks continued and furthermore the workmen complained that the gloves were so thick that they could not handle the bucket!

In desperation engineers were then brought into the affair, with the result that between the bucket and the end of the wire hawser was inserted a block of lignum vitae, in order to insulate the bucket from

the charged wire. Even this was only partially successful until the scheme was elaborated by inserting two lignum vitae hoops between the block and the bucket.

Now, whenever the bucket is coming down a bell rings to warn those below, because although the series insulating arrangement works very well while the wire is taut, there is still a possibility of the slack wire coming into contact with the bucket and starting the trouble all over again.

The precautions insisted upon by the insurance company need not be taken as an indication that there is any danger to life in the vicinity of 2LO's transmitting aerial, but that the unexpectedness of an electric shock, however slight, might possibly cause an accident to a workman perched on a scaffolding, for example.

# Another Problem Solved

★ When you shut off for the night, just give, last thing, the necessary touch to a simple straight forward switch. That's all—but it will mean that all that night and all the next day - till you move that switch again — your batteries will be drawing from the house electricity main. They will be renewing themselves! All night — all the next morning—slowly and steadily—without haste but without rest—with perfect safety —at a rate specially adjusted to your set—costing you practically nothing after the first cost—your batteries will be absorbing electricity from the main. And when you listen-in again all the power you used last time will be renewed!

Install an Exide Trickle Charger and you will always have that pure, smooth wireless reception which only a battery can give, with none of the inconvenience of battery recharging.

And another thing! Your batteries by this method not only feed but they actually nourish themselves. The slow gradual dosage does them good and used batteries feeding themselves so, enter on a fresh lease of life.

That's the Exide Trickle Charger. Perhaps you are one who likes to know in technical terms the why and wherefore. If so, literature is at your service.

★ ★ ★

*Your dealer or Exide Service Agent will fit the Exide Trickle Charger and adjust it to your set.*

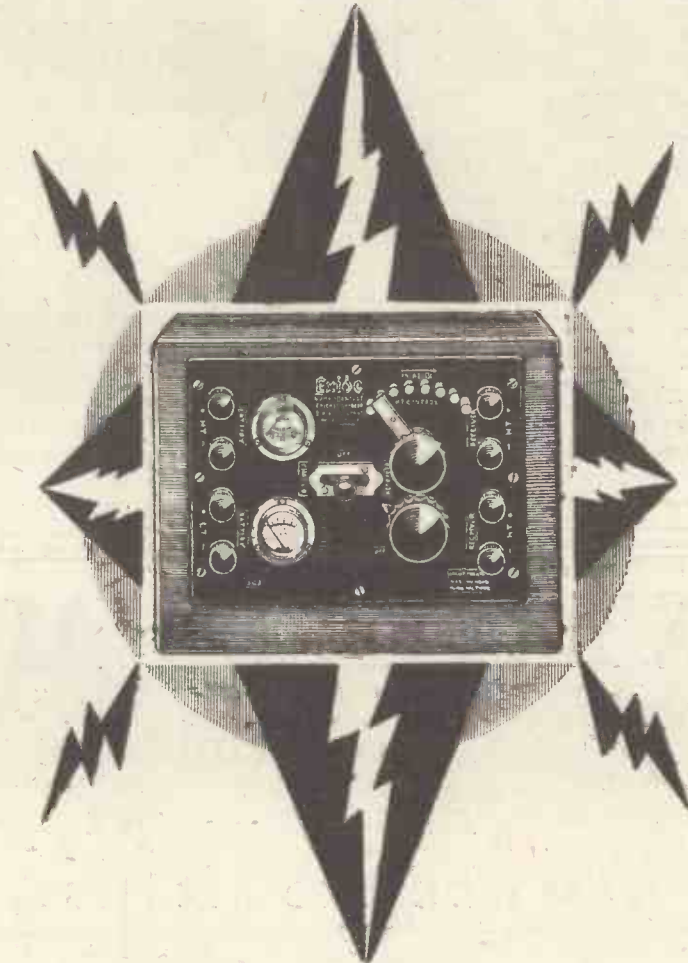

## Exide TRICKLE CHARGER

For A.C. Mains. For High Tension Batteries, for Low Tension and for both.

EXIDE BATTERIES, 219 SHAFTESBURY AVENUE, W.C.2

*You will Help Yourself and Help Us by Mentioning "A.W." to advertisers*

**"THE ADAPTABLE THREE"**

*(Continued from page 318)*

according to the type of power valve, and a loud-speaker. If a fairly short aerial is used, aerial tap No. 4 should be connected in circuit, whereas a long aerial should be attached to connection No. 3.

| <b>Valves For The "Adaptable" Three<br/>Recommended Two-volt Combinations</b> |         |           |                                                               |
|-------------------------------------------------------------------------------|---------|-----------|---------------------------------------------------------------|
| Make                                                                          | Det.    | 1st. L.F. | 2nd. L.F.                                                     |
| B.T.H.                                                                        | B210L   | B210L     | B215P                                                         |
| Cosmos                                                                        | SP16'G  | SP16'G    | SP18/RR                                                       |
| Cossor                                                                        | 210LF   | 210LF     | Stentor 2                                                     |
| Ediswan                                                                       | GP2     | GP2       | PV2                                                           |
| Marconi                                                                       | HL210   | DEL210    | DEP $\left\{ \begin{array}{l} 215 \\ 240 \end{array} \right.$ |
| Mullard                                                                       | PM1HF   | PM1LF     | PM $\left\{ \begin{array}{l} 2 \\ 252 \end{array} \right.$    |
| Osram                                                                         | HL210   | DEL210    | DEP $\left\{ \begin{array}{l} 215 \\ 240 \end{array} \right.$ |
| Six-Sixty                                                                     | SS210HF | SS210LF   | SS215P                                                        |

With the loud-speaker plug in the first jack, two-valve reception of the local station can be essayed. Set the reaction condenser at zero and slowly turn the dial of the tuning condenser until something is

heard. Increase reaction and compensate by a readjustment of the tuning.

If a more distant station is wanted, insert the loud-speaker plug in the other jack and listen with three valves, until a carrier wave is picked up, with the receiver just oscillating.

Stop oscillating—and to make sure of this turn the tuning condenser from side to side of the main tuning point, decreasing reaction until only a hiss is heard and not a "chirrup" as the tuning is altered.

Both wavelength ranges, above and below the broadcast band, can be explored to good advantage with the sizes of coils specified.

**VALVE ROYALTIES**

**Marconis to Appeal**

**I**N our report of the decision of the Comptroller-General of the Patents Office regarding reductions of valve royalties, we mentioned that it was open to Marconi's Wireless Telegraph Co., Ltd., to appeal to the Court of Appeal. This the company has now announced its intention of doing.

With a view to clarifying the position and assisting manufacturers of broadcast receiving apparatus, the Marconi Company wishes it to be known that, if the Comptroller's decision in the case of the Loewe Radio Company's application is affirmed, so that a licence is directed to be granted to the Loewe Company, other manufac-

turers who desire to manufacture the same apparatus as the Loewe Company (which apparatus is protected by a number of Loewe patents) will, so far as the Marconi Company's patents are concerned, be given licences, upon application to the Marconi Company, as from the date of such affirmation, on the same terms as those which the judge grants to the Loewe Company.

Similarly, if the Comptroller's decision in the Brownie case is affirmed, so that a licence is directed to be granted to the Brownie Company, it is the intention of the Marconi Company to grant to their existing licencees, on request, new licences, as from the date of such affirmation, on the same terms as those which the judge grants to the Brownie Wireless Company of Great Britain, Limited.

After the decision of the judge, no further appeal is permitted.

The Aberdeen station has run lines to the city's art gallery. These are not for television, however, but for the relaying of afternoon concerts from the Sculpture Court!

Dale Smith, the singer, who has returned home from a visit to the Continent, says his experience of German methods has far from diminished his admiration for our native vocal talent. Listeners will be interested to observe what effect his stay in Germany has had on his familiar voice.

**WIRELESS MAGAZINE**

for September, is selling out rapidly — get your copy before it is too late

*Some of the Contents*

An entirely new type of loud-speaker, with a linen diaphragm.—**THE ALADDIN THREE:** A special receiver for any type of screened-grid valve.—**THE FRAME-AERIAL FOUR:** Entirely self-contained receiver using a screened-grid high-frequency valve.—**THE POLE-TO-POLE SHORT-WAVER:** Successful reception of long-distance stations is assured with this new three-valver.—**HOW TO RUN YOUR SET FROM THE LIGHTING MAINS:** By J. H. Reyner, B.Sc., A.M.I.E.E.—**THE INVENTOR'S STORY OF THE NEUTRODYNE:** Exclusive article by L. A. Hazeltine.—**BROAD CASTING STILL AND MOVING PICTURES. GRAMO -RADIO SECTION ;** Reducing Your Record Wear, Etc. Etc.

*Full-size Blueprints of all sets mentioned above available at half-price.*

**Wireless Magazine is on sale at all Newsagents, etc., 1/-**



# Charge your own batteries

The Ediswan L.T. Battery Charger for A.C. Mains will deliver a charging current of 2 amps. and charges 2, 4 and 6 volt Accumulators of any capacity. It will work on supply mains of frequencies ranging from 40 to 100 cycles, and is suitable for all standard voltages.

Full instructions with each Charger.

Price, £2 17 6, complete with Valve and Barretter.

**Ediswan Rectifying Valves and Barretters for use in H.T. Eliminators and L.T. Battery Charging Devices.**

Rectifying Valve U.222 for use in high tension side of Eliminator.

Price 10/6.

Barretter for use with U.222, No. H.T. B.I.

Price 5/-.

Specification.

Fil. current at 2 volts, 2.2 amp.  
Max. anode volts, 125+125.

Output on Std. Eliminator up to 30 m.a.

Rectifying Valve U.235 for use in Battery Charger.

Price 10/6.

Barretter for use with U.235, No. B.U. 200.

Price 5/-.

Specification.

Fil. current at 2 volts, 3.5 amp.  
Max. anode volts, 30+30.

Output on Std. Charger, up to 2 amps.

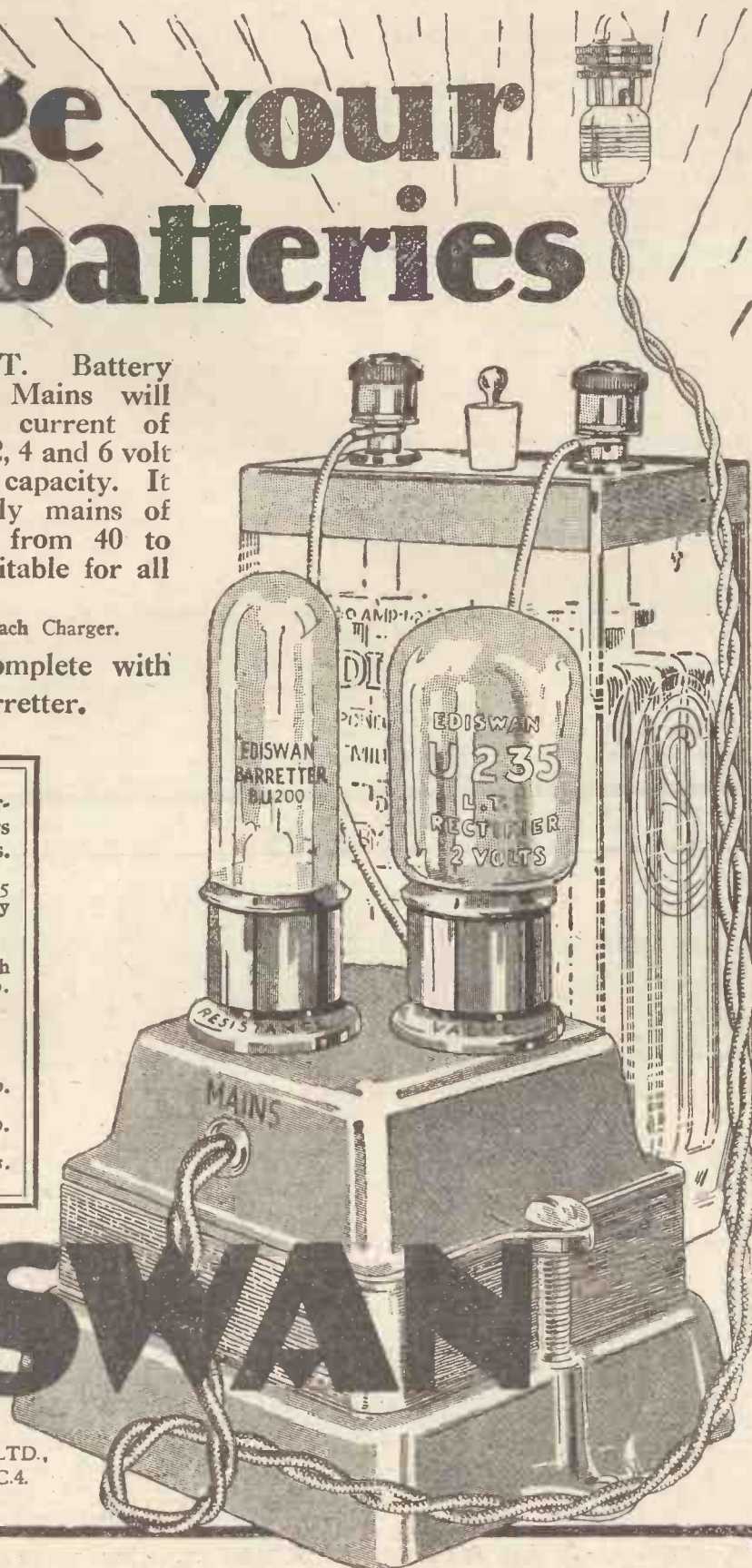

# EDISWAN

The EDISON SWAN ELECTRIC CO., LTD.,  
123/5, Queen Victoria Street, London, E.C.4.

Don't Forget to Say That You Saw it in "A.W."

“WHAT HAPPENS WHEN A SWITCH CLOSSES?” (Continued from page 311)

compared with passing from a rifle to a machine gun. Inasmuch as the intensity of the projectile rain in this connection was once more raised about one-thousandfold, it would at given moments reach such minute time intervals as one-thousand-millionths of a second.

An investigation of such minute fractions of a second was suggested by a process which, though occurring every day in an endless number of cases, has, despite many endeavours, never been fully understood, viz., the operation of an electric switch. Whenever the key of a telegraph or the switch of a radio receiver is pressed down, whenever an incandescent lamp or motor, or a high-tension power transmission line is switched in (as well as in connection with a lightning flash) there is a line of conductor which, suddenly, is made to carry some current intensity and tension.

The question now arises as to how each portion of the conductor is receiving its electric tension, whether this takes place abruptly and whether this abruptness means within a thousandth, a millionth or a thousand-millionth of a second.

This and many related problems, which so far puzzled the mind of scientists and engineers, have, thanks to Prof. Rogowski's investigations, found a most satisfactory solution.

Assuming a high-tension transmission line between Cologne and Berlin, i.e., between two places about 600 kilometres (about 360 miles) apart, to be open at both ends; to begin with, as long as this line is not applied to any source of high-tension, it does not show any peculiarity, all voltmeters reading zero.

This state of affairs, however, changes the very moment direct current at a tension of, say, 100,000 volts is applied to the line at the Cologne end. The line then assumes something special by “coming under tension,” all voltmeters now reading 100,000 volts.

While this is a familiar fact to everybody, only a few have ever pondered over the question as to what the distribution of tension will be, immediately after turning the switch.

Portions of the line in the immediate neighbourhood of Cologne will, of course, instantly assume a tension of 100,000 volts. However, providing that the interval of time be chosen small enough, there is no denying the fact that the tension at the Berlin end will still be zero, there being nothing to tell that switching has just taken place at Cologne. In fact, the only possibility left is that portions immediately adjacent to Cologne first come under tension, after which those next to them

follow suit, and so forth, until the far end of the line is reached. There is thus a “wave of charging current” passing along the line and causing it to come under tension by degrees.

This charging wave travels at an enormous rate of speed, viz., the velocity of light (300,000 kilometres = about 185,000 miles per second), the distance between the two places, viz., 600 kilometres, or about 360 miles, being traversed in about one-five-hundredth second. There will thus, only during this minute interval of time, be both charged and uncharged portions of the line.

If the line be not 600 kilometres, but only 1 kilometre long, the corresponding time interval will be only one-three-hundred-thousandth second, and if its length be further reduced to just one metre, a simple reflection will show that the corresponding time interval during which there is any distinction between charged and uncharged portions dwindles down to one-three-hundred-millionth of a second.

However, the very moment the charging wave arrives at the far end, it instantaneously rebounds from 100,000 volts to twice that figure, viz., 200,000 volts. The supply of charging current being discontinued, there is started a peculiar waving

(Continued on page 330)

BLUEPRINTS

Full-size blueprints are available of the following sets. Copies of the “Wireless Magazine” and of “Amateur Wireless” containing descriptions of all these sets can be obtained at 1s. 3d. and 4d. respectively, post free.

- CRYSTAL SETS. 6d. each, post free.**  
 “Best-yet” Set . . . . . AW114  
 Two-programme Set . . . . . WM25  
 Centre-tap Set . . . . . WM50

- ONE-VALVE SETS. 1s. each, post free.**  
 Loud-speaker Special . . . . . AW 73  
 Fan's Short-wave One . . . . . AW119  
 Super Reinartz One . . . . . AW127  
 Beginner's One-valver . . . . . AW140  
 Long-range Hartley . . . . . WM54  
 Reflexed One for the Loud-speaker . . . . . WM66

- TWO-VALVE SETS. 1s. each, post free.**  
 General-purpose 2 (D, Trans) . . . . . AW 55  
 Britain's Favourite (D, Trans) (Price 4d., with copy of “A.W.”) . . . . . AW 74  
 Ultra-and-Abroad 2 (D, Trans) . . . . . AW 77  
 Ultra-selective Hartley (D, Trans) . . . . . AW 90  
 Oceanic Short-wave (D, Trans) . . . . . AW 91  
 Trapped Reinartz (D, Trans) . . . . . AW 92  
 “Q” 2 (D, Trans) . . . . . AW 99  
 Long Distance Two (HF, D) . . . . . AW110  
 Three-waveband Two (D, Trans) . . . . . AW112  
 DX Headphone Two (HF, Det.) . . . . . AW134  
 Girdle Two (Price 1s. 3d., with copy of “W.M.”) . . . . . WM30  
 Mains-fed 2 (D, LF) . . . . . WM37  
 British Broadcast 2 (D, Trans) . . . . . WM44  
 Two-programme 2 (D, Trans) . . . . . WM56  
 Q-coil 2 (D, Trans) . . . . . WM62  
 Crusader (D, Trans) . . . . . WM69  
 Flat-dweller's 2 (HF, D) . . . . . WM76  
 Two Daventry Two (D, Trans) . . . . . WM97

- THREE-VALVE SETS. 1s. each, post free.**  
 Modern Tuned-anode (HF, D, Trans) . . . . . AW 35  
 All-from-the-Mains (D, 2LF) . . . . . AW 41  
 Economy 3 (D, 2RC) . . . . . AW 48  
 Short-wave (D, RC, Trans) . . . . . AW 50  
 Ether-searcher (D, RC, Trans) . . . . . AW 52  
 Britain's Favourite (D, RC, Trans) (Price 4d., with copy of “A.W.”) . . . . . AW 72  
 Broadcast 3 (D, RC, Trans) . . . . . AW 76  
 Q-coil 3 (D, RC, Trans) . . . . . AW 84  
 Clarion 3 (D, 2 Trans) . . . . . AW 88  
 Miniature Hartley Three (D, 2RC) . . . . . AW101

- Three-valve Mains receiver (HF, D, Trans) . . . . . AW109  
 Summer-time DX Three (HF, D, Trans) . . . . . AW106  
 British Station Three (HF, D, Trans) . . . . . AW122  
 Optional Two-three (D, 2LF) . . . . . AW124  
 “Simpler Wireless” Mains Three (D, 2LF) . . . . . AW126  
 Simplicity Screen-grid Three (HF, D, Trans) . . . . . AW132  
 “Proms” Three (D, 2RC) . . . . . AW137  
 Adaptable Three (D, 2 Trans.) . . . . . WM1  
 Continental (HF, D, RC) . . . . . WM 7  
 Screened-grid (HF, D, RC) . . . . . WM29  
 Five-guinea 5 (HF, D, Trans) . . . . . WM29  
 Dominions Short-waver (D, 2 Trans) . . . . . WM39  
 Screened-grid Short-waver (HF, D, Trans) . . . . . WM51  
 Metropolitan (D, 2LF) . . . . . WM48  
 Everyday (D, 2 Trans) . . . . . WM52  
 Music Chamer (D, RC, Trans) . . . . . WM60  
 Britannia (D, RC, Trans) . . . . . WM67  
 Home and Garden 3 (D, 2RC) . . . . . WM78  
 Pole-to-Pole Shortwaver (D, RC, Trans) . . . . . WM89  
 Glee-singer Three (D, 2RC) . . . . . WM92  
 Aladdin Three (HF, D, LF) . . . . . WM95

- FOUR-VALVE SETS. 1s. 6d. each, post free.**  
 Tuned-anode 3-4 (HF, D, 2 Trans) . . . . . AW 49  
 Near and Far Three-four (HF, D, RC, Trans) . . . . . AW113  
 “Pick-up” Three-four (D, 2 Dual Imp.) . . . . . AW118  
 Explorer Four (HF, D, RC, Trans) . . . . . AW120  
 Summertime Searcher (2HF, D, Trans) . . . . . AW128  
 Overseas Shortwaver (HF, D, 2 Trans) . . . . . AW133  
 Revelation (HF, D, RC, Trans) . . . . . WM29  
 Simplicity (HF, D, 2 Trans) . . . . . WM49  
 Station-finder (HF, D, 2RC) . . . . . WM68  
 Gramo-Radio 4 (D, RC, 2 Trans Push-pulled) . . . . . WM70  
 Q-coil 4 (HF, D, Trans, RC) . . . . . WM71  
 Screened-grid 4 (HF, D, 2RC) . . . . . WM77  
 Frame Aerial 4 (HF, D, 2RC) . . . . . WM85  
 All-from-the-Mains Four (HF, D, 2LF) . . . . . WM86  
 Five-pounder Four (HF, D, RC, Trans) . . . . . WM91

- FIVE-VALVE SETS. 1s. 6d. each, post free.**  
 Exhibition 5 (2HF, D, RC, Trans) . . . . . WM33  
 Phoenix (2HF, D, 2LF) . . . . . WM42  
 1928 Five (2HF, D, 2 Trans) . . . . . WM46  
 All-the-world 5 (2HF, D, 2RC) . . . . . WM63  
 Cataract 5 (HF, D, RC, Push-pull) . . . . . WM79

- SIX-VALVE SETS. 1s. 6d. each, post free.**  
 Short-wave Super-6 (Super-het, Trans) . . . . . AW 67

- Adaptor for above (See Misc. List) . . . . . AW67A  
 Nomad (2HF, D, RC, Push-Pull Trans) . . . . . WM11  
 Connoisseur's Six (2HF, D, RC, Push-pull) . . . . . WM88

- PORTABLE SETS.**  
 Easter 7 (Super-het, RC, Trans) . . . . . AW 89 1/6  
 Companion 5 (2HF, D, RC, Trans) . . . . . AW103 1/6  
 Daventry Loud-speaker Portable (2 HF, D, RC, Trans) . . . . . AW107 1/6  
 Town and Country (HF, D, RC, Trans) . . . . . AW111 1/6  
 House and Garden (screened-grid HF, D, RC, Trans) . . . . . AW116 1/6  
 Hand Portable (D) . . . . . AW125 1/-  
 “Best yet” Portable (Sc. Grid, D, 2 Trans) . . . . . AW136 1/6  
 Sunshine 5 (2HF, D, 2 Trans) . . . . . WM74 1/6  
 Chummy 4 (HF, D, RC, Trans) . . . . . WM80 1/6  
 Chummy 4 (with modification for L.S.&H.T.) . . . . . WM80a 1/6  
 Sidecar (2HF, D, RC, 3 Trans) . . . . . WM83 1/6  
 Pilgrim Portable (D, Trans) . . . . . WM94 1/-

- AMPLIFIERS. 1s. each, post free.**  
 Screened-grid HF Unit . . . . . AW 75  
 One-valve LF Unit . . . . . AW 79  
 Add-on HF Unit . . . . . AW 82  
 Super-power Push-pull . . . . . AW 86  
 Hook-on Short-waver (Amplifier) . . . . . AW104  
 Purity Amplifier (2 v.) . . . . . AW108  
 Add-on Distance-getter . . . . . AW117  
 Add-on Three . . . . . AW121  
 Screened-grid HF One . . . . . AW129  
 Screened-grid HF Amplifier . . . . . AW138  
 Range Extender (HF Unit) . . . . . WM38  
 True-tone Amplifier (3 valves) . . . . . WM47  
 Gramo-radio Amplifier (2 v.) . . . . . WM72

- MISCELLANEOUS. 1s. each, post free.**  
 Rectifier for “Simpler Wireless” Sets . . . . . AW 62  
 Adaptor for Short-wave Super-6 (6d.) . . . . . AW67A  
 H.T. from A.C. Mains . . . . . AW 73  
 “AW” Moving-coil Loud-speaker . . . . . AW 97  
 H.T. Eliminator for A.C. (200 v. output) . . . . . AW102  
 Moving-coil Output Unit . . . . . AW115  
 L.T. and H.T. Mains Unit (DC) . . . . . AW123  
 Anti-motorboating Unit . . . . . AW130  
 Knife-edge Wavetrap (6d.) . . . . . AW131  
 All-metal Eliminator for H.T. . . . . AW135  
 A.C. Battery Eliminator . . . . . WM41  
 Cone Loud-speaker . . . . . WM55  
 Moving-coil Loud-speaker . . . . . WM58  
 D.C. Battery Eliminator . . . . . WM59  
 Wavetrap . . . . . WM64  
 Universal Short-wave Adaptor . . . . . WM82  
 Linen Loud-speaker . . . . . WM90

Send, preferably, a Postal Order (stamps over sixpence in value unacceptable) to  
**BLUEPRINT SERVICE**

**AMATEUR WIRELESS**  
 58-61 FETTER LANE, LONDON, E.C.4

# A CONE SPEAKER OF EXCEPTIONAL MERIT

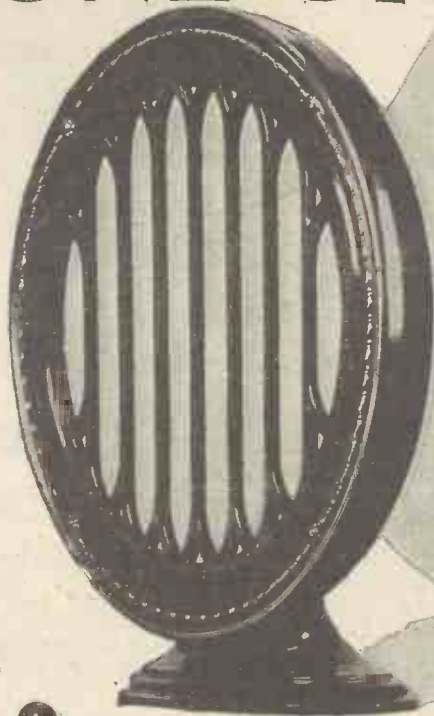

HERE is the cone loud speaker you have been looking for! Just think—for £3 you can have a cone speaker of exceptionally good tone, giving sufficient volume for a large room, and having the all-round quality, finish and appearance of an instrument costing two or three times as much.



PRICE

£3.0.0

## B.T.H.

# 504E CONE SPEAKER

The British Thomson-Houston Co., Ltd.

## Three Indispensable BURNDDEPT Accessories for Mains-operation



### 1. The BURNDDEPT "Ethopower"

For the cost of a penny per ten hours, the "Ethopower" will supply all the H.T. and L.T. current your set needs—even if it be an 8-valve set with super power valve! The "Ethopower" works from A.C. mains, and when set up, requires no attention whatever—and its filamentless

"Ethotron" rectifying valve rarely needs replacing. Can be used with any set in absolute safety, as it conforms to I.E.E. regulations. No noise—no distortion—no hum. Tappings provided to give correct H.T. voltages for detector, amplifier or screen-grid valves—grid bias automatically adjusting itself. Maximum H.T. 150 volts; total output 25 milliamperes. For A.C. Mains 100/240 volts, 40/100 cycles.

PRICE £6. 18. 3.  
(Marconi Royalty extra).

STANDS 112-113



### 3. BURNDDEPT AUTOMATIC CONTROL

This is an optional device which disconnects the Charger and connects the H.T. eliminator and vice versa when the set is switched on or off. PRICE: £1. 5. 0.

### 2. The BURNDDEPT L.T. Battery Charger

This charger will keep your L.T. Battery always fully charged for 2d. a week—working from A.C. mains. There are NO UPKEEP COSTS—NO ACID—NO VALVES—NO HUM. NO ATTENTION OF ANY KIND IS NEEDED, and the charger is PERFECTLY SAFE. Incorporates Westinghouse Metal Rectifier. The indicator-fuse lamp—a special feature, shows whether the battery is being properly charged, and also safeguards the transformer and metal rectifier against an overload. Universal type, for A.C. Mains, 100/110 or 200/240 volts, 40/100 cycles; charges 2- 4- 6-volt accumulators at half-ampere. Conforms to regulations of I.E.E. Sub-committee. PRICE: £2. 9. 6. NOTE: This charger may be used to excite the fields of 6-volt 5 ampere Magnavox and B.T.H. Rice-Kellogg Moving Coil Loud Speakers. The results are excellent.

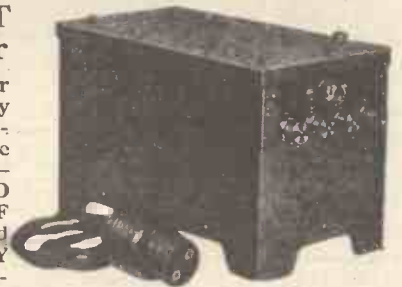

# BURNDDEPT

OFFICES:  
Blackheath, London, S.E.3

LONDON SHOWROOMS:  
15 Bedford St., Strand, W.C.2

RADIO EXHIBITION OLYMPIA

A.J.W.



**S**TEP by step the world-famous group of Celestion Loud-speakers has advanced through scientific development to a position of unquestioned supremacy. No greater human effort could have been made to perfect every detail of "Celestion" construction than has been made.

The famous Celestion group consists of four models, in oak or mahogany, as shown, with prices varying from the C.10 in oak at £5 10 0 to the C.24 in mahogany at £25.

Why not hear a demonstration without obligation at the new Celestion Showrooms, one minute from Victoria Station? Or ask your dealer to demonstrate. Celestion illustrated literature giving full particulars of all models and of the Celestion-Woodroffe Gramophone Pick-up, price £4 4 0, sent free on request.

VISIT US AT STANDS Nos. 19 & 20  
NATIONAL RADIO EXHIBITION  
OLYMPIA

Made under licence.

# CELESTION

The Very Soul of Music

Write to Dept. J,  
**THE CELESTION RADIO CO.,**  
LONDON RD., KINGSTON-ON-THAMES.

Tel: Kingston 5656 (4 lines),

Showrooms: 106, VICTORIA STREET, S.W.1.

## "WHAT HAPPENS WHEN A SWITCH CLOSSES?"

(Continued from page 328)

movement which, but for existing resistances, would be undamped. As it is, the wave is eventually damped by these resistances and a stationary condition is brought about, when the line, in accordance with the usual conception of the case, is permanently charged. The tension at the far end is particularly interesting, fluctuating between zero and double the amount of tension switched in, until the wave has become damped and the charging process comes to an end.

From an engineering point of view, this fact is of particular importance, showing as it does that insulators should stand at least twice the tension permanently carried by the line. This accounts for many cases of breakdown of the initial windings of transformers connected up to high-tension lines, and as all attempts to prevent such occurrences by choke coils, condensers and the like, have proved inadequate, it was rightly thought that an experimental investigation would alone settle the case.

Fig. 2 shows Prof. Rogowski's improved cathode oscillograph in actual operation at the Professor's laboratory.

Fig. 4 shows the wave produced on switching in a double conductor line 60 metres long, as it appears at the end of the line. The first rise from zero to 10,000 volts occurs in less than one-hundred millionth of a second, after which follows a horizontal stretch drawn in four ten-millionths of a second. The most delicate upper harmonics seen in this photographic record are, of course, missing in the theoretical diagram. The abrupt fall of tension then ensuing was recorded in about one-hundred millionth of a second. This phenomenon was eventually repeated. Scale of tensions: 26 mms. = 10,000 volts. Scale of time; 4 mms. = one-tenth millionth of a second.

Fig. 5 is the curve of tensions of a point-electrode spark gap at the end of a transmission line 60 metres long, the distance between points being 6 millimetres. On switching in there was thrown a first tension jerk across the spark gap, without puncturing it. During the second tension surge, puncturing occurred as the maximum tension was reached. In fact, the passage from the insulator to the conductor in this case should, according to a conservative estimate, have taken between one-hundred-millionth and one-thousand-millionth of a second. Initial scale of time: 4 mms. = one-tenth millionth of a second. Tension scale: 2.4 cms. = 10,000 volts.

Fig. 6 gives a striking idea of the puncturing of a sheet of mica .035 mm. thick. Tension in this case reached within about two-tenth millionths of a second a maximum of 10,000 volts, after which there occurred an instantaneous passage from the insulator to the conductor, which, according to a rough estimate, should be intermediary between

(Concluded on next page)



neat-  
accurate and  
inexpensive

Watch for Brownie's latest triumph in artistic moulded components — the "Dominion" Vernier Dial. Special non-back-lash slow motion drive gives very accurate turning, while the action will fit any condenser, and the new design of the dial will enhance the appearance of every set.

# BROWNIE

WIRELESS  
"DOMINION" VERNIER DIAL

THE BROWNIE WIRELESS Co., (G.B.) LTD.  
MORNINGTON CRESCENT, LONDON, N.W.1



The Benjamin Vibrolider is the most modern valve-holder obtainable. It ensures perfect contact with the valve-leg and protects the filament from every shock and vibration.

Use Vibroliders this season, they are simple to fix and simple to wire. Price 1/6

1,500,000 Benjamin valve-holders have already been sold. The original model is still retained. Price 2/-



**BENJAMIN**  
ELECTRIC Ltd., Brantwood Works, TOTTENHAM

**CHIEF EVENTS OF THE WEEK**

**LONDON AND DAVENTRY (5XX)**

- Sept. 17 Prom. Concert.
- " 18 *The Greater Power*, a thriller.
- " 19 *The Great Dressing-gown Tragedy*, a "waist-coat-pocket" musical comedy.
- " 21 A musical-comedy programme.

**DAVENTRY (5GB)**

- Sept. 17 Vaudeville programme.
- " 20 Summer Symphony Concert.
- " 21 Prom. Concert.

**CARDIFF**

- Sept. 20 A Concert by the Carmarvon Choral Society.
- " 22 *At Fiveways*, a sketch with songs and orchestra.

**MANCHESTER**

- Sept. 17 *On With the Show of 1928*.
- " 18 Prom. Concert.
- " 22 *Both Sides of the Microphone*, by L. du Garde Peach.

**NEWCASTLE**

- Sept. 19 "My Programme," by the Countess of Tankerville.
- " 21 Municipal orchestral programme from Whitby.

**GLASGOW**

- Sept. 18 Ladies' variety programme.
- " 19 Programme of the fighting songs of Scotland.

**ABERDEEN**

- Sept. 20 A special Irish programme, arranged and announced by John M. McQuitty.

**BELFAST**

- Sept. 18 A Shakespeare programme.
- " 22 *The Marchioness*, an operetta adapted from Charles Dickens, by B. W. Findon. Music by Edward Jones, arranged by Robert Chignell.

**"WHAT HAPPENS WHEN A SWITCH CLOSSES?"**

(Continued from preceding page)

one-hundred-millionth and one-thousand-millionth of a second. A rapid drop of tension then ensued.

Fig. 7 shows a damped condenser discharge as recorded with a sensitive incandescent cathode oscillograph. Scale of time: 1/2 mm. = one-millionth of a second. Scale of tensions: 1 mm. = 50 volts.

Fig. 8 is an oscillogram illustrating the fluctuations of tension of a spark gap with a flat tension rise. As soon as the spark gap has come into play the tension drops rapidly and dies out in beats.

The Japan Radio Broadcasting Association has decided to increase the power of the JOCK (Nagoya) broadcasting station from 1 to 10 kilowatts.

"Amateur Wireless and Electrics." Price Threepence. Published on Thursdays and bearing the date of Saturday immediately following. Post free to any part of the world: 3 months, 4s. 6d.; 6 months, 8s. 9d.; 12 months, 17s. 6d. Postal Orders, Post Office Orders, or Cheques should be made payable to "Bernard Jones Publications, Ltd."

General Correspondence is to be brief and written on one side of the paper only. All sketches and drawings to be on separate sheets. Contributions are always welcome, will be promptly considered, and if used will be paid for. Queries should be addressed to the Information Bureau and the conditions printed at the head of "Our Information Bureau" closely observed.

Communications should be addressed, according to their nature, to The Editor, The Advertisement Manager, or The Publisher, "Amateur Wireless," 58-61 Fetter Lane, London, E.C.4.

**No RADIO without DARIO**

**REDUCED PRICES**

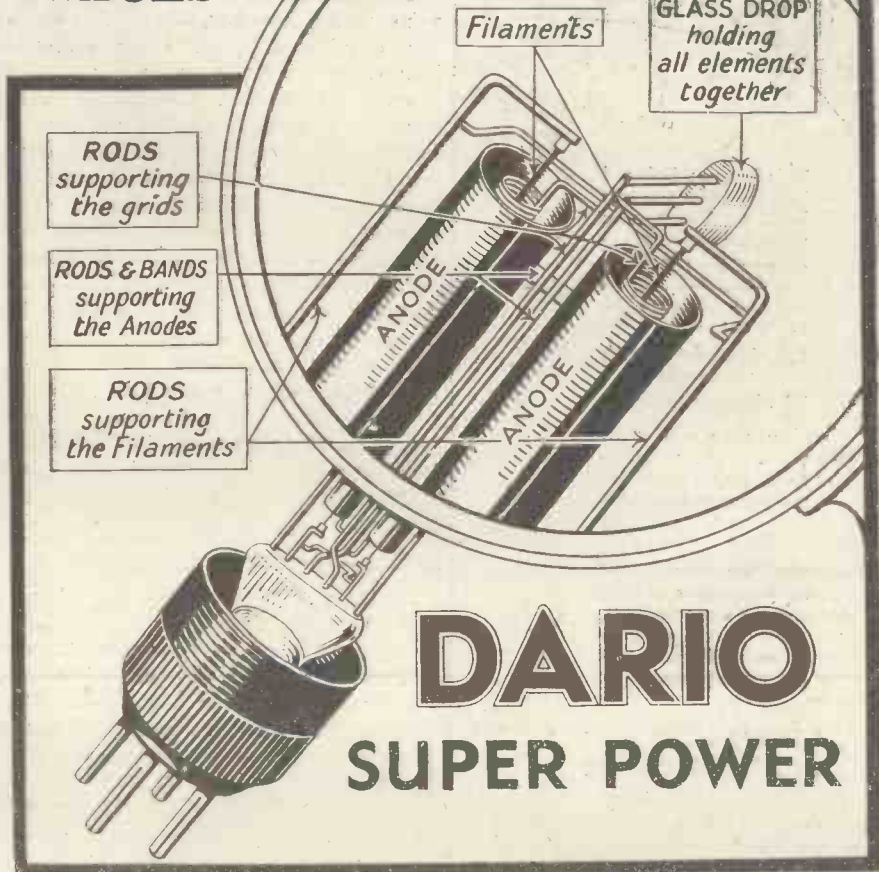

**DARIO SUPER POWER**

**DARIO VALVES**

(Latest Series of RADIO-MICRO) ARE Scientifically Constructed

| 2-VOLT                 |     | 4-VOLT              |     |
|------------------------|-----|---------------------|-----|
| Dario Micro Bivolt     | 5/6 | Dario Micro Special | 5/6 |
| .05 G.P.               |     | .05 G.P.            |     |
| Dario Resistron Bivolt | 5/6 | Dario Resistron     | 5/6 |
| .06 R.C.C.             |     | .07 R.C.C.          |     |
| Dario S. Power Bivolt  | 7/6 | Dario Super Power   | 7/6 |
| .18 L.S.               |     | .1 L.S.             |     |

The CHEAPEST to buy and to keep AND the BEST

Sold by all High-class Radio Dealers.

**IMPEX ELECTRICAL LTD.,**  
538 HIGH ROAD, LEYTONSTONE, E.11

Telegrams: Dariolect, Leystone, London

Telephone: Wanstead 2722

# Reduced in price

This is news indeed! The world-famous W.B. Anti-phonic valve holder, as specified by all the leading designers of the day, is reduced in price to:

1/6 Complete with terminals

1/3 without terminals.

Now why are W.B. valve holders chosen time after time for the premier circuits? Because they do definitely exclude microphonic noises.

Sprung on specially shaped springs, W.B. Anti-phonic valve holders ensure really pure reception.

COME AND SEE US AT  
OLYMPIA—STAND 120

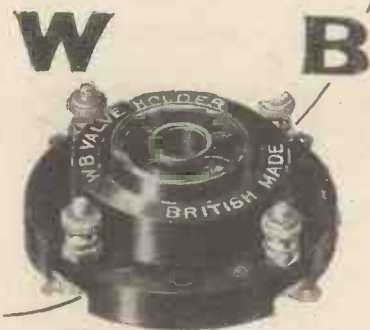

## ANTI-PHONIC VALVE HOLDER

WHITELEY, BONEHAM & CO.,  
LIMITED,  
Nottingham Road, MANSFIELD,  
Notts

### "WHAT THE EXHIBITION WILL REVEAL"

(Continued from page 305)

the same glass container. The first of these is designed to give a high  $\mu$  with a relatively low A.C. resistance, while the second has the characteristics of a power valve. These two valves are connected externally by some suitable coupling such as a resistance-coupling device.

The fact that there is so much new in the valve world, however, should not obscure the developments in other directions. References are made on page 313 to developments in L.F. transformer design, resulting in a much smaller size than has hitherto been found possible. New forms of coupling will be exhibited, notably the dual-impedance arrangement now becoming popular, while a device which should prove attractive to many, is the Formo two-stage unit. This contains a special form of resistance-coupling, having a choke leak instead of the usual resistance leak, together with a 3-1 transformer. These are all housed in the same moulding, the connections being brought out to eight terminals which are taken to the necessary two valve holders so that the two stages of amplification are included within the same housing.

#### A Loud-speaker Development

On the subject of low-frequency development, attention should be given to the new Amplion "Hush-Hush" speaker. This is a loud-speaker which is claimed to give greater discrimination between loud and soft tones. We have not yet had an opportunity of inspecting this, but it is sure to arouse no little interest.

Messrs. R. I. and Varley will have a complete range of low-frequency apparatus and mains supply units in addition to their usual products. Their new season's goods are housed in a different and distinctive form of shrouding which has a very pleasing appearance and should prove attractive to many users.

Mains units will be present in force, both as manufacturers units and in the shape of components for the home constructor. The requirements in a mains unit are becoming more and more appreciated; and there are numerous smoothing chokes on the market capable of handling the current required without saturation. In this respect some chokes exhibited by Messrs. Wright and Weaire will be of interest, these utilising a special iron for the core which gives much greater freedom from saturation than with the ordinary iron customarily employed.

#### A.C. Rectifiers

There are several new types of rectifying valve giving larger output and higher anode voltages than previously, while a class of component which is sure to be of great interest is the new metal rectifier. The utility of this type of rectifier is becoming appreciated and there are models now

available from small grid-bias units up to units delivering 200 milliamps at 200 to 400 volts, and on the low-tension side, units delivering 1 ampere rectified current at 9 volts.

Condensers for high voltages will be exhibited by the principal manufacturers as before; the trend of developments is to make the condensers somewhat smaller in size by the use of better quality material, but it should be noted particularly here that there is a most definite limit beyond which reduction in size cannot be carried. It must not be thought, therefore, that because a condenser is a little more bulky than some of its competitors, that it is necessarily an inferior or less well-designed article. It may be that the particular manufacturer prefers to rate his condensers more conservatively.

#### Electrolytic Condensers

An interesting feature will be the new electrolytic condensers which are being marketed by one or two firms. These condensers are obtained by forming a very thin film of gas on the surface of metallic plates. This gas is the insulating dielectric which is of such extreme thinness that the resultant capacity is enormously high. It is possible, by this means, to obtain, within a comparatively small size, capacities as high as 1,500 or 2,000 microfarad (i.e. the equivalent of 1,000 ordinary 2-microfarad condensers joined in parallel). Such condensers are used for low-tension work and are, therefore, only made to stand a voltage of about 12 volts. This is in order to obtain the high capacity, for it is a peculiar property of these condensers that the higher the voltage which they are designed to carry, the less is the capacity for a certain size of plate.

Turning to the high-frequency side of receivers, the principal development here is the "Q" coil. These coils are already well-known to readers and they will be exhibited by a number of manufacturers, some of whom are introducing them for the first time. The usefulness of these coils is being increased by the introduction of new types, in addition to those already existing. Thus there will be the standard aerial coil, the split-primary transformer, and two types of Reinartz coil. Since, in every one of these coils, the operation of changing from long to short waves is accomplished merely by the simple series-parallel switch on the secondary, their use is simple in the extreme. They need only be connected up as ordinary six-pin coils and they cover both wave bands without any changing.

#### Short-wave Receivers

Short-wave reception is also a matter of considerable importance at the present time as there are now quite a number of stations transmitting on the very short wavelengths. Apparatus enabling short-wave reception to be accomplished with the minimum of difficulty will be found in numerous

(Continued at foot of page 334)

**[The MOVEMENT is the part that really matters]**



The "Movement" is the part that really matters—if it's good, then you can be pretty sure of the best results.

The Goodman P.G.3 is a Double Acting Reed Unit—four pole, adjustable, ultra sensitive, yet handles huge volume and gives remarkably pure and undistorted reproduction.

Price complete 27/6

Come and see our latest range of Moving Coil Speaker Parts at the National Radio Exhibition.

STAND 269A, Olympia, Sept. 22-29

**GOODMANS**  
27 FARRINGDON ST. LONDON E.C.4

Telephone: City 4472

Cut down self-capacity and you increase range, power and selectivity. The

**"GODWINEX"**

Non-microphonic

**VALVE HOLDER**

is designed for lowest possible self-capacity.

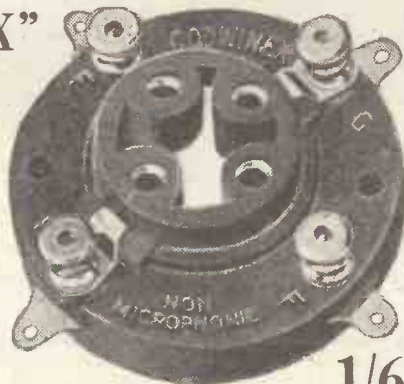

1/6  
EACH

More and more attention is being paid to the elimination of undesirable self-capacity in every radio component, and experts are discovering that the "Godwinex" Valve Holder has inestimable advantages. The secret is in the absolute minimum of di-electric between the sockets.

The "Godwinex" Valve Holder is also definitely anti-microphonic, the body being mounted on nickelled phosphor-bronze springs which are soldered to the sockets.

Strong stops to prevent distortion of springs when withdrawing valve, sunk sockets to prevent shorting of valve, soldering tags in one piece with springs, these are a few of the numerous advantages. Then look at the low price.

Send a P.C. for illustrated leaflet of this and other radio goods.

At  
**STAND No. 1**  
National Radio Exhibition,  
Olympia,

you may see this and other "Godwinex" and "Airmax" components and accessories—for better radio. Number one is easy to remember, easy to find, and valuable to visit. Make it your rendezvous.

**J. DYSON & Co. LTD.**

Bradford: 5 & 7 GODWIN ST. London: 2 COLEMAN ST., E.C.2. Hull: 38 BEVERLEY RD.

**Wonderfully Efficient Igranic Components for 1929**

THE new Igranic components excel even Igranic's previous standards. Look at these few examples—a new transformer giving even amplification between 100 and 9,000 cycles for only 17/6—an entirely new form of intervalve coupling giving hitherto unobtainable constancy of amplification—a high value variable resistance that is the most efficient volume control ever invented and a screened condenser specially made for reaction that eliminates hand capacity effects. Replace your old components with these and you will be surprised by the vastly improved results you will get.

The new Igranic catalogue, List No. D.101, gives full particulars.

Send for a copy to-day!

WE ARE EXHIBITING AT

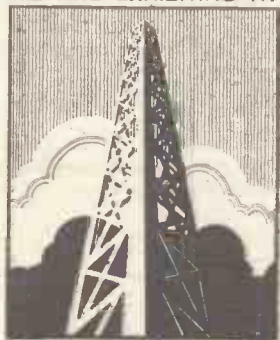

SEPT. 22-29  
**THE NATIONAL RADIO EXHIBITION OLYMPIA**  
ILLUSTRATION DANCING  
AMERICAN DAILY

Stands 53, 54 & 75

While at Olympia  
Come and hear Igranic apparatus demonstrated at  
28 West Kensington Gardens  
(Adjoining Olympia)



Igranic Dual Resistance-Capacity Coupling Unit.  
Price 17.6



Igranic Wire Wound Variable Resistance  
50,000 ohms, Price 15/-  
250,000 ohms, Price 17/6



Igranic Dual Impedance Capacity Unit.  
Price 30/-



Igranic Vernier Drum Control  
Price 17/6



149, Queen Victoria Street,  
LONDON, E.C.4  
Works: BEDFORD

Branches: Manchester, Birmingham, Cardiff, Leeds, Bristol, Newcastle, Glasgow.





## LETTERS TO THE EDITOR

The Editor does not necessarily agree with the views expressed by correspondents.

### Loewe Multiple Valves and Sets

SIR,—It gives us much pleasure to refer to the decision of the Comptroller-General of Patents in connection with our application for compulsory licences under certain patents held by Marconi's Wireless Telegraph Co. and the British Thomson-Houston Co.

The terms now having been fixed by the Comptroller it is anticipated that there will now be no obstacle in the way of our commencing manufacture of these valves and sets at our factory in Tottenham.

It will, of course, be realised that some little time must elapse before we can obtain and train the necessary staff and labour.

THE LOEWE RADIO CO., LTD.

(The decision referred to above is to be the subject of an appeal, as mentioned on page 318 of this issue.—Ed.)

### Mr. Moseley's Critics

SIR,—Had I had the pleasure of providing titles for letters from correspondents in your issue of July 21, I am afraid I would have headed the first letter "Sour Grapes," that is, of course, judging by the very unnecessary remark regarding "fees."

Your correspondent A. M. is evidently still in the youthful years of comic papers and limerick competitions, but it is to be hoped that he will eventually grow out of that evil stage and in time will be taught that there are many other subjects in life, in literature, and in music which he perhaps may become competent to judge.

Possibly you will offer the columns in question to A.M. when Mr. Sydney Moseley retires, but I sincerely trust that many years will elapse before such a calamity occurs.

Most people I have discussed B.B.C. programmes with, in various parts of the world, and those who also read the weekly criticisms in "A.W.," hold the same opinion

as I do, that "Sydney speaks for the multitude." P. F. (London).

### Cinder-track Racing

SIR,—I do not think Thermion's note in a recent issue, *re* Cinder Track Race quite fair.

Owing to the late arrival of some competitors, as well as several spills, the timetable could not be kept. It was not possible in the microphone hut to know what was happening in the control room. Owing to the flood lights, the commentator could not see the competitors until they were passing his hut at sixty to seventy miles an hour, and owing to the speed and dust raised, they could only be seen but indifferently.

I always read his page with pleasure, but give the poor man a chance!

G. P. (Bexhill).

### Cone v. Horn

SIR,—W. J. F. puts forward an interesting point in your issue of September 1, in that the bass notes of a cone loud-speaker are sometimes due to the natural vibration of the diaphragm. In an effort to secure more pleasing reproduction than is afforded by either a cone or a horn used alone, I combine the two, and by switches am enabled to use them in series or parallel, or separately.

By this method I am enabled to obtain a clarity and naturalness of reproduction which I have never achieved on one loud-speaker.

In my own case, I use a 10-inch Sferavox cone and a 5-ft. exponential wooden horn, working with an Amplion unit. The cone delivers music better than speech and the horn vice versa, so with the two working together, I obtain a pleasant and natural blending which cannot be heard with either speaker alone.

H. G. (Brighton).

### Equal to a Moving-coil

SIR,—Regarding the letter from W. J. F. (Redruth) on the merits of cone and horn type loud-speakers.

I have experimented with both types and have never been quite satisfied with either. I am now using an Amplion horn and a

Maguavox cone joined in parallel. The result is excellent and I am quite sure it can only be beaten by a moving-coil, which, of course, requires a more powerful set and is much more costly to run.

R. A. (Leeds).

### Fifty Stations on the Loud-speaker

SIR,—It might interest you to know that I have just completed the "Add-on Distance Getter" which was so well explained in AMATEUR WIRELESS of June 30. Although suffering from atmospheric the results are surprising. In combination with a three-valve receiver (2 L.F. transformer-coupled), I can receive forty or

(Continued on next page)

## REVISED PRICES. FIT TUNEWELLS

We are pleased to be able to pass on to the public the reductions made possible by the enormous demand created for these coils.



Mullard Master Three, Three-Wave Two, etc. Low and B.B.C. Wavelength 3/11 each. High-Wave 5/3 Split-Primary H.F. as previous Formers 2/3 and 3/6

What a satisfied "A.W." reader writes:

"Your coils are simply wonderful value. They are more efficient and altogether superior in every way to others at nearly double the price."

Coils for all 6-pin or plug-in circuits, from all live dealers or direct Post Free from:

**TURNER & CO.**  
54 Station Rd., N.W.11



### TWO STAGE L.F. UNIT

One Stage RESISTANCE and one Stage TRANSFORMER. In sealed Bakelite Moulding

Price 30/-

Delightfully clear reproduction and volume.



Send for Full Catalogue, and Booklet "L.F. AMPLIFICATION" WITH BLUEPRINTS. Post Free.

**OLYMPIA: STAND 140**

CROWN WORKS, CRICKLEWOOD LANE, N.W.2. Phone: Hampstead 1787

# FREE CATALOGUE

## FREE CABINETS

for PORTABLE CASES MOVING-COIL AND CONE SPEAKER CABINETS

A twenty-page catalogue showing our latest range of CABINETS. Send for a FREE copy.

**OLYMPIA: Stand No. 107.**  
Carrington Manufacturing Co., Ltd.,  
Cameo Works, Sanderstead Rd., South Croydon. Tel.: Croydon 0623 (2 lines).





CABINETS PANELS

# EXTRA POWER ALL THE TIME PATENT STEEL WIRELESS MAST

A High Aerial is as good as another Valve

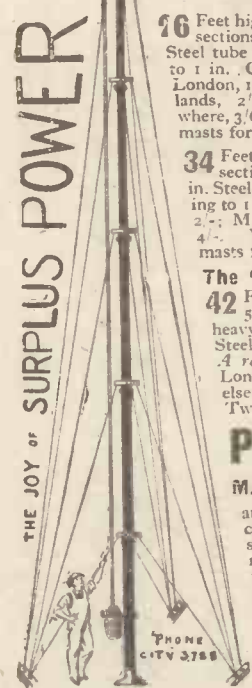
**DAMP PROOF!  
ROT PROOF!!  
GALE PROOF!!!**



THE JOY OF SURPLUS POWER

**26** Feet high. In 3 sections of 1 1/2 in. Steel tube tapering to 1 in. Carriage, London, 1/6; Midlands, 2/6; elsewhere, 3/6. Weight, 24 lb. Two masts for 28/6.

**34** Feet high. In 4 sections of 1 1/2 in. Steel tube tapering to 1 in. Carriage, London, 2/-; Midlands, 3/-; elsewhere, 4/-. Weight, 34 lb. Two masts for 40/-.

The "SUPER" Mast **42** Feet high. In 5 sections of heavy 1 1/2 in. Steel tube tapering to 1 in. A real bargain. Carriage, London, 2/6; Midlands, 3/6; elsewhere, 4/6. Weight, 46 lb. Two masts for 55/-.

**P.R. MASTS** are made of British Steel in 9-ft. lengths, from 1 1/2 in. tapering to 1 in., and are supplied with cast-iron bed plate, steel ground pegs, stay rings, galvanised steel flexible wire stays cut to lengths, pulleys, bolts, and fullest erecting instructions. No further outlay necessary. **NO HOLES TO DIG.**

**GUARANTEE**  
Minimum Radius 3 ft. 6 in.  
The easiest Mast to erect.  
Anyone can put it up.  
Waterproof Log Line, double length. 26-ft. Mast, 1/6; 34-ft. Mast, 2/-; 42-ft. Mast, 2/6.  
P.R. Colloid Coating for protecting the Masts against weather—sets in one hour. 2/6. Sufficient for one Mast.

**P. R. MASTS**  
(Opposite Post Office Tube)  
17-1 PATERNOSTER SQ., NEWGATE ST., LONDON, E.C.4

**USE EEXLEX TREBLE DUTY TERMINALS AND OTHER WIRELESS ACCESSORIES**  
J.J. EASTICK & SONS.  
EEXLEX HOUSE, BUNHILL ROW, LONDON, E.C.1

**TAYLEX WET H.T. BATTERIES**  
New Prices Jars 1/3, Bacs 1/2, Zincs 11d. Sample doz. (18 Volts) complete with leads and electrolyte 4/3., post 0/1. Sample unit 6d. Illus. booklet free. Bargain list free.  
**AMPLIFIERS, 30". 2 VALVE ALL-STATION SET 5/4.**  
A. TAYLOR, 57 Studley Road, Stockwell, LONDON

## LETTERS TO THE EDITOR

(Continued from page 335)

fifty stations at loud-speaker strength at any time during the day or night and Radio Paris comes in louder in the day time than Daventry at night time on my three-valve set.

Congratulating you on this fine circuit. I am yours gratefully, S. T. B.

### Charlot's Hour

**S**IR,—I must write a line to thank Mr. Moseley for the fourth paragraph of his "Without Fear or Favour" in the August 25 issue, *re* "Charlot's Hour."

Every listener I know will echo his remarks. S. A. J. (Eastbourne).

All Scottish stations are to relay the juvenile prize winners' concert from the National Gaelic Mod at Inverness on September 25. All lovers of Gaelic song will be interested in this relay, as it is the first time a juvenile concert has been broadcast by the National Mod.

A play, entitled *Followers*, by Harold Brighouse, will be given by 5GB on September 25. The Midland Pianoforte Trio will provide the incidental music, and the cast will include F. A. Chamberlain, Molly Hall, Gladys Joiner, and John Moss.

*Our Programme* is the title of a concert to be given by the Bristol Listeners' Club from the Cardiff station on September 29. The artistes include Hilda Eager (soprano), Reginald Russell (bass), E. U. Ridgway, and Frances Gayton (entertainers). Music will be provided by the Bristol Banjo Quartet.

## PREPAID ADVERTISEMENTS.

Advertisements under this head are charged **THREEPENCE PER WORD**, minimum charge **THREE SHILLINGS.**

### DEPOSIT SYSTEM

As the Publishers cannot accept responsibility for the bona fides of advertisers in this publication, they have introduced a system of deposit which it is recommended should be adopted by readers when dealing with persons with which they are unacquainted. It is here explained.

Intending purchasers should forward to the Publishers the amount of the purchase money of the article advertised. This will be acknowledged to both the Depositor and the Vendor, whose names and addresses must necessarily be given. The Deposit is retained until advice is received of the completion of the purchase, or of the article having been returned to and accepted by the Vendor. In addition to the amount of the Deposit, a Fee of 6d. for sums of £1 and under, and 1s. for amounts in excess of £1, to cover postage, etc., must be remitted at the same time. In cases of persons not resident within the United Kingdom, double fees are charged.

The amount of the Deposit and Fee must be remitted by Postal Order or Registered Letter (Cheques cannot be accepted), addressed to

"AMATEUR WIRELESS," ADVERTISEMENT DEPARTMENT, 58/61, FETTER LANE, LONDON, E.C.1

**PATENTS.**—Trade Marks, Advice Handbook free.—B. T. King, Regd. Patent Agent, 246, Queen Victoria Street, London.

**WOOD HORNS** for all gramophone units, etc.: List, Maddison, 1 Chapel St., Edgware Rd., N.W.1. Manufacturer of THE ALLWOODORNS.

**MOVING COIL, LOUD SPEAKERS**—10" and 19" monthly. **COSSOR MELODY MAKER** and all accessories. 5- and 16/6 monthly. Everything wireless on easy terms. Lists free.—World's Wireless, Wallington.

**A. C. MAINS UNIT.** Permanent low tension filament current. No acids no valves. Costs less than £2 to make. Blueprint instruction 2/3. Electric Devices Co., 47 Arcade, Lord Street, Liverpool.

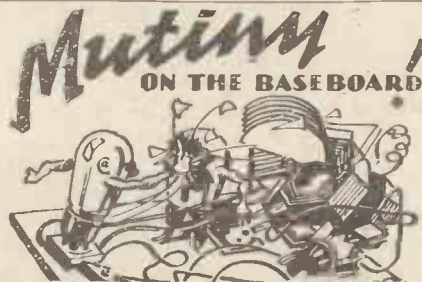

When your set gets out of hand, take the one vital step that ensures the perfect balance so necessary to secure harmonious, distortionless reception—fit a Sifam Meter and tune with your eyes on the dial. **FREE leaflet "Distortion"**  
from—(Dept. A), SIFAM, LTD., BUSH HOUSE, ALDWYCH, W.02

M.B. 529

**THE FAMOUS DIX-ONEMETER**  
Still leads the way  
A £10 Tester for 55/-  
Send Stamped Envelope for Free Booklet

A.C. to D.C. Battery Chargers, 220 v. to 6 v. 6 amp. 50/- only.  
Anode Converters, 400 volts, £6 10s. B.E. Valve Bargains, B.T.H. Cossor, etc., A.C. to D.C. 50 m/a. 200 to 1,200 volts, cost 35/-, Sale 4/6.  
Switches, 250 volts, 6d. 8-way Lucas 3/6. S.K. Amplifier Micro. Units, 2,000 ohms, 13/-. Buttons, 1/-.

Western Electric Loud Speakers, 15/-. Violins, 25/- Sullivan Headphones, 3/-. Single Phone, 1/6. Rubber Ear Pads, 3d. per pair. Gramo Pick-ups, 15/-. Gyroscopes, 15/-. Mains Smoothing Chokes, 1/- 2-mfd. Condensers, 2/6 Remote Relays, 10/-. Pear Pushes, 6d. Sterling 1-valve Amplifiers, 22/6. 2-v. T.B. Amplifiers, 32/6. Inert Fuller, 1 1/2 cells, 1/- Thermo A.C. Meters 250 m/a. 15/-. 4-range B21 Testers, A.C. or D.C. 200 m/a, 4 amps. 6 v., 120 v., 40/- Large Steel Horseshoe Magnets for Coil Speakers, 3/6. Bargain Sale of Transmitters and Receivers, 1 to 6 Valves, now on.

NEW 72-PAGE CATALOGUE NOW READY SEND 4d. STAMPS  
**ELECTRADIX RADIOS**  
218 Upper Thames Street, E.C.4.

**BRIGHTER B.B.C. PROGRAMMES**  
Will you support a petition to the Government asking for brighter and more entertaining B.B.C. Programmes, and the omission of uninteresting talks during evening transmissions? Then send your name and address.

**Have a RELIABILITY WIRELESS GUIDE Handy.**  
It's Free upon request. When programmes are more popular you will listen often, and as replacements are required, the GUIDE will be of great service. Write for it NOW.

**J.H. TAYLOR & CO.**  
3-RADIO HOUSE - MACAULAY ST. HUDDERSFIELD

**THE LITTLE CELLS THAT SATISFY**  
Eten Primary 11.T. Battery. Pl Porous Pot Cells, S1 and S2 Sa: Cells. All complete for assembly.

|    |        |        |         |         |
|----|--------|--------|---------|---------|
|    | 1-cell | 2-cell | 12-cell | 30-cell |
| P1 | 1d.    | 3/3    | 5/3     | 14/-    |
| S1 | 1d.    | 3/-    | 5/3     | 12/-    |
| S2 | 4d.    | 2/6    | 3/10    | 9/5     |

Send 1d. stamp for booklet giving full particulars to—  
**THE ETON GLASS BATTERY CO.**  
46 ST. MARY'S ROAD - LEYTON - E.10

**STANDARD HIGH TENSION BATTERIES with GRID BIAS**

No. 16217 "Daimon" Battery 60 volts with Grid Bias 7/3 each  
No. 16219 "Daimon" Battery 100 volts with Grid Bias 12/3 each

From all good dealers

Issued by The Mandaw Company, Ltd., 9-15 Whitecross Street, London, E.C.1

**Amateur Wireless** **COUPON**  
Available until Saturday, **SEPTEMBER 22nd, 1928**

# Look for at **LOTUS** **OLYMPIA!**

News at the Lotus Stand! Two new components, two new sets being introduced by Lotus.

There is a new Variable Condenser and Vernier Dial—both typical Lotus quality. The condenser is mid-line and logarithmic. It is made with chemically cleaned special brass vanes and crd plates, with ample spacing and ball bearings.

The Lotus Vernier Dial is a slow motion dial with machine geared movement giving a ratio of 14-1. A closely marked satin aluminium dial reading 0-180 fitted to rear, fits flat against panel and a nickel plated cursor is rotated by a small knob round the dial.

The famous Lotus Remote Controls, Buoyancy Valve Holders, Coil Holders, Jacks, Switches and Plugs are also on view.

Come to Stand No: 115

## LOTUS COMPONENTS

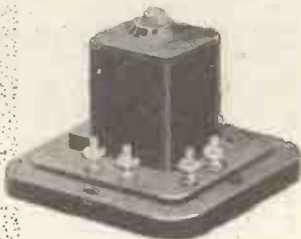
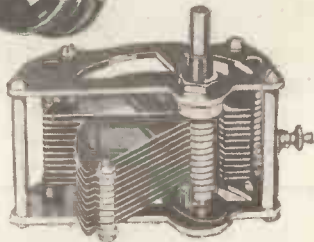
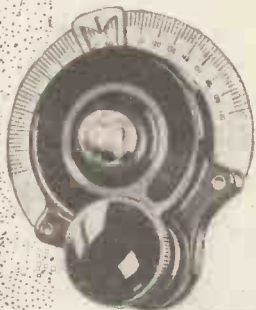

Lotus Relay



Lotus Valve Holder



Lotus Coil Holder

### PRICES

New Lotus Variable Condenser: '0005, 5/9d.; '0003, 5/6d.; '00025, 5/3d.; '00015, 5/-.

New Lotus Vernier Dial, 4/9d.

### The New LOTUS Portable and Transportable Sets

The new Lotus sets are the latest wireless—triumph. Using the new Mullard Screened and Pentode valves, the circuit is a combination of latest wireless discoveries and actually makes these three-valve sets capable of five valve results. Transportable models in oak, 30 gns., in walnut and mahogany, 31 gns. Portable models in leather case, 39 gns. Instalment terms.

Write for Booklet

**GARNETT, WHITELEY & CO., LTD.,**  
Lotus Works, Broadgreen Road, Liverpool.

To Ensure Speedy Delivery, Mention "A.W." to Advertisers.



make practically every wireless component you want!

Whether it be for a simple 2-valve Set or a highly selective Multi-valve Set—whether it be L.F. Components required to ensure real tonal purity, or the most up-to-date components for modern high-frequency amplification—whether it be the components necessary to construct an Eliminator suitable for all purposes, and capable of assuring the best results under all conditions—whether it be Gramophone Electrical Reproduction Apparatus—R.I. & Varley make them all, and in each and every one of them, **QUALITY** is the outstanding feature.

Come and see all our new products at the National Radio Exhibition, Olympia, Stands 56 and 73, and discuss your particular problems with our technical experts.



A.C. H.T. Eliminator  
£13 : 15 : 0



Heavy Duty Power Transformer  
£3 : 10 : 0



The New Gramophone Pick-up  
£3 : 3 : 0



Volume Control

**STANDS 56 & 73**

NATIONAL RADIO EXHIBITION  
Olympia, Sept. 22 - 29

**THE MARK OF**



**BETTER RADIO**

KINGSWAY HOUSE, 103 KINGSWAY, W.C.2  
Telephone: Holborn 5303