

*Radio and
Television*

CIRCUITS

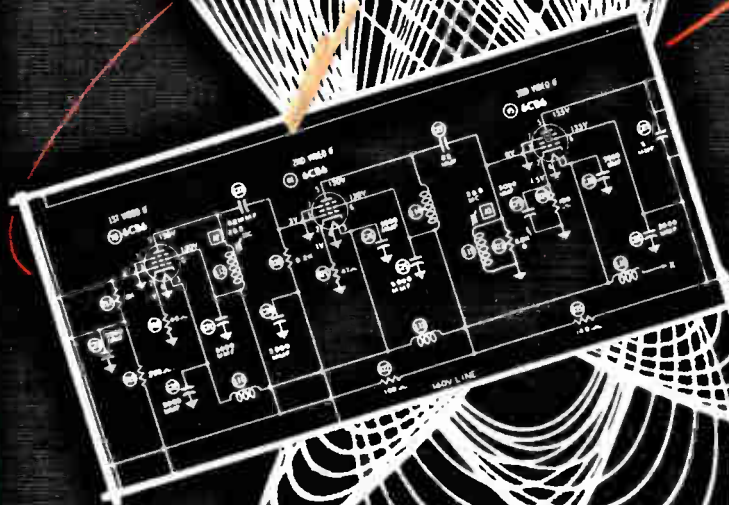

Coyne PUBLICATION

**APPLIED
PRACTICAL
RADIO-
TELEVISION**

APPLIED PRACTICAL RADIO-TELEVISION

A Practical Book

Covering

AMPLIFIERS
POWER TUBES
PHASE INVERTERS
TRANSFORMERS
DECOUPLING & SHIELDING
RECEIVERS
TUNING & TRACKING TESTS
TESTING METHODS
DISTORTION & NOISE
GAS & VAPOR FILLED TUBES
CONTACT RECTIFIERS — DETECTORS
HIGH FREQUENCY AMPLIFIERS
PHOTOTUBES — SPECIAL USES
Hundreds of facts, photos and diagrams

by

THE TECHNICAL STAFF

of

COYNE ELECTRICAL SCHOOL

CHICAGO 7, ILLINOIS

Copyright, 1955, by
COYNE ELECTRICAL SCHOOL, INC.
1501 W. Congress Pkway.
Chicago, Illinois

All rights reserved. This book or any parts thereof may not be reproduced in any form without written permission of the publishers.

1958 EDITION

Printed in the United States of America

FOREWORD

This book deals with Radio and Television circuits. It explains how various radio and television parts "dovetail" into complete circuits for the reception of signals. The best and quickest ways to determine the source of troubles in radio circuits is both explained in clearly written text and vividly portrayed illustrations.

The principal subjects covered are: special types of amplifiers, modern decoupling and shielding, receiver performance, tuning and tracking range tests, testing for faulty performance, selectivity, distortion, noise elimination, gas and vapor filled tubes, and what they can do, contact rectifiers and detectors, high frequency amplifiers, phototubes and dozens of other subjects.

This book is an excellent reference book for the radioman "in the field" who wants to be up to date on new applications and methods. It assumes no previous knowledge but presents the subjects in an easy to understand method of explanation.

As in all Coyne books the approach on every subject was, **MAKE IT PRACTICAL**. For that reason you will find close to 300 photos and diagrams, all crystal clear and as large as possible for easier reading and understanding.

Another advantage is that the material is not the work of one man, but rather represents the efforts of the Coyne Technical Staff of Instructors. The copy in each chapter of this book has been reread and checked by many men to make sure it was 100% technically accurate and also as clear and easy to follow as possible.

The rapidly expanding fields of Radio and Television have no place for a man who "stands still." The set, **APPLIED PRACTICAL RADIO-TELEVISION** (of which this book is an important part) provides the information you need to progress with your industry — to qualify for better jobs at more pay. A purchase of **APPLIED PRACTICAL RADIO-TELEVISION** is therefore an investment — an investment in yourself and your future in Radio and Television.

FOREWORD

As you continue to progress it is my confident belief that you will make more and more daily reference and use of Coyne's set, **APPLIED PRACTICAL RADIO-TELEVISION**. You now have the best set of books in one of the greatest opportunity fields in the world today — make the most of it —



B. W. COOKE, JR., *President*
Educational Book Publishing Division
COYNE ELECTRICAL SCHOOL

TABLE OF CONTENTS

RESISTANCE COUPLED AMPLIFIERS.....	1-36
20 diagrams, circuits, parts, load resistor, coupling capacitor, reactances (chart) grid resistor, capacitance, effect of shunt capacitance (chart) radio-frequency amplifier, DC & wide band amplifiers, high and low frequency compensation, questions.	
POWER AMPLIFIERS	37-58
15 diagrams, circuit, types, waveforms, phase inverters, power tube biasing, transformer, power stage oscillation, questions.	
POWER AMPLIFIER PERFORMANCE	59-82
16 diagrams, degeneration in amplifiers, variation of impedance with frequency, feedback (current and voltage), types A-A1, A2, B, AB1, AB2, C, driver Stages, questions.	
DECOUPLING AND SHIELDING.....	83-120
25 diagrams, principles of decoupling, effect of circuit elements on current and potential, capacitors for by-passing-plate and screen decoupling, choke coils, wave filters, low-high and band pass filters, questions.	
RECEIVER AND AMPLIFIER PERFORMANCE.....	121-146
15 diagrams, testing sensitivity, attenuator, output measurement, correction for decibel (chart) tracking test, oscillator frequency, checking gain variation, gains from load lines, questions.	
TESTS FOR FAULTY PERFORMANCE.....	147-176
18 diagrams, selectivity test, protecting receiver during selectivity test, testing with signal generator, constant signal testing, I-f amplifier selectivity, cross modulation, image frequency interference, I-f test, hum voltage, modulation and residual hum, hum bucking, questions.	
DISTORTION AND NOISE	177-200
15 diagrams, amplitude distortion, checking for harmonic and phase distortion, oscilloscope tracing, frequency distortion, questions.	
GAS-FILLED AND VAPOR-FILLED TUBES.....	201-234
Circuits, diagrams, ionization, voltage regulator tubes, gas-filled rectifiers, mercury vapor rectifiers, gas triodes, cold cathode rectifiers, gas tetrodes, ballast tubes or resistors, questions.	
CONTACT RECTIFIERS AND DETECTORS.....	235-250
Circuits, diagrams, types, selenium rectifiers, crystal detectors, crystal diodes, questions.	
TUBES FOR SPECIAL PURPOSES.....	251-265
Miniature and sub-miniature tubes, tubes for low plate voltage, tubes for high-ultra high frequencies, transit time effects, questions.	
HIGH FREQUENCY AMPLIFIERS.....	265-288
Circuits, diagrams, capacitors, inductors for high-frequency, by-passing, feltering and shielding—parts, polystyrenes, superregeneration, H-f receivers, transceivers, grounded-grid amplifier.	
PHOTOTUBES	289-334
Circuits, diagrams, visible and invisible radiations, photo-emission, sensitivity, gas phototubes, effects of load resistance, ratings and characteristics, cathode areas and lumens, amplifiers, relay operations applications.	

ACKNOWLEDGMENT

We wish to acknowledge and express our appreciation for the assistance and co-operation given to us by the following companies in supplying data and illustrations for the preparation of Coyne's Applied Practical Radio.

WESTINGHOUSE ELECTRIC & MFG. Co.

GENERAL ELECTRIC Co.

DUMONT COMPANY

CROSLY RADIO & TELEVISION CORP.

P. R. MALLORY COMPANY

STRUTHERS DUNN Co.

J. P. CLARE COMPANY

SYLVANIA ELECTRIC PRODUCTS Co.

WELCH SCIENTIFIC COMPANY

R. C. A. MANUFACTURING Co.

AMERICAN STANDARDS ASSOCIATION

PHILCO RADIO & TELEVISION Co.

Chapter 1

RESISTANCE COUPLED AMPLIFIERS

Were we to attempt arranging the sections of a radio or television receiver in the order of their relative importance we would be confronted with the fact that total failure of any important section makes the receiver useless, and so all the parts are essential. But were we to consider the various parts in relation to tone quality, sensitivity, selectivity, volume, and generally satisfactory rendition of music and speech the amplifiers doubtless would head the list.

So far as function is concerned there are three general classes of amplifiers; those for radio frequency, for immediate frequency,

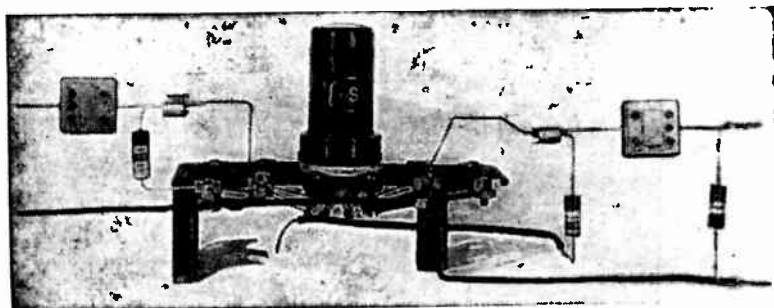

Fig. 1.—The parts of a resistance-coupled amplifier stage.

and for audio frequency. While the majority of radio-frequency amplifiers have tuned transformer coupling, there are a great many with resistance or resistance-capacitance coupling. Practically all intermediate-frequency amplifiers are of the tuned transformer type. Practically all audio-frequency amplifiers are of the resistance coupled type. Audio-frequency amplifiers of this type are found also in public address systems, intercommunication systems, phonograph reproducers, and in many special applications such as measuring instruments.

2 APPLIED PRACTICAL RADIO-TELEVISION

There are few of us, nowadays, who would design and build a tuned transformer coupling unit—it costs so little to buy them ready made of any desired quality. The resistance coupled amplifier, on the other hand, is easy to build. It consists merely of separate resistors and capacitors wired into the input and output circuits of the amplifier tubes. Once constructed, either in the service laboratory or the factory, the resistance coupled amplifier is easily altered to bring about major changes in performance in case the behavior is unsatisfactory.

Because of the mechanical simplicity and adaptability of resistance coupling it is worth spending some time to understand the functioning of the several parts and to understand their relations to one another and to the tube or tubes in the complete amplifier. Fig. 1 is a picture of the parts in a resistance coupled

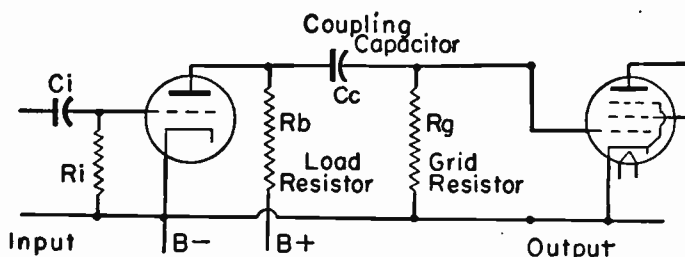

Fig. 2.—Circuit diagram of resistance coupling.

stage of amplification. In the center is the amplifier tube, set upon a small panel which carries a terminal for each socket connection. The input circuit for the control grid is at the left. The output circuit for the plate is at the right.

Fig. 2 shows the same parts in a circuit diagram. The left-hand tube and connections constitute the stage of amplification. Other parts are included because they form the input and output of most resistance coupled stages. Were the amplifier tube a pentode, instead of the triode shown by the diagram, there would be required an additional connection to B+, but this connection would not be part of the coupling.

An a-c signal, which may be at audio or radio frequency, comes through capacitor C_i to the control grid of the amplifier. In an a-f amplifier this might be the capacitor between the slider of the volume control and the grid of the first a-f amplifier tube. The grid return to the cathode is through resistor R_i . This resistor, in combination with capacitor C_i , provides a negative grid bias by means of grid rectification. If grid rectification were not used, the bias might be provided from the d-c plate and screen supply system or might be secured with cathode-bias.

D-c plate current for the tube flows in load resistor R_b which is between the plate and B+. Signal potential on the control grid varies the plate current or gives it an a-c component which follows the signal, and across resistor R_b there are these signal variations of potential.

The signal potentials, which are the a-c component of the potential in R_b , act through coupling capacitor C_c and appear across grid resistor R_g . The a-c signal potential which is across

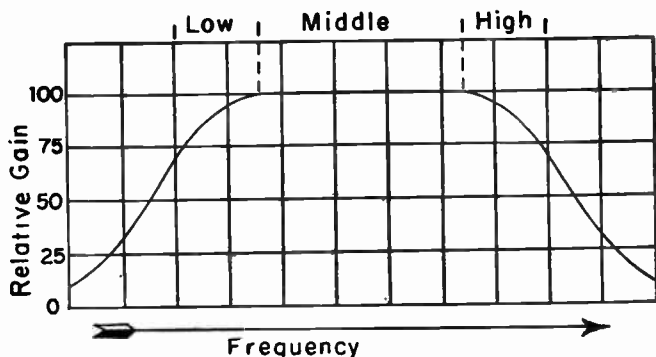

Fig. 3.—Relative gain in various ranges of frequency.

resistor R_g is the output potential of the amplifying stage. The a-c signal potential across resistor R_i is the input potential. Resistor R_g is called the grid resistor because it is connected between the control grid and cathode of the following amplifier tube. This following tube usually is the output amplifier or power amplifier.

Were we to draw a frequency response curve for any resistance coupled amplifier, showing the relative voltage gains at various operating frequencies, the curve would have the general form shown by Fig. 3. Somewhere between the lowest and highest frequencies for which measurements are made there will be a considerable range through which gain or amplification is fairly uniform or almost completely uniform and constant. This we call the middle frequency range. At both lower and higher frequencies the gain will become less. The low frequency range is considered to extend from the low limit of uniform gain down to a frequency where the gain is about 70 per cent of maximum, and the high frequency range extends from the high limit of uniform gain up to a frequency where the gain is about 70 per cent of maximum. These 70 per cent points, actually 70.7 per cent, are frequencies at which the voltage gain is down three decibels and at which the power is down to one-half of maximum. Sometimes we call these the cutoff points, because there is no useful gain at lower or higher frequencies.

Load Resistor.—Greater resistance in the load resistor R_b will raise the gain at all frequencies provided we can maintain the same plate current. But to maintain the same plate current calls for more and more plate supply voltage as the resistance is increased, because there is an increasing voltage drop in the resistor. If the plate supply voltage is not increased, and the load resistance is increased, the plate current will be reduced. The lower plate current means less transconductance or mutual conductance. Usually the drop of transconductance will counteract the extra gain that might be expected from the greater load resistance. Gain seldom is increased by using more load resistance unless the plate supply voltage is raised to maintain the plate current.

Changes of load resistance have little effect at the low frequency range. That is, the proportion of gain or ratio of gain at the low frequencies to the gain at middle frequencies cannot be helped by changing the load resistance. You may raise or lower the overall gain, as might be done with the volume control, but you will not improve the low frequency response to any great extent by experimenting with load resistors.

When you change the load resistance there will be a change of

plate voltage at the tube unless the B-supply system is altered at the same time to maintain the original plate voltage. The B-supply system usually cannot be changed to any great extent without rather complete re-designing. Therefore, more load resistance will have a greater voltage drop in this resistance, and less plate voltage will remain at the tube plate. Then there will be less plate current in the tube and in the new load resistance. The mutual conductance of the tube will be decreased with the smaller plate current, and variations of signal current will be smaller in the load resistance. These smaller signal current variations in the increased load resistance may cause signal voltages in the resistance which are greater than the signal voltages with the former smaller resistance, or the result may be smaller signal voltages than before.

With any particular amplifier circuit and B-supply system there will be some one load resistance for maximum gain. Ordinarily this will be the value of load resistance built into the amplifier at the factory. There will be less gain with smaller load resistances, and there will be less gain with greater load resistances. With any smaller load resistance the signal currents do not produce enough signal voltage, and with any greater resistance the lessened plate current causes too much decrease in mutual conductance.

If the B-supply voltage can be increased there will be greater signal output and greater gain provided the amplifier tube is not overloaded by the accompanying increase of plate current. If the amplifier tube has cathode-bias for the grid, the greater plate current in the bias resistor will make the bias more negative, will more or less counteract the effect of plate voltage on plate current, and will limit the increase of gain. With fixed bias the gain will go up about as fast as the B-supply voltage.

In some amplifiers, as shown by Fig. 4, there are two resistors in series between the B-supply and the plate of the amplifier tube. One is the load resistor R_b and the other is a voltage dropping resistor R_{bb} . Between the bottom of R_b and the tube cathode, or ground, is a bypass capacitor C_d of such large capacitance as to carry the signal potentials and currents from R_b back to the cathode. Then the signal appears only in R_b and there is nearly pure direct current in R_{bb} .

Plate voltage and current are determined by the B-supply voltage and the series resistance of R_b and R_{bb} . This average voltage and current may be held constant by keeping the sum of the two resistances constant while making the resistance of R_b either more or less, to change the effective load resistance. That is, when the resistance of R_b is increased that of R_{bb} is decreased, and vice versa.

In audio-frequency amplifiers using triodes the load resistances usually are between 0.2 and 1.0 megohm, with 0.47 megohm

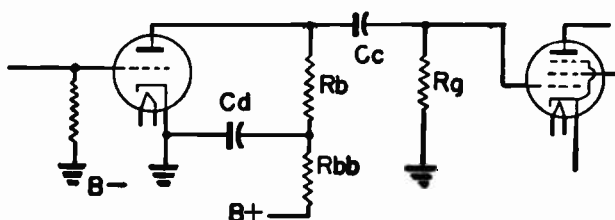

Fig. 4.—Decoupling resistor in series with load resistor.

a common value. With pentodes the load resistances range from about 0.04 to 0.50 megohm, with 0.22 megohm one of the more common values.

Coupling Capacitor.—As may be seen from the circuit diagrams the coupling capacitor C_c is between the highly positive plate potential and ground or cathode potential through the following grid resistor. This capacitor must be capable of withstanding the maximum B-supply voltage while the tube cathodes are cold. It must have very high leakage resistance so that current from B+ cannot flow through the grid resistor. Even a very small current would make the grid of the following tube positive. Coupling capacitors always are of mica or paper dielectric types, not electrolytics.

Capacitances of coupling capacitors in a-f amplifiers using either triodes or pentodes range from 0.001 to 0.050 microfarads, with 0.01 mfd probably the most common value. Signal current variations have to go through this capacitor from the load re-

sistor to the following grid resistor, and the signal is opposed by the capacitive reactance of the coupling capacitor.

If we make a slight rearrangement in the diagram for the resistance coupled amplifier, as in Fig. 5, it becomes easy to see that the reactance of the coupling capacitor C_c and the resistance of the grid resistor R_g are in series with each other. It also becomes plain that whatever signal potential is developed across the load resistor R_b is applied to C_c and R_g in series. We assume that the reactance of capacitor C_d , a bypass, is negligible at the

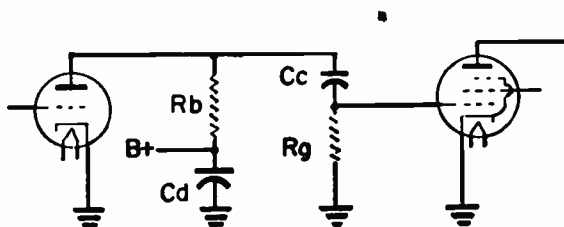

Fig. 5.—The coupling capacitor and grid resistor are in series.

signal frequencies. This bypass between B+ and ground or cathodes may be almost anywhere in the circuits, but always it will be found somewhere.

The signal voltage which is applied across C_c and R_g in series will divide between the capacitor and resistor in proportion to their impedances, or in proportion to the capacitive reactance of C_c and the resistance of R_g . At audio frequencies and at broadcast radio frequencies the resistance or impedance of R_g will undergo little change throughout the range of frequencies. But the reactance of C_c is relatively great at low frequencies, and small at high frequencies.

If we consider a frequency at which the reactance of C_c is equal to the resistance of R_g , the signal will divide equally between them. The only part of the signal potential applied to the following tube is the part appearing across R_g . Therefore, with half of the potential being used up in the coupling capacitor only the remaining half will go to the following tube. If the reactance of C_c is one-fourth the resistance of R_g only one-fifth of the

signal will be lost in C_c , because C_c will have only one-fifth of the total impedance of C_c and R_g in series.

Because the reactance of the coupling capacitor goes up as frequency goes down, more and more of the available signal potential will be lost in the capacitor as the frequency is lowered, and less and less will remain for the following tube. Then the gain of any resistance coupled amplifier must become less at the lower operating frequencies than at the higher frequencies.

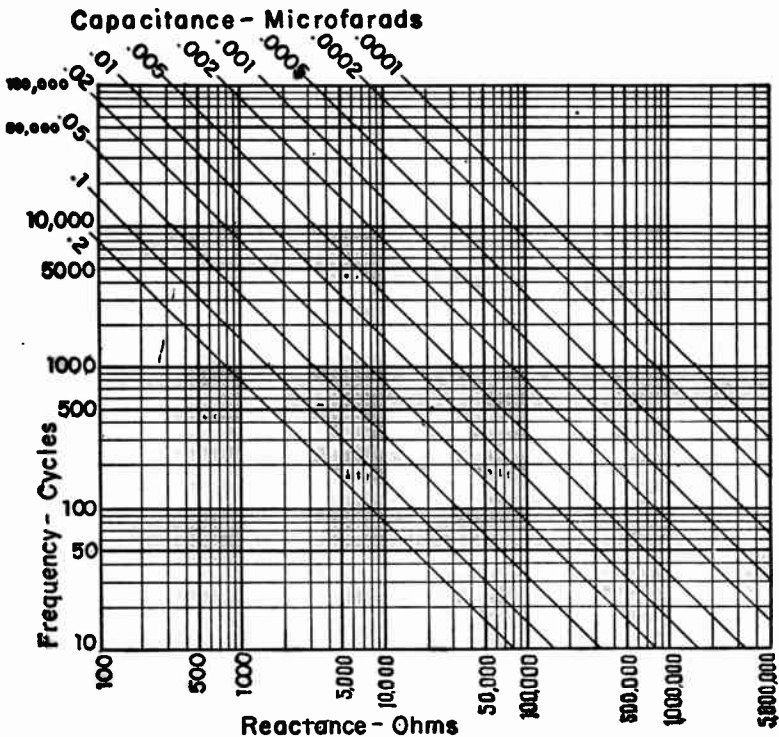

Fig. 6.—Capacitor reactances at audio frequencies.

The gain at various frequencies depends on the capacitance and capacitive reactance of the coupling capacitor at each frequency, and on the resistance of the following grid resistor.

Fig. 6 shows the relations between capacitance in microfarads, capacitive reactance in ohms, and frequency in cycles for all of the

values met with in a-f amplifiers of the resistance coupled type. The vertical frequency scale extends from 10 to 100,000 cycles per second. The horizontal reactance scale extends from 100 ohms to 5 megohms. Capacitance values from 0.0001 to 0.2 mfd are shown by the sloping lines. As an example in using this chart, assume a capacitor of 0.001 mfd and a frequency of 8,000 cycles. Following the diagonal capacitance line for 0.001 mfd to the horizontal line for 8,000 cycles, the intersection is on the vertical line for 20,000 ohms, which is the reactance of the capacitor at this frequency.

From this chart may be computed the theoretical percentage of the signal across R_b which is applied to the following tube from R_g at any frequency in the audio range. For an example assume a coupling capacitor of 0.01 mfd capacitance, a grid resistor of 0.5 megohm or 500,000 ohms, and a frequency of 200 cycles.

Reactance of 0.01 mfd at 200 cycles	80,000 ohms
Resistance of grid resistor	500,000 ohms
Total impedance	<u>580,000 ohms</u>
Fraction of total in grid resistor	0.862
Percentage of signal in output	86.2 per cent

At 100 cycles the percentage would be 75.8, at 50 cycles it would be 62.5, but at 800 cycles it would be 96.2 per cent.

Again considering the 200-cycle frequency, increasing the coupling capacitance from 0.01 to 0.02 mfd would raise the percentage from 86.2 to 92.6. Decreasing the coupling capacitance from 0.01 to 0.005 mfd would lower the percentage to 75.8.

The lower the frequency at which it is desired to have satisfactory output the greater must be the capacitance of the coupling capacitor. A common rule is to use a capacitance such that its reactance at the lowest important frequency is not more than 1/10 of the resistance of the following grid resistor. Assume that we wish to have good reproduction down to 100 cycles and that the resistance of the grid resistor is 500,000 ohms. One-tenth of this resistance is 50,000 ohms. On Fig. 6 we find that the intersection of the vertical line for 50,000 ohms and the horizontal line for 100 cycles lies between capacitance lines for 0.02 and 0.05 mfd. The required capacitance appears to be about 0.03 mfd or slightly greater.

Sometimes the coupling capacitance is made rather small with the intention of lessening the 60-cycle hum with a half-wave rectifier in the power supply, or the 120-cycle hum with a full-wave rectifier.

Fig. 7 shows the effect of several values of coupling capacitance on low frequency signal transfer. The values are computed from the relative reactances of the capacitances and 0.5 megohm or 500,000 ohms resistance in the following grid resistor. The upper curve is for a capacitance of 0.05 mfd, the next one for 0.01 mfd, the third one for 0.005 mfd, and the bottom curve is for 0.001 mfd.

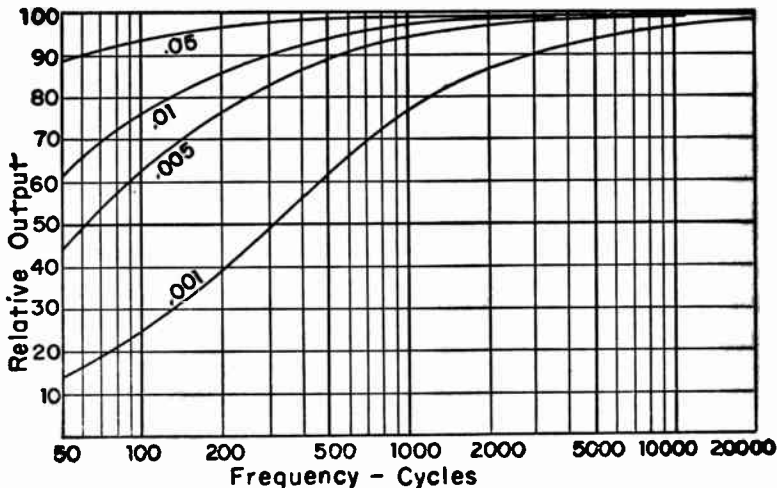

Fig. 7.—Effect of coupling capacitance on low-frequency gain.

If we consider that the signal transfer is no longer useful when it falls below 70 per cent of maximum, the cutoff for the 0.05 mfd capacitor is well below 50 cycles, that for 0.01 mfd is at about 70 cycles, for 0.005 mfd it is at about 150 cycles, and for 0.001 mfd the cutoff frequency is around 700 cycles.

Grid Resistor.—From what has been said about the effect of coupling capacitance and grid resistor on the percentage of sig-

nal transferred it is apparent that we wish to have the highest possible resistance in the grid resistor. The higher is this resistance the greater is the percentage of the signal transferred to the following tube.

If the resistance of the grid resistor R_g is made too great with an amplifier tube operated at a small negative grid bias, or possibly at zero bias, the very small grid current which may flow in the grid resistor will upset the bias. With excessively high resistance, negative electrons which reach the grid accumulate there instead of passing quite freely through the grid return path. The effect is erratic amplification, somewhat as though there were a "free grid" with no grid return at all.

Commonly used values for the grid resistor are between 0.2 and 2.0 megohms. As we should expect, the smaller the coupling capacitance and the greater its reactance, the greater we usually find the grid resistance. Thus there is maintained a high percentage of signal potential in the grid resistor. Nearly always the resistance of the grid resistor is twice or more the resistance of the load resistor R_b .

Fig. 8 shows how variations of resistance in the grid resistor affect the signal transfer and the gain at various frequencies. The full-line curves apply with a coupling capacitor of 0.01 mfd. The upper one of these full-line curves shows the relative output at various frequencies with the grid resistor of 2.0 megohms. The next curve shows the output with the grid resistor changed to 1.0 megohm, still with the 0.01 mfd coupling capacitor. The third curve shows output with a grid resistor of 0.5 megohm. This curve is the same as the one for 0.01 mfd coupling capacitor in Fig. 7, where all of the curves are drawn for a grid resistor of 0.5 megohm. The lower full-line curve of Fig. 8 shows output with the grid resistor changed to 0.25 megohm.

The broken-line curves of Fig. 8 apply with the coupling capacitor of 0.001 mfd and with grid resistors of 2.0 megohms (upper broken-line curve) and of 0.5 megohm (lower broken-line curve). This lower curve is the same as the one for a coupling capacitor of 0.001 mfd in Fig. 7.

From Figs. 7 and 8 it is apparent that an increase of resistance in the grid resistor has much the same kind of effect on low frequency gain as has an increase of capacitance in the

coupling capacitor. Changing the grid resistor (Fig. 8) from 0.5 to 2.0 megohms gives about the same improvement in low-frequency gain that results from changing the coupling capacitor (Fig. 7) from 0.01 to 0.05 mfd. A 2.0 megohm resistor costs little if any more than a resistor of 0.5 megohm, but a capacitor of 0.05 mfd costs a great deal more than one of 0.01 mfd. Consequently, it is less costly to attain good low-frequency response by raising the grid resistor resistance than by raising the capacitance of the coupling capacitor. The difficulty is that very high resistances in the grid circuit cause erratic performance.

Note that variations of grid resistor have relatively little effect on gain at frequencies higher than about 1,000 cycles, and prac-

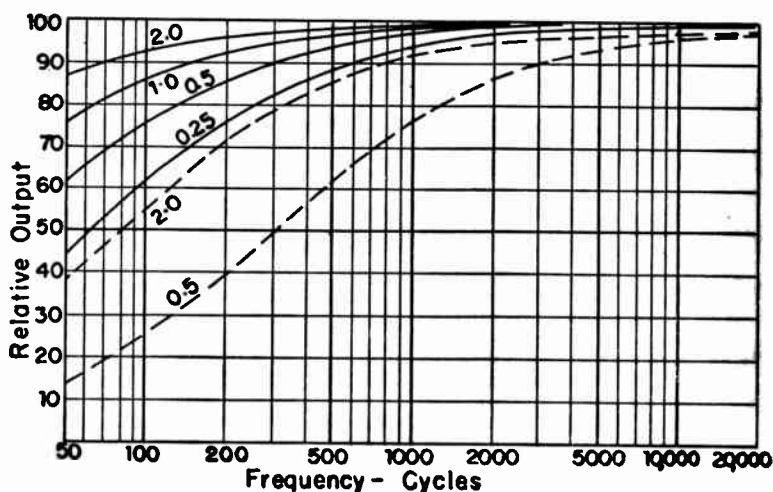

Fig. 8.—Effect of grid resistor resistance on low-frequency gain.

tically no effect at frequencies above 2,000 or 3,000 cycles. The grid resistor, like the coupling capacitor, has its greatest influence at the lowest frequencies.

Capacitances of Tubes and Circuit.—In the resistance coupled

amplifier there are capacitances which are not inserted in the form of capacitors, but which nevertheless have important effects on the gain at high frequencies. These capacitances include (1) the output capacitance of the amplifier tube, (2) the input capacitance of the following tube, and (3) the distributed or stray capacitances of the wiring, the sockets, and all other parts of the amplifier.

The capacitances may be represented as at the left in Fig. 9. Here C_o is the output capacitance of the amplifier tube, C_w is the total distributed or stray capacitance in sockets and all connections, while C_i is the input capacitance of the following tube. These three capacitances are in parallel with one another and with resistors R_b and R_g . The coupling capacitance, shown as C_c in other diagrams, here is omitted because at the high frequencies being considered its reactance is so small as to form the equivalent of a direct conductive connection for signal potentials and currents.

Since the tube capacitances and the circuit capacitances are in parallel with one another their values add together, and the three may be considered as a single shunt capacitance. Then, so far as the signal is concerned, the circuit may be simplified as at the right in Fig. 9. This is an "equivalent circuit" for the

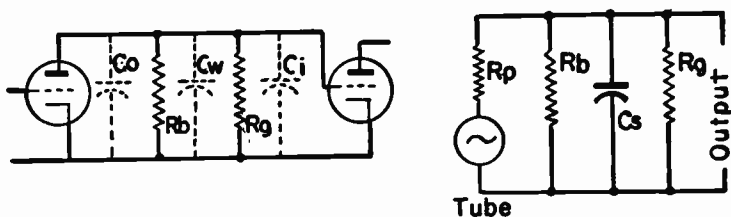

Fig. 9.—Capacitances which affect the gain at high frequencies.

resistance coupled amplifier operating at high frequencies. The amplifier tube is shown as an a-c generator in series with which is the plate resistance R_p of the tube. It is in the tube that the signal voltages are generated, and these voltages have to act

through the tube plate resistance. The total shunt capacitance is shown as C_s , in parallel with resistors R_b and R_g .

The output capacitances of tubes commonly used in resistance coupled amplifiers range from 4 to 10 micro-microfarads. The input capacitance of tubes following is not much different. The average parallel value of output and input capacitances will be around 15 mmd. The stray capacitances in the sockets and connections may be almost anything in value up to several hundred mmd.

The shunt capacitance acts like a bypass across the load and grid resistors, and across the output. As the frequency rises, the reactance of this capacitance falls. The upper frequency limit

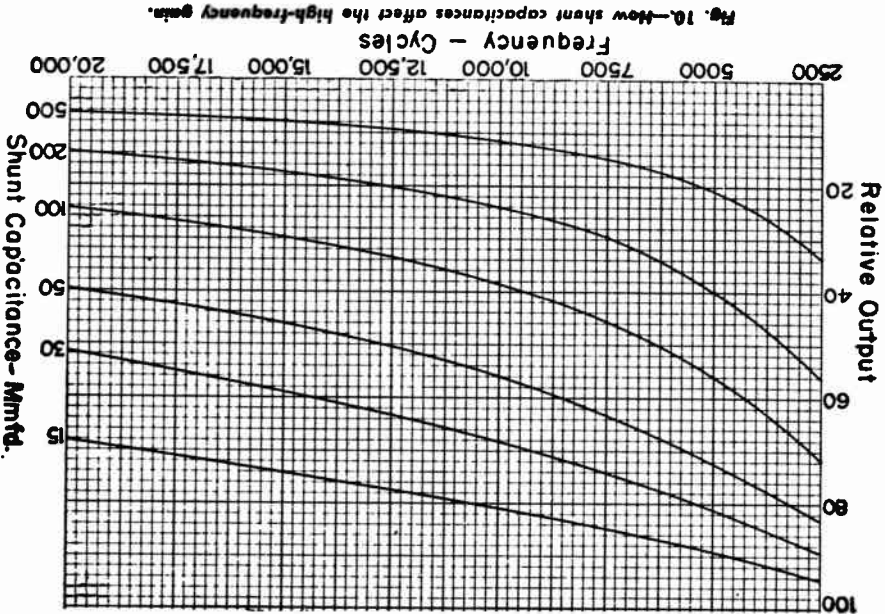

Fig. 10.—How shunt capacitances affect the high-frequency gain.

of useful amplification is determined by the bypassing effect of the shunt capacitance. The less the total shunt capacitance the higher will be the frequency at which there is satisfactory gain. The effect of shunt capacitance on the output or gain at various

frequencies between 2,500 and 20,000 cycles is shown by Fig. 10. In arriving at the values shown by this graph it has been assumed that the load resistor is of 0.5 megohm and the grid resistor is of 0.5 megohm resistance. The two resistors are in parallel across the tube, as shown at the right in Fig. 9. Their parallel resistance is 0.25 megohm. But, in parallel with the two resistors is the shunt capacitance and its reactance. Then the load on the tube really is the impedance of the resistors and the capacitance, all in parallel.

In Fig. 10 an output of 100 is considered to exist when there is no shunt capacitance. This is an ideal, but impossible, condition. The reduction caused by shunt capacitances from 15 to 500 mmfd is shown by the curves. With construction of laboratory quality it might be possible to have a shunt capacitance of only 15 mmfd. Then we would have 70 per cent or more of the ideal output at frequencies almost as high as 20,000 cycles. With first class com-

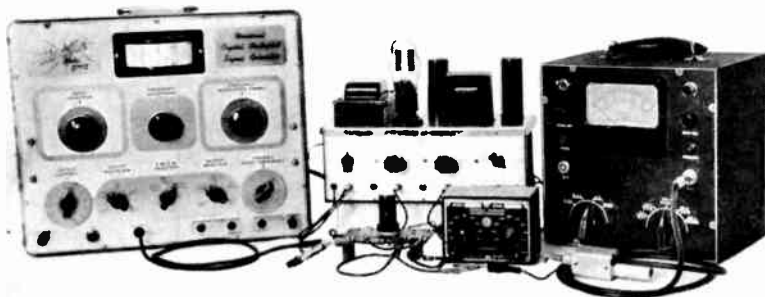

Fig. 11.—Test setup for measuring performance of resistance couplings.

mercial construction the shunt capacitance might be 30 mmfd. Then we would have 70 per cent or more of the ideal output at frequencies up to about 10,000 cycles. Even with a total of 50 mmfd of shunt capacitance the output would be high at frequencies between 5,000 and 6,000 cycles. But with still greater shunt capacitances there will be a sharp drop with increase of frequency, and the high-frequency response will be severely limited.

Inspection of Figs. 7, 8 and 10 shows that it should be easy to construct an amplifier with high output at low audio frequencies and a cutoff of all frequencies above 2,000 or 3,000 cycles. We would use a large coupling capacitance and the maximum permissible resistance in the grid resistor, and would make no particular attempt to reduce the shunt capacitance. To build an amplifier having good response at the highest audio frequencies requires high quality parts and careful construction.

Although the curves which have been shown so far have been drawn from computed values, the same results are obtained in practice with a testing setup such as pictured by Fig. 11. The signal generator at the left provides an adjustable frequency with variable amplitude. In the center rear is a power unit providing adjustable voltages for plate, screen, and grid bias. In

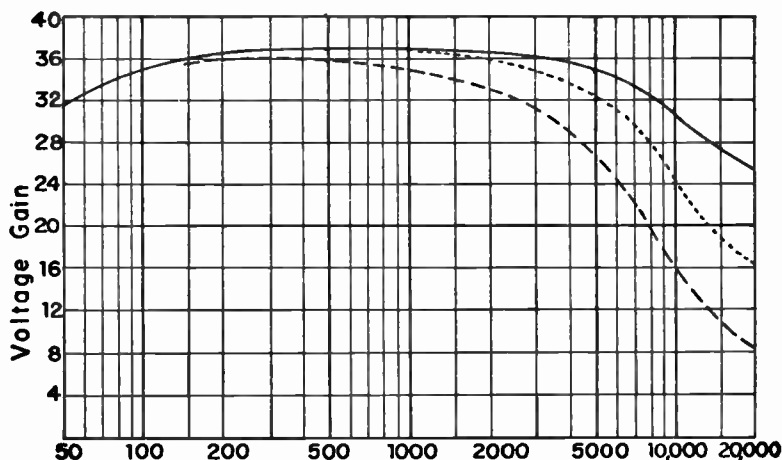

Fig. 12.—Effect of shunt capacitances on overall gain.

front of the power unit is the amplifier tube with the connected resistors and capacitors. Adjustable coupling capacitance is secured with the decade capacitor at the right of the tube, in which are used low-loss silver mica capacitors. The output is measured with the electronic voltmeter at the right. The voltmeter itself

has an input resistance of many megohms and less than 10 mmfd of shunt capacitance.

Fig. 12 shows the results of tests made with a triode amplifier, using a coupling capacitor of 0.01 mfd. The full-line curve shows the gain with the output connected to the electronic voltmeter, and with the only shunt capacitances those in the amplifier tube, the voltmeter, and the circuit connections. The tube socket was of low-loss construction, and all parts and wiring were spaced apart to lessen the capacitances. Maximum gain is 36. The gain does not fall to 70 per cent of maximum until the frequency reaches 20,000 cycles.

The dotted line curve of Fig. 12 shows the effect on gain of adding a shunt capacitance of 75 mmfd. Now the gain drops to 70 per cent of maximum at about 10,000 cycles. The dash-line curve shows the effect of adding a shunt capacitance of 200 mmfd. The 70 per cent point now occurs at about 5,000 cycles. Neither of the shunt capacitances has any important effect at frequencies below about 1,000 cycles.

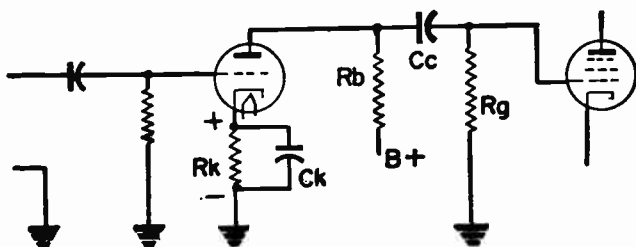

Fig. 13.—Cathode-bias with resistance coupling.

Shunt capacitance may be lessened by using resistors and coupling capacitors of small dimensions and small surface areas, by mounting parts in the control grid and plate circuits away from chassis metal, by keeping the leads for control grid, plate and screen separated from one another and from chassis metal, and by making all connections as short and direct as possible. It

even helps to use wire of small gage size. All of these things improve the high-frequency gain.

Formulas for Gain.—There are many formulas and rules by which the gain of a resistance coupled stage may be computed. The formulas which give results borne out in actual practice are complicated. They require knowledge of the actual total shunt capacitance, which can be determined only by laboratory measurements. To measure all of the factors which must be known requires more apparatus and more time than needed to make direct measurements of gain with an input signal of known amplitude.

Gain always is increased by greater mutual conductance or transconductance in the amplifier tube. Gain is increased also by greater load impedance. The load impedance is the impedance or

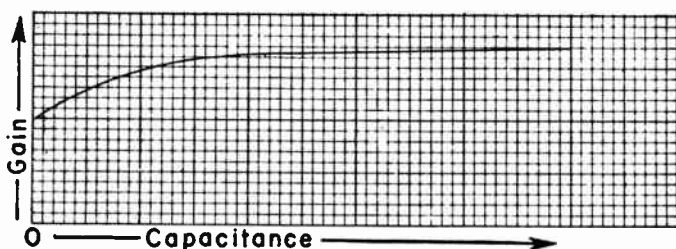

Fig. 14.—Greater bypass capacitance allows increased gain.

resistance of the load resistor, grid resistor, and shunt capacitance in parallel with one another. Gain drops when this impedance becomes smaller.

Cathode Bias.—Some resistance coupled amplifiers are provided with cathode bias as in Fig. 13. The bias resistor in series with the cathode is Rk . The bypass capacitor for the bias resistor is Ck . Were there no bypass capacitor the variations of potential produced across Rk by variations of signal current in the tube would cause degeneration. Degeneration is a negative feedback which opposes changes of signal potential, or the variations of the signal, in the grid circuit. This comes about because resistor Rk is in both the plate circuit and the grid circuit of the

tube. When the grid becomes less negative during a cycle of signal potential there is a corresponding increase of plate current. This increase of plate current in resistor Rk causes or is accompanied by an increased voltage drop across the resistor. Since the grid is connected to the lower negative end of the resistor, and the cathode to the upper positive end, the increase of voltage drop makes the grid more negative. The signal potential, which is making the grid less negative, is opposed by the cathode resistor potential, which tends to make the grid more negative.

Amplification and gain are reduced by negative feedback. How much feedback occurs, and how much the gain is reduced, depends on the capacitance of bypass capacitor Ck . If the capacitance is so large as to make the capacitive reactance much smaller than the resistance of Rk at the frequency considered there will be little feedback and but little reduction of gain. If the capacitance is small enough to have a reactance large in comparison with the resistance of Rk there will be more feedback and a greater reduction of gain.

If a cathode biased amplifier tube is operated at any given frequency, first with no cathode bypass and then with bypasses of increasing capacitance, the effect on gain will be about as shown by Fig. 14. There will be the least gain with no bypass, because then there is the greatest negative feedback. With bypasses of greater and greater capacitance the gain will increase until some certain capacitance is reached, and with all greater capacitances there is no appreciable increase of gain.

The value of capacitance above which there will be little additional gain often is considered to be that whose capacitive reactance is about $1/10$ the resistance of the bias resistor. The capacitive reactance is figured at the lowest frequency to be satisfactorily reproduced or amplified. As an example, assume a bias resistor of 5,000 ohms, and a low frequency of 100 cycles. Then the capacitive reactance of the bypass capacitor is to be $1/10$ of 5,000, or is to be 500 ohms at 100 cycles. To meet this requirement would call for 3.2 mfd of capacitance. The required capacitance is easily computed with this simple formula.

$$\text{Bypass mfd} = \frac{160\ 000}{\text{reactance, ohms} \times \text{frequency, cycles}}$$

Satisfactory results usually are obtained with any bypass capacitor whose reactance at the considered frequency is not more than 50 per cent of the resistance in the bias resistor. In the example using a bias resistor of 5,000 ohms and a low frequency of 100 cycles the formula would show the required capacitance, on the 50 per cent basis, to be 0.64 mfd.

Small values of biasing resistance require large values of bypass capacitance in order to obtain the necessary low value of capacitive reactance. Bypasses larger than one-half or one mfd usually are of the electrolytic type. Smaller capacitances usually are obtained with paper capacitors.

Bypassing with large capacitances is employed when it is desired to have maximum gain and the least possible or practicable negative feedback. Negative feedback or degeneration with relatively small bypass capacitances, or with no bypass at all, may be used when degeneration is desired. Degeneration re-

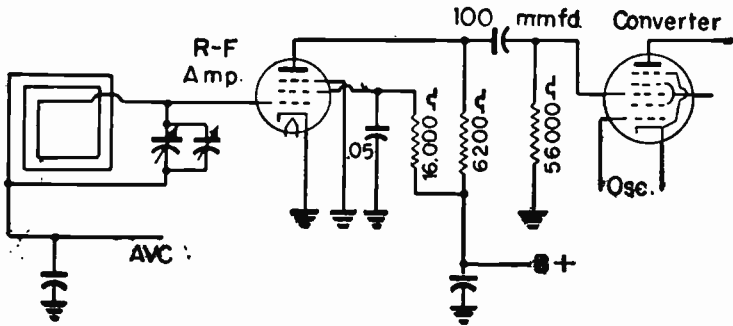

Fig. 15.—Resistance coupling in a radio-frequency amplifier stage.

duces distortion which is due to harmonic frequencies, and makes the amplifier less affected by changes in plate load impedance, by power line voltage fluctuations, and by replacement of tubes.

Radio-frequency Amplifier.—What may be called a typical or average resistance coupled radio-frequency amplifying stage is shown by Fig. 15. This amplifier is shown connected between a

tuned loop antenna, which might be replaced with any tuned antenna coil, and the signal grid of the following converter tube. The r-f amplifier is a pentode of high transconductance, usually around 2,000 micromhos, and of rather high plate resistance, an average value being about 1.0 megohm.

This amplifying stage operates in the broadcast band of radio frequencies, and often in the lower short-wave frequencies as well. From what we have learned about the difficulties of maintaining the gain at high frequencies we should expect to find very little amplification. The actual average gain will be only about six times from the r-f control grid to the converter signal grid when operating at the lower standard broadcast frequencies; this in spite of the high transconductance of the amplifier tube. Grid bias for the r-f amplifier is secured from the automatic volume control system when the tube is of the remote or semi-remote cutoff type, as most often is the case. This average gain of six in r-f resistance coupled stages compares with an average gain of 28 to 30 in a-f resistance coupled stages. The same types of pentodes used in r-f stages may be found also in a-f stages, but triodes as used in a-f stages are not used for r-f amplification.

The most apparent difference between r-f and a-f amplifiers of the resistance coupled type is in the values of load resistance, coupling capacitance, and grid resistance. The load and grid resistances in the r-f amplifier are only about 1/15 to 1/20 as great as in the a-f amplifier, and the r-f coupling capacitance is only 1/100 or less of the capacitance generally used in a-f amplifiers.

The smaller coupling capacitance is sufficient in the r-f amplifier because the reactance of any capacitance is much smaller at radio frequencies than at audio frequencies, also because the r-f signal voltages and currents are much smaller than those in the a-f amplifiers.

The smaller load resistance and grid resistance are necessary in order to lessen the effects of the shunt capacitances. The effect of shunt capacitance on impedance in the plate circuit is shown by the "equivalent circuits" of Fig. 16. At the left we have a load resistor of 6,200 ohms and a grid resistor of 56,000 ohms. The shunt capacitance is assumed to be 50 mmfd. At a frequency of 1,000 kc the capacitive reactance of the shunt capacitance is

about 3,200 ohms. The impedance of the capacitance and the two resistors in parallel is 2,033 ohms.

In the right-hand diagram the load and grid resistors have been increased to 500,000 ohms each. The reactance of the shunt capacitance remains as before. Now the parallel impedance be-

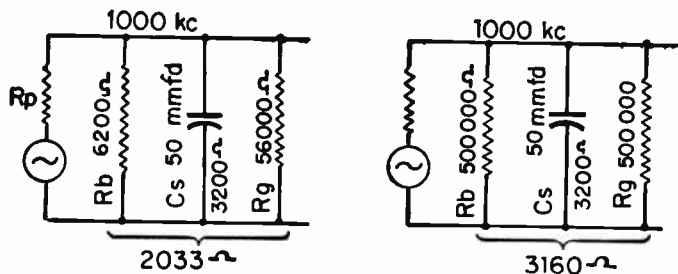

Fig. 16.—High-frequency load impedance depends largely on shunt capacitance.

comes 3,160 ohms. The impedance never can be greater than the capacitive reactance no matter how great we make the resistances which are in parallel.

By using high resistances we succeed in raising the parallel impedance by about 55 per cent, and, so far as the effect of impedance in the plate circuit is concerned, will have about 55 per cent more gain. But in the higher load resistance there will be a great drop of voltage even with only a very small plate current flowing in this resistance. So little voltage will remain at the plate of the tube that the output from the stage will be very small. There may be no gain at all, rather there may be a loss of nearly all of the signal input.

If the plate supply voltage could be raised to compensate for the drop in the load resistor, and maintain the same plate voltage as before, there actually would be an increase of gain. We then would be maintaining the transconductance of the tube and would have the advantage of the higher impedance in the plate circuit.

With any given load resistance an increase of plate voltage will be accompanied by an increase of output and of gain until we approach the maximum operating voltage and current for the tube. But every increase of plate voltage and plate current means that there will be more current and more voltage drop in the load resistor. Consequently, to obtain any given increase of

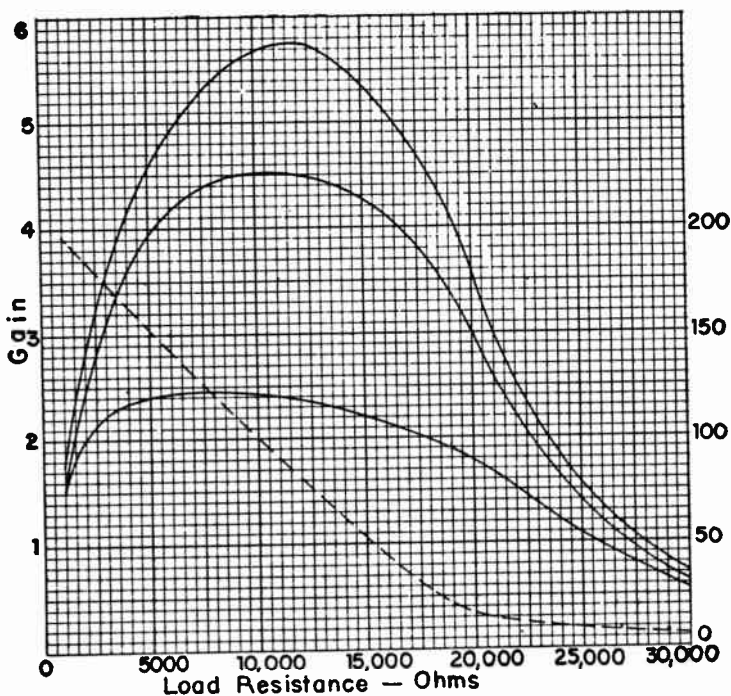

Fig 17.—Effect of shunt capacitance on high-frequency gain

voltage at the tube plate, which is plate voltage, the B-supply voltage will have to be raised much more than the rise obtained in plate voltage.

Fig. 17 shows what actually happens to gain of a resistance coupled r-f stage with three different values of shunt capacitance

and with load resistances from 1,000 to 30,000 ohms. The tube used in the test was an r-f pentode, operated at a frequency of 1,000 kilocycles. Plate supply voltage varied less than eight per cent, screen voltage was held constant, and the control grid bias was constant.

The upper full-line curve shows the gain with minimum shunt capacitance, the middle full-line curve shows gain with an added 20 mmfd of shunt capacitance, and the lower full-line curve shows gain with an added 75 mmfd of shunt capacitance. The broken line curve shows the change of plate voltage, measured from plate to cathode, as the load resistance in series with the plate is changed.

Fig. 17 emphasizes the importance of reducing shunt capacitance if any worth while gain is to be secured from a resistance coupled r-f stage. In examining the curves it must be kept in mind that a gain of 1.0 is really no gain at all, for it means that the output signal is just equal to the input signal. Any "gain" of less than 1.0 really is a loss, for then the output is less than the input.

It is apparent from the curves of Fig. 17 that the load resistance must be lessened as the shunt capacitance increases. With minimum shunt capacitance (upper curve) the maximum gain is secured with a load resistance of about 12,000 ohms. With some extra capacitance the maximum gain is secured with a load resistance around 10,000 ohms, and with still more capacitance a resistance of about 8,000 ohms gives the greatest gain. It is a general rule that the greater the shunt capacitance the smaller must be the load resistance.

A typical frequency characteristic for a resistance coupled amplifier designed for broadcast radio frequency amplification is shown by Fig. 18. In the design whose performance is represented the load resistance was selected for greatest possible gain at 1,000 kilocycles. At frequencies from this one down to about 500 kilocycles there is an increase of gain. At still lower frequencies there is a dropping off of gain due to the small coupling capacitance. Additional coupling capacitance would raise the lower end of the curve. At frequencies above 1,000 kilocycles there is a decrease of gain because of the effects of shunt capacitance.

The screen grid of the pentode must have adequate bypassing to the cathode or to ground, as shown in Fig. 15. A bypass capacitance of 0.05 mfd is quite commonly used, although a much smaller capacitance usually would be satisfactory. The reactance of 0.05 mfd at 500 kilocycles is between 6 and 7 ohms, much less than one per cent of any resistance likely to be used in series with the screen grid.

The plate current of an r-f pentode is affected very little by plate voltage, as is true with all pentodes, but is controlled almost

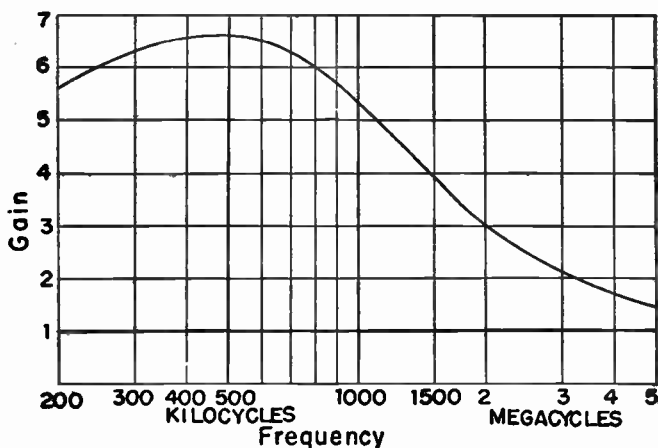

Fig. 18.—Response of an amplifier designed for standard broadcast r-f band.

entirely by the screen voltage and the control grid bias. The small signal voltages in the r-f amplifier, considered in relation to the fairly large minimum negative bias on the control grid, make it unnecessary to operate the screen at a higher direct potential than the plate to prevent secondary emission. However, in practically all ac-dc receivers which have no plate transformer the screen voltage is much higher than the plate voltage, the ratio of voltages often being as much as two to one or even

greater. This relation between plate and screen voltages results from the fact that it is necessary to use a load resistance in the plate circuit, which drops the plate voltage. No resistance, or one much smaller than the plate load resistance, is used in the screen circuit. In receivers having a plate transformer, which makes available any desired plate and screen voltages, the screen voltage may be either higher or lower than the plate voltage.

When it is possible to vary the screen voltage, as by altering a resistor in series with the screen, this voltage is adjusted to give acceptable gain with plate current no greater than necessary. With the performance shown by Fig. 17 the plate current is between 10 and 11 milliamperes for load resistances giving greatest gains. Tube specifications or data for the tube used list typical operating plate currents as lying between 9 and 13 milliamperes. Higher screen voltages and plate currents give little extra gain, but use more power and cause more heating of the tube. Any considerable reduction of screen voltage and plate current will cause large dropping off of gain. In general, if the screen voltage is adjusted to cause listed typical plate currents with the recommended control grid bias, the gain will be about as high as can be had economically.

Direct-current Amplifiers.—Although resistance coupled or resistance-capacitance coupled amplifiers such as have been described will amplify frequencies as low as 10 cycles they will not amplify changes of direct potential. This is because there are one or more capacitors in the coupling circuits, and capacitors do not pass direct current.

There are several types of resistance coupled amplifiers which will amplify direct potentials. One of them is shown by Fig. 19. The first tube, *A*, is connected to the input across which appear the direct potential changes to be amplified. This tube is cathode biased by resistor *Rk*, which must not be bypassed with a capacitor. If the resulting degeneration and loss of gain are to be avoided, the bias may be provided by a battery in the grid circuit.

The plate of the first tube is connected directly to the control grid of the second tube, *B*. Between grid and cathode of this second tube is load resistor or coupling resistor *Rb*. The varying direct potential on the grid of tube *A* causes a varying plate current in resistor *Rb*, and the accompanying variations of poten-

tial across R_b are applied to the control grid of tube B . Although the grid of tube B is at the same potential as the plate of tube A this grid would have a highly negative bias due to the drop of voltage across resistor R_b . This drop of voltage accompanies the plate current for tube A . The polarity is such as to make the grid of tube B negative, as shown on the diagram. Most of the

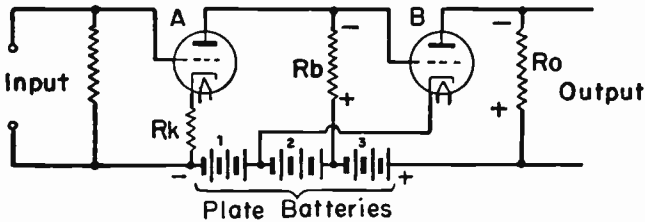

Fig. 19.—An amplifier for direct current or potential.

highly negative bias is balanced out by connecting the cathode of tube B to a point on the battery which is negative with reference to the point where the lower end of R_b is connected. The battery voltage between the two points is somewhat less than the voltage drop across R_b , thus leaving for a negative grid bias on tube B the difference between the voltage across R_b and the voltage of the battery between the intermediate points of connection.

The plate supply voltage for tube A is the voltage of sections 1 and 2 of the battery. The plate supply voltage for tube B is the voltage of sections 2 and 3 of the battery. If the change of input potential is such as to make the grid of tube A less negative, there will be more plate current in this tube and in R_b , and the top of R_b will become more negative. Then the grid of tube B , which is connected to the top of R_b , will become more negative. This change of grid potential will reduce the plate current in tube B and the current in output load resistor R_o . The upper end of R_o is negative with reference to the bottom because of electron flow through it. The change of grid potential and plate current in tube B will make this upper end less negative than before,

which is equivalent to making the end more positive. Thus a more positive, or less negative, potential on the grid of tube A will cause the upper end of the output resistor to become less negative or more positive.

When using a battery power supply and no bypass capacitors or other capacitors anywhere in the amplifier or the power supply, the response will be uniform at even the lowest frequencies. There will be a change of output even with a drift of potential either way in the input. If the B-supply is obtained from the a-c line through a rectifier and filter the response will not be uniform under all conditions.

Wide Band Amplifiers.—In spite of all the difficulties in maintaining satisfactory gains at low frequencies and at high frequencies with resistance coupled amplifiers it is possible to use tubes and construction practices allowing nearly uniform gain all the way from about 30 cycles to more than four megacycles. Such wide band resistance coupled amplifiers are found in the video circuits of television receivers, in many oscilloscopes, and in other applications where tuned amplifiers are not practicable. In addition to providing uniform gain, wide band amplifiers usually are used where there must also be minimum amplitude distortion and minimum phase shift over the range of frequencies to be handled.

As with all resistance coupled amplifiers it is difficult to maintain the gain at high frequencies, because of shunt capacitances. Without any special means of compensating for the capacitance effect it is a general truth that gain is inversely proportional to shunt capacitance; doubling the capacitance halves the gain, and having the capacitance doubles the gain. It is true also, in a general way, that the gain at any frequency is directly proportional to the transconductance of the amplifier tube; gain increases in direct proportion to transconductance.

By using sockets and other parts having low losses at high frequencies, and by placing all wiring and connections to reduce their capacitances as much as possible, we may get the circuit shunting capacitance down as low as 10 mmfd. To this must be added the output capacitance of the amplifier tube and the input capacitance of the following tube. A "figure of merit" for high-frequency amplifier tubes often is arrived at by dividing their

transconductance in micromhos by the sum of their output and input capacitances in mmfd.

This figure of merit may be somewhat misleading, because the input and output capacitances of the same tube are not directly in the coupling circuit. Rather it is the output capacitance of the amplifier, plus the wiring and socket capacitances and the input capacitance of the following tube which affect the coupling. No matter how a tube is rated for high-frequency service the transconductance must be high, usually 3,000 micromhos or more.

All of the tubes used in wide band amplifier stages are pentodes, or, if the tube is a power amplifier, it may be a beam power type. Although the control grid bias may be secured from the plate power supply system, or even by grid rectification, it is recommended for many of the high-frequency tubes that cathode bias be used. The cathode bias resistor usually is bypassed with a capacitor of such large capacitance as to bring the capacitive reactance far below the bias resistance at the lowest frequency to be amplified. Bypasses of several hundred microfarads may be used. If the bias resistor is not bypassed, or if the bypass is of small capacitance, there will be negative feedback or degeneration. While degeneration will make for more uniform response or amplification over the frequency band, it will lower the gain, and usually the gain is none too great at best.

High-frequency Compensation.—The uniformity of the gain is improved by using small values of load resistance, so that the impedance in the plate circuit is not too greatly affected by drop of reactance of the shunting capacitances as the frequency is increased. With tubes having transconductance much less than 3,000 micromhos the small load resistance would allow no gain at all with frequencies even as high as a few megacycles.

Fig. 20 shows one method of continuing the uniform gain into higher frequencies, or even of making the gain at certain high frequencies greater than at the middle frequencies. In series with the load resistor R_b is connected a shunt inductor L_b , which is a coil having an inductance usually somewhat less than 100 microhenrys. The coil is called a shunt inductor because it is in shunt or parallel with the shunt capacitances of the tubes and circuit, although it is in series with the load resistor.

The reactance of the shunt inductor is so small as to have

practically no effect at the middle and low frequencies. But at some relatively high frequency the shunt inductor and the shunt capacitance become resonant. Then, connected to the amplifier plate, we have what amounts to the circuit shown by Fig. 21. The impedance of L_b and C_s in parallel becomes maximum at the resonant frequency. Because resistance R_b is in the resonant circuit the tuning of the circuit is very broad. There is gradually

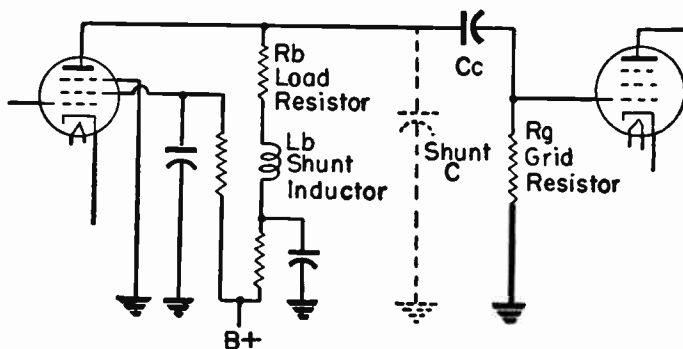

Fig. 20.—High-frequency compensation with resistance coupling.

increasing impedance as the frequency rises toward resonance, then a gradual falling off at still higher frequencies. Whereas the shunt capacitance alone would cause a decreasing impedance with rise of frequency, making this capacitance part of a resonant circuit causes an increase of impedance with rise of frequency.

The inductance of the shunt inductor usually is chosen with reference to the value of shunting capacitance and the value of load resistance, using the following formula.

$$\text{Shunt inductor, microhenrys} = \frac{\text{shunt } C, \text{ mmfd}}{2} \times (\text{load } R/1000)^2$$

As an example, assume that the total shunt capacitance is 40 mmfd and that the load resistance R_b is 2,000 ohms. The formula

says to divide the shunt capacitance by 2, which gives 20. This is multiplied by the square of the load resistance divided by 1,000. Dividing our load resistance by 1,000 gives 2. The square of 2 is 4. Then, multiplying 20 by 4 gives 80 microhenrys as a desirable value for the shunt inductor.

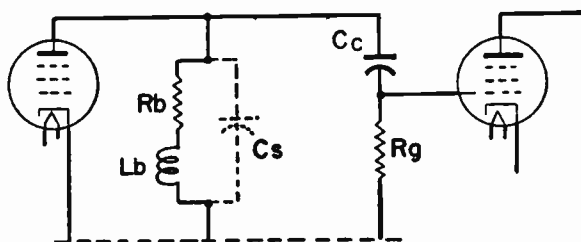

Fig. 21.—The equivalent resonant circuit in the plate load.

The probable value of shunt capacitance may be estimated by adding together the output capacitance of the amplifier tube, the input capacitance of the following tube, and the socket and circuit capacitances. These latter may be taken as from 10 mmfd with all low-loss parts and careful wiring up to 40 or more with ordinary parts and less careful wiring.

The approximately correct load resistance may be found as follows.

$$\text{Load } R, \text{ ohms} = \frac{160\,000}{\text{max. frequency, mc} \times \text{shunt } C, \text{ mmfd}}$$

If the maximum frequency to be satisfactorily amplified is 2.0 megacycles, and the shunt capacitance totals 40 mmfd, we would, according to the formula, multiply 2.0 by 40, giving 80, and then would divide 160,000 by 80 to find that the load resistance should be 2,000 ohms.

In these examples we have a shunt capacitance of 40 mmfd and a shunt inductor of 80 microhenrys. The resonant frequency for this combination is about 2.8 mc. The highest frequency to be satisfactorily amplified was taken as 2.0 mc. When making computations with the two formulas which have been shown,

the highest frequency always will be approximately equal to the resonant frequency divided by 1.4.

Going back to the formula for inductance of the shunt inductor, where the shunt capacitance is divided by 2, the division may be made with any numbers between 1.7 and 2.3 (instead of exactly 2) and the results will be generally satisfactory. Dividing by numbers smaller than 1.7 will result in a peak of amplification at the high frequency, while dividing by numbers larger than 2.3 will bring performance more nearly to that with no shunt inductor at all, but will allow less distortion both from amplitude and phase shift.

A different method of high-frequency compensation is shown by Fig. 22. At the left is the actual circuit, and at the right is the equivalent circuit for the signal potentials at high frequencies. Here there is a series inductor in series with the coupling

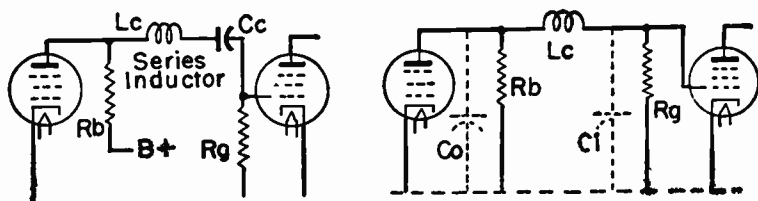

Fig. 22.—Series compensation for high frequencies.

capacitor. This method is called series compensation. The one first described is called shunt compensation. As shown by the right-hand diagram, the series inductor separates the circuit so that the output capacitance C_o of the amplifier tube does not add directly to the input capacitance C_i of the following tube. The high-frequency reactance of coupling capacitor C_c is so small that this capacitor acts like a conductive connection or a short circuit for the signal frequencies. This leaves series inductor L_c in series with the input capacitance of the following tube, while the input capacitance and grid resistor are in parallel with each other.

With series compensation the load resistance usually is made

about 1.5 times the load resistance used with shunt compensation, and the inductance of the series compensating coil is made about 1.33 times as great as the inductance of a shunt compensating coil. These relations assume an unchanged total shunt capacitance. Series compensation gives somewhat greater gain than shunt compensation, and also allows satisfactory amplification at somewhat higher frequencies or over a wider band.

For still further extension of uniform gain into the higher frequencies it is possible to use both shunt and series compensation in the same coupling circuit, as shown by Fig. 23. This arrangement also allows somewhat greater gain than either shunt or series compensation alone. The load resistance usually is made

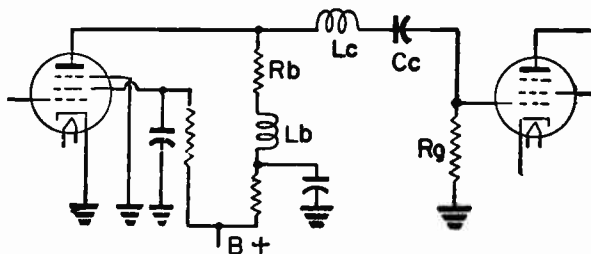

Fig. 23.—Shunt and series compensation in the same coupling.

about 1.8 times as great as the load resistance for shunt compensation alone. The inductance of the shunt inductor, in series with the load resistor, is made about one-fourth as great as that of the shunt inductor used for shunt compensation alone, and the series inductor, in series with the coupling capacitor, is made with inductance about equal to that of the inductor used with shunt compensation alone.

When shunt compensation is used alone, with the inductor in series with the load resistor, a small capacitor sometimes is connected in parallel with the inductor or across the ends of the inductor. Then the inductor and this added capacitor form a small resonant circuit of low resistance or high-Q in series with the load resistor. The effect is to extend the range of uniform frequency response toward higher frequencies. The capacitance of

this parallel capacitor may be from one-fourth to one-third the value of total shunt capacitance. Since the shunt capacitance seldom is known with any great accuracy, the parallel capacitor has been made adjustable in some receivers. An air-dielectric trimmer capacitor giving from 4 to 25 mmfd capacitance, or something in this general range, is suitable.

In talking about the several arrangements of inductors for shunt and series compensation it has been assumed that the inclusion of one or more coils adds nothing but inductance. Actually these coils will have a certain amount of distributed capacitance of their own, and their wiring and connections will have capacitance. It is quite possible to add so much to the total of shunting capacitance by putting in extra parts that there is no net advantage. Unless the highest grades of parts and of mechanical construction can be used, the simpler the compensation method the better the results are likely to be.

Low-frequency Compensation.—In wide band amplifiers it usually is necessary that uniform gain extend down to very low frequencies as well as up to very high ones. Low frequency response is affected by the reactance of the coupling capacitor and by the resistance of the grid resistor. The greater the coupling capacitance and grid resistance the better will be the gain at low frequencies.

Grid resistance, R_g in Fig. 24, is limited by the type of tube. With a few tubes this resistance may be as high as 1.0 megohm, but with most tubes it should not exceed 0.5 megohm, and with some operating conditions has to be limited to 0.25 megohm. Coupling capacitance is limited by the fact that capacitors having large capacitance are large in physical size, and the large size increases the shunting capacitance between the capacitor and surrounding parts. The shunting capacitance must not be unduly increased because of its effect at high frequencies. In actual constructions we seldom find coupling capacitances greater than 0.1 mfd.

With grid resistors and coupling capacitors as large as mentioned the gain of a resistance coupled stage will depend almost wholly on the transconductance of the tube and the effective impedance in the plate circuit. At low frequencies the effective impedance is practically equal to the plate load resistance, be-

cause the shunting capacitances have negligible effect. At a frequency of 20 cycles there will be a drop of only about two per cent in gain.

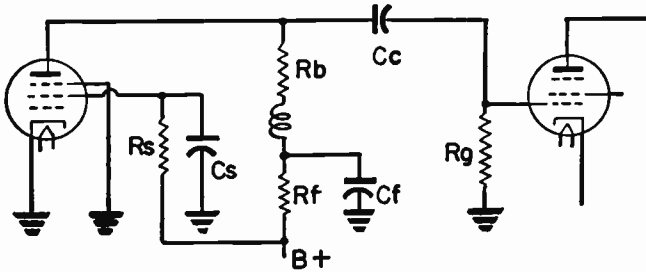

Fig. 24.—Plate circuit filter for low-frequency compensation.

As the frequency decreases there is an increasing phase displacement or time displacement, meaning that low frequency portions of a signal are held back in the amplifier more than are higher frequency portions. At 100 cycles the displacement is less than two degrees, but every time the frequency is halved the phase displacement doubles. This phase displacement is of little or no importance in amplifiers for sound, because at frequencies ordinarily audible there is but little phase displacement and because we do not notice a moderate displacement in sounds. But in television video reproduction and in many measurements made with oscilloscopes and other instruments any great phase shift is highly objectionable.

Phase shift is lessened by connecting into the plate load circuit the filter consisting of resistor R_f and bypass capacitor C_f of Fig. 24. If the product of megohms of resistance in R_f and microfarads of capacitance in C_f is equal to the product of megohms of resistance in grid resistor R_g and microfarads of capacitance in coupling capacitor C_c the phase shift is almost completely corrected so far as the effects of coupling capacitance and grid resistance are concerned.

To prevent feedback couplings which may cause low-frequency oscillations in the amplifier stage it is necessary to have highly

efficient decoupling in the leads from the B-power supply to the several stages. Decoupling capacitors of 250 to 1,000 microfarads capacitance often are required. It is necessary also to effectively bypass the screen series resistor, R_s in Fig. 24, with a capacitor at C_s . This bypass usually is made of 8 microfarads or greater capacitance.

REVIEW QUESTIONS

1. Does an increase of load resistance improve the low frequency response or the overall gain?
2. What effect has an increase of coupling capacitance on (a) low frequency response, (b) high frequency response?
3. Is gain at all frequencies made more nearly uniform by using large or small grid resistance?
4. In what way, if any, is shunt capacitance affected by using a large or small coupling capacitor?
5. Does shunt capacitance have its greatest effect at low, middle, or high frequencies?
6. Will there be greatest gain when using no bypass capacitor on a bias resistor, when using a small capacitance, or when using a very large capacitance?
7. Would you expect to find greatest gain, in an ordinary audio amplifier, at 50 cycles, 500 cycles, or 5,000 cycles?
8. Is high-frequency compensation applied in the plate circuit of the first tube or in the grid circuit of the following tube?

Chapter 2

POWER AMPLIFIERS

The power amplifier of a radio or television set consists of the stage of audio-frequency amplification whose output feeds the loud speaker or speakers, and whose input comes from a preceding a-f voltage amplifying stage, or, sometimes, directly from the detector. The amplifying tubes employed are called power tubes to distinguish them from voltage amplifying tubes and other types used in preceding stages. There are three general classes of power tubes; power triodes, power pentodes, and beam power tubes. In comparison with voltage amplifying tubes the power tubes operate with greater plate currents, with grid biases which are more negative, they have smaller internal plate resistances, and relatively low amplification factors. This does not mean that power tubes have low mutual conductances or transconductances, for this characteristic is high in all power tubes.

Power pentodes and beam power tubes give greater power outputs than triodes when operating conditions, such as voltages, are the same. Pentodes and beam power tubes also give more output with a given strength of input signal than do triodes. However, power triodes inherently cause less distortion than pentodes and beam power tubes.

Practically all present-day battery operated power tubes are pentodes or beam power tubes. They are designed for maximum plate voltages of 90 or 135 in most cases. Pentodes designed for 90 volts on the plate have transconductances from 800 to 2,000 micromhos and power outputs from 0.10 to 0.25 watt on the average; while pentodes designed for 135 plate volts have about the same range of transconductances but have outputs of 0.30 to 0.60 watt. Various battery operated beam power tubes are designed for operation with from 67.5 to 135 volts on their plates, with transconductances between 1,500 and 2,500 micromhos and power outputs of from 0.15 to 0.50 watt.

In the larger power tubes having heater-cathodes and a-c operated filament-cathodes we have triodes with mutual conduct-

ances from 1,500 to more than 5,000 micromhos with power outputs from one to nearly four watts. Beam power types have transconductances from 4,000 to 9,000 micromhos and power outputs up to six or seven watts. Triodes, pentodes, and some beam power tubes are operated with plate voltages between 250 and 350, but many of the beam power tubes are designed for high

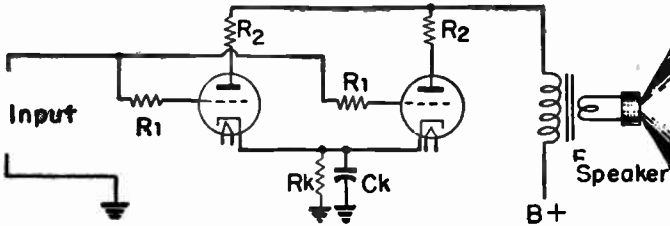

Fig. 1.—Two power tubes connected in parallel.

power output with plate voltages as low as 100 for use in transformer-less ac-dc receivers and amplifiers.

Parallel Power Tubes.—When it is desired to have greater power output than may be obtained from a single tube of types such as generally found in receivers it is possible to connect two or more power tubes in parallel as shown in principle by Fig. 1.

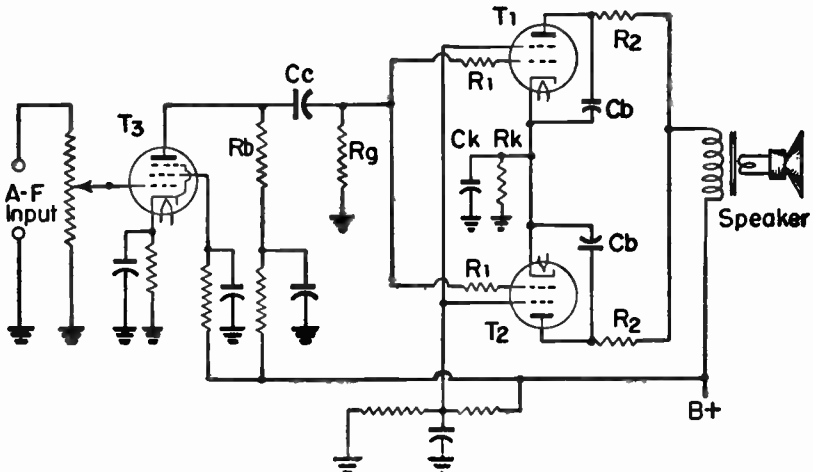

Fig. 2.—Two-stage amplifier with parallel power tubes for output.

The input signal is fed to the two control grids through resistors $R1$. The two plates are connected through resistors $R2$ to one end of the output transformer primary winding. The two cathodes are connected together and through the cathode-bias resistor Rk to ground. Capacitor Ck is the bypass for Rk . Resistors $R1$ and $R2$, usually of 150 ohms or less resistance, are used to help divide the signal and the load equally between the tubes. These resistors help also to prevent oscillation which might result from power transfer or feedback between the tubes.

With parallel power tubes the total power output is practically as much as the output from a single tube multiplied by the number of tubes in parallel. No greater input signal potential is required than for a single similar tube. If the output power is no more than that of one tube multiplied by the number of tubes the harmonic distortion will be no greater and may be somewhat less than with a single tube. The total plate current is equal to the normal plate current for a single tube multiplied by the number of tubes. If the tubes are pentodes or beam power tubes the total screen current is likewise that for one tube multiplied by the number of tubes. The load resistance or impedance in the plate circuit is to be made half of that used for a single similar tube.

Fig. 2 shows connections as actually used in a parallel power amplifier which includes beam power tubes $T1$ and $T2$, fed from a-f amplifier pentode $T3$. Coupling from the plate of $T3$ to the control grids of $T1$ and $T2$ is through the system consisting of plate load resistor Rb , coupling capacitor Cc , and grid resistor Rg . This is an ordinary resistance coupled arrangement. Between Rb and the B+ line, also between the screen of $T3$ and the B+ line, are decoupling resistors with bypass capacitors. Signal voltage developed across Rg is fed to the power tube grids through series resistors $R1$. The output signal from the power tube plates goes through series resistors $R2$ to the upper end of the primary of the speaker coupling transformer. Both power tubes are cathode-biased by resistor Rk and bypass capacitor Ck . Capacitors Cb are bypasses for frequencies higher than audio frequency which may appear in the plate circuits and cause loss of power output. These bypasses have capacitances in the neighborhood of 0.005 mfd each.

Push-pull Amplifiers.—A method of combining the outputs of two power tubes and at the same time reducing certain kinds of distortion and other common operating difficulties is called push-pull amplification. The elementary principle of the push-pull connection is shown by Fig. 3. Transformer couplings are shown here because they simplify the explanation. Resistance coupling to the power tube grids may be used with connections to be discussed later in this chapter.

The input transformer has a center-tapped secondary winding. During one half-cycle of applied signal input the upper end of the secondary will become positive and the lower end negative with reference to the center tap. Since the center tap is connected to the cathodes of both tubes, the result is to make the control grid of one tube less negative while the other grid is being made more negative. The opposite changes of grid potentials cause more electron flow or current in the plate circuit of one tube, while causing less flow in the plate circuit of the other tube. Then

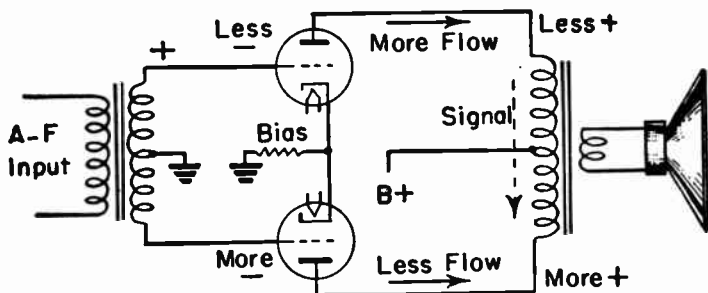

Fig. 3.—Signal potentials combine in the output for push-pull connections.

the plate of one tube, and the end of the output transformer primary to which it is connected, will become less positive while the plate of the other tube and its end of the primary become more positive. With the upper end of the primary becoming less positive, and the lower end becoming more positive at the same time, there is a change of signal current in the primary as shown by the broken-line arrow.

The signal change acts in the same direction through both halves of the primary winding of the output transformer. In each half is developed a signal potential equal to the output from one

tube. In the two halves the signal strength is the combination of the outputs from the two tubes, and is approximately twice the strength of the signal from one tube alone. Now we have combined the outputs of both power tubes into a single signal output for the loud speaker. This, however, is not the principal reason for using the push-pull connection, for the outputs might be combined more simply with a parallel connection.

The principal reasons for employing the push-pull system may be explained with the help of Fig. 4. Here the directions of electron flow from the plate power supply are shown by arrows. The electron flows are opposite in the two halves of the primary winding of the output transformer. Each of these average electron flows cancels the effect of the other so far as magnetizing the transformer core is concerned. No matter what changes occur in the rates of electron flow through the two halves they will induce no potentials in the secondary of the transformer so long as the changes are equal in the plate circuits of the two tubes.

This cancellation of effects of opposite current changes in the output primary results in a number of advantages. For one thing, hum voltages or ripple voltages from the power supply have little

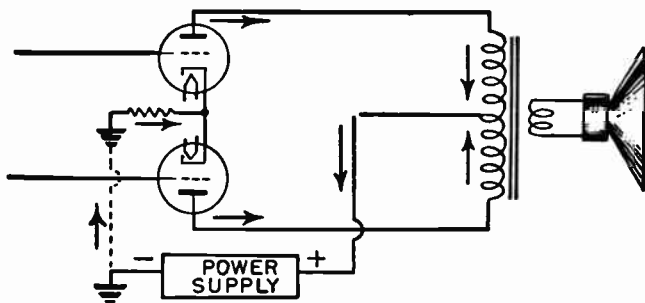

Fig. 4.—Direct currents oppose in the output for push-pull connections.

effect, since they act oppositely in the plate circuits for both tubes. Then we may use a power supply with poorer voltage regulation and with less filtering in the B+ line going to the output transformer and also in the line to screen grids. Quite often the B+ tap for the power tube circuits may be taken from a point in the power supply filter nearer the rectifier tube than

the take-off for the B-supply to other tubes. At such a point the voltage is higher than after the flow has gone on through additional chokes or filter resistors, and we do not have to have such high rectified voltage from the rectifier tube as when more filtering is needed.

There is also cancellation of the effects of sudden and brief fluctuations of supply line voltage. Hum potentials and other interference picked up in grid, screen and plate wiring will be nullified if the pickup is equal in the circuits for both power tubes. It should be mentioned also that because of the cancellation of d-c magnetization in the output transformer this unit may be constructed with a smaller core than where plate current flows only in one direction in the whole primary winding.

The advantage most often mentioned in connection with the push-pull system is the possible great reduction of distortion due to second harmonics and other even harmonics. If a tube is

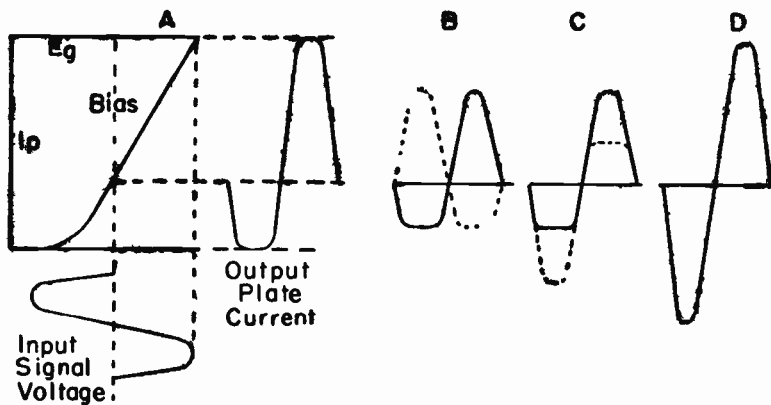

Fig. 5.—Two distorted waveforms combine into one which is undistorted.

operated with an input signal too great for the grid bias, or too great to be handled on the straight portion of the grid-voltage plate-current characteristic, as at A in Fig. 5, the plate current will not follow the grid signal in form. There will be distortion of amplitude. When there is such distortion the output does not consist of a single frequency but of a fundamental frequency accompanied by harmonic frequencies.

Diagram A shows the output of one tube. But in the push-pull system there are two tubes, with the output of one having polarity which is the opposite of that in the other output. Then we have two outputs, as at B. As was shown in Fig. 3 the two outputs are combined in the transformer primary to make a single signal acting in one direction. This reversal of one signal with reference to the other may be shown as at C in Fig. 5. Here, in the first half-cycle, there are two potentials which have amplitudes just like the amplitudes of the two potentials in the second half-cycle. The two unequal potentials combine, as at D, to produce in each half-cycle an amplitude equal to the amplitude in the other half-cycle. Thus the amplitude distortion disappears in the output to the loud speaker.

Fig. 6 shows some of the effects of combining even harmonics such as the second, and odd harmonics such as the third, with the fundamental waveform. The fundamental waveform is shown at the upper left. It is approximately a sine wave. Next toward the right is shown the waveform of the second harmonic, having twice the frequency of the fundamental. Next is shown the waveform produced when the fundamental and second harmonic act together. The effect of combining the first and second half-cycles in the push-pull output is shown at the upper right. The first

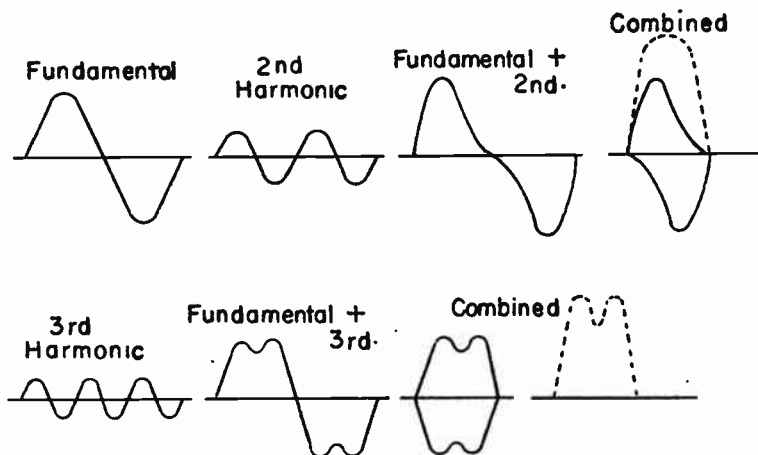

Fig. 6.—Effects of even and odd harmonics in the push-pull output.

half-cycle from one tube occurs with the second half-cycle from the other tube, just as though the second half-cycle were moved underneath the first half-cycle. The combination is shown by the broken-line curve for one of the resulting half-cycles. Other half-cycles would be of the same form, approximately sine-wave, or like the fundamental with the effects of the second harmonic eliminated. The fourth, sixth, and any other even harmonics produce similar results, and their effects are eliminated when the amplifier is operated with suitable signals and biases.

In the lower part of Fig. 6 are shown effects of a third harmonic. The effects of any other odd harmonics would be similar. At the left is shown the third harmonic waveform, with three times the fundamental frequency. When the fundamental and third harmonic act together in the same circuit the combined wave is shown by the next diagram toward the right. If the positive and negative half-cycles are placed one above the other, as in the next diagram, one is a mirror of the other. That is, if the waveforms were folded together on the central zero amplitude line they would match. This is a characteristic of all combinations of a fundamental frequency with its odd harmonics. When the two half-cycles are combined in the push-pull output we have a waveform for one half-cycle such as shown by the broken-line curve at the right. The amplitude is greater, but all the distortion still remains. The combined waveform is similar to either of the half-cycles, and is not of the same form as the fundamental. Thus we see that odd harmonics are not canceled in the push-pull output.

Phase Inverters.—In most of the push-pull amplifiers now used in receivers, phonograph reproducers, and public address systems of moderate power output the coupling between the a-f amplifier tube and the grids of the push-pull tubes is of the resistance-capacitance type rather than of the transformer type. In a resistance coupled amplifier it is necessary to invert the phase, or reverse the polarity, of the input to one push-pull grid. With an input transformer, as shown by Fig. 3, this inversion is accomplished by connecting the power tube grids to opposite ends of the center-tapped secondary winding of the input transformer. As one power tube grid is made less negative the other one is made more negative. and vice versa.

To accomplish the necessary phase inversion with resistance coupling it is usual practice to use an additional triode tube, which is called the phase inverter. In the inverter circuit one grid signal is placed 180° out of phase with the other grid signal, and is maintained of the same amplitude or potential as the other signal.

Fig. 7 shows the principle of a type of inverter which is in general use. The push-pull power tubes are $T1$ and $T2$. Their cathodes are connected together and through a bias resistor to ground. Their plates are connected to opposite ends of the primary winding of the speaker coupling transformer.

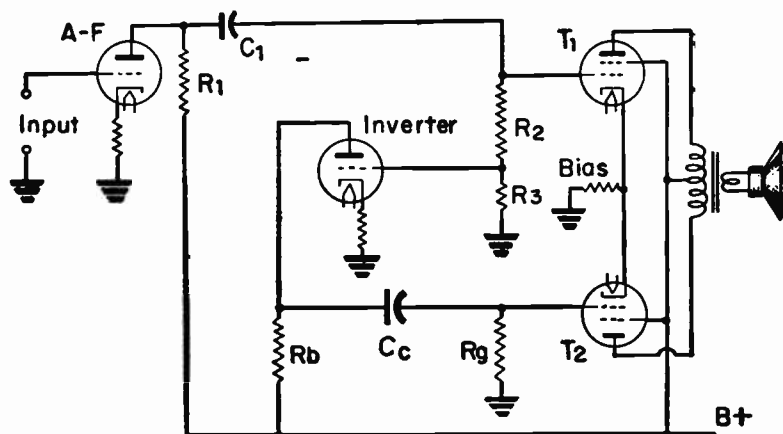

Fig. 7.—One kind of phase inversion circuit for a push-pull amplifier.

mary winding of the speaker coupling transformer. Signal input is to the grid of the a-f triode amplifier at the upper left. The output of the a-f amplifier tube is coupled to the control grid of power tube $T1$ by resistance coupling. For this coupling $R1$ is the load resistor in the plate circuit and $C1$ is the coupling capacitor. The output signal from the a-f amplifier appears across the grid resistor which is between the control grid of $T1$ and ground. This grid resistor consists of two parts, $R2$ and $R3$.

The entire signal potential for the grid of $T1$ appears between the top of resistor $R2$ and the bottom of resistor $R3$, which is grounded. Part of the signal potential is across $R2$ and the remainder across $R3$. Because the resistance of $R2$ is much greater than that of $R3$, only a small fraction of the whole signal poten-

tial is across R_3 . The top of R_3 is connected to the grid of the inverter tube, and the bottom is connected to the inverter cathode. Therefore, the fraction of the signal which appears across R_3 is applied to the grid of the inverter.

The plate of the inverter tube is resistance coupled to the control grid of power tube T_2 . In this coupling R_b is the load resistor in the plate circuit, C_c is the coupling capacitor, and R_g is the grid resistor which is between the control grid of the power tube and ground. The small fraction of the signal from the a-f amplifier which is across R_3 is amplified by the inverter and applied to the grid of power tube T_2 . The entire output signal from the a-f amplifier is applied to the grid of power tube T_1 .

Fig. 8 shows how phase inversion takes place. Consider a half-cycle of input signal during which the grid of the a-f amplifier is made less negative, which is equivalent to more positive. This will increase the plate current, which is also the current through load resistor R_1 . Since the B-supply voltage (B+ in the diagram) remains nearly constant the result of more current in R_1 will be more voltage drop across R_1 . The upper end of R_1 , and the plate of the a-f amplifier, then become less positive than before, because more of the supply voltage is being used up in R_1 .

The upper end of R_1 and the plate of the a-f amplifier are connected through capacitor C_1 to the control grid of power tube T_1 . Consequently this grid follows the voltage changes of the a-f amplifier plate and becomes likewise less positive, which is

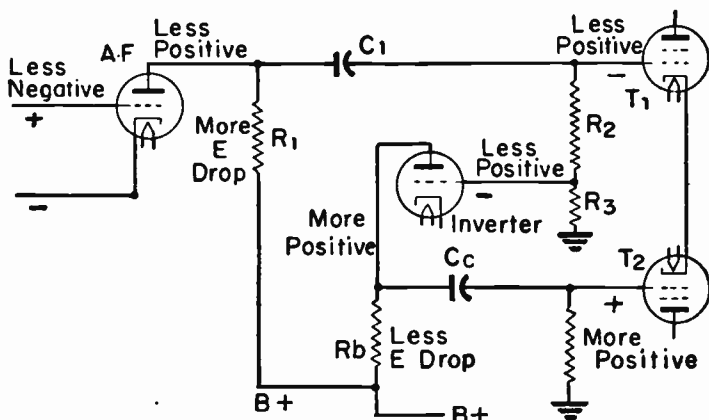

Fig. 8.—How phase inversion is brought about.

equivalent to becoming more negative. When the potential at the top of R_2 becomes less positive the potential at the top of R_3 also must become less positive, although in lesser degree. The top of R_3 is connected to the grid of the inverter, so this grid must become less positive, or more negative, than before.

When the grid of the inverter becomes less positive, or more negative, there will be a reduction of plate current in this tube. The plate current flows in resistor R_b . Less current in R_b means less voltage drop in this resistor. With a smaller drop of voltage in R_b , and with the $B+$ supply voltage remaining practically unchanged, the top of R_b must become more positive, or more nearly of the same voltage as the B -supply line. The top of R_b is connected through capacitor C_c to the control grid of power tube T_2 . Therefore, the control grid of T_2 becomes more positive, or less negative.

Now we have seen that the half-cycle of signal applied to the grid of the a-f amplifier causes the control grid of power tube T_1 to become less positive while causing the control grid of T_2 to become more positive. There is phase inversion between the power tube control grids. This is just what happens also with the input transformer arrangement of Fig. 3. On the following half-cycle of input signal all of the potential changes will be reversed, and while the control grid of T_1 is becoming more positive the control grid of T_2 will become less positive. It must be kept in mind that when we say a grid becomes less positive, the word positive is used merely to simplify the explanation. Since the grids are maintained at negative potential by their bias, they really become more negative. The explanation made with reference to Fig. 8 ignores the effects of grid bias and considers only the effects of signal potentials.

Fig. 9 shows how the signal strengths or amplitudes are made equal at the control grids of the two push-pull power tubes when an inverter tube is used. We shall assume that the output from the a-f amplifier tube is such as to apply a 20-volt signal to the control grid of power tube T_1 . We shall assume also that the total resistance of the grid resistor for this power tube is to be 500,000 ohms. This will be the resistance of R_2 and R_3 in series. Our final assumption is that the voltage gain of the inverter stage is 10. This means that the output voltage from the in-

verter, applied to the grid of power tube T_2 , will be 10 times the input voltage applied to the grid of the inverter.

Since we have a 20-volt signal at the grid of power tube T_1 we wish to have an equal 20-volt signal at the grid of power tube T_2 . Then the output of the inverter is to be 20 volts of signal potential. With a gain of 10 in the inverter stage the input to the inverter must be 2 volts in order to have a 20-volt output. This

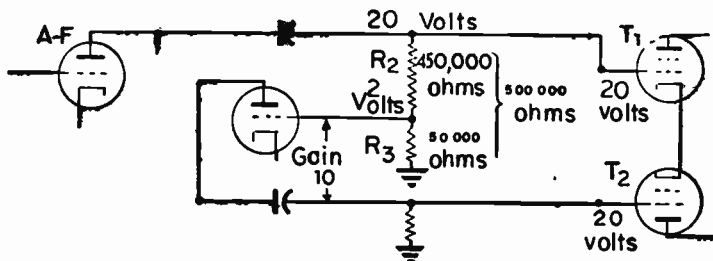

Fig. 9.—How equal signal voltages are applied to both power tubes.

means that the signal potential across resistor R_3 , which is the potential on the inverter grid, must be 2 volts. The 2-volt signal required across R_3 is 1/10 of the 20-volt signal across R_2 and R_3 in series. Consequently, the resistance of R_3 must be 1/10 the resistance of R_2 and R_3 in series. The total resistance of R_2 and R_3 is 500,000 ohms, of which 1/10 is equal to 50,000 ohms, the resistance required in R_3 . This leaves the resistance of R_2 as the difference between 500,000 and 50,000 ohms, or 450,000 ohms.

In any case, dividing the sum of the resistances of R_2 and R_3 by the voltage gain in the converter stage will give the resistance required in R_3 . Then whatever signal voltage is applied to the control grid of one power tube will be applied to the grid of the other power tube.

We seldom will know the exact voltage gain of the inverter stage until the stage is constructed, is in operation, and the gain is measured. Furthermore, in order that the two power tubes may have exactly equal outputs it will be necessary to apply slightly different signal strengths to their control grids unless the two tubes are exactly alike in performance. Two tubes of the same make and type usually will have slight differences in plate cur-

rents, screen currents, and transconductances, even when operated with equal voltages. For all these reasons it would seem desirable to be able to vary the resistance of R_3 until the outputs of the two power tubes were made equal. When an amplifier first is designed or constructed it really is necessary to make some experiments with the value of resistor R_3 , but this resistor need not be adjustable in the final construction. Even though a precise balance of power tube outputs were attained, this balance would be upset by replacement of one or both power tubes, or by replacement of the inverter tube. Also, as the tubes age in operation their characteristics change, and the changes seldom will be equal or equalizing in all the tubes of the amplifier.

Although the a-f amplifier and the phase inverter may be separate tubes as shown in preceding diagrams, the two more often are combined in a twin-triode tube. Such an arrangement is shown by Fig. 10 where the left-hand section of the twin-triode acts as the a-f amplifier and the right-hand section as the inverter. Otherwise the circuit is practically the same as those which have already been explained. The capacitors C_c couple the a-f amplifier plate and the inverter plate to the control grids of the power tubes. The capacitors between the a-f plate and ground, and between the inverter plate and cathode, are for getting rid of high frequencies which are above audibility, but which cause loss of power and sometimes cause oscillation. Resistors R_2 , R_3 and R_g serve the same purposes as similarly identified resistors in preceding diagrams. The bias resistor for the power

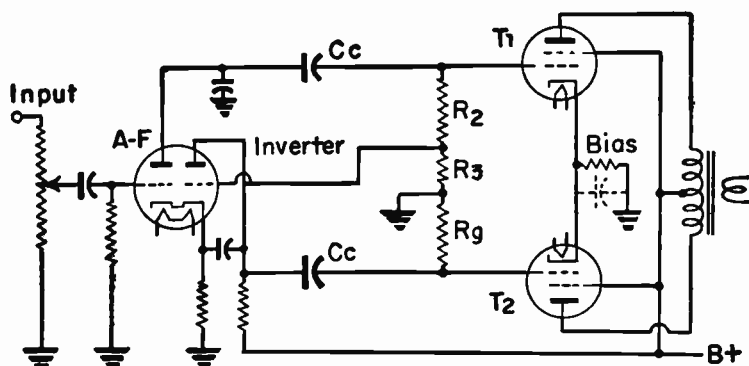

Fig. 10.—Connections for a typical push-pull amplifier with phase inverter.

tube cathodes may or may not be bypassed with a capacitor. Usually there is no cathode bypass. The output is through a transformer to the loud speaker. The input to the a-f amplifier tube ordinarily will be from the volume control potentiometer as indicated in the diagram.

Other Inverter Circuits.—Although the inverter circuit which has been described is in quite general use there are many other inverter arrangements used as commonly, or possibly more so. A few of these other circuits will be shown and described.

In Fig. 11 the connections of the resistors in the grid circuits of the power tubes and inverter tube is different than in preceding circuits. The grid circuit resistance for power tube $T1$ consists of resistors $R2$ and $R3$ in series. The grid circuit resistance for power tube $T2$ consists of resistors $R1$ and $R3$ in series. Resistor $R3$ is in both power tube grid circuits. It is the signal voltage across $R3$ which is applied to the grid of the inverter, because one end of $R3$ is connected to the inverter grid and the other end is connected through ground to the inverter cathode. The resistances at $R1$ and $R2$ may be alike, usually between 0.25 and 0.50 megohm each, or the resistance of $R2$ may be somewhat less than that of $R1$. The resistance of $R3$ will be less than either of the others, in proportion to the gain in the inverter stage.

The signal voltages on the power tube grids are, of course, in opposite phase or polarity. Then the signal voltage from the grid of $T1$, acting through $R2$ and $R3$, is in one direction or polarity while the signal voltage from the grid of $T2$, acting through $R1$ and $R3$ is of opposite polarity. These signal voltages are in op-

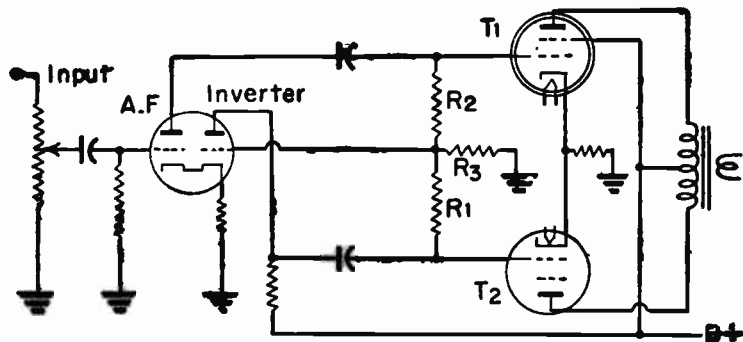

Fig. 11.—A modification of the phase inversion principle.

posite polarities or phase in $R3$ at any given time. It is the slight difference between them which excites the grid of the inverter. If voltage from the inverter to the grid of $T2$ tends to become too great, it is opposed by the voltage increase across $R3$. This opposition occurs because the voltage from the plate of the inverter is in opposite phase to the voltage at the inverter grid.

In Fig. 12 the grid of the inverter tube is fed from a take-off on a voltage divider consisting of resistors $R4$ and $R5$. The a-f signal comes to the top of this voltage divider through capacitor Cd , being taken from the line running from the plate of the a-f amplifier tube to the control grid of power tube $T1$. Thus the signal voltage applied to the converter grid is in phase with the signal voltage going to the grid of $T1$. The phase is inverted in the inverter tube, and from the plate of the inverter the opposite-phase signal goes to the control grid of power tube $T2$ just as in other circuits.

The ratio of the series resistance of $R4$ and $R5$ to the resistance of $R5$ alone is made equal to the gain of the inverter stage, or approximately so. That is, the resistances of $R4$ and $R5$ in Fig. 12 are arrived at in the same way used for determining the resistances of $R2$ and $R3$ in Fig. 9. The greater the gain of the inverter stage the smaller must be the resistance of $R5$ in comparison with the total series resistance of $R4$ and $R5$. Of course, there is some loss of signal voltage due to the reactance of capacitor Cd . This loss is compensated for by altering the ratio of resistances in the voltage divider, thus raising the inverter output to make up for any loss which occurs. The only function of

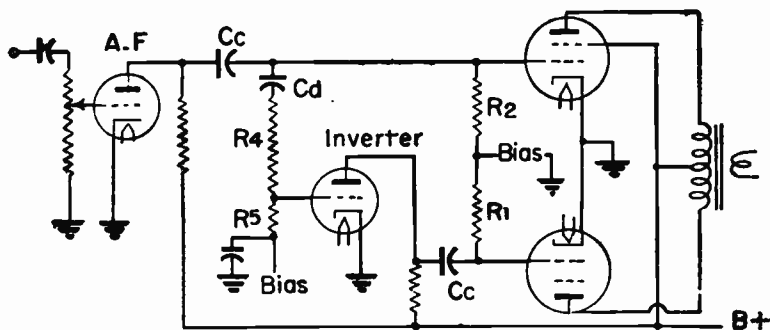

Fig. 12.—Inverter tube fed from a separate voltage divider.

resistors $R1$ and $R2$ in this circuit is to act as grid resistors for the two power tubes.

In Fig. 13 the inverter tube furnishes signal potentials for the grids of both power tubes. The signal voltage for the control grid of power tube $T1$ is taken from the inverter plate circuit in the usual manner, while the signal voltage for the control grid of power tube $T2$ is taken from the cathode circuit of the inverter.

The signal voltage which is applied to the grid circuit of power tube $T1$ is the voltage developed in resistor Rb in the plate circuit of the inverter. The signal voltage across Rb is applied to this power tube because the top of Rb is connected through capacitor Cc to the power tube grid, and the bottom of Rb is connected through a capacitor and ground to the cathode of the power tube.

The signal voltage which is applied to the grid circuit of power tube $T2$ is the voltage developed across resistors $R4$ and $R5$ in series in the cathode lead of the inverter. The top of $R4$ is connected through capacitor Cc to the power tube grid, while the bottom of $R5$ is connected through ground to the power tube cathode.

The same plate current and signal current which flows in resistor Rb flows also in resistors $R4$ and $R5$. Then if the resistance of $R4$ and $R5$ in series is made equal to or approximately equal to the resistance of Rb there will be signal potential across $R4$ and $R5$ equal to the signal potential across Rb . Then the grids of the two power tubes will receive signals of equal amplitude or potential.

Electron flow in resistor Rb is from top to bottom, because

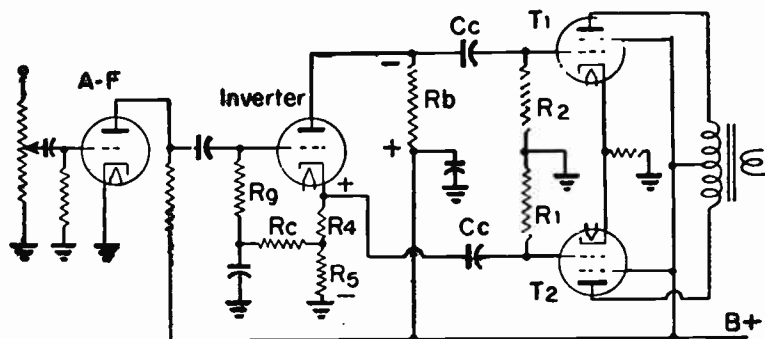

Fig. 13.—An inverter with outputs from its plate and cathode circuits.

electrons come out of the plate of the inverter. Then the top of R_b is negative with reference to the bottom. Electron flow in resistors R_4 and R_5 is from bottom to top, because electrons flow toward the cathode of the inverter. Thus the top of R_4 is positive with reference to the bottom of R_5 . An increase of signal current or plate current will make the top of R_b and the connected grid of T_1 become more negative. The same increase of current will make the top of R_4 and the connected grid of T_2 become more positive, or less negative. The control grid of T_1 becomes more negative while the control grid of T_2 becomes less negative, and we have phase inversion with reference to the power tubes.

Resistor R_4 of Fig. 13 is the cathode-bias resistor for the inverter tube. The grid of this tube is connected through resistors R_g and R_c to the bottom of R_4 . Since the bottom of R_4 is negative with reference to its top, the negative grid bias is equal to the potential drop across R_4 . The resistance of R_g and R_c is very high, usually around 0.5 to 1.0 megohm, while the combined resistances of R_4 and R_5 usually are in the neighborhood of 20,000 ohms.

Power Tube Biasing.—Power tubes usually are biased by means of a resistor in the cathode line, which is self-bias or cathode-bias, rather than being biased by connection of their grid resistor to a negative point on the d-c plate supply. With cathode bias it is permissible, with most power tubes, to use much greater resistance in the grid circuit than the fixed bias. The ratio of permissible maximum grid circuit resistances is from 2.5 to 1 up to 50 to 1. For instance, the grid circuit resistance or grid resistor with cathode-bias on a typical power tube may be as great as 500,000 ohms, while with fixed bias on the same tube it may be no more than 50,000 ohms. Higher values of grid resistor allow greater stage gain.

Filament-cathode types of power tubes are provided with cathode-bias by using a center-tapped resistor across the filament voltage source, with the bias resistor connected to the tap. Cathode-bias is of especial advantage with battery operated tubes because the bias becomes less negative with decreasing plate and screen current due to weakening of the batteries. The less negative bias allows more plate current at the lower battery voltage, and longer life is secured from the batteries.

The cathode bias resistor for two tubes in push-pull has resistance equal to one-half that used for a single similar tube with the same plate voltage, screen voltage, and grid bias. If the push-pull tubes are operated with such negative grid bias and limiting of input signal amplitude that the control grid never becomes positive, and so that operation is on the straight portion of the characteristic curve, the cathode-bias resistor need not be bypassed with a capacitor. Under such operating conditions the fluctuations of current in the plate circuits are balanced out in the output transformer. It is such fluctuations which require a bypass if degeneration is to be avoided. Of course, if there is hum or other disturbances which is eliminated by a bypass, then the bypass should be used.

Output Transformer.—With the output transformer of Fig. 14 each half of the center-tapped primary winding has a number of turns represented by N_p . The secondary winding has a number of turns represented by N_s . Across the secondary is a load resistance or impedance R_o which usually would be the resistance or impedance of the voice coil in the loud speaker. The total resistance or impedance, plate to plate of the power tubes, is represented as R_{pp} .

The turns ratio of the transformer usually is considered as the ratio N_p/N_s , which is the ratio of the number of turns in either half of the primary to the number of turns in the secondary. The turns ratio is related to the plate-to-plate resistance and load resistance as follows.

$$N_p / N_s = \frac{1}{2} \sqrt{R_{pp} / R_o}$$

The turns ratio, primary to secondary, is equal to one-half the square root of the number found from dividing the plate-to-plate resistance by the load resistance. If we require a plate-to-plate resistance of 10,000 ohms and have a load resistance or voice coil resistance of 8 ohms the ratio of turns would be,

$$\begin{aligned} N_p / N_s &= \frac{1}{2} \sqrt{10000 / 8} = \frac{1}{2} \sqrt{1250} \\ &= \frac{1}{2} \times 35.4 = 17.7 \end{aligned}$$

Then the number of turns in each half of the primary winding should be 17.7 times the number of turns in the entire secondary, or, the number of turns in the secondary should be the number in half the primary divided by 17.7. Listing of characteristics and

typical operating conditions for power tubes in push-pull circuits include the plate-to-plate resistances which are desirable with various plate voltages, screen voltages, and control grid biases.

Output transformers designed especially for replacements in service work may have center-tapped primaries with other taps

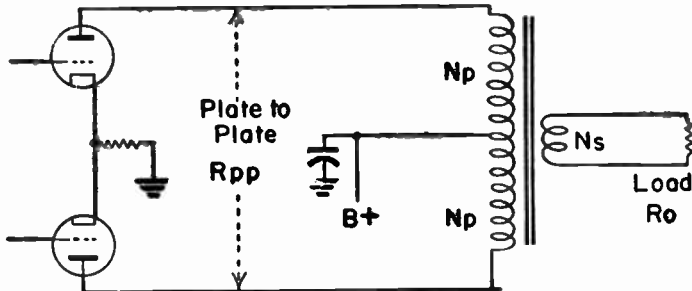

Fig. 14.—Connections to the primary of the output transformer.

equally spaced from the center to permit their use with various tubes. In addition, the secondary winding may have tap connections suited to various load or voice coil resistances. These are called universal output transformers.

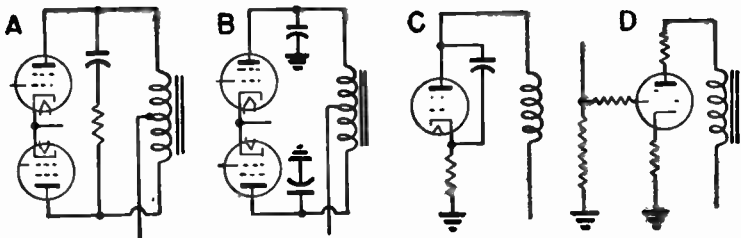

Fig. 15.—Methods of suppressing high-frequency oscillation.

Power Stage Oscillation.—Oscillating currents which have frequencies far above audibility may be generated in the power stage due to capacitances in tubes and wiring and to inductances in the wiring. The power to maintain these oscillations is taken from the output power and reduces the audible output while making for poor tone quality.

Some methods of preventing power stage high-frequency oscil-

lation are shown by Fig. 15. At *A* there is a capacitor, usually of 0.002 to 0.005 mfd capacitance, across the output of push-pull power tubes. A resistor may or may not be placed in series with the capacitor. At *B* there are separate capacitors, of about the mentioned capacitances, from the plate of each power tube to ground. At *C* there is a capacitor between the power tube and its cathode. This capacitance may be about 0.01 mfd. At *D* there are resistors of a few hundred ohms directly in series with the grid and the plate of a power tube. Either or both may be used. These resistors should be placed right at the power tube socket. All resistors used for suppression of oscillation should be of non-inductive types, usually carbon.

Any kind of degenerative feedback tends to suppress power stage oscillation because the oscillating currents tend to cancel themselves. The connection at *C* of Fig. 15 is a type of degenerative feedback, since the signal potential at the top of the cathode resistor is out of phase with the potential at the plate.

REVIEW QUESTIONS

1. What is the power output from two tubes in parallel, as compared with that from a single similar tube operated with equal voltages?
2. Which acts in the same direction in both primary windings of a push-pull output transformer, (a) direct current from the power supply, or (b) changes of signal current?
3. Would greater hum result from ripple voltage in the power supply when using a push-pull amplifier or a single power tube?
4. Which of the following harmonics would be more greatly reduced in a push-pull amplifier: 2nd, 3rd, 4th, 5th?
5. Why is a phase inverter not required in a transformer coupled push-pull amplifier?
6. Can a single tube be used as a phase inverter, or must there always be two tubes or a twin tube which is the equivalent of two tubes?
7. Do power tubes usually have cathode bias or fixed bias?
8. Between what points might a capacitor be connected to prevent oscillation in the power stage? What capacitance should be used here?

Chapter 3

POWER AMPLIFIER PERFORMANCE

The performance of power amplifiers depends not only on the type of tube or tubes, and on whether there is a single tube or two or more in parallel or push-pull. The performance is affected also by the means employed for reduction or elimination of distortion, and by the relative values of maximum signal voltage and control grid bias. The more important of these performance factors will be discussed in this chapter.

Degeneration in Power Amplifiers. — Degeneration means a feedback of energy from the output to the input of an amplifier tube, with the feedback in such polarity or phase relation as to oppose the normal input signal. The principle is shown by Fig. 1. In the output of the power tube a strong voltage is represented by a sine wave of considerable amplitude. Through any one of various types of feedback circuits, indicated in a general way by the broken line connection, a small fraction of this output voltage is allowed to act. This feedback voltage has the same phase as the phase of the power tube output.

From the a-f amplifier tube at the left is coming a signal voltage represented by a sinewave of moderate amplitude. The signal voltage and feedback voltage act together in the coupling between the a-f amplifier and the power tube. The two voltages are of opposite phase. This is because there is phase inversion in the

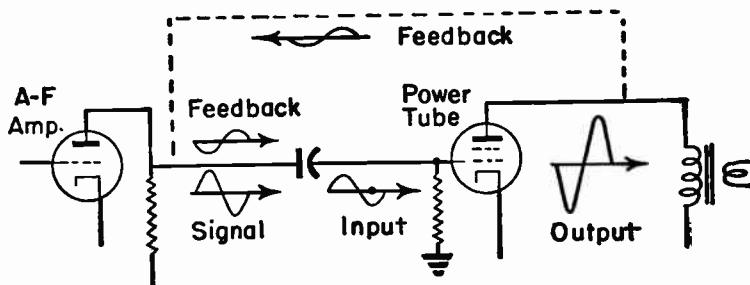

Fig. 1.—Negative feedback from plate to grid of a power tube.

power tube, just as in any amplifier tube, because the feedback voltage comes from the power tube output, and because the power tube grid is actuated by the phase of the incoming signal voltage.

The opposite-phase feedback voltage reduces the amplitude of the signal voltage coming from the a-f amplifier, and the input voltage to the power tube control grid is of smaller amplitude than the original signal voltage. At first thought it might seem illogical to deliberately reduce the input to an amplifier, for this reduced input will mean a correspondingly reduced output. There will be less gain between the plate of the a-f amplifier and the plate of the power tube than as though degeneration were not used.

But degeneration brings so many advantages that the loss of gain is a small price to pay. One advantage is a reduction of harmonic distortion. A second advantage is greater uniformity of output at both lower and higher frequencies. A third is reduction of phase displacement or phase distortion. A fourth advantage is a lessening of hum and of tube and circuit noises. The fifth advantage is greater constancy of amplifier performance with tube replacements or changes, and with variations in plate, screen, and grid voltages.

If we designate the voltage gain of a stage as G when there is no feedback, as g when there is a degenerative feedback, and designate as Ef the fraction of the output voltage which is fed back to the input, we may write the following formula for the reduced gain with degeneration.

The formula does not show Ef . Just f is used.

$$g = \frac{G}{1 + (f \times G)}$$

As an example, assume that we have a gain (G) of 20 times with no feedback, and that the feedback is made 1/10 or 0.1 of the output voltage. Then the formula shows,

$$g = \frac{20}{1 + (0.1 \times 20)} = \frac{20}{3} = 6.67$$

Thus the stage gain has been dropped from 20 to 6.67, or to one-third of its value with no degeneration. If it were required

to have the same voltage output as with no degeneration, the input signal voltage would have to be increased three times. With a power triode, which takes a rather high signal voltage to give full output, it probably would be difficult to increase the signal input by three times. But typical power pentodes take a signal of only 6 to 20 volts for maximum output, and the increase of signal might not be too difficult. Beam power tubes, as a general class, will deliver much greater output for a given input signal voltage than will triodes or pentodes, and with beam power tubes it usually is easy to raise the input signal to provide ample power output.

Because of the facts just mentioned, degeneration is in common use for beam power output tubes. It is an effective way to lessen the effects of harmonic distortion which tends to be fairly high in such tubes. Harmonic distortion naturally is less with power triodes, and this makes degeneration less necessary so far as this type of distortion is concerned.

Fig. 2 shows the effects on gain of feedbacks ranging from two per cent to 50 per cent of the output voltage. Each curve corresponds to a certain percentage of feedback; 2 per cent for the top curve, 5 per cent for the next one, 10 per cent for the third one, and so on. The lower horizontal scale shows voltage

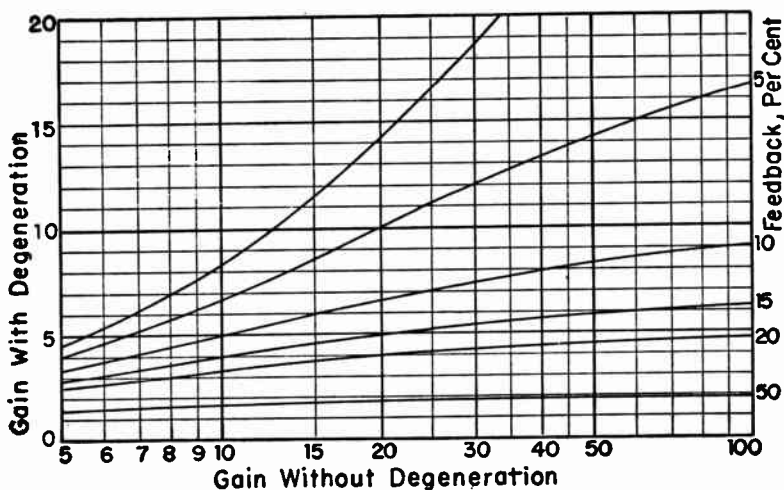

Fig. 2.—Effect on gain of degenerative feedbacks of various percentages.

gains of the stage when there is no feedback. The left-hand vertical scale shows the gains when there is feedback, or degeneration, with each percentage of the output.

With a feedback of only two per cent there is but little reduction of gain, but the feedback commences to become effective with a five per cent feedback. One of the first things to be noted from these curves is that degeneration has much greater effect on a stage of naturally high gain than on one of lower gain. For example, with a 10 per cent feedback and an original gain of 10 (lower scale) the degenerated gain is 5 (left-hand scale). The gain is dropped to half. But with an original gain of 40 and the same percentage of feedback the degenerated gain becomes about 8, which is only one-fifth of the gain without degeneration.

Here is something else which should be noted. If the feedback is made great enough the gain of the stage remains nearly constant regardless of any conditions which might affect the gain without degeneration. Consider a feedback of 20 per cent. Were the undegenerated gain to be 10 it would be dropped to about 3.3. Were there to be some sudden rise of screen voltage, or anything else which would raise the normal gain to 50, degeneration would drop it to about 4.5. Where the normal gain without degeneration would have increased by five times, the degenerated gain increases only about one and one-third times. With a 50 per cent feedback the degenerated gain would remain between 1.5 and 2.0 times with normal gain conditions varying from 5 to 100 times.

Harmonic distortion will be reduced by just about the same degree that gain is reduced. In the preceding example where, with a 20 per cent feedback, the gain would have increased 5 times but actually increased only $1\frac{1}{3}$ times, the reduction is to about one fourth. That is, $1\frac{1}{3}$ is about one-fourth of 5. Then harmonic distortion would be reduced to about one-fourth by this feedback and the same operating conditions.

For a non-mathematical explanation of how distortion is reduced in a greater degree than the desired signal we may follow Fig. 3. At *A* is represented a badly distorted waveform which we shall assume would exist in the output of the amplifier tube. A fraction of this output voltage or waveform, *B*, is taken off through the feedback circuit. When this feedback voltage, which is applied to the input, again goes through the tube from grid to

plate it will be amplified, as at *C* to a strength almost equal to that of the original distorted signal at *A*. In addition to being amplified, the phase of this distorted voltage will be inverted, as at *D*. We are following much the same travel of voltages as was shown in Fig. 1.

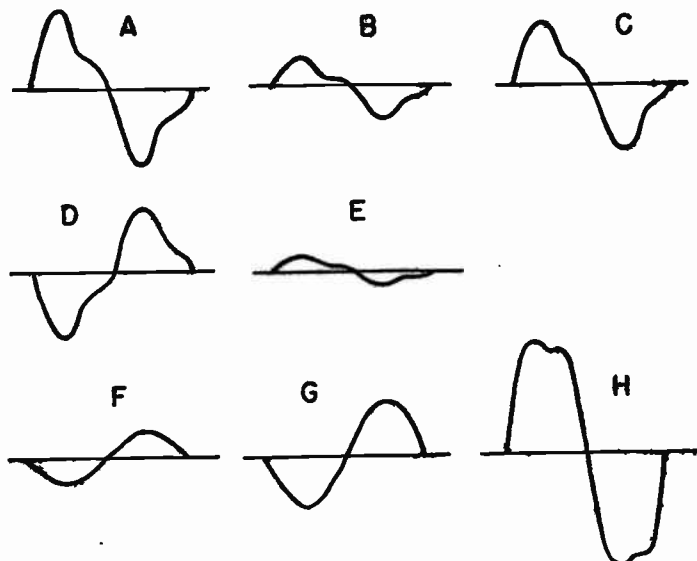

Fig. 3.—Distortion is reduced more than the desired signal is reduced.

Now the amplified and inverted voltage shown at *D* is combined in the tube output with the distorted voltage shown at *A*. The opposite-phase potential of *D* reduces the total to that shown at *E*. That is, the distortion has been made to very nearly balance itself out of the picture. We may assume that the incoming signal when no degeneration is being used need be of no greater amplitude than shown at *F*. But to compensate for the reduction of gain brought about by degeneration the signal amplitude is increased to the value indicated at *G*. Finally, the remaining distortion shown at *E* combines in the output with the stronger signal wave *G*, and we have in the output the waveform shown at *H*. Some of the original distortion remains, but it is insignificant in comparison with that shown at *A*.

Degeneration reduces harmonic distortion which is produced

in the amplifier, as by operating the tube or tubes with incorrect combinations of plate and screen voltage, grid bias, and input signal strength. Degeneration does not reduce distortion fed into the amplifier from a preceding stage; such distortion is amplified.

Now we shall consider the effect of degeneration on amplifier gain at various frequencies. To begin with it should be recalled that gain varies with changes of resistance or impedance in the plate circuit of the amplifier tube; increasing with higher load impedances and decreasing with lower impedances. The impedance in the plate circuit of a power tube is that of the primary of the output transformer. This primary impedance varies with any changes in the impedance or resistance of the load connected across the secondary winding. This load usually is the voice coil of a moving coil loud speaker. The impedance of moving coil loud speakers varies with frequency, usually in about the manner shown by Fig. 4. This varying impedance is reflected back into the plate circuit of the power tube.

When the power tube is a pentode or a beam power type, which has high plate resistance within the tube, a varying impedance in the plate load circuit can cause much distortion, because different frequencies then are amplified in varying degrees. If the gain of the amplifier can be made more or less independent of variations in load impedance the frequency distortion will be lessened. Degeneration will do this.

If an amplifier without degeneration were connected to a loud speaker having the characteristic shown by Fig. 4 a curve show-

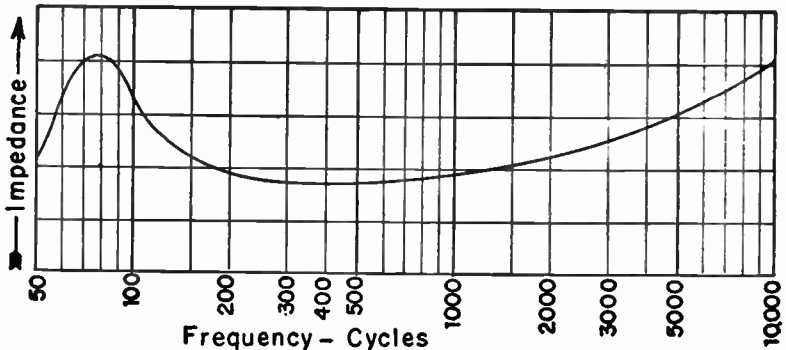

Fig. 4.—Variation of impedance with frequency in a moving coil loud speaker.

ing amplifier gain with frequency would have the same general shape, but with even greater differences between peaks and valleys. If, however, the amplifier has a 10 per cent feedback the performance will be governed by the 10 per cent curve of Fig. 2. Assume that a shift of frequency in the signal would cause such a change of load impedance as to raise the normal gain from 10 to 40, on the 10 per cent curve of Fig. 2. With degeneration the gain will change from 5 to 8. Instead of the frequency shift causing a one-to-four change of gain it will cause a change in the ratio of only one to one and three-fifths. The frequency response of the amplifier and speaker combined may be made fairly flat over the whole range of audio frequencies.

Reduction of noise results from the action shown by Fig. 3. When the noise arises in the amplifier its effects are largely canceled by the feedback. In effect, the desired signal is amplified while the noise voltage goes nearly without amplification. There is much greater reduction of the noise than of the signal.

Because degeneration makes the gain more nearly independent of all influences which normally would vary the gain, the degenerative amplifier is fairly free from hum due to poor filtering in the power supply system, from sudden changes of output due to power line voltage fluctuation, and from unbalances due to the aging of tubes in service. Such advantages are desirable, but it should not be forgotten that they may be had only at the expense of a considerable loss of amplification.

Current Feedback.—There are two general methods of obtaining a degenerative feedback. One method is called current feedback because it tends to maintain a constant current in the amplifier output. The other is called voltage feedback because it tends to maintain a constant output voltage.

Current feedback most often is obtained as in Fig. 5, by using cathode bias with a resistor in series with the cathode of the tube. In the left-hand diagram all of the signal currents which act in the plate load resistor R_b act also in the cathode resistor R_k , because there is the same electron flow in both resistors. Resistor R_k is in the control grid circuit as well as in the plate circuit. The control grid circuit includes grid resistor R_g and cathode resistor R_k . Then whatever signal voltage appears across R_k due to the inclusion of this resistor in the plate circuit is fed

back into the grid circuit because Rk is in the grid circuit.

Electron flow in Rk is upward, with the bottom negative with reference to the top. The grid is connected through Rg to the bottom of Rk , and so the grid is made negative with reference to the cathode. This is the manner in which Rk maintains a negative grid bias.

If an input signal were momentarily in such polarity as to be positive at the tube grid that signal would cause an increase of plate current in the tube. Since the plate current flows in Rk there will be an increased potential difference across Rk . This increased potential difference makes the grid more negative with reference to the cathode. The effect of plate current in Rk opposes the signal voltage. The change of grid potential caused by change of current in Rk is negative while the change of grid potential due to the signal is positive. Changes of signal potential fed to the grid circuit from Rk always are in opposite phase to the changes of signal current in the grid circuit. This is a negative feedback and the result is degeneration.

The fraction of plate signal voltage which is fed back to the grid circuit depends on the relative resistances of Rk and Rb in

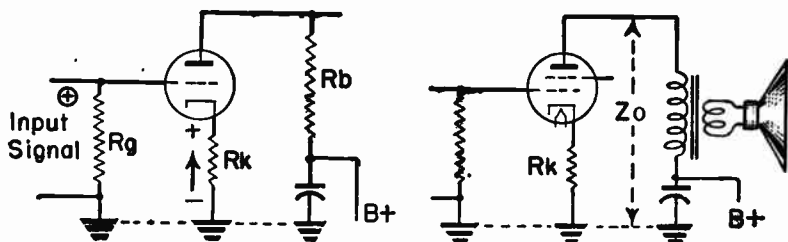

Fig. 5.—Current feedback with a cathode-bias resistor.

the left-hand diagram of Fig. 5. Because the same plate signal current flows in both resistors the relative signal voltages across the two will be proportional to their resistances, or,

$$\text{Feedback fraction} = Rk/Rb$$

As an example were Rk 2,000 ohms and Rb 100,000 ohms the fraction would be 2,000/100,000, which is 0.02 and is a 2 per cent feedback.

In the case of a power tube feeding a loud speaker, as at the right in Fig. 5, the plate circuit load consists of the impedance

of the primary winding of the speaker coupling transformer. The turns ratio of this transformer has been selected to match the desirable load resistance of the power tube to the resistance or impedance of the loud speaker, usually at a frequency of 400 cycles. The desirable load resistance for various power tubes may be found in the listings of typical operating conditions as published by tube manufacturers.

For a typical beam power tube the desirable load resistance may be listed as 5,000 ohms and the resistance of the cathode-bias resistor listed as 250 ohms. Then, if the output transformer gives a correct matching of impedances, the feedback fraction will be $250/5000$ or 0.05. This will mean a 5 per cent feedback when the impedance of the loud speaker is that for which the matching has been provided. If the impedance of the loud speaker increases at some other frequency there will be increased impedance and less current in the power tube plate circuit. The rise of plate circuit impedance tends to raise the amplification or gain. The feedback fraction does not change, because the same smaller plate current flows in both the plate load and the cathode resistor, and voltages across the two still are proportional to their resistances.

In Fig. 6 the cathode resistor R_k is bypassed with capacitor C_k . Now the feedback voltage developed between the cathode and the grid return will be proportional to the impedance of R_k and C_k rather than to the resistance of R_k alone. If C_k has large capacitance its reactance will be low and the impedance Z_k will be small. Then the feedback voltage will be small and there will be little degeneration. The feedback fraction now becomes,

$$\text{Feedback fraction} = Z_k / Z_o$$

Because the reactance of C_k increases as the frequency be-

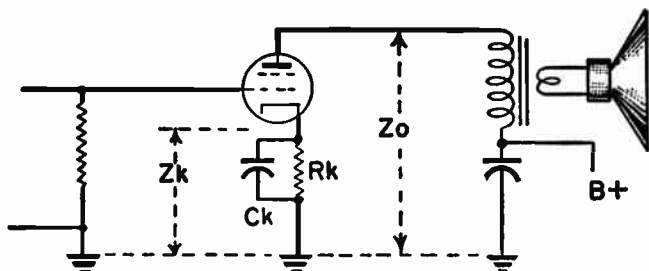

Fig. 6.—Impedances in output and feedback with cathode-bias degeneration.

comes lower, and decreases at higher frequencies, the impedance Z_k will vary with frequency in a similar manner. Since feedback varies directly with Z_k the feedback will increase at low frequencies and decrease at higher frequencies. If the capacitance of C_k is made so great as to have reactance no greater than one-tenth the resistance of R_k at the lowest frequency to be amplified there will be negligible feedback at all frequencies. Then there will be maximum amplification or gain. The feedback fraction may be varied by choosing different capacitances for C_k . However, this fraction never may be made greater than that which corresponds to having no bypass on the cathode resistor.

Fig. 7 shows how the power stage gain would be varied by using various values of impedance Z_k due to the combination of R_k and C_k in Fig. 6. The tube is a typical beam power tube for which the recommended cathode-bias resistance is 250 ohms. Zero impedance would be obtained with a bypass capacitor of such large capacitance as to have negligible reactance. Values between zero and 250 ohms could be had for any one frequency by using a bypass of successively smaller capacitances. With resistors greater than 250 ohms, with no bypasses, it would be necessary to use greater B-supply voltages to maintain the

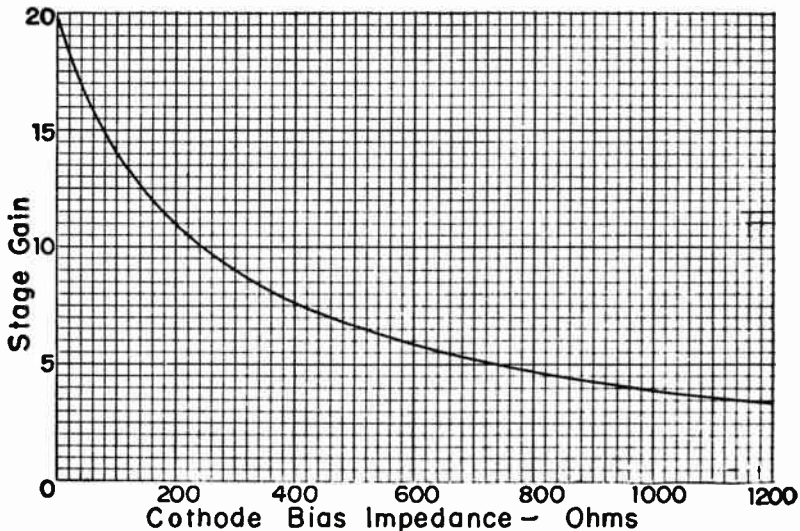

Fig. 7.—Effect on gain of varying the cathode impedance.

normal plate and screen currents. This curve shows also the effect on gain of various feedback percentages. The normal load resistance for the particular tube is 5,000 ohms. Therefore, the feedback percentage for any cathode impedance may be found from multiplying the number of hundreds of ohms impedance by two. For instance, with impedance of 250 ohms (2.5 hundreds) the feedback is 2.5 times 2, or is 5 per cent.

Voltage Feedback.—Fig. 8 shows one method of obtaining a negative voltage feedback to provide degeneration. The a-f amplifier tube is resistance coupled to the power tube with an ordinary coupling circuit consisting of plate load resistor R_b , coupling capacitor C_c , and grid resistor R_g . The power tube is cathode-biased with resistor R_k , across which is capacitor C_k of sufficiently large capacitance to prevent any appreciable amount of current feedback due to cathode impedance.

The voltage feedback is through resistor R_f , which is connected from the power tube plate to the upper end of R_b , from which the signal potential is furnished to the power tube grid. Since the signal potentials at the plate and at the grid of the power tube are of opposite phase, this connection provides a negative feedback or an opposite-phase feedback.

So far as the a-c signal from the power tube is concerned, R_f is in series with the parallel combination of R_b and R_g . We may think of the signal feedback from the power tube plate as passing through R_f and then through R_b and R_g in parallel. Grid resistor R_g usually is of much greater resistance than R_b , and in series with R_g is the reactance of the coupling capacitor C_c . Thus the parallel resistance or impedance will be lower than the resistance of R_b , but not a great deal lower. The resistance

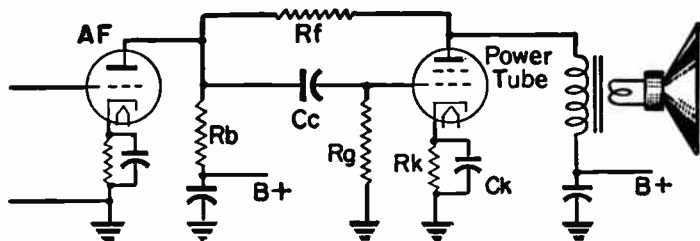

Fig. 8.—Voltage feedback with a resistor from output to input.

of R_f and the resistance or impedance of R_b - R_g form a voltage divider for the feedback potential, with the takeoff to the power tube grid from the point between R_f and R_b .

The entire output voltage from the power tube exists between the power tube plate and ground, and thus exists across the voltage divider just mentioned. The voltage at the grid takeoff, which is the feedback voltage, will depend on the relative resistances in R_f and in R_b - R_g . Indicating the effective impedance of R_b and R_g with C_c in series by the symbol R_b - R_g the feedback fraction will be,

$$\text{Feedback fraction} = \frac{R_b-R_g}{R_f + R_b-R_g}$$

The formula shows that the greater the resistance in R_f the smaller will be the feedback fraction and feedback percentage with the same values at R_b , R_g and C_c . The resistances at R_f commonly are between 0.5 and 5.0 megohms.

Fig. 9 shows a generally similar method for voltage feedback, with the difference that the feedback connection is taken directly to the grid of the power tube at the top of R_g rather than to the output of the a-f amplifier at the top of R_b . Now we have power tube plate potential at one end of feedback resistor R_f and have grid potential at the other end. To keep direct current from the plate circuit out of the grid circuit it is necessary to place a blocking capacitor C_f in series with the feedback line. This capacitor usually is of large capacitance, something like 0.1 mfd, and must have a voltage rating higher than the peak potential in the plate circuit.

Still another method for voltage feedback is shown by Fig. 10. Here there is placed across the output of the power tube a voltage divider consisting of resistors R_1 and R_2 . The feedback takeoff is from between these two resistors, and goes to the input for the power tube grid at the top of resistor R_b . Resistors R_b and R_2 are in parallel with each other; their tops are directly connected through the feedback line and their bottoms both go to the B+ line. Then whatever fraction of the power tube output voltage exists across resistor R_2 must be applied also to resistor R_b , because voltage across parallel resistors must be the same. Because the input for the power tube grid comes from the voltage

across R_b , the feedback voltage existing across resistor R_2 is applied to the power tube grid.

The feedback fraction and percentage depend on the relative values of resistances in R_1 and R_2 . The fraction is,

$$\text{Feedback fraction} = \frac{R_2}{R_1 + R_2}$$

The greater the resistance in R_1 , and the smaller the resistance in R_2 , the less will be the feedback. The total series resist-

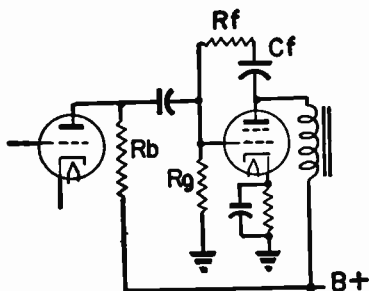

Fig. 9.—Voltage feedback to the grid of a power tube.

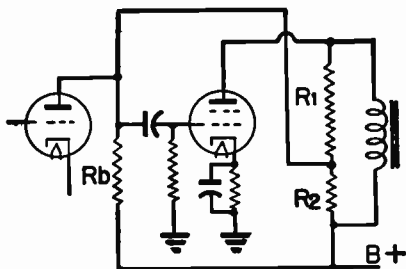

Fig. 10.—Voltage feedback from an output circuit divider.

ance of R_1 and R_2 must be great enough to prevent much extra loading of the power tube output. This total resistance usually will be 0.1 megohm or more.

The types of feedbacks which have been shown may be applied to push-pull power tubes and to parallel power tubes as well as to the single power tubes which have been shown in the diagrams. Both current feedback and voltage feedback may be used in the same amplifier if desired. Removing or reducing the capacitance of the cathode bypass capacitors in Figs. 8 to 10 would bring about current feedback in addition to the voltage feedbacks shown by the diagrams.

All of the simple rules or formulas which have been given for degenerative feedbacks assume that the feedback voltage is in opposite phase or is 180° out of phase with the input signal voltage. This actually is true in only a portion of the middle frequency range. At higher and lower frequencies the phase difference becomes less than 180° , and the degree of feedback is affected.

Power Amplifier Classification.—The operating characteristics and the type of output signal from any amplifier may be changed quite radically by varying the relations between the maximum potential of the signal applied to the control grid and the bias voltage for the control grid. The three methods of operation originally distinguished from one another are designated as class A, class B, and class C. In class A amplifiers the waveform of the output plate current follows the waveform of the input signal voltage. In class B amplifiers most of the negative swing of plate voltage is cut off. In class C amplifiers all of the negative swing and part of the positive swing of the plate voltage is cut off. In addition to these three original classes of amplifiers there are three others which have characteristics intermediate between those of the A, B and C classes. Now we shall examine the performance of each of the six generally recognized classifications.

Class A or A1 Amplifier.—The type of operation first designated as class A now usually is called class A1. The numeral 1 following the letter indicates that under no conditions will there be current in the grid circuit of the amplifier tube, which means that the control grid shall not become positive with reference to the cathode at any time. This always is the meaning of the number 1 in the designation for any type of amplifier. If the numeral 2 follows the letter designation for an amplifier it means that there will be grid current in the amplifier tube at some times, and it means that under some operating conditions the grid will become positive with reference to the cathode.

Fig. 11 shows how a class A1 amplifier operates. The curve on the graph shows the relations between control grid voltage and plate current. The particular curve used here applies to a type of beam power tube. The grid-voltage plate-current curves for any other tube would have a somewhat similar shape, with increasing curvature near zero plate current and again near maximum plate current, or at highly negative grid voltages and again where the grid voltage approaches a positive value or actually becomes positive.

In the class A method of operation the control grid bias is chosen to bring the average value of plate current about midway between zero and maximum plate currents, or to bring the plate current with no signal to about the center of the relatively

straight portion of the curve. The peaks of input signal voltage must be no greater than will keep the swings of plate current on the straight portion of the curve. This means that the peak signal voltage must be somewhat less than the grid bias voltage. Plate current flows at all times; there never is plate current cut-

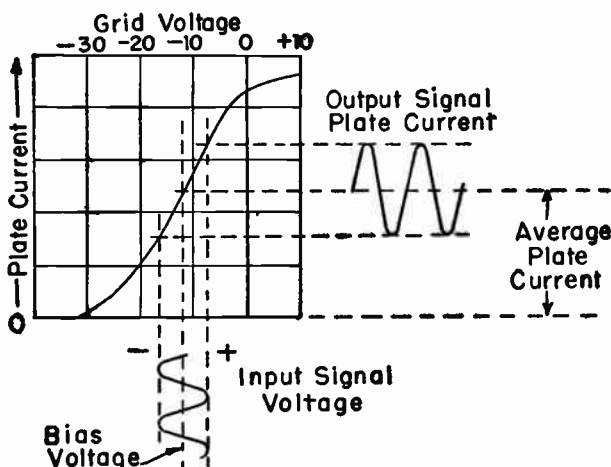

Fig. 11.—Performance with class A or A1 operation of amplifier.

off. The average value of plate current remains constant. This average remains the same when there is a signal as when there is no signal, and does not vary with strength of signal. Because the average plate current remains constant the plate power supply system (rectifier, filter, and voltage dividers) need not have particularly good voltage regulation.

Because there never is any current in the control grid circuit there will be no power used in this circuit. Power requires that there be a flow of current as well as a difference of potential. Harmonic distortion is low in a class A-1 amplifier using a triode or triodes, but is somewhat higher with pentodes or beam power tubes. The difference in distortion is due to the types of tube, not to the class of amplifier. Degeneration or negative feedback may be used to lessen distortion and provide its other advantages.

The class A1 amplifier may have high gain, but its output

power is less than that of any other class for given operating conditions. The power efficiency is low with triode tubes, but is relatively high with pentodes or beam power tubes. Power efficiency, as a fraction, is found from dividing the a-c power input to the plate by the d-c power input to the plate. This efficiency is low because the average plate current (which determines the d-c power) is large in comparison with the variations of plate current (which represent the a-c component and determine the a-c power). The plate efficiency likewise is low. Plate efficiency indicates how effectively the B-power supply voltage is used. Plate efficiency, as a fraction, is as follows:

$$\text{Plate efficiency} = \frac{\text{maximum plate current} \times \text{load resistance}}{1.26 \times \text{plate supply potential}}$$

Maximum plate current is the peak current in any cycle, in amperes. Load resistance is the resistance or impedance in the output circuit or plate circuit, in ohms. The plate supply potential is the d-c potential, in volts, applied to the tube and the load resistance in series.

Class A1 operation may be used with single power tubes and with power tubes in push-pull or parallel for high fidelity output. In addition to being used for power stages this method is used for r-f and i-f amplifiers in receivers, and for a-f voltage amplifiers in receivers.

Class A2 Amplifier.—Fig. 12 shows the operation of a class A2 amplifier. The control grid bias may be about the same as for class A1 operation, or may be somewhat more negative. The peak signal voltage, when there is maximum strength of signal, may be greater than with class A1 operation. As a consequence the control grid may become slightly positive on positive peaks of input signal voltage, this being the principal way of distinguishing class A2 operation from class A1. Plate current flows at all times; there never is plate current cutoff. However, the average plate current may drop slightly on very strong input signals due to the bend of the curve at the upper positive end. The plate power supply system should have rather good voltage regulation because of the possible fluctuations in average plate current.

On strong input signals there will be grid current during a part of each positive half-cycle of signal voltage. The effects of

the grid current sometimes are lessened by placing a small resistance directly in series with the control grid. When grid current flows in this resistance there is a potential difference across the resistance in such polarity as to make the grid less positive. That is, the resistor potential tends to make the control grid negative while the signal potential is making it positive. The

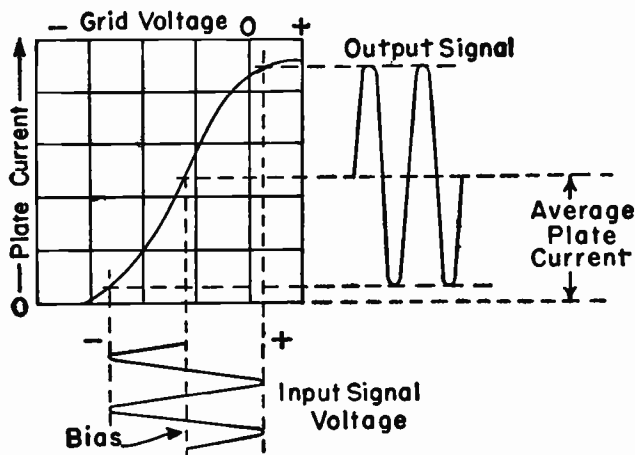

Fig. 12.—Performance with class A2 operation of amplifier.

grid current causes some power to be used in the grid circuit. This power, in addition to the signal voltage, must be furnished by the preceding stage of amplification. There is more harmonic distortion with class A2 operation than with class A1, especially when only a single power tube is used. The distortion is lessened when the power tubes are push-pull, which is the usual connection. The fact that power is used in the grid circuit, or that there is current in this circuit, makes it rather difficult to use degeneration for lessening distortion.

Voltage gain tends to be less with class A2 operation than with class A1, but power output is considerably greater because of the greater swings of plate signal current. Class A2 operation may be employed with special types of beam power tubes which permit surprisingly large power outputs with plate and screen

voltage as low as 28 instead of the usual range of from 90 to several hundred volts.

Class B Amplifier.—The operation of a class B amplifier is shown by Fig. 13. The control grid bias is made so negative that there is hardly any plate current with no signal on the tube. That is, the amplifier or amplifiers are biased nearly to the plate current cutoff point. Some tubes designated especially for class B operation may be operated with zero bias. When a bias potential is required, as it is in nearly all tubes of recent design, the potential is secured from a fixed bias connection in the d-c plate and screen power supply system. Cathode-bias would be undesirable because of the great changes of average plate current with varying strengths of input signal voltage. This variation is shown at the right in Fig. 13. With no signal the average plate current is near zero. With maximum signal it is many times as great. With intermediate signal strengths the average plate current shifts between these extremes. Cathode-bias voltage is determined by average plate current, or plate and screen current, in the bias resistor. With class B operation this bias voltage would undergo great variations.

The maximum input signal voltage with class B operation may

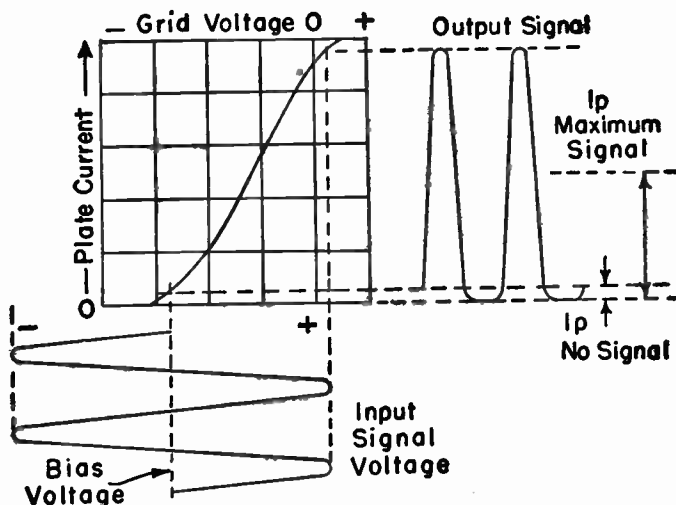

Fig. 13.—Input, output, and biasing for class B operation.

be much greater than with any other method except class C, which is not used in sound amplifiers. The plate current waveform is not at all like the signal voltage waveform to the grid. There is plate current during only about half of each cycle of input signal voltage, this being the half in which the input signal is positive. There is plate current cutoff during nearly all of the negative swing of signal voltage at the input. Because of the great variations of average plate current with input signal strength the power supply for class B operation must have exceedingly good voltage regulation. The power supply filter usually is of the choke input type rather than the capacitor input type. The choke and the power transformer should have low resistances in their windings. If plate and screen voltages are taken from the same supply they usually are taken from a voltage divider in which there is a large bleeder current to improve the voltage regulation.

With class B operation and large input signals the power tube control grid is driven decidedly positive. Then there is considerable grid current, and there is considerable power used in the grid circuit. Grid input usually is from a transformer between the preceding amplifier tube or tubes and the power tubes. There is high harmonic distortion with class B operation, requiring push-pull power tubes for its reduction. Distortion tends to be greater with weak input signals than with strong ones. Degeneration or negative feedback seldom can be used with class B amplifiers because of the current and power used in their grid circuits.

Power output is high with class B operation. There is a large power gain but relatively small voltage gain. Since there is large plate current during only about half of each cycle the heating or power dissipation in the tubes is reduced. Power tubes may be operated class B to give five or more times the power output of the same tubes operated class A1 without overheating. Class B operation always is with power tubes in push-pull, never with a single power tube. As may be seen from Fig. 13, each tube acts during only about one-half of each signal cycle. When their outputs are combined in the push-pull output transformer there is a large signal output. Plate-to-plate load resistance is made much higher for push-pull triodes operated class B than for other classes of sound amplifier operation.

Class AB1 Amplifier. — A class AB amplifier is one whose operation is intermediate between those of amplifiers in the A class and B class. A class AB1 amplifier is a class AB type with which there is no grid current at any time in the amplifier tubes. A class AB2 amplifier is a class AB type with which there is grid current under some conditions of operation.

The operation of a class AB1 amplifier is shown by Fig. 14. The control grid bias is more negative than for class A opera-

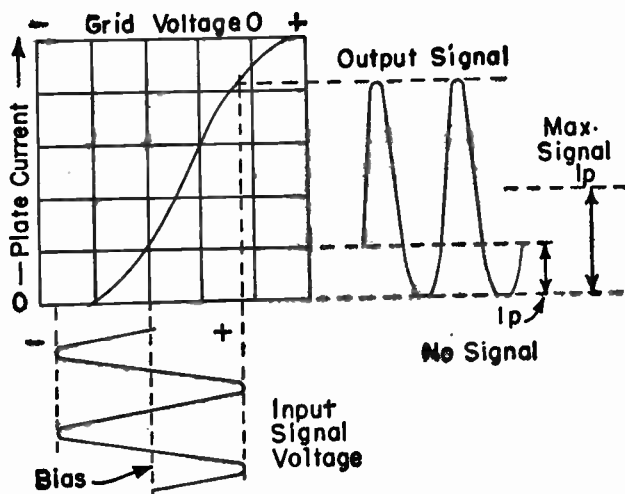

Fig. 14.—Performance of a class AB1 amplifier.

tion, but not so negative as for class B operation. It is possible to use either fixed bias or cathode-bias. The maximum peak signal potential must not be greater than the negative bias voltage, since with any amplifier whose designation includes the numeral 1 there is to be no grid current and no positive grid potential at any time.

As shown by Fig. 14 the average plate current increases with input signal strength, although not to such an extent as with class B operation. The waveform of the plate current does not follow the waveform of input signal voltage. There is plate current during more than one-half of each signal voltage cycle, but with strong input signals there is plate current cutoff during a

part of the negative swing of grid potential. It is shown quite clearly by the graph that with a weak input signal the plate current will not come down to the cutoff point at any time. Then with small input signals the performance is much like that of a class A1 amplifier. With large input signals there is plate current cutoff and performance approaches that of a class B amplifier. It may be noted that with cathode bias for class AB1 operation the bias voltage changes to oppose the variations of plate current, and so lessens the variations. The cathode resistor must be well bypassed with push-pull connections because the sum of the plate currents in the two tubes does not remain constant, and the difference current will be in the cathode resistor. The plate power supply system must have good voltage regulation because of the variation of average plate current with variations of input signal strength.

There being no grid current in the class AB1 amplifier, and no power used in the grid circuit, it is possible to use degeneration or negative feedback to lessen harmonic distortion. Class AB1 amplifiers always are of the push-pull type, never of the single power tube type. The push-pull connection nearly eliminates harmonic distortion to the irregular waveform of plate current and output voltage from each tube. Distortion will increase with increase of signal strength, or as the operation passes from that of a class A amplifier toward that of a class B amplifier.

The class AB1 amplifier provides more voltage gain than a class B type, but less than a class A type. The power output is greater than for class A, but less than for class B operation. Power efficiency and plate efficiency also are intermediate between these efficiencies for class A and class B operation. Class AB1 operation formerly was called class A-prime operation.

Class AB2 Amplifier.—With the class AB2 amplifier, whose performance is shown by Fig. 15, the control grid bias may be about the same as for class AB1 operation but the input signal may be strong enough to make the control grid somewhat positive. That is, the positive peaks of the input signal may have amplitude or voltage greater than the negative bias potential, thus giving the control grid a net positive potential. It is the positive grid condition which distinguishes the class AB2 ampli-

fier from the class AB1. As with class AB1 operation, the grid bias may be a fixed bias potential from the B-power supply or may be secured with cathode-bias. If cathode bias is used the bias resistor must be well bypassed.

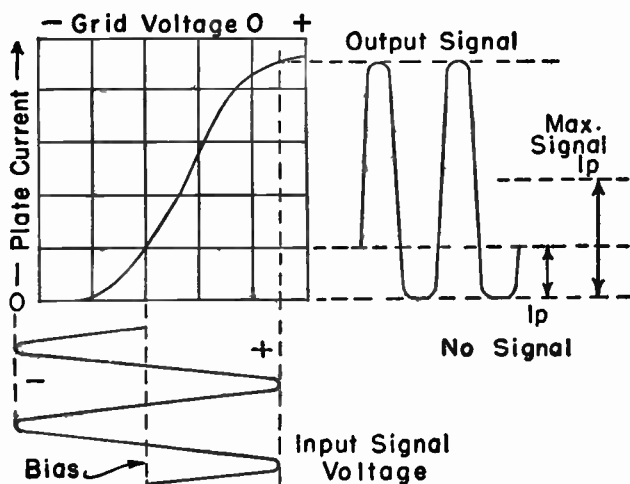

Fig. 15.—Performance of a class AB2 amplifier.

Plate current average value varies with signal strength about the same as with class AB1 operation, or slightly more. Power supply voltage regulation must be very good, just as for class B operation. The plate current waveform does not follow the input signal waveform, and to lessen the distortion which would result the class AB2 amplifier always is a push-pull type. There is plate current cutoff during a considerable portion of each negative swing of input signal voltage, leaving plate current flow during not much more than half of each cycle. The general performance of the class AB2 amplifier is more nearly like that of a class B than a class A amplifier, while performance of an AB1 amplifier is more nearly like that of a class A than a class B amplifier.

There will be grid current during part of each cycle in the class AB2 amplifier when the input signal is strong. Then power will be used in the grid circuit. If operation is such as to permit only small grid currents and little power consumption in the grid circuit it is possible to use resistance coupling between the

preceding amplifier tube and the class AB2 power tubes. Otherwise the interstage coupling must be with a transformer. There is greater tendency to harmonic distortion with class AB2 operation than with class AB1 operation, this being due to the grid current and power. Naturally, the distortion increases with strong input signals because such signals cause flow of grid current. Degeneration seldom can be used with a class AB2 amplifier.

Voltage gain with the class AB2 amplifier is somewhat less than with the class AB1, but power output, power efficiency, and plate efficiency are greater. These things are indicated by comparing the graphs for the two classes of operation. With push-pull operation the plate-to-plate load resistance is made greater with class AB2 operation than with class AB1 operation.

Class C Amplifier.—The class C amplifier, whose performance is shown by Fig. 16, is found only in power amplifiers having tuned plate circuits or output circuits where operation is in a relatively narrow band of frequencies. It is much used in tuned r-f power amplifiers of transmitters.

The control grid bias is made more negative than the value for plate current cutoff with no signal applied, often being much more negative than indicated in Fig. 16. Peak input signal ampli-

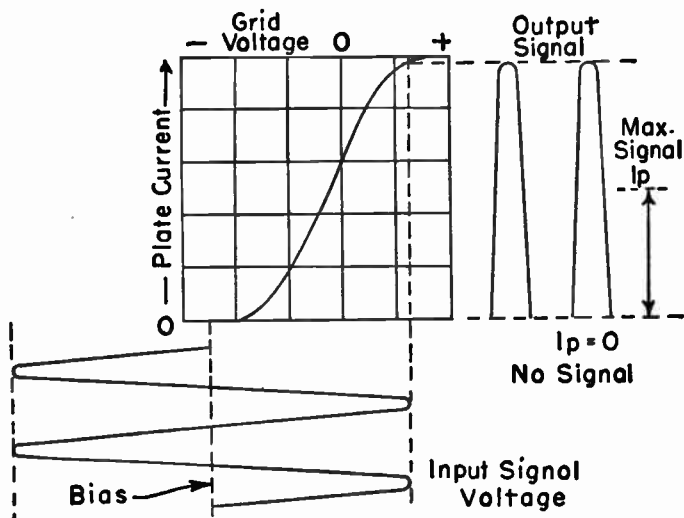

Fig. 16.—Input, output, and biasing for class C operation.

tude is great enough to drive the control grid positive, often well up onto the bend which indicates plate current saturation or a condition in which practically all emitted electrons are drawn to the plate instead of remaining in the space charge around the cathode.

Because of the control grid bias being more negative than for cutoff the plate current is zero with no signal applied to the grid. Plate current flows in separated pulses during a portion of each positive half-cycle of input grid signal. The plate power supply must have very good voltage regulation. The plate current waveform causes more harmonic distortion than could be satisfactorily reduced even with push-pull operation of an a-f amplifier. There is low voltage gain, but high power output with high power efficiency and plate efficiency.

Driver Stages.—It has been mentioned that flow of grid current in an amplifier tube means that power must be supplied to the grid circuit from the preceding stage. This condition exists with class B and class AB₂ amplifiers. The stage which furnishes the power for the grid circuit, while also delivering the signal, is called the driver stage and its tube is called the driver tube. Fig. 17 shows a push-pull class B or AB₂ amplifier to which is transformer coupled a driver tube which is a pentode type connected as a triode, with its screen connected directly to the plate.

When the control grid of a power amplifier is maintained negative with reference to the cathode, and when there is no grid current, the grid circuit acts like an infinitely great impedance which is across the output of the preceding stage. But if there is grid current the grid input circuit acts like some certain value of resistance connected across the output of the preceding

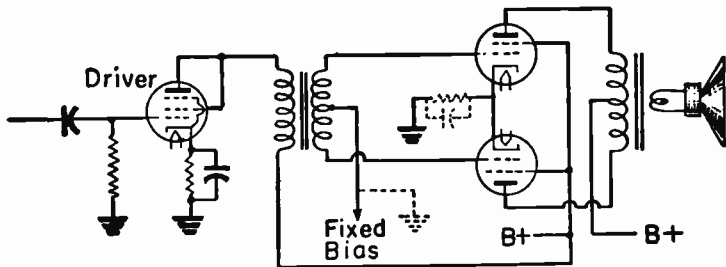

Fig. 17.—A triode-connected pentode used for a driver tube.

stage. This shunting resistance varies with the amount of grid current; the greater the grid current the lower the shunt resistance. Naturally, the lower is this shunt resistance the more power must be put into it from the preceding stage to maintain a signal voltage for the power tubes.

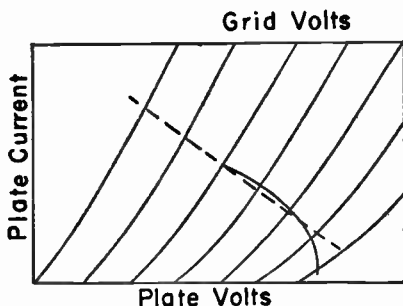

Fig. 18.—Power tube grid current makes the driver operate on a curved load line.

The driver tube really is working into a varying load resistance. Instead of this tube operating along a straight load line, as shown broken in Fig. 18, it has to operate along a load line which curves, as shown by the solid line of Fig. 18. Such operation means that the plate current of the driver is not following the grid signal voltage applied to the driver, and there will be distortion in this stage. The distortion would be passed along to the input of the power tubes.

Distortion in the driver stage may be lessened and nearly eliminated by several factors. The driver tube should be of a type which causes minimum distortion. This calls for a triode or for a pentode connected to operate as a triode. The driver tube should have the least possible plate resistance. Power tubes

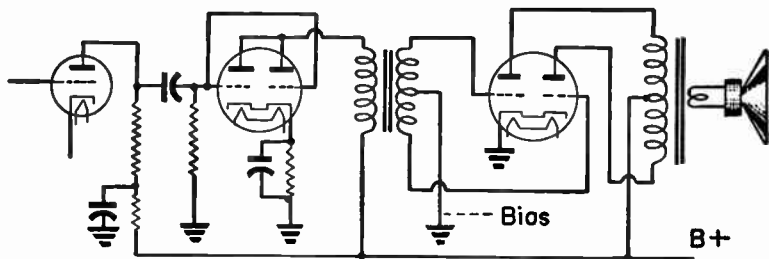

Fig. 19.—A parallel connected twin-triode used as a driver.

usually are used for drivers, this general type having relatively low plate resistances. The transformer requires careful designing. Distortion is lessened by increasing the power output of the driver, also by using a coupling transformer (between driver and power tubes) which has a considerable step-down ratio from primary to secondary. These step-down ratios commonly are between two to one and six to one.

The low resistance and low power consumption which are quite easily realized in the windings of an interstage coupling transformer are much more difficult to obtain with resistance coupling between driver and power tubes. However, when a class AB2 power stage is operated to have but very little grid current the resistance coupling may be used. Instead of the triode-connected pentode shown as the driver tube in Fig. 18 this tube sometimes is a twin-triode operated in parallel, with both plates connected together and with both grids connected together. Such an arrangement is shown by Fig. 19. Here the same type of tube is used in both the driver stage and the power stage. It is a twin-triode power tube, used with the two sections connected parallel for a driver and with the sections used separately in the push-pull power stage. Some tubes of this type are designed for operation with zero grid bias, as indicated by the full-line grid return to ground.

REVIEW QUESTIONS

1. Is gain increased or decreased by using degeneration?
2. What is the smallest percentage of negative feedback giving noticeable effect in making gain more uniform at all frequencies?
3. Is a cathode-bias resistor used for voltage feedback or current feedback? What is the effect on feedback of omitting the bypass capacitor from the bias resistor?
4. Does the numeral 1 in amplifier classification indicate that there always is some grid current, that there never is grid current, or that there sometimes is grid current?
5. Is greater control grid bias used with class A or class B amplifiers?
6. Which are usually found with single power tubes and which with push-pull tubes, class A amplifiers or class B amplifiers?
7. Which are in general use for home radios, class A, class B, or class C amplifiers?
8. Is a driver stage required (a) when there is no grid current in the power tube, or (b) when there may be grid current in the power tube?

Chapter 4

DECOUPLING AND SHIELDING

In Fig. 1 are shown connections for two stages of amplification and their d-c power supply unit. In this and in all amplifiers we wish to have the signal proceed from the input at the control grid of the first tube through to the output from the plate of the last tube. We wish to have what might be called "forward" coupling from the plate of one tube to the control grid of a

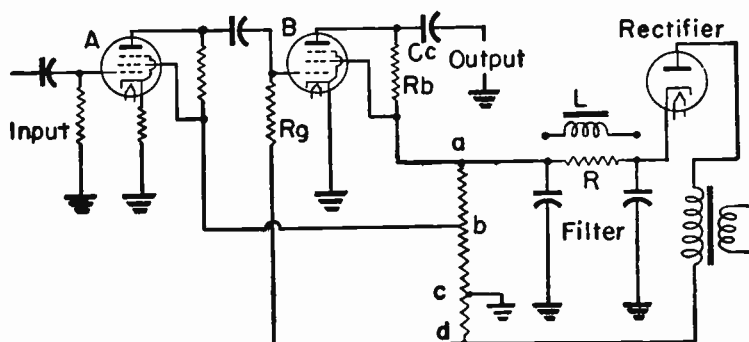

Fig. 1.—Two stages of audio amplification and a d-c power supply.

following tube. Sometimes we wish to have a backward coupling to provide feedback which is degenerative. But in any case we wish to have only such couplings as are intentionally made part of the design, and do not want any other couplings which feed signal energy either forward or backward.

In the diagram there is resistance coupling between the plate of tube A and the control grid of tube B. Also, there is degenerative feedback coupling from plate to control grid of tube A because the cathode-bias resistor is not bypassed with a capacitor. These two are intentional couplings. Let's see what other couplings exist in the two stages of amplification.

The signal potential from tube B must exist in the entire external plate circuit, from plate back to cathode. By following

the electron flow from the plate we see that the plate circuit passes first through resistor R_b , then to point a on the power supply voltage divider, through the resistance of the divider to point c and ground, and through ground back to the cathode of the tube. The portion of the plate circuit signal which goes through capacitor C_c will pass through whatever may be the output load, thence to ground and through ground back to the tube cathode.

Now look at the screen grid circuit for tube B . Starting from the screen we follow to point a on the power supply voltage divider, through the divider resistance to point c and ground, and through ground back to the tube cathode.

Tube B is biased through a connection from its grid resistor R_g to point d on the voltage divider. This point is negative with reference to grounded point c . The cathode is connected directly to ground. To follow the control grid circuit we start from the grid, go through grid resistor R_g , then to point d on the voltage divider, up through the divider resistance to point c and ground, and through ground back to the tube cathode.

All or part of the power supply voltage divider forms portions of the plate circuit, the screen grid circuit, and the control grid circuit of tube B . Whenever a single resistance is included in two or more circuits, there is resistance coupling between those circuits. Therefore, we have unwanted couplings for signal potentials between all three circuits of this tube.

Now follow the plate circuit and screen grid circuit of Tube A . The plate circuit of this tube includes the power supply voltage divider between points b and c , and this portion of the divider resistance is also in the screen grid circuit. The divider resistance between b and c is common to both tubes. In this common resistance there will be undesired couplings between the plate and screen circuits of tubes B and A .

Even though the power supply system does not include a voltage divider, there still will be undesired couplings. Were there any direct connections from a of the power unit to the plate resistors and to the screen grids, with no voltage divider between a and d , the circuits would be completed through impedances in the power unit. The signal potentials and currents then would act through the filter capacitors, which have reactance,

and through either a filter resistor R or a choke L , which have reactance and resistance. Then these common impedances would provide coupling.

Feedback will tend to cause either degeneration or regeneration, depending on the relative polarities or phase relations in the circuits. Degeneration opposes the input signal and weakens it. Regeneration assists the input signal and strengthens the signal. Regeneration often will cause low-frequency oscillation in the tube circuits of audio-frequency amplifiers.

Fig. 2 shows grid and plate phase relations in three successive stages. When the grid of tube A becomes more negative the plate becomes more positive. Then the grid of the tube B is made more positive and its plate more negative. This makes the grid of tube C more negative and its plate more positive. Feedback from the plate of tube B to the grid of tube A causes regeneration, because both potentials are in the same polarity or phase.

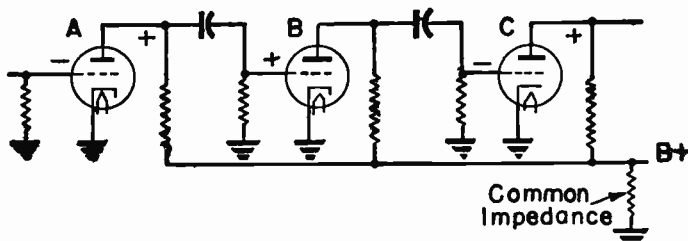

Fig. 2.—Polarities which determine whether feedback is degenerative or regenerative.

Feedback from the plate of tube C to the grid of tube A causes degeneration, because the two potentials are in opposite phase or polarity. Feedback from tube C to tube B causes regeneration. Feedback from the plate of any tube to the grid of the same tube causes degeneration, because plate and grid potentials are in opposite phase.

To prevent unwanted couplings and the resulting feedbacks it is necessary to employ various methods of "decoupling." Were we to have the voltage divider on the power supply, as in Fig. 1, decoupling might be accomplished as shown by Fig. 3. Signal potentials in the control grid circuit of tube B now may complete their path from grid back to cathode through bypass capacitor 1

from the bottom of grid resistor R_g to the cathode, rather than having to go all the way to d on the voltage divider and then through part of the divider resistance to ground and the cathode. The capacitive reactance in ohms of capacitor 1 must be small in comparison with the resistance in ohms between d and c of the voltage divider.

Signal potentials and currents in the plate circuit of tube B now go through plate resistor R_b and through bypass capacitor 2 to the cathode, rather than having to go all the way to a on the voltage divider and then through the divider resistance to point c and ground before getting back to the cathode. Although the power supply filter capacitor 3 would permit signal currents

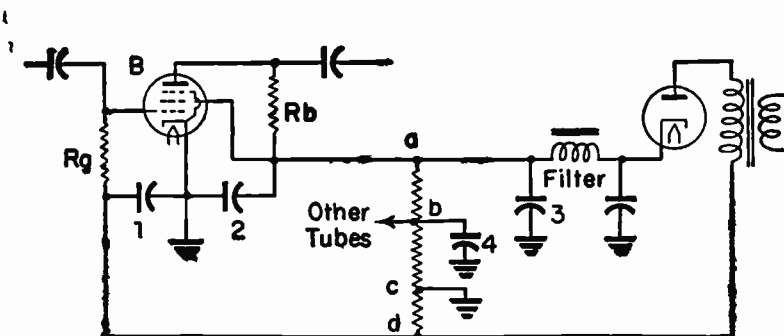

Fig. 3.—Decoupling when there is a voltage divider in the power supply.

to pass through it to ground and the cathode, rather than through the voltage divider resistance, it is far more effective to have the bypass capacitors close to the tube. Bypass capacitors close to the tube, or the tube socket, have the further advantage of reducing inductive couplings in wiring leads going to the power supply. These leads usually run close together for all of the plate and screen connections, and there is considerable mutual inductance between the various wires.

To lessen the unwanted coupling between tube B of Fig. 3 and any other tubes whose plates and screens are supplied from the voltage divider we would use bypass capacitor 4 at the take-off for the other tubes. Then signal currents and potentials from the other tubes would pass to ground through capacitor 4 instead of through the resistance of the voltage divider. Here, as in all

other bypasses, the capacitive reactance of the capacitor must be much less than the resistance or impedance of the parts bypassed.

Principles of Decoupling.—Before taking up details of practical decoupling methods it will be well to briefly review some of the elementary facts with which we shall be dealing. To begin with, in the circuits of amplifiers and power supply units there are several kinds of potentials and currents. They are represented at the top of Fig. 4.

1. Smooth direct potentials and currents, whose values remain constant.

2. Low-frequency alternating currents and potentials, whose frequencies range from about 50 to 20,000 cycles per second. These include (a) power line frequencies and (b) audio frequencies.

3. High-frequency alternating currents and potentials, whose frequencies range from around 50 kilocycles up to 100 mega-

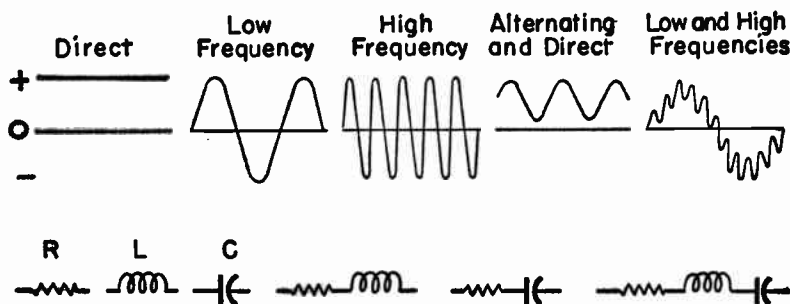

Fig. 4.—Waveforms of currents and potentials, and the elements in which they exist.

cycles and higher. These include (a) intermediate frequencies and (b) radio frequencies.

4. Combination currents and potentials, which consist of the above mentioned direct currents and potentials and of any kind of alternating current and potential flowing in the same circuit at the same time. Combination currents include also currents and potentials of two or more alternating frequencies in the same circuit at the same time.

The circuits in which the potentials and currents act consist of combinations of resistance, inductance, and capacitance, represented by R , L , and C at the bottom of Fig. 4. Actual circuits consist of combinations of resistance and inductance, of resistance and capacitance, and of all three elements, as represented toward the right. It is, of course, true that all circuits contain more or less inductance and capacitance, in addition to resistance, but the effects of inductance and capacitance may be negligible except at very high frequencies.

The accompanying table gives a summary of the effects of resistance, inductance and capacitance on the rate of flow of direct and alternating currents, and on the drop of direct and alternating potentials in these circuit elements. It must be kept in mind that no actual circuit may have only inductance, only capacitance, or only inductance and capacitance. All circuits must also have resistance. Then the effects on current flow and potential drop always will be some combination of the effects of resistance together with the effects of inductance or capacitance or both.

EFFECTS OF CIRCUIT ELEMENTS ON CURRENT AND POTENTIAL

	Resistance	Inductance	Capacitance
CURRENT RATE			
Direct	Flow is inversely as resistance.	Flow not retarded in any degree by inductance alone.	No continual flow, but only during charging of capacitor.
Alternating	Flow is inversely as resistance.	Flow is inversely as the frequency, also inversely as inductive reactance.	Flow directly proportional to frequency, but inversely as capacitive reactance.
POTENTIAL DROP			
Direct	Drop is directly as resistance.	No drop due to inductance alone.	No continued effect, but only during the charging of capacitor.
Alternating	Drop is directly as resistance. May be skin effect at very high-freq's.	Drop directly proportional to frequency, also directly as inductive reactance.	Drop inversely proportional to frequency, but directly as capacitive reactance.

Now let's see what will happen to currents in the loads of Fig. 5 when the frequency is varied. In each circuit is represented a source delivering alternating potential and current. In series with the load is either resistance, inductance or capacitance, and in parallel with the source is either one of these elements. Remember that the reactance of an inductance increases with frequency, while the reactance of a capacitance decreases with frequency.

In circuit 1 at low frequencies most of the current will go through the source bypass L and little current through C and the load. At high frequencies the division of current will be reversed.

In circuit 2 a resistor has been substituted for the bypassing inductance, with capacitance still in series with the load. Because of the manner in which capacitance reactance changes with

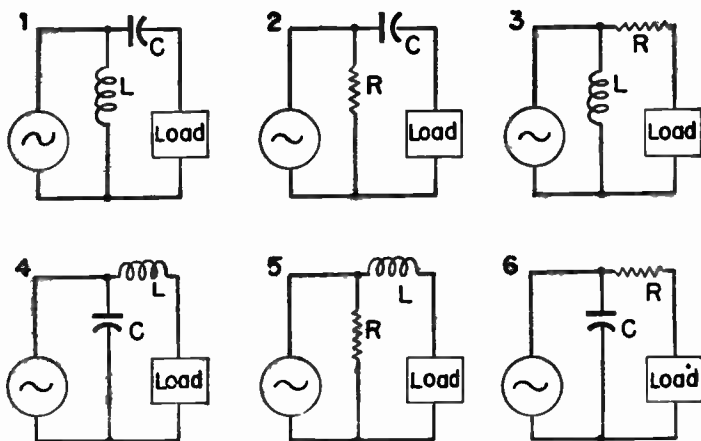

Fig. 5.—Combinations of capacitance, inductance, and resistance in a load circuit.

frequency there will be less load current at low frequencies and more at high frequencies, just as in circuit 1.

In circuit 3 a resistor has been substituted for the series capacitance of circuit 1, with an inductance across the source. Because inductive reactance increases with frequency there will be more current through the inductance and less through the load at low frequencies, while at high frequencies there will be less current

through the bypass inductance and more will be forced through the load. This is the same division of currents as in circuits 1 and 2.

In circuit 4 there is inductance in series with the load and capacitance across the source. Figure out what will happen as frequency changes from low to high. At low frequencies most of the current will go through the load, and at high frequencies most of the current will go through the source bypass. This is the opposite of current division with frequency in circuits 1 to 3.

In circuit 5 there still is inductance in series with the load, but the bypass capacitor across the source has been replaced with a resistor. Division of current with change of frequency will be like the division in circuit 4.

In circuit 6 we have a capacitor across the source, as in circuit 4, but the inductance formerly in series with the load is replaced with a resistor. Still the division of current with frequency is the same as in circuits 4 and 5.

By suitable connections of inductance and capacitance, or of either one together with resistance, we may cause almost any desired division of currents between a load and a bypass at either low frequencies or high frequencies.

In Fig. 6 we have assigned definite values to the inductance, capacitance, and load of circuit 1 in Fig. 5. The load resistance is 2,500 ohms. Reactances of the 1 millihenry inductance and of the 0.0025 mfd capacitance are shown on the diagram for a high audio frequency of 15 kc and for a low radio frequency of 600 kc. The load resistance and the capacitance reactance always are in series, and these two are in parallel with the inductive reactance, with the parallel combination connected across the source. Total current will be determined by the potential difference from the source and the parallel impedance of the whole

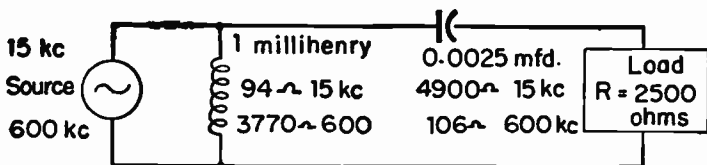

Fig. 6.—The manner in which reactances vary with frequency.

connected circuit. The division of current will be inversely proportional to the impedances of the inductor and of the capacitor and load in series. In this, as in all cases involving resistances and reactances or impedances we have to figure out the various values before knowing the division of current.

Assuming that the source furnishes a potential difference of 100 volts at each frequency we would have the following: At 15 kc the total current would be 1+ amperes, with only about 13 milliamperes in the load and the remainder in the inductor. At 600 kc the total current would only be about 64.8 milliamperes, with about 38.3 milliamperes in the load and 26.5 milliamperes in the inductor. Computing currents for one particular case, such as that of Fig. 6, gives us no information of general application. Every circuit has to be worked out according to the frequencies, resistances, and reactances.

Capacitors for Bypassing.—In order that the greater portion of a signal current may flow in a bypass capacitor, and only a relatively small portion in the unit which is to be bypassed, the capacitive reactance of the capacitor must be low in comparison with the impedance of the part bypassed. If it is a resistor that is to be bypassed then the reactance of the capacitor must be much less than the resistance of the resistor at the lowest frequency to be handled. If a choke or inductor is to be bypassed then the reactance of the capacitor must be much less than that of the inductor at the lowest frequency.

It is a general rule to make the capacitor of such capacitance that its reactance is between $1/10$ and $1/5$ of the resistance or impedance of the part bypassed. The reactance always is computed for the lowest frequency to be handled in the circuit. Although there is decreasing advantage in using capacitive reactance less than $1/10$ of the bypassed impedance, the ratio sometimes is made as much as $1/50$.

The chart of Fig. 7 may be used for estimating the capacitance required in bypass capacitors. This is an alignment chart with which you lay any straight edge, such as a ruler, on two known values on two of the scales, then read the third unknown value where the straight-edge crosses the third scale. The left-hand scale is for capacitive reactances of 10 ohms to 100,000 ohms. The center scale is for frequencies between 1 cycle and 8 mega-

cycles. The right-hand scale is for capacitances between 0.002 mfd and 20 mfd.

An example will show how the chart is used. Assume that it is desired to bypass a resistance of 10,000 ohms, and to have the capacitive reactance 1/10 of this number of ohms at a frequency of 50 cycles. This calls for a capacitive reactance of 1,000

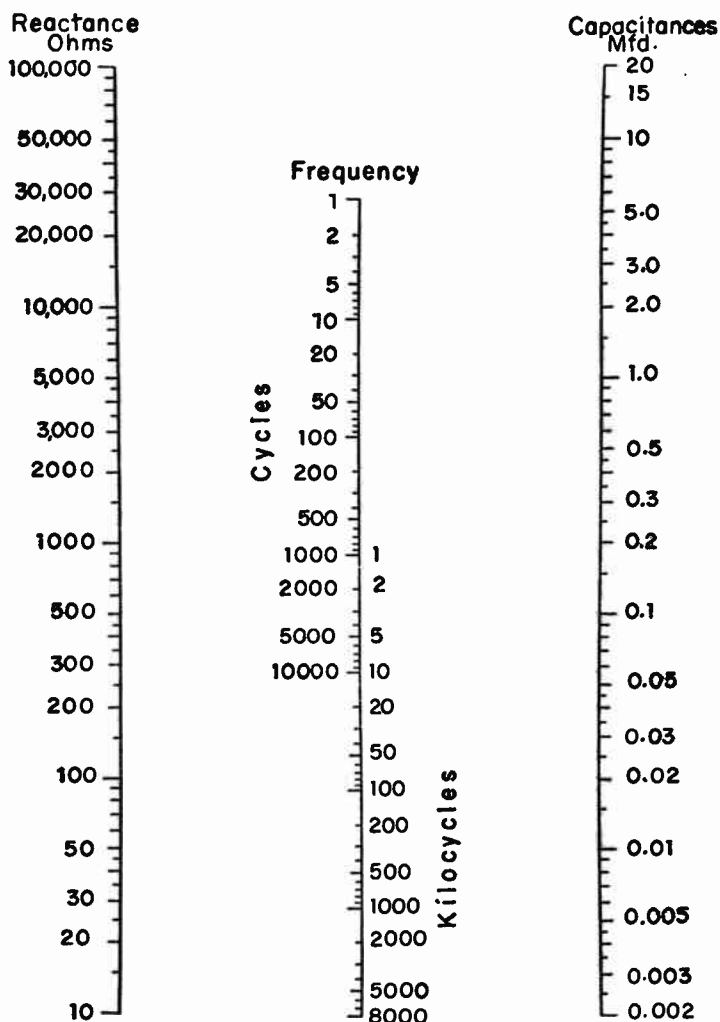

Fig. 7.—The chart for estimating capacitances required in bypass capacitors

ohms. The straight-edge is laid on the 1,000-ohm graduation of the left-hand scale and at the same time on the 50-cycle graduation of the center scale. The straight edge now crosses the capacitance scale, the right-hand scale, at a little above the graduation for 3 mfd. A capacitor of 3 mfd or greater capacitance would be needed.

The range of the chart may be extended to smaller reactances and higher frequencies by dividing all reactance values and multiplying all frequency values by the same number at the same time, or by multiplying reactances and dividing frequencies by the same number at the same time. For example, desiring a reactance of 6 ohms at 10 megacycles, lay the straight-edge on 60 ohms reactance and on 1 megacycle. So long as the product of reactance and frequency remains unchanged, the required capacitance remains unchanged. In the example we commenced with 6 ohms reactance and 10 megacycles frequency, the product of 6 and 10 being 60. We used scale values of 60 ohms and 1 megacycle, whose product is 60.

Audio-frequency bypassing requires large values of capacitance. These large values may be obtained economically by using electrolytic capacitors. Because of the considerable inductance and resistance in many types of electrolytic capacitors they are not suitable for bypassing at radio frequencies. For radio-frequency bypassing the capacitors should be of mica or paper dielectric types.

Where an electrolytic capacitor would form the only bypass in an r-f or i-f circuit the electrolytic should be shunted with a mica or paper capacitor whose capacitance is based on the radio or intermediate frequencies to be handled. Such a case is shown by Fig. 8, The plate and screen voltages for the i-f amplifier tube are taken from the left-hand end of the power unit filter resistor. Between this point and ground is filter capacitor *a*, which ordinarily would be an electrolytic type of 10 or more mfd capacitance. It is necessary to use also bypass capacitor *b*, which will be a mica or paper type with capacitance usually somewhere between 0.002 and 0.1 mfd. Capacitor *b* shunts capacitor *a*, or is in parallel with *a* between ground and the return ends of the plate and screen grid circuits of the i-f tube.

In Fig. 8 the plate and screen voltages for the output tube are

taken from the right-hand end of the filter resistor. Filter capacitor c forms an effective bypass to ground for the audio-frequency potentials and currents in the output tube circuit.

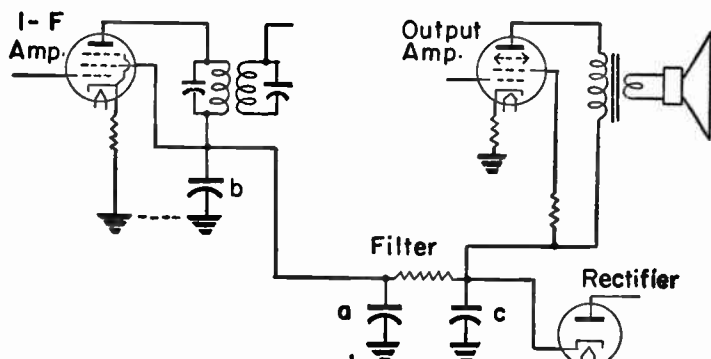

Fig. 8.—Electrolytic capacitors are themselves bypassed with paper or mica units for high frequencies.

No additional high-frequency shunting capacitor is required where the frequency is in the audio range.

Plate and Screen Decoupling.—With the connections to the i-f amplifier tube shown by Fig. 8 there will be a certain amount of coupling between the plate circuit and the screen grid circuit in spite of the connection of bypass capacitor b from these circuits through ground to the cathode. This coupling occurs partly because the reactance of capacitor b is common to both circuits.

More complete decoupling is shown by Fig. 9. Here the screen voltage and currents are taken from B+ on the power supply through resistor R_1 . This resistor and the resistance or im-

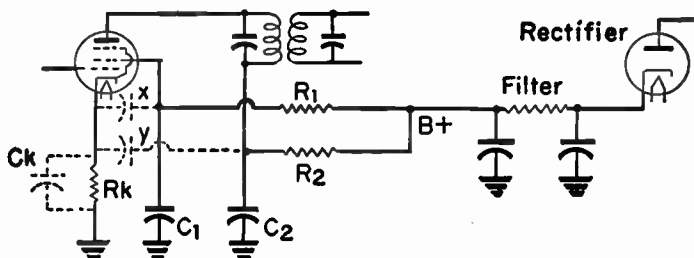

Fig. 9.—Decoupling capacitors and resistors for plate and screen circuits.

pedance of the power supply are bypassed by capacitor $C1$. Plate voltage and current are taken from the power supply through resistor $R2$. This resistor and the power supply are bypassed by capacitor $C2$. If the reactance of capacitor $C1$ is much smaller than the resistance and impedance of $R1$ and the power supply, alternating screen currents find easy passage through the capacitor to ground and are prevented from flowing in any great degree through the resistor and the power supply. The same thing applies to plate bypass capacitor $C2$ and the combined resistance and impedance of resistor $R2$ and the power supply.

Even with the resistors and bypasses as just described, and as shown by full lines in Fig. 9, there still will be coupling between plate and screen circuits because the currents in both circuits reach the cathode from ground by going through cathode resistor Rk . This resistor would be common to the plate and screen circuits, and, in addition, would be in the control grid circuit.

The coupling through resistor Rk may be reduced by using across this resistor a bypass capacitor Ck having very small reactance at the lowest frequency handled. If the cathode resistor is to remain without a bypass, as when degeneration is wanted, the screen bypass capacitor $C1$ should be replaced by a capacitor at X connected directly from screen to cathode. A suitable capacitor at X , and a resistor at $R1$ would quite completely decouple the screen from other elements.

The screen should have adequate decoupling because the screen, as we know, has much more control over plate current than has the plate itself. A small variation of screen potential causes changes of plate current as great as caused by large variations of plate potential. If lack of decoupling allows plate voltage changes or hum voltages from the power supply to act on the screen, this element will act much like a control grid in the tube and all these screen voltage variations will appear in the plate current of the tube.

If the plate bypass capacitor $C2$ of Fig. 9 is replaced with a capacitor at Y going from plate return directly to the cathode, this bypass will control degeneration. That is, were all signal variations of plate current to return to the cathode through capacitor Y , none would go through cathode resistor Rk and

there would be no plate circuit signal voltages fed back to the control grid circuit through the coupling of Rk . If bypasses were used at both X and Y the bypass Ck across the cathode resistor could be omitted.

The chief objection to the arrangement of Fig. 9 is the additional voltage drop through resistors $R1$ and $R2$, which has to be furnished by a higher output voltage from the power supply. With transformer-less receivers of the ac-dc type the drops in $R1$ and $R2$ might make undesirably low voltages for the plate and screen. Although Fig. 9 represents an i-f stage, the same methods of decoupling may be used for r-f or a-f stages, and with either resistance or transformer coupling between stages.

High-frequency Plate Bypass.—With any tube in whose output circuit we wish to have only audio frequencies it usually is desirable to connect a high-frequency bypass capacitor from plate to cathode or plate to ground, or, in any case, to connect such a bypass across the output load.

Fig. 10 shows three examples of such high-frequency bypassing. One bypass is capacitor $C1$ connected between the return for the detector diode plates and the cathode of the tube. In the secondary of the i-f transformer which feeds the diode detector are the intermediate frequency and the audio frequency which is the modulation frequency. In the detector output leading to the avc line and the volume control we wish to have only audio-frequency potentials and currents. Therefore, we bypass the i-f currents through capacitor $C1$ to the cathode, choosing a capacitance which has small capacitive reactance for the inter-

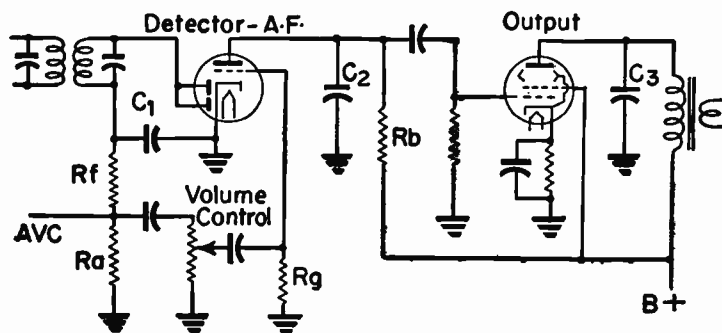

Fig. 10.—High-frequency bypassing in an audio amplifier.

mediate frequency. Any such capacitance will have high reactance at audio frequencies, and the escape of a-f signal potentials through $C1$ will be negligible. Capacitor $C1$ bypasses resistors Rf and Ra , also the volume control and grid resistor Rg . The reactance of the bypass capacitor is based on the effective resistance of all these bypassed parts and on the intermediate frequency. Capacitances of 100 to 300 mmfd are common in position $C1$.

The second example of high-frequency bypassing in Fig. 10 is capacitor $C2$, between the plate of the a-f amplifier section of the tube and ground. This bypass might be connected to the tube cathode rather than to ground. Here the bypassing is of any intermediate frequency current and potential which may have gotten past the detector and into the audio amplifier section of the tube. The resistance which is bypassed is that of plate load resistor Rb , or this resistance as slightly modified by the following coupling capacitor and the grid resistor for the output tube. The reactance of this bypass capacitor then will be based on the effective resistance in the coupling circuit (chiefly resistance Rb) and on the intermediate frequency. Capacitance values usually are about the same as used in position $C1$.

The third example of high-frequency bypassing is capacitor $C3$, between the plate of the output tube and ground. Instead of connecting this bypass to ground it might be connected directly to the tube cathode above the cathode resistor. The high frequencies to be bypassed here would be any intermediate frequencies which may have come through the amplifier, but more especially any frequencies which may result from oscillation generated in any of the circuits of the output tube. These oscillation frequencies may be above audibility, or they may be audible as whistles and squeaks of very high pitch. The impedance to be bypassed is that of the primary of the output transformer and of the power supply. The bypass capacitance may be based on some frequency in the high audio range, such as 15,000 to 20,000 cycles, and on the impedance mentioned. But because the frequencies seldom can be known with any exactness it is more usual to experiment with different bypass capacitances until the audio output is satisfactory. Lack of a bypass at $C3$ not only may cause high-pitched audible whistles,

but cause a considerable waste of output power and reduction of effective gain in the output stage. Bypass capacitances of 0.002 to 0.05 mfd are common in position C_3 .

Fig. 11 shows high-frequency bypasses on the plate of a pentode a-f amplifier and the plate of a pentode output tube. Bypass C_2 on the a-f amplifier serves the same purpose as bypass C_2 of Fig. 10. Likewise, C_3 serves the same purpose as C_3 in Fig. 10. In the output tube plate circuit is also a tone control

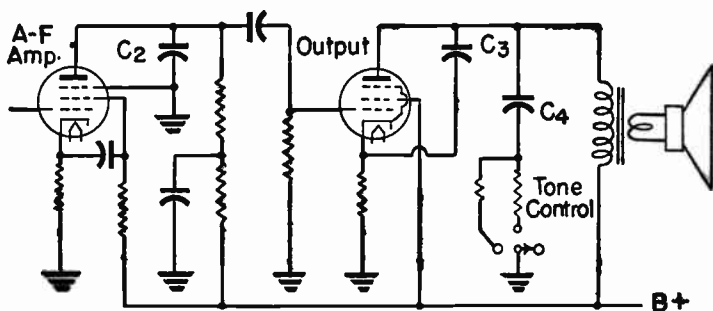

Fig. 11.—High-frequency plate bypasses and a tone control.

system consisting of capacitor C_4 which may be placed in series with either of two resistors and to ground through the tone control switch, or which may be left open-circuited in one position of the switch. With C_4 open-circuited the only remaining bypass is C_3 , which is the reason for using a bypass from plate to cathode in addition to the tone control. Plate and screen bypasses for the a-f amplifier of Fig. 11 are like those described for the i-f amplifier of Fig. 9.

High-frequency bypass capacitors in the plate circuits of push-pull power tubes are shown by circuit diagrams in the descriptions of push-pull amplifiers.

Choke Coils for Decoupling.—The objection of extra voltage drop in decoupling resistors R_1 and R_2 of Fig. 9 might be overcome by using decoupling chokes as at L_1 and L_2 of Fig. 12. Other than for substitution of chokes for the decoupling resistors the two circuits are alike. In circuits operating at radio and intermediate frequencies it is not difficult to obtain large inductive reactances with low resistances in air-core or powdered iron core choke coils. However, the cost of such chokes is so

much higher than that of resistors serving nearly the same purpose that the saving in cost of the lower-voltage power supply might be balanced by the cost of chokes. When plate and screen currents are small there will be but little drop of voltage in resistors whose resistance is amply great for decoupling. When

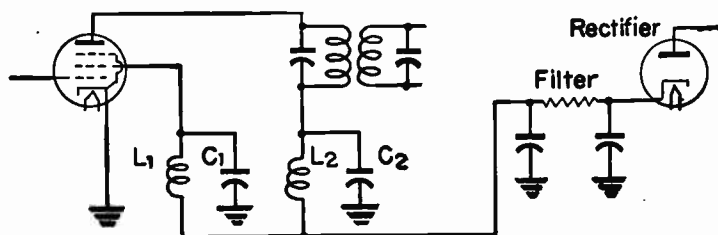

Fig. 12.—Decoupling chokes in plate and screen circuits.

the currents are large there will be a proportionately large drop of voltage in the resistors. Then decoupling chokes may be preferable to decoupling resistors, since there will be little drop in the small resistance of the chokes.

Due to the combination of distributed capacitance with the inductance of air-core chokes they may act like a series resonant circuit of small impedance at some radio or intermediate frequency. Iron-core high-frequency chokes usually have less distributed capacitance for a given inductance, and will be self-resonant at higher frequencies than air-core types.

In audio-frequency circuits the large inductance needed to secure enough inductive reactance calls for iron-core chokes. Their cost is high in comparison with that of resistors, and such chokes would be used only when the currents are large. The inductance of ordinary iron-core chokes decreases with increase of direct current in the windings. The inductive reactance is directly proportional to frequency, and may become much too small at low audio frequencies to be effective.

Positions of Wiring and Parts.—Even though decoupling capacitors, resistors and chokes are correctly used in radio apparatus it still is possible to have many undesired couplings and feedbacks. These couplings will occur through the capacitances existing between wiring leads and between metallic portions of many other parts. There may be also inductive couplings between many connections. Some of the precautions which may be

observed in avoiding such troubles will be mentioned in connection with Fig. 13, on which numbered parts correspond to similar numbers in following paragraphs. The placing of wiring and parts often is referred to as the "dress," and we speak of dressing the wires and parts in certain ways.

The lead from the antenna to the r-f grid (1) either should be kept clear of all other wiring or else dressed close to the chassis. This applies also to the signal grid lead to the converter (2) when connected to the antenna without an r-f stage. All control grid leads (1, 2, 3, etc.) should be kept well separated from all plate leads (4, 5, etc.). It is rather common practice to dress all the plate leads close to chassis metal and to keep all control grid leads as far as possible from the chassis. All leads to detector diode plates (6) should be treated just as are leads for control grids, keeping them separated from other wiring.

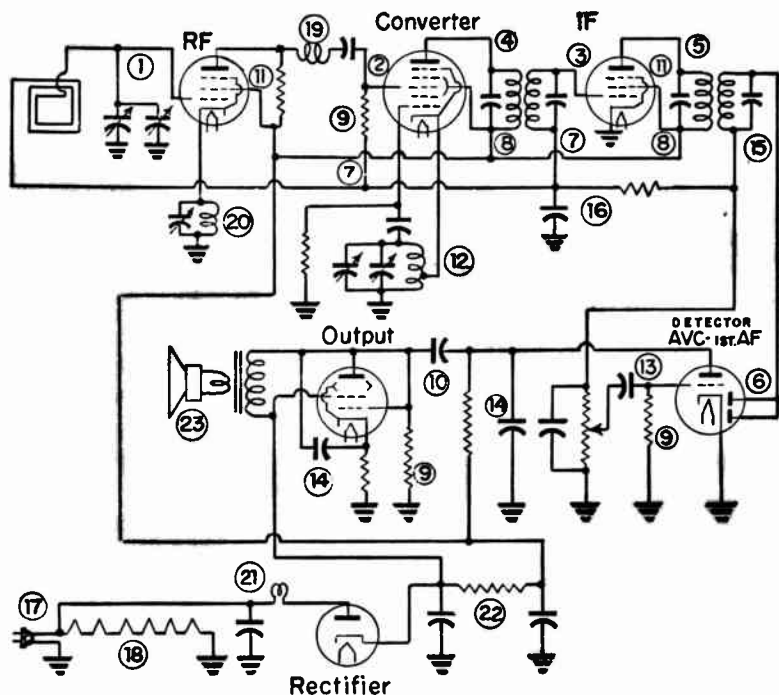

Fig. 12.—Points at which care should be used in dressing wires and parts

The leads for all control grids, all plates, and the diode plates should, in general, be made as short and direct as possible. Grid returns (7) and plate returns (8) for any one tube should be kept separated, at least as far as points where these returns are connected to decoupling capacitors. Grid resistors (9) preferably are mounted close to the socket of the tube to whose control grid they connect. This rule of mounting near the appropriate socket applies also to all coupling capacitors (10). Extra lengths of leads on these two parts are preferably left on their side which is away from the control grid.

Leads for the screen grids (11, etc.) are dressed close to the chassis, like the plate leads.

Leads for the oscillator circuit (12) on the cathode and oscillator grid sides should be kept separated from each other and from all other wiring so far as is practicable.

The audio coupling capacitor (13) which is between the volume control and the a-f control grid, also the leads on both sides of this capacitor, should be kept close to the chassis. This a-f coupling capacitor should be kept well separated from all high-frequency bypass capacitors (14) which are in the plate circuits. All parts in the detector system (15) and the avc system (16) are subject to pickup of power line and audio frequencies. They should be kept separated from power cords (17) and heater circuits (18). The same precautions apply to all phonograph jacks, switches and connections, which ordinarily lead more or less directly into the detector and a-f amplifier systems.

Inductors or choke coils which carry radio frequency currents are kept close to chassis metal unless they have individual shielding cans. This rule would apply to any filter chokes, including peaking coils (19) and wave trap coils (20).

The a-c line connection (17) and all heater wiring (18) should be dressed tightly against the chassis metal and kept as far as possible from all parts carrying audio frequencies. The two sides twisted pair or parallel conductor wire so far as this is possible. of all circuits carrying power-line currents should be run with Any excess length of leads to pilot lamps (21) should be cut out, and the remaining wire kept close to chassis metal.

In general, any excess lead length which cannot readily be cut off is dressed back toward the transformer or other part into

which the leads extend, and the extra lengths (except with control grid leads) are dressed down onto the chassis.

The smaller the resistances and impedances in all parts of the power supply (22) the smaller will be the couplings between circuits fed from the supply. From this standpoint, filter chokes are preferred to filter resistors, and power transformers with low resistance windings are an advantage.

Permanent magnet types of loud speakers should not be mounted too close to any amplifying or oscillating tubes. A powerful magnet will deflect the electron streams in tubes which are in the strong part of the magnetic field.

Paper-dielectric capacitors have one end or one pig-tail lead identified by the word "ground" and by a band of black or some color extending all the way around the end. The end or lead so marked is the one connected to the outside of the foil in the capacitor. This marked end of the capacitor always should be connected to the chassis or to ground when either end of the capacitor is to be thus connected. Then the outer layer of foil in the capacitor acts much like a grounded shield.

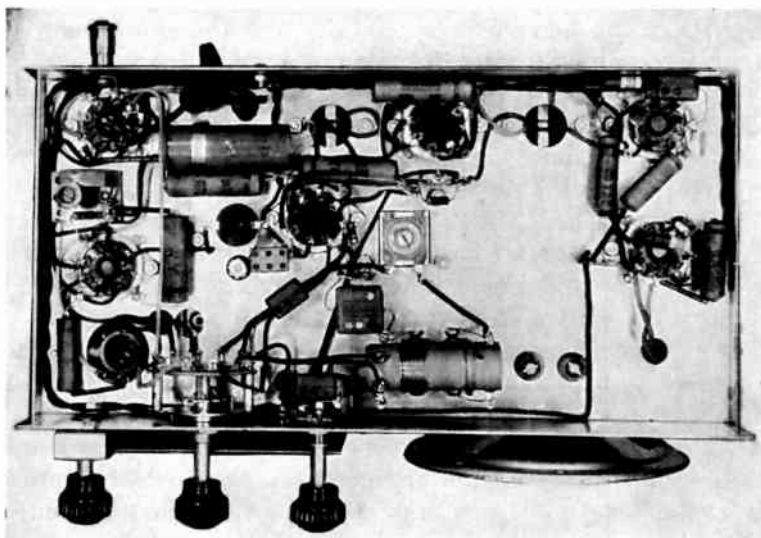

Fig. 14.—In simple receivers having ample chassis size it is easy to separate the parts of circuits.

All metallic parts solidly attached to the main body of the chassis are considered as being the chassis ground or chassis metal. This includes end plates of tuning capacitors in many designs, also any partitions or shelves for mounting the parts. There is quite effective shielding between any two parts or sets of parts mounted above and below the chassis base or on opposite sides of any partition or shelf.

The greater the gain in any amplifier or any stage the greater is the need for decoupling. Also, there is more likelihood of undesired couplings the higher the frequencies at which the amplifier or stage operates.

Shielding.—Undesired couplings in radio apparatus may result when a varying magnetic field produced in one part passes through some other part. Then there may be electromagnetic induction. Varying magnetic fields are produced in power transformers, power supply filter chokes, and in all coils which carry signal currents at any frequency. In the coils which carry signal currents there may be induced extra emf's by any magnetic field whose lines cut the coil turns, these emf's being in addition to the signal emf's intentionally induced in the coils.

Such unwanted inductive coupling is reduced or prevented by

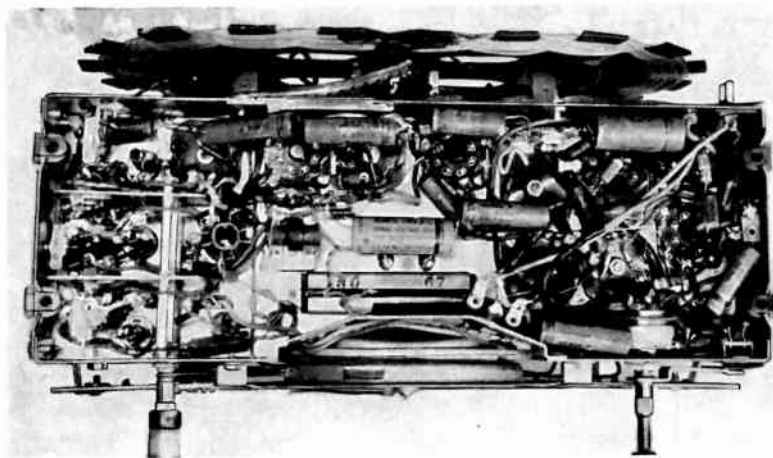

Fig. 15.—Separation of parts and dressing of leads becomes more difficult in the more elaborate receivers.

the use of metallic shields which partially or wholly enclose either or both of the parts between which there might be coupling. When the lines of some external magnetic field reach the metal of the shield the lines induce eddy currents in the metal. These eddy currents then have magnetic fields of their own, and these eddy current fields are of such magnetic polarity as to oppose the external fields.

The greater the conductivity of the shield metal the stronger will be the eddy currents and their fields in proportion to the external magnetic field, and the more effective will be the shielding. Shields made of copper and of aluminum have low resistance, and high conductivity. The thicker the shield metal the less is its resistance, and the greater its conductivity. Rather fortunately, the effectiveness of any given shield increases with increase of frequency. This makes it fairly easy to shield parts operating at radio and intermediate frequencies.

At power-line and audio frequencies the effectiveness of non-magnetic shielding metals decreases, because the eddy-current

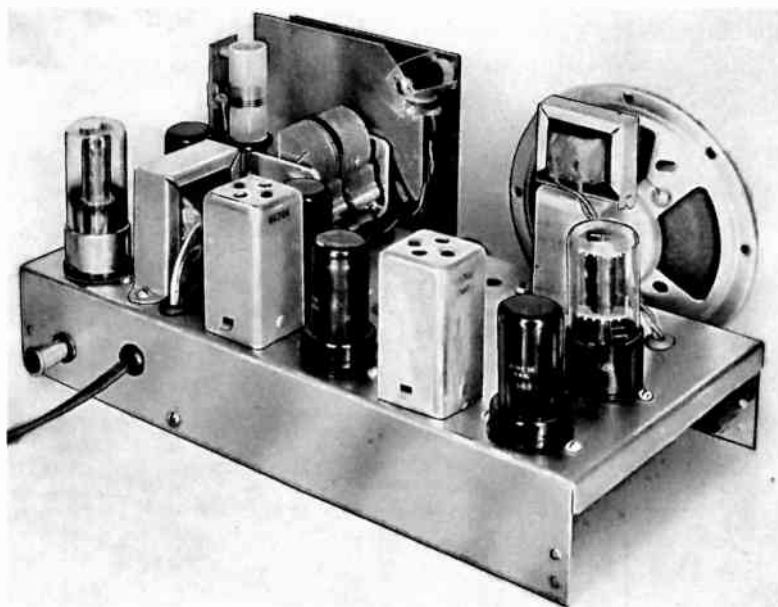

Fig. 16.—Parts which are shielded on the top of a radio chassis.

effect falls off with drop of frequency. Then it may be necessary to use shield metal of iron or steel, which is magnetic. The effect of a magnetic shield is to carry the lines of an external field through the shield and around the parts enclosed within the shield. That is, the magnetic lines of the external field flow through the iron or steel of the shield rather than through the space within the shield. The greater the permeability of the iron in the shield the more effective is its action.

If the chassis of Fig. 16 is examined with reference to shielding we note first that the two i-f transformers are enclosed within shielding cans. Some of the tubes have metal envelopes which are grounded to the chassis metal through one of the tube base pins. Then the tube envelopes form shields. The power-supply filter choke is between the tube at the extreme left and one of the i-f transformers. This choke is only partially enclosed by its metal frame or housing, and so may radiate a magnetic field. However, this radiation is at power line frequency and all of the parts around the choke operate at radio and intermediate frequencies, and have relatively little tendency to pick-up the power line frequency. Were this choke near audio-frequency parts the pick-up might be troublesome.

In addition to magnetic or inductive couplings there may be many electrostatic couplings between parts of radio apparatus. Electrostatic coupling occurs with parts which have capacitance. There is capacitance between any two conductors which are separated by insulation. When there is a change of electric charge on one of the conductors there will be a corresponding change of charge on the other, because of the electric field in the dielectric or insulation between them. This is the principle of all capacitors, which we think of as at the left in Fig. 17. But even though the two conductors are connected together through more

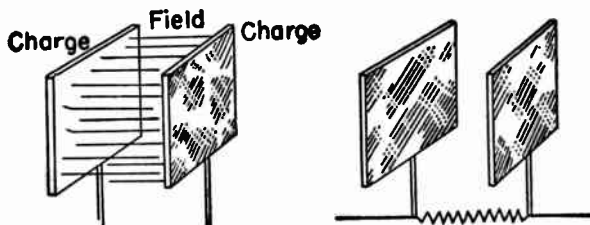

Fig. 17.—There may be capacitive coupling between parts connected through resistances.

or less resistance, as at the right, there will be an electrostatic field between them when they are at different potentials. Different potentials really mean different degrees of charge, and between charges which are relatively positive and negative there must be an electric field.

When the lines of an electric or electrostatic field reach the surface of a metallic shield the conductor of which the shield is composed is given an electric charge. Free electrons in the shield metal pass to the outer surface and distribute themselves over that surface when the external field is of such polarity as to induce a negative charge on the shield metal. If the field is of the opposite polarity the free electrons are driven to the inner surface of the shield. In any case, the surface of the shield acquires an electric charge which offsets the effect of the ex-

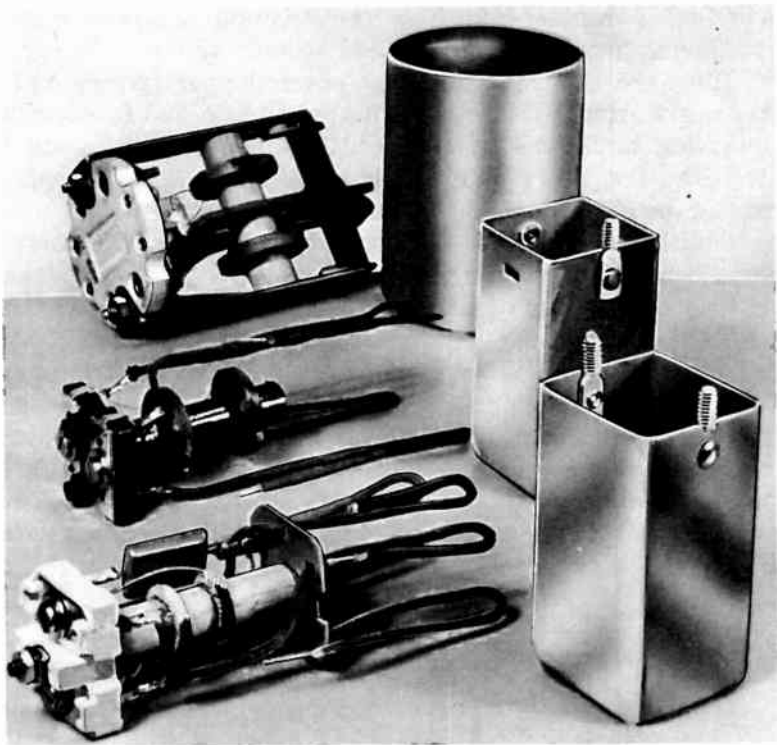

Fig. 18.—Shielding cans and the I-f transformers which they enclose.

ternal electric field. Then the lines of that field end on the charge induced on the shield metal, and do not pass through to whatever may be enclosed within the shield.

When a coil is enclosed within a metallic shield the effective inductance of the coil becomes less than when no shield is used. Then the coil has to have more turns or length or diameter than without a shield. Some energy from the magnetic field of the coil itself is used in production of eddy currents in the shield, which means greater high-frequency resistance or loss. The increase of losses and the reduction of inductance add up to a lower Q-factor for the shielded coil than when there is no shield.

To have reasonably small losses the diameter of the shield or the distance across a square shield is made equal to one and one-half to two times the coil diameter. The length of the shield is made such that it clears both ends of the coil by one-half to one times the diameter of the coil. The greater the diameter and length of the shield the less is the energy loss. The oscillator coil in a superheterodyne receiver should be well shielded. This sometimes is accomplished by placing the oscillator coil under the chassis and well separated from other parts.

As mentioned before, some metal-envelope tubes are designed for using the envelope as a shield through its connection to chassis ground from one of the base pins. Some glass-envelope tubes designed for use at intermediate and radio frequencies have internal shields in the form of a cage around the plate, with one of the base pins connected to this internal shield so that the shield may be grounded to the chassis metal. Other glass envelope tubes have part of the screen grid around the outside of the plate, permitting this part of the screen to act as a partial shield for the other elements within the tube. With some of the GT and GT/G type tubes there is a metal shell base connected to one of the base pins. This base forms part of the shielding when the pin is connected to chassis ground.

Unless a tube used at intermediate or radio frequencies has some type of shielding included in its own construction, it is desirable to enclose the tube within a close fitting metallic shield which is well grounded to the chassis. Several tube shields are shown at the right in Fig. 19.

Radio power transformers usually have electrostatic shields

between their primary winding and the secondaries. These shields consist of a sheet of thin copper placed around the primary winding and either connected to the core or else provided with an external lug or terminal. The core or the shielding lug should be grounded to the chassis metal. This shield helps to keep high-frequency line surges out of the radio apparatus, and helps prevent radio impulses from going out into the power line.

The transformer static shield is needed because there is capacitance between the primary winding and other windings which are insulated from the primary. The windings form large metal plates while the insulation forms the dielectric of a capacitor. The grounded shield between the windings acts much like the screen grid in a radio tube.

In high-frequency high-gain amplifiers it is desirable that parts in the output be shielded from those of the input in each stage, that the parts of each stage be shielded from those in other stages, that the two tuned circuits of the converter tube be shielded from each other, and that the parts and wiring of

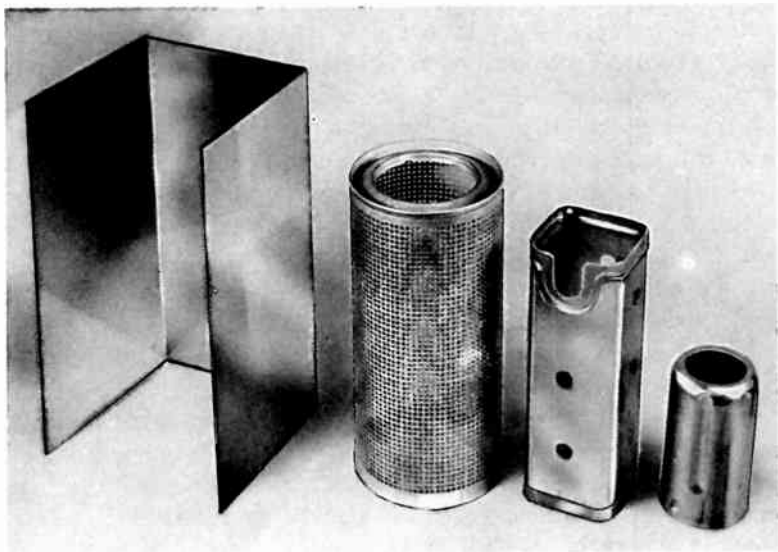

Fig. 19.—A stage shield at the left, and three tube shields at the right.

the power stage be shielded or well separated from those in antenna circuits.

When complete amplifying stages are shielded from each other the decoupling capacitors and any decoupling resistors or chokes should be inside of the stage shield for the stage which they are intended to decouple. If a tuned coil has its individual shield, any grid resistor and coupling capacitor in the same control grid circuit should be within the shield.

It should go almost without saying that all shields must be securely grounded, otherwise they increase rather than reduce unwanted couplings. Shielded wires should have their shield braid soldered or securely clipped to the chassis at both ends of the shield. Alignment and all other adjustments of shielded parts should be carried out with all shields in place and well grounded.

Wave Filters.—Wave filters consist of combinations of inductances and capacitances which are used in radio and television for the separation of frequencies from one another. Wave filters usually are employed to make either one of the four following kinds of frequency separation. The frequency characteristics are shown by Fig. 20.

1. To pass with little loss or attenuation all frequencies below one which is called the cutoff frequency, and to provide much greater attenuation for all higher frequencies. These are called *low-pass filters*.

2. To provide great attenuation for all frequencies lower than a cutoff frequency, but to have relatively small attenuation for all higher frequencies. These are called *high-pass filters*.

3. To have little attenuation for all frequencies between some certain frequency and another higher frequency, but to have relatively great attenuation for all frequencies both lower and higher than these two cutoff frequencies. These are called *band-pass filters*.

4. To have great attenuation for all frequencies in a band between a certain low frequency and another higher frequency, with relatively little attenuation for all frequencies both lower and higher than those between the two cutoff frequencies. These are called *band-stop filters* or band-exclusion filters.

In the upper row of graphs in Fig. 20 are shown the attenu-

ation characteristics of the four filter types. The curve of attenuation with frequency is the same as a curve of impedance with frequency. In the low-pass filter the impedance and consequent attenuation are small at low frequencies and large at high frequencies. In the high-pass filter the impedance variation is reversed. In the band-pass filter the impedance and attenuation are small for the passed band of frequencies, while in the band-stop filter the impedance and attenuation are large for the band which is stopped.

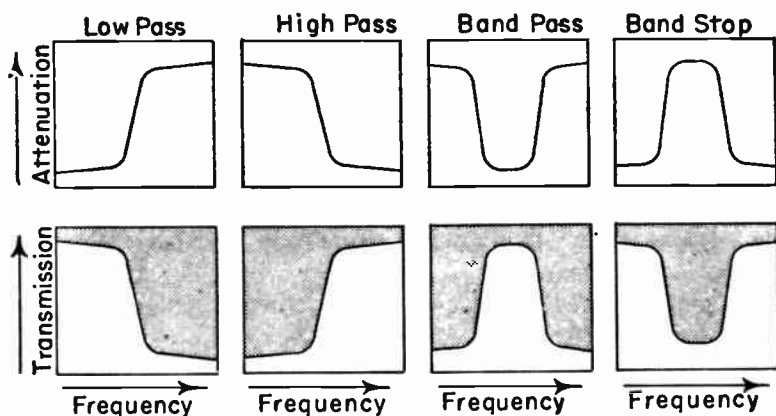

Fig. 20.—Attenuation and transmission characteristics of the four principal kinds of wave filters.

The lower row of graphs shows transmissions which correspond to the attenuations up above. A *transmission curve* is an *attenuation curve* upside down. The transmission curves show what frequencies get through the filter. For instance, the transmission of the low-pass filter is large in the low frequencies and small in the high frequencies. The degree of transmission is indicated by the unshaded areas of the graphs. The shaded areas indicate the degree to which frequencies are blocked off.

Wave filters make use of the characteristics of inductances and capacitances shown by Fig. 21. The performances of these circuit elements with varying frequency are familiar to us in all radio work, and are shown here merely for convenience of reference.

Inductance alone increases its inductive reactance and its

attenuation in direct proportion to increase of frequency. Its transmission then must decrease steadily as frequency increases. The capacitive reactance and attenuation of a capacitor alone becomes less as the frequency increases, they are inversely proportional to frequency. Then the transmission of a capacitor alone must increase as the frequency becomes higher.

Inductance and capacitance in series have decreasing impedance and attenuation with rise of frequency until the resonant frequency is reached. At still higher frequencies the impedance and attenuation increase again. Then for series inductance and capacitance the transmission becomes maximum at the resonant frequency, and is smaller at frequencies both below and above resonance. With inductance and capacitance in parallel there is maximum impedance and attenuation at the resonant frequency. Then the transmission of the parallel combination must fall to minimum at the frequency of resonance, and be greater at frequencies both below and above resonance.

A series resonant circuit is a type of band pass filter, as may be seen upon comparing the graphs of Figs. 20 and 21. The passed band centers around the frequency of resonance. A parallel resonant circuit is a type of band stop filter, with the stopped band centered around the resonant frequency.

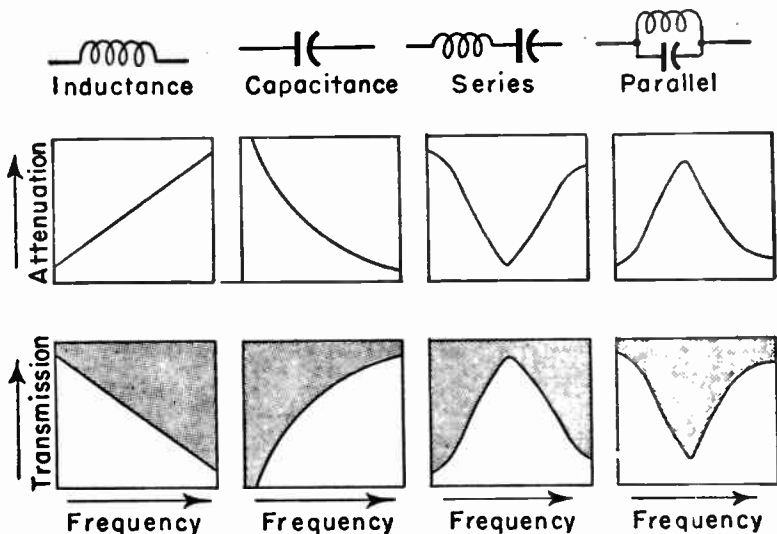

Fig. 21.—How inductances and capacitances affect attenuation and transmission.

You will note that the characteristics of the band-pass filter shown by Fig. 20 are similar to those for double-tuned i-f transformers in superheterodyne receivers. Therefore, two closely coupled parallel resonant circuits tuned to the same frequency (as in i-f transformers) form a type of band-pass filter.

Wave traps which are in series with antenna circuits or other signal circuits make use of parallel resonance to shut out an undesired frequency. Such wave traps are a form of band-stop filter. Wave traps connected between a signal circuit and ground, to bypass an undesired frequency, are series resonant circuits. Such wave traps are a form of band-pass filter.

The types of filters just mentioned make use of resonance to pass or reject frequencies near resonance. Low and high pass filters now to be examined do not have elements which are resonant in the bands of frequencies passed or rejected. Band pass and band stop wave filters include inductances and capacitances connected together in series or in parallel, these combinations will be resonant at frequencies inside of the band controlled.

Low-pass Filters.—The simplest low-pass filter consists of an inductance in series with one side of the line and of a capacitance shunted across the line, as at the left in Fig. 22. This is called an *L-section filter* because the arrangement of the inductance and capacitance resemble a capital letter L turned upside down. The performance of all wave filters depends not only on the values of inductance and capacitance, but also on the impedances or resistances of the source and the load. Such resistances are shown as R and R at the right in Fig. 22. In all the following discussions of wave filters it is assumed that the impedances or resistances of source and load are equal to each other, or that R and R are equal.

A cutoff frequency for any type of filter is the frequency at which the attenuation and transmission change more or less



Fig. 22.—A low-pass filter having a single L-section.

sharply. The cutoff in a low-pass filter would be the frequency at which there occurs a rather decided drop of transmission, and in a high-pass filter would be the frequency at which occurs a rather decided increase of transmission. No practical filter can have complete cutoff at one exact frequency, the cutoff always is more or less gradual. If we take any filter section, such as the L-section of Fig. 22, and follow it with another similar section, the cutoff of the two sections will be much sharper than for one section. With three similar sections, one following another, the cutoff becomes very sharp. The sharper the cutoff the steeper or more nearly vertical become the curves shown by Fig. 20. The sharpness of cutoff in any filter is increased by using elements having higher Q-factors, or having less energy loss and having greater reactance in proportion to their energy losses or resistances.

Inductances and capacitances for the low-pass L-section filter are chosen as follows, where the symbols are as shown by Fig. 22.

$$L, \text{ henrys} = \frac{0.3183 \times R, \text{ ohms}}{f, \text{ cycles}}$$

$$L, \text{ microhenrys} = \frac{318.3 \times R, \text{ ohms}}{f, \text{ kilocycles}}$$

$$C, \text{ mfd} = \frac{318\ 310}{f, \text{ cycles} \times R, \text{ ohms}}$$

$$C, \text{ mfd} = \frac{318.31}{f, \text{ kilocycles} \times R, \text{ ohms}}$$

These formulas show that the required values of inductance and capacitance depend on the terminal resistances, which are the resistances of source and load between which the filter is connected. The greater the terminal resistances the greater will be the required inductance and the smaller the required capacitance for the same cutoff frequency. However, the product of inductance and capacitance will remain the same for all terminal resistances.

Some values for L and C with 1,000-cycle cutoff frequency are shown for three different terminal resistances at the top of Fig. 23. If you multiply the number of henrys by the number

of microfarads shown on each diagram, the products always will be the same. Note that the highest terminal resistance, 1,000 ohms, requires the most inductance and the least capacitance, while the lowest terminal resistance, 200 ohms, requires the least inductance and the greatest capacitance.

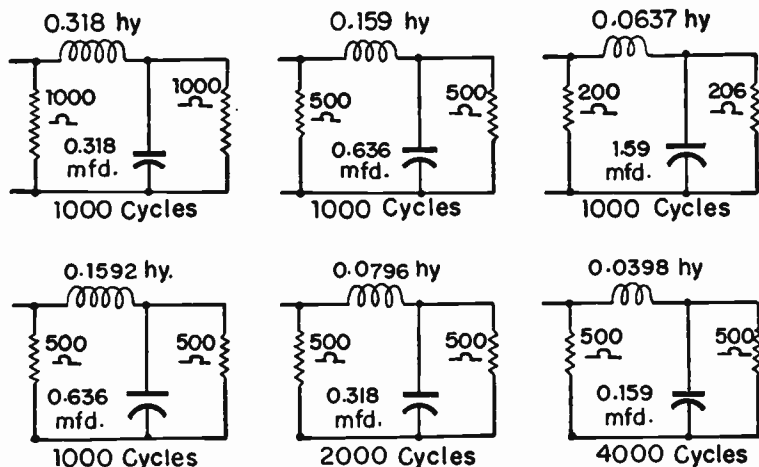

Fig. 23.—Inductances and capacitance values in low-pass L-section filters.

At the bottom of Fig. 23 are shown computed values of L and C for three different cutoff frequencies, all with the same terminal resistances of 500 ohms. Here we note that values of both inductance and capacitance are inversely proportional to the cutoff frequency, the lower this frequency the greater the inductance and capacitance, and vice versa.

Computing the resonant frequencies for all the combinations of inductance and capacitance of Fig. 23 would show that this resonant frequency always is one-half the cutoff frequency. For the 1,000-cycle cutoff combinations L and C would resonate at 500 cycles, for the 2,000-cycle combination at 1,000 cycles, and for the 4,000-cycle combination at 2,000 cycles.

Other types of sections used for low-pass filters are shown by Fig. 24. At the left is a *T-section* low-pass filter, so called because the arrangement of elements resembles the capital letter T. At the right is shown a *pi-section* low-pass filter, so called because the arrangement of elements resembles the Greek letter pi (π).

T-sections and pi-sections are symmetrical. That is, whether you "look into" the filter from either the source end or the load end there are the same elements arranged in the same fashion in series and shunt arms. In symmetrical structures the attenuation and transmission characteristics will not be altered so long

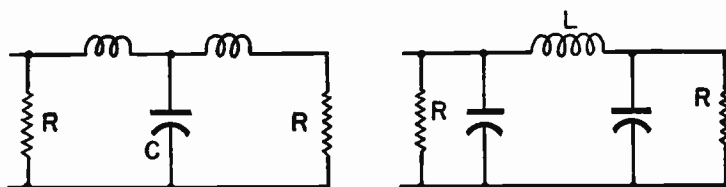

Fig. 24.—Low-pass filters of T-section (left) and pi-section (right).

as there is no change in the ratio between impedances in series with the line and impedances shunted across the line. The T-section is like two L-sections back-to-back. That is, were you to divide the capacitive reactance of the center capacitor into two parts and place one with each of the inductive reactances, you would have two L-sections. Similarly, the pi-section might be split to leave half the inductive reactance with each of the capacitive reactances, and there would be two L-sections.

In any type of filter having two or more inductances it is assumed, when making computations, that there is no mutual induction and no inductive coupling between these elements. With two or more capacitances it is assumed that there is no added capacitance due to the units being close together.

Doubtless you have noticed that the pi-section low-pass filter is the type so commonly used in power supply filter systems. In such filters the capacitances are made very large because the cutoff frequency is to be brought as low as possible, or as near to direct current as possible. Most of the decoupling combinations of capacitance and inductance used in radio apparatus are low-pass filters of either L-, T-, or pi-section types. In many of the decoupling filters the inductance is replaced by a resistance. The resistance-capacitance filter has a cutoff much less sharp than an inductance-capacitance type.

High-pass Filters.—Fig. 25 shows the arrangements of inductance and capacitance in high-pass filters of L-section, T-section, and pi-section. In all of these filters the capacitance or capaci-

tances are in series with one side of the line, while the inductance or inductances are shunted across the line. As the frequency increases the capacitive reactances drop lower, and it becomes

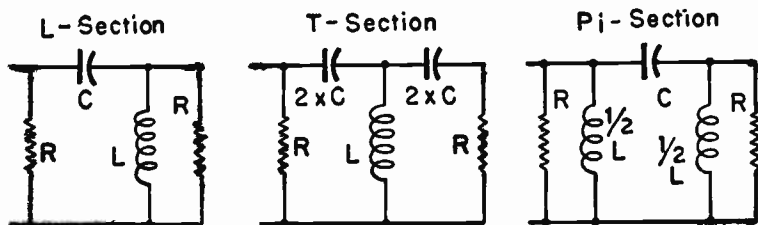

Fig. 25.—Connections for high-pass filters of three types.

increasingly easier for current to flow in the line. At the same time the inductive reactances rise higher, and it becomes increasingly difficult for current to flow through the inductances rather than on through the load.

The following formulas allow computing inductances and capacitances, L and C , for the high-pass filters. The cutoff frequency is represented by f , and the equal source and load resistances by R .

$$L, \text{ henrys} = \frac{0.0796 \times R, \text{ ohms}}{f, \text{ cycles}}$$

$$L, \text{ microhenrys} = \frac{79.58 \times R, \text{ ohms}}{f, \text{ kilocycles}}$$

$$C, \text{ mfd} = \frac{79\,580}{f, \text{ cycles} \times R, \text{ ohms}}$$

$$C, \text{ mfd} = \frac{79.58}{f, \text{ kilocycles} \times R, \text{ ohms}}$$

For any given cutoff frequency the product of inductance and capacitance remains the same no matter what the terminal resistance may be. However, the required inductance increases directly with terminal resistance, while the required capacitance decreases inversely with rise of terminal resistance. These things are true also of the low-pass filters. If you compute frequencies of resonance for the high-pass filters you will find these frequencies to be double the cutoff frequencies, whereas with low-pass filters the resonant frequencies are half the cutoff frequencies. With high-pass filters all of the values for inductances

and capacitances will be equal to one-fourth the values for inductances and capacitances in low-pass filters for the same cutoff frequencies and same terminal resistances.

Band-pass Filters.—In Fig. 26 are represented the elements of a band-pass filter. In series with one side of the line is a series resonant combination of an inductance L_a and a capacitance C_a . These two elements are chosen to have a resonant frequency midway between the cutoff frequency at the low end of the band to be passed, and the cutoff frequency at the high end of the band. For instance, were the band to be passed to extend from 3,000 to 4,000 cycles, the mid-frequency for resonance would be 3,500 cycles. Transmission through the line at various frequencies around the mid-frequency will be as shown by the curve, which is the transmission curve for series resonance in Fig. 21.

Across the line is a parallel resonant combination of inductance L_b and capacitance C_b . These two are chosen to be resonant at the mid-frequency. Then the transmission across the line is as shown by the curve which is the same as that for parallel resonance in Fig. 21. Now, at the mid-frequency, there is maximum transmission through the line from source to load, and minimum transmission across the line which would bypass the load. At either higher or lower frequencies there is decreasing transmission through the line and increasing transmission across the bypass. The band of frequencies passed extends from somewhat below the mid-frequency to somewhat above it. Using additional filter sections will make the sides of the transmission curves steeper and there will be sharper cutoffs at the band limits.

The following formulas are used for determining the in-

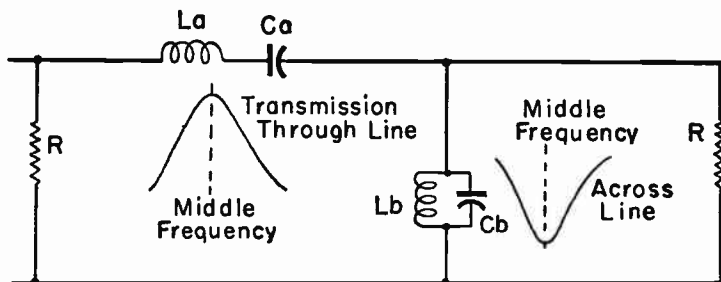

Fig. 26.—The operation of an L-section band-pass filter.

ductances and capacitances required in band-pass filters. In addition to the letter symbols shown on Fig. 26 the lower cutoff frequency is indicated by f and the higher cutoff by F in the formulas. Frequencies are to be in cycles per second. Source

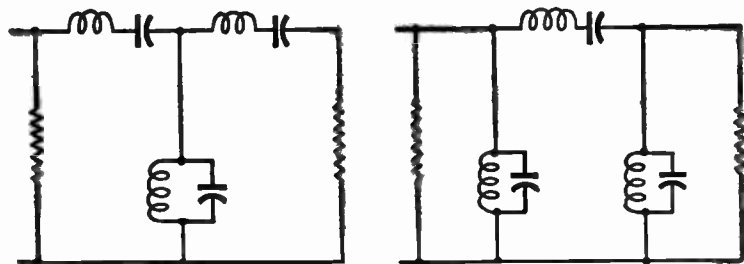

Fig. 27.—Band-pass filters of T-section (left) and pi-section (right).

and load resistances R and R are to be equal. Resistances are in ohms.

$$L_a = \frac{0.3183 \times R}{F - f}$$

$$C_a = \frac{79\,580 \times (F - f)}{F \times F \times f}$$

$$L_b = \frac{0.07958 \times R \times (F - f)}{F \times f}$$

$$C_b = \frac{318\,310}{R \times (F - f)}$$

The diagram of Fig. 26 shows connections for an L-section band-pass filter. The connections for T-section and pi-section band-pass filters are shown by Fig. 27.

Band-stop Filters.—If we interchange the series resonant and parallel resonant circuits of Fig. 26 the result is a band-stop filter as shown by Fig. 28. The transmission curves stay with their types of elements. Now we have minimum transmission through the line from source to load at the mid-frequency of the band to be stopped, and at the same time have maximum transmission of this mid-frequency across the line or bypassing the load. Then a band of frequencies extending each way from the mid-frequency will be greatly attenuated, while frequencies

both lower and higher than this band will pass with comparatively little attenuation from source to load.

Following are formulas for inductances and capacitances re-

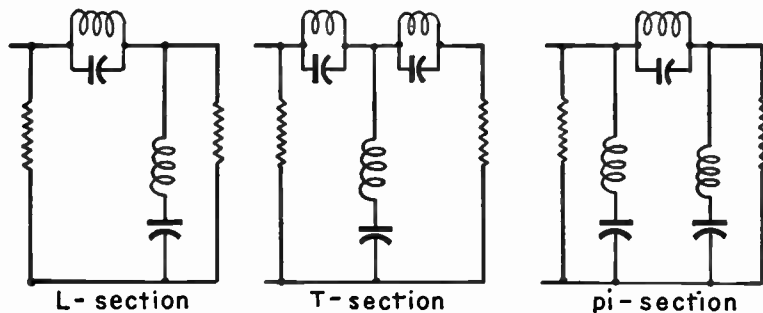

Fig. 28.—Band stop filters of three different section types.

quired for band-stop filters. The letter symbols are as shown on Fig. 28 and as used in the formulas for band-pass filters.

$$L_a = \frac{0.3183 \times R \times (F - f)}{F \times f}$$

$$C_a = \frac{79\,580}{R \times (F - f)}$$

$$L_b = \frac{0.07958 \times R}{F - f}$$

$$C_b = \frac{318\,310 \times (F - f)}{R \times F \times f}$$

The filters which have been shown and for which formulas have been given are the simplest types for each kind of frequency separation and for each type of section. They are called *constant-K* filters because of the constant relations between impedances in the series and shunt arms. The principles of variation of reactances with change of frequency, and of resonant combinations, are applied in a great many other ways in filters having a variety of transmission and attenuation characteristics.

Fig. 29 shows at the left two low-pass L-sections in which there are parallel resonant and series resonant combinations of inductance and capacitance. At the right are shown two high-pass L-sections in which resonance is employed. These are four

examples of the many which are called *derived* types. Such types may be designed to provide attenuation curves with sharper cutoffs than constant-K filters will give.

Filters of various types are used in radio transmission for such purposes as single side band radiation and vestigial side

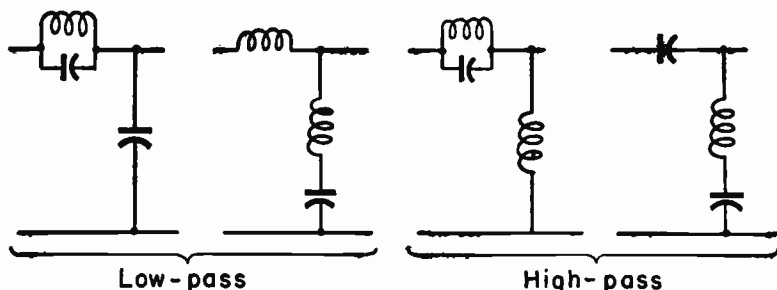

Fig. 29.—Low-pass and high-pass filter sections having resonant elements.

band radiation. They are used to reduce or prevent harmonics in the output of oscillators. Filters of rather elaborate types have been employed in the antenna circuits called band selectors. Filters are necessary in telephone and telegraphy for frequency separation and suppression.

REVIEW QUESTIONS

1. May a feedback coupling cause degeneration, regeneration, or either one?
2. Which are most commonly used for preventing undesirable feedbacks; resistors, capacitors, or inductors (coils)?
3. What type of signal currents are bypassed with a capacitor connected between detector plate and either the cathode or ground?
4. Is it usual practice to dress plate leads or control grid leads close to chassis metal, or should these two kinds of leads be run close to each other?
5. Should a power transformer be mounted at the r-f end or the a-f end of a chassis?
6. Should metal used for shielding be of high or low resistance? Under what conditions should magnetic metal be used for shielding?
7. Is the filter system used in most power supplies of the high-pass or the low-pass type? Is it of L, T or pi section when having capacitor input from rectifier to first filter section?
8. In a high-pass filter will capacitors be in series with the line, or shunt across the line?

Chapter 5

RECEIVER AND AMPLIFIER PERFORMANCE

If you were asked to measure the performance of a radio receiver, what items should you check? The answer is, you should measure five characteristics: (1) tuning, (2) sensitivity, (3) selectivity, (4) noise, and (5) fidelity. These are the performance characteristics measured with great precision by engineers who design radio apparatus. Their measurements, and alterations which improve performance, take weeks in the design laboratory. At the other extreme of time spent on checking is the "once over" given by the radio technician to a simple receiver following some small job in the service laboratory. In between the extreme lie all degrees of completeness of measurements.

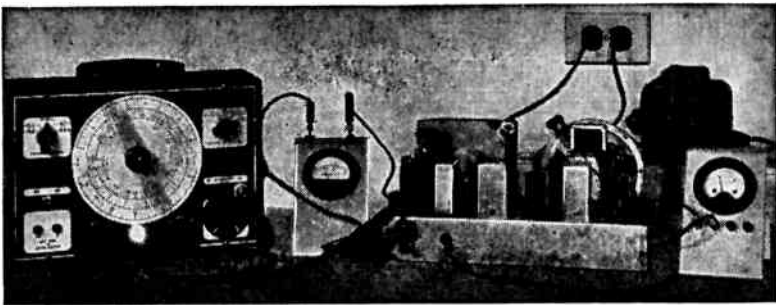

Fig. 1.—Testing sensitivity by means of servicing instruments.

In following pages we shall discuss the five tests for performance as they may be made in the service laboratory. At the same time we shall point out the more common causes for poor performance, and some suitable remedies.

Standardized Test Conditions. — In order that performance tests may indicate true conditions it is necessary to follow a rather definite and orderly procedure. The first step is measurement of power supply voltage.

For all line-power receivers and amplifiers, including television and ac-dc sets, the standard line voltage is 117 volts effective or r-m-s for a-c lines and 117 volts for d-c lines. If line voltage is higher or lower the difference must be considered, or a voltage adjusting power transformer may be used between line and apparatus tested.

For automobile radios the standard test voltage is 6.6 volts at the terminals of a storage battery or other d-c power supply. A battery preferably is kept on a trickle charger to maintain this voltage. For farm-light radios the standard test voltage is 36 volts d-c at the battery terminals.

The next step is measurement of all plate voltages, screen grid voltages, and control grid bias voltages; comparing them with voltages listed in service data for the receiver or in published operating conditions for the tubes. If the tube voltages are normal, and if the apparatus reproduces sound without faults apparent to the ear, it may be assumed that the tubes are in good condition. If there can be any doubt, all of the tubes should be tested before proceeding further.

For receivers operating in the standard broadcast band tests may be made at each of seven radio frequencies; 540 kc, 600 kc, 800 kc, 1,000 kc, 1,200 kc, 1,400 kc, and 1,600 kc. It is more usual practice to make tests at only 600 kc, 1,000 kc, and 1,400 kc, or sometimes at only 600 kc and 1,400 kc, and again at only 1,000 kc.

For other r-f frequency bands tests are made at frequencies near the bottom, middle and top of each band, or sometimes only near the top and bottom, or possibly only at a frequency near the center of the band.

The r-f signal is, of course, furnished by a signal generator. Unless stated otherwise for certain tests, the r-f signal is modulated 30 per cent at an audio frequency of 400 cycles.

The greatest difficulty in making standard tests is in obtaining signal generator outputs of known voltages. This is because few service types of generators have accurately calibrated attenuators and outputs. Such a design usually includes an electronic voltmeter or a thermocouple meter at the input to the attenuator inside of the generator, where the signal strength always is high enough to be measured. Then the adjustable attenuator for-

lowing this meter is calibrated on its scale or by means of a graph curve used with the scale. Fig. 2 shows one arrangement.

There are four standard signal strengths, as follows:

50 microvolts or 86 db below one volt, a "distant signal."

5 millivolts or 46 db below one volt, the "mean signal."

0.1 volt or 20 db below one volt, a "local signal."

2.0 volts or 6 db above one volt, a "strong signal."

When one of these voltages or signals is called for at the generator output, and receiver input, anything within 10 per cent in the standard broadcast band or within 25 per cent in the higher short-wave bands ordinarily is satisfactory.

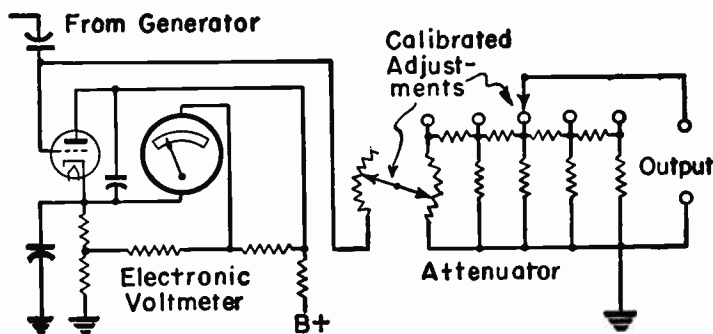

Fig. 2.—Voltmeter and output attenuator for a signal generator.

When making measurements on ac-dc receivers and on any other apparatus in which one side of the a-c power line is connected directly or through large capacitance to the chassis, difficulty will be avoided by using an insulating transformer between the line and the apparatus tested. The transformer must have separate primary and secondary windings, and between the windings should be an effective static shield which may be grounded. The turns ratio may be one-to-one, or the transformer may have taps for adjusting the voltage applied to the apparatus with line voltages below or above the standard 117 volts.

When an insulating transformer is not used, and the generator and tested apparatus are plugged into the same power line, there is danger of damaging the attenuator of the generator by current through the common ground connection unless an insulating or

blocking capacitor is connected in the ground line between generator and apparatus on test. Without having the static shield of a transformer grounded, most receivers pick up unpredictable signals from the power line. The power line signals mix with the generator output in the amplifier circuits and affect the amplifier output.

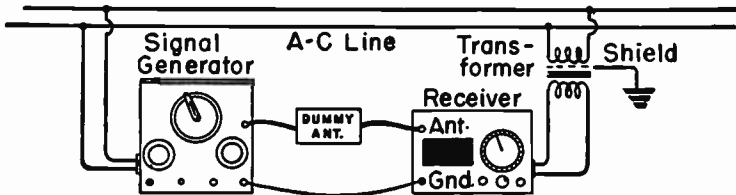

Fig. 3.—Receiver power taken through an insulating and shielding transformer.

If the tested receiver is a type designed to take r-f signals from the power line this pickup may be allowed by connecting a capacitor of about 0.005 mfd between the primary and secondary of the insulating transformer. The capacitive reactance is very high at the power-line frequency, and low for radio frequencies. While signal input is from the generator this capacitor should not be connected. Fig. 3 shows the connections for the generator and receiver with the receiver power taken through the insulating transformer.

If the receiver has a tone control it is set for high frequencies or treble unless otherwise specified for some tests. A selectivity control, if provided, is set for maximum selectivity. If there is a sensitivity control it ordinarily is set for maximum sensitivity or for distant reception unless instructions for a test state otherwise.

Output Measurement.—The output of the receiver or amplifier is connected to a dummy load resistor instead of to the loud speaker while making measurements. Connections are shown by Fig. 4. At the left the voice coil leads of the speaker have been disconnected from the secondary of the output transformer. Across the secondary is connected the dummy load resistor R . The output meter is connected across the ends of this resistor. The output meter may be a rectifier type a-c voltmeter or may be an electronic voltmeter.

The reason for using a dummy load resistor instead of making

measurements on the voice coil is that the impedance of the loud speaker varies with frequency. Then voltages indicated by the output meter would be those existing across a varying impedance, which usually would have minimum value around 400 cycles and would have much higher values at lower and higher frequencies. Under such conditions a given output voltage would not be comparable with voltages at other frequencies. Furthermore, the power tube or tubes of the amplifier would be working into a varying impedance.

The resistance of load resistor R is made equal to the impedance of the speaker voice coil at 400 cycles. For most loud speakers this impedance is somewhere between three and eight ohms, quite often being between three and four ohms for speakers up to eight or ten inches in diameter, and between six and eight ohms for diameters of ten inches or more.

The wattage rating of the dummy load resistor should be at least four times the maximum output of the amplifier in watts. A high power rating for the resistor will prevent overheating and consequent change of resistance.

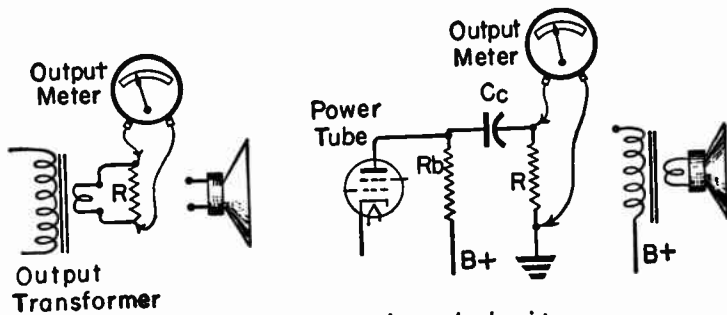

Fig. 4.—Connections for dummy load resistors.

At the right in Fig. 4 are shown connections for a dummy load resistor to the plate of a power tube instead of to the speaker voice coil circuit. The primary of the output transformer is disconnected. To the power tube plate which formerly was connected to the transformer is connected resistor R_b , whose other end goes to $B+$ where the transformer primary is connected. The resistance of R_b should be such as will leave the power tube plate voltage the same as with the transformer primary in circuit.

To the power tube plate and one end of resistor R_b is connected a paper dielectric capacitor C_c whose capacitance should be at least one mfd, and preferably more, to lessen its reactance at low audio frequencies. Between the capacitor and ground is connected the dummy load resistor R , whose resistance should be equal to the recommended load resistance for the power tube or tubes used in the amplifier.

Actual operating conditions would be more nearly matched were resistor R_b of Fig. 4 replaced by a high-inductance choke L_b as at the left in Fig. 5. The change of inductive reactance in L_b with change of audio frequency then will be similar to the

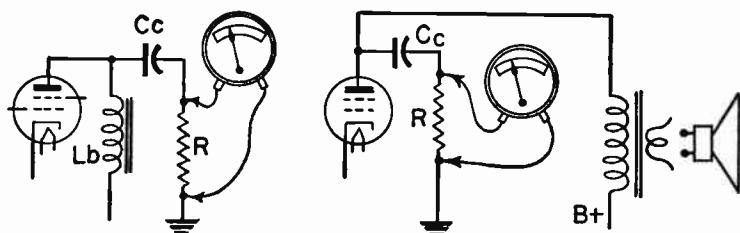

Fig. 5.—Dummy load resistors used with output choke and with transformer primary for the B-supply.

change in the primary of the output transformer. At the right in Fig. 5 are shown connections for using the primary of the regular output transformer in the same manner as the choke is used at the left. The secondary of the output transformer is disconnected from the loud speaker voice coil so that varying speaker impedance will not affect the measurements. The primary of the transformer remains connected between the power tube plate and B+. To the power tube plate and one end of the transformer primary is connected capacitor C_c , with the dummy load resistor R between this capacitor and ground. As always is the case, the output meter is connected across the dummy load resistor.

If two or more power tubes are connected in parallel the resistance of dummy resistor R as computed for a single similar tube is divided by the number of tubes in parallel.

With power tubes in push-pull the computed resistance for

the dummy load resistor is the resistance to be connected across the output of each tube. A single dummy resistor may be connected across the output of either push-pull tube, with the ends of this resistor connected to the output meter. It is possible also

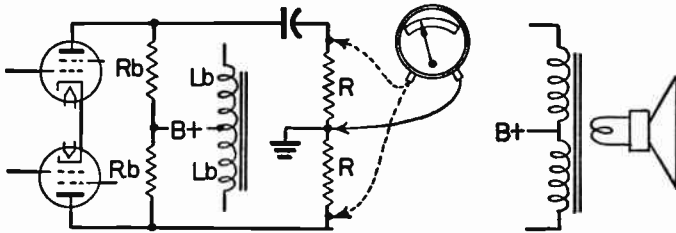

Fig. 6.—Connections of dummy load resistor and output meter to push-pull power tubes.

to use a center tapped dummy load resistor with the resistance of each half equal to the value computed for one push-pull tube. The power tube plates are connected to the outer ends of the tapped load resistor, as in Fig. 6. The center tap of the resistor is grounded. The output meter is connected across either half of the load resistor, or across first one half and then the other half to measure the output of each tube. The B-supply for the power tube plates may be furnished through either a center-tapped resistor $Rb-Rb$ or else through a center-tapped choke $Lb-Lb$.

Decibel Measurements.—Many output meters have scales graduated in decibels as well as in a-c volts. When the decibel scale is used it is assumed that the output meter is connected across a resistance or impedance for which the scale is calibrated. The calibration usually is for either 500 ohms or 600 ohms. When the meter is connected across a load whose value is anything other than for which the calibration is made, the numbers of decibels indicated by the meter are not the true numbers of decibels of voltage in the circuit.

The impedance between the output terminals of some public address and other commercial amplifiers may be either 500 or 600 ohms, or may be adjusted to one of these values. Then a suitably calibrated decibel meter will show actual changes in decibels of voltage or power when connected across the output terminals.

When an output meter is connected in any of the ways shown by Figs. 4 to 6 it seldom would be across a resistance of either 500 or 600 ohms, because recommended plate load resistances and loud speaker voice coil impedances ordinarily are not of these values.

With loads other than that for which a decibel meter is calibrated it is necessary either to add to or else to subtract from the indications some number of decibels which depends on the actual load across which the meter is connected. A decibel meter is simply an a-c voltmeter whose scale is graduated in decibels. The decibel scale has its zero point somewhere between bottom and top of the graduation, with "decibels down" or minus on the left of the zero point, and with "decibels up" or plus on the

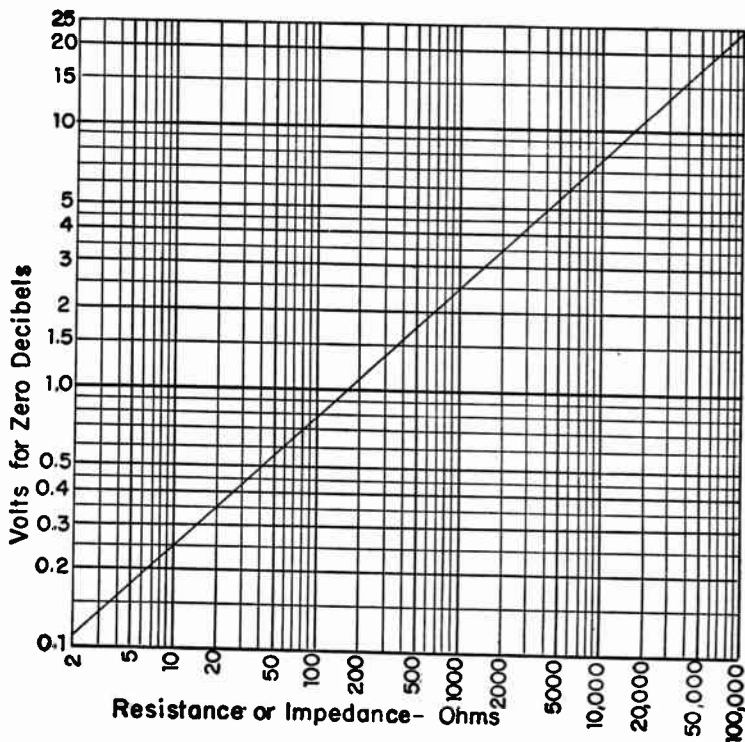

Fig. 7.—Voltages for zero decibels when power is six milliwatts in various values of connected resistance.

right. The position of the zero point, or the number of a-c volts to which it corresponds, is fixed by the load for which the meter is calibrated. For calibration at 500 ohms the decibel zero point corresponds to 1.732 a-c volts. For 600 ohms it corresponds to 1.897 a-c volts.

The graph of Fig. 5-7 shows where the point for zero decibels would be placed on a scale for a-c volts with load resistance calibration anywhere between two ohms and 100,000 ohms. Note that on this graph the zero decibel point for 500-ohm calibration comes at about 1.75 volts, as nearly as it can be read. As mentioned before, the zero point for 500 ohms is actually at 1.732 a-c volts. On the graph the zero point for 600 ohms comes at about 1.90 a-c volts.

Supposing that the output meter were connected across a voice coil impedance or resistance of 8 ohms. The graph shows that for 8 ohms the zero decibel point should be at 0.22 a-c volts on the meter scale. Again, supposing that the output meter were connected across a plate load resistance of 20,000 ohms. The graph shows that for calibration at this resistance the zero decibel point should be placed at about 11.0 volts, actually at 10.95 a-c volts on the meter scale.

Were the meter calibrated for 500 ohms or 600 ohms on the decibel scale it would be necessary to apply corrections to the indicated values in order to learn numbers of actual decibels.

Decibel measurements are based on powers in watts expended in loads of certain resistances. The standard reference value of power dissipation is 0.006 watt or 6 milliwatts. When a decibel meter calibrated for 500 ohms indicates zero decibels while connected to a 500-ohm load, the power dissipation in that load is 6 milliwatts. If calibration is for 600 ohms, and if the meter is connected across 600 ohms when indicating zero decibels, the power dissipation in that load is 6 milliwatts. If the power dissipation is doubled the meter will indicate 3 decibels up or plus, and if the power is halved the reading will become 3 decibels down or minus. Every change of 3 decibels means that the power is doubled or is halved, regardless of the load resistance for which the meter is calibrated.

We may deal with voltages instead of powers because the voltage across a load is proportional to the square root of the

power in that load. It turns out that doubling the voltage across a load makes the meter read 6 decibels higher, while halving the load voltage makes the meter read 6 decibels lower. Every change of 6 decibels on the meter means that the load voltage has been doubled or halved. This is true no matter what the resistance for which the meter is calibrated.

Now let's look at Fig. 8, where we have a decibel meter calibrated for 500 ohms shown connected to several load resistances. At the left the meter is connected across 500 ohms in which the

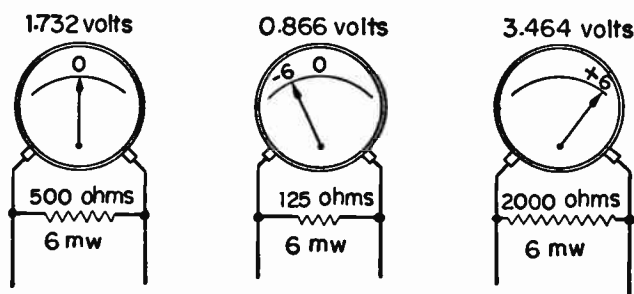

Fig. 8.—Voltages and decibels for a meter connected across various loads.

power dissipation is 6 milliwatts. The corresponding load voltage is 1.732 volts. Zero decibels on this meter is at the scale point corresponding to 1.732 volts, so the meter indicates zero decibels.

The center diagram shows the same meter connected across 125 ohms. The power in this resistance still is 6 milliwatts. But to dissipate this much power in 125 ohms requires only 0.866 volts across the load. Then the meter pointer drops to the position corresponding to 0.866 volt. On the decibel scale this is 6 decibels down or minus, yet the reading should be zero decibels because a power of 6 milliwatts is our reference level, and always should be indicated as zero decibels. To correct the meter reading we must add 6 decibels to the indication.

In the right-hand diagram the same meter is connected across 2,000 ohms, and in this resistance the power dissipation again is 6 milliwatts. To have this much power in the higher resistance takes a load voltage of 3.464 volts. The meter pointer stands at the position corresponding to 3.464 volts, which is marked 6 decibels up or plus on the meter scale. Because the power in the

load is at the reference level of 6 milliwatts the meter should read zero decibels. To correct the reading we must subtract 6 decibels.

For any load of less resistance than the meter calibration the decibel meter will read low, and we must add some certain number of decibels as a correction. For any load whose resistance is greater than the calibration value the meter will read high, and we must subtract from the indicated reading to get the true value.

The graph of Fig. 9 shows corrections to be made on meter indications when the meter is connected across loads of resistances or impedances other than those for which the calibration holds. The lower horizontal scale shows load resistances or im-

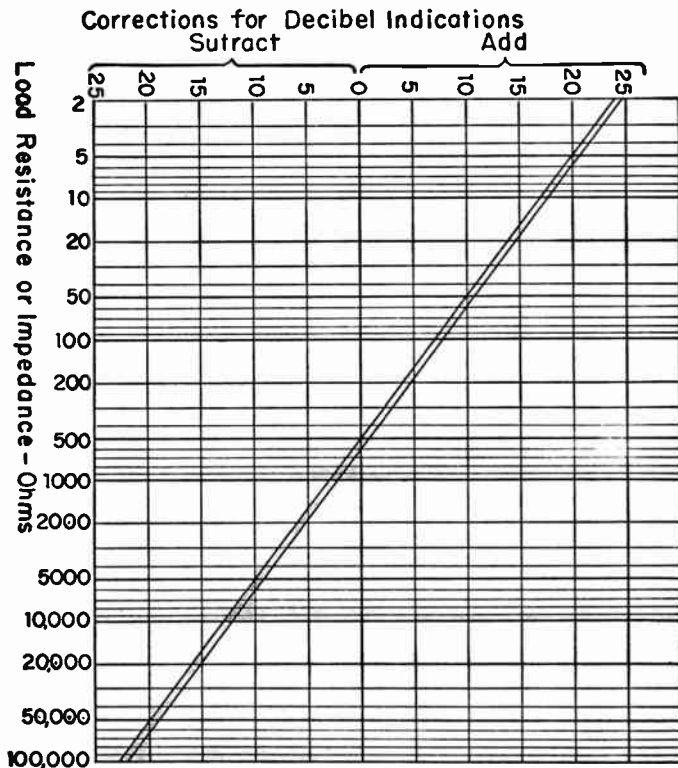

Fig. 9.—Corrections for decibel indications with loads other than those of the meter calibration.

pedances across which the meter is connected, the range being from 2 ohms to 100,000 ohms. The left-hand vertical scale shows the number of decibels to be added to or subtracted from the actual meter reading. The upper diagonal line applies when the meter is calibrated for 600 ohms. Note that this line crosses the 600-ohm vertical line on the horizontal line for zero correction. The lower diagonal line applies when the meter is calibrated for 500 ohms. This line crosses the 500-ohm vertical line on the horizontal line for zero correction.

For an example in using this graph assume that a decibel meter calibrated for 500-ohms is connected across a 5-ohm resistance used instead of a voice coil. Following upward along the 5-ohm vertical load line to the lower diagonal line (for a 500-ohm decibel meter) and thence to the left we find that about 20 decibels should be added to the meter reading. Were the same meter connected across a 5,000 ohm load we would follow upward along the 5,000-ohm load resistance line to the lower diagonal line, then to the left and find that 10 decibels should be subtracted from the meter indication.

Tuning Range Test.—To check the tuning of a receiver connect the signal generator ground terminal to the receiver ground terminal or the chassis metal and connect the generator high side through a dummy antenna to the receiver antenna post. Turn on both instruments and let them warm up for fifteen minutes or more. Connect the output meter to the receiver output in any of the ways which have been shown. Tune by obtaining maximum readings on the output meter, not by listening to the loud speaker.

Set the receiver tuning dial at its lowest frequency position. Set the volume control at maximum on the receiver. With the least output from the generator which gives distinct readings on the output meter tune the generator for maximum meter reading. When the tuning is correct the meter reading will drop with change of generator tuning in either direction. Make a record of the generator frequency. Repeat the test with the receiver tuning dial at its maximum frequency position, and record the generator frequency.

Usually it is desirable to make similar checks at each of the three standard r-f test frequencies, or at all of the standard

frequencies, thus obtaining a frequency calibration of the receiver tuning dial. The low and high limits of tuning, or the frequency range, should be checked for each frequency band for which the receiver is designed.

Tracking Test.—The next test of tuning is a check on how well or poorly the oscillator tuning “tracks” with the tuning of the antenna or r-f circuits throughout each band of frequencies for which the receiver is designed. This may be done conveniently by temporarily varying the inductance of the tuning coils by means of the tool shown in Fig. 10. This tool consists of a short

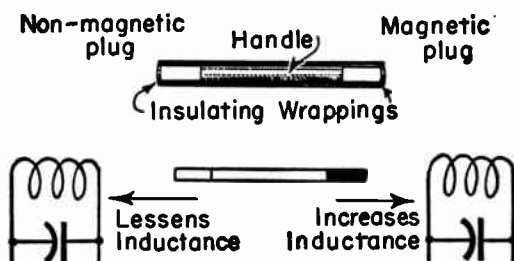

Fig. 10.—Tool for testing tracking of an oscillator.

insulating handle in one end of which is a piece of non-magnetic metal, such as aluminum, and in the other end is magnetic metal which should be powdered iron such as used for permeability tuning. A regular tuning slug is most suitable. The metal pieces must be covered with insulation, such as cellulose tape.

When the non-magnetic plug is brought near the end of a coil, or inserted within the coil winding, the effective inductance of the coil is lessened. When the magnetic plug is used similarly the inductance of the coil is increased.

To make the test for tracking proceed as follows. Tune the signal generator and receiver to a radio frequency near the low-frequency end of the band being checked. Adjust the generator output or receiver volume control for an output meter reading near the center of the meter dial. Bring the magnetic plug and then the non-magnetic plug near the end or insert them into the tuned oscillator coil and also the tuned antenna or r-f coil.

If the output meter reading increases when the magnetic plug is brought to or into a coil the inductance of the coil is too small

or the tuning capacitance is too small. If the meter reading increases with the non-magnetic plug the coil inductance or tuning capacitance are too great, and need reducing. Inductance and capacitance are correct when both plugs cause the meter reading to decrease. Trimmer or padder adjustments should be set for this correct condition at the low frequency end of the band.

Now the generator and receiver are tuned to a frequency near the high end of the band. The tests with the two plugs are repeated with both coils. Correction usually can be made with trimmer capacitors at the high tuned frequency without much upset of adjustments at the low frequency end of the band, where capacitance trimmers have relatively little effect. Similar tests may be made at a tuned frequency near the middle of the band as a check on performance, although nothing can be done to improve matters at this frequency without affecting the performance at the ends of the band.

Oscillator Frequency.—When there is a change in the frequency at which an oscillator tube or the oscillator section of a converter tube operates there is a change of intermediate frequency. The intermediate frequency is a beat frequency produced by the oscillator and signal frequencies. When the oscillator frequency varies with no change of signal frequency the resulting beat frequency is not that for which the i-f amplifier system is tuned or aligned. The result is a decrease of output from the receiver.

Oscillator frequency drift usually is not troublesome in the standard broadcast band, but may cause fading of signal output in the short-wave bands. This is likely to happen when the bias for the converter signal grid is controlled by the automatic volume control. This change of bias with variation of signal strength varies the total cathode current of the converter and varies the plate and anode voltages. Any variation of oscillator plate or anode voltage tends to change the frequency of oscillation. Similar variations of oscillator frequency may result from change of plate or anode voltage and current due to any cause, such as variation of line voltage or any variation of voltages furnished by the d-c power supply. Good voltage regulation in the power supply helps matters.

Sensitivity.—The sensitivity of a receiver is a measure of the

amplification or gain. Sensitivity is the strength or voltage of the r-f input signal which will result in a specified output at the loud speaker. For receivers which are capable of a maximum undistorted output of one watt or more the output for sensitivity measurement usually is one-half watt. For receivers whose maximum undistorted output is less than one watt the output for

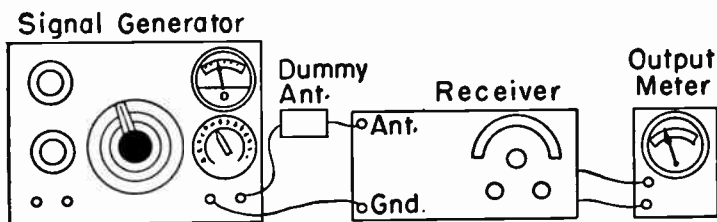

Fig. 11.—Connections for checking sensitivity with signal generator having calibrated output.

sensitivity measurement usually is one-tenth watt, but may be some other specified power. Then, for example, if the r-f signal strength must be at least 10 millivolts in order to have the standard output at the speaker the sensitivity of the receiver is 10 millivolts. Because sensitivity varies with changes of input radio frequency the sensitivity is specified for one or more particular frequencies.

The r-f input signal is modulated 30 per cent at 400 cycles. The regular dummy antenna is used between the signal generator and the receiver antenna post. If the receiver has any special controls which affect or control the sensitivity they are set for maximum sensitivity during tests.

If the output of the signal generator is accurately calibrated and may be adjusted to various signal strengths, the connections are made as in Fig. 11. With generator and receiver tuned together at one of the frequencies where tests are to be made, the receiver volume control is set for maximum volume and the output of the generator is increased until the output meter reads the required output. A note is made of the generator output. Similar tests are made at other frequencies in the band, and in any other frequency bands for which the receiver is designed.

If the output meter is not of a type which reads directly in

watts and fractions of watts of power, the output for the tests may be taken as any suitable number of a-c volts or decibels. Then the generator output is adjusted at each test frequency to obtain the selected reading on the output meter. The procedure at each test frequency is as follows: First; tune the signal generator to the test frequency. Second; tune the receiver to obtain maximum reading on the output meter. Third; adjust the generator output to obtain the selected constant output. Fourth; make a record of the generator output.

Fig. 12 shows a sensitivity curve for a six-tube superheterodyne receiver operated through the standard broadcast band of frequencies from 550 to 1,600 kilocycles. For this curve the output of the signal generator, which is the input to the receiver, was varied to produce the same a-f output in the loud speaker circuit at all radio frequencies. In order to have the height of the curve indicate sensitivity, with greater height indicating greater selectivity, the left-hand scale of inputs is upside down. The less the required input the greater is the sensitivity of the receiver.

When making sensitivity tests with signal generators such as ordinarily used for radio service work it will be necessary to shift from one frequency range to another to cover the entire band. Generator output voltages differ in the several ranges. The output for a given frequency tuned at or near the top of one range will be greater or less than for the same frequency tuned near the bottom of another range. If the a-f modulating

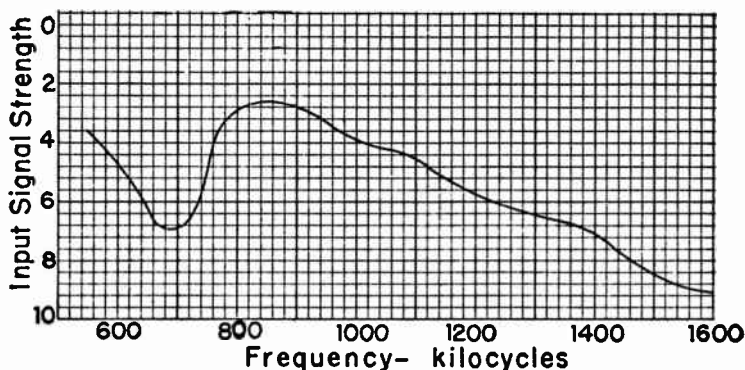

Fig. 12.—A graph of receiver sensitivity in the standard broadcast band.

voltage remains constant, as usually is the case, the percentage of modulation will be different in the various r-f bands. With constant a-f voltage, the smaller the r-f output the greater will be the percentage of modulation.

The greater the percentage of modulation the higher will be the a-f output at the speaker circuit of the receiver for any given strength of r-f signal. Thus it comes about that when the generator r-f output is made the same in two or more frequency bands there will be different a-f outputs indicated by the output meter on the loud speaker circuit of the receiver. Although the r-f generator outputs and receiver inputs are equal, the modulation will be greater or less in one band than in another.

If, during sensitivity tests, the signal generator output is great enough to cause automatic volume control in the receiver then the sensitivity will appear more uniform than it actually is. It is the purpose of the avc system to make for constant sensitivity. If a strong generator output must be used it is well to cut off the avc line and temporarily substitute a fixed bias for the r-f, converter, and i-f tubes. The fixed negative bias may be two or three volts, furnished by dry cells or by bias cells. Once the manual volume control of the receiver has been adjusted at the beginning of a sensitivity test this control must not be changed during that run of tests.

If the output of the signal generator is not accurately calibrated the receiver sensitivity may be checked by maintaining the generator output constant at all radio frequencies while observing and noting changes of receiver output as indicated by the output meter. Connections for such a test are shown by Fig. 13. An r-f microammeter may be arranged by connecting a germanium crystal rectifier in series with any meter whose

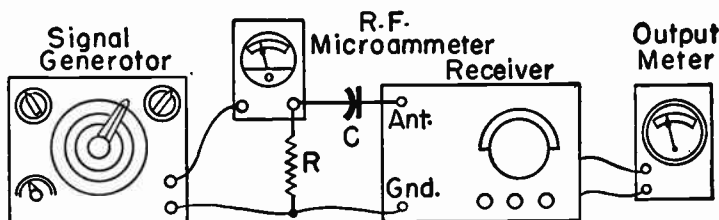

Fig. 13.—Sensitivity checking with a signal generator whose output is not calibrated

maximum range is no more than 200 microamperes, and preferably less. The generator output is run through this meter and a resistor R . Input to the receiver antenna-ground circuit is taken from across the resistor through capacitor C . The resistance at R may be between 500 and 10,000 ohms, being chosen to allow the output available from the generator to give an easily identified reading on the microammeter. The capacitance at C may be 0.0005 or more mfd.

The signal generator output is kept as small as will permit a clear indication on the microammeter and allow for either raising or lowering this output during the tests. The procedure then is as follows: First; tune the generator to one of the test frequencies. Second; tune the receiver for maximum reading of the output meter, then adjust the receiver volume control for a reading near the center of the output meter scale. Third; adjust the generator output for whatever reading of the microammeter has been selected as a constant value to be used. Fourth; note the reading of the output meter. Similar tests are made at whatever other radio frequencies are to be checked.

Fig. 1 pictures the manner in which ordinary service types of radio test equipment may be used in making the kind of sensitivity check just outlined. A graph drawn from measurements made with this setup is shown by Fig. 14. The receiver is the

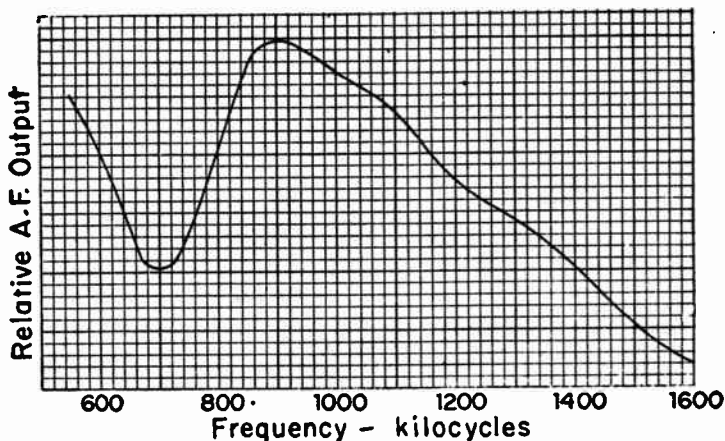

Fig. 14.—Sensitivity curve made with constant input and varying output from the receiver.

same as used for measurements shown by Fig. 12, where the output was maintained constant by varying the input at the various frequencies instead of maintaining a constant input while observing the resulting output at the various frequencies as for Fig. 14. Both curves have generally similar shapes. Different signal generators were used for the two tests. Even though tests are not made under strictly standard conditions there still are shown comparative sensitivities at the frequencies in the band where measurements are made. Any serious faults or irregularities would be disclosed as well as though the measurements were of absolute sensitivities in microvolts input for a standard output power.

Automatic Volume Control.—The standard method for checking the performance of the automatic volume control system of a receiver is as follows. The signal generator and receiver are tuned together at a frequency near the middle of the band in which the test is to be made. The generator output is set at its maximum value, or to something between one and two volts of r-f potential. Then the receiver volume control is set as high as possible without causing overloading and distortion in the a-f amplifier of the receiver.

With an output meter connected to the loud speaker circuit, and maximum input from the signal generator, advancing the manual volume control will cause the meter reading to rise and

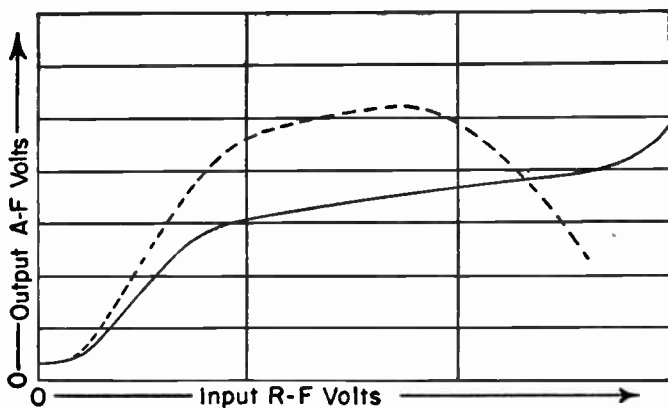

Fig. 15.—Receiver output with and without automatic volume control.

then fall back. Overloading is indicated by the decreasing output. The volume control may be set slightly lower than the point at which the output ceases to rise and well below the point at which the output commences to drop off.

Now the output of the signal generator is set at its lowest value, and is increased in fairly small steps while observing and noting the reading of the output meter at each step of r-f input. Plotting a-f output voltages against r-f input voltages will give a curve on the order of the one drawn with a full line in Fig. 15. If the same receiver is operated with a fixed bias for r-f, converter, and i-f tubes the plot of a-f output against r-f input will appear somewhat as shown by the broken-line curve.

Even with the generator output at zero there will be a small a-f output which represents noise and hum voltages produced in the receiver, and possibly some r-f pickup other than from the generator. This condition is shown at the left-hand end of the curves. The avc system commences to limit the output quite decidedly where the full-line curve bends toward the horizontal. With increasing r-f input the a-f output then rises gradually, and at some high input with the manual volume control turned too high this curve will take an upward bend.

The curve showing output with fixed bias instead of with avc rises faster than the one for avc because the avc system is limiting the output to some extent for all values of input voltage. With more than some certain value of r-f input the peak value of the input signal becomes greater than the fixed bias voltage. Then the amplifier tubes are overloaded and the a-f output will drop off as the input voltage is increased still more. This is shown where the broken-line curve turns downward. This does not occur with the avc in action because then the bias on the amplifier tubes becomes more and more negative as the input voltage is increased.

Cathode Follower.—In some wide band amplifiers and in many testing instruments a tube is used as a cathode follower or cathode coupler with connections shown by Fig. 16. The purpose of such a tube is to provide an input of very high impedance where the load is of relatively low impedance or resistance. The control grid of the tube is negatively biased by voltage drop across cathode resistor R_k . With negative bias there is no cur-

rent in the grid circuit so far as the tube is concerned, and the grid impedance is high. Even when a grid resistor R_g is used the input impedance will be about equal to this resistance.

The output from the cathode follower stage is taken from across resistor R_k . By suitable choice of tube type and plate voltage, and consequent cathode current, this resistor may be

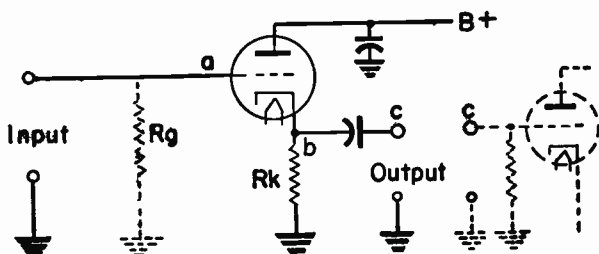

Fig. 16.—Connections for a cathode follower tube.

made of a value which provides good match for the output load, whatever the load may be. Resistor R_k biases the cathode follower tube while providing the output coupling.

There can be no voltage gain in a cathode follower stage. There always will be an output voltage which is less than the input voltage. The "gain" formula is

$$\text{Gain} = \frac{R_k \times \mu}{R_p + R_k \times (\mu + 1)}$$

R_k , cathode resistor, ohms.

R_p , tube plate resistance in ohms, at operating conditions.

μ , tube amplification factor, at operating conditions.

As an example assume 900 ohms for the cathode resistor, 20 as the amplification factor (μ) of the tube, and 7700 ohms as the plate resistance. Then we have,

$$\begin{aligned} \text{Gain} &= \frac{900 \times 20}{7700 + 900 \times (20 + 1)} = \frac{18000}{7700 + 900 \times 21} \\ &= \frac{18000}{7700 + 18900} = \frac{18000}{26600} = 0.677 \end{aligned}$$

Thus we find that the output voltage across the cathode resistor would be about two-thirds of the voltage applied to the

control grid. When gains are being measured there always will be some loss between input and output of a cathode follower stage. Feedback through the cathode resistor, which is in both the plate circuit and control grid circuit, is degenerative and tends to make the gain uniform over a wide range of frequencies.

There is no phase inversion in the cathode follower stage. Assume, as an example, that the potential at the control grid *a* becomes less negative. Then there will be more plate current through *R_k* and the potential at *b* will become more positive with reference to ground. This more positive potential goes to *c* of the output. If the output goes to the control grid of a following tube the grid of that tube will be made more positive. The grid of that tube already will be negatively biased, and so will be made less negative. Thus the control grids of both the cathode follower and the tube coupled to its output become more negative at the same time. The cathode follower tends to lessen phase distortion in an amplifier.

Gain Varying with Input.—The gain of audio-frequency amplifiers usually varies with changes in the strength or voltage of the signal input to the amplifiers. Such variations of gain may be checked with the arrangement shown by Fig. 17. If the a-f

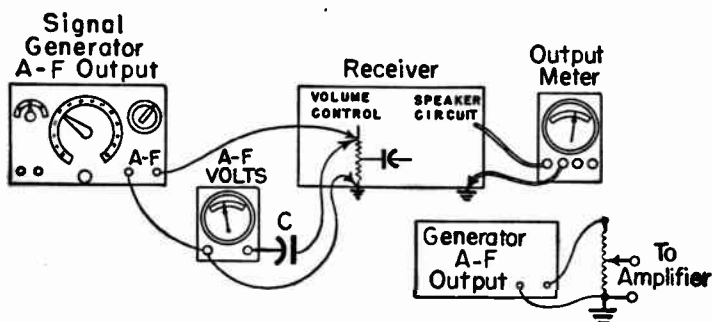

Fig. 17.—Check of variation of gain when the input voltage is changed.

output of the signal generator is accurately calibrated in volts and fractions of volts the generator may be connected directly to ground and the ungrounded end of the manual volume control in the receiver.

If the a-f output of the generator is adjustable, but not calibrated, the a-f output may be measured with an a-c voltmeter of the rectifier type capable of indicating potentials of less than one volt at audio frequencies. This meter is connected as shown between the a-f output of the signal generator and the receiver volume control and ground. Rectifier meters respond to direct currents and potentials. In the volume control there is direct current rectified by the detector and there is the accompanying direct potential. To keep this direct potential from affecting the readings of the a-f voltmeter there should be connected in series with either voltmeter terminal a capacitor C having a value of one mfd or more.

If the a-f output of the signal generator is neither calibrated nor adjustable it is possible to obtain an adjustable output as shown in the sketch at the lower right-hand side of Fig. 17. A potentiometer of voltage divider having maximum resistance of 1,000 to 10,000 ohms is connected across the a-f output of the generator. Then the potentiometer slider and ground are connected to the a-f voltmeter and receiver volume control just as are the jacks marked $A-F$ on the generator at the left. Adjusting the slider will vary the voltage applied to the receiver while this voltage is measured by the a-f meter.

The audio frequency for the test usually is either 400 cycles

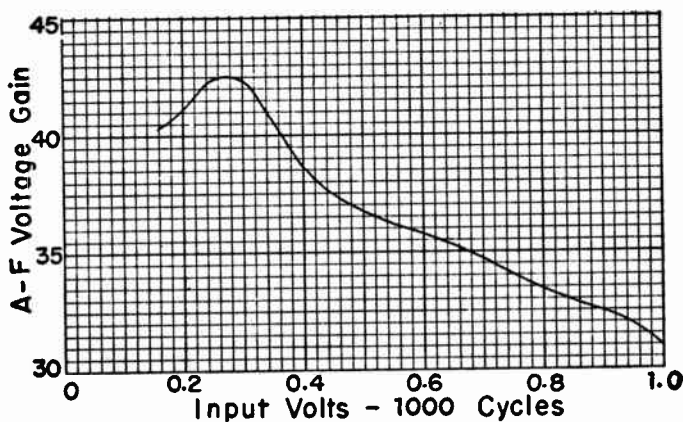

Fig. 18—Variation of gain with change of input voltage to an amplifier.

or else 1,000 cycles. The generator output is adjusted for maximum voltage. The manual volume control of the receiver is set as high as does not cause audio distortion, or is set below the point at which the reading of the output meter commences to drop as the volume control is raised. Readings now are taken of the receiver outputs as the input is decreased in steps to a value

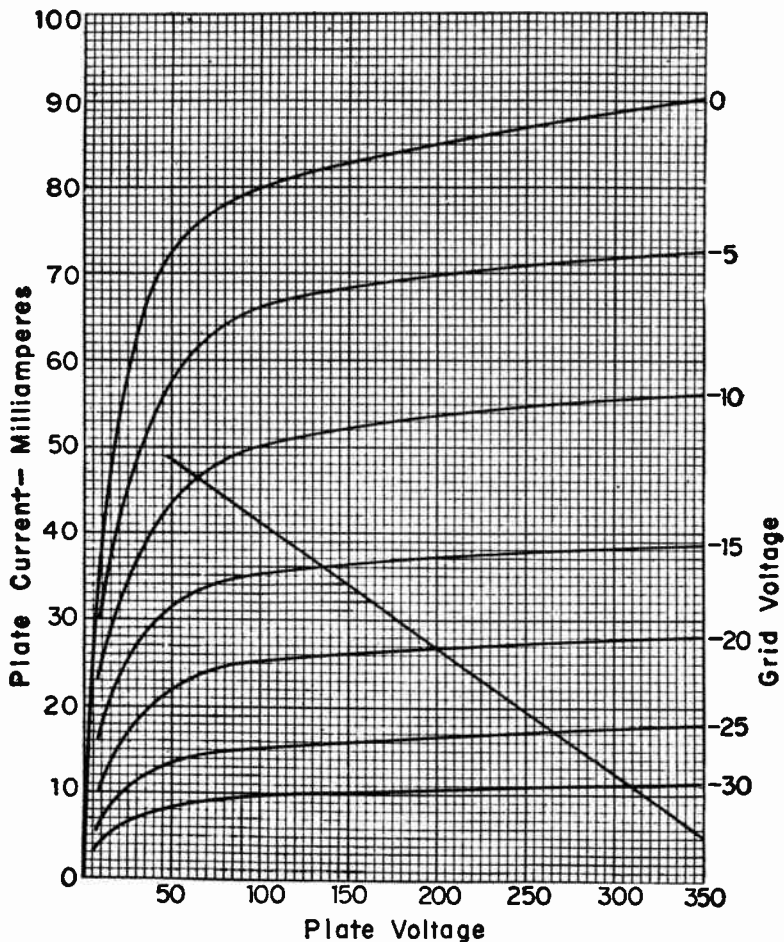

Fig. 10 —The load line used in the example of computing voltage gain

as low as can be read on the meter or on the calibration adjustments. Dividing each output voltage by the corresponding input voltage gives the gains of the amplifier for the several inputs.

Fig. 18 shows gains of a two-stage amplifier having a single power tube as the a-f input was varied from one volt down to somewhat less than 0.2 volt. With this particular amplifier there was maximum gain of about 42.5 with the input around 0.3 volt. The gain drops to about 31.0 with 1.0 volt input, where distortion commences to show.

Gains from Load Lines.—When the theoretical gain of a stage is to be computed for comparison with the actual measured gain the computation is made most directly and simply from a load line for the tube operating at the known conditions. An example may be worked out with the help of Fig. 19 which shows plate characteristics for a beam power tube with a load line drawn for a plate load resistance of 7,000 ohms. The following conditions are assumed for this example: Average plate voltage, 200. Control grid bias, 20 volts negative. Average plate current, 27 milliamperes. Peak signal potential, 10 volts, which gives a 20-volt peak-to-peak grid swing. There are five steps in determining the gain.

1. Determine the total change of control grid voltage or the minimum and maximum grid voltages. From the bias voltage subtract the peak signal voltage to find the minimum, and to the bias voltage add the peak signal voltage to find the maximum. In our example we will have 20 minus 10, giving 10 volts minimum grid potential, and will have 20 plus 10, giving 30 volts maximum grid potential.

2. On the load line read the plate currents in milliamperes corresponding to the minimum and maximum grid voltages. On the load line of Fig. 19 these currents are 11.0 milliamperes and 46.4 milliamperes.

3. Subtract the smaller from the larger plate current and change the result to equivalent amperes. The difference between 46.4 and 11.0 milliamperes is 35.4 milliamperes. This is equivalent to 0.0354 ampere of current change.

4. Multiply the change in amperes of plate current, as just determined, by the number of ohms load resistance. In our example we multiply 0.0354 (ampere) by 7,000 (ohms load) to

obtain 247.8. This is the change of voltage which will be produced across the load resistance.

5. Divide the change of voltage as just determined by the peak-to-peak grid swing in volts. The result is the voltage gain. In our example 247.8 (volts) is divided by 20 (volts) to find that the gain is 12.39 or about 12.4 times.

REVIEW QUESTIONS

1. What is the standard line voltage for testing a-c types of home receivers? What are the five standard frequencies in the standard broadcast r-f band?
2. Should power tube output be measured across the load speaker voice coil or across a dummy load resistor? Why?
3. What is the approximate voltage for zero decibels on a 5,000-ohm load? Refer to Fig. 7.
4. When using a decibel meter on load resistance greater than that for which the meter is calibrated, will decibel indications be too high or too low?
5. For making standard sensitivity tests with a modulated r-f signal, what is the modulation frequency in cycles and what is the percentage of modulation?
6. In tests for sensitivity and selectivity, should the automatic volume control be made to act, or should it be replaced with a fixed bias?
7. In testing a cathode follower stage, would you expect a high gain, no gain, or a loss?
8. Make a sketch of connections and parts between a receiver and a generator having an uncalibrated output, as used for testing gain or for sensitivity?

Chapter 6

TESTS FOR FAULTY PERFORMANCE

In the preceding chapter we dealt with performance tests in general, and in particular with tests of gain and output of amplifiers and complete receivers. Now we shall consider the kinds of performance which affect what we hear rather than how loudly we hear it. At best we shall hear only a desired program rendered with highest fidelity. Or, we may hear several different programs at the same time, with the possible addition of hum, whistles and assorted other noises, while speech and music are marred by various kinds of distortion.

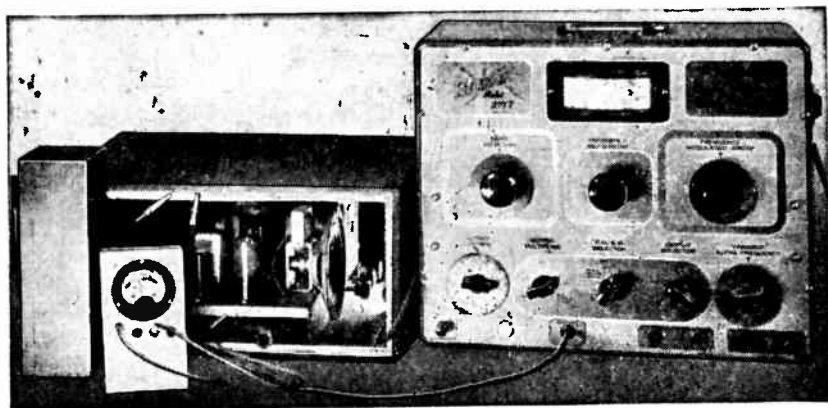

Fig. 1.—Selectivity test with receiver in shielding enclosure and with a filter in the power line connection.

Selectivity.—Our first concern is with the receiver characteristic called selectivity. Selectivity is a measure of the ability of a receiver to respond to signals at one carrier frequency while excluding those of all other frequencies. In a still broader sense the selectivity of a receiver refers also to its ability to exclude the effects of all electrical disturbances as well as undesired signals.

The selectivity of any one tuned circuit is almost directly proportional to the Q-factor of the circuit, which is the ratio of reactance to high-frequency resistance of all kinds. Selectivity always tends to be greater at low radio frequencies than at higher ones because the Q-factor of all the tuned circuits decreases as the radio frequency increases. Selectivity is improved by adequate shielding, which prevents signal pickup other than through the antenna. The selectivity of an entire receiver is increased by using more tuned circuits, each of which has the ability to accept the desired frequency while reducing the response to other frequencies.

Selectivity Test.—Before a receiver is tested for selectivity there should be a careful check and any necessary re-setting of alignment adjustments in the r-f, oscillator, i-f, and wave trap circuits. Then the automatic volume control is disconnected from

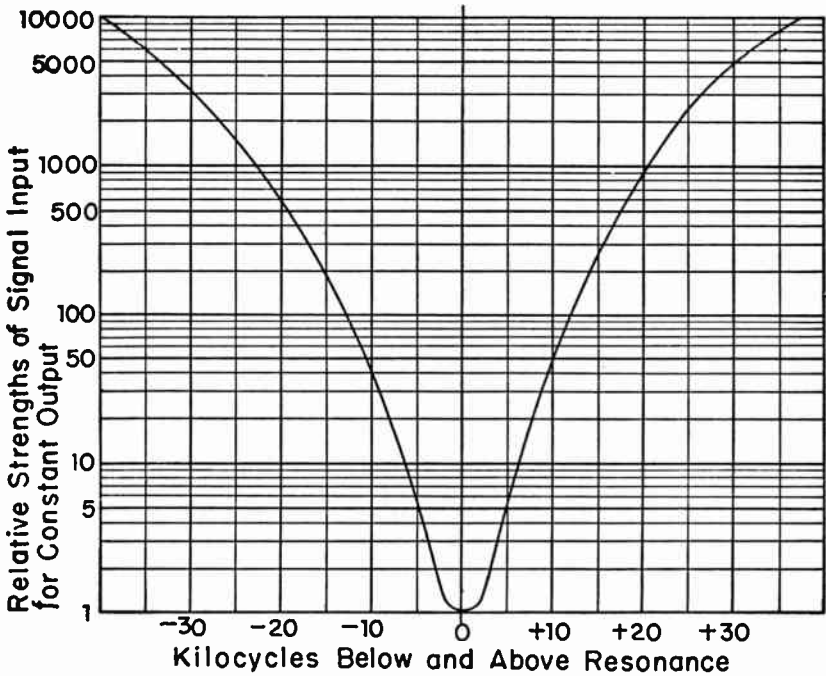

Fig. 2.—Selectivity curve for a typical small receiver.

the amplifier tube grid circuits and a fixed bias is connected to these tubes. The signal generator is connected through the regular dummy antenna to the receiver antenna post and to the chassis ground. An output meter is connected to the receiver loud speaker circuit.

The standard test for selectivity consists of adjusting generator and receiver to the same frequency, usually 1,000 kc for tests in the standard broadcast band, then noting the amount by which the generator output must be increased to maintain the original output from the receiver as the generator is detuned both sides of resonance.

When the results of the test are plotted on a graph the curve should be of the general type shown by Fig. 2. The bottom scale shows frequencies in kilocycles below and above resonance. Resonance is the frequency to which the receiver and generator are originally tuned, and to which the receiver remains tuned as the generator is detuned.

The left-hand vertical scale shows relative strengths of generator signal required to maintain the original output from the receiver. The numbers on this scale are merely relative values. The number 1 might represent any number of microvolts. Then the number 2 would be twice as many microvolts, the number 5 would be five times as many, and so on. This scale is logarithmic, because it always should provide for an increase of generator output up to 10,000 times, and this great change can be shown only by such a scale while keeping the smaller values well separated.

On the curve of Fig. 2 the generator output at 5 kc either way from resonance must be increased to about five times its lowest value. At 10 kc below resonance the generator output must be 40 times its original value, and at 10 kc above resonance about 50 times the original value. In this particular receiver a signal at 10 kc below resonance would have to be 40 times as strong as one at resonance in order that both signals might sound equally loud from the speaker. At 10 kc above resonance the other signal would have to be 50 times as strong.

Frequency channels in the standard broadcast band are 10 kc apart, being at 800, 810, 820 and other numbers of kilocycles which are multiples of 10. Channels next below and above any

one to which a receiver is tuned are called the adjacent channels. The selectivity against signals in these nearest channels is called the *adjacent channel selectivity*. The adjacent channel selectivity shown by Fig. 2 is a ratio of between 40 and 50. Sometimes we specify also the "second channel selectivity," which applies to the channels next below and above the adjacent channels. Second channel selectivity in Fig. 2 is at a ratio of 600 on the side below resonance and at 900 on the side above resonance.

A major difficulty in making selectivity tests is interference from broadcast signals. Most receivers will pick up signals from nearby stations with no antenna connection of any kind. Much of the pickup is through wiring and exposed coils in radio-frequency circuits. Ac-dc receivers, and others too, have strong pickup through the power supply line and the cord attached to the receiver power input. All such interference affects indications of the output meter.

Laboratory tests of selectivity usually are made with the receiver in a fully shielded room, with all power inlets brought into the room through low-pass filters. A fair approximation of the shielded room may be had in the service laboratory by placing the receiver inside a metal box as pictured in Fig. 1. The arrangement of parts and their connections are shown by Fig. 3.

The box is preferably of copper, brass or aluminum, but sheet iron or steel will serve quite well. The dimensions should not be much greater than those of receivers ordinarily tested, with allowance for reaching the controls and the antenna and ground terminals. The front of the box may be left open at all times.

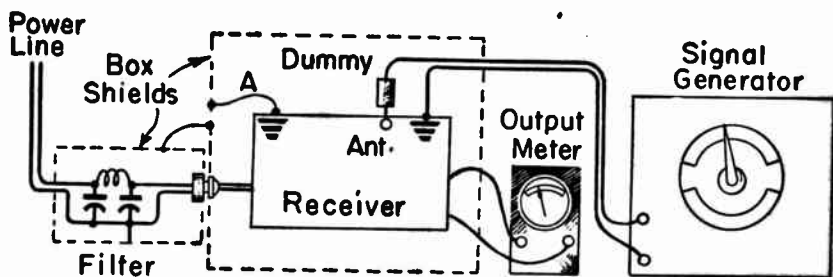

Fig. 3.—How the receiver is protected from interference during selectivity tests

The receiver chassis must be connected to the metal of the box, as at A in Fig. 3. The box need not be grounded. Grounding to a cold water pipe will bring in interference, since the power and lighting circuits of the building usually are grounded to the same water system.

Connection from the power line is made through a low-pass filter. Good quality commercial interference filters serve very well at this point. Otherwise the filter choke may be made by winding onto a form an inch or more in diameter 100 turns or more of single enameled copper wire of about number 20 gage, which is amply large for the current taken by any ordinary receiver or amplifier. The filter capacitors may be of 0.001 mfd or greater capacitance. The filter must be in a separate metal shield. No part of the filter is connected to the shield, and the shield metal is connected to the main shield for the receiver, but is not otherwise grounded. The outlet receptacle from the filter must fit tightly against the main shield so that the power cord of the receiver may be plugged into this receptacle without extending outside of the shields. The receiver power cord should be coiled up and kept wholly inside of the main shield. Even one inch of exposed cord will pick up much signal voltage.

It is well to keep the r-f end of the receiver as far as possible from the open side of the main shielding box. The shielded lead from the signal generator must extend well into the box before its connection to the dummy antenna. There is very little signal pickup through leads for the output meter, and this meter may be placed anywhere that is convenient.

Selectivity Test Procedure.—Although the standard test frequencies are 600, 1,000 and 1,400 kc, there usually will be nearby stations at one or more of these frequencies. Therefore, to avoid station interference, it is better to use test frequencies which are multiples of 5, such as 995 kc or 1,105 kc, and so on. Before going ahead with measurements leave the signal generator connection off the dummy antenna (after having tuned the receiver to the proposed test frequency) and then turn the volume control to maximum while observing the output meter. Interference will be indicated by any considerable rise of the meter pointer. Station interference is indicated by rather rapid swinging of the pointer on the output meter. A frequency should be

selected at which there is minimum interference. The remaining steps are as follows.

1. Set the generator at the test frequency, tune the receiver accurately to the generator signal, and do not again change the receiver tuning control.

2. Turn the manual volume control of the receiver up, and the generator output control down, until reaching some very low generator output at a number of microvolts easily multiplied, while the reading of the output meter is at some easily identified point near the center of its scale. This latter is the output which is to be maintained as the generator is detuned.

3. Detune the generator by either 5 or 10 kc below the resonant frequency, and increase the generator output to obtain the original reading on the output meter. Note and make a record of the generator output.

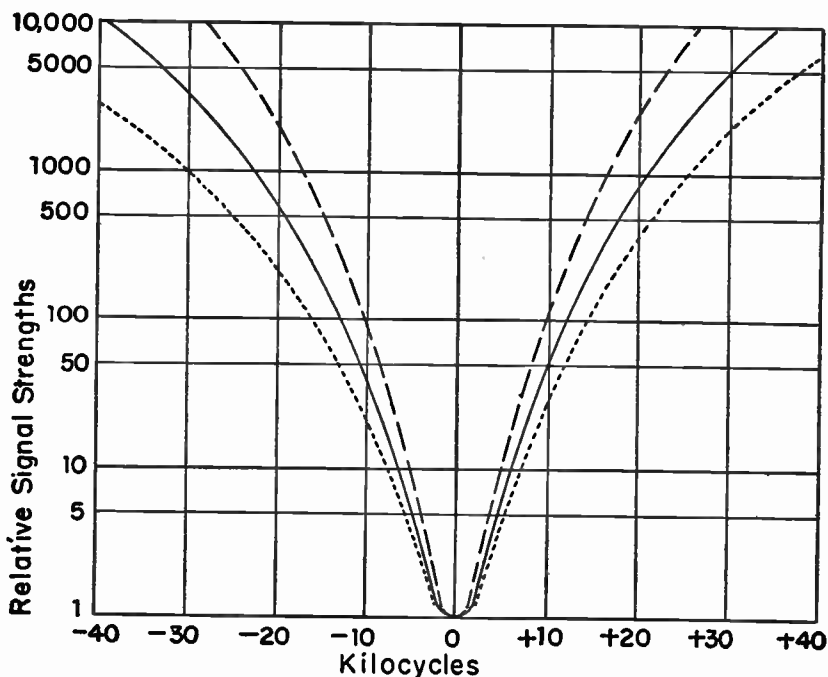

Fig. 4.—Selectivity curves for frequencies near the top, center, and bottom of a band.

4. Continue detuning the generator in steps of 5 or 10 kc until the output is made one volt or until the output is 10,000 times the original value, whichever comes first during the tests.

5. Repeat the process as the generator is detuned to frequencies higher than resonance.

6. The tests below and above resonance may be repeated at other test frequencies; usually at one near 600 kc and at another near 1,400 or 1,500 kc. The three curves will appear somewhat as shown by Fig. 4. The dotted-line curve shows selectivity at or near 600 kc, the full-line curve shows selectivity at or near 1,000 kc, and the dash-line curve shows selectivity around 1,400 or 1,500 kc. Greater signal input is required at 600 kc than at 1,000 kc, and greater at 1,000 kc than around 1,400 kc. Consequently, selectivity is greatest around 600 kc and is least around 1,400 kc on these curves. In general, selectivity decreases as the radio frequency increases.

7. If the receiver has a special control for selectivity, the selectivity may be measured with this control at various settings.

Tests with Two Signal Generators.—Selectivity tests made in the manner just described do not give exact indications of what happens with station interference, because only one signal is present. To more nearly match actual operating conditions it is necessary to use two signal generators at the same time; one generator furnishing the desired signal while the other generator furnishes the interfering signal.

There are several possible ways of connecting the two generators to the receiver. Fig. 5 shows a method which is generally satisfactory. Here the generator furnishing the interference (B) is connected through one side of a coupler and a dummy antenna to the antenna post of the receiver. The coupler is an untuned radio-frequency transformer with its two coils having equal numbers of turns and placed end to end on the same form. Inductance of 100 to 200 microhenrys in each coil gives suitable coupling. The generator furnishing the desired signal (A) is connected to the second side of the coupler.

To begin with the two generators and the receiver are tuned together for the frequency at which the test is to be made. This tuning may be done as follows: Turn on either generator and set it at the desired frequency. Tune the receiver to this generator

as accurately as possible. Now turn on the second generator, cut off the modulation in both generators, and tune the second generator for zero beat from the receiver. The zero beat condition may be identified with the output meter, but the loud speaker is easier and gives a more positive indication. As the second generator is tuned across the frequency of the first one there will be a high-pitched whistle which drops in pitch and

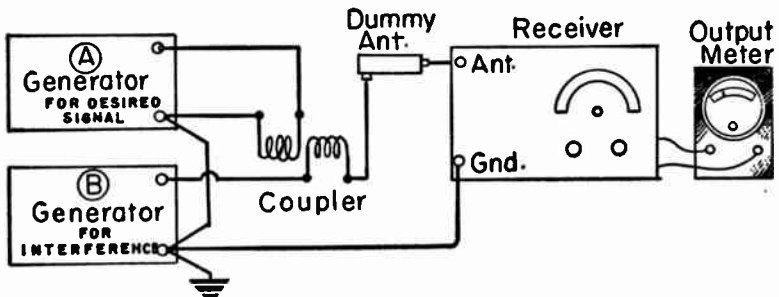

Fig. 5.—Using two signal generators for testing selectivity.

then rises again. Zero beat is at the point where the note is of lowest pitch, or where there is silence from the speaker between the whistles. Zero beat is indicated by the lowest reading of the output meter.

The next step is turn generator *B* on and *A* off, with modulation on generator *B*. With the output of generator *B* adjusted to any low value set the volume control of the receiver to give some easily identified reading on the output meter. This reading will be maintained during the tests. Generator *B* now is turned off, but not disconnected from the coupler.

Now generator *A* is turned on, with its output modulated, and the output of this generator is adjusted to give the same output meter reading as before. Thus the two generators have been adjusted to give equal inputs to the receiver at the test frequency. Generator *A* is left turned on, but its modulation is cut off. Were modulation to be used on both generators there would be strong audio-frequency beat notes giving high readings on the output meter.

The final step is to turn on generator *B*, with modulated output, and detune this generator to 10 kc either side of the test frequency. Were the detuned frequency kept any closer to the frequency of generator *A* the two radio frequencies would form audio frequency beats of 10,000 cycles (10 kc) or less. These audio frequencies would cause high readings on the output meter. The output of generator *B* is raised until the reading of the output meter on the receiver is brought up to the original value. The output of generator *B* is noted and recorded. With generator *B* detuned to other frequencies still farther from the original resonant frequency measurements are made of the generator outputs required to maintain the reading of the receiver output meter. From these measurements may be plotted a selectivity curve.

Instead of coupling the two signal generators by means of a radio-frequency transformer they may be connected in parallel to the receiver as at the left in Fig. 6. Two dummy antennas are connected to the antenna post of the receiver. If the dummy antennas are capacitance types the capacitance of each may be

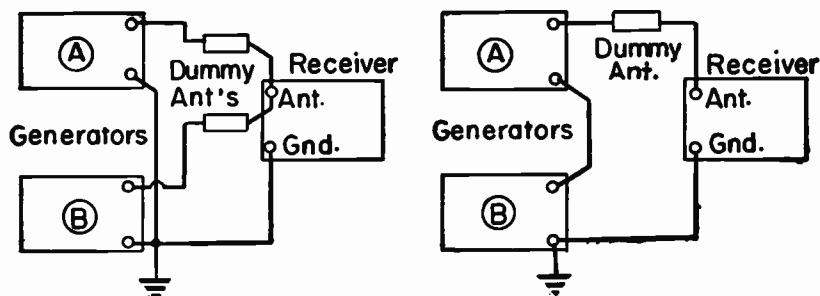

Fig. 6.—Two signal generators in parallel (left) and in series (right).

half of what would ordinarily be used, and if of resistance types the resistance may be twice that ordinarily used when only a single dummy antenna is employed. It is possible also to connect the two signal generators in series, as at the right in Fig. 6. Here the signal from each generator passes through the attenuators for both instruments.

Selectivity with Constant Signal. — It would seem logical to check selectivity by detuning the signal generator from the original resonant frequency while observing the change of receiver output. That is, we might commence by tuning the generator and receiver to the test frequency, observe and note the reading of the output meter on the receiver, then detune the generator in steps while watching the falling off of receiver response.

Such a method will give a selectivity curve of the general form shown by Fig. 7. The left-hand vertical scale of receiver output is numbered in relative values corresponding to potentials which can be read on the output meter. The number 1 on the scale might correspond to 1/10 or 0.1 volt. Then the number 10 would correspond to 1.0 volt, and so on. The frequency scale across the bottom is the same as used for other selectivity graphs.

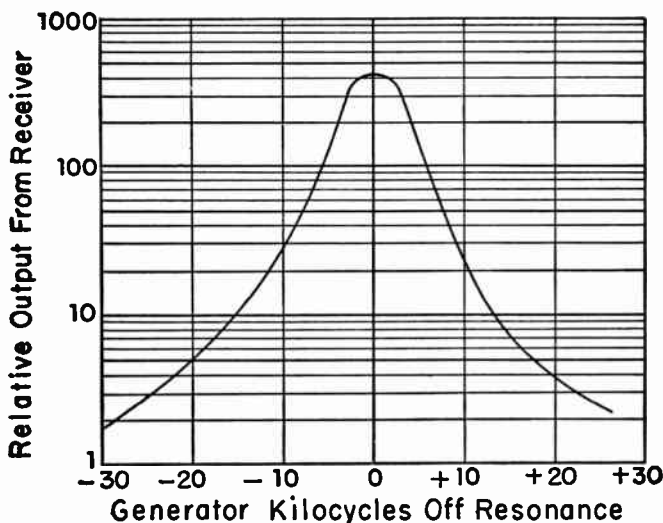

Fig. 7.—Selectivity curve as made with constant output from the signal generator.

The principle of this method is good, but there are practical difficulties in carrying it out. For one thing, the receiver output cannot be varied over a range comparable with variation of out-

put from a calibrated signal generator. Such a range of receiver outputs would result either in severe distortion with the high value at original resonance, or else it would be impossible to read the output meter for the lowest values. Output meters, like all other a-c meters, tend to be inaccurate at the very low readings.

Another difficulty arises from the fact that the output of signal generators varies with frequency. With the generator detuned below the original resonant frequency its output may be either lower or higher, depending on the frequency range being used and on the make and type of generator. A relatively small change of generator output causes large changes of receiver output because of the gain in the amplifying stages. However, this method of checking selectivity has the advantages of simplicity and speed, and often will show up operation which is much at fault.

I-f Amplifier Selectivity. — The selectivity of most receivers against adjacent channel interference is due largely to action in the intermediate-frequency amplifier rather than to the radio-frequency stage. The ideal i-f amplifier would have uniform gain over the entire range of frequencies in the r-f channel, and would cut off sharply at the edges of this range. That is, in a standard broadcast channel centering at 1,000 kc the i-f amplifier should have uniform amplification from 995 to 1,005 kc, and zero amplification at frequencies either lower or higher. If the amplification extends into lower and higher frequencies there will be adjacent channel interference. If amplification does not

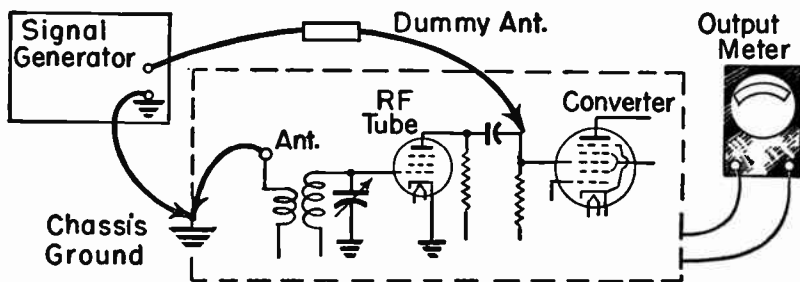

Fig. 8.—Test for selectivity of an i-f amplifier.

extend to the limits of the channel there will be cutting off of the higher audio frequencies in amplitude modulation, which is called sideband cutting.

Selectivity of the i-f amplifier is greater at low intermediate frequencies than at higher ones. Intermediate frequencies in the standard broadcast band are fairly well standardized at 456 and 455 kilocycles. The choice of intermediate frequency for short-wave and high-frequency reception in general is important from the standpoint of selectivity.

I-f amplifier selectivity may be checked as shown by Fig. 8. The high side of the signal generator is connected through the usual dummy antenna to the signal grid of the converter tube or to the control grid of a separate mixer tube if such a tube is used instead of a converter. The antenna post of the receiver is

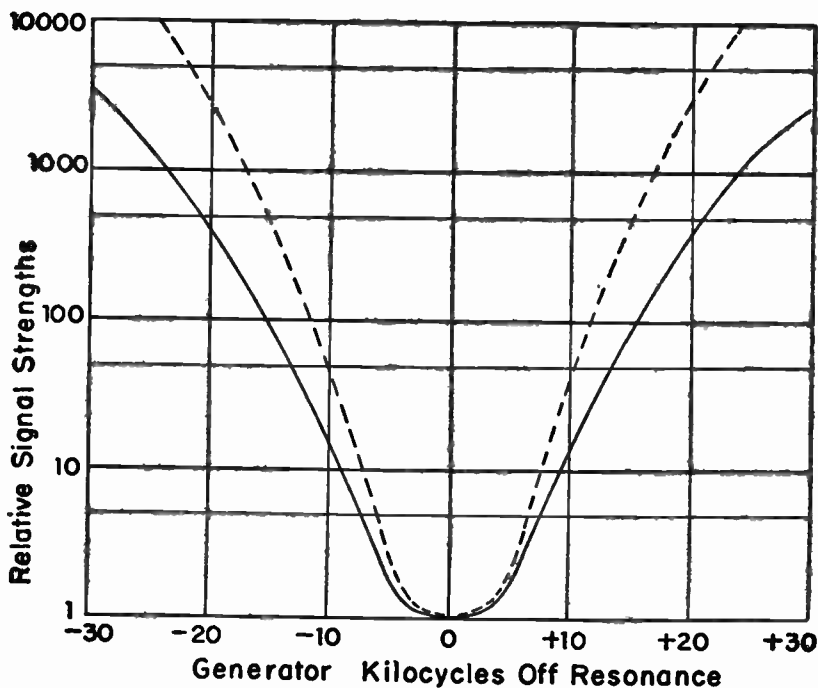

Fig. 9.—Selectivity of an i-f amplifier alone and of the i-f and r-f amplifiers operating together.

grounded to the chassis in order to reduce signal pickup through the antenna tuner and r-f amplifier circuits. The signal generator and the receiver are tuned together at the test frequency, which usually is either 600 kc, 1,000 kc, or 1,400 kc provided no nearby stations are operating on one of these frequencies. If such stations are operating a different test frequency should be selected unless the receiver is very completely shielded.

The tests now are made just like any other selectivity tests. The signal generator is detuned in steps of five or ten kilocycles each side of the original resonant test frequency. The generator output is increased to maintain a constant output from the receiver on each detuned frequency. When the required generator outputs are plotted on a graph there will be a selectivity curve for the i-f amplifier.

The full-line curve of Fig. 9 shows the selectivity of an i-f amplifier having a single amplifying tube and two double-tuned i-f transformers, one transformer between the converter and the i-f tube, and the other one between the i-f tube and the detector. The broken-line curve shows the selectivity of the same receiver when the r-f stage is included. The r-f stage used for measurements had a tuned antenna circuit and untuned resistance-capacitance coupling between the r-f tube and the converter tube.

At frequencies near resonance there is very little selectivity added by the r-f stage. Even at 5,000 cycles (5 kc) off resonance there is not much difference. But as an assumed interfering frequency becomes farther and farther from the frequency to which the receiver is tuned there is more and more selectivity contributed by the r-f stage. At 20 kc off resonance the interference input with the r-f stage has to be about 3,000, and without the r-f stage only about 400.

This comparison does not mean that receivers having an r-f stage will be more than seven times as selective as those without such a stage at 20 kc off the tuned frequency. In the test whose results are shown by Fig. 9 the tuned antenna circuit is not effective, the signal input being to the converter signal grid as in Fig. 8. In receivers without r-f stages, and with the antenna circuit going to the converter tube, the tuned antenna circuit adds much selectivity.

It is generally true that lack of selectivity against adjacent channel interference indicates faults in the i-f amplifier, while lack of selectivity for channels farther away indicates faults in the r-f stage or stages.

Cross Modulation.—When listening to a weak signal from one station while another nearby station is emitting a strong signal the a-f modulation (speech or music) of both stations may be heard at the same time. Such an effect is called cross modulation. It may result from having the bias for an r-f amplifier tube so highly negative that the tube operates on the lower bend of the characteristic curve showing relations between plate current and grid voltage. When a tube is thus operated it acts as a sort of detector or rectifier, and the plate current will vary simultaneously at both modulation frequencies. The weaker signal is being amplified in the usual manner, but at the same time there are variations of plate current corresponding to the stronger signal.

Cross modulation would show up in a test made with two signal generators as in Figs. 5 and 6 provided there were different audio frequencies of modulation in the two generators. The output meter would not differentiate between the two audio frequencies, and it would be necessary to listen to the loud speaker of the receiver.

Cross modulation is prevented by operation of r-f amplifier tubes with normal grid biases, and by having good selectivity in the r-f amplifier. Good selectivity calls either for high-Q circuits or for more than one stage of r-f amplification.

Image Frequency Interference.—An image frequency is a signal frequency which is equal to the frequency of a desired signal plus twice the intermediate frequency or minus twice the intermediate frequency. Assume that we have an oscillator which tunes to frequencies higher than the frequencies of signals to be received. Assume also that our intermediate frequency is 456 kc. If the receiver now is tuned at 550 kc, the oscillator frequency must be equal to 550 plus 456 kc, or 1,006 kc. Supposing that the antenna circuit is affected at the same time by another signal at 1462 kc. The oscillator will beat with this other signal to form a difference frequency which will be equal to 1462 minus 1006 kc, or 456 kc. Thus the intermediate frequency

of 456 kc is produced by both the desired 550-kc signal and by the other signal of 1462 kc. This other signal is called the image frequency. Subtracting 550 from 1462 kc gives 912 kc, which is twice the intermediate frequency of 456 kc.

If we assume that the oscillator frequency always remains below the tuned frequency, and assume a tuned frequency of 1500 kc, the required oscillator frequency will be equal to 1500 minus 456 kc, or 1044 kc. If there is another signal at 588 kc the difference between this other signal frequency and the oscillator frequency of 1044 kc will be 456 kc, which again is our intermediate frequency. Here the signal frequency of 588 kc is an image frequency. It differs from the tuned frequency of 1500 kc by 912 kc, which is twice the intermediate frequency. When the oscillator tunes below the desired signal frequency the image frequency always will be below the tuned frequency by an amount equal to twice the intermediate frequency. When the oscillator tunes above the desired signal the image frequency always will be above the tuned frequency by twice the intermediate frequency.

With the test connections of Fig. 8 it will be found that the receiver outputs will be practically equal when the generator is

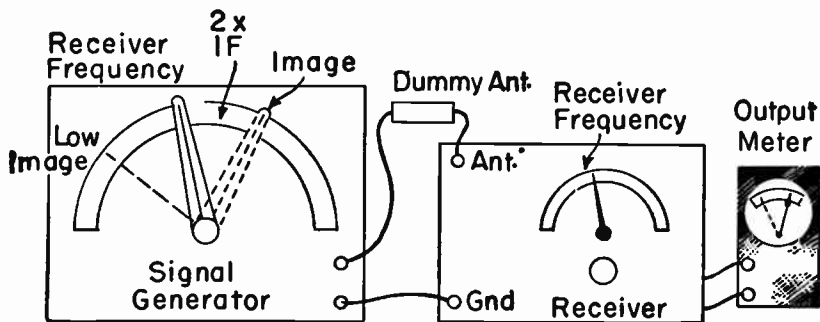

Fig. 10.—Testing a receiver for image frequency response.

tuned either to the desired signal frequency or to the image of this signal frequency. If the generator is connected to the antenna post rather than to the converter signal grid, the desired signal frequency will be received in full strength but the image

frequency will be received weakly if at all. One of the chief objects of tuned antenna circuits and of tuned r-f stages is to provide selectivity against image frequencies.

Receivers should be checked for image frequency response or selectivity as in Fig. 10. The receiver and generator are tuned together at any selected test frequency. The generator output and receiver volume control are adjusted to give a high reading on the output meter. Then the receiver tuning is left unchanged while the generator is detuned to a frequency differing from its original setting by twice the intermediate frequency. Since differences of a few kilocycles often cannot be read accurately on the generator tuning scale the generator tuning should be varied somewhat in either direction until the image response is located. To obtain this image response it should be necessary to use a generator output several thousand times as great as for the receiver frequency response. Otherwise there is trouble in the tuned circuits between antenna and converter or mixer tube.

The connections of Fig. 10 allow easy and rapid checking of the approximate intermediate frequency for which a receiver is aligned. After tuning generator and receiver together at some frequency the generator is detuned to obtain the image response. Then half the difference between the first and second generator frequencies is equal approximately to the intermediate frequency. It is possible also to determine whether the receiver oscillator frequency is above or below the tuned signal frequency. If the image response is found at a frequency higher than that of the original signal the oscillator is tuned above the signal frequency. If the image is below the signal frequency on the generator then the receiver oscillator is tuning below the signal frequency. Such a procedure often is useful when testing in the short-wave and high-frequency bands where oscillators may tune either above or below the signal frequency.

I-f Rejection Test.—The receiver should have good selectivity against the intermediate frequency when this frequency is applied to the antenna. Otherwise an interfering signal at the intermediate frequency will reach the converter or mixer and be applied to the i-f amplifier where it will be strongly amplified.

To check receiver selectivity at the intermediate frequency connect the signal generator through the regular dummy an-

tenna to the receiver antenna post, and connect the generator ground to the receiver ground. Tune the generator to the intermediate frequency used in the receiver. Tune the receiver anywhere in the low-frequency end of the band except at harmonic frequencies of the intermediate. Increase the generator output while varying the generator tuning a little ways either side of the intermediate frequency, thus being sure to cover the actual frequency to which the receiver i-f amplifier is tuned.

The receiver output as read on the output meter should be much lower than with receiver and generator tuned to the same frequency. As the receiver is tuned away from the low end of its scale, and toward higher frequencies, the output should decrease because this tuning gets farther from the intermediate frequency. Because practically all service types of signal generators produce harmonics of any frequency to which they are tuned, there will be relatively high output from the receiver when it is tuned to a harmonic of the intermediate frequency being furnished by the signal generator.

With receivers having i-f wave traps this test is a check on adjustment of the trap circuit. The wave trap should be adjusted

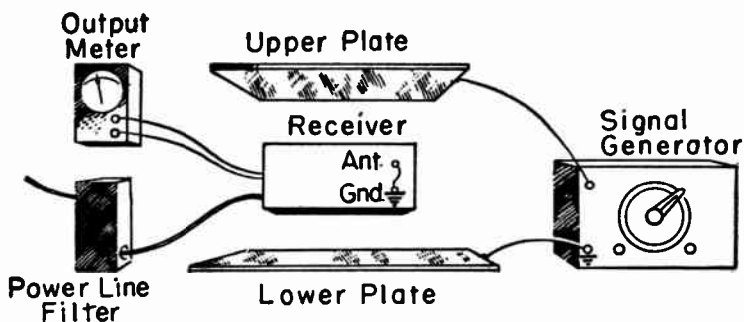

Fig. 11.—Connections for measuring signal pickup in an r-f field.

or aligned to permit minimum response to the intermediate frequency.

Pickup on Wiring and Parts.—Fig. 11 shows connections for testing the degree to which a receiver will pick up radio-fre-

quency signals other than through the antenna circuit. The receiver to be tested is supported between two large metal plates which are horizontal. The output of the signal generator is connected to the upper and lower plates. Then in the space between the plates will be a radio-frequency field similar to that produced by signals from broadcast and other transmitters, but this field will be at the generator frequency and will be of strength controlled by generator output adjustment. R-f energy picked up by wiring, coils, capacitors, and other parts of the receiver will be amplified and will affect the reading of the output meter.

The antenna post of the receiver should be directly connected to chassis ground. A loop antenna should be disconnected or removed from the receiver. The upper and lower metal plates must be well insulated from each other. Supports of dry, clean wood are satisfactory. A complete setup for the test is pictured by Fig. 12. The power line r-f filter is at the left of the receiver. The signal generator, at the right, is connected to the plates.

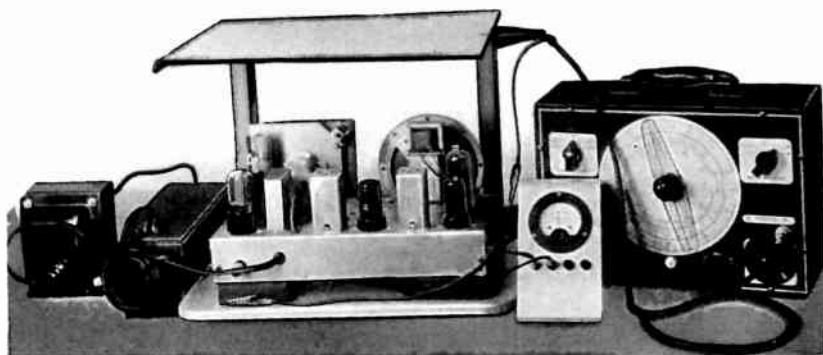

Fig. 12.—A test setup for measuring pickup in an r-f field.

The output meter is connected to the loud speaker or power tube circuits of the receiver in any of the usual ways.

The receiver may be set on the lower metal plate, thus grounding the receiver chassis to the plate, or else the receiver may

be supported a little ways above the plate with no connection between the chassis and the plate.

To make the test commence by tuning the generator to the test frequency, usually 1,000 kc or thereabouts in the standard broadcast band. Then tune the receiver to the generator and raise the volume control of the receiver while reducing the output of the generator until reaching the lowest generator output which allows a distinct reading on the output meter. Now the generator is detuned below and above resonance, as in any selectivity test, and the generator output is increased at each step to restore the original reading of the output meter.

The r-f pickup of the receiver should be checked at various frequencies in each band. Pickup normally will be greater as the frequency is increased, although the actual condition may not be evident because of change in generator output with change of generator frequency. The tests may be made also by maintaining a constant generator frequency and a constant generator output while varying the tuning of the receiver. This is the method used in developing Fig. 7. In any event, a check should be made with the generator tuned to the intermediate frequency used in the receiver, because a wave trap for i-f rejection might be effective on antenna signals but less effective on signals picked up other than through the antenna.

While the reading of the output meter is fairly high during any of the tests try moving your hand about within the space above the receiver and underneath the upper metal plate. Make a similar check with a small plate of non-magnetic metal moved

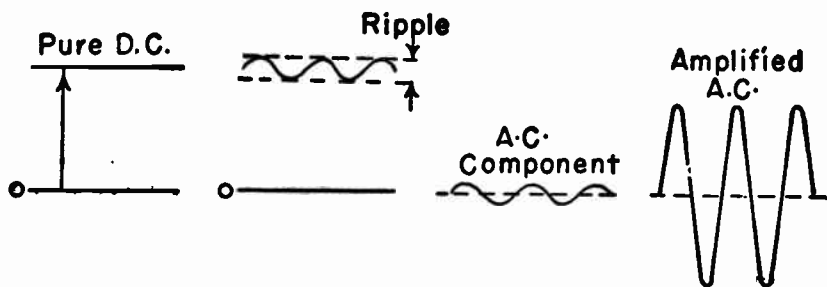

Fig. 13.—Ripple voltage or hum voltage.

about in the same space. Note the difference between the effect of your hand or the metal when near r-f parts and circuits and when near a-f parts. The pickup is greatly reduced near r-f parts, but affected only a little near the a-f parts.

These pickup tests check the effectiveness of whatever shielding is installed on the parts of the receiver. If there are exposed r-f coils above the chassis it will be instructive to temporarily cover them with a shield which is grounded to the receiver chassis, then retune the circuits containing these coils, and again check the degree of pickup. It may be found worth while to install the extra shielding in permanent fashion. The pickup tests check also the effectiveness of dressing of grid, plate, and screen leads and connections in the receiver. If leads which should be dressed close to chassis metal are not so placed there will be greater pickup.

Hum Voltage.—Pure direct current or direct potential such as might be furnished by a battery may be represented as at the left in Fig. 13. This is the ideal supply voltage for plates, screens, and the biasing of control grids. In rectified direct current and potential, such as furnished by a d-c power supply including rectifier and filter, there always is more or less ripple voltage

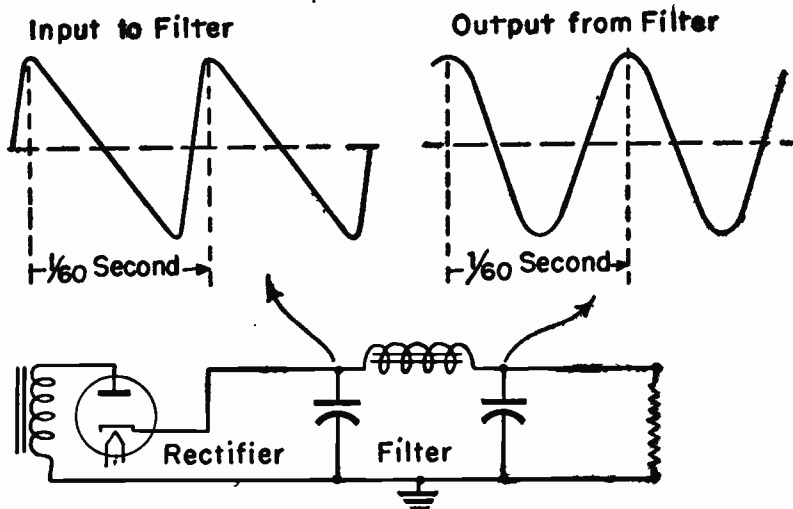

Fig. 14.—Ripple voltage waveforms at input and output of a power supply filter.

as represented by the next diagram. Ripple voltage causes a variation above and below the average value of the direct current and potential. It is the a-c component of the one-way current. If direct current is blocked by a capacitor the ripple voltage will pass through the capacitor and become an alternating voltage as marked *a-c component* in the diagrams. When this a-c component is amplified in amplifying stages of a receiver or amplifier the result is audible hum from the loud speaker.

If we connect an oscilloscope to the output of a half-wave rectifier operating from a 60-cycle line supply, or connect it to the input to the filter, the waveform will be as shown at the left in Fig. 14. The diagram shows a capacitor-input filter, and the waveform is for this type of filter. The input capacitor is charged rapidly and discharges slowly, as shown by the quick vertical rises and slower falls of potential in the wave.

With the oscilloscope connected to the output of the filter the waveform appears as at the right in Fig. 14. Although the two waves are drawn of equal heights, indicating equal potentials, the a-c ripple in the output ordinarily will be somewhere between 1/30 and 1/200 of that at the input to the filter. The reduction of ripple in the filter depends on the type and construction of the filter.

With a half-wave rectifier the frequency of the ripple voltage will be the same as the frequency of the power line. If the line frequency is 60 cycles then the ripple frequency will be 60 cycles. If the oscilloscope is connected to the input and the output of a filter fed from a full-wave rectifier the waveforms will be about

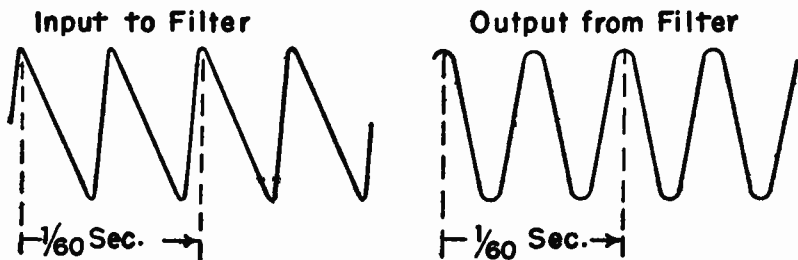

Fig. 15.—Ripple voltages from a full-wave rectifier.

as shown by Fig. 15. The ripple frequency is twice the frequency of the a-c power line. With line frequency of 60 cycles the ripple frequency will be 120 cycles per second. Again the input and output curves are drawn of equal height, although the output ripple will be but a very small fraction of the a-c potential at the filter input.

Hum voltage or ripple voltage may be measured at various points in an amplifier with any a-c meter capable of measuring or indicating very small voltages. All a-c meters have the disadvantage of not distinguishing between frequencies. Such a meter will have a reading proportional to the sum of all alternating potentials, which may include not only the ripple voltage but higher audio frequencies due to many other causes and to various kinds of interference. Any a-c meter or any output meter used for measuring ripple voltage must have in series with the meter a blocking capacitor to keep out any direct potentials which may be present. The working voltage of the blocking capacitor must be amply high for plate and screen circuits in which ripple is to be measured. The capacitance should be one microfarad or more to provide low reactance at the low frequencies of ripple voltages.

Ripple voltages may be detected by means of a signal tracer having an audible output. The 120-cycle ripple hum from a full-wave rectifier is within the range of hearing for nearly everyone, but many ears do not hear frequencies as low as the 60 cycles from a half-wave rectifier unless the voltage is high.

A nearly ideal instrument for checking the presence of ripple voltage at various points in an amplifier is the oscilloscope. It is easy to adjust the horizontal sweep frequency either for the line frequency or for twice this frequency, depending on whether the radio apparatus has a half-wave or a full-wave rectifier. Then only this ripple frequency will show up as a steady trace on the oscilloscope screen, while other frequencies, if present, merely cause flickering of the trace.

The more common causes for audible hum fall into five general classes, as follows: 1. Insufficient filtering, either in the rectifier-filter d-c supply system or in the filters at plate and screen returns of tubes. 2. Power transformer faults; including insulation breakdown, shorted turns in the high-voltage secondary, and

loose laminations which cause mechanical vibration of tubes, coils and capacitors. 3. Magnetic fields around transformers, filter chokes, and heater or filament wiring which cause induction into other transformers or into the wiring of plate, screen and grid circuits. 4. Leakage between heater and cathode of one or more tubes, or electron emission between heater and cathode in either direction. 6. Badly matched push-pull power tubes with which voltages do not cancel in the primary of the output transformer.

Insufficient filtering in the d-c power supply may result from an open circuited filter capacitor, from high resistance in old or defective capacitors, or from capacitors which have been badly overloaded. Faults in resistance-capacitance filters in plate and screen grid returns usually are found in the filter capacitors, either from breakdown or poor connections. The filter resistors might be short-circuited to cause hum. Were the resistors open circuited the plate or screen voltages would be cut off.

Plate, screen or control grid leads running too close to heater or filament wiring will pick up hum voltages from that wiring. The cure is in correct placement or dressing of the leads. Audio-frequency coupling transformers or chokes should not be too near power transformers and filter chokes unless the relative mounting positions have been checked by shifting the units until there is least interaction between their magnetic fields. Air-core coils seldom pick up the low-frequency hum voltages, although it is possible for them to do so when unshielded. Hum may result from having audio-frequency or detector tubes too close to power transformers and filter chokes.

If the oscilloscope detects ripple voltage at power line frequency in apparatus having a full-wave rectifier the cause often is in leakage between cathode and heater of a tube or tubes. Heater-cathode leakage always causes hum at the frequency of the heater supply, which is line frequency in a-c operated heaters. tube. Hum due to slight leakage in high gain tubes may be lessened by using a bypass of 20 mf or greater capacitance across a cathode-bias resistor, even when the tube is an r-f or i-f circuit where a small capacitance bypass otherwise would be sufficient. Unless heater-cathode leakage is large it causes little trouble when

the cathode is connected directly to the chassis ground. Heater-cathode leakage is best corrected by replacing the faulty tube.

Electron emission from cathode to heater occurs when the cathode is negative with reference to the heater, and occurs from heater to cathode when the cathode is positive with reference to the heater. The emission will be too small to cause trouble unless there is considerable difference of potential between the two elements. It is emission from heater to cathode that is more likely to cause hum. Such hum is lessened by large bypass capacitance across any resistor in the cathode circuit.

Hum which is due to causes other than poor filtering in the power supply will ordinarily originate in some one amplifying stage and then will be amplified by following stages until it reaches the loud speaker. If the control grid of the tube in any amplifying stage is connected to chassis ground through a large capacitance the only signals reaching the loud speaker will be those picked up in parts beyond the control grid. Should the hum continue to be heard or noted on an output meter the pickup of hum voltage must be between the control grid temporarily con-

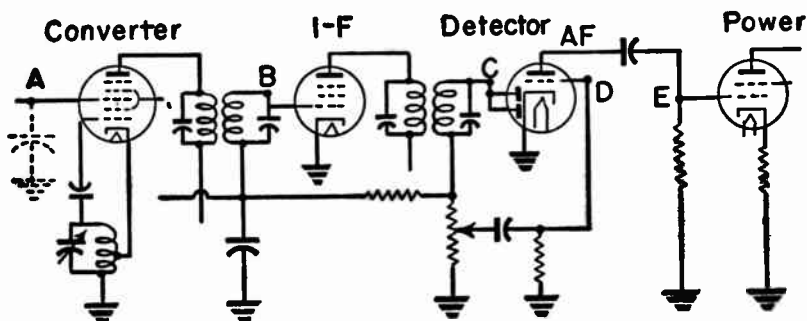

Fig. 16.—Points for grounding stage inputs in locating causes for hum.

nected to ground and the loud speaker. By connecting the grids of various tubes to the chassis as described the stage in which the hum originates may be located.

As an example of the foregoing method, were the converter signal grid of Fig. 16 grounded through a capacitor as at A,

any potentials entering grid or plate circuits on the right would be amplified and would reach the loud speaker. Potentials in parts to the left of point *A* would not pass through the converter and following stages. Control grids and detector diode plates might be similarly grounded at *B*, *C*, *D* and *E*, in each case cutting off everything to the left of the point grounded. The only disturbances reaching the loud speaker would originate on the right of the grounded points.

Modulation Hum.—Hum that is noticeable only when the receiver is tuned to an r-f carrier wave or broadcast signal may be called modulation hum. The effect is as though the high-frequency signal were being varied in average potential by the low-frequency hum voltage, as at the left in Fig. 17. On the oscilloscope screen the high-frequency carrier will appear with waves at the hum frequency, as at the right.

The degree of modulation hum, when present, is checked as follows: The signal generator is connected through the usual dummy antenna to the receiver antenna post, and to ground. The two are tuned together at some frequency near the center of the band, usually at around 1,000 kc in the standard broad-

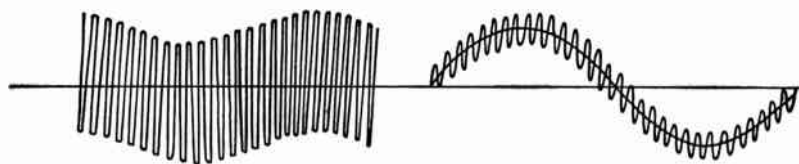

Fig. 17.—Apparent effects of modulation hum.

cast band. If the receiver has a tone control it is set for the high audio frequencies. The manual volume control of the receiver is set as high as will not cause distortion, and the generator output is adjusted to give a fairly high reading on the output meter connected to the receiver. Then the audio-frequency modulation is cut off at the generator to leave only the hum voltage instead of hum plus audio modulation at the receiver output.

If the loud speaker has been cut off the reading of the output meter may be due more to noise in general than to hum. Con-

sequently, it is well to have both speaker and meter in action in order to detect the hum by its sound. Noise of the hissing variety may be reduced by manipulation of the receiver volume control and generator output to leave any hum voltage more clearly audible.

Modulation hum may result from poor filtering of the power supply as this affects the r-f and i-f stages, also from defective units or connections in filters at the plate and screen returns for r-f and i-f tubes. This type of hum results also from inductive coupling from magnetic fields into wiring and other parts, from cathode-heater leakage in the high-frequency tubes, and from shields which are not well grounded to the chassis metal.

Residual Hum.—Hum which is created wholly within the audio-frequency amplifiers may be called residual hum. To check this residual hum it is necessary to make the r-f and i-f amplifiers incapable of delivering a signal to the detector. If the detector is combined with the first a-f amplifier, as at the left in Fig. 18, the high-frequency amplifiers may be cut off in any of four ways. First, the last i-f amplifier tube may be removed from its socket provided the tube heaters or filaments are in parallel on the power supply so that this removal will not open the circuit for other heaters or filaments. Second, if the last i-f

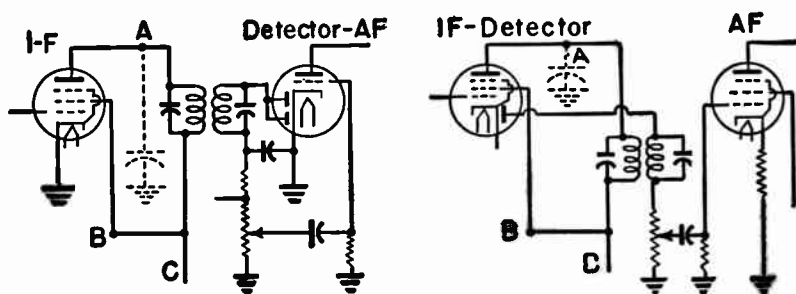

Fig. 18.—Points at which the i-f input to a detector may be cut off.

amplifier cannot be removed, as would be the case with series heaters or filaments, the plate of this tube may be connected to chassis ground as at A through a capacitor of 0.02 mfd or

greater capacitance. This capacitor should be of paper or mica type, not electrolytic. Third, the screen circuit for the last i-f amplifier may be opened at *B* in the diagram. Fourth, both plate and screen circuits may be opened at *C*.

If the detector is combined with the last i-f tube, as at the right in Fig. 18, this tube cannot be removed from its socket, regardless of heater or filament connections, without removing the detector. The plate may be grounded through a capacitor of 0.02 mfd or greater capacitance, as at *A*. The screen circuit may be opened at *B*, or both plate and screen circuits may be opened at *C* without affecting the action of the diode detector.

No signal generator is used during tests for residual hum, but an output meter may be connected to the loud speaker circuits. It is advisable to leave the speaker in action so that the hum voltage may be recognized by its low pitch. If the amplifier has a tone control it is set at the high-frequency or treble position. The volume control of the amplifier is turned to its lowest position, then varied while noting any change in hum output.

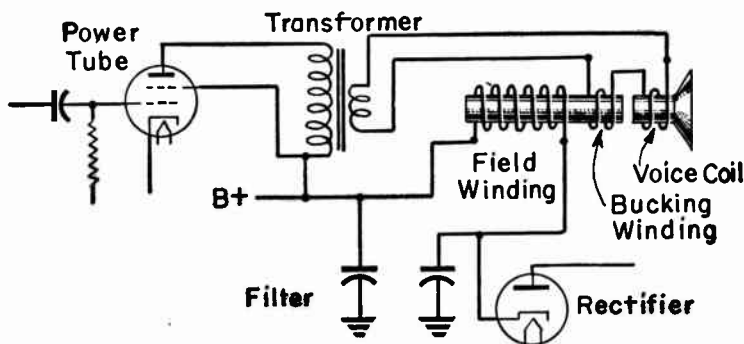

Fig. 19.—Hum bucking with an electromagnetic loud speaker.

Residual hum may be due chiefly to the loud speaker, especially when this unit is of the wound field type rather than of the permanent magnet type. To make a separate check of the loud speaker its voice coil leads, or one of these leads, may be disconnected from the secondary winding of the output transformer and the two ends of the voice coil shorted together.

Hum Bucking.—If a hum voltage or ripple voltage is to be objectionable to listeners this voltage must appear in the voice coil of the loud speaker or in the magnet or magnetic field of the loud speaker. In many loud speaker circuits the hum voltage which does appear is opposed by another voltage of equal amplitude but of opposite phase, so that the two voltages cancel either wholly or in large part. This general method may be called hum bucking.

Fig. 19 shows the principle of a hum bucking method which may be employed with loud speakers having a field winding. In this particular drawing the field winding of the speaker is used as the filter choke in the d-c power supply system, with the two filter capacitors connected between the ends of this winding and ground. On the field core is the bucking winding connected in series with the voice coil and the secondary of the output transformer.

In the field winding there are small variations of the direct current which are at the hum frequency, because the field wind-

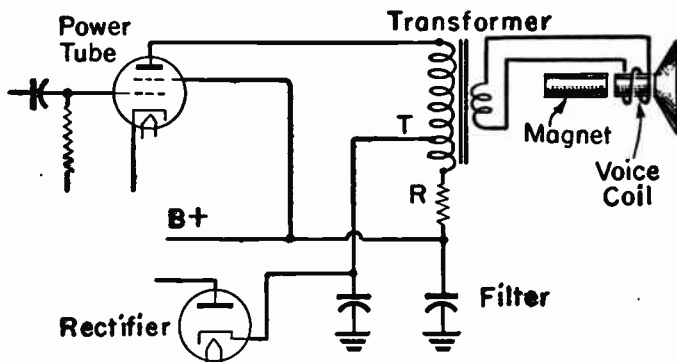

Fig. 29.—Hum bucking with a permanent magnet loud speaker.

ing is in series with the output from the rectifier. These variations of current induce in the bucking winding potentials which are at hum frequency. The relative directions of windings on the voice coil and the bucking winding are such that hum potentials induced in the bucking winding are in approximately

opposite phase to any hum potentials in the secondary circuit of the output transformer and in the voice coil.

Reversal of connections either to the field winding or else to the voice coil and bucking winding will cause hum potentials induced in the bucking winding to add to those in the voice coil circuit as taken from the output transformer secondary, and hum will be increased. Reversing the connections to both the field winding and to the voice coil and bucking winding will not affect the hum output. Therefore, either one set of connections or else the other set may be reversed to find the arrangement for least hum output from the speaker.

The hum bucking method shown by Fig. 19 cannot be used with permanent magnet loud speakers because there is no field coil to induce an opposing hum voltage. A similar effect may be had with the arrangement shown by Fig. 20. Here there is an off-center tap at *T* on the primary winding of the output transformer. The portion of the primary above this tap acts as the primary winding for the plate circuit of the power tube, so that audio-frequency current variations induce a-f potentials and currents for the secondary winding and the voice coil of the speaker. The portion of the primary winding below the tap, together with resistor *R*, act as a choke and resistor for the filter system in the d-c power supply, with the filter capacitors connected to *T* and to the lower end of *R*.

In the lower portion of the transformer primary there are variations at hum frequency of the rectified direct current output from the rectifier, because this portion of the winding is in series with the rectifier output. Electron flow from the power tube plate is downward through the primary winding above *T*. Electron flow coming back through the B+ connection from other circuits passes upward through *R* and the portion of the winding from *R* to *T* on its way to the rectifier cathode. Thus the hum potential in the power tube plate circuit is opposed by a hum potential in the lower section of the transformer primary. With correct design and normal rates of electron flow or current the two hum potentials cancel each other, cause no variations of primary current at hum frequency, and there are no hum potentials induced in the transformer secondary winding and speaker voice coil.

In any amplifier there is phase inversion or reversal of polarity between input and output of any one tube. Consequently, a hum potential produced in one stage sometimes may be wholly or partially cancelled by a hum potential in another stage. Hum may be intentionally caused in one stage to correct an overall hum appearing at the loud speaker. Such methods of hum correction seldom remain in effective action as the tubes age in service, and as some tubes are replaced with new ones.

REVIEW QUESTIONS

1. When testing selectivity to produce a curve such as that of Fig. 2, is the receiver tuning control varied above and below resonance? Is the receiver volume control varied during the test?
2. If a receiver lacks adjacent channel selectivity, would you look for trouble in the r-f amplifier or in the i-f amplifier?
3. What is the image frequency with the following conditions: Intermediate frequency 455 kc, oscillator frequency higher than tuned frequency, receiver tuned to 900 kc?
4. How would you determine whether the oscillator frequency is above or below the frequency to which a receiver is tuned?
5. Is hum voltage, due to insufficient filtering, identified most easily by using an output meter, an oscilloscope, or a set of headphones?
6. Modulation hum occurs only when tuned to an r-f carrier. It may result from poor filtering. Name two other causes for such hum.
7. Name two ways, other than removal from its socket, in which a tube may be prevented from amplifying.
8. Where would you look for a hum bucking coil with an electromagnetic loud speaker? With a permanent magnet loud speaker?

Chapter 7

DISTORTION AND NOISE

The output of an audio-frequency amplifier should be exactly like the input, with one exception. The exception is that the amplitude or voltage in the output should be greater than that of the input. This increase of amplitude is amplification or gain. But the output may differ from the input not only in amplitude but in at least four other ways. These other differences between

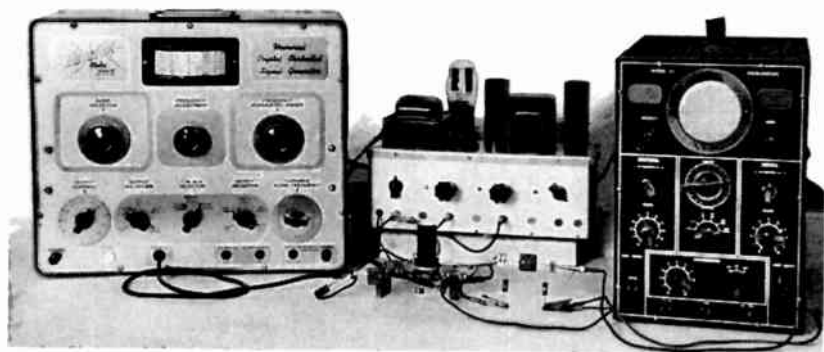

Fig. 1.—Checking harmonic and phase distortions of a single amplifying stage.

output and input are four kinds of distortion. They may be called amplitude distortion, harmonic distortion, frequency distortion, and phase distortion.

Amplitude Distortion.—There is amplitude distortion when input signals of some amplitudes are amplified more or less than input signals of different amplitudes. This kind of distortion was discussed in connection with methods of measuring gains or amplification ratios, where the gains were measured with inputs of various amplitudes and differences in gain were noted.

Amplitude distortion is represented by the curves in Fig. 2. At the left is an input wave and at the right is the resulting output wave from the amplifier. All parts of the input have the

same frequency and same waveform, but the amplitude varies. From *a* to *b* the input amplitude has a value of 1, which might be one volt. Between *b* and *c* the input amplitude is 2, and between *c* and *d* it is 3 units.

In the output wave we have an amplitude of 3 units between *a* and *b*. Then, with an input of 1 unit the gain is three times, because the amplitude is multiplied by 3. But between *b* and *c*

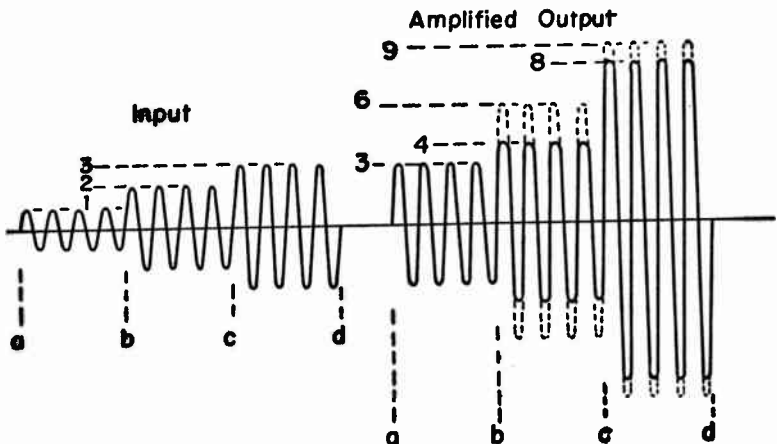

Fig. 2.—Amplitude distortion.

of the output wave the amplitude is only 4 units, as shown by the full-line curves. The input between *b* and *c* is 2 units, and with an output of 4 units the gain is only two times. Were the gain to remain three times the output amplitude between *b* and *c* would be 6 units, as shown by the broken-line tops on the curves. Between *c* and *d* in the output the full-line curves show an amplitude of 8 units, where the input amplitude between *c* and *d* is 3 units. Thus the gain here is $8/3$ or $2\frac{2}{3}$ times. Were there no amplitude distortion the output amplitudes would be as shown by the tops of the curves, and the gain always would be three times regardless of the amplitude of the input.

Amplitude distortion sometimes is called *modulation distortion*, because audio-frequency gain will vary with the percentage of modulation of the r-f signal. The greater the percentage of r-f modulation the greater will be the demodulated amplitude delivered from the detector to the first a-f amplifier tube.

Amplitude distortion may be checked or measured as in Fig. 3 with a modulated r-f signal generator having a control for percentage of a-f modulation. Otherwise any source of audio-frequency whose amplitude is adjustable, may be connected to the

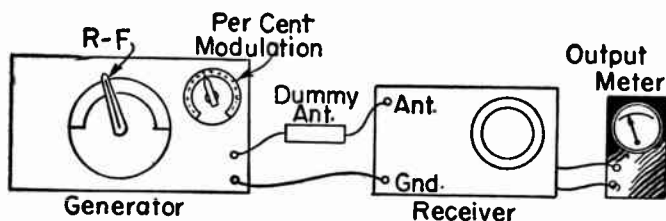

Fig. 3.—Instrument connections for checking amplitude distortion.

“external modulation” posts or jacks of an r-f signal generator. The output amplitude of the a-f source may be adjusted by means of a voltage divider or potentiometer while being measured with any rectifier type of a-c voltmeter giving sufficiently low readings. The test usually is made with the radio frequency at 1,000 kc and with 400 cycle modulation, although other modulation frequencies may be used. The output from the receiver should be kept low, to avoid other kinds of distortion, and the generator output varied to maintain a constant receiver output at the various audio frequencies of modulation. The modulation on the generator may be varied from 10 per cent up to 100 per cent during the tests.

Harmonic Distortion.—In an amplifier having harmonic distortion the original or fundamental frequency is amplified as usual, but at the same time there are produced in the amplifier various new frequencies which are harmonics of the fundamental. A harmonic frequency is one which is twice the fundamental, three times the fundamental, or any other number of times the fundamental frequency. The harmonic which has twice the fundamental frequency is the second harmonic, the one having three times the fundamental frequency is the third harmonic, and so on.

What happens when there is harmonic distortion is shown by Fig. 4. At the left is represented some certain frequency of input potential for the amplifier. This is considered to be the

fundamental frequency. In the output of the amplifier, as at the right, there is the amplified fundamental frequency shown at the top. At the same time there are in the amplifier output lesser amplitudes of current and potential at various harmonics of the fundamental. The second, third and fourth harmonics are shown by the curves underneath the fundamental, but other "higher order" harmonics also may be present.

All of the harmonic currents combine with the fundamental in the output to produce a complex waveform which is very different from that of the fundamental alone. Fig. 5 shows complex waveforms resulting from the combination in a single voltage wave of a fundamental frequency with a second harmonic, a third harmonic, and with both a second and third harmonic frequency. As an example, were a 400-cycle frequency applied to the input of an amplifier having harmonic distortion, the output might be a waveform resulting from a combination of 400 cycles, 800 cycles, 1,200 cycles, and other frequencies which are multiples of 400 cycles.

Harmonic distortion sometimes is called *waveform distortion*, because the output wave is not of the same form as the input wave. Another name used for harmonic distortion is *non-linear distortion*, meaning that changes of plate current do not cor-

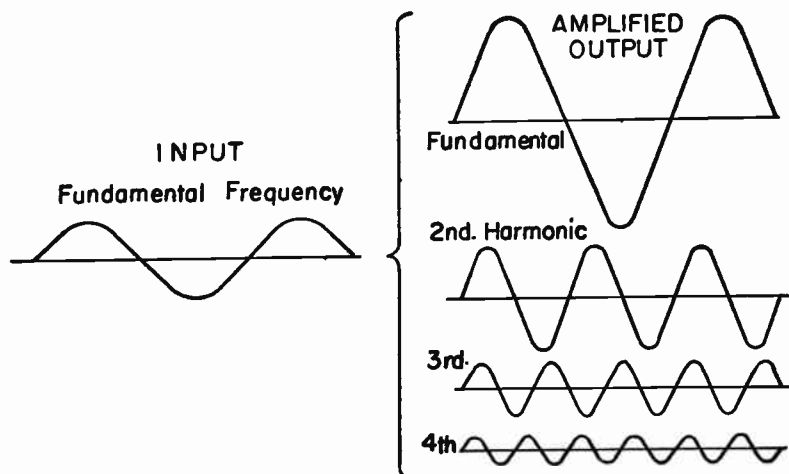

Fig. 4.—Harmonic distortion.

respond exactly to changes of control grid potential; that there is not a straight line or a linear relation between the two.

When the input to an amplifier having harmonic distortion is at a single frequency the output will contain this frequency and some of its harmonics. But if two or more frequencies are applied at the same time to the input of such an amplifier there will be beat frequencies in the output. The two or more input frequencies might themselves exist in a complex wave such as a musical note from some instrument. The beat frequencies will be equal to the sum of any of the harmonics or any of the fundamentals, or the sum of any fundamental and any harmonic. The beat frequencies may be equal also to the differences between fundamentals and harmonics in the input.

If the odd harmonics are strong the resulting distortion will be highly disagreeable to the ear. The odd harmonics are those of odd numbers; 3rd, 5th, 7th, and so on. The higher the order of an odd harmonic of given strength or amplitude the more troublesome it becomes. Some odd harmonics produce sounds which are not in any musical scale, with strange results at the loud speaker.

When examining tube specifications and ratings you will note that the ratings for maximum output most often are based on some certain percentage of total harmonic distortion, or else on some percentage of second harmonic distortion. The percentage of any one harmonic is the percentage which the amplitude or voltage of this harmonic forms of the amplitude or voltage of the corresponding fundamental frequency. To find the total harmonic distortion, as a percentage, we would add together the squares of all the separate percentages and take the square root of that sum.

The total harmonic distortion is one measure for tube and amplifier performance, but it is not necessarily true that a high harmonic percentage makes unpleasant tones. Many tones resulting from pure frequencies are not particularly pleasing to the ear, and certain harmonics may give a result more pleasing. But that resulting note will not correspond to the input, and there is distortion although it may be a pleasant sort of distortion.

Harmonic distortion results most often from operating audio amplifier tubes in such manner that there is plate current cutoff

during some part of each cycle or so that there is grid current during some part of each cycle. Plate current cutoff results from a control bias which is too negative for the plate and screen voltages being used, or from plate and screen voltages too low in relation to the grid bias being used. Grid current flows when the control grid becomes positive during some part of the cycle. This happens when the negative grid bias potential is less than the positive peak amplitudes of the signal applied to the grid. Under such conditions the positive signal more than overcomes the negative grid bias. The first check for causes of excessive harmonic distortion always is of plate, screen, and control grid voltages to make certain that they are of recommended values or are within normal operating limits for the tube.

In resistance coupled amplifiers distortion is increased by using grid resistors of too low resistance. Distortion at the low audio frequencies is increased also by using coupling capacitors of larger capacitance, although such capacitors increase the gain at the low frequencies. Distortion in these amplifiers is increased by using resistances higher than necessary in the plate load, this being the resistor connected to the tube plate and also to the coupling capacitor. While greater resistance in the plate circuit load increases the distortion it also gives a decided increase of gain. Gain and harmonic distortion are opposed in desirability of effects. When we make changes which increase the gain the same changes also increase this distortion.

The use of degeneration or inverse feedback in audio amplifiers tends to lessen the harmonic distortion while also making for more uniform amplification at all frequencies. Harmonic distortion whose cause is not found in incorrect operation of the amplifier tubes quite often results from incorrect control grid

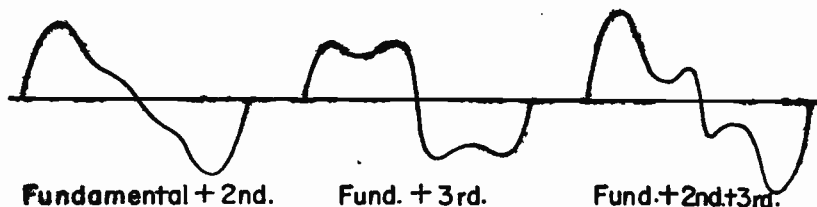

Fig. 5.—Waveforms showing harmonic distortion.

bias applied from the automatic volume control system. The avc voltage should be checked with various strengths of r-f input, or the avc characteristic may be measured as described in an earlier chapter.

Harmonic distortion of all orders or all harmonic numbers increases as the power output of amplifier tubes is increased. When coming close to the maximum power output for moderate distortion, usually called maximum undistorted power output, the harmonic amplitudes commence to rise quite sharply. Therefore, to avoid such distortion it is well to operate power amplifiers rather well below their power limits, thus avoiding the danger of severe distortion with a sudden rise of input signal strength. In class AB1 power amplifiers there will be a decided increase of distortion when operation gets to the point of plate current cutoff, although it is at this point and above that the full power capabilities of the amplifier may be realized.

Wide variations in loud speaker impedance with changes of audio frequency tend to increase the harmonic distortion. Because speaker impedances ordinarily are quite high at the very low audio frequencies and again at the high frequencies, it is in reproduction of lowest and highest notes that this kind of distortion appears.

With push-pull operation of power tubes the second harmonic frequencies are largely cancelled in the output circuit, thus leaving the third harmonic amplitudes as the limit on increase of signal input and power output. The fourth harmonic, being an even harmonic, will be cancelled like the even second harmonic. The fourth harmonic is relatively small in any case. This cancellation of second and other even harmonics assumes a sine wave input. If the input signal itself contains harmonics they will be amplified, including any second harmonics in the input. The cancellation applies only to even harmonics produced in the push-pull stage itself.

A practice often followed in push-pull amplifiers is that of using plate load resistances less than might normally be employed for the particular tube and its operating voltages. This smaller plate load resistance increases the amplitude of the second harmonic, but reduces the amplitude of the third harmonic. The increased second harmonic amplitudes are cancelled in the out-

put circuits, and there is a net effective reduction in the total harmonic percentage.

Although it should theoretically be possible to use an unby-passed cathode-bias resistor for a pair of push-pull tubes, sometimes it will be found that the addition of a bypass capacitor of several microfarads capacitance will lessen distortion by getting rid of unbalanced audio frequencies. A bypass ordinarily would be unnecessary because all potentials appearing in opposite polarity in the halves of the output primary winding should cancel.

In the outputs of power tubes operated in parallel will be even and odd harmonics just as would be found in the output of one of the tubes. The parallel connection does not increase the total harmonic percentage over what it would be for one tube. That is, there will be double the output and double the harmonic strength, but the ratio or percentage remains unchanged.

Tests for Harmonic Distortion.—Harmonic distortion usually is measured in the laboratory by means of a wave analyzer or else with a distortion meter. In one type of wave analyzer the voltage to be measured is fed into a mixer tube and combined with the output of an oscillator in the instrument to give sum and difference beat frequencies. One of these frequencies is amplified. Upon tuning the instrument to the various harmonic frequencies which may be present the amplitude of each such frequency is indicated by a meter as a fraction or percentage of the amplitude of the fundamental.

A commonly used type of distortion meter contains a rectifier for the alternating input frequency to be examined, also a filter, an amplifier and an electronic voltmeter. The meter indicates total harmonic distortion as a percentage of the fundamental frequency amplitude. Such meters are used also for direct measurement of hum or ripple voltage and of noise voltage in general.

Service checks of harmonic distortion are conveniently made with a modulated r-f signal generator or an audio-frequency signal generator and an oscilloscope. Connections for such a test are shown by Fig. 6. When using a modulated r-f output from the generator the high side of the generator is connected through the usual dummy antenna to the antenna terminal of the receiver, and to the receiver ground or chassis metal. If the generator is an audio-frequency rather than a radio-frequency type the high

side of the generator is connected to the ungrounded end of the volume control in the receiver, as shown by a broken line. This latter connection is used also when taking straight audio frequency rather than modulated radio frequency from an r-f type of signal generator.

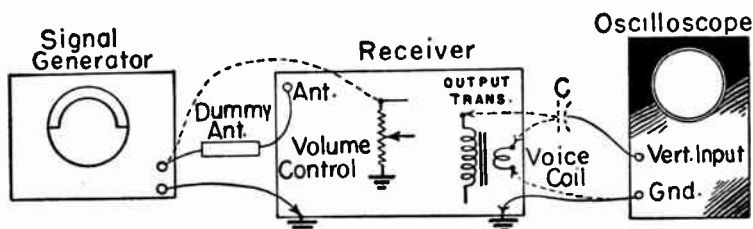

Fig. 6.—Connections for testing harmonic distortion.

When feeding modulated radio frequency to the antenna of the receiver there will be a check of overall distortion, such as might arise in r-f, i-f, or a-f sections of the receiver. With audio frequency fed to the volume control the check is only of the audio frequency system between volume control and loud speaker. The audio frequency for the test usually is 400 cycles, or is the modulation frequency of the r-f generator when this frequency is not adjustable.

The vertical input of the oscilloscope may be connected either to the plate end of the primary winding of the output transformer or else to one side of the speaker voice coil. The first connection checks only to the output of the power tube, the second checks all the way to the speaker itself. With a connection to the output transformer primary the oscilloscope ground is connected to the receiver chassis ground. For the voice coil test method the oscilloscope is connected to the second side of the voice coil.

The series capacitor at C may be of a high-voltage paper dielectric type having capacitance of 0.1 mfd or more when its purpose is to protect the oscilloscope from high plate voltages. If the receiver has a high hum output at the rectifier frequency the a-f output will be modulated with the hum frequency to

make a rather fuzzy trace on the oscilloscope screen. The hum component may be reduced by using at *C* a capacitance as small as 0.0005 mfd, although such a capacitance will itself introduce some waveform distortion.

The oscilloscope is set for internal sweep and the sweep frequency is adjusted to the audio frequency being used. The horizontal and vertical gain controls are used to make the trace of such size as allows observation of the waveform. Then the receiver volume control is operated while watching for change of waveform, keeping in mind that an increase of amplitude (height of the trace) is not in itself a change of waveform. Checks of waveform may be made also by altering the output of the signal generator. Harmonic distortion is indicated by waveforms such as shown by Fig. 5, or by any such irregular trace as shown by Fig. 7. By using a high-enough input from the signal generator and a high enough setting of the receiver volume control any receiver may be made to show a distorted output, which is due to overloading of the tubes. Harmful distortion is only that which shows up when the input and the volume control are

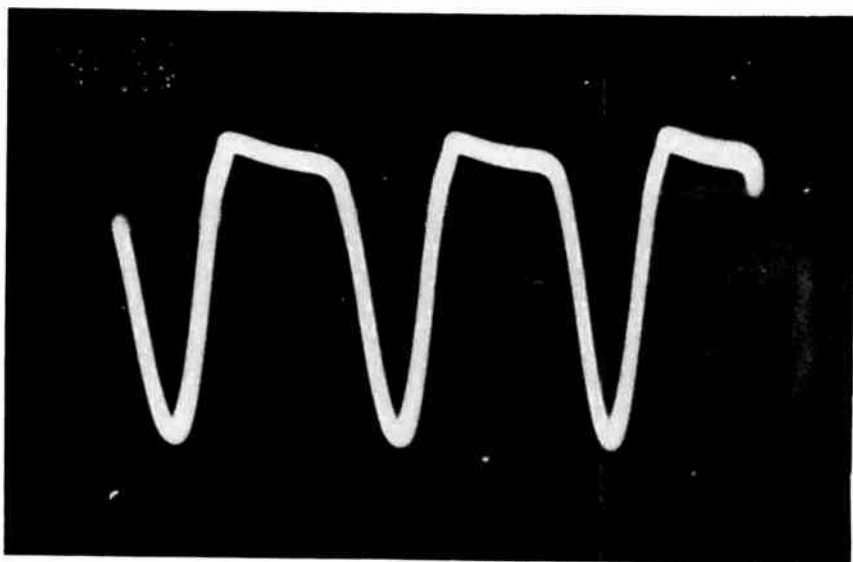

Fig. 7.—An oscilloscope trace showing distortion.

operated to give a volume of loud speaker sound output such as might reasonably be expected from the receiver or amplifier on test.

If distortion is present at the voice coil or the transformer primary, the vertical input connection of the oscilloscope should be moved back through the audio amplifier, connecting it to the several plates and control grids until reaching the volume control. If distortion disappears at some of these connections the fault lies between that point and the last previous point at which the distortion was evident. When tests are made at the plates of push-pull tubes there may be even harmonic distortion, but this should be cancelled in the output transformer, and a voice coil test then would show no distortion.

In discussing tests for harmonic distortion it has been assumed that the audio frequency from the generator has no distortion, that it is a practically pure sine wave. If there can be any doubt on this score the first step is to connect the a-f output of the generator directly to the vertical input of the oscilloscope and observe the waveform. If the generator wave is distorted the same distortion should appear in the receiver output unless it is obscured by bad distortion in the receiver. When making precise measurements of harmonic distortion it is customary to use a band-pass filter between an audio-frequency generator and the receiver or a-f amplifier. This filter is designed to pass freely the modulation frequency or audio frequency, and to greatly attenuate harmonic frequencies of that fundamental.

Frequency Distortion. — If a receiver or amplifier amplifies some audio frequencies more or less than others there is frequency distortion. At the left in Fig. 8 is represented an input potential in which there is medium or middle frequency to begin with (*a* to *b*) then a high frequency (*b* to *c*) and finally a low frequency (*c* to *d*). The input amplitude is the same for all frequencies.

If there is no frequency distortion the output at all frequencies will be uniformly amplified, as shown by the full-line curves. But the output may be as shown by broken-line curves. These curves show too great amplification of the high frequencies (*b* to *c*), too little amplification of the low frequencies (*c* to *d*), and the desired amplification only of middle frequencies (*a* to *b*).

No audio amplifiers such as generally used in receivers, public address systems, phonograph apparatus, and other applications will have perfectly uniform amplification from lowest to highest audio frequencies. It is not necessary to have perfectly uniform amplification for satisfactory reproduction of speech and music. However, there should be no great over-amplification in some

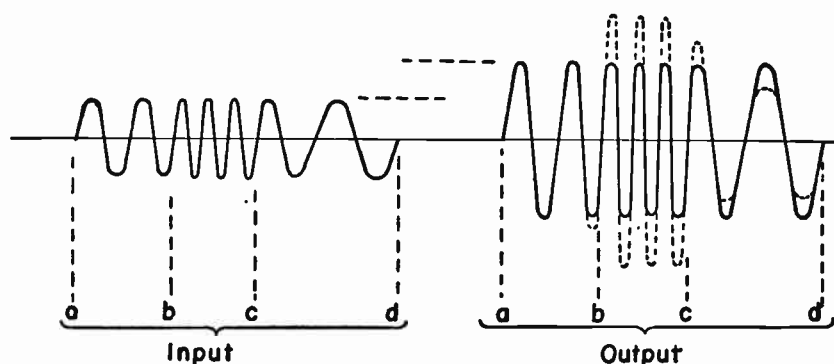

Fig. 8.—Frequency distortion.

narrow frequency ranges in the band, nor should there be great losses of amplification at only certain frequencies. In the absence of such decided irregularities there is no frequency distortion from the practical standpoint.

The ability of a receiver to amplify with satisfactory uniformity a good range of audio frequencies often is referred to as *fidelity*. Apparatus capable of sufficient amplification, but not too much, over a range of 50 or more than 10,000 cycles may be called a high-fidelity receiver or amplifier. Fidelity, in another sense, refers to absence of excessive distortion of all kinds; amplitude, harmonic, frequency, and phase distortion.

Many receivers are intentionally designed to reproduce with good audibility only a range of frequencies between something like 100 cycles and 5,000 cycles, or the high-frequency cutoff may be even lower than 5,000 cycles. All tone controls are arrangements designed to reduce the strength of certain frequencies or to emphasize other frequencies. But the effects of

intentional limiting of the audio frequency range and the effects of tone controls ordinarily are not considered as frequency distortion of the objectionable kind.

The test for frequency distortion or fidelity is made by measuring the relative audio-frequency outputs at various frequencies

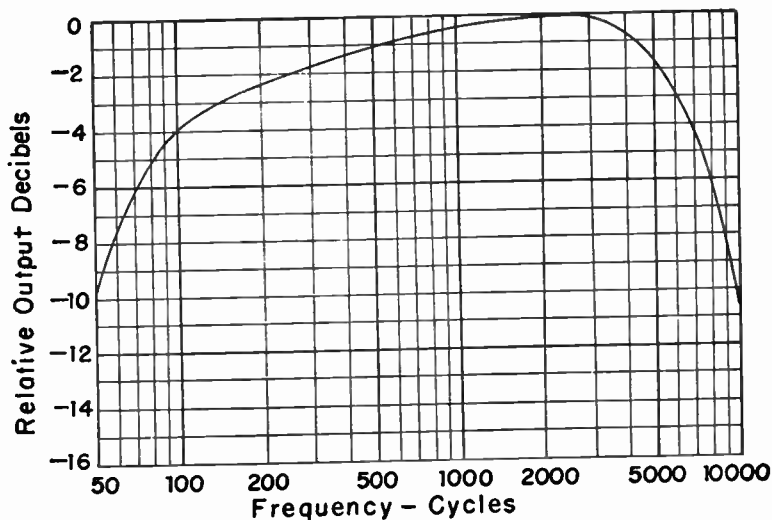

Fig. 9.—Fidelity curve or frequency distortion curve of a receiver.

from a low of around 30 or 50 cycles up to a high limit of at least 10,000 cycles. These relative outputs then are plotted on a graph to form a fidelity curve such as the one shown by Fig. 9. The frequency scale across the bottom is logarithmic to accommodate the wide frequency range while giving good separation of low frequencies. The vertical scale here is graduated in decibels below zero, although it might be graduated in a-f volts.

The signal source may be a modulated r-f generator, or it may be an r-f generator with external a-f modulation, or it may be an audio-frequency generator. When using a modulated r-f generator the radio frequency usually is set at or near 1,000 kc, although separate curves may be plotted at lower and higher frequencies and at one or more frequencies in each band. The r-f output amplitude of the generator is to remain constant for each

fidelity curve. Modulation should remain at 30 per cent, or at some other selected percentage of the r-f amplitude. The audio frequency of modulation must be adjustable, since it is necessary to take receiver output readings at enough audio frequencies to allow drawing the fidelity curve.

If the audio modulation frequency of the r-f generator is not adjustable an external audio oscillator or a-f generator may be used and connected to the external modulation terminals of the

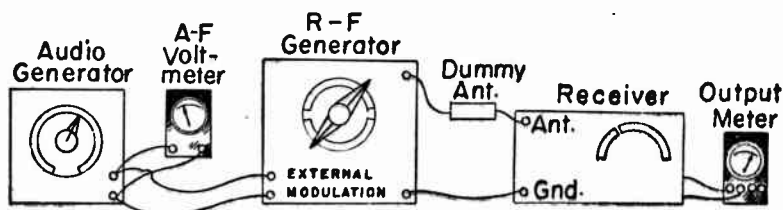

Fig. 10.—Connections of instruments for checking frequency distortion.

r-f generator. The arrangement of apparatus is shown by Fig. 10. The external source must be of adjustable frequency and its output amplitude must be kept constant, either by adjustment of a calibrated output control or else by measurement with a meter capable of indicating audio frequencies. Were this not done there would be a variation in percentage of modulation. Any type of r-f generator is connected through a dummy antenna to the receiver antenna post, and to the receiver ground.

If an audio-frequency signal generator is available it is connected to the receiver volume control just as in Fig. 6. The amplitude of the a-f output from this generator must be kept constant as the frequency is varied. There may be a calibrated output control. Otherwise the output may be measured with a suitable meter.

The output meter is connected either across the speaker voice coil leads or else across a dummy resistance connected in place of the voice coil to the output transformer secondary. If output readings are taken in decibels the fidelity curve will more nearly represent the effect on human ears than as though the readings were in a-f volts. Since a decibel meter probably will not match the voice coil impedance the actual readings of the meter may

be corrected by adding some suitable number of decibels to each actual reading to obtain values used for the curve.

When everything is ready for the test the receiver is carefully tuned to the generator frequency if an r-f generator is being used. Then the audio-frequency adjustment is varied while noting the frequency at which there is maximum output from the receiver. In Fig. 9 this frequency is between 2,000 and 3,000 cycles. With this frequency in use adjust the receiver volume control to give some fairly high reading on the output meter. This output will be considered as zero decibels if a decibel meter is used, or as maximum voltage with a voltmeter, and will appear at the top of the vertical scale, as in Fig. 9. Actual decibel readings are corrected to make this value equal to zero. Then readings of the output meter are taken at enough audio frequencies to give sufficient points on a graph for drawing the curve through the points.

If the receiver or amplifier has a tone control one curve should be drawn with this control in the high-frequency or treble position. Other curves may be plotted for other positions of the tone control, thus giving a check on how this control affects response at various audio frequencies.

Frequency distortion will result from any conditions which vary the impedance of audio-frequency plate and grid circuits when there are changes of frequency. This is because the gain rises with greater impedances and falls with less impedance. If one tube in an amplifier is overloaded to the extent that grid current flows in that tube, the preceding tube will be working into a plate load impedance which varies with flow of grid current in the following tube. Grid current results from a signal which is too strong or from control grid bias not sufficiently negative.

Loud speaker impedances which vary irregularly through the audio-frequency range cause varying loads in the plate circuits of power tubes, and cause frequency distortion. The greater the regular load resistance in the plate circuits of power tubes the less is the effect of variations in loud speaker impedance. Consequently this type of trouble will occur less often with power pentodes and beam power tubes than with triode power tubes. Sometimes there will be high impedance at some frequency due

to resonance in circuits having large inductances and large distributed capacitances when they tune at some audio frequency. This applies to circuits containing choke coils, and may occur in some transformers.

Phase Distortion.—When signals in the middle range of audio frequencies are applied to the input of an amplifier these signals will appear at the same instants in the output. But at low frequencies the output voltage will lead the input, while at high

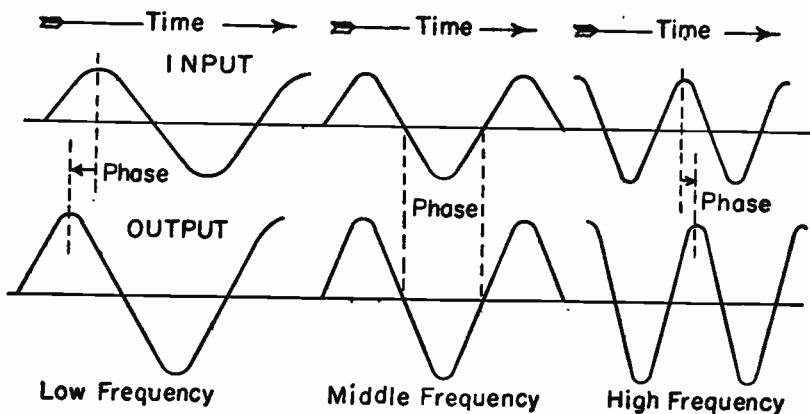

Fig. 11.—Phase distortion.

frequencies the output will lag behind in time. This is phase distortion, as represented by Fig. 11. The low-frequency signal is advanced in time or phase relation to the middle frequency, and the high-frequency signal is retarded in time relation to the middle frequency. The effect is as though different frequencies pass through the amplifier at different speeds, and in the output the time relation or phase relation of each frequency to the others is not the same as at the input.

There may be a great deal of phase distortion before the effect becomes unpleasant to our ears, and so this kind of distortion is not of great importance in ordinary sound amplifiers. But the results of phase distortion may be serious in long transmission lines, in many applications at ultra-high frequencies, in all types of measuring instruments wherein frequency is a factor in the measurements, and especially in television amplifiers. Phase dis-

tortion in television amplifiers results in some parts of the image on the picture tube screen being displaced in relation to other parts.

Phase distortion increases when the frequency decreases because the reactance of the coupling capacitor, X_c at the left in Fig. 12, becomes greater and greater as the frequency drops,

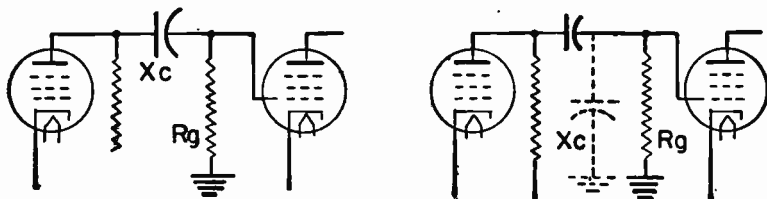

Fig. 12.—Factors affecting phase distortion in resistance coupled amplifiers.

and becomes increasingly larger in comparison with the resistance of grid resistor R_g . Phase distortion increases at the high frequencies because the reactance of the shunting capacitances, X_c at the right in Fig. 12, becomes smaller and smaller in comparison with the resistance of R_g .

The increase of coupling capacitive reactance at the low frequencies makes the whole circuit more and more capacitive, and it is well known that in any capacitive circuit the current (here the output signal) leads the voltage (the input signal). Hence the lead of the output at low frequency in Fig. 11. The decrease of shunting capacitive reactance at the high frequencies has an opposite effect. The circuit becomes less capacitive, which is equivalent to becoming more inductive, and in any inductive circuit the current (output signal) lags the voltage (input signal) as for the high frequency in Fig. 11.

In a resistance-capacitance coupled circuit, such as shown by Fig. 12, the gain decreases at low frequencies because there is an increase of reactance in the coupling capacitor. The gain decreases at high frequencies because there is a drop in capacitive reactance of the shunting capacitances. Thus the same factors which cause the decreases of gains at low and high frequencies also cause the increases of phase distortion at these frequencies. Anything which helps to make the gain more uniform, or to maintain the gain at low and high frequencies, helps also to lessen

phase distortion. The use of degeneration or negative feedback makes for more uniform gain, and also lessens phase distortion.

Low-frequency gain is improved, and phase distortion reduced, by using more capacitance in the coupling capacitor. But the larger capacitor increases the shunting capacitance of the circuit, and there is more rapid falling off of gain and increase of phase distortion at the high-frequency end of the range. The relation between gain and phase distortion is so direct that either one may be computed when the other is known.

Phase distortion never can become quite so great as 90 degrees of the alternating signal potential cycle. This means that the time advance at low frequencies and the time delay at high frequencies never can become quite so much as the time of one-quarter cycle. When talking about the low-frequency, middle-frequency, and high-frequency ranges of an amplifier we usually consider that the middle-frequency range extends between the frequencies at which the gain is down three decibels or is down to 0.707 of the maximum voltage. At these limits of the middle-frequency band the phase distortion will be 45 degrees, or one-eighth of the time of one cycle. If this low-frequency cutoff were at 100 cycles, where the time for one cycle is $1/100$ or 0.01 second, the phase distortion would be one-eighth of this or 0.00125 second. At a high-frequency cutoff of 5,000 cycles the phase distortion would be 0.000025 second.

The frequencies at which phase distortion commences may be observed by using a signal generator having an adjustable audio frequency output in connection with an oscilloscope. This test will show also the severity of phase distortion. Since phase

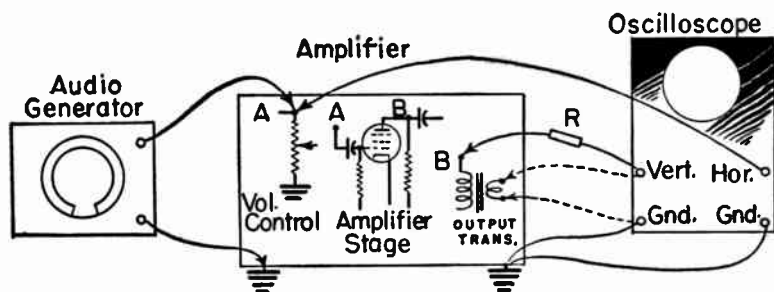

Fig. 13.—Connections of instruments for checking phase distortion.

distortion commences when gain begins to drop off, the same test will show the approximate limits of uniform gain through the middle frequencies.

Connections of apparatus for the test are shown by Fig. 13. The generator is of any type which will furnish an audio-frequency output adjustable between 30 or 50 cycles and 10,000 cycles or more as the upper limit. The high side of this generator is connected to the input of the amplifier being tested, and at the same time is connected to the horizontal input of the oscilloscope so that the same signal frequency is applied to both the amplifier input and the oscilloscope horizontal deflection system. The low side of the generator is connected to the chassis ground or to any ground post of the amplifier.

For checking a complete amplifier, from volume control or input attenuator clear through to the voice coil the generator high side and oscilloscope horizontal input are connected to the ungrounded end of the volume control or attenuator as at *A*. The vertical input of the oscilloscope is connected across the voice coil leads of the speaker, as with broken-lines. Otherwise the oscilloscope vertical input may be connected to the plate end of the primary of the output transformer, as at *B*, and to the amplifier ground, as shown by full lines. With this latter connection a protective resistor *R* (about one-half megohm) should be in series with the vertical input lead.

For checking any one stage the oscillator high side and the oscilloscope horizontal input are connected to the input for the stage, *A* in the diagram. Here it will be necessary to connect in series with the generator lead a resistance of a half-megohm or more to prevent practically grounding the input through the low resistance of the output attenuator in the oscillator. If the amplifier input connection, *A*, is in the plate circuit of a preceding tube there must be in series with the generator lead a capacitor of one mfd or greater capacitance and of working voltage amply high for the plate voltage in the circuit. This capacitor should be a paper type, not an electrolytic. Then the connection to the amplifier unit will be as in Fig. 14. The protective capacitor is at *C* and the protective resistor is at *R1*. The vertical input of the oscilloscope now is connected through a protective resistor *R2* (one-quarter megohm or more resistance) to the plate circuit

of the amplifier tube at *B*. All the ground connections remain as in Fig. 13.

To make the test proceed as follows: With the amplifier or receiver turned off temporarily remove the vertical input lead of the oscilloscope from *B* in Figs. 13 or 14 and connect it to *A*,

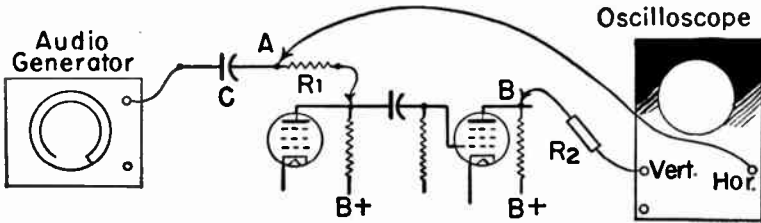

Fig. 14.—Details of connections for the phase distortion test.

so that the generator output is applied to both the horizontal and vertical inputs of the oscilloscope. Set the generator output amplitude, at any frequency, to produce a trace an inch or so long on the oscilloscope screen. Adjust the oscilloscope vertical and horizontal gain controls to place this line at about a 45-degree angle on the screen, and leave the gain controls in these positions.

Replace the vertical input lead of the oscilloscope on point *B* of the diagrams and turn on the receiver or amplifier. Now vary the frequency of the generator. At some frequencies the trace on the oscilloscope will remain a practically straight line. This line may be fuzzy, because of hum and other distortions from the amplifier, but at frequencies where it is practically straight there is no phase distortion. Adjusting the generator to lower

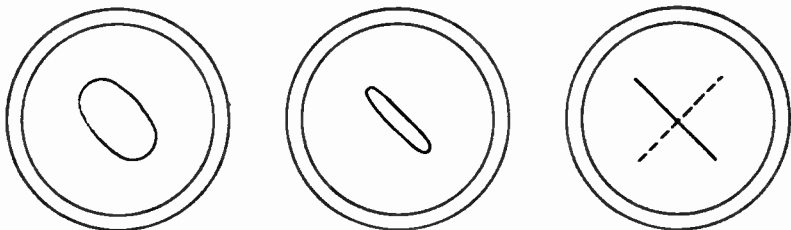

Fig. 15.—Traces showing no phase distortion (right) and showing such distortion (center and left).

frequencies will cause the straight-line trace to open out into an ellipse, as in Fig. 15. The original straight diagonal line is shown at the right. Moderate phase shift or phase displacement is shown at the center. The more nearly the trace becomes of circular pattern the greater is the phase shift at the applied frequency. Such a condition is shown at the left.

Whether the diagonal line and the axes of the ellipses slope one way or the other, as shown by the full line and broken line in the left-hand diagram, depends on how many amplifying stages are included between input and output. It is a matter of the number of phase inversions.

Low-frequency phase distortion is lessened, and low-frequency gain increased, by using in the plate circuit of the amplifier tube

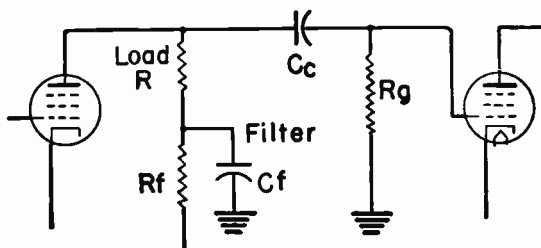

Fig. 16.—Position of the plate circuit filter in an amplifier stage.

a resistance-capacitance filter as shown by Fig. 16. The regular plate load resistor is between the tube plate and the filter. The filter resistance is R_f , the filter capacitance is C_f , the regular coupling capacitor is C_c , and the grid resistor for the following tube is R_g .

If the time constant of the entire plate circuit can be made the same as the time constant of the following grid-cathode circuit there will be the same phase shift in both and, theoretically, there will be no phase displacement. It is desirable to have the filter resistance small in comparison with the load resistance up above, also to have the reactance of the filter capacitor C_f no more than one-tenth of the filter resistance at the very low audio frequencies. Then the plate circuit consists essentially of the load resistance in series with the filter capacitance, and the following grid circuit consists essentially of the grid resistance in series with the coupling capacitance.

The two time constants will be equal when the products of the circuit resistances and capacitances are equal. That is, multiplying the number of megohms of load resistance by the number of microfarads of filter capacitance should give the same product as multiplying the number of megohms of grid resistance by the number of microfarads of coupling capacitance. This filter arrangement can be used only between two a-f amplifying tubes, since in the output or power tube stage there is no following tube and no following grid resistor.

Noise.—Noise, as it comes from the loud speaker, has no particular frequency but is distributed more or less evenly throughout the whole audio range above about 200 cycles. The sound is best described as a hiss, possibly mixed with slight crackling. Noise results also from irregular small impulses which occur throughout the entire radio-frequency range, these being a sort of modulation on any received carrier and producing audible noise after demodulation or detection.

Because radio-frequency noise impulses exist all through the r-f range the narrower the band selected for amplification in the receiver the less total noise is collected along with the desired signal. Consequently, noise is reduced by selectivity in the r-f and i-f amplifiers. Tone controls which reduce the audio response at the higher frequencies lessen the proportion of noise to desired signal, because most of the noise is in the higher audio-frequency range.

Noise output of an amplifier or receiver may be measured with the regular output meter, but because the meter also measures low-frequency hum it is desirable to use between receiver output and meter a high-pass filter. This filter should cut off all frequencies below about 300 cycles as completely as possible. Noise may be checked with a signal tracer having an audible output, since with such an instrument the difference between hum and hissing noises may be detected by ear.

In addition to noise impulses which enter a receiver through the antenna circuit other noises are produced within the amplifying stages. These are of two kinds; thermal noise and tube noise. Thermal noise results from random motion of free electrons in conductors. If you consider any conductor connected at its ends to other conductors there will be movement of free electrons

between atoms even when there is no steady or alternating current in the circuit. Free electrons will move back and forth between the conductors. The average flow will be zero, or there will be as much flow one direction as the other over any fairly long period. But at any one instant more free electrons may go one direction than the other. This unbalanced movement is an electron flow, and in the resistance of the conductors this flow causes small irregular voltages to appear. When the small potentials are amplified in following stages they cause noise.

Thermal noise increases with conductor temperature, because at higher temperatures there is more electron movement. Such noise increases also with resistance of the conductor, because given currents or flows cause voltages which increase with resistance. Even though the actual ohmic resistance or parts in a parallel resonant circuit is small, there may be thermal noise which is proportional to the parallel impedance of the circuit. High-impedance circuits cause more noise than those of lower impedance.

Tube noise results from slight irregularities in the rate of electron flow from cathode to plate. Even with no input to the control grid there will be small voltages in the plate circuit, these being due to the electrons from the space charge which strike the plate. The noise voltages thus produced in the output extend over a great range of frequencies with about equal amplitudes. The greater the mutual conductance or transconductance in comparison with the plate current the less is the tube noise. This is the reason that r-f amplifier tubes are selected for high mutual conductance and rather small plate currents. Tube noise becomes more troublesome the higher the operating frequency. This is a result not so much of the frequency itself as of the fact that high-frequency amplifiers have grid circuits of relatively low impedance. The lower the impedance in the grid circuit the less is the gain and the smaller will be the plate circuit signal in proportion to tube noise in the plate circuit.

Amplifier tubes which have excessive quantities of gases within their envelopes are very noisy. In such tubes there is not only the impact of electrons on the elements but also that of the relatively heavy ions of the gases.

The amplified effect of thermal noise and tube noise may be

heard from receivers having plain automatic volume control when they are tuned between stations. When no carrier signal is applied the gain rises to high values as the grid bias is automatically reduced by the AVC action.

Tube noise and thermal noise may cause disagreeable sound output only when the causes for these noises are in the first and possibly in the second amplifying stage. The outputs of these early stages receive great amplification before reaching the loud speaker. Tube and thermal noise voltages in later stages are not amplified enough to do much harm in the final output.

Although good selectivity reduces the effect of "hiss" noise potentials reaching the antenna it tends to increase the effect of sharp intermittent pulses of interference such as result from atmospheric static, commutator sparking in motor driven appliances, opening of line switches, and sparking in general. Such impulses start oscillations at the tuned frequency in resonant circuits, and the oscillating currents continue until damped out by the circuit resistance. The more selective a tuned circuit, and the higher its Q-factor, the stronger are the oscillations and the longer they continue.

REVIEW QUESTIONS

1. What voltages at amplifier tubes should be checked when harmonic distortion is suspected?
2. Which is likely to cause harmonic distortion: Grid resistor too great or too little? Plate circuit resistor (load resistor) too great or too little?
3. Is harmonic distortion due to varying impedance of a loud speaker likely to be more noticeable at middle frequencies or at high and low frequencies?
4. Should a high-grade receiver be expected to provide absolutely uniform amplification of all frequencies in the audio range?
5. Variation of plate circuit impedance causes frequency distortion. Does this mean that the output frequency is not the same as the input frequency?
6. Is phase distortion more serious in an audio-frequency amplifier, or in a long-distance transmission line?
7. Which is likely to be more noisy, a highly selective resistor or one less selective? What is there about the noise frequencies which brings about this result?
8. Which would be more affected by static, as distinguished from noise produced in an amplifier, high-Q circuits or circuits of more r-f resistance?

Chapter 8

GAS-FILLED AND VAPOR-FILLED TUBES

In all tubes classed as vacuum types, whose envelopes contain only minute traces of gases, the electrons traveling from cathode to plate lose much of their energy in getting through the evacuated space. The electrons have to overcome resistance between cathode and plate. The apparent resistance might be measured by applying known values of direct potential differences between cathode and plate, measuring the resulting rates of electron flow, and computing the ohms of resistance.

Were such measurements made on triode amplifiers and on any tubes connected as triodes and with the grids connected to the cathode the apparent resistances would be as follows: Around 2,000 ohms with power tubes. Around 10,000 ohms with many voltage amplifiers. Around 60,000 ohms or more with high- μ tubes. Using the same methods on vacuum types of rectifier tubes would show apparent resistances ranging from 150 to 600 ohms.

The rates of electron flow through the tubes and their connected circuits would depend on the resistances of the tubes and also on the resistances of the external circuits. These two resistances would be in series, and their sum would determine the rate of electron flow with any given potential difference applied to the whole circuit.

Measuring or computing the apparent tube resistance with various values of electron flow or current in any one tube would show that the tube resistance does not remain constant. With small currents the apparent resistance would be relatively great. With increase of current the resistance would drop lower and lower. This is true, in a general way, of all evacuated tubes.

Were a thoroughly evacuated tube to have a small quantity of gas admitted before finally sealing the envelope we should have a gas-filled tube or gaseous tube. Again making measurements of apparent tube resistance would show a remarkable difference between performances of gas-filled tubes and vacuum tubes. A



Fig. 1.—A gas-filled tetrode tube used for control purposes.

gradual increase of voltage between cathode and plate would show a high apparent resistance with moderate voltages. But at some certain voltage the resistance of the tube would practically disappear, and at the surface of the cathode would appear a luminous glow whose color would depend on the kind of gas in the envelope. Then the rate of electron flow through the tube and its connected circuit would depend almost entirely on the resistance in the external circuit, and hardly at all on the tube itself.

Ionization.—The tube resistance all but disappears because of an action called ionization of the gas within the envelope. What happens during ionization of the gas is shown by Fig. 2. In diagram 1 the billions of gas atoms in the space between cathode and plate are represented by three atoms. They are neutral atoms to begin with, and are shown by circles enclosing positive and negative signs. The billions of negative electrons in the space charge near the cathode are represented by a few small circles enclosing negative signs.

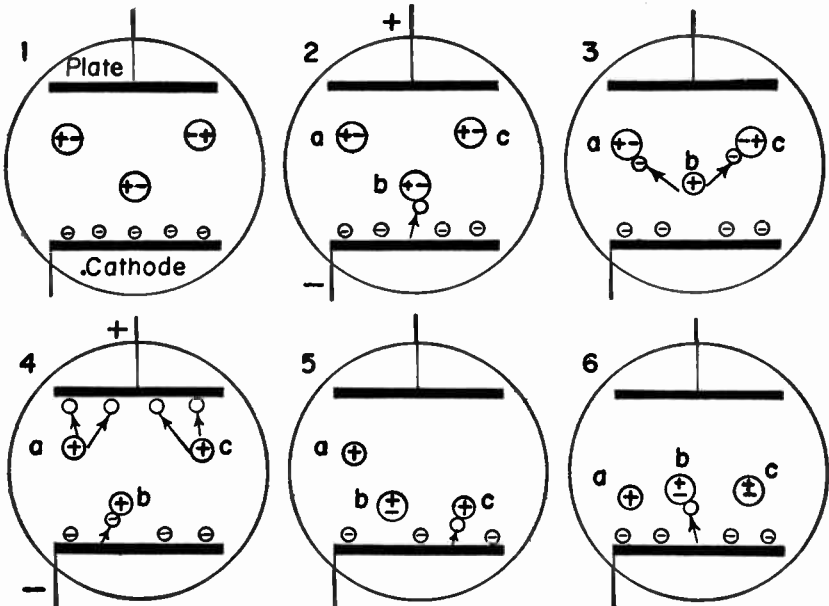

Fig. 2.—What happens during ionization in a tube.

In diagram 2 the plate has been made positive and the cathode negative. An electron from the space charge is drawn toward the plate by attraction, but before getting very far this electron collides with atom *b*. The flying electron strikes the atom so hard that one of the electrons in the atom is knocked out of the atom and into the surrounding space. The original electron still is being drawn toward the plate, and the newly freed electron also is drawn toward the plate. Before the two electrons go very far they collide with neutral atoms *a* and *c*, as in diagram 3.

Now, in diagram 4, each of the two electrons has knocked an additional electron out of atoms *a* and *c*, and instead of the original electron which started alone from the space charge in diagram 2 there now are four electrons entering the plate.

Going back to diagram 3, the loss of an electron from atom *b* left this atom with a net positive charge. An atom with a positive charge, or an atom which lacks one or more of its normal complement of electrons, is called a *positive ion*. Such an atom has been ionized in the process called ionization. In diagram 4 atoms *a* and *c* have lost electrons and these atoms have become positive ions. In this same diagram positive ion *b* has attracted to itself one of the negative electrons from the space charge.

In diagram 5 the negative electron drawn from the space charge has combined with positive ion *b* to form a neutral atom. Thus atom *b* has gone through the whole process of being ionized and then deionized. The positive ions are drawn toward the negative cathode by the attraction between the unlike charges. As the ions pull electrons out of the space charge in the re-formation of neutral atoms there is made room in the space charge area for more negative electrons to emerge from its cathode surface. The emission of these new electrons into the space charge is greatly assisted by the attractive force of all the positive ions which gather near the cathode surface.

In diagram 6 atom *c*, which was a positive ion, has acquired the electron which again makes this a neutral atom. At the same time the attraction of the positive charge on the plate has started another electron away from the center of the cathode. This electron which is trying to get to the plate collides with neutral atom *b*, and we start over again as in diagram 2.

Ionization does two things. First, as in diagram 4, there are

produced in the tube space many, many times as many electrons as originally leave the cathode. Second, as in diagrams 4 to 6, much of the space charge is neutralized by the positive ions. The space charge is a negative charge (negative electrons) and it tends to retard or prevent emission of electrons from the cathode. Neutralization of the space charge permits a great increase in the rate of electron mission. What has been shown for a few atoms, ions, and electrons in Fig. 2 is occurring billions of times per second throughout the space between cathode and plate.

Among the gases used singly or mixed in tube envelopes are argon, neon, helium and xenon. These gases are used in gas-filled tubes. In other tubes which make use of ionization there is the vapor of mercury, evaporated from a small quantity of liquid mercury by heat in the tube. The ionization in these mercury-vapor tubes is started by some gas which is in the envelope, and then the mercury is vaporized. The total quantity of gas or vapor put into the tube envelopes varies from about 1/15 to 1/75000 of the total quantity of gases in an equal volume of open air.

Ionization commences only when electrons traveling from cathode to plate gain enough velocity and force to knock other electrons out of the gas atoms. The velocity and force of the emitted electrons increase with greater potential difference between cathode and plate. Ionization commences when this potential difference is made of a value required by the kind of gas, its density, and other structural factors of the tube.

When voltage is increased gradually the action is as shown by

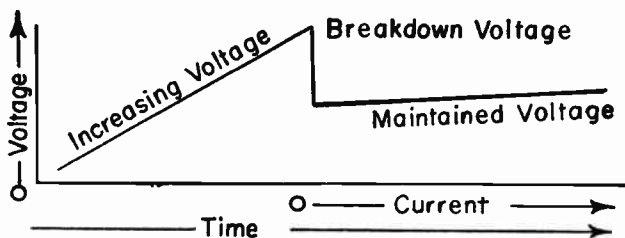

Fig. 3.—The maintained voltage drop in a gas-filled tube is less than the breakdown voltage.

Fig. 3. Ionization commences when the applied voltage has been raised to the breakdown point, which sometimes is called the *ignition voltage* or *starting voltage*. Then the voltage across the tube, or between cathode and plate, drops suddenly to some lower value which is maintained with little change. There is appreciable current through the tube only after breakdown.

The maintained voltage or the constant voltage drop in the tube is only of the value required to continue the ionization. It is only the voltage needed to give electrons enough velocity so that they may knock other electrons from atoms. This voltage drop



Fig. 4.—One type of voltage regulator tube.

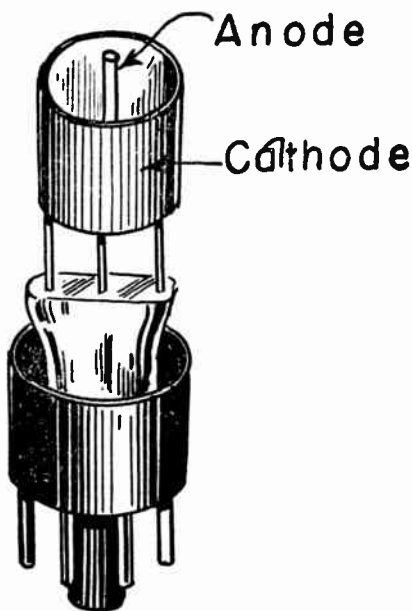

Fig. 5.—The anode and cathode of a voltage regulator.

is not related to the rate of electron flow or current flow through the tube. Were there no external resistance in the tube circuit the only limit on the current would be destruction of the tube. Spots on the cathode would quickly become red hot, due to positive ions striking the cathode surface. Then the normal "glow discharge" would change to an "arc discharge," and unless the

cathode were designed for such operation it would soon disintegrate.

The maintained voltage drop depends on the type of tube, its construction and the kind of service for which it is designed. In gas-filled and vapor-filled rectifier tubes and also in triode and tetrode tubes the drop usually is somewhere between 8 and 25 volts, regardless of current. In tubes designed for the special purpose of maintaining a nearly constant voltage in a circuit the drops range between 55 and 150 volts for commonly used types.

If the voltage across a gas- or vapor-filled tube is gradually decreased while the tube is ionized there will come a point at which ionization stops almost as suddenly as it began during the increase of voltage. This break-off occurs when so few ions are being formed by collisions that more ions are being lost by combining with electrons than are being formed anew.

Voltage Regulator Tubes.—Gas-filled tubes called voltage regulators are used to maintain nearly constant voltages when there are changes of current in the plate, screen, and grid biasing circuits of amplifiers and testing instruments. These tubes have only two elements, an *anode* corresponding to the plate in other tubes, and a cold cathode in the form of a cylinder around the central anode as in Fig. 5. There is no heater and no filament. While the gas inside the envelope is ionized a blue or purple glow may be seen near the inner surface of the cathode. The greater the current through the tube the more of the cathode surface becomes covered by this glow.

The voltage regulator tube acts much as would a variable resistance connected between power supply and amplifier circuits in Fig. 6 at the point marked *Voltage Regulator*. Without this variable resistance in place there would be a decrease of plate and screen voltages at the amplifier tube whenever there were increases of plate and screen currents. The voltages would decrease because of the greater drops in the power supply system as the increased currents flowed in the circuit resistances. With smaller plate and screen currents there would be greater plate and screen voltages, because of smaller drops in the circuit resistances. Voltages at the amplifier vary because of changes in current taken from the power supply.

There would be a constant output voltage from the power

supply were the current drain maintained constant. The current could be maintained constant were the resistance of the regulator varied with every change of current to the amplifier. The resistance would have to be increased when the amplifier demanded more current. Then less current would flow in the regulating resistance. The sum of the currents to the amplifier and the regulating resistance would remain constant, and the supply

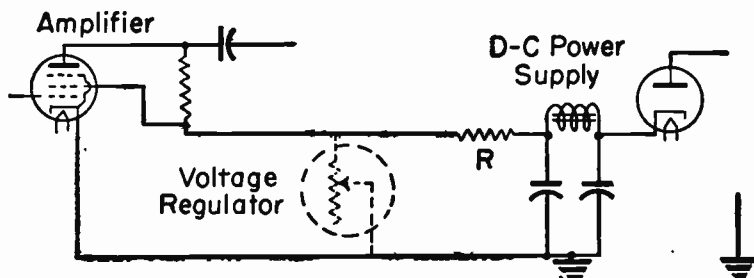

Fig. 6.—The voltage regulator acts like a variable resistance in parallel with the load.

voltage would remain constant. When the amplifier required less current more would have to flow through the regulating resistance. This would be allowed by decreasing the resistance, again maintaining an unchanged total current for amplifier and regulating resistance together.

A voltage regulator tube connected across a supply circuit as in Fig. 6 automatically varies its effective resistance with the slightest changes of voltage. If the circuit voltage tends to rise, due to less current taken by the amplifier, the effective resistance of the voltage regulator will drop. Then the regulator will take more current as the amplifier took less. A drop of voltage would cause a great increase in effective resistance of the regulator, and less current would flow through the regulator as more flowed to the amplifier.

The regulator changes its effective resistance because only a very small increase of voltage on the tube causes a great increase in the rate of ionization; for the reason that electrons are speeded up and collide more often and more violently with gas atoms.

Fig. 7 shows the performance of a voltage regulator tube de

signed to maintain a load potential in the neighborhood of 105 volts. One graph shows how the internal resistance or effective resistance of the voltage regulator tube decreases as the voltage across the tube is increased from 104 to 108 volts. With a one-volt rise of potential, from 104 to 105 volts the internal resistance drops from about 22,000 to 7,500 ohms, and with greater voltage the resistance drops to only a little more than 2,500 ohms when the potential reaches 108 volts.

The other graph shows how current through the voltage regulator tube increases when there is an increase of voltage across the tube. Between 104 and 108 volts the current increases from

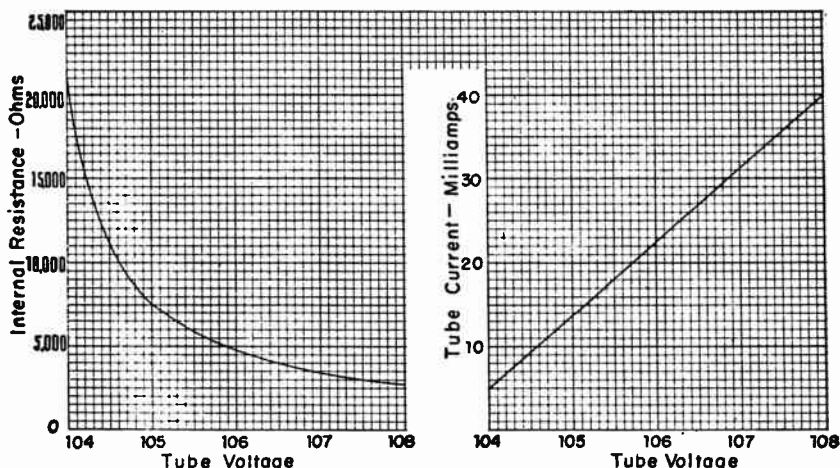

Fig. 7.—Changes of internal resistance and current in a voltage regulator when there are changes of voltage drop.

5 to 40 milliamperes. Were this particular regulator used in parallel with a power supply and amplifier as in Fig. 6, current in the amplifier plate and screen circuits might vary from 40 to 5 milliamperes and cause a change of potential only from 104.0 to 105.7 volts. This is shown by the current curve of Fig. 7.

There are six important operating characteristics of a voltage regulator tube: 1, the minimum d-c voltage at which there is

breakdown, called the starting voltage. 2, the nominal average working voltage which the tube is designed to maintain. 3, the minimum operating voltage. 4, the maximum operating voltage. 5, the minimum operating current. 6, the maximum operating current.

Starting voltages for various types of tubes are from 20 to 40, per cent higher than average working voltages. Working voltages for common types of radio voltage regulators are 75, 90, 105 and 150. Minimum and maximum operating voltages for the tube of Fig. 7 are 104 and 108. Its minimum and maximum operating currents are 5 and 40 milliamperes. The minimum or greater current must be maintained or else ionization will cease and the tube no longer will regulate. The maximum current must not be exceeded, except for brief intervals while amplifier tubes warm up, or else the cathode of the regulator tube will be damaged.

If the maximum voltage for the regulator tube is not exceeded then the maximum safe tube current cannot be exceeded. To prevent the possibility of excessive tube voltage a fixed resistor, *R* of Fig. 6, always must be in series with the power supply and the regulator. The resistance at this point must be such that



Fig. 8.—Socket and base connections for voltage regulator tubes.

with no current being taken by the load, and with maximum permissible current through the regulator, the supply voltage will be dropped to the value of safe tube voltage. For example, were the maximum possible supply voltage to be 200, and the maximum permissible regulator voltage 150, the difference of 50 volts would have to be dropped in the protective resistor. The required resistance is determined from the necessary voltage

drop and the maximum permissible regulator current. Were this current 40 milliamperes or 0.04 ampere we would divide 50 (volts drop) by 0.04 to find that the protective resistance must be 1,250 ohms.

The required protective resistance for any regulator tube and supply voltage may be determined by subtracting the maximum regulator voltage from the maximum supply voltage, then dividing by the maximum permissible regulator current—just as was done in the preceding paragraph.

Fig. 8 shows socket and base connections for voltage regulator tubes as seen from the bottom of the tube base. The left-hand diagram shows an octal base with six pins. The cathode is connected to pin 2, the anode to pin 5, and between pins 3 and 7 is an internal conductor called a *jumper* which is used for circuit connections as shown later. A miniature type of regulator uses the base connections of the center diagram, with the miniature button 7-pin base. The cathode is connected to pins 2 and 7, with the anode connected to pins 1 and 5. A jumper connects pins 2 and 4. The 4-pin base of an older type is shown at the right. Here the cathode is connected to pin 1, the anode to pin 3, and there is a jumper between pins 2 and 4.

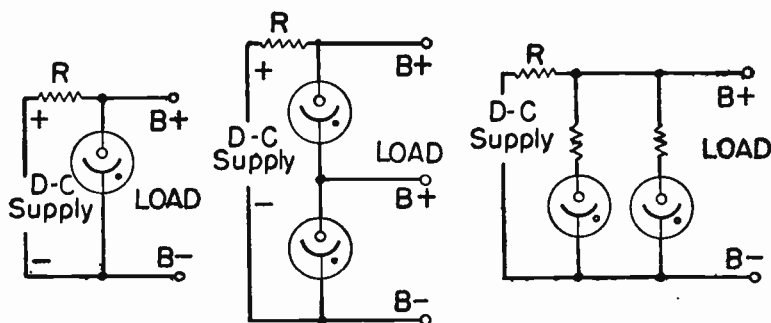

Fig. 9.—Voltage regulator connections; singly, in series, and in parallel.

Fig. 9 shows connections for voltage regulator tubes used between the d-c supply system and a load consisting of plate, screen, and control grid circuits. At the left is a single regulator

tube. The tube always is in parallel with the load. The anode is connected to the positive sides of both the load and the d-c supply, with the cathode connected to the negative sides of supply and load. Protective resistor R always must be between the d-c supply and one side of the regulator tube.

At the center of Fig. 9 are shown two regulator tubes connected in series with each other for regulating two load voltages at the same time. The load voltage between B- and the intermediate B+ tap will be regulated by the lower tube, and will remain at the average regulation voltage for which this tube is designed. The load voltage between the intermediate B+ tap and the upper B+ *Max* tap will be regulated by the upper tube and will remain at the average voltage for which the upper tube is designed. As an example, were a 150-volt regulator used in the lower position and a 105-volt regulator in the upper position the positive regulated potential at the intermediate B+ tap would be 150 volts. There would be a difference of 105 volts between the intermediate and maximum B+ taps. Thus the positive potential at the maximum tap would be the sum of 150 and 105 volts, or would be regulated at 255 volts. Various combinations of tubes may be used to regulate a variety of tap voltages. The value of protective resistance at R is based on the total d-c supply voltage, the maximum B+ load voltage, and on the maximum permissible current for one regulator, for the one taking the least current if there is a difference between the two tubes.

At the right in Fig. 9 are shown two regulator tubes connected in parallel to regulate a greater load current than can be handled by any one tube. The two tubes must be of the same type, designed for the same regulated voltage and for the same maximum current. In addition to the protective resistor R there must be in series with each tube an additional resistor of 50 to 100 ohms which helps to make an equal division of currents in the two tubes. Without such dividing resistors one or the other of the regulator tubes will take nearly the whole current and its cathode will be damaged. The value of the protective resistor R is based on the maximum d-c supply voltage, the maximum permissible voltage for one regulator tube, and on the maximum permissible current for one regulator tube. Because of the

greater protective resistance and the two current dividing resistances the voltage regulation of the parallel tubes is not as good as that of a single tube.

Fig. 10 shows voltage regulator tubes used with resistance voltage dividers to provide extra voltage taps for the load. At the left a single regulator tube is in parallel with a voltage divider consisting of resistors R_a and R_b . The tube will regulate the voltage at the B+ Max tap in relation to B-. Load voltage at the intermediate B+ tap will vary with changes of current through this tap, and will not be directly controlled by the regulator tube. However, the fact that the voltage at the maximum B+ tap is held nearly constant helps to maintain a fairly con-

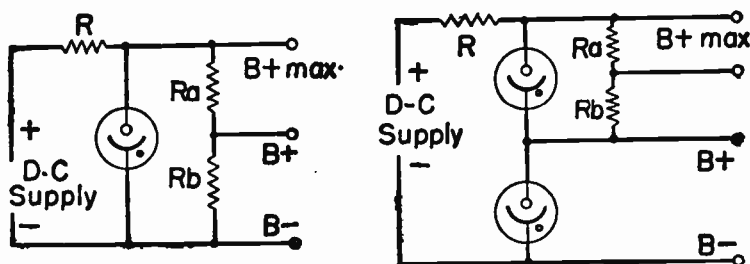

Fig. 10.—How voltage regulator tubes are used to control more than one load voltage.

stant voltage at the intermediate tap provided the current changes through this tap are not too great. The upper tap might be for a plate voltage and the intermediate tap for a screen voltage.

At the right in Fig. 10 are two regulator tubes in series with each other. Voltage between B- and the lowest B+ tap is regulated by the lower tube. Voltage between the lowest and highest B+ taps is regulated by the upper tube. Voltage at the intermediate tap on the voltage divider resistors varies just as with the arrangement in the left-hand diagram. A voltage divider might be used across the lower tube, or voltage dividers might be used across both tubes. Bleeder current in the voltage dividers forms part of the load current being regulated.

Fig. 11 shows how the jumper connections in the bases of voltage regulator tubes may be used. At the left there is a single regulator tube regulating a single load voltage with the usual connections between d-c supply, regulator tube, and load. One

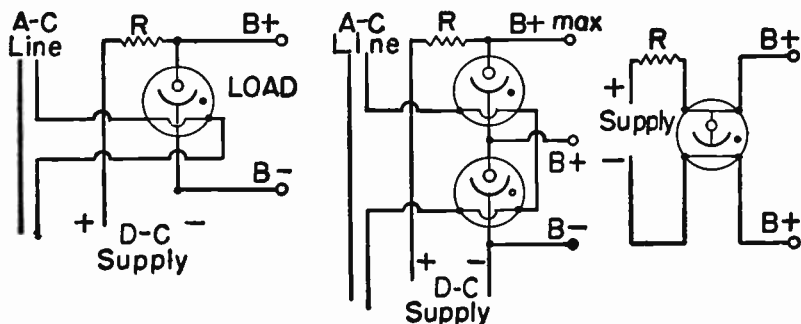

Fig. 11.—How the jumpers in voltage regulator tubes open power and load circuits.

side of the a-c line is opened and is run to the jumper pins of the tube. When the regulator tube is taken out of its socket the a-c line is opened to shut off the regulated apparatus. Otherwise, with the regulator tube out of action, the load might be subjected to excessive voltages and currents. The opening in the a-c line may be between the regular off-on switch and the primary of a power transformer. With ac-dc apparatus using no power transformer the jumper of the regulator tube may be in the a-c line running to the rectifier or to the series heaters and filaments of the tubes.

At the center in Fig. 11 are shown connections for the jumpers in two regulator tubes connected in series with each other. Connections for the d-c supply, the regulator anode and cathode, and the load, are the same as at the center of Fig. 9. The a-c line now is run through the jumpers of both regulator tubes, with the jumpers connected in series with each other. Removing either of the regulator tubes now will open the a-c line and shut off the regulated apparatus.

At the right in Fig. 11 are shown connections which may be

used with a regulator tube having two jumpers. Base connections for such a tube are shown at the center of Fig. 8. One jumper, which also connects to the tube anode, is used to open the positive side of the load circuit. The other jumper, connected to the cathode of the tube, is used to open the negative side of the load circuit. Sometimes only one of the jumper connections is used, and only the positive side of the load circuit is opened by removal of the tube. With two tubes connected in series, to regulate two load voltages, the jumpers of both tubes would be connected in series to open the load circuit when either regulator tube is removed from its socket. Opening the d-c supply circuit for the load is just as effective as opening the a-c line in preventing application of excessive voltages and currents to the load.

Gas-filled Rectifiers.—Rectifier tubes of the gas-filled type are not in common use for radio receiving or testing apparatus. Such tubes are used in large numbers for industrial applications requiring large direct currents at moderate voltages. They are in general use also for the charging of storage batteries. Gas-filled rectifiers are called *phanotrons*. Low voltage types for battery charging and similar purposes have trade names such as Tungar or Rectigon. Many industrial types of rectifiers which have mercury vapor in their envelopes, as well as those having only gases, are called phanotrons.

Mercury-vapor Rectifiers.—In rectifier tubes having mercury vapor within the envelopes the drop through the tube is only about 15 volts, and this drop remains unchanged with variations of rectified current. Because of this small and constant voltage drop, corresponding to a small internal resistance, the voltage regulation of such a d-c power supply system is better than when using vacuum rectifiers with their relatively high internal drop. The actual voltage drop in these tubes varies somewhat between different tubes of the same type and make, increases as the tubes age, and varies with changes of temperature at which the tubes operate.

Mercury-vapor rectifiers for use in radio receivers, amplifiers, and testing equipment are made in types which match some of the vacuum rectifiers in filament voltage and current, and in maximum d-c output currents as well as in a-c voltages applied to the rectifier plates from the power transformer secondary.

The mercury-vapor rectifiers are clearly recognizable and distinguished from vacuum rectifiers by the blue-green glow which appears inside the mercury-vapor envelopes while the tubes are operating. This glow, like that in other gas and vapor filled tubes is due to energy changed into light during the re-combination of positive ions with electrons.

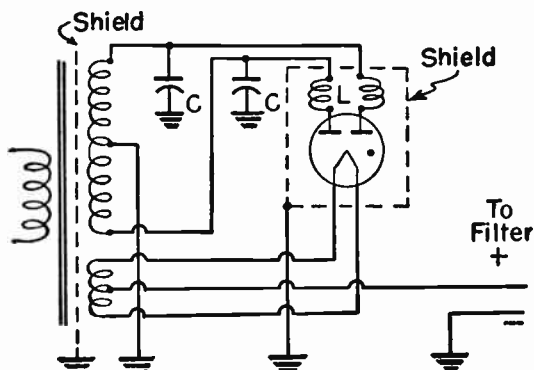

Fig. 12.—Methods of reducing r-f interference from a mercury-vapor rectifier.

The chief objection to the use of mercury-vapor rectifiers is that they generate r-f interference causing harsh, high-pitched sounds when detected and amplified. This interference may be reduced or eliminated by methods illustrated in Fig. 12. The power transformer has an electrostatic shield between primary and secondary windings. This shield is grounded. R-f filter chokes L are in series with each of the rectifier plate leads, close to the tube. These chokes are enclosed within a shield which surrounds the rectifier tube, including its base. The tube shield is grounded. Bypass capacitors at $C-C$ are connected between ground and each of the plate leads from the power transformer, between the transformer and the chokes. These capacitors are mica-dielectric types. Their d-c working voltage must be well above 1.4 times the r-m-s a-c voltage per plate from the power transformer. All leads between the power transformer and the rectifier tube should be as short as they can be made. Not all of

the remedies shown by Fig. 12 may be needed; one or more of them may be sufficient in any given case.

Unless a mercury-vapor rectifier is operated at a sufficiently high temperature the mercury will remain condensed and there will be practically no vapor formed. Minimum operating temperatures usually are between 68° and 75° F. Maximum operating temperatures for these tubes are 140° F. Mercury-vapor rectifiers must be mounted with their bases downward and envelopes upward, in a vertical position, so that the mercury vapor condensing to liquid mercury may run downward into the bottom of the envelope, which is the coolest part of the tube.

Cold Cathode Rectifiers.—A cold cathode rectifier is a gas-filled tube having one plate for half-wave or two for full-wave rectification, and having an electron emitting cathode which requires no heating from an external supply. The cathode is coated with materials or is made of materials which readily emit electrons, and is of larger area than the uncoated anode. When the anode is made positive and the cathode negative there is a glow discharge due to ionization. Part of the cathode surface soon is heated to incandescence, whereupon there is a high rate of emission and a high rate of electron flow from cathode to anode.

The starting or breakdown voltage is high in cold cathode rectifiers, being about 300 volts in types used in radio apparatus. The tubes are small, and have high d-c current capacities for their size. There is r-f interference of somewhat the same kind as experienced with mercury-vapor rectifiers, making it necessary to use bypass capacitors and sometimes r-f chokes as shown by Fig. 12. Cold cathode rectifiers formerly were used in a great many d-c power supply systems for radio receivers and amplifiers, but now are used chiefly where there is a distinct advantage in avoiding the power consumption and extra wiring for heating the cathode from an external source.

Gas Triodes.—A triode tube in whose envelope there is some gas rather than an almost perfect vacuum is called a gas triode. The gas triode is one type of a general class of tubes called *thyratrons*. The gas triode has three active elements; an electron emitting cathode, a control grid, and an anode. The anode is the element which we are used to calling a plate in other tubes. There are other thyratrons with four active elements; a cathode,

a control grid, a screen grid or shield grid, and an anode. These are called gas tetrodes. First we shall consider gas triodes of the smaller types which are comparable in size, cost, and load handling ability with radio amplifiers and rectifiers. In some of these tubes the cathode is an indirectly heated separate element; the construction is of the heater-cathode type. Others are of the cold cathode type, with which the cathode requires no external power source for heating.

What happens in a grid-controlled gas-filled tube is shown by Fig. 13. In the left-hand diagram the control grid is highly negative with reference to the cathode and the anode is highly positive. There is a space charge of negative electrons near the cathode surface, but these electrons are held on the cathode by the highly negative charge of the grid. In the space between cathode and anode there are neutral atoms of the gas.

In the center diagram the grid has been made less negative. Now some negative electrons are drawn away from the cathode and toward the anode. These electrons collide with the gas atoms, knock other electrons out of the atoms, and ionization commences. This leaves great quantities of positive ions inside the envelope,

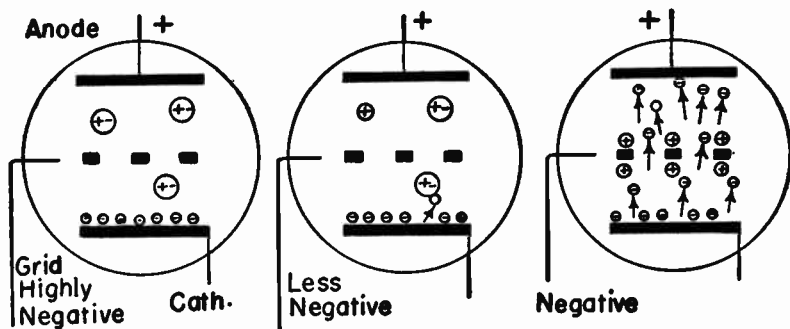

Fig. 13.—How the grid loses control after ionization commences.

as at the right. The grid still is negative with reference to the cathode and, of course, is negative with reference to the charges of the positive ions. Consequently, the ions collect in great density all around the grid. The negative charge of the grid is neutralized by the positive sheath around the grid.

Now the grid has lost all control over the rate of electron flow from cathode to anode. The tube acts in practically the same manner as though there were no grid, and electrons flow from cathode to anode at a high rate for the reasons explained in connection with Fig. 2. The voltage drop through the tube becomes of low value, falling possibly to something like 25 volts. The rate of electron flow is limited almost entirely by whatever resistance is in the external circuit, and it depends on this resistance and on the potential difference applied to the tube circuit.

Once ionization commences in the thyatron tube the electron flow cannot be stopped by any reasonable change of voltage on the grid. If the grid is again made highly negative it merely attracts more positive ions and the negative charge remains neutralized. The only way to stop the electron flow is to reduce the anode voltage below the value at which ionization is maintained. In practice the anode voltage must drop to zero to stop the electron flow.

A control characteristic for a typical small gas triode is shown by Fig. 14. The curve shows the grid voltages at which there will be breakdown (and ionization) with various values of anode voltage. For an example, assume that the anode is 100 volts positive with reference to the cathode. From 100 volts on the left-hand vertical scale for anode volts we follow across to the curve, then downward to the grid voltage scale across the bottom of the graph. There we see that in the average tube of the type here represented there will be breakdown when the grid voltage is reduced from some value more negative to a value of 10 volts negative.

With any combination of anode and grid voltages found below and to the left of the curve the tube will not break down and will not conduct current. With any combination of voltages found above and to the right of the curve there will be breakdown and conduction. For instance, assume 150 volts on the anode and 15 volts negative on the grid. The intersection of lines for these two voltages is to the left of the curve, therefore the tube will not break down. Again consider 100 volts on the anode and 5 volts negative on the grid. This combination of voltages is to the right of the curve. therefore the tube will break down and conduct.

Although the performance of one tube might conform exactly to the curve of Fig. 14 another tube of the same type might have a performance curve somewhat higher or lower. To show the limits of performance of all tubes of a given type and make it is customary to use two curves, as in Fig. 15. The breakdown

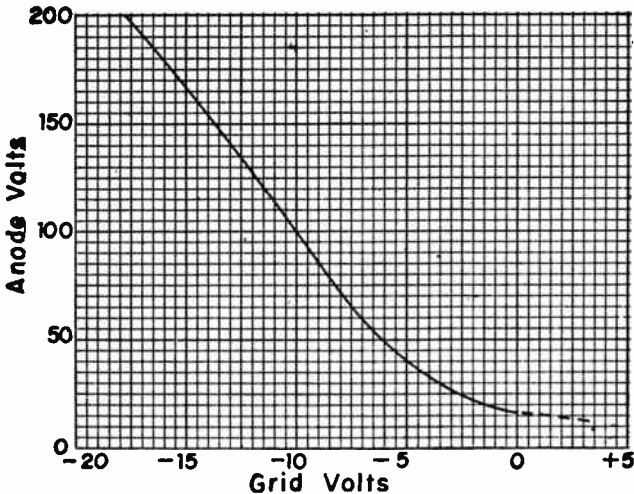

Fig. 14.—Control characteristic for a small gas triode.

voltages for all such tubes will lie somewhere in the area between the curves. Then, for all combinations of plate and grid voltages found to the right of the right-hand curve *all* tubes of the given type and make surely will break down. For all voltage combinations found to the left of the left-hand curve *none* of the tubes will break down and conduct. But for voltage combinations found somewhere between the curves any given tube either may or may not break down; it will depend on the tube. However, for any one tube it would be possible to draw a single curve, as in Fig. 14, and have that one curve correspond to the performance of that one tube.

In designing apparatus to use the tube type represented by Fig. 15 we would not choose circuit voltages lying in the area

between the curves. That is, we would not design for conduction to commence with a plate voltage of 100 when the grid voltage was changed to exactly 10 volts negative, for this combination lies between the curves. Although the apparatus might work when originally adjusted, it might fail when a new tube was

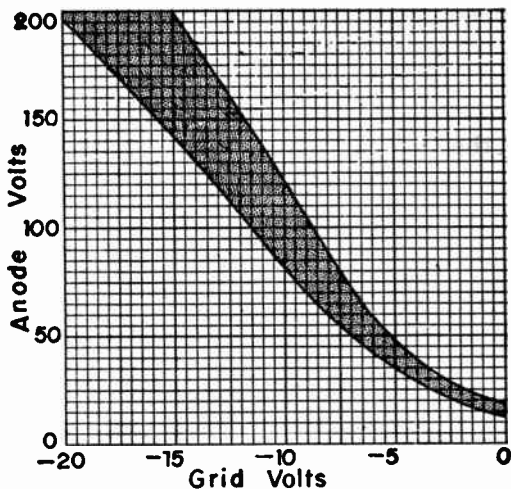

Fig. 15.—Operating limits for a typical gas triode.

used to replace the original one. The design voltages for conduction always should be to the left of the left-hand curve, and for no conduction they should be to the right of the right-hand curve.

Gas triodes may be used for many purposes. They may be used as grid controlled rectifiers. In such service the grid is made to control the value of the rectified direct current, and this value may be altered by adjustment of suitable control circuits. With ordinary two-element rectifiers the value of rectified direct current depends on the alternating potential applied to the rectifier plates and on the type of load circuit, such as the filter in a d-c power supply. But with a grid controlled rectifier the direct current may be varied even when the input alternating potential

and the load circuit remain unchanged. Also, the flow of rectified direct current may be started and stopped at will, merely by adjustment of the control apparatus.

The most generally satisfactory control methods for a thyatron rectifier employ a shifting of the phase of alternating grid potential with reference to alternating plate potential. Thus the tube is allowed to conduct during more or less of each positive half-cycle of potential applied to the plates of the rectifier. The phase relation is changed by means of an adjustable resistor or by means of an adjustable capacitor. Generally similar methods of grid control allow adjustment of the voltage applied to any load taking direct current from the thyatron rectifier, and so these tubes may be used as either automatic or manually operated voltage regulators.

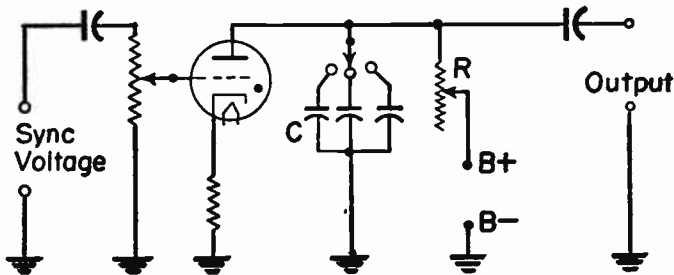

Fig. 16.—The circuit for a gas triode oscillator.

Special types of gas triodes are in common use as the sweep oscillators in cathode-ray oscillographs or oscilloscopes. The principal parts of such an oscillator circuit are shown by Fig. 16. One of the capacitors C is charged through adjustable resistor R from the d-c voltage supply system, the capacitor and resistor being in series between $B+$ and $B-$. The capacitor is connected also to the anode of the gas tetrode. When the capacitor becomes charged to the voltage at which the tube breaks down, ionization commences and the capacitor discharges through the tube in a small fraction of a second. The rate at which the capacitor charges, and the time for the charge voltage to reach

the breakdown value for the tube, depend on the capacitance at C and the resistance at R . This time is related to the time constant of the capacitance-resistance combination.

The time between one discharge and the following discharge is the time required for charging the capacitor to the breakdown voltage. The number of charges and discharges per second is the frequency of oscillation, in cycles per second. Each oscillation consists of the relatively slow increase of capacitor voltage during charge, and of the rapid discharge through the tube. This slowly rising and rapidly falling voltage appears also at the output. The output is of sawtooth waveform.

The synchronizing voltage applied to the gas triode grid through connections on the left of the tube maintains the oscillation frequency in step with the frequency of this voltage. The frequency determined by C and R is just a little lower than that of the synchronizing voltage. Then each positive half-cycle of the synchronizing voltage makes the grid enough less negative to cause breakdown at the synchronizing frequency. The oscillation frequency is varied by connecting smaller or larger capacitances at C and by adjusting the resistance at R to vary the time constant.

Gas triodes may be used for operating magnetic relays, with the relay doing the switching for some load operated from an a-c or d-c power line. Fig. 17 shows how a cold cathode type of gas triode is used for relay control of a load located at a distance from the point of control on an a-c power line. The tube anode is connected through the relay winding to the upper side of the line, and the cathode is connected to the lower side of the line through coil L . During half-cycles in which the upper side of the line is positive and the lower side negative the tube anode will be positive with reference to the cathode, and the tube may be made to conduct by a change of grid voltage. During opposite half-cycles the anode is negative with reference to the cathode, and there can be no conduction. Therefore, there is pulsating direct current through the tube. Capacitor C_b discharges through the relay winding during half-cycles in which the tube does not conduct, thus holding the relay closed during these periods.

The relay will be closed when a high-frequency signal voltage is transmitted over the power line and reaches the grid control

circuit consisting of resistors R - R , capacitor C , and coil L . The grid of the tube is connected to a point between resistors R - R , which form a voltage divider across the power line. During half-cycles in which the anode is positive the grid is maintained at a potential just a little lower than needed for breakdown.

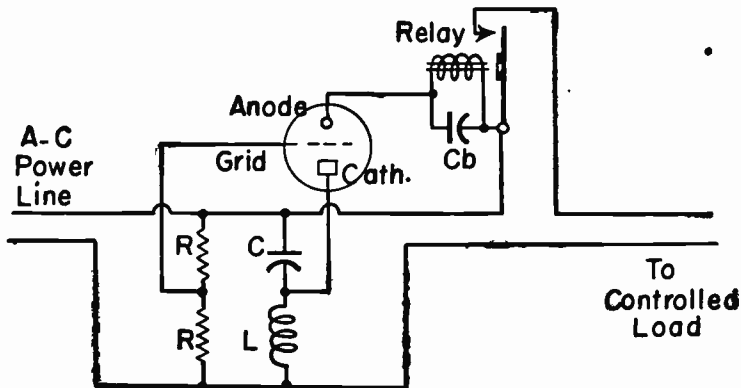

Fig. 17.—Remote control by means of r-f signals carried on a power line.

The cathode of the control tube is connected to a high-Q high-frequency resonant circuit consisting of capacitor C and inductor L connected across the a-c line. This resonant circuit is tuned to some high frequency, usually in the lower r-f ranges, which may be transmitted over the a-c power line without interference from the lower power frequency. When such a signal is transmitted over the line from some distant control point there are produced high voltages at the resonant frequency in the tuned circuit C - L . Thus the average potential of the tube cathode is made more negative by the signal. Making the cathode more negative brings its potential nearer to the grid potential, and in effect makes the grid less negative with reference to the cathode. Then the tube breaks down and there is a large electron flow in the anode circuit to close the relay contacts. Closing of the relay contacts completes the a-c power line circuit to the controlled load.

With all thyatrons, whether triodes or tetrodes, the heater voltage and current always should be applied before applying an

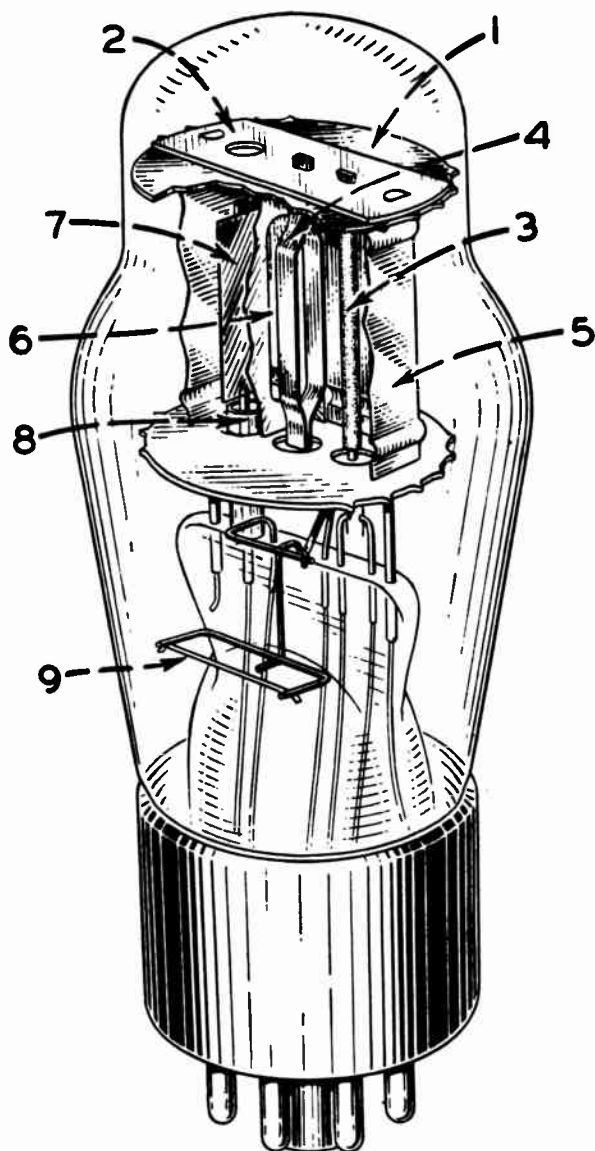

Fig. 18.—The construction of an RCA gas tetrode.

anode-cathode potential difference which can cause breakdown. It is desirable to have a delay of 10 seconds or more. Thus there will be emission and formation of a space charge before electrons in any quantity are drawn from the space charge by the positive anode potential. If this is not done the electrons are drawn to the anode as fast as emitted, and the cathode surface is left unprotected against bombardment by the relatively heavy positive ions. Such bombardment shortens the useful life of the cathode emitting surface. One advantage of cold cathode tubes is that they do not require a preheating time.

Nearly all gas-filled thyratrons are designed to operate at high temperatures, at temperatures high enough to give a severe burn if the tube is touched while in operation. The high temperature does not indicate overloading.

Gas Tetrodes.—In gas tetrodes there is placed between the control grid and the anode an additional element called the *shield grid*. This shield grid has the same position in relation to other elements as has the screen grid in vacuum tubes, but it serves other purposes than served by screen grids. One advantage gained by using a shield grid is a great reduction in the amount of control grid current. In gas triodes there may be grid currents which are large, possibly as much as 100 or even 1,000 microamperes. Such grid currents make it necessary to limit the resistance in the control grid circuit to values in which there will not be excessive voltage drops due to grid current. With low resistances in the control grid circuits it becomes necessary to have rather large currents from the source of any signal voltage which is to cause breakdown of the thyratron. Large currents from the signal source mean that this source must furnish considerable power in order to operate the thyratron. Such power demands limit the kinds of signal sources which may be used.

In the gas tetrode the control grid current is only a small fraction of this current in the gas triode. Consequently, it becomes possible to have resistances in the control grid circuit which are many times as high as those with gas triodes. Then only a small current and little power are needed from the signal source to provide ample change of voltage to actuate the control grid of the tetrode. The gas tetrode is much more sensitive than the gas triode.

Fig. 18 shows the internal construction of an RCA gas tetrode of the 2050 type. Mica shielding and insulation are shown at 1 and 2. The cathode is at 3, the control grid at 4, the shield grid at 5, and at 6 is the opening through the shield grid which permits electron flow. At 7 is the anode. The glass sleeve, and the getter

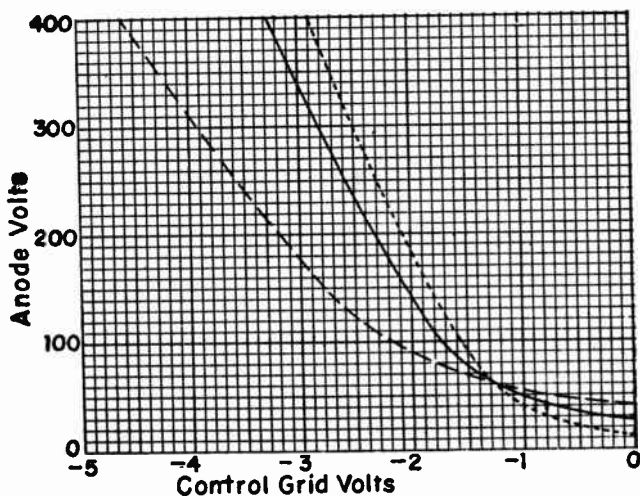

Fig. 19.—The control characteristic of a gas tetrode is changed by varying the resistance in the control grid circuit.

for removing gas during the first evacuation, are shown at 8 and 9. The shield grid of the gas tetrode, like the screen grid in vacuum amplifiers, lessens the capacitance between cathode and anode or plate. Then the tube is not so likely to break down from sudden changes of supply voltage, such as might result from power line surges.

Curves showing control characteristics of gas tetrodes are of the same general shape as those for gas triodes. Fig. 19 shows how the breakdown voltages or the combinations of anode and control grid voltages are affected by change of resistance in the control grid circuit. These curves apply when the shield grid is connected to the cathode at the tube socket, making the shield

grid potential zero. The full-line curve shows breakdown voltages with 100,000 ohms resistance in the control grid circuit, the dotted-line curve shows performance with no resistance in the control grid circuit, and the curve made with long dashes shows performance with ten megohms of grid circuit resistance.

With combinations of anode voltage and control grid voltage for breakdown such as would be used in most applications, the

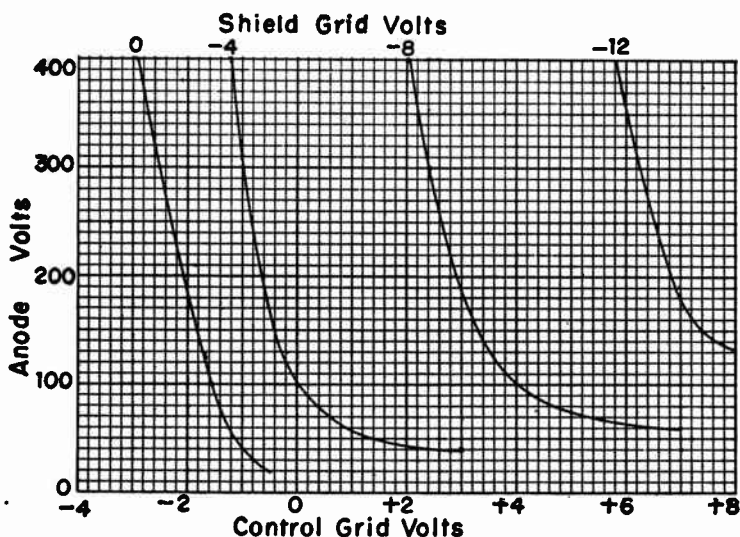

Fig. 28.—Varying the voltage of the shield grid changes the control characteristics of a gas tetrode.

greater the resistance in the control grid circuit the more negative will be the control grid voltage for breakdown with any given anode voltage. It is, of course, true also that the greater the resistance in the control grid circuit the lower will be the anode voltage for breakdown with any given voltage on the control grid.

In most of the applications of gas tetrodes the shield grid is connected directly to the cathode and thus is held at the same

potential as the cathode. However, by changing the potential of the shield grid in relation to the cathode it is possible to change the control characteristic or to shift the whole curve which represents this characteristic.

Fig. 20 shows how the control characteristic is shifted by making the shield grid more and more negative with respect to the cathode. The left-hand curve, for the shield grid at zero volts, is the same as the dotted-line curve of Fig. 19 although the grid voltage scale is more condensed. As the shield grid is made more negative the control grid must be made less negative, or more positive, to cause breakdown with any given anode voltage. As might be expected, the control grid and shield grid have balancing effects on breakdown; as one of these voltages is made more negative the other must be made less negative or more positive to maintain the same anode voltage for breakdown.

Fig. 21 shows a gas tetrode actuated by a phototube, with the gas tube operating the relay at the right. The voltage and current source for both tubes is the a-c line. During half of each a-c cycle the anodes of both tubes become positive, and both may conduct. During opposite half-cycles both anodes are negative, and neither tube conducts.

During each half-cycle in which the right-hand side of the a-c line is positive the anode of the gas triode is positive because of its connection through the relay coil to the a-c line. The cathode of this tube is negative with reference to its anode because of voltage drop through resistor R_b . The grid is still more negative than the cathode because of voltage drop in the portion of resistor R_a which is between the cathode and the slider connection from grid resistor R_g . At the same time the anode of the phototube is positive because it is connected directly to the end of the a-c line which momentarily is positive. The phototube cathode is negative with reference to the anode in this tube because the anode is connected through R_g near the end of the a-c line which momentarily is negative.

When light strikes the phototube cathode there is electron emission from this cathode and the electrons go to the anode. These electrons reach the cathode by flowing upward through R_g . With this direction of electron flow the upper end of R_g becomes positive with reference to its lower end. Then the grid of

the gas triode is made more positive, or less negative, because of the potential difference across R_g . The gas triode breaks down and there is a large electron flow from the end of the a-c line which is negative through resistor R_a , then from cathode to anode in the gas triode, through resistor R_c , the relay winding,

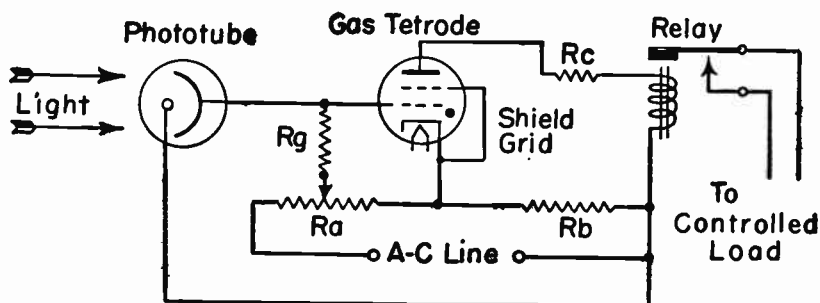

Fig. 21.—A phototube controlled gas tetrode which operates a magnetic relay.

and to the positive end of the line. The purpose of R_c is to limit the rate of electron flow in the gas triode after breakdown.

Electron flow through the relay winding magnetizes the core, pulls down the relay armature, and closes the main relay contacts which are in the circuit of the controlled load. During the a-c half-cycles in which line polarity is reversed there is no electron flow in the tube circuits or in the relay winding. Adjustment of the slider on R_a varies the sensitivity of the control apparatus by varying the bias on the grid of the gas triode. The less negative this bias is made the less light is needed on the phototube to furnish the positive impulse for breakdown in the gas triode.

Ballast Tubes or Resistors.—A ballast tube or ballast resistor is a unit, usually mounted in a tube envelope and on a tube base, which is used to maintain a nearly constant current when there are variations of voltage. Radio ballasts often are connected in series with the series heaters of ac-dc receivers or with any other series heaters to maintain a nearly constant heater current

when there are wide variations of line voltage. Ballasts are used also in series with the primary windings of power transformers to maintain a nearly constant primary current and secondary output voltage when there are variations of line voltage in the primary circuit.

Ballasts depend for their operation on a peculiar property of iron and some iron alloys. When current flows in a wire or filament of the metal there is the usual heating and a consequent rise of temperature. The resistance rises just as in many other

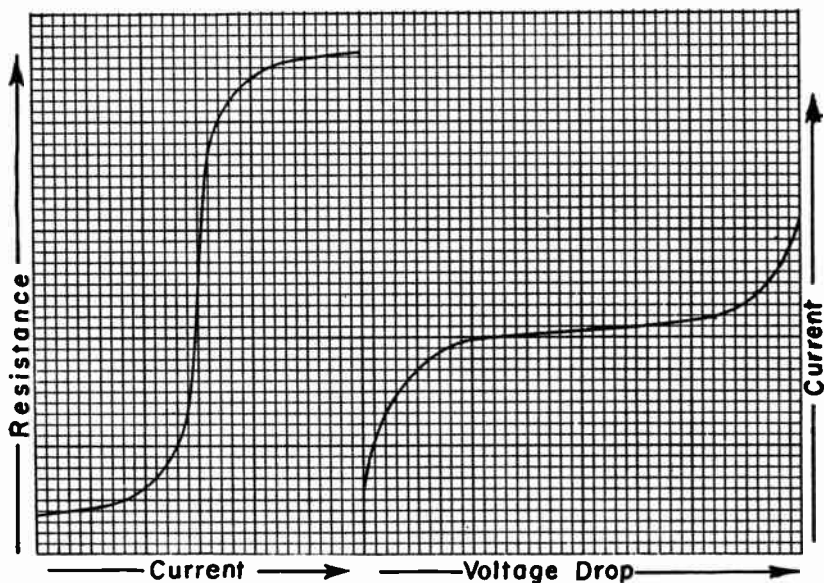

Fig. 22.—Resistance, current, and voltage drop for a ballast operating near the critical temperature.

metals whose temperature is increased. But when iron reaches a critical temperature approaching dull red heat its resistance increases very rapidly. The temperature results from flow of current, and we may say that the resistance increases rapidly at some certain current. This will be the amount of current

which produces the critical temperature in the size and type of iron conductor being used. The effect is shown at the left in Fig. 22. At the critical temperature there is a great rise of resistance with flow of only a very little additional current.

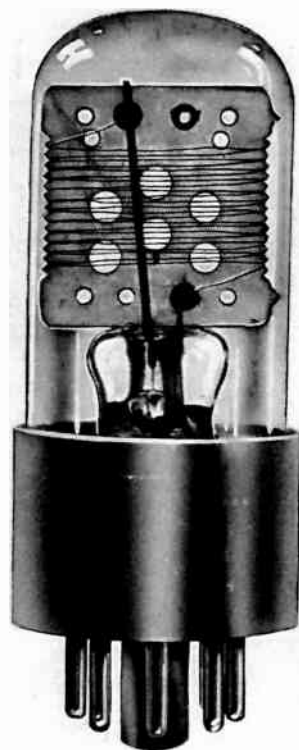

Fig. 23.—A ballast tube mounted on an octal base.

The voltage drop across the ballast depends on current and resistance, and is proportional to their product. Thus it comes about that to get only a little more current through the rapidly increasing resistance of the ballast at the critical temperature there must be an increase of voltage proportional to the increase of resistance. This relation between voltage and current is shown

at the right in Fig. 22. Here we have a condition in which large changes of voltage cause hardly any changes of current, and have a unit which will maintain a nearly constant current when there are large changes of applied voltage.

As may be seen from the curves there is only a certain range of voltages within which current is regulated, and the current is regulated at some one value or near one value. By using suitable diameters and lengths of the iron wire ballasts may be designed to operate at any desired value of regulated current and within certain ranges of applied voltage.

The ballast wire is enclosed within an envelope which has been highly evacuated and into which then has been admitted a quantity of hydrogen gas. Thus a ballast tube might be called a gas-filled tube. But the purpose of the hydrogen is not to allow ionization, rather it is to conduct heat away from the ballast iron and to the envelope from which the heat is dissipated. This allows the temperature of the iron to be controlled by current and resistance, and to change rapidly with rapid changes of these two factors.

In addition to the uses already mentioned, ballasts are connected in series with tube filaments which are heated from either dry-cell batteries or storage batteries. Then the current through the tube filaments, and the corresponding voltage drops across the filaments, are maintained fairly constant with change of battery voltage. One type of ballast tube is shown by Fig. 23. The ballast wire is supported on a mica insulator within the tube, and is connected to base pins.

Ballasts operate at rather high temperature, which is necessary to obtain the current regulating effect. The range of voltages compensated for is affected to some extent by surrounding temperatures, since these affect the temperature of the ballast wire. These units perform their function of current regulation by change of temperature of the iron, and since this change requires some time there is no protection against sudden and brief surges of line voltage. If ballasts are operated at voltage drops either less or more than those for which they are rated there will be little or no regulation of current. This is evident from the curves of Fig. 22. At higher voltages the useful life of the ballast will be shortened.

Some so-called ballast resistors have only some type of ordinary high-resistance wire instead of iron or an iron alloy. Such resistors have no current regulating ability, but merely serve to reduce a voltage by using part of an applied voltage in their own drop.

REVIEW QUESTIONS

1. Ionization increases electron flow in two ways. One is by knocking electrons out of neutral atoms. What is the other way?
2. Which requires higher voltage, breakdown of a gaseous tube, or maintenance of electron flow after breakdown has occurred?
3. Does current through a voltage regulator tube increase when there is increase of load current or when there is decrease of load current?
4. What protective resistance (R of Fig. 9) is required with a 150-volt regulator tube, maximum supply voltage of 220, and maximum current of 30 milliamperes?
5. In grid controlled gas-filled tubes will the grid control the rate of electron flow, start the flow, or stop the flow, when grid voltage is changed?
6. Which requires greater power in its control grid circuit for regulating breakdown, a gas triode or a gas tetrode?
7. When the control grid of a gas tetrode is made more negative, will the original breakdown voltage be maintained by making the shield grid more negative or more positive?
8. What is the name of the tube whose filament resistance changes rapidly at a certain temperature? Is it used to regulate voltage or current?

Chapter 9

CONTACT RECTIFIERS AND DETECTORS

In addition to the vacuum types and gas-filled tube types of rectifiers and detectors used in radio there are several varieties of contact rectifiers. A contact rectifier consists of metals or compounds of metal which, when in close contact, offer high resistance to electron flow in one direction and comparatively low resistance to flow in the opposite direction. This, of course, is the chief property of all rectifiers.

There are three principal types of these devices which may be classed as low-frequency rectifiers, in that they are used chiefly for producing direct currents from the low-frequency alternating potentials found in power and lighting lines. There are several other types which may be classed as high-frequency rectifiers, since they are used chiefly for rectifying high-frequency potentials and for demodulating high-frequency modulated potentials to produce audio-frequency or other signals of relatively low frequencies.

Low-frequency Rectifiers.—The class of low-frequency contact rectifiers which has been used for the longest time in radio is the copper-oxide type. The active elements are metallic copper and copper oxide which is formed on the copper. Another class is the copper-sulphide type, in which the elements are copper sulphide and the metal magnesium. A third class consists of the selenium rectifiers, in which one-way electron flow is through a thin layer of the metal selenium held between another metal such as iron or aluminum and some metallic alloy.

All of the low-frequency contact rectifiers have certain features in common. All of them will have long, trouble-free life when operated within their voltage and current ratings, and within established temperature limits. None require any external source of heating power, such as needed for most of the vacuum and gas rectifiers. All the contact rectifiers commence to operate as soon as alternating potential is applied. All will withstand large over-currents for brief intervals if such currents are not

continued to cause overheating. Contact rectifiers may be connected in series with each other to raise the permissible voltage, or in parallel for more current than can be handled by one unit.

One group of low-frequency rectifiers is designed for low voltages and large currents. In this group are both copper-oxide and copper-sulphide units. They are used for purposes such as charging storage batteries from a-c lines, also in d-c supplies or A-

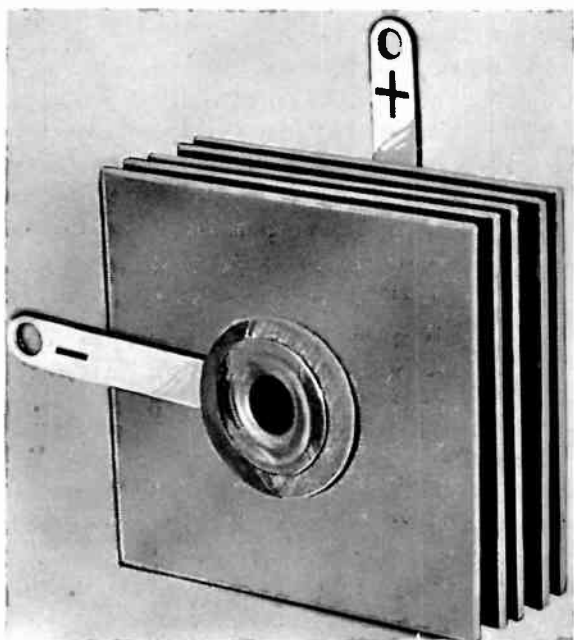

Fig. 1.—A selenium contact rectifier having d-c capacity of 100 milliamperes.

supplies for filaments or heaters of radio tubes. The line voltage is stepped down by a transformer to a value suitable for overcoming the load or battery voltage and the drop in the rectifier. Direct currents usually are between two and 30 amperes. Selenium rectifiers of large current capacity also are used for similar purposes.

Another group is designed for low voltage and low current service as instrument rectifiers such as used in a-c current meters and voltmeters having moving-coil permanent-magnet movements. Both copper-oxide and selenium rectifiers are found in this group. Maximum a-c voltages usually are either five volts or ten volts. Where the maximum average current will be one milliamperere or less the maximum current rating usually is five or ten milliamperes, and for more than one milliamperere the average rating usually is 30 milliamperes.

A third group of low-frequency contact rectifiers is designed for the same service given by vacuum tube rectifiers. All in this group are selenium units, which are able to withstand inverse potentials (cathode positive and anode negative) many times as high as the other types without permitting excessive back current. These units operate on a-c potentials up to 130 volts and deliver direct currents up to 200 milliamperes with the types most often employed in radio.

Instrument rectifiers are made as small as possible, which is satisfactory construction because of the small voltages and currents, and the little heat developed. With the other types mentioned the rectifier elements themselves usually are rather small discs mounted at the centers of and alternating with heat-radiating flanges of metal. These extended flanges are in contact with the rectifying elements, consequently are "alive" and must not be allowed to come on contact with other conductors of any kind, such as chassis metal. Some of these rectifiers have a central opening through which may be passed a screw for mounting. The metal insert around the mounting opening is well insulated from all other parts of the rectifier unit, and so the mounting screw needs no further insulation. Other types have mounting brackets, with the bracket metal insulated from the remainder of the unit.

When mounted on a receiver chassis these rectifiers should preferably be near the r-f end, as is true with any rectifier. They should be placed to allow reasonable ventilation for carrying away heat, and should not be close to high-temperature parts such as filter and other power dissipating resistors. Excessively high temperature lowers the rectifier resistance to "forward" current, which is the desired rectified current, but also allows

a greater back current or inverse-voltage current and much additional heat is produced in the rectifier itself.

The connection polarity of contact rectifiers is marked on one or more terminals. When a terminal is marked positive or has a plus (+) sign that terminal is the cathode of the rectifier. The cathode terminal sometimes is marked with red. The negative terminal of the rectifier is the anode, it is the negative terminal for the output or for the d-c current to the load.

The direction of electron flow in copper-oxide rectifiers is from the copper to the oxide. In copper-sulphide types electron flow is from magnesium to the sulphide. In selenium rectifiers the electron flow is from the alloy coating through the selenium to the iron or aluminum base plate. The directions are shown by Fig. 2.

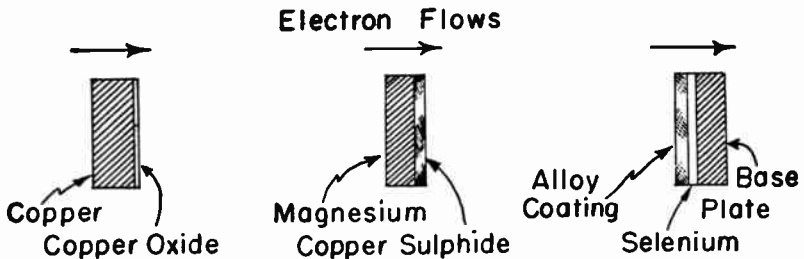

Fig. 2.—Directions of electron flow in contact rectifiers.

The polarity of any contact rectifier may be checked with an ohmmeter whose own polarity is known or marked. When the ohmmeter is connected to the rectifier in the direction that shows less resistance, then the negative side of the ohmmeter (or the ohmmeter battery) is connected to the cathode of the rectifier, which is the positive terminal of the rectifier. A d-c voltmeter in series with a battery and the rectifier may be used similarly. With the direction of connection which shows higher meter reading the negative side of the battery is connected to the rectifier cathode. With instrument rectifiers the ohmmeter current or battery current must not be great enough to overload the rectifier.

Selenium Rectifiers.—Selenium rectifiers of the type whose performance is equivalent to that of vacuum tube rectifiers are made in direct-current capacities ranging from 65 to 450 milliamperes per unit. These ratings are for average or continuous output current. Peak momentary current ratings are from 900 to 2,000 milliamperes per unit. The maximum r-m-s a-c working potential is 130 volts, and the maximum peak inverse potential is 380 volts. The drop through a rectifier unit is approximately five volts. These characteristics apply to selenium rectifiers in common use for radio and television.

The selenium rectifiers just mentioned are used instead of vacuum tube rectifiers in ac-dc receivers, in phonograph and microphone amplifiers, for excitation of speaker field windings, for d-c power supplies of all kinds, for the rectifiers of non-synchronous vibrators, for phototube relays and for any d-c relays operated from a-c lines, for battery charging in ac-dc-battery

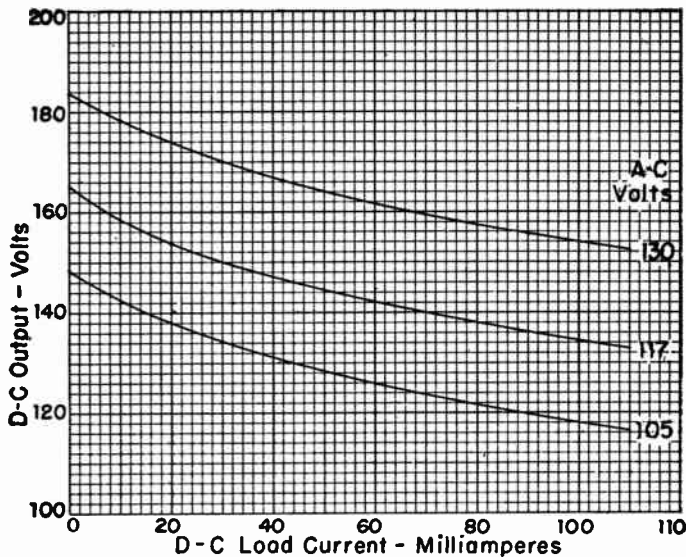

Fig. 3.—Voltage regulation curves for a selenium rectifier.

receivers, and for practically any application requiring moderate direct currents at moderate voltages.

Fig. 3 shows voltage regulation curves for a Sylvania Type NC5 selenium rectifier having a maximum allowable d-c output of 100 milliamperes and having other characteristics as mentioned in an earlier paragraph. The curves are taken with a resistor of 20 ohms between the a-c supply and the rectifier, and with a 40 mfd filter capacitor across the output or across the load. The upper curve is for an a-c supply of 130 volts (maximum permissible), the middle curve is for 117 a-c volts, and the lower one for 105 a-c volts. There is less change of load current with change of load voltage than when using one of the small half-wave vacuum tube rectifiers which the selenium unit is designed to replace. This assumes that both rectifiers are used at the same voltages and in the same circuits.

At the top of Fig. 4 is shown a d-c power supply and series heater circuit such as used in many ac-dc receivers. The rectifier tube is a half-wave vacuum type with a tapped heater. The pilot lamp is across part of this heater, with the heaters of other tubes in series between that of the rectifier and ground. The d-c filter capacitors and resistor are in the lead from the rectifier cathode. The rectifier plate (or anode) connects through the pilot lamp and part of the heater to one side of the power line.

Down below is shown a d-c power supply circuit for the same type of receiver as above, but using a selenium contact rectifier instead of the vacuum tube type. All of the differences or changes are included between the points marked with X's on the conductors. The pilot lamp is changed from the usual 6.3 or 7.5 volt type to one with a filament designed for line voltage, and is connected across the line. The contact rectifier, with resistor R_a in series, is connected between the ungrounded side of the line and the filter. The purpose of resistor R_a is to limit the peak current through the rectifier. The resistance here usually is between 20 and 30 ohms.

Because there no longer is a rectifier heater in series with heaters for other tubes it is necessary to insert resistor R_b in its place. The resistance required at R_b depends on the resistance of the original rectifier, or on the heater voltage and current of that rectifier. The required resistance is found from dividing

the heater voltage by the heater current. For example, with a 35-volt heater taking 0.15 ampere, dividing 35 by 0.15 gives 233 ohms. A 230-ohm unit would be satisfactory. The wattage rating of the resistor is found from multiplying the voltage drop (35 in the example) by the current (0.15 ampere in the example), and taking about twice the product. For the values being used here

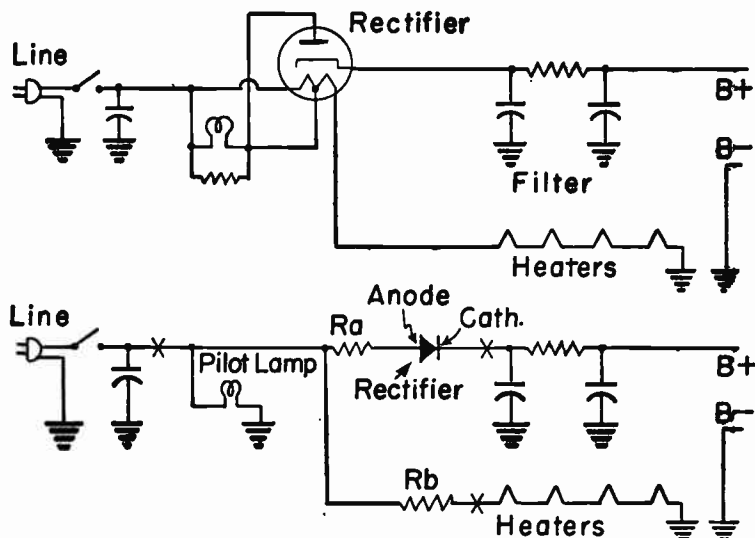

Fig. 4.—B-c power supply with vacuum tube rectifier (top) and with selenium rectifier (bottom).

the product of 35 and 0.15 is 5.25, so a 10-watt resistor would not overheat. In a design using the selenium rectifier as original equipment rather than as a replacement the sum of heater voltages of the tubes could be selected to match the line voltage, and resistor R_b would not be needed. A low-voltage pilot lamp sometimes is connected across part or all of the resistance at R_a , or, in some receivers, no pilot lamp is used.

Selenium rectifiers may be used in voltage doubler circuits, as shown by Fig. 5. Resistors $R-R$ are for limiting peak currents in the two rectifiers. The circuit is basically the same as when using

a vacuum tube voltage doubler rectifier with separate cathodes and plates. The circuit shown is a half-wave type.

Contact rectifiers sometimes are called "dry rectifiers." This name comes from the fact that in the early days of battery elim-

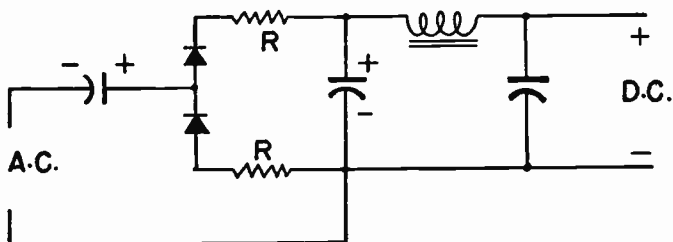

Fig. 5.—Voltage doubler rectifier circuit with two selenium rectifiers.

inators the contact rectifiers were compared with electrolytic types which used various liquid solutions as electrolytes.

Crystal Detectors.—The earliest radio receivers contained no tubes. In those receivers the incoming modulated high-frequency signal was demodulated by means of a crystal detector. A crystal detector is a rectifier, just as the diode tube detectors of today are rectifiers. With either of these detectors the high-frequency signal potentials of one polarity cause electron flows much greater than are caused by potentials of the opposite polarity. The detector has low resistance to electron flow in one direction, and high resistance to flow in the opposite direction. The one-way pulses of current, which occur at the signal frequency, add together to form an average electron flow which increases and decreases at an audio-frequency rate. The audio frequency is the modulation of the applied high-frequency signal.

Two crystal detectors are shown by Fig. 6. These and all other generally similar detectors consist of compounds of some metal with sulphur or carbon. These compounds are the crystals. In contact with the crystal is placed a fine metallic wire or a small metallic rod which is called the "cat-whisker." There is low resistance to electron flow from cat-whisker to crystal and high resistance to flow in the opposite direction. The high resistance

usually will be 10 to 20 times the low resistance. Then equal amplitudes in the high-frequency signal will cause electron flows in one direction which are 10 to 20 times as great as the flows in the opposite direction.

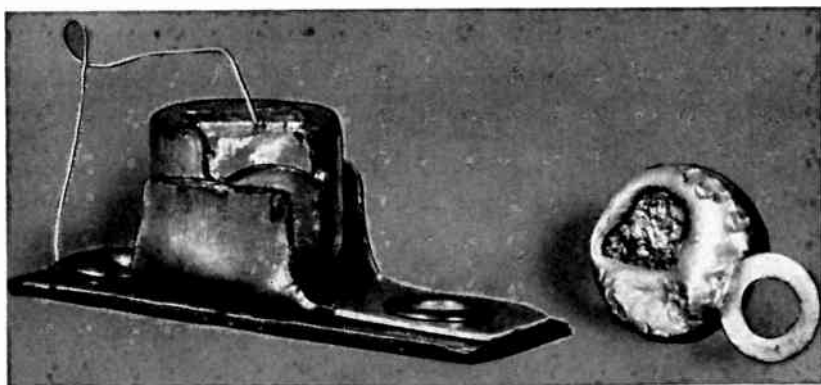

Fig. 6.—A galena crystal detector (left) and a silicon detector (right).

The sensitivity of a crystal detector is the ratio of direct electron flow in the output to alternating potential in the input. The most sensitive of the crystal detectors employs galena, which is a blue-gray cube-shaped crystal of lead sulphide having a metallic luster. The cat-whisker is a stiff wire of about number 30 gage making a rather light contact with the crystal. The cat-whisker has to be moved about over the crystal surface to locate a sensitive spot. Rather frequent readjustment is required. A spot loses sensitivity after a few months in the air, or if touched with the fingers, or if there is an extra strong signal such as may result from static.

Another popular type of crystal employs fused metallic silicon as formed in an electric furnace. The cat-whisker may be either a fine wire or else the rather blunt point of a small screw which exerts considerable pressure on the crystal. The silicon detectors are less sensitive than those of galena, but it is easier to find one of the many sensitive spots on silicon, and there is less change of sensitivity with time and exposure.

A third popular type of crystal detector has a crystal of iron pyrites, cubical crystals of iron sulphide which are bright yellow in color and have a metallic luster. The cat-whiskers are of the same types used with silicon crystals. There are fewer sensitive spots on a pyrite crystal than on silicon, but a good spot may be more sensitive than one on silicon. Pyrite crystals retain their sensitivity with age and exposure in about the same way as silicon crystals.

The crystals of any type are set in a mounting of some metal which melts at low temperature. This is because a high temperature will permanently destroy the sensitivity of any crystal.

The rather low sensitivity and need for re-adjustment of crys-

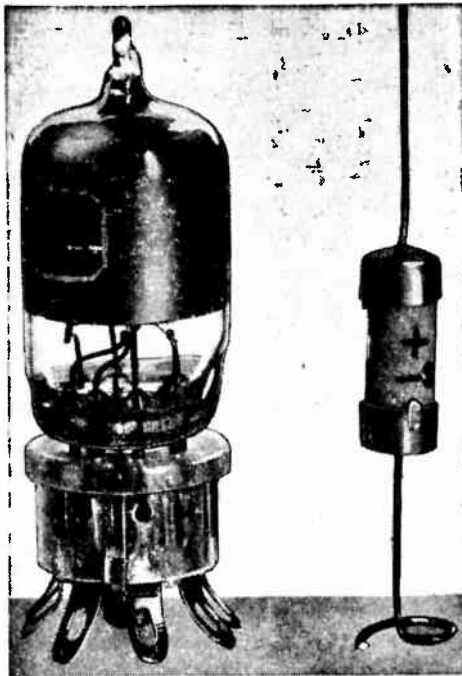

Fig. 7.—A high-frequency vacuum tube diode with socket, and at the right a germanium crystal diode. The crystal diode is 11/16 inch in length.

tal detectors make them impractical for use in receivers other than of experimental types. They cannot be permanently calibrated for use as rectifiers in a-c meters having moving-coil permanent-magnet movements. Crystal detectors are used in resonance indicators when making tests and measurements in resonant circuits, where the ability of the crystal to rectify at very high frequencies is an advantage.

Crystal Diodes.—A modern evolution of the early crystal detectors is called a crystal diode. Fig. 7 shows a crystal diode alongside a high-frequency vacuum tube diode. The Sylvania crystal diode pictured contains a crystal of germanium, which is a gray-white, brittle metallic element. The crystal is cut from a sheet about 1/40 inch thick, is ground optically smooth on one side, and is silver soldered to the tip of a brass screw. The cat-whisker is a tungsten wire about 3/1000 inch in diameter, soldered to another screw and having a loop which allows original adjustment for correct forward and back resistances. These parts are enclosed within a tube of Isolantite which is wax-filled to maintain the adjustment and to make the assembly moisture-proof. On each end are wire pigtails silver soldered to end cups which are welded over the end caps.

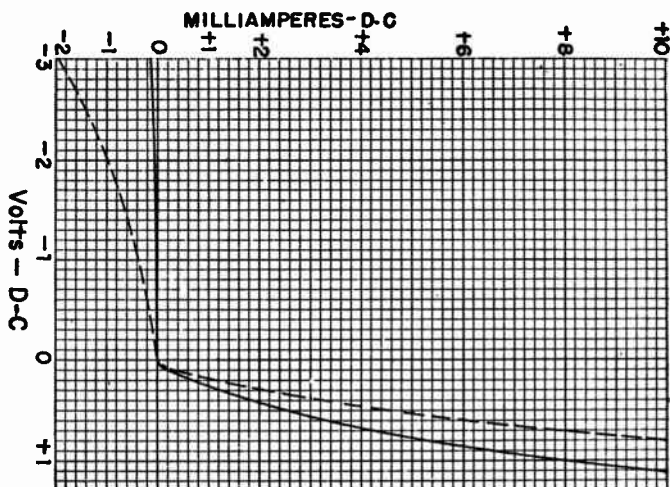

Fig. 8.—Rectification curves for a germanium crystal diode and for a galena detector

The difference between rectification efficiencies of the germanium crystal diode at one megacycle and at 100 megacycles is only 10 to 20 per cent with loads of 20,000 to as small as 5,000 ohms. Up to 10 megacycles the falling off in efficiency is only between two and about seven per cent. The efficiency still is better than 50 per cent at frequencies as high as 500 megacycles, and with loads as small as 5,000 ohms.

Fig. 8 shows differences between rectifications of a germanium crystal diode and a well-adjusted galena crystal detector at low frequencies. The full-line applies to the germanium unit and the broken line to the galena. For a given voltage the galena has somewhat greater forward conduction, which would mean less resistance. But with reversed voltage the galena shows conduction increasing rapidly with applied potential or amplitude. Except for very small amplitudes of applied voltage the net rectified current from the galena would be small in proportion to the voltage.

The back conduction curve for the germanium unit in Fig. 8 does not truly represent the conditions, for at a 3-volt reversed

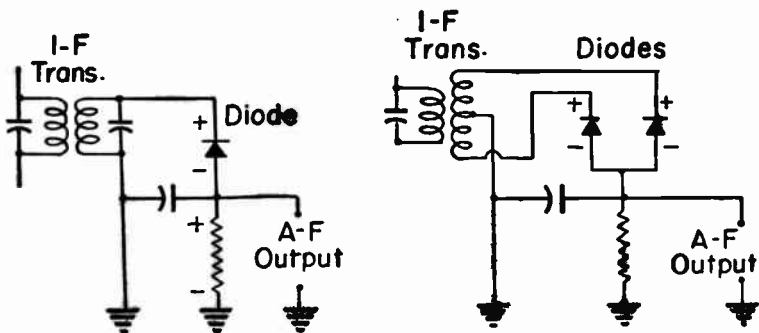

Fig. 9.—Crystal diodes as half-wave and full-wave detectors.

potential the current would be only about six microamperes and the resistance about a half-megohm. At three volts forward potential the resistance is about 60 ohms. These are average values and will vary somewhat with individual diodes.

The germanium crystal diode may be used as a half-wave detector as shown at the left in Fig. 9. The connections are no different than when using a vacuum tube diode half-wave detector except for the omission of heater or filament. The a-f output is shown across the load resistor. Any of the usual volume control circuits might be used. The connections for a full-wave detector using two crystal diodes are shown at the right. Again the principal circuit details are the same as for a double-diode full-wave vacuum tube detector. For full-wave detection and other circuits in which the two rectifiers should be quite evenly balanced the germanium crystal diodes are available in matched pairs wherein the forward matching is within 10 per cent at one-volt input and the reverse matching is within 20 per cent at 10 volts.

Fig. 10 shows two matched germanium crystal diodes as the two rectifiers in the discriminator for an f-m receiver. The crystal units may be used in other discriminator circuits as well as

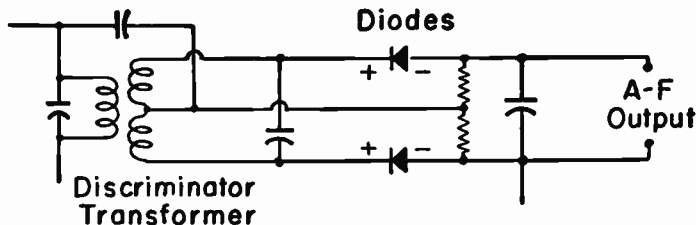

Fig. 10.—Matched crystal diodes in the discriminator for an f-m receiver.

the conventional type shown here. The positive and negative polarities for diodes in the diagrams correspond to the positive and negative signs which are on the crystal tubes.

A disadvantage of the crystal diode in comparison with vacuum tube diodes for some applications is the lower inverse voltage which may be withstood; 50 volts for the crystal as against several hundred volts for most tubes. Crystal diodes taken at random are not so uniform in either forward or back resistance as are vacuum tube types of high-frequency rectifiers.

Advantages of the crystal diode in comparison with vacuum

tube diodes include the absence of wiring and power dissipation for heaters or filaments, and consequent less heating. The forward resistance of the crystal diode is much less than that of vacuum tube types and the maximum direct current capacity, 22.5 milliamperes of continuous loading, is higher than that of detector types of vacuum tube diodes. The shunting capacitance of the crystal diode is only about three micro-microfarads when correctly mounted in a circuit, this being at least as small as the effective shunting of vacuum tube diodes and their sockets of types especially adapted to high-frequency work. The simple mounting of the crystal unit, with only its own pigtail leads, contributes to reduction of shunting capacitances. The cost of the germanium crystal diode is not much different from that of a high-frequency miniature diode and high-frequency socket.

Crystal diodes, like other contact rectifiers, may be used in rectifier type a-c meters which have moving-coil permanent-

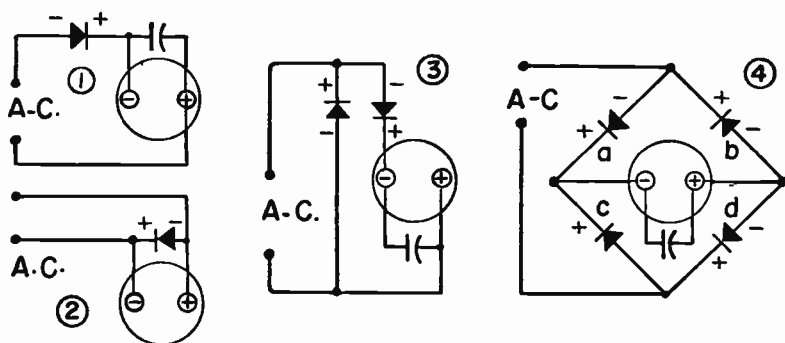

Fig. 11.—Crystal diodes in rectifier types of meters for alternating potentials and currents.

magnet movements. Some of the rectifier meter circuits are shown by Fig. 11. At 1, 2 and 3 are half-wave rectifiers with which current flows through the meter only during half-cycles of one polarity, with current during intervening half-cycles blocked or greatly reduced by the rectifier. The left-hand rectifier of diagram 3 carries current during these intervening half-cycles,

thus reducing the total resistance or impedance in the measured circuit, but giving somewhat less rather than more current through the meter than with the arrangement at 1. The single rectifier of diagram 2 acts as does the left-hand unit of diagram 3, carrying current during the half-cycles in which there is little current in the meter movement.

Diagram 4 shows the use of four rectifier elements in a full-wave bridge circuit. Here both polarities in the applied alternating potential cause flow of current through the meter movement. During half-cycles of one polarity the flow is through rectifiers *a* and *d*, with flow through rectifiers *b* and *c* during the half-cycles of opposite polarity.

The bypass capacitors shown across the meter movements in diagrams 1, 3 and 4 permit a worth while increase of meter current for a given applied alternating potential. The improvement with the capacitor is greater with circuits 1 and 4 than with 3, because with the arrangement at 3 the extra rectifier is really a bypass during half-cycles in which the meter carries little current.

Any of the rectifier meters of Fig. 11 will give readings at frequencies up to many megacycles provided the meter movement and its mountings do not have an excessive quantity of metal or of high-loss types of insulation, and provided resonances in the windings and distributed capacitances of the meter movement do not cause too much trouble. Making the rectifier elements into a separate shielded unit and allowing only rectified direct currents in the movement and its connections will improve the response at higher frequencies. The separate rectifier unit always should contain the bypass capacitor which helps complete the a-c path around the meter movement.

Crystal diodes are used in the high-frequency pickup probes for electronic voltmeters and signal tracers. The circuits for such probes are practically the same as those for vacuum tube diodes in the same kind of service, with the omission of leads for cathode heater or filament which are required for the vacuum tubes. The crystal diodes are used also in resonance indicator circuits for measurements at radio frequencies where the measuring circuit is tuned at or near resonance during some of the steps in these processes.

REVIEW QUESTIONS

1. Which of the three common types of contact rectifiers may be operated directly on power line voltages, without a step-down transformer?
2. Which of the following parts of contact rectifiers are live, and which are insulated; mounting screws, heat radiating flanges, mounting brackets, rectifying discs?
3. In replacing a tube rectifier with a contact rectifier, are changes required also in (a) the filter system, (b) the pilot lamp circuit, (c) the series filament circuit, (d) the line voltage?
4. Battery chargers and A-supplies often include low-voltage gaseous tube rectifiers. Which of the three principal types of contact rectifiers usually replaces such gas-filled tube rectifiers?
5. Why is it impractical to employ ordinary crystal detectors (galena, etc.) for rectifiers in meters, or in commercially built radio receivers?
6. Is the chief advantage of a crystal diode over an ordinary crystal detector in (a) a much greater forward current, or (b) a much smaller back current?
7. Except for the omission of heater circuits, is there any material difference between detector and discriminator circuits using crystal diodes and those using diode vacuum tubes? See Figs. 9 and 10.
8. Is it the vacuum tube diode or the crystal diode which has greater advantage with respect to (a) resistance, (b) ability to withstand reverse voltage, (c) uniformity of performance, and (d) current handling capacity?

Chapter 10

TUBES FOR SPECIAL PURPOSES

There are many types of tubes designed especially for applications in which requirements differ in greater or less degree from those of ordinary receivers and sound amplifiers. Special purpose tubes include those of small size used in portable and other small receivers, and in hearing aid devices. There are many tubes especially well suited for amplification or oscillation at high frequencies. Others are made for aircraft radios, still others for

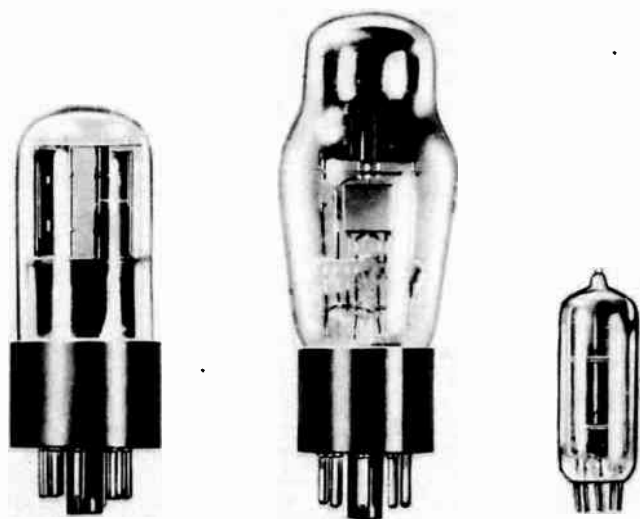

Fig. 1.—Tubes of three sizes. A miniature tube at the right.

farm light radios. Some tubes are made with highly uniform characteristics for use when close matching is required. In another group there are special tubes permitting little microphonic disturbance even where there is considerable vibration.

Miniature and Subminiature Tubes.—In Fig. 1 are picture-tubes of three sizes. At the left is a "GT" type, a little more than three inches in overall height. At the center is a standard "G" type, about four and one-half inches high. At the right is a miniature tube whose overall height is less than one and three-quarters inches. The outside diameters of the three tubes shown are, left to right, $1\frac{1}{4}$ inches, $1\frac{3}{4}$ inches, and $\frac{3}{4}$ inch.

The "GT" and "G" tubes have standard octal bases. The miniature tube has a miniature button 7-pin base. The base pins of the miniature tube come directly through the bottom of the glass envelope and are held by thickened parts of the glass without additional support or insulation. The pins are only $\frac{1}{25}$ inch in diameter and are from $\frac{3}{16}$ to $\frac{9}{32}$ inch long outside of the glass.

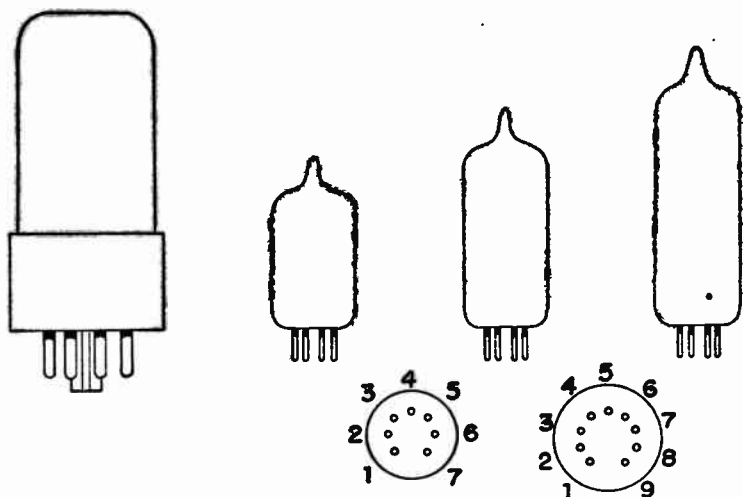

Fig. 2.—Comparative dimensions of a "GT" tube and three miniature sizes.

Fig. 2 shows outlines of a "GT" tube and three sizes of miniature tubes, all drawn to the same scale. All three miniatures have the same diameter, $\frac{3}{4}$ inch, but their overall heights are approximately $1\frac{3}{4}$ inches, $2\frac{1}{8}$ inches, and $2\frac{9}{16}$ inches. All have the 7-pin miniature button base shown at the lower left. The pins are spaced at 45-degree points around a circle, just as on an octal base. But there are only seven pins, leaving a possible

eighth position with no pin. Sockets for these tubes have only seven openings, spaced like the seven pins. The vacant position insures correct positioning of the tube in its socket.

Some miniature tubes have a 9-pin base and use a socket such as shown at the lower right in Fig. 2. The nine pins are located at 36-degree positions around a circle, with a tenth position vacant. Tubes of the 9-pin type are about $\frac{7}{8}$ inch in diameter and 2- $\frac{3}{16}$ inches long overall.

Fig. 3 shows outlines of some Raytheon subminiature tubes, drawn to the same scale as the tubes of Fig. 2. As shown at the left, one group of subminiatures has a slightly flattened envelope whose maximum width is $\frac{4}{10}$ inch and whose maximum thickness is $\frac{3}{10}$ inch. Tubes in this group are $1\frac{1}{2}$ or $1\text{-}\frac{9}{16}$ inches in overall height of the glass envelope, without the base connections. Some types of subminiature tubes have base pins only 0.016 inch (about $\frac{1}{64}$ inch) in diameter and may be used with sockets designed for these tubes. Other types have tinned flexible leads instead of base pins for making external connections. The lead wire diameter is the same as mentioned for the base pins.

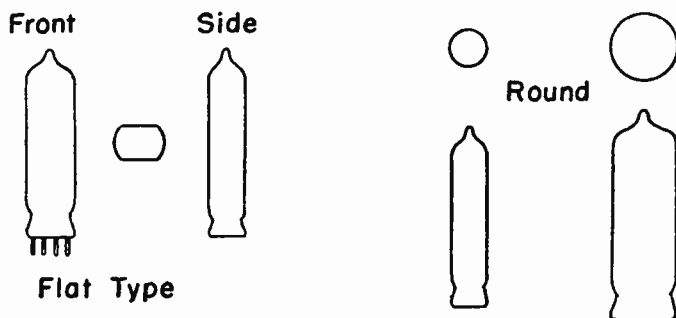

Fig. 3.—Outlines of subminiature tubes.

Subminiature tubes are made also with round or cylindrical envelopes as shown at the right in Fig. 3. The smallest are between $\frac{1}{4}$ and $\frac{5}{16}$ inch in diameter, with a length of $1\frac{1}{2}$ inch over the envelope. These are provided with flexible lead connections as mentioned for the types having flattened envelopes.

Miniature tubes are made in practically all of the types found

in the larger tubes. Following are the principal varieties in general use.

Diodes. Twin diodes. Quadruple diodes, with four plates and one cathode.

Triode and twin triode voltage amplifiers. Triode power amplifiers.

Double-diode triodes. Diode pentodes.

Voltage amplifier pentodes, both sharp and remote cutoff.

Power pentodes. Beam power tubes.

Pentagrid converters.

Half-wave and full-wave rectifiers.

Gas-filled voltage regulators.

Thyratrons, both triode and tetrode or shield grid types.

The miniature tubes are made both in filament-cathode and heater-cathode types. Heater voltages range from 1.4 to 117 volts, with heater currents from 0.04 to 0.60 ampere. Most filament-cathodes are designed for 1.4 volts, with some arranged for either series or parallel connection. Most filament currents are 0.05 ampere. Subminiature tubes are made in nearly all of the types found in miniature, and additional types of subminiatures appear frequently.

Tubes for Low Plate Voltage.—For use in aircraft having 12-cell storage battery power supplies and in other mobile equipment applications there are tubes especially designed to operate with very low plate voltages. The plate voltages, also screen voltages in types having screen grids, may be from 22 to 30 volts for normal operating conditions. Some of these tubes have heater-cathodes designed for 26.5 volts in the heater, others are for 28.0 volts, and still others for 12.6 volts. With the two higher voltages for heaters the plates, screens, and heaters all are operated at the same voltage as taken from the battery supply.

A fully charged 12-cell lead-acid storage battery has a terminal voltage of 30.0 while still being charged. When not being charged the voltage falls to 25.0 or 26.0 at normal load currents while the battery remains well charged. As the battery voltage falls off, with corresponding drop of plate and screen voltages, there is rapid decrease of amplification and increase of distortion with these tubes.

The low-voltage tubes are made in various types, including

voltage pentodes, double-diode triodes, twin-triode voltage amplifiers, converters, and twin beam power tubes. Considering the very low plate and screen voltages the transconductances or mutual conductances are high; running up to 1,800 micromhos in some of the triodes, somewhat higher in pentodes, and to over 5,000 micromhos in the beam power tubes. With suitable circuit design and operation, outputs of the beam power tubes in push-pull may reach one-half watt or somewhat more.

Tubes for Very-high and Ultra-high Frequencies.—It is becoming general practice to classify radio frequencies in certain definite bands or ranges as follows:

Medium frequencies	0.3 to	3 megacycles
High frequencies	3 to	30 megacycles
Very-high frequencies	30 to	300 megacycles
Ultra-high frequencies	300 to	3,000 megacycles
Super-high frequencies	Higher than	3,000 megacycles

All of the standard broadcast band and all of the short-wave broadcast bands ordinarily covered by short-wave receivers for homes are in the medium frequencies and in the high frequencies. Transmission or carrier frequencies for television and for frequency-modulation broadcasting are in the very-high frequencies. The intermediate frequencies for television and for f-m reception are high frequencies.

Nearly all of the types of tubes commonly used in standard broadcast reception will operate satisfactorily throughout all of the high frequencies, which extend to 30 mc, although the gain of amplifiers commences to fall off at 10 mc or below. Many of these tubes may be used at frequencies as high as 50 mc, but usually with increasing noise and with decreasing gain and selectivity. As oscillators some of the standard broadcast types of tubes will operate at frequencies as high as 100 mc, and this applies also to pentagrid converter tubes.

There are many tubes whose design permits really satisfactory operation through all of the very-high frequencies and well into the ultra-high frequency range. Some of these tubes designed especially for television and f-m reception have the commonly used glass or metal envelopes and standard octal bases. Suitable for the television and f-m transmission frequencies, and also for higher frequencies in some services, are a number of types of tubes having glass envelopes and lock-in bases.

A great number of the tubes which operate well in the very-high and ultra-high frequency bands are of the miniature type shown in Figs. 1 and 2, and of the subminiature type shown by Fig. 3. For operation well into the ultra-high frequency band there are a number of Acorn tubes of which the outlines are shown by

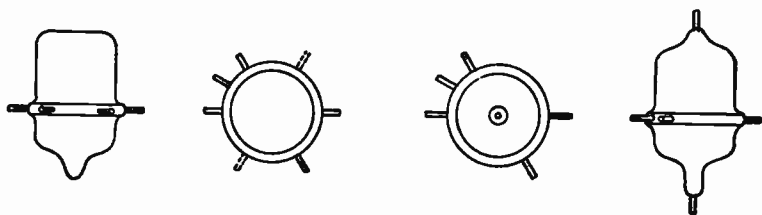

Fig. 4.—Outlines of Acorn tubes, from the side and the bottom.

Fig. 4. Connections to the elements in these Acorn tubes are made through pins which extend radially outward around the cylindrical sides of the tube envelope. On some types, as at the left, there are only the radial pins. On other types, as at the right, there are radial pins and also pins at the top and bottom extending in line with the axis of the tube. The terminal pins are about $1/25$ inch in diameter. They extend outward to a length of about $5/32$ inch. The outlines in Fig. 4 are drawn to the same scale as those in Figs. 2 and 3.

For operation at very-high and ultra-high frequencies there are five desirable characteristics for tubes.

A high mutual conductance or transconductance helps to maintain reasonable gain in amplifying stages in spite of all the effects acting to lessen the gain at high frequencies.

It is desirable to have small capacitance between plate and control grid of amplifiers to lessen the feedback which tends to cause oscillation, and it is desirable to have a low input capacitance between the control grid and cathode connections in order to reduce the shunting effect at high frequencies.

The inductance of the leads between external terminals or pins and the internal elements should be as small as possible, thus avoiding unwanted resonances and degenerative feedbacks.

The transit time should be as short as possible. This is the time

required for electrons to pass from cathode to control grid, and from cathode or control grid to plate.

Energy losses in dielectric materials of the tube and its socket should be as low as possible.

The gain of an amplifier depends on getting a satisfactory compromise between the factors just mentioned. Maximum advan-

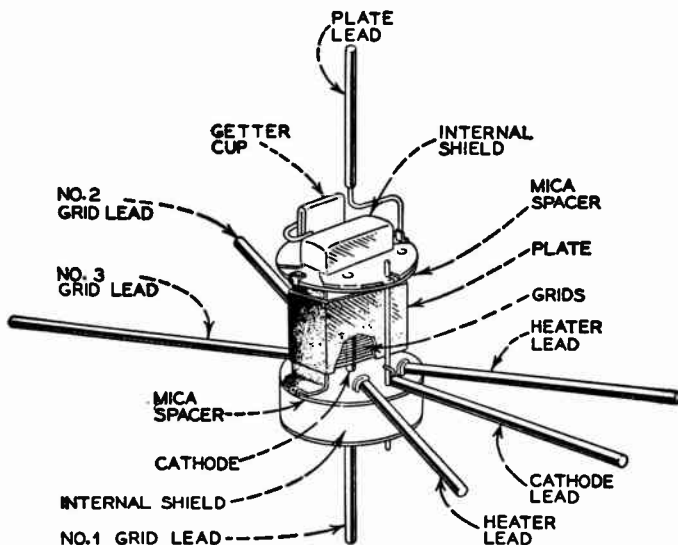

Fig. 5.—The arrangement of elements and pins in an RCA Acorn pentode tube.

tages of all kinds cannot be attained in the same tube. For example, constructions which permit high mutual conductance are the same ones which increase interelectrode capacitance and input capacitance.

The use of high-frequency tubes does not, by itself, make a high-frequency amplifier. It is necessary to design all of the connected circuits to reduce high-frequency losses. This applies especially to control grid and plate circuits. Most tubes which are designed for high-frequency operation may be used also at lower frequencies, although there may be no real advantage in doing so. Some high-frequency tubes will not operate as well as ordinary types in low-frequency circuits. Most high-frequency

amplifier tubes may be used also as high-gain audio amplifier tubes, but again this is not always true.

Several pentode amplifier tubes originally designed for television receivers have mutual conductances ranging from about 4,000 to 9,000 micromhos, but they also have input capacitances ranging from 7 to 11 micro-microfarads. These tubes find wide application in f-m receivers, especially since the f-m carrier frequencies were raised into the same general ranges as used for television. This is an illustration of how tubes originally designed for one class of service may give excellent results in a great many other applications.

The performance of all tubes at all of the high frequencies depends to a great extent on the *input impedance* of the tube between its control grid and cathode. This, like all impedances, measures the opposition to flow of alternating currents. If the input impedance is high there will be little current in the control grid circuit, but as input impedance decreases there will be more and more current in the grid circuit. The greater the current in the grid circuit the more power must be consumed in this circuit, and the more power or energy must be furnished to the circuit. The grid circuit is said to be loaded by the power demand due to low input impedance. Ordinarily there is very little power available in the signal circuits connected to the control grid; they should be voltage operated rather than power operated. Then, if power must be furnished for satisfactory gain, and if this power is not available, there will be little gain or no gain or possibly a loss.

Input impedance is affected chiefly by three factors; by capacitance between control grid and cathode, by inductance of any tube leads which are in both the control grid and plate circuits, and by electron transit time through the tube spaces.

The smaller the capacitance between control grid and cathode the higher is the input impedance and the less the loading. These capacitances in high-frequency triodes range from about 0.3 to 3.5 mmfd and in pentodes from about 2.0 to 11.0 mmfd. But, on the average, the pentodes have higher mutual conductances than the triodes. A fairly typical triode might have input capacitance of 2.0 mmfd, and mutual conductance of 2,200 micromhos, while a typical pentode might have input capacitance of 6.0 mmfd, and

mutual conductance of 4,800 micromhos. Input capacitances of glass envelope tubes are increased slightly by using a close-fitting external metallic shield.

In all triode and pentode amplifier tubes designed for operation at moderately high frequencies there will be a single base pin for the one cathode, or one base pin for each cathode in the tube. The lead from pin to cathode, and the pin itself, are in the control grid circuit and also in the plate or plate and screen grid circuits. The lead and the pin possess inductance, even though they are practically straight conductors. At moderate frequencies the reactance of this very small lead inductance is so small as to be of no importance.

But at very-high and ultra-high frequencies the reactance of the inductance in the cathode lead may become great enough to provide coupling between output and input circuits of the tube, because the same reactance is in both output and input. The phase relation of the output and input is such as to cause degeneration and reduction of gain.

A number of high-frequency triodes and pentodes have two separate pins and two internal leads for the single cathode. Connections to the two cathode pins may be made as in Fig. 6. The high-frequency return from the control grid circuit is made through a capacitor to one cathode lead, at the left. The high-frequency plate return, and screen grid return if there is one, are made through capacitors to the other cathode lead, at the right. Then the inductance and reactance of the lead in the control grid circuit is not common to the other element circuits.

The effects of lead inductance and reactance are lessened by short leads to the elements and by having the leads and pins of small diameter, both of which reduce inductance. This advantage is found in miniature, subminiature, Acorn, and many types of lock-in tubes. The effective input impedance is lowered by reactance of element leads. This effect increases with frequency because reactance increases with frequency.

In some high-frequency tubes there are two pins and two leads for the plate, and sometimes there are two or even three pins and leads for the control grid. The purpose of all multiple leads is, in general, to allow separation or isolation of two or more external circuits which are connected to the same tube element.

A tuned control grid circuit might connect to one lead and the bias circuit to another. In some oscillators one tuned circuit may connect to one lead and another tuned circuit to a separate lead. Under any conditions with which two or more leads to a single element are connected in parallel with one another the inductance and inductive reactance are lessened because the total inductance of inductances in parallel is less than that of either one alone.

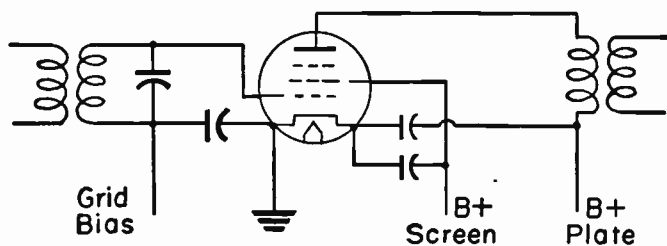

Fig. 6.—Connections to two leads for a single cathode.

The internal capacitances and inductances of a tube will form a self-resonant circuit at some high frequency. The resonant frequencies of some diode tubes used as detectors and other applications are from 700 to 1,500 megacycles. Self-resonance in an entire circuit using such tubes cannot be of as high frequency as that of the tube alone, but may be about two-thirds as high. Triodes and pentodes cannot be tuned at frequencies as high as their resonant frequencies, nor will these tubes oscillate at such limits of frequency. Tubes not designed for high-frequency operation usually become self-resonant at frequencies less than 200 megacycles.

Transit Time Effects.—We usually think of electrons as traveling instantaneously from cathode to plate in an evacuated tube. The electron speed is high, but when operation is at frequencies around 100 megacycles and higher the alternating potentials on the tube elements change at rates which are comparable with the time of electron transit through the tubes. A control grid may tell electrons to come ahead, but before the electrons are well on their way the grid may wave them back.

The velocity or speed of an electron in an evacuated tube space is proportional to the square root of the plate-cathode potential difference. Increasing this plate voltage increases electron speed,

but raising the voltage from 100 to 225 increases the electron speed only 50 per cent, because the square root of 100 is 10, and of 225 it is 15. In a tube operating with a plate-cathode potential of 250 volts the average speed or velocity of electrons between cathode and plate is about 10.5 million miles an hour, or about 11.7 million inches per second. We speak of average velocity because the electron may be assumed to start from rest at the cathode and to gain speed all the way to the plate. Then how long the electron takes to cross the space is proportional to half the final velocity at the plate, or to the average of this velocity and no velocity at all when starting out.

In some low-frequency receiving triodes the distance from cathode to plate may be 0.35 inch. With 250 volts on the plate the transit time would be about two billionths (0.000 000 002) second. Were this tube operating at 1,000 kilocycles the time period for one cycle would be one millionth (0.000 001) second, and only 1/500 of one cycle would be needed for an electron to go from cathode to plate. But supposing that the same tube were in a circuit with a frequency of 100 megacycles. The time period

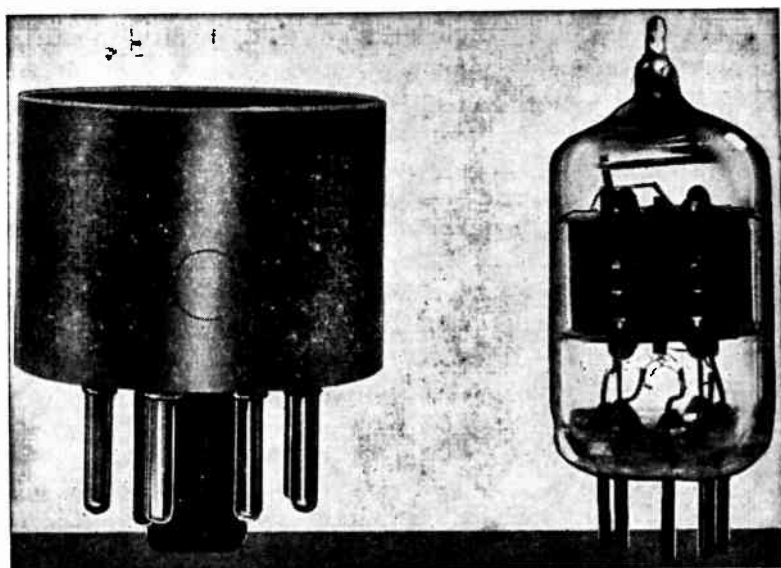

Fig. 7.—A miniature twin-diode tube alongside the base of a "GT" tube.

per cycle would be only $1/100$ of that at 1,000 kilocycles, which is one megacycle. Then $1/5$ of a cycle would elapse while the electron crossed the tube space.

One-fifth of a cycle is 72 degrees in the cycle. With a sine wave the grid potential would change from peak negative or positive to three-tenths of the peak value, or the potential might change from negative to positive during the electron transit. In a tube such as being considered the control grid would be much closer to the cathode than to the plate. Because electrons start slowly from the cathode, and reach maximum velocity only at the plate, more than half of the transit time might be taken during electron travel from cathode to grid.

In many high-frequency tubes of miniature, subminiature and Acorn types the distance from cathode to plate is only about 0.015 inch. Then the transit time would be only about $1/23$ of that in the tube first considered. In some high-frequency tubes the cathode-plate spacing is only about 0.005 inch, and electron transit time becomes proportionately shorter. In such a tube operating at 100 megacycles the transit time would be but little more than one degree in an alternating cycle.

Transit time is reduced directly with reduction of spacing between tube elements. It is reduced also, but not in direct proportion, by increase of plate voltage. Small spacings increase capacitances between the electrodes. High voltages increase power dissipation in the tube, and the small spacings and small elements make it more difficult to get rid of heat resulting from power dissipation. Once more we find that construction details which help high-frequency performance in one way harm such performance in other ways. It might be noted here that relatively high screen voltages for pentodes and beam power tubes give greater acceleration and velocity to electrons, and thus reduce transit time.

Solutions of problems involving transit time get into rather involved mathematics. However, such solutions would show that electrons do not arrive at the plate in time with changes of control grid potential when transit time is comparable to the time period of one cycle at the operating frequency. The plate current and plate voltage no longer will be in phase, and power dissipation will increase or power output will decrease. Even though the

control grid is negatively biased the grid-cathode and grid-plate electron flow rates will not be equal and opposite, and there will be a greater or less net electron flow or current in the grid circuit. This "electron loading" of the grid circuit means a reduction of the input impedance of the tube.

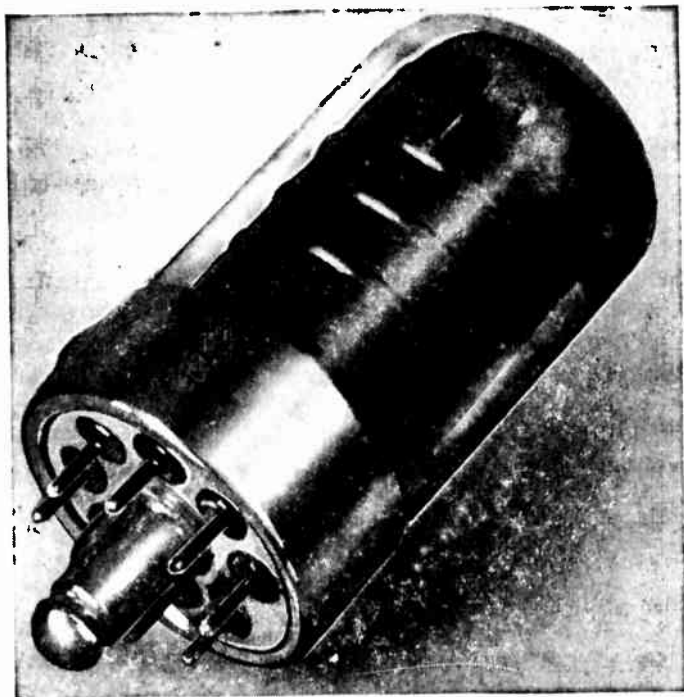

Fig. 8.—A lock-in tube. The small base pins come directly through the glass envelope.

When we consider the effects of transit time, of input capacitance, and of lead inductance on reduction of input impedance, and combine all this with the higher losses and lower Q-factor of tuned circuits, it is apparent that high-frequency operation meets great difficulties.

The high-frequency operating characteristics of tubes which have bases not an integral part of the envelopes are affected by the bases. The operation of tubes which require sockets is af-

ected by the sockets. The energy loss in materials used for bases and sockets is proportional to their dielectric power factors. This power factor, expressed as a fraction or as a percentage, is a measure of the fraction or percentage of power which is wasted in production of heat. The loss or the heat is due chiefly to movements of atoms, and of electrons and nuclei in atoms, as alternating potentials and charges reverse their polarity. Dielectric power factors of materials usually employed for high-frequency work range from 0.02 to 0.80 per cent or, in fractions, from 0.0002 to 0.008.

A *dielectric loss factor* commonly referred to is the product of dielectric power factor and dielectric constant of the material. Higher dielectric constants increase the capacitances between metal parts separated by or supported by the materials, and increase shunting effects as well as input capacitances as they affect input impedance. Among the dielectric materials having loss factors low enough for very-high and ultra-high frequencies are some varieties of low-loss phenolic compounds such as yellow Bakelite, low-loss varieties of Pyrex glass, the kind of glass known by the trade name Nonex, polystyrene, and steatite. In these materials the loss factors range from 0.5 to 3.5, as found from multiplying their dielectric constants by power factors in per cent.

REVIEW QUESTIONS

1. Are miniature tubes available in practically all types, or only in types suited to special purposes?
2. Are all miniature tubes of the same overall height? Are all of the same diameter?
3. What types of tubes may be wired into their circuits with flexible leads and no sockets?
4. Name the five desirable characteristics of tubes which are to operate at very-high and ultra-high frequencies.
5. Is it desirable to have large or small capacitance between cathode and control grid of a tube operating at ultra-high frequencies?
6. What is the purpose, in a general way, of providing more than one base pin or lead for the same tube element?
7. At what frequencies is transit time likely to cause trouble in tube operation?
8. Which lessens the transit time; low or high plate voltage, small or large element spacing?

Chapter 11

HIGH FREQUENCY AMPLIFIERS

As the operating frequency for amplifiers and oscillators is made higher there is a decrease in the gain of amplifiers, in the efficiency of oscillators, and in power output from both. If frequency is made high enough, amplifiers give us losses rather than gains, and oscillator efficiency becomes zero. At just what frequency an amplifier or oscillator no longer is useful depends on the requirements of the particular job, and on whether anything better is available for the same job.

The usefulness of amplifiers and oscillators may be extended into higher and higher frequencies by selecting tubes and circuit parts whose design and materials are especially well suited to high-frequency work. The frequency limit is extended also by designing and constructing the circuits in ways which reduce

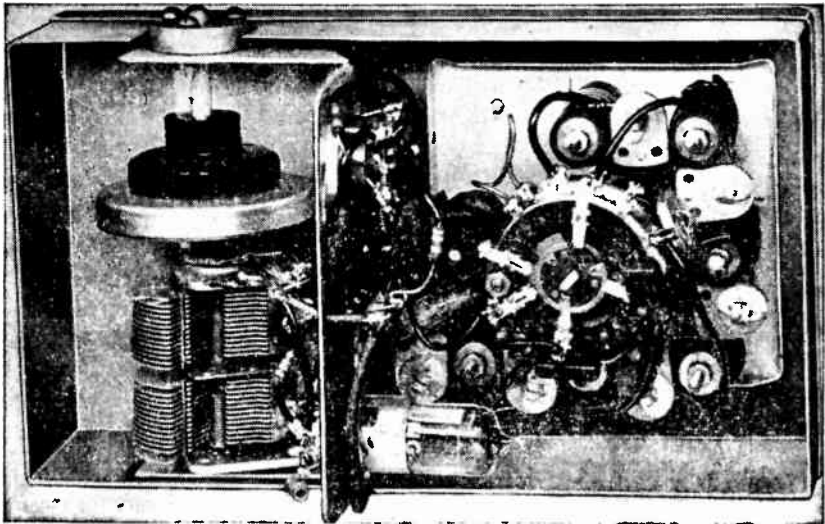

Fig. 1.—A high-frequency oscillator using a miniature tube shown near the lower center of the picture.

waste of energy at high frequencies. There is no definite limit of frequency at which we must change from certain types of parts and circuits to other types, for there is a steady dropping off of gain and efficiency as the frequency is multiplied.

It happens that most tubes, other parts, and methods of construction which give good results in the standard broadcast band are still useful at frequencies as high as 30 megacycles. Many ordinary tubes and many good quality parts may be used at much higher frequencies provided the circuits are arranged to avoid excessive losses. But at frequencies in excess of 50 megacycles it becomes worth while, or even necessary, to select all parts as well as circuit designs for minimum possible losses of energy at such frequencies.

In this chapter we shall discuss some parts and methods of construction which reduce losses at frequencies as high as several hundred megacycles. How many of these high-frequency practices must be incorporated in any one piece of apparatus will depend on individual requirements and on the limit of cost. Unfortunately, nearly everything which contributes to good performance at very-high and ultra-high frequencies costs more than parts which would be equivalent for low-frequency work.

Most of our difficulties at very-high and ultra-high frequencies result from the large inductive reactances of straight conductors and other parts, and from low capacitive reactances between all separated conductors. Parts designed as capacitors, to provide capacitive reactance, will have enough inductive reactance to cause unexpected resonances. Inductors or coils will have an astonishing amount of capacitive reactance. Resistors may act like bypass capacitors, or like inductive chokes, and even may become resonant. The chassis and panels become resistance couplings or conductive couplings for feedback. An extra inch of wire, or the position of one wire in relation to another may mean the difference between good and poor performance.

Capacitors.—Variable tuning capacitors of the air-dielectric type should have nothing but air in the electric field spaces. This means that insulating supports for the stator plates and other parts should be out of the electric field. The electric field is not only in the spaces between stator and rotor plates but spreads outward beyond the edges of the plates on all sides. The smaller

the size or quantity of supporting material the smaller will be dielectric losses in it. The supporting insulation should be of material having a reasonably low dielectric loss factor at high frequencies. Ceramic supports of the steatite class are in common use, for they combine the advantages of low energy loss with mechanical strength and rigidity.

It is desirable that tuning capacitors for high-frequency applications have no magnetic material anywhere in their construction. Magnetic materials include iron, steel, and all other iron alloys. This leaves aluminum, brass, bronze, copper and magnesium for use in plates, shafts, bearings, brackets, and fastenings.

An ideal capacitor would possess capacitance without resistance or inductance. Resistance is lessened by making plates and other current-carrying parts of metals having high conductivity

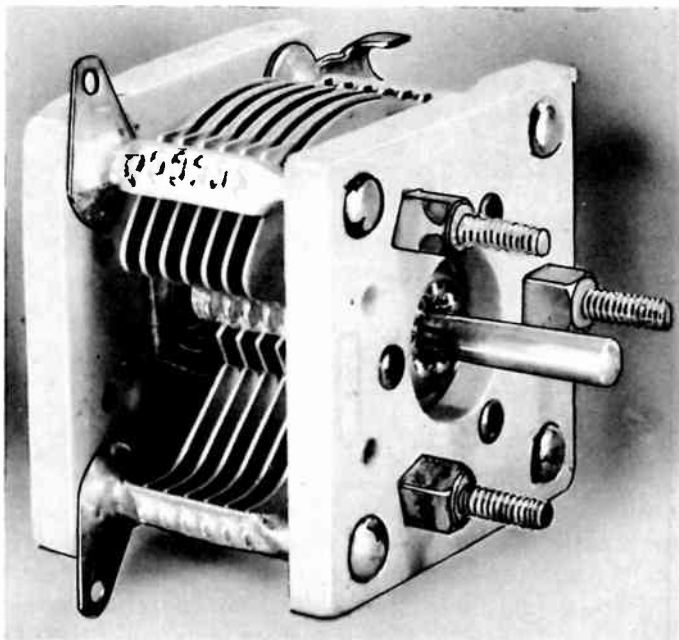

Fig. 2.—A capacitor having two stators, with a double rotor meshing with both stators

At high frequencies much of the electron flow is forced toward conductor surfaces by skin effect. Silver plating helps to reduce the high-frequency resistance by providing good conductivity over surfaces.

Contact resistances are lessened by soldering, brazing or welding the plates and shafts and by having the fewest possible joints or contacts between plates and the terminals for external circuit connections. It is a simple matter to make a good connection to the stator plates at the metal which joins all the stators into one unit. It is not so easy to make a connection of permanently low and constant resistance to the movable rotor plates. The rotor connection usually is made through a spring which presses on the shaft carrying the rotors, or through two or more such springs. Dirt or corrosion at the spring contact introduces high resistance which varies as the rotors are turned.

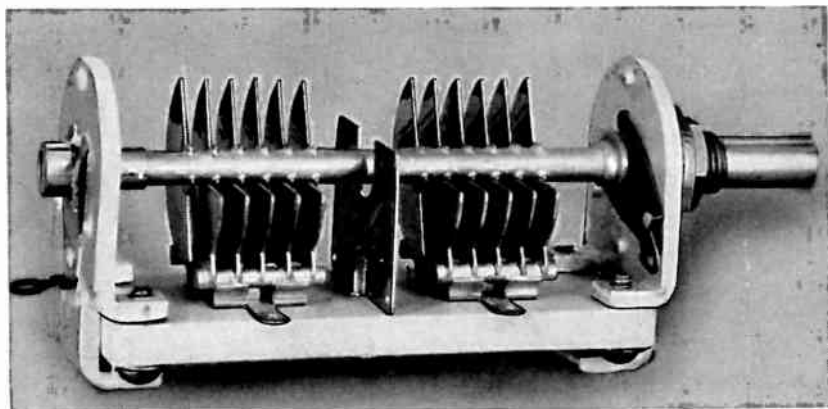

Fig. 3.—A small dual tuning capacitor with widely spaced plates.

Inductance of leads and connections within a capacitor is lessened by making these current paths short. In some high-frequency capacitors the connections are made to the centers of the groups of rotor and stator plates so that currents do not flow through the whole length of a group or its connecting strap to reach the terminal.

The capacitor of Fig. 2 has two groups of stator plates on opposite sides of the frame. On the shaft is mounted a butterfly-shaped rotor with similar groups of plates on opposite sides of the shaft. With the rotor plates fully in mesh with the two stator groups there is maximum capacitance between the two stator groups. The effect is that of two capacitors in series. One capacitor is formed by one stator group and the rotor group on one side of the shaft, while the second capacitor is formed by the opposite stator group and the rotor group on the other side of the shaft. The series connection results from the fact that the two rotor groups are electrically continuous. External connections are made only to the two stators, with the rotor insulated. Thus there are no moving or sliding current-carrying contacts.

Rather wide spacing between stator and rotor plates helps to maintain frequency stability, because then any change of plate position or shape due to any causes will cause a smaller percentage change of separation or dielectric thickness than with the plates originally close together. The dual tuning capacitor of Fig. 3 has plate spacing of about $1/20$ inch between stators and rotors. Many compact tuning capacitors for standard broadcast receivers have spacings much less than half of this amount. When plates are of large dimensions frequency stability is promoted by having the plates thick enough to insure rigidity and to maintain their alignment.

Fixed capacitors for bypassing, filtering and coupling at high frequencies often are of the silver-mica type. In these units a high quality capacitor mica is coated with a compound which reduces to metallic silver in a high-temperature furnace. Capacitances of these units remain quite constant with time, and with any ordinary temperature changes. They may be had in standard types with capacitance tolerance as close as one per cent.

Ceramic capacitors are much used in all high-frequency applications for bypassing, filtering, coupling, alignment adjustments, and temperature compensation. Most capacitors of this general type have for the dielectric a thin-walled tube compounded with low-loss ceramic material and titanium dioxide. Titanium dioxide permits large capacitance in small units having fairly thick dielectric, because with some kinds of this dioxide the dielectric constant exceeds 5,000. or is more than 5,000 times that of an equal

thickness of air. The metallic plates are formed on the outside and inside of the tube by depositing a silver compound which is fused to metallic silver by high temperature. In some types the silver then is plated with copper to which the leads are attached. The capacitance unit is moisture-proofed by wax impregnation, and may be coated with low-loss insulation or may be enclosed within a sealed tube of steatite.

Temperature compensating ceramic capacitors have dielectric compounds which vary their dielectric constants with changes of temperature. This type may be designed to maintain a practically constant capacitance with temperature changes, or to either increase or decrease the capacitance at a known rate with increase of temperature. Temperature compensating capacitors are used to counteract or balance the changes which naturally occur with variation or rise of temperature in other parts of a circuit. They are commonly employed to counteract frequency drift of oscillators, but are used also in other than oscillator circuits.

The temperature coefficient of temperature compensating capacitors may be specified as a certain number of micro-microfarads per microfarad of average capacitance per centigrade degree of temperature change. One of the more common negative coefficients is 750 mmfd per mfd per degree. This would mean a decrease of 750 mmfd of capacitance per mfd total average capacitance for each centigrade degree rise of temperature. With a total capacitance of 500 mmfd or 0.0005 mfd the change would be 750 times 0.0005 or 0.375 mmfd per centigrade degree. One centigrade degree is equal to 1.8 Fahrenheit degrees. With a temperature rise of 10 centigrade degrees or 18 Fahrenheit degrees the change would be 3.75 mmfd in the 500-mmfd capacitor.

Temperature compensating capacitors usually are mounted with only their own pigtail leads for support, and are placed where they will be affected quickly by changes of temperature in other parts of the compensated circuit. To correct for oscillator frequency drift the compensating capacitor may be used as a padder in the oscillator tuned circuit.

Ceramic trimmer capacitors have greater frequency stability than ordinary types of mica-dielectric trimmers unless the mica types have positive adjustments and are used with the plates

well separated. With widely separated plates any small shifting makes little percentage change in total separation, just as mentioned earlier for tuning capacitors.

One style of ceramic trimmer capacitor is shown by Fig. 4. The rotor is ceramic dielectric with the rotor plate consisting of metallic silver fused over part of the area on the upper side. On the stationary base is the stator plate of fused silver. The stator and rotor elements are pressed tightly together by radial springs. The areas of the silver coatings, and their shapes, determine the

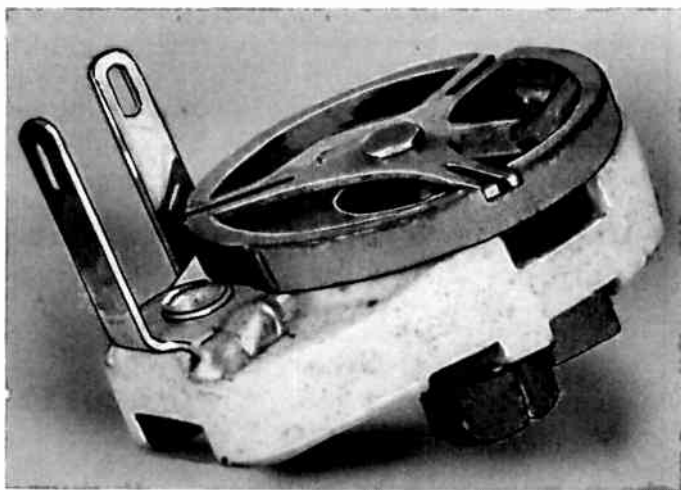

Fig. 4.—Rotary type of ceramic trimmer capacitor.

manner in which capacitance is varied by turning the rotor assembly on the stator. A number of ceramic trimmers are used in the oscillator of Fig. 1.

Unless the leads to or inside of fixed capacitors are very short the inductance of the leads may be enough to produce inductive reactance greater than the capacitive reactance of the unit at some high frequency. Then the capacitor acts more like an inductor than a capacitor. The inductance and capacitance may form a series resonant circuit at some ultra-high frequency. Such

resonance sometimes is used to advantage by matching it to a frequency which is to be bypassed.

Inductors for High Frequencies.—The factors which cause greatest difficulty with coils or inductors operated at high frequencies are distributed capacitance and energy losses in the windings. With single-layer solenoid windings the distributed capacitance is lessened by spacing between adjacent turns, as

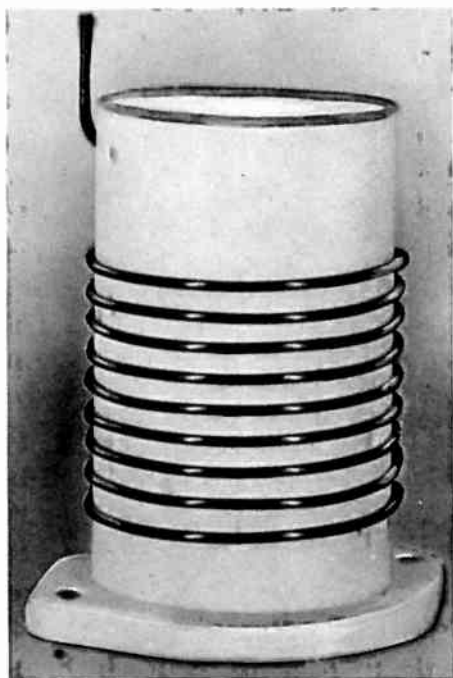

Fig. 5.—A coil with spaced turns on a ceramic form.

with the coil of Fig. 5 and by using a form or support of material having a low dielectric constant. Coil forms for high-frequency use most often are made of steatite materials or else of low-loss phenolic materials such as mica-filled Bakelite. In addition to having low dielectric constant the form material should have a

low dielectric power factor, this because the material is in electrostatic fields which result from differences of potential between adjacent turns acting as plates for a capacitance.

The less the dielectric material of any kind which is between and near the coil turns the smaller will be the distributed capaci-

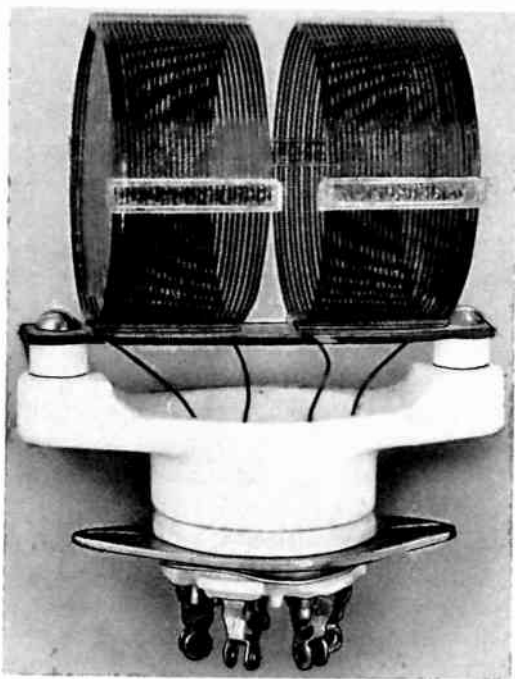

Fig. 6.—Coils with minimum dielectric in the field space, supported and mounted with polystyrene and steatite.

tance and the smaller will be the energy losses in the material. Fig. 6 shows "air-core" coils as used in a coupler or tuned transformer at high frequencies. In this design the windings are very nearly self-supporting, and are kept in correct alignment by passing the turns through or fastening them to a few narrow strips of low-loss insulating material. In the design illustrated

there is a minimum of dielectric material in the strongest parts of the coil field. The support is a plug-in type for mounting in a tube socket. The support and the socket both are of ceramic material having low energy losses and ample strength.

Although skin effect losses are reduced by making coil windings of stranded Litz wire for frequencies in the standard broadcast and some short-wave bands, the advantage disappears at about three megacycles. For higher frequencies it is usual practice to use solid round wire, coated to prevent corrosion of the copper.

The turns spacing shown by Fig. 5 is greater than necessary, and would be used only where very little inductance is needed. The greater the spacing the greater is the length of wire needed for a given inductance, and the more loss will occur due to high-frequency resistance in the wire. As a general rule the best compromise between effects of distributed capacitance and high-frequency resistance is had with spacing between adjacent turns equal to about 0.4 or $\frac{2}{5}$ the diameter of the wire used in the winding.

Air-core windings of the type shown by Fig. 6 are available in lengths which may be cut off to provide a required inductance and then mounted. Diameters range from $\frac{1}{2}$ to $2\frac{1}{2}$ inches, and stock windings have from 4 to 32 turns per inch.

When an amplifier or oscillator is to operate in more than one frequency band by using different coils for the several bands there will be energy losses in the unused coils unless they are far removed from the above circuit. There are energy losses whether unused coils are merely disconnected or are disconnected and short-circuited on themselves and to ground. If only part of the turns of one coil are active in some frequency bands there will be energy losses in unused turns whether they are left as "dead ends," are disconnected completely, or are short circuited. When magnetic fields of active coils reach any other coils there are emf's and sometimes currents induced in those other coils. The energy is taken from the active circuits.

Tuning coils and chokes with powdered iron cores are quite generally used at frequencies as high as 200 to 300 megacycles. The powdered iron core ordinarily is in the form of a cylinder $\frac{1}{4}$ to $\frac{3}{8}$ inch in diameter and from $\frac{3}{8}$ to more than $\frac{1}{2}$ inch long.

This core or "slug" is arranged with a screw adjustment allowing it to be moved farther into or out of the center of the coil which is wound on an insulating form acting as a guide for the core.

The powdered iron core gives a considerable increase of inductance compared with an air core for the same coil. The increase of inductance usually is between two and three times. Consequently, for any given inductance the coil winding may be made smaller, both shorter and of less diameter, than with an air core. The smaller winding will have less distributed capacitance and less high-frequency resistance than the equivalent winding for an air core. Then, with the same inductance but less high-frequency resistance, the iron-core will have a higher Q-factor than the air-core type provided the general construction and quality are the same for both.

Moving the core farther into the winding increases the inductance and lowers the resonant frequency, while moving the coil out of the winding lessens the inductance and raises the resonant frequency. With a fixed capacitor to complete the resonant circuit all tuning may be done by movement of the core.

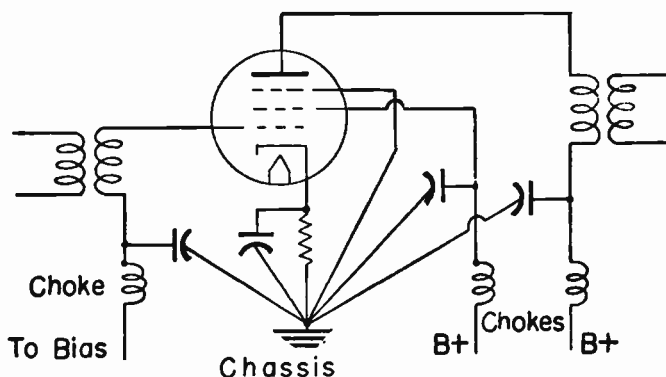

Fig. 7.—Bypassing and filtering for high frequencies.

Sometimes the core adjustment is used for tracking at the low-frequency end of a band, with a capacitor trimmer for tracking at the high-frequency end. In other cases all tuning is done with

a variable air-dielectric tuning capacitor, with the core adjusted to balance the inductance with the variable capacitance over the tuning range.

Bypassing, Filtering, and Shielding.—The metal of the chassis and panels to which grounding connections are made will have sufficient resistance and possibly inductance to provide coupling between grounded circuits. Such coupling occurs when high-frequency currents in plate, screen and control grid circuits return to the tube cathode through the same metal. If, as indicated in Fig. 7, all the element circuits have their high-frequency returns through bypass capacitors which are grounded at the same point of the chassis metal these couplings will be lessened. Back couplings of the nature mentioned are especially troublesome when between the output of one amplifier tube and the input for some preceding amplifier tube in the same apparatus.

The leads to and from the bypass capacitors should be kept separate from one another all the way to the cathode or to the grounding point. Otherwise some of the lead lengths will be common to two or more element circuits and there will be inductive feedbacks. The bypass capacitors should be of low-loss construction. Lead connections on both sides of the capacitors should be as short as possible. When one lead has to be longer than the other the longer one should preferably be on the ground side.

For still more complete isolation of element circuits there may be high-frequency choke coils in the leads from the plate circuit and screen grid circuit to the B-supply, and in the lead from the control grid coil to the bias voltage supply when the bias is other than from a cathode resistor. These chokes are shown in Fig. 7. High-frequency chokes may be used also in both of the heater leads.

The ground connection for circuits of each tube should be close to the socket. When there is no cathode-bias resistor the screen bypass capacitor may be mounted on the socket terminals.

Tuning coils, couplers and transformers may require individual shields. The clearances between coils and the insides of shields should be greater than usually provided at lower frequencies. The shield diameter may be twice the diameter of the coil, and the ends of the coil may clear the shield by a space equal

to the coil diameter. One or more of the high-frequency amplifier stages may have to be enclosed within a stage shield to prevent interstage couplings.

All high-frequency shields should be of non-magnetic metal having high conductivity, thus reducing losses due to currents induced in the shield metal and lessening couplings which may result from the fields of these currents. All shields must be securely grounded to the chassis metal through connections of good conductivity.

The d-c power supply for high-frequency amplifiers and oscillators should have good voltage regulation. Voltage regulator tubes usually are needed for best results when operation is from power and lighting lines. Battery power supply is excellent in high-frequency work, because of good regulation and also because of smaller tendency to cause feedbacks. Many tubes designed for high-frequency operation will have considerable variation of input impedance when there are variations in supply voltage and in average values of plate and screen currents.

Parts and Materials for High Frequencies.—The chassis, the panels, and all metallic supports and fastenings in apparatus for very-high and ultra-high frequency work should be non-magnetic and of high conductivity. Such metals act as efficient shields and at the same time their high conductivity or low resistance helps to prevent resistance or conductive couplings between stages. Aluminum and many of its alloys have the desired electrical properties combined with good mechanical strength and ease of forming and machining. Many small brackets, posts, screws, and similar parts may be of brass or bronze.

All metals oxidize or corrode to a greater or less extent when exposed to air, and the resulting surface coatings have resistances much higher than those of the metals themselves. Movable contacts, as in switches, should be of wiping or sliding types to provide self-cleaning features. Fastenings must be tight enough to exclude air, and should be secured with lock washers or other devices which prevent turning. Wherever it is possible, all joints should be well soldered.

Tuning capacitors and coils should be mounted as close as possible to the tubes with which they are connected. This reduces the lengths of plate and control grid connections and lessens their

inductance. It is not uncommon to find the control grid terminal of a socket fastened directly to the stator terminal of a tuning capacitor. Small tubes may be mounted at odd angles when this allows shortening of connections.

The insulation and insulating supports have important effects not only in coil forms but also in tube sockets, jacks and terminal connectors, band selector switches, bushings, and other places. Although small dielectric losses are a necessity it is necessary also to consider mechanical strength and rigidity, the ease or difficulty of cutting, threading and tapping, and the effects of temperature on energy losses and on mechanical strength.

The three materials in common use are ceramics of the steatite group, phenol compounds such as Bakelite, and polystyrene. Steatite cannot be machined after it has been vitrified by heat during manufacture. Low-loss varieties of phenol compounds can be machined, although with considerable difficulty and danger of fracture with ordinary shop methods. Polystyrenes are easily cut and threaded, and may be bent when heated. Maximum rigidity is found in steatites, but it is combined with brittleness. Phenols are rigid enough for practical purposes, and have enough elasticity to withstand mechanical strains and shocks. Polystyrenes are elastic and quite easily deformed unless of large cross section or unless supported by metallic parts.

Polystyrenes have the lowest energy losses at high frequencies. The energy losses in low-loss grades of steatites are greater than in polystyrenes, but still are so very small as to make this material satisfactory for ultra-high frequency work. The losses of low-loss phenols are greater than in either of the other materials being considered, but still are very small. Average loss factors might be about 0.75 for polystyrene, 1.10 for steatite, and 2.50 for yellow low-loss phenol. Any loss factor less than 3.50 causes no great difficulty at frequencies of many hundreds of megacycles. In all of these materials, even when classed as low-loss varieties, there are various grades and qualities.

Polystyrenes do not permanently deform at temperatures up to about 165° F. The phenols remain stable up to about 280°. Steatites are stable up to at least 1800°. Polystyrene absorbs the least water when immersed. Steatites absorb about twice as much, and the phenols absorb many times as much. Steatites usually are

glazed or otherwise surface-treated to prevent absorption and prevent spread of a moisture film over the surfaces.

Capacitances which act as undesired shunts, bypasses, and impedances in high-frequency circuits depend on mechanical design and spacings between metallic parts which are embedded in or supported by the dielectric insulators. Greater separation and smaller metallic surfaces reduce these capacitances. The average dielectric constant of polystyrenes is about 2.5, of low-loss phenols is about 5.3, and of steatites is about 6.1.

When lacquers, dopes, and cements are used to hold coil windings and other circuit parts the distributed capacitances are increased, because all such fastenings have dielectric constants greater than that of air. Polystyrene cement probably causes the least capacitance increase. All of these fastening materials should be applied in the smallest quantities which will provide support.

At frequencies higher than about 10 megacycles all ordinary types of wire-wound resistors have sufficient inductance to allow resonance with either distributed or lumped capacitances in the circuits. At any higher frequencies composition resistors will be more reliable.

High-frequency Receivers. — Superheterodyne circuits are in general use for reception of either amplitude- or frequency- modulated carriers up to frequencies in excess of 200 megacycles. In the highest of the television high-frequency channels the sound carrier frequency is at 215.75 megacycles. Receivers for the higher frequencies may have two or even three tuned r-f stages ahead of the mixer or converter when designed for reception of weak signals. Either two or three i-f stages are used in receivers operating above 50 megacycles.

Tubes for r-f stages, also for the converter or for separate mixer and oscillator usually are miniature or Acorn styles of types designed for high-frequency operation. The small tubes or else the larger "GT," lock-in, and metal envelope tubes of high-frequency types are used in the i-f amplifiers.

Intermediate frequencies always are much higher than used for standard broadcast and short-wave reception. These frequencies range from about 8 to as high as 30 or more megacycles in order to lessen the image response and to avoid pulling of the

oscillator frequency. Oscillator circuits may be compensated to lessen frequency drift, employing temperature compensating capacitors for this purpose. Frequency stability is further improved in some receivers by using voltage regulator tubes in the d-c power supplies.

With receivers designed to operate in any one of several frequency bands, with separate tuning coils for each band, the same

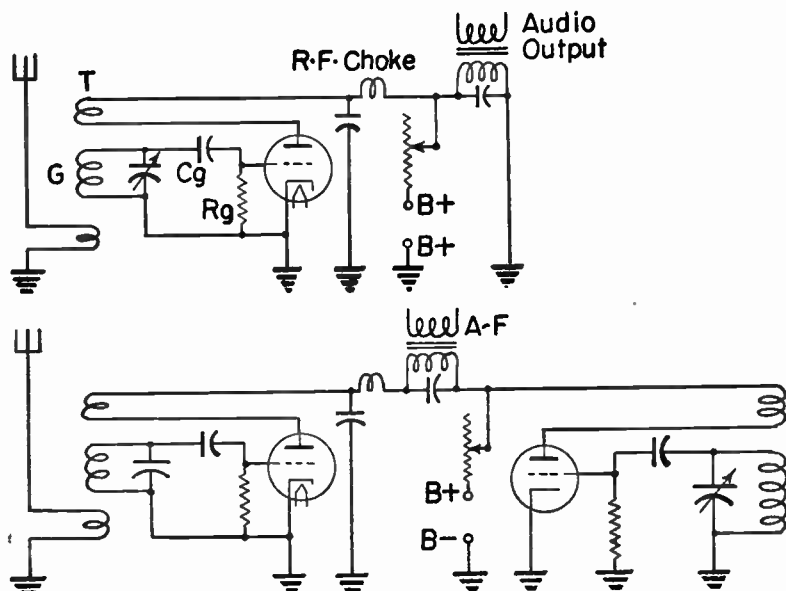

Fig. 8.—A regenerative detector (top) and a superregenerative detector and separate oscillator (bottom).

tuning capacitors often are used for all bands. Then the ratio of tuning inductance to capacitance is high in the low-frequency bands and low in the higher frequency bands. This reduces the voltage gain of the resonant circuits at the higher frequencies. The difficulty is overcome in some receivers by using two or more tuning capacitors, with a relatively large capacitance for

the lower frequencies and smaller capacitances for higher frequencies.

Superregeneration.—A type of receiver often used for experimental work in the very-high frequencies employs what is called a superregenerative detector. Such a detector permits high amplification in the detector itself. The receiver requires few tubes and the circuits are simple in construction. Without a preceding tuned r-f stage the detector alone is not very selective, and there is strong radiation from the connected antenna.

The superregenerator is a development from the regenerative detector, of which one style is shown at the top of Fig. 8. The detector is of the grid rectification or grid leak-capacitor type. Feedback from plate to grid circuits is through the tickler coil *T* in the plate circuit and coil *G* in the grid circuit. The feedback increases grid circuit potentials at the signal frequency; the action being called regeneration. The amount of regeneration may be controlled by moving the tickler coil with reference to the grid coil, by varying the plate voltage, and in other ways.

As regeneration is increased the amplification increases, but at some degree of feedback the tube commences to oscillate. Just as oscillation is about to commence the amplification reaches a very high value. With the circuit shown by the upper diagram it is impossible to maintain the conditions for peak amplification without allowing oscillation.

In the lower diagram of Fig. 8 there has been added on the right-hand side of the audio takeoff a feedback oscillator circuit including a triode tube with tuned grid and tickler feedback from the plate circuit. The frequency of this oscillator is adjusted to something well above the audible range, usually 20 kilocycles or higher, but far lower than the frequency of the received signal. The oscillator potentials are added to the plate potentials of the detector tube at the left and make the feedback alternately great enough for oscillation and too little to sustain oscillation.

Now the tickler coupling, plate voltage, or other regeneration control may be adjusted for very great regeneration and amplification. The control may be set just short of the point at which oscillation would be limited by the power handling ability of the detector tube and at which the tube would generate sustained oscillations. At this degree of regeneration the reversal of poten-

tial from the oscillator tube stops the process. On the following half-cycle of oscillator potential the build-up of amplification commences all over again. The audio output really is a series of pulses interrupted at the oscillator frequency, but since this frequency is above audibility the interruptions are not noticeable in the sounds.

In Fig. 9 are shown two methods of using a single tube as both regenerative detector and oscillator for interruption frequency. The frequency at which regeneration and oscillation are interrupted in the detector may be called the *quench frequency*.

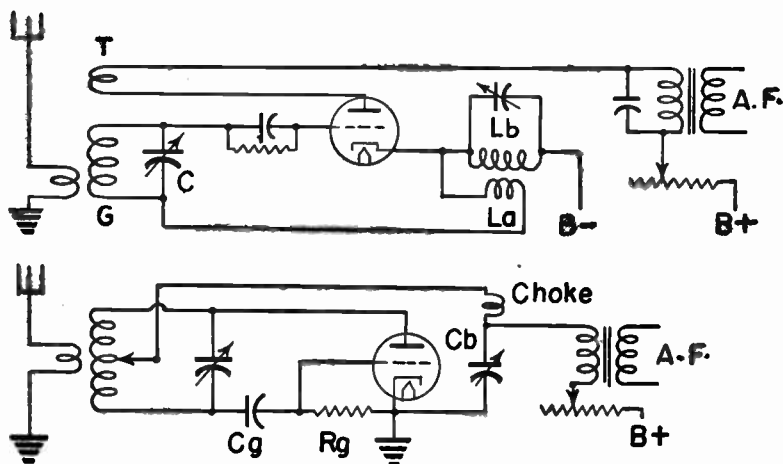

Fig. 9.—A tube having separate circuits for detection and oscillation (top) and a self-quenched superregenerator (bottom).

In Fig. 9 we have self-quenching superregenerative detectors. In the upper diagram the regenerative detector circuit is formed by coil *G* and tuning capacitor *C* in the grid circuit, and by tickler coil *T* in the plate circuit of the tube. The oscillator circuit for quench frequency is formed by coil *La* which is in series with the grid circuit of the tube and is coupled to coil *Lb* which is in the

plate circuit. The capacitor across L_b is tuned for the quench frequency.

In the lower diagram of Fig. 9 the tube acts as a regenerative detector and as a blocking oscillator. As oscillations build up to greater amplitudes the charge of grid capacitor C_g increases faster than it can leak off through grid resistor R_g . As a result, the grid becomes so highly negative as to reduce plate current to zero or nearly so, and oscillations cease. As soon as some of the excess charge escapes from capacitor C_g , the build-up commences all over again. How often the oscillation and regeneration are thus interrupted depends on the time constant of C_g and R_g . The frequency of interruption is the quench frequency. Feedback and regeneration may be varied by change of plate voltage, also by shifting the tap on the tuned winding in the grid-plate circuit to include more or less of this winding in the plate end of the coil. Adjustment of bypass capacitor C_b also affects the degree of feedback and regeneration.

The effect of quenching is shown by Fig. 10. It is evident that the quench frequency must be low enough, and the active periods long enough, to permit a number of signal frequency alterations

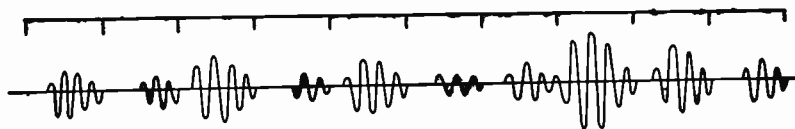

Fig. 10.—Signal amplitudes during intervals between quenching.

to be completed during each active period. The quench frequency should be no lower than $1/100$ of the signal frequency, and preferably is $1/400$ to $1/500$ of the signal frequency for reception of very-high frequencies. At the same time the quench frequency must be well above all audio frequencies. With a quench frequency of 20 kilocycles and a signal frequency at least 100 times as high the minimum signal frequency would be 2,000 kilocycles

or 2 megacycles. The superregenerator is not suitable for reception of low signal frequencies. The greater the signal frequency compared with the quench frequency the greater is the possible amplification.

In practical superregenerative receivers it is desirable to have a tuned radio-frequency stage ahead of the detector. This gives some added gain, greatly improves the naturally poor selectivity, and goes far to prevent radiation from the antenna. It is necessary to insert a low-pass filter between the detector output and a following a-f amplifier to keep the quench frequency out of the audio system. The power supply for plate current must have good voltage regulation. A voltage regulator tube may be used. In the audio output there is a hissing sound characteristic of this

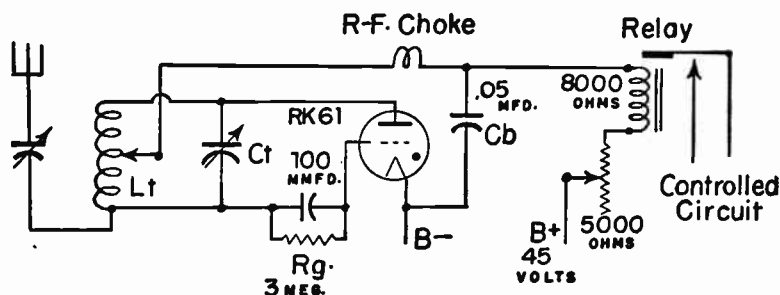

Fig. 11.—A high-frequency remote control for a relay, using a superregenerative detector.

method of reception. The hiss decreases when a carrier is tuned in, and becomes less with increase of carrier strength. The sensitivity is greater for weak signals than for strong ones, providing somewhat of an automatic volume control effect.

The Raytheon Manufacturing Company gives the circuit of Fig. 11 for remote control of a relay by means of a radio signal at carrier frequencies up to 100 megacycles. The tube is a Raytheon RK61 gas triode or three-element thyatron, connected as a self-quenching superregenerative detector. When operating correctly

the tube oscillates or blocks at audio frequency except during reception of an r-f signal, whereupon a-f oscillation should disappear. Average anode or plate current is increased by tighter antenna coupling or by less inductance and more capacitance at L_t and C_t of the tuned circuit. Maximum controllable relay current is increased by more capacitance at C_b and by less resistance at R_g . By using headphones instead of the relay, and using a smaller capacitance at C_b the apparatus will operate as a superregenerative receiver with B+ supply as low as 30 volts. The RK61 tube is little more than $\frac{1}{2}$ inch in diameter and about $1\frac{3}{4}$ inches long, with flexible leads for circuit connections. The filament requires 0.05 ampere at 1.4 volts.

Transceivers. — A transceiver includes tubes and associated circuits which may be used for both reception and transmission

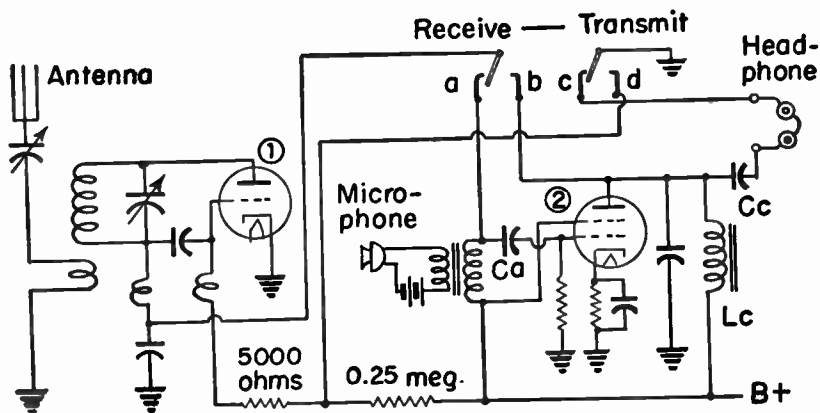

Fig. 12.—A type of transceiver using a superregenerative detector.

of high-frequency modulated signals. Many designs and circuits have been employed for transceivers. One of the simplest arrangements is shown by Fig. 12. Tube 1, a high-frequency triode, operates as a superregenerative detector for reception and as a modulated oscillator for transmission. Tube 2, a power pentode

or a beam power tube, operates as an audio-frequency amplifier for reception and a modulator tube for transmission. The headphones shown at the extreme right are used for reception, and the microphone at the center of the diagram is used for transmission. The same antenna is used for both receiving and transmitting.

The change-over from receiving to transmitting connections is made by the double-pole double-throw switch at the upper right. Switch arms are shown in the receiving position. In the *Receive* position the audio output of detector tube 1 is connected through switch contact *a* and capacitor *Ca* to the control grid of the a-f tube 2. The output of tube 2 is impedance coupled to the head-phone with audio choke *Lc*, coupling capacitor *Cc*, and switch contact *c* to ground.

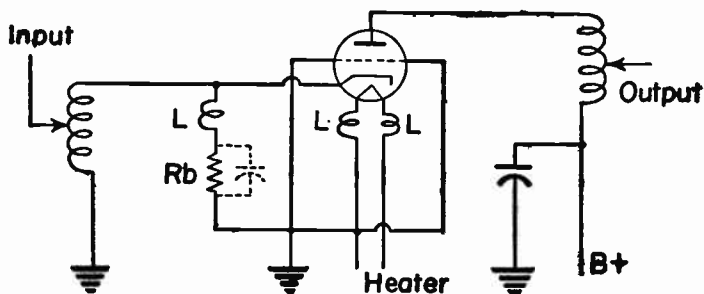

Fig. 13.—One method of connecting a grounded grid amplifier.

In the *Transmit* position the microphone is coupled through its transformer and capacitor *Ca* to the control grid of tube 2 acting as a modulator. The audio output of tube 2 passes from its plate through switch contact *b* to the grid circuit of tube 2 which is acting as a high-frequency oscillator. Switch contact *d* completes the grid circuit of tube 1 to ground. Plate voltages for both tubes now come from B+ through *Lc* (to tube 2) and through switch contact *b* (for tube 1).

It is illegal to operate the transceiver or any other apparatus

as a radio transmitter without first having an operator's license from the Government. Transceivers are now operated chiefly in the band between 144 and 148 megacycles and at higher frequencies in experimental pursuits. Distance ranges are from two to about 30 miles for small low-power sets. Antennas are vertical copper or aluminum rods or tubes 15 to 30 inches long. Miniature and other small tubes are used in all positions.

Grounded-grid Amplifier.—Triodes used in ordinary amplifying circuits have a decided tendency to oscillate because of feedback through the plate-grid capacitance of the tube. It is this tendency which has brought pentodes into general use for r-f amplifiers. At very-high and ultra-high frequencies the greater input capacitance of the pentode is a disadvantage. Triodes of special design may be used as amplifiers without danger of oscillation in a grounded-grid circuit, of which one style is shown by Fig. 13, in the ultra-high frequency ranges above 300 megacycles.

The high-potential side of the input circuit is connected to the tube cathode and the low-potential side to ground, and through ground to the tube grid. All of several leads provided for the grid are grounded to reduce the effective inductance of these leads and raise the input impedance. The capacitance between cathode and heater is across the input circuit, but the harmful effects are reduced by placing r-f chokes *L-L* in the heater leads so that cathode and heater remain at the same r-f potential. There is another r-f choke in series with cathode-bias resistor *Rb*. This resistor may or may not be bypassed with a capacitor.

There would be a feedback to cause oscillation in the capacitance between plate and cathode, but the grounded grid between plate and cathode acts as a shield to lessen the effective capacitance just as does the screen between plate and control grid in a pentode or tetrode. Tubes designed for grounded-grid operation have very small capacitances between plate, cathode and heater, the capacitance usually being only about one-fourth of that in other miniature triodes. Tendency to oscillation is still further reduced by the fact that the r-f plate return goes through the input circuit on its way to the cathode. The opposite phase in the output and input makes this feedback degenerative or negative, whereas feedbacks which cause oscillation must be regenerative or positive.

REVIEW QUESTIONS

- 1. Are tubes and parts suited for standard broadcast frequencies still useful at a limit of 5, 25, 50 megacycles, or up to what frequency?**
- 2. In a high-frequency tuning capacitor is it desirable to have long or short conductive paths?**
- 3. In coils for very-high frequencies are the windings usually of solid wire, stranded wire, or Litz wire?**
- 4. What is the minimum desirable spacing between sides and ends of a coil and its shield for high-frequency operation?**
- 5. Do commercial receivers for very-high frequencies usually employ the tuned r-f, the superheterodyne, or the superregenerative circuit?**
- 6. What two advantages result from using a tuned r-f circuit ahead of a superregenerative detector?**
- 7. Why are transceivers not in general use for intercommunication between departments of factories and in offices?**
- 8. What part or connection in a grounded grid amplifier or tube prevents oscillation due to plate-cathode feedback?**

Chapter 12

PHOTOTUBES

When you try to explain to a non-technical person why electronic amplifiers and oscillators do wonderful things you immediately get tangled in the relations between control grid potentials and plate currents. The other person can see nothing wonderful, because he doesn't appreciate what you are talking about. But when the beam from a pocket flashlight hits a phototube and controls switches, heaters, motors, and everything else electrical, and when walking through a beam of invisible radiation sets off bells, whistles, and all manner of alarms, no explanations are needed to prove that something wonderful is happening.

Among all the electronic tubes none are simpler than the phototube. In it there are only two elements, a cathode and an anode. The phototube is a diode. With triodes, tetrodes, and pentodes we regulate the rate of electron flow by varying the potential on the control grid. In the phototube we regulate the rate of electron flow by varying a light beam. The stronger the light the greater the electron flow. The weaker the light the less is the flow until, with no light, there is no flow. Not only may we use visible light which is white or of any color to control the phototube, we may also use invisible radiations called ultra-violet and infra-red. The phototube "sees" radiations which are wholly beyond our human vision.

For what may phototubes be used? You, yourself can give part of the answer, for anything and everything which requires electric power, electric heat, electric light, or any other electrical energy may be controlled by phototubes. That isn't all. Phototubes will count objects as they pass, will regulate traffic on a highway, time a horse race, or cause a printed label to appear at the same place on every package as wrapped by a high-speed machine. Phototubes will sort objects according to size, shape, position, or color, and will inspect articles on a production line for flaws. Phototubes will open doors at your approach and close

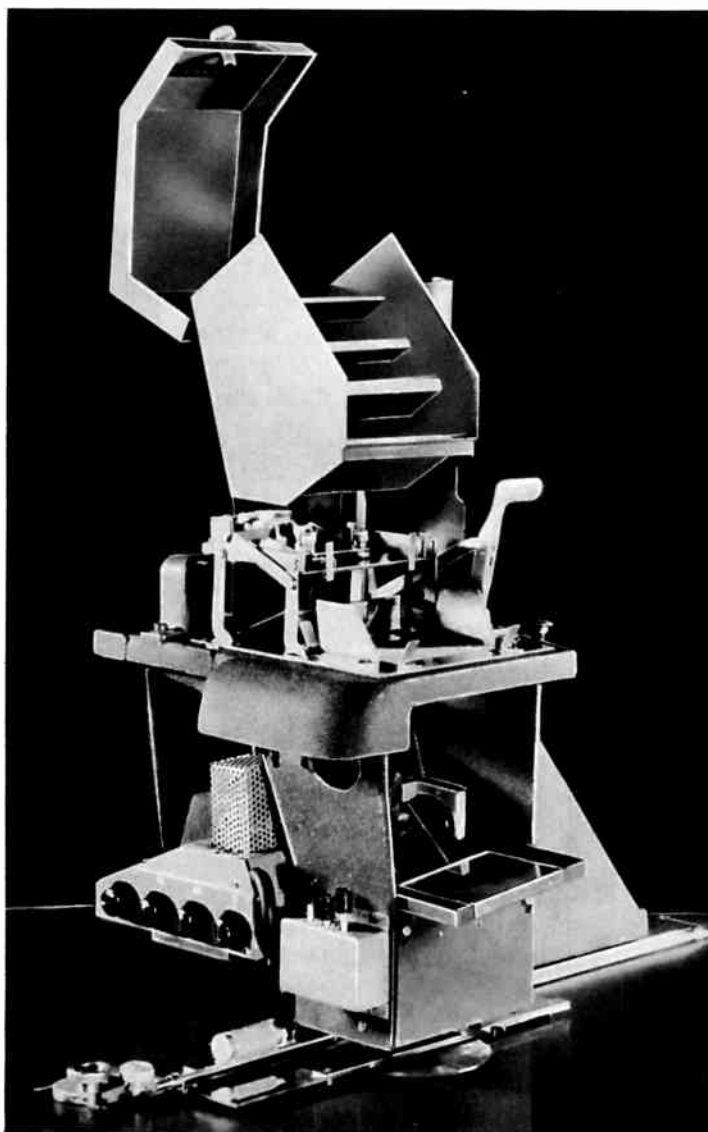

*Fig. 1.—An automatic photographic printer controlled by a phototube.
(Eastman Kodak Company)*

them after you pass, or they will shut off a punch press if you stick your fingers near the dies. A phototube may be used to time photographic exposures, to instantly measure areas of surfaces of most irregular shapes, to match colors, to control chemical processes in manufacture, to detect fire or even smoke, and to do so many other things that mere mention of them would fill this page.

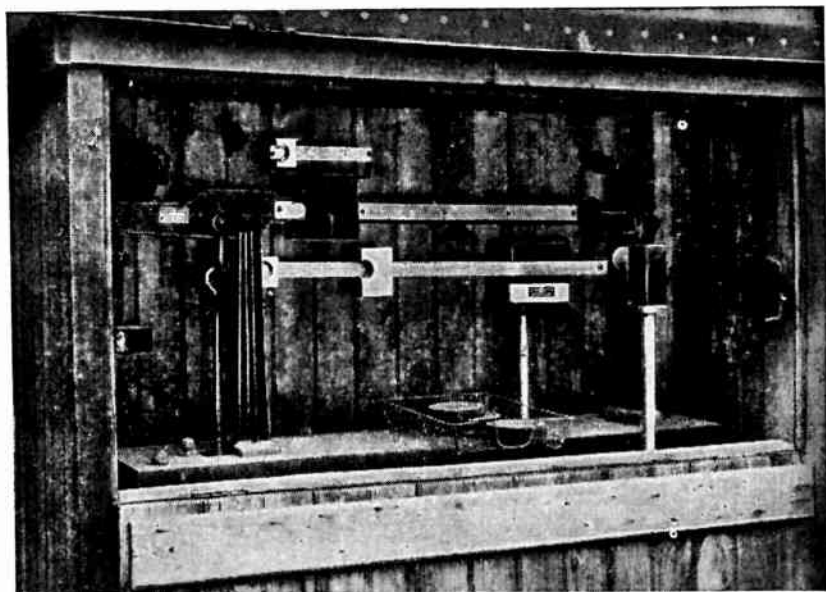

Fig. 2.—A scale equipped with a General Electric photo-relay for automatic weighing.

Strangely enough, the effect by which light regulates flow of current was discovered more than one hundred years ago. The earliest radio tubes didn't appear until sixty years later. During the early twenties you would have been lucky to buy a good phototube for fifteen to twenty dollars. Today you can buy phototubes far superior to the early types for around two dollars, some for less.

The most generally used kinds of modern phototubes look

much like radio tubes, with the same sizes and shapes of glass envelopes, bases and base pins, and using the same kinds of sockets. In the majority of phototubes the cathode is shaped like a half-cylinder with the anode a vertical wire near the axis of the cylinder. This arrangement is shown at the left in Fig. 3. Light must come to this tube from one side, to strike the inner curved surface of the cathode and cause electron emission from this sensitive surface. Other tubes, as at the center, have a cylindrical perforated cathode structure with the inside surface sensitive to light. The anode is at the center of the cylinder. Light from any direction may pass through the holes and strike the opposite internal surface to cause electron emission. In still other types the anode is a ring and the cathode a cup, as at the right. Light may come toward the end of this tube and strike the cathode surface to cause electron emission.

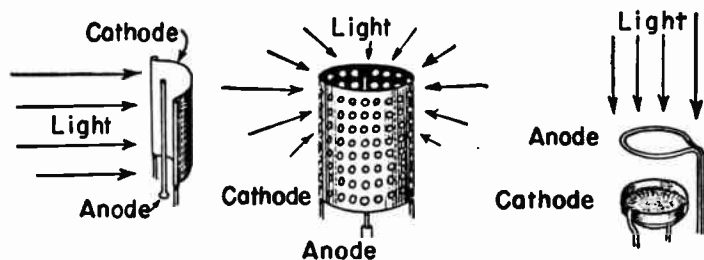

Fig. 3.—Phototube anodes and cathodes.

Visible and Invisible Radiations.—Electron emission from the cathodes of radio tubes is caused by heat energy. Heating the cathode imparts additional energy to electrons in the cathode material, and some emerge through the cathode surface and into the adjacent space. Electron emission from the cathodes of phototubes occurs because radiant energy of the kinds called light and ultra-violet and infra-red radiation gives electrons the extra energy they need to break through the cathode surface. The phototube cathode is not heated, and must not be heated, to cause emission. Light energy takes the place of heat energy.

Because we shall have much to do with light and other radiant

energies we should understand something about their behavior and how they are measured. Both light and radio waves are varieties of radiant energy. As we pass through higher and higher frequencies used in commercial and experimental radio we finally reach the super-high frequencies extending above 3,000 megacycles. But radio frequencies are considered to extend to 1,000,000 megacycles and then we come to radiation called infra-red because its frequencies are below those of the lowest visible frequency, which affects our eyes as the color red. Among the infra-red radiations are those called radiant heat.

Finally we reach frequencies so high that our eyes perceive them as color. At about 410,000,000 megacycles we perceive the darkest red. As the frequency increases we then see, in order, the colors orange, yellow, green, blue and violet. Violet becomes darker and darker until, at about 750,000,000 megacycles our vision no longer is affected. Then comes the region of ultra-violet frequencies extending to above a billion megacycles. Still higher we find the frequencies of X-rays, gamma rays, and cosmic rays extending to limits not even guessed at.

To express frequencies of many millions of megacycles calls for numbers inconveniently large, and it becomes easier to use units of wavelength. In radio we measure wavelengths in meters, also in centimeters which are equal to 1/100 meter. Wavelengths of light and similar radiations are such small fractions of a meter or centimeter that we usually employ a unit called the

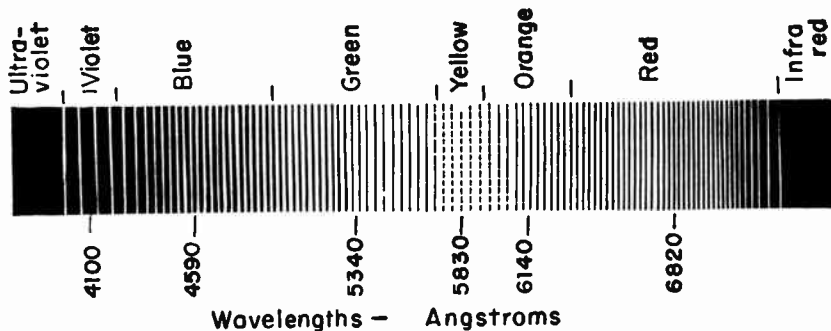

Fig. 4.—Wavelengths of light in the visible spectrum.

Angstrom or Angstrom unit. One Angstrom is a length equal to one hundred-millionth of a meter, or to about four billionths of an inch. Should you wish to translate megacycles into Angstroms, or Angstroms into megacycles, divide 3,000,000,000,000 by the known number of either megacycles or Angstroms and you have the equivalent in the other unit.

Fig. 4 shows wavelengths in Angstroms through the visible spectrum from violet to red. A spectrum is a range of wavelengths, or of frequencies. A visible spectrum shows ranges of visible light. The photoelectric spectrum includes visible light and also portions of the ultra-violet and infra-red. Do not get the habit of speaking of ultra-violet and infra-red as invisible light. Light implies visibility to our eyes, and there cannot be invisible light. The wavelengths shown in the graph are the approximate centers for the several colors. The colors change gradually from one into another and no boundary wavelengths can be assigned. That is, we cannot say that blue extends from 4,225 to 4,960 Angstroms and then suddenly changes to green. A wavelength of 4,590 Angstroms would seem blue to nearly everyone, and 5,340 Angstroms would seem green, but few would agree as to where blue ended and green commenced. A fairly uniform mixture of all colors or all wavelengths gives the sensation of white light. Absence of all visible wavelengths gives the sensation of black.

Were we to attempt studying the whole science of light it would be necessary to become familiar with a great number of new words and terms. But for work with phototubes alone we may omit most of the puzzlers and concentrate on the very few which are essential. First comes the matter of flow of light energy through space. A lighted lamp or any other source of light emits a flow of light energy. But instead of using the word flow we speak of flux, and say that the light source emits luminous flux. The rate of luminous flux is measured in a unit called the lumen. The lumen is a unit as important in the science of light as is the ampere in the science of electricity. Where we would measure electric flow in amperes we measure luminous flux in lumens.

Were the source to have a light emitting ability of one candle-power it would emit luminous flux at the rate of 12.57 lumens.

Imagine this one-candlepower source to be a mere point at the center of a hollow sphere having a radius of one foot, as at the left in Fig. 5. Light or luminous flux would be thrown uniformly over the inside of the sphere. Supposing now that in the surface of the sphere we make an opening having an area of just one square foot, as at the right. The area of the whole surface of

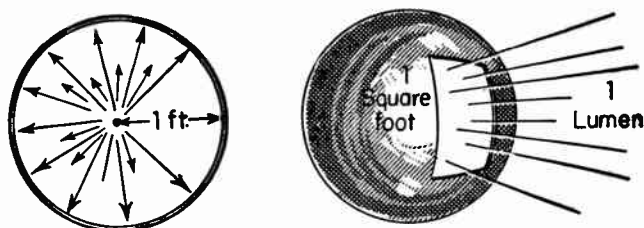

Fig. 5.—A one-candlepower source emits one lumen of flux through one square foot at a distance of one foot from the source.

the sphere is 12.57 square feet. Since we have 12.57 lumens on 12.57 square feet, luminous flux will come through the square-foot opening at the rate of one lumen.

Light emitting ability of lamps is expressed in lumens. A 60-watt Mazda incandescent lamp of the inside frosted type delivers a total flux of about 760 lumens. A 100-watt lamp delivers about 1,530 lumens.

Now look at Fig. 6. Here we have a source delivering a total luminous flux of such value that 36 lumens will pass through an opening one foot from the source and having an area of one square foot. The flux spreads more and more as it travels away from the source. At a distance of two feet from the source the same flux will have spread so that an opening to take it would have to measure two feet on a side and would have an area of four square feet. At three feet from the source the same luminous flux of 36 lumens would have spread so that it would fill an opening three feet on a side, and having an area of nine square feet.

Instead of considering successive openings filled by the same flux imagine that you hold a card one foot from a source of light.

The surface of the card will be well illuminated. Moving the same card two feet from the same source will reduce the illumination on the card surface, and moving the card three feet from the source will reduce the illumination still more. This is because the luminous flux spreads out thinner and thinner, just as in Fig. 6. At a distance of one foot there are 36 lumens for one

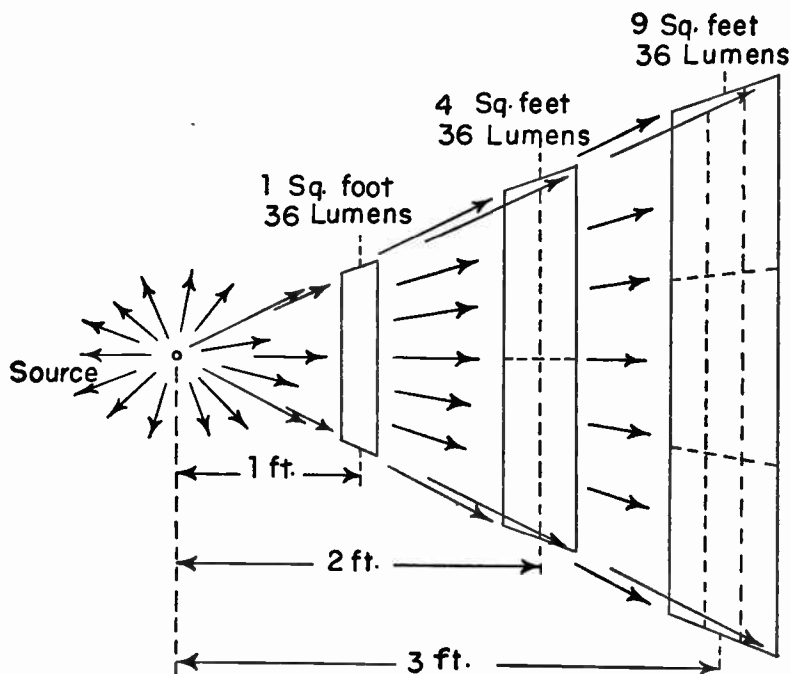

Fig. 6.—Intensity of illumination decreases as the square of the distance from the light source.

square foot, and the illumination is 36 lumens per square foot. At a distance of two feet there are 36 lumens for four square feet, and the illumination is only nine lumens per square foot. At three feet the 36 lumens spread over nine square feet, and the illumination drops to four lumens per square foot.

Illumination in a space or on a surface may be measured as so many lumens per square foot of area. An illumination of one

lumen per square foot is an illumination of one *foot-candle*. Dividing the lumens of flux by the number of square feet of area gives illumination in foot-candles. If you know the number of foot-candles of illumination and the area on the surface, multiply the number of foot-candles by the number of square feet to find the luminous flux in lumens reaching the surface. Lumens and foot-candles are the two units most often used in photo-electric work so far as measurements of light are concerned.

Photo-emission.—Scientists have a way of explaining the behavior of radiant energy which makes it quite easy to discuss the manner in which light causes emission of electrons from a phototube cathode surface. It is assumed that radiant energy travels through space not as a steady flow, like water from a hose nozzle, but rather in little bundles of energy comparable to bullets from a machine gun. Each little bundle of energy is called a *quantum*. If the radiant energy is that existing in visible light the quantum may be called a *photon*.

How much energy there is in each photon depends on the wavelength (color) of the light. The shorter the wavelength the greater is the energy per photon. Each photon of violet or blue light contains much more energy than each photon of red light.

When a photon strikes a cathode the photon penetrates the surface and its energy is transferred to a free electron in the cathode material. If this free electron already has a lot of energy the extra energy from the photon may enable the electron to jump right out through the surface of the cathode and enter the surrounding space. This is the process of photo-emission. In some cathode materials the photons may knock electrons out of the outermost orbits of some of the atoms.

The intensity of illumination at a surface increases when more photons arrive each second, and decreases when fewer photons arrive. Thus we find that intensity might be measured in foot-candles.

If the light is sufficiently intense, and is of short wavelength to provide high energy per photon, at least a few electrons may be brought through the surface of almost any kind of metal. There are a few metals, however, from which it is especially easy for photons to knock electrons, and which are thus well adapted for use in phototube cathodes. From this standpoint

the best metals are caesium, rubidium and potassium. Potassium seldom is used nowadays. Rubidium is used in some cathodes which are to operate with short wavelengths, in the blue and violet. Caesium is used in the cathodes of the great majority of phototubes. The active metal is deposited in a layer only one atom thick, which allows easy penetration for photons. The caesium layer most often is deposited on caesium oxide which is on silver.

Phototube Sensitivity.—The basic phototube circuit, shown by Fig. 7, is very simple. The phototube is connected in series with a load resistor R and a source of potential and current. The positive side of the source is connected to the phototube anode, the negative side to the cathode. The load resistance may be in either side of this series circuit. The resistance at R most often is something from one to ten megohms, although it may be less than one megohm or as great as 100 megohms.

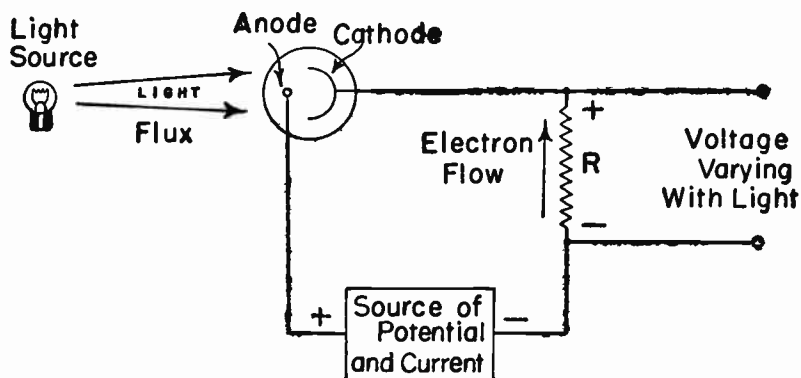

Fig. 7.—The basic phototube circuit.

When no light flux reaches the phototube cathode there is no electron emission from the cathode and no electron flow in the circuit. When light does reach the cathode there is electron emission and an electron flow through the circuit. The positive anode draws emitted electrons away from the negative cathode, just as in any electronic tube. The potential difference of the source

is great enough so that the anode-cathode potential difference draws all electrons away from the cathode as fast as they are emitted. There is no space charge in a phototube. As a consequence, the rate of electron flow in the whole phototube circuit is exactly the same as the rate of electron emission from the cathode. Since the rate of electron emission varies with the light flux reaching the cathode the electron flow in the whole circuit varies with light flux.

Across the load resistance R appears a potential difference which is proportional to the value of resistance and the rate of electron flow. With resistance measured in megohms and electron flow or current measured in microamperes, the volts of potential difference across R are equal to megohms times microamperes. This potential difference will vary with changes of light on the phototube cathode. The light-controlled potential difference across R may be applied to the grid-cathode circuit of an amplifier tube or thyratron, may be measured with a sensitive voltmeter, or used in any way that any potential difference might be used.

Upon measuring the current in the phototube circuit this current will be found to vary with changes of luminous flux reaching the cathode. The flux is measured in lumens, so phototube current varies with lumens. The number of microamperes of current per lumen of luminous flux is called the *luminous sensitivity* of the phototube.

Luminous sensitivity depends on the cathode emitter material of the phototube. Some materials give greater emission with short wavelength (blue and violet) light than with long wavelength (red) light, while other materials are more sensitive to red than to blue, and under some conditions we may have maximum sensitivity in the yellow-green wavelengths. For any given cathode material the sensitivity will vary with the wavelength or color of light being used. If you use blue light on a cathode which is strongly red-sensitive the luminous sensitivity (microamperes per lumen) will be relatively lower than when using red light for the same cathode. Similarly, using red light on a blue-sensitive cathode would show lower sensitivity than when using blue light.

Luminous sensitivity varies somewhat with intensity of light or with degree of illumination, even when the color remains con-

stant. Sensitivity will be a little greater for weak light than for strong light. When the anode-cathode potential difference is somewhere around 25 volts all emitted electrons will be drawn to the anode as fast as emitted. The higher voltages will not cause any increase of current, because the emission and resulting current depend on the light and not on the applied voltage. Above some certain value changes of voltage have no effect on luminous sensitivity.

Fig. 8 shows the photoelectric sensitivity of two different cathode surface materials and of the average human eye. The broken-line curve applies to a cathode surface having maximum emission and sensitivity at a wavelength of about 3,700 Angstroms, which is in the range of invisible ultra-violet wavelengths. The full-line curve applies to a cathode surface having

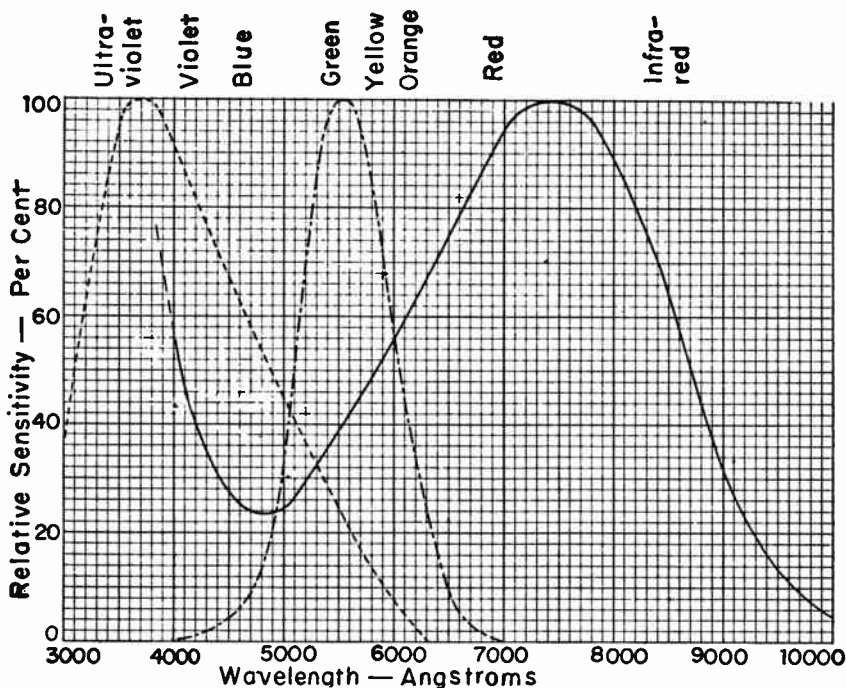

Fig. 8.—Wavelength or color sensitivity of cathode materials (left and right) and of the average human eye (center).

maximum sensitivity at about 7,500 Angstroms, which is in the region of invisible infra-red radiation. The dot-dash curve applies to the average human eye, which has maximum sensitivity at about 5,550 Angstroms, between the wavelengths corresponding to green and yellow.

The full-line curve is drawn only as far as 4,000 Angstroms wavelength. The sensitivity actually continues to increase at still shorter wavelengths and would show a strong peak in the ultra-violet region. However, the kinds of glass used in the envelopes of most phototubes do not transmit light of wavelengths much shorter than 4,000 Angstroms. To make use of cathodes at ultra-violet wavelengths it is necessary to have at least the portion of the envelope in front of the cathode made of special kinds of glass or even of quartz which transmits well into the ultra-violet.

The curves show only the manner in which sensitivity of each surface varies with wavelength. The sensitivity at the wavelength where it is maximum has been taken as 100 per cent for each curve, but the 100 per cent point on one such curve does not necessarily mean the same number of microamperes per lumen as on some other curve. Furthermore, the curves are drawn on the assumption of equal radiant energy at all wavelengths, and the only source which comes anywhere near meeting this condition is natural daylight.

One of the standard sources used in obtaining ratings for

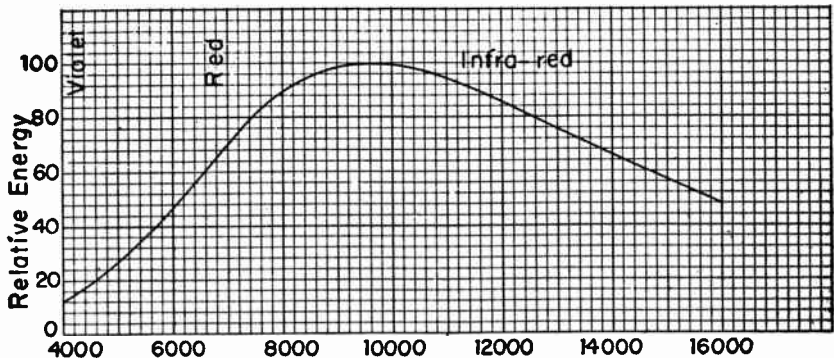

Fig. 9.—Wavelength distribution of radiant energy from a 2,870° K. tungsten lamp

phototubes is a gas-filled tungsten-filament incandescent electric lamp with the filament at a specified temperature. This temperature is called a color temperature of 2,870° Kelvin. The number of degrees does not correspond to the actual heat temperature on any thermometer scale, but is merely a means for indicating the wavelength distribution and the brightness of light from the lamp filament. Fig. 9 shows the distribution of energy from a 2870° tungsten lamp at various wavelengths from 4,000 to 16,000 Angstroms.

The standard lamp delivers more radiant energy around 9,500 Angstroms than at any other wavelength. By far the greater portion of the total energy is in infra-red wavelengths, and is radiant heat instead of visible light. With such a lamp used for phototube illumination the sensitivity curves would not appear as in Fig. 8. The short wavelength (violet) ends of the curves would be dropped far down and the long wavelength (red) ends would be raised, because the lamp furnishes little energy in the blue end of the visible spectrum and an increasing amount toward the red end. Then we would have curves showing sensitivity to 2870° tungsten radiation, not to equal energy at all wavelengths.

Ratings of luminous sensitivity are based on radiant flux in lumens. Lumens measure only visible light. Therefore, luminous sensitivity really can be specified only for radiations within the visible spectrum. For all radiations, both within and beyond the visible spectrum, sensitivity may be specified as so many microamperes of phototube current per microwatt of power in the radiant flux.

Vacuum Phototubes.—Some phototubes are made with their envelopes highly evacuated, with hardly any traces of gases remaining. With other phototubes the envelopes are first evacuated and then small quantities of gas are admitted before the final sealing. In these gas phototubes ionization is utilized to increase the sensitivity. We shall discuss vacuum phototubes first, then the gas types.

At the top of Fig. 10 a vacuum phototube is connected in series with a source of voltage and a microammeter. An adjustment allows varying the anode-cathode voltage on the phototube. The light source is movable, so that illumination on the phototube

cathode may be varied to provide various fluxes in lumens on the cathode. We shall assume that the total flux on the cathode is adjusted to 1/10 lumen for the first measurements.

If anode-cathode voltage or anode voltage, now is gradually increased from zero while noting the currents for each voltage the current-voltage relations for a certain tube may be as shown by the curve at the bottom of Fig. 10. At first there is a rapid rise in current. This rapid rise is due to drawing away from the cathode region the electrons which have accumulated in a space charge as they are emitted under the influence of light energy.

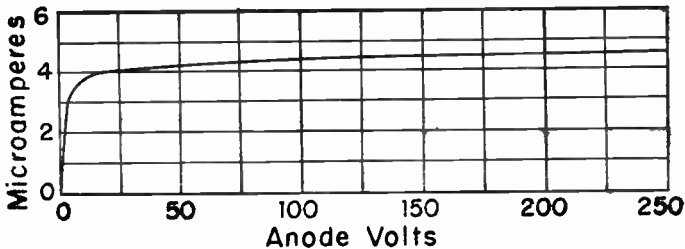
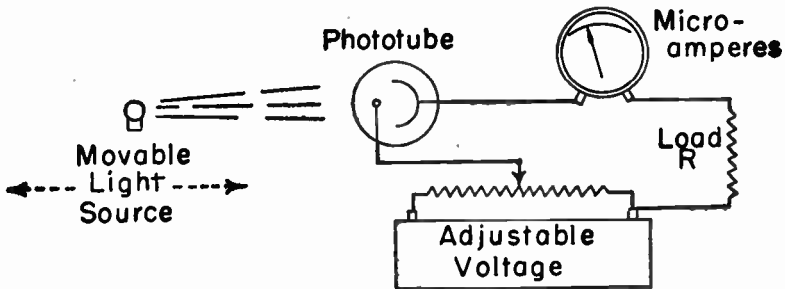

Fig. 10.—Current in a vacuum phototube at various anode voltages.

With increase of voltage the space charge is reduced, and by the time we apply about 20 volts the emitted electrons are being drawn from the cathode as fast as they are emitted. No matter how much greater the anode voltage is made there is little further increase in current so long as the luminous flux remains constant. There is some rise of current because the increasingly

stronger charges on the anode help to slightly increase the emission, but the rise is very slight.

The curve of Fig. 10 is an anode characteristic for a phototube, comparable to a plate characteristic for an amplifier tube operated with some one control grid potential, just as the phototube is being operated with some one luminous flux. Anode characteristics for all vacuum phototubes are shaped like the curve shown here. The current values for certain voltages may differ, but the general form of the curve remains the same. Vacuum phototubes always are operated with anode voltages higher than the value at which the characteristic curve becomes nearly horizontal.

If the luminous flux reaching the phototube now is reduced in steps, and currents measured at various voltages with each value of illumination, we may draw a whole group of anode characteristics, as shown by Fig. 11. Here the top curve, for 0.10 lumen of flux, is the same as the single curve of Fig. 10 although

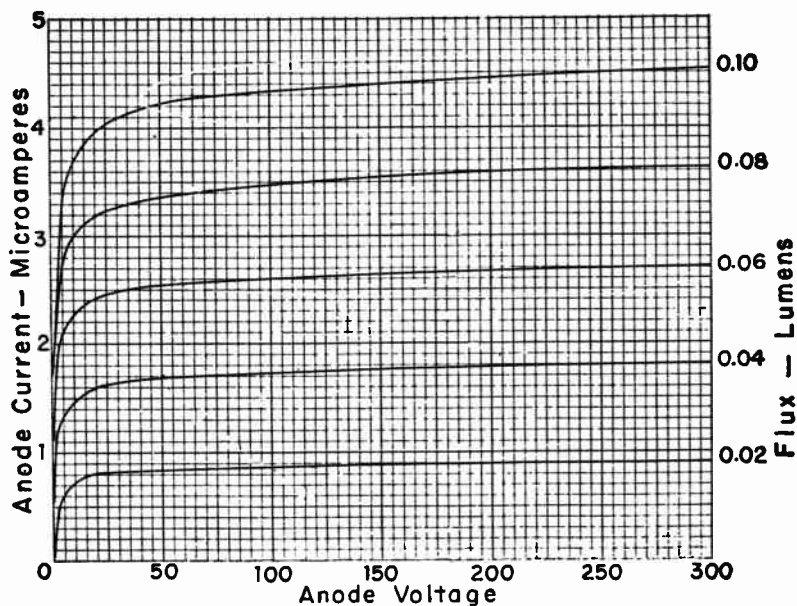

Fig. 11.—A family of anode characteristics for a vacuum phototube.

drawn to different scales. With all voltages at which the curves are nearly horizontal equal changes of illumination cause equal changes of current. To illustrate this valuable property of vacuum phototubes we may check currents at two voltages, as nearly as the currents may be read from the curves.

Flux, lumens	Currents, microamperes	
	At 100 volts	At 250 volts
0.02	0.90	0.87
.04	1.80	1.73
.06	2.70	2.60
.08	3.60	3.47
.10	4.50	4.33

At 250 volts the current changes 0.90 microampere for each change of 0.02 lumens of flux. At 100 volts the current changes are read as either 0.86 or 0.87 microampere and would be 0.865 microampere for each change of 0.02 lumen of flux. Note also that with 250 volts we gain very little in the value of current changes over those obtained with 100 volts. Sensitivity is changed hardly at all by changes of voltage in the normal operating range of voltages. At 250 volts the sensitivity of the tube represented by Fig. 11 is 45 microamperes per lumen, found from dividing any of the current values by the corresponding value of flux in lumens. At 100 volts the sensitivity is about 43 microamperes per lumen.

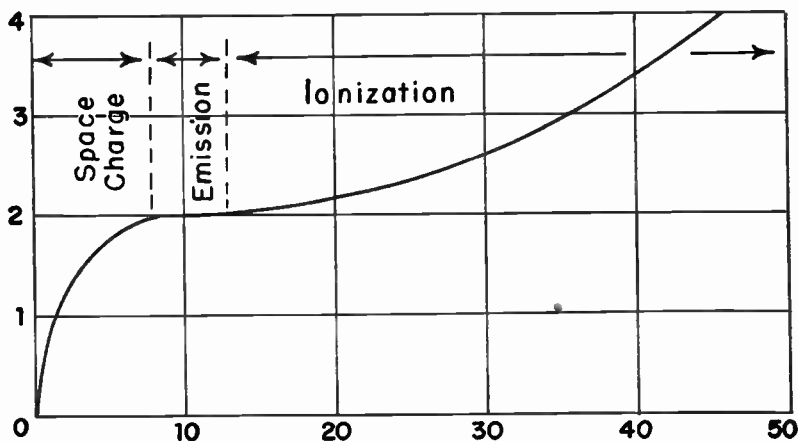

Fig. 12.—Current in a gas phototube at various anode voltages.

Gas Phototubes.—If the apparatus shown at the top of Fig. 10 is used for measurement with a gas phototube, and if measurements are made with care at the lower anode voltages, the characteristic curve will be of the general form shown by Fig. 12. With increase of voltage from zero there is at first a rapid rise of current, just as with the vacuum phototube. Then the characteristic curve levels off, as with a vacuum tube. But instead of remaining nearly horizontal with still higher voltages the anode current curve commences to rise, and the higher the voltage the faster the current increases.

Current at lowest voltages is taken largely from the space charge near the phototube cathode. Then, through the flat part of the curve, the anode current is "emission limited," with all electrons drawn to the anode as fast as emitted from the cathode. The following rise of current results from ionization of gas which is in the phototube envelope. As the anode voltage is increased the emitted electrons are accelerated to greater velocities, colliding more forcefully with gas atoms to increase the rate of ioniza-

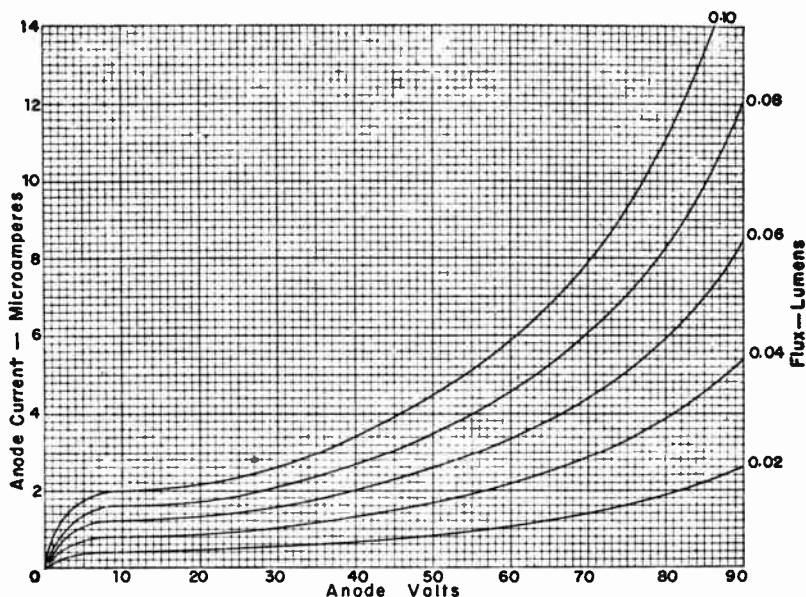

Fig. 13.—A family of anode characteristics for a gas phototube.

tion and the resulting current. There also may be some secondary electron emission from the cathode due to its being bombarded by positive ions.

If the luminous flux in lumens is varied in steps, as when testing the vacuum phototube, and if the anode voltage is varied between zero and 90 volts, there may be drawn a family of anode characteristics for the gas phototube, as in Fig. 13. The curves are of the same general form for all values of illumination. Although there will be variations in exact relations between voltage and current, the anode characteristics for all gas phototubes appear much like those of Fig. 13.

The highest voltage shown for the gas phototubes is 90 volts. At any higher voltage there is great danger that the ionization will become a glow discharge between anode and cathode. Were any of the curves continued into higher and higher voltage values it is plain that current soon would commence to increase at a great rate. The rise of current becomes more rapid with increasing illumination, and since nearly always there is the possibility of excessive illumination it is necessary to limit the voltage.

A glow discharge is shown by a faint purple light inside the tube envelope. Once the glow commences, ionization proceeds by itself and electron emission continues because of cathode bombardment without any need for illumination. Reducing the illumination to zero then has no effect on the discharge. If the tube is to be saved the supply voltage must be cut off instantly. The first few moments of glow discharge will ruin the cathode surface.

Gas phototubes must not be operated without a resistor in series. As current increases with ionization there is an increasing drop of voltage across the resistor and a corresponding reduction of remaining potential difference between anode and cathode of the tube. Minimum values of load resistance usually are between one and four megohms. The required minimum varies with supply voltage and maximum current to be used, and is specified in operating data or instructions for the tubes.

The *gas amplification factor* of a gas phototube is the number of times that current is increased in comparison with the value of current just before ionization commences. For example, the upper curve of Fig. 13 shows current of 2.0 microamperes at the

flat part of the curve (near 10 volts) before there is ionization. At 70 volts on the same curve the current is about 8 microamperes. This is four times the current existing before ionization, and so the gas amplification factor at 70 volts and 0.10 lumen of flux is 4. Gas amplification factors of from 3 to 7 usually are safe to use so far as danger of glow discharge is concerned. At gas amplifications of 8 or 10 there is great danger of glow discharge.

The luminous sensitivity of the gas phototube may be found from dividing the number of microamperes of current by the lumens of flux, which gives microamperes per lumen. If we make such divisions with values of current and corresponding flux

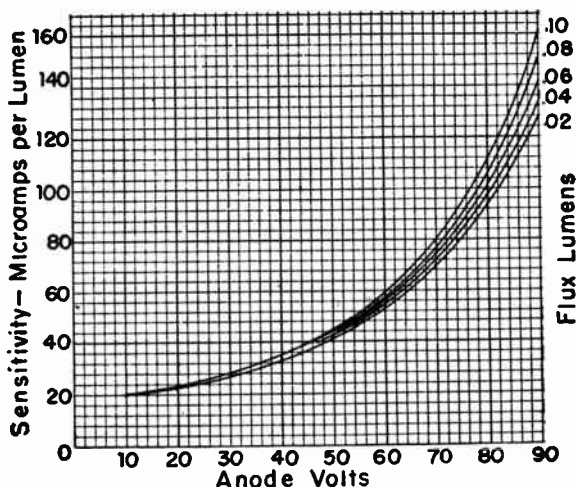

Fig. 14.—How sensitivity of a gas phototube changes with variations of anode voltage and luminous flux.

shown by Fig. 13 the results will give sensitivities at the various illuminations and various anode voltages. Using these values of sensitivity on a graph will give the curves of Fig. 14. Here there are five curves, one for each of the five values of luminous flux.

The sensitivity of the gas phototube becomes somewhat greater as the illumination is increased through the range cov-

ered by Fig. 14, but this increase of sensitivity is relatively large only at the higher anode voltages. All the curves get closer together as the anode voltage is lowered, and all of them come to the same value at 10 volts, where ionization has not commenced. But the gas phototube shows a great increase of sensitivity as the anode voltage is raised. For example, with 0.10 lumen of flux the sensitivity at 60 anode volts is 60 microamperes per lumen. At 90 volts, with the same luminous flux, the sensitivity has increased to more than 160 microamperes per lumen.

Gas phototubes have an advantage where the illumination levels are low. Under such conditions the greater sensitivity of the gas tube as compared with vacuum types allows greater variations of current and of voltage across the load resistor. Sensitivity of a phototube has much the same significance as mutual conductance of a radio amplifier tube. Mutual conductance in micromhos shows the change in microamperes of plate current caused by a one-volt change in control grid potential. With phototubes the changes of light flux take the place of changes of control grid voltage with the amplifier tube. A phototube having high sensitivity will produce greater change of current for a given change in light flux than will a tube of less sensitivity.

Greater sensitivity does not mean that the gas phototube will handle more current than the vacuum phototube. Maximum permissible currents in both types range from 50 to 150 microamperes per square inch of cathode surface, depending on the kind of cathode and the general construction as it affects heat dissipating ability. Cathode surface areas in commonly used phototubes range from one-quarter square inch to one square inch. The same cathode areas may be found in both gas and vacuum phototubes, and the same cathode surface materials are used in both kinds of tubes. In most phototube applications the light is focused by mirrors and lenses onto a small part of the cathode surface, usually onto an area of something between $1/6$ and $1/3$ of a square inch. With these small areas the maximum permissible currents most often are somewhere between 10 and 30 microamperes for either vacuum types or gas types of phototubes.

If the vacuum tube represented by Fig. 11 is operated at 250

volts and the flux on its cathode changes from 0.02 to 0.04 lumen the current will change from 0.9 to 1.8 microamperes, which is a change of 0.9 microampere. If the gas phototube of Fig. 13 is operated at 90 volts and the light flux is changed from 0.02 to 0.04 lumen the current will change from 2.6 to 5.4 microamperes, which is a change of 2.8 microamperes. The change of current with this particular gas phototube is more than three times the change secured from the same variation of illumination with the particular vacuum phototube being considered. We shall find that sensitivity of gas phototubes may be greater than that of vacuum types when operation is at low levels of illumination, also when the load resistance in the phototube circuit must be less than about ten megohms.

Effects of Load Resistance.—In nearly all practical applications of phototubes we wish to have changes of light cause corresponding changes of current and voltage in the load resistance which is in series with the phototube. Then the changes of voltage across this resistance may be used in the control grid circuit of a following tube, or the changes of current may be read with a microammeter or may operate a sensitive relay. We are not so greatly interested in total values of current and voltage as in the changes which result from variations of light. That is, a

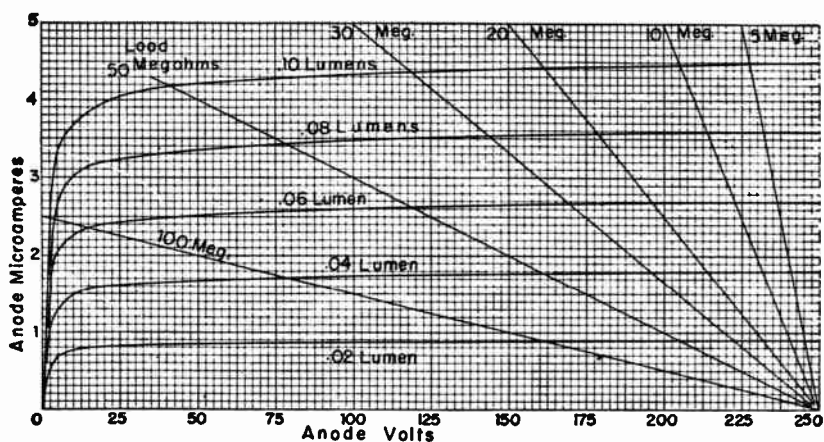

Fig. 15.—Load lines on the anode characteristics of a vacuum phototube

change of five volts is just as useful for a following grid circuit when this change is between 10 volts and 15 volts as when it is between 50 volts and 55 volts.

As we know, a given change of current will be accompanied by a much greater change of voltage across a large resistance than across a small resistance. To observe what happens to currents and voltages in load resistances when there are changes of light we draw load lines for various load resistances on a family of anode characteristics for the phototube being investigated. The load lines are drawn in exactly the same manner as on a family of plate characteristics for an amplifier tube when we wish to measure the effects of variations in control grid voltage. In Fig. 15 we have the same anode characteristics as in Fig. 11, these being the characteristics of a certain vacuum type phototube. On the graph have been drawn load lines for load resistances from five to 100 megohms. It is assumed that the source of potential and current furnishes 250 volts, making all of the load lines start upward from 250 volts and zero current on the graph.

From Fig. 15 we may read the changes of anode current and anode voltage resulting from a change of luminous flux between any of the lumen curves with a load resistance of any of the values for which lines are drawn. As an example, supposing that we have a 50-megohm load resistance and a change of flux from 0.06 to 0.04 lumen. On the 50-megohm load line we read at the intersection of the 0.06 lumen curve an anode voltage of 118.5, and at the 0.04 lumen curve read 161.0 volts. Then the change of voltage at the tube is the difference, or is 42.5 volts. At the same intersections we read anode currents of 2.63 and 1.78 microamperes. The difference is 0.85 microampere, which is the change of anode current and of load current.

Voltages read from Fig. 15 are anode voltages, which are voltage drops between anode and cathode in the phototube. The voltage drop across the load always must be the difference between the source voltage and the anode voltage. For instance, if the source furnishes 250 volts, and if 161 volts are being used across the phototube, then the remainder of 89 volts must be used across the load resistance. In the example just given we had voltages of 118.5 and 161.0, which are anode voltages. Sub-

tracting each of these from the source voltage of 250 leaves 131.5 and 89.0 volts, which are the corresponding voltages across the 50-megohm load.

In Fig. 16 are shown voltages across all the load resistances of Fig. 15, for all of the luminous fluxes. If you read from Fig. 16 the load voltages on the 50-megohm load curve at fluxes of 0.06 and 0.04 lumen the voltages will be 131.5 and 89.0 volts, just as previously computed.

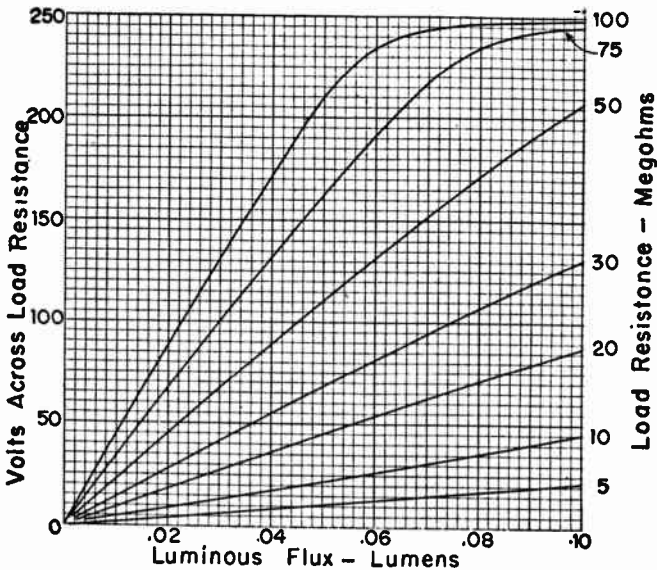

Fig. 16.—Voltages across load resistances at various values of luminous flux on a vacuum phototube.

Fig. 16 shows that load voltage for any flux increases directly with increase of load resistance so long as we stay on the fairly straight portions of the curves. Furthermore, the changes of load voltage for any given change of light flux increase almost directly with increase of load resistance so long as we don't get onto the bend of the curves.

If you compare Figs. 15 and 16 it becomes plain that the bends

of the curves of Fig. 16 occur where the tube is operating space charge limited rather than emission limited. Were the supply voltage increased to more than 250 volts all of the load lines on Fig. 15 would move to the right, with no change in the slope of the lines. At about 450 source volts the 100-megohm load line would cross even the 0.10 lumen curve on the horizontal portion of this curve and we would get rid of the bend at the top of the 100-megohm curve of Fig. 16. On the other hand, were the source voltage lowered in value, the load lines for 50 megohms and still lower resistances would show sharp bends on Fig. 16. We may make this conclusion: The greater the level of light flux and the greater the load resistance, the higher must be the source voltage to have changes of load voltage proportional to changes of light. Conversely, for low levels of light and for small load resistances we will have proportional changes with relatively small source voltages.

Fig. 17 shows still another set of curves derived from the load lines for the vacuum phototube of Fig. 15. Here we show,

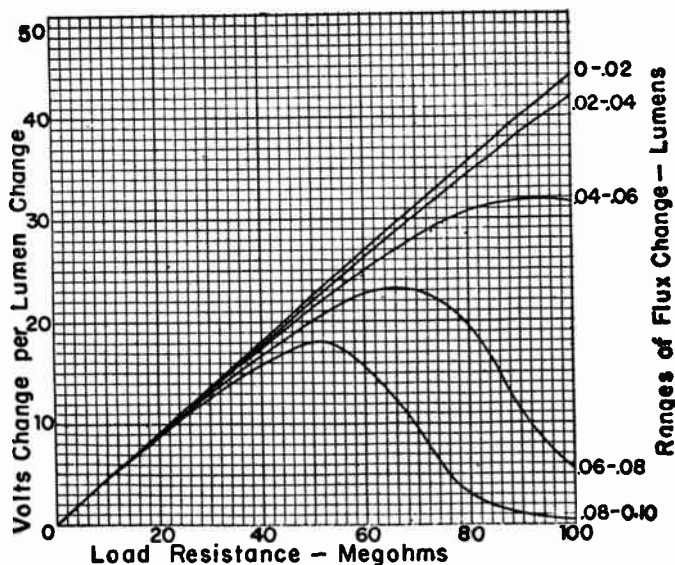

Fig. 17.—Changes of load potential, in volts per lumen of flux change, with a vacuum phototube.

on the left-hand vertical scale, the *changes* of load voltage per lumen change of light flux with loads between zero and 100 megohms and when the light changes occur at various levels of illumination. Consider first the top curve, applying when the change of light occurs somewhere in the range between zero light and a flux of 0.02 lumen. Assume that the load resistance (bottom scale) is 60 megohms. The *change* of load voltage will be 27 volts per lumen of light *change*. Supposing that the actual change of illumination is from 0.008 lumen down to 0.003 lumen, which is a change of 0.005 lumen. Multiplying 27 (volts per lumen) by 0.005 gives 0.135, which will be the *change* of voltage in the 60-megohm load for the specified change of illumination.

So long as we work within illumination levels from zero to 0.04 lumen we are working on the two upper curves of Fig. 17. Then changes of voltage with changes of light increase steadily as we use higher and higher load resistances, all the way to a resistance of 100 megohms. But supposing that we are working with light levels between 0.04 and 0.06 lumen. Then there is no object in using more than about 80 megohms of load resistance, because at still greater resistances we are not going to appreciably increase the changes of voltage for given light fluctuations—this being shown by the leveling off of the curve.

If the changes of illumination are within the level of 0.06 to 0.08 lumen we obtain more and more voltage change with load resistances up to about 65 megohms, but at still higher resistances the voltage change becomes less than at 65 megohms. With light changes occurring between 0.08 and 0.10 lumen the peak of the voltage-change curve is at about 50 megohms, and with still higher resistances the changes of voltage for given light changes become less and less until they are nearly zero at 100 megohms. The lower the level of illumination, and also the smaller the changes of illumination, the higher may be the load resistance and the greater will be the voltage change for any given light change. Excessively high load resistances are worse than useless for high levels of illumination and for large changes.

We have examined the performance of a vacuum phototube whose behavior is quite typical of all vacuum phototubes. Now let's examine the performance of a gas phototube as it is affected by load resistances. Fig. 18 shows a family of anode character-

istics for a gas phototube which is comparable with the vacuum type just observed, this because the currents at various fluxes are about the same before ionization commences in the gas phototube. On the anode characteristics have been drawn load lines for various load resistances between one and 20 megohms. The source is assumed to furnish 90 volts, which is the maximum permissible source voltage for most gas phototubes. Consequently, all the load lines start upward from 90 volts and zero current on the graph.

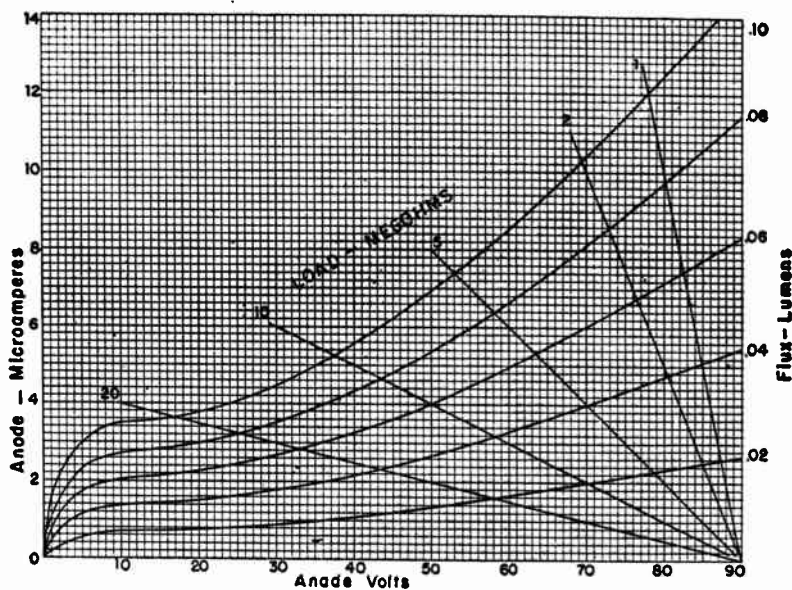

Fig. 18.—Load lines on the anode characteristics of a gas phototube.

By dividing the currents by lumens of flux at the intersections of the load lines it is possible to compute sensitivities in microamperes per lumen for various fluxes and load resistances. Sensitivities thus computed for the gas phototube are shown by Fig. 19, for loads between one and 20 megohms. Each curve applies with the value of light flux marked at the right-hand end

of the curve. From this graph it is apparent that maximum sensitivity is obtained with lowest illumination and with smallest load resistance. With only 0.02 lumen and a load of only one

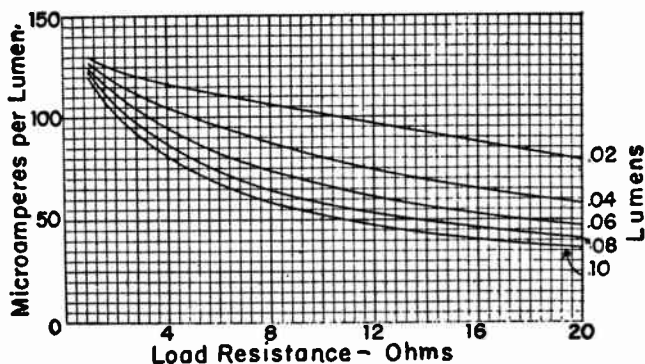

Fig. 19.—Sensitivity of a gas phototube with various load resistances and luminous fluxes.

megohm the sensitivity is 130 microamperes per lumen. With 0.10 lumen and a 20-megohm load the sensitivity is only 36 microamperes per lumen.

Sensitivity of a vacuum phototube remains nearly constant with variations of illumination and load resistance so long as we work the tube on the fairly horizontal portions of the anode characteristics. Sensitivity of the vacuum phototube represented by Fig. 15 remains between 42 and 45 microamperes per lumen for all usual illuminations and currents.

Because of the limited source voltage (usually 90 volts) which may be used with gas phototubes we cannot use very high values of load resistance without having the load lines run onto the space-charge limited parts of the anode characteristics. Although the gas phototube may be operated to have greater sensitivity than the vacuum type, and to produce greater changes of current for a given change of light flux, the accompanying voltages across the load are proportional only to the lower load resistances.

Fig. 20, which applies to the gas phototube, shows voltages across various load resistances, from one to 50 megohms, with luminous fluxes from zero to 0.10 lumen. This graph corresponds to the one of Fig. 16 for the vacuum phototube. Again we find

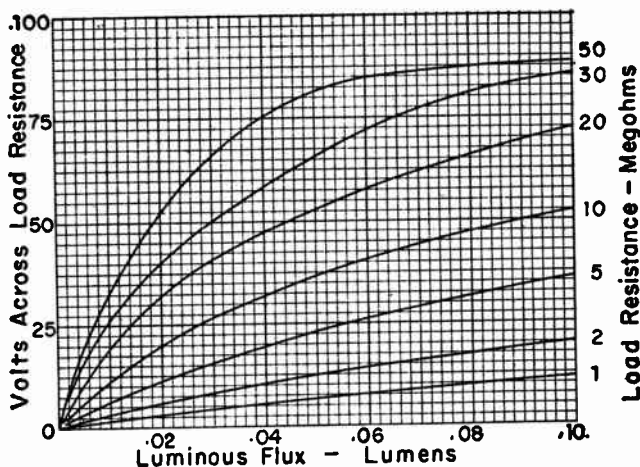

Fig. 20.—Voltages across load resistances at various values of luminous flux on a gas phototube.

that with high levels of illumination and with high-resistance loads the curves undergo sharp bends. Under such conditions the changes of current and of voltage will not be proportional to changes of light flux. The bends on the curves for the gas phototube occur with lesser load resistance than for the vacuum phototube because we are forced to use lower source voltages when operating the gas phototube.

Fig. 21 shows changes of voltage across the load which are caused by changes of light flux on the gas phototube with load resistances from zero to 100 megohms. This graph for the gas phototube corresponds to that of Fig. 17 for the vacuum phototube. When changes of light flux are in the range between zero light and 0.02 lumen the resulting changes of load voltage are shown by the upper curve of Fig. 21. Comparing these voltage

changes at low levels of illumination the gas and vacuum types of tubes we observe that the changes are greater with the gas tube for all load resistances up to about 70 megohms. For instance, with a 20-megohm load the gas phototube gives a change of 16 volts per lumen and the vacuum phototube gives a change of 9 volts per lumen.

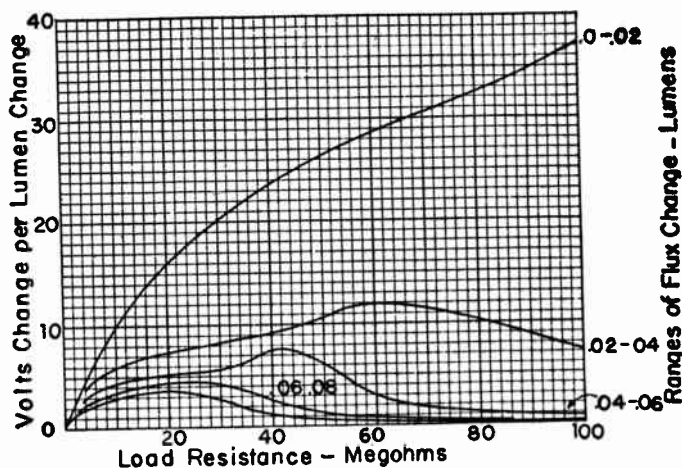

Fig. 21.—Changes of load potential, in volts per lumen of flux change, with a gas phototube.

When changes of light flux occur at higher levels of illumination, shown by the lower curves of Fig. 21, the changes of load voltage drop off rapidly when using the gas phototube. Also there are certain values of load resistance at which the gas phototube produces maximum changes of load voltage in any of the illumination levels. Between 0.02 and 0.04 lumen there is maximum voltage change with a load of about 60 megohms. Between 0.04 and 0.06 lumen the optimum load is about 40 megohms, and at still higher illumination levels there is no advantage in using loads greater than about 20 megohms.

It must be kept in mind that we are examining the performance of one particular gas phototube, and are comparing this performance with that of one particular vacuum phototube. Other

tubes, both gas and vacuum, would have different anode characteristics and different sensitivities. However, our graphs show in a general way what may be expected from gas and vacuum types of phototubes.

Gas phototubes seldom are used with load resistances greater than 20 megohms. To better show the performance with such loads, Fig. 22 is drawn with enlarged scales up to 20 megohms

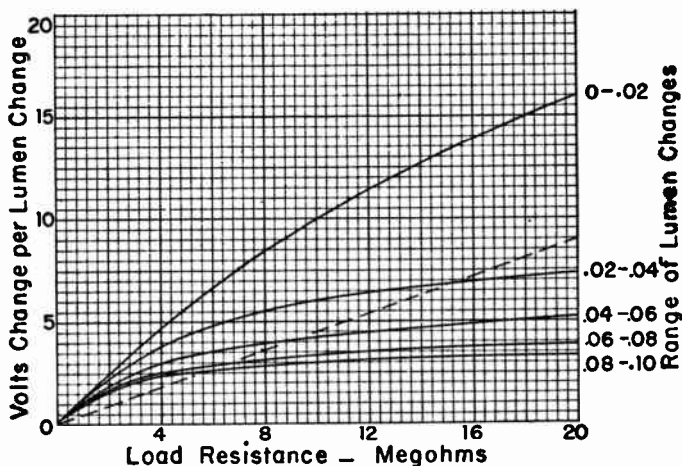

Fig. 22.—Potential changes developed across various loads with a gas phototube (full-line curves) and a vacuum phototube (broken line curve).

load resistance and 20 volts change in the load per lumen change of light flux. The full-line curves on this graph are the same as the full-line curves of Fig. 21 up to a load resistance of 20 megohms. The broken-line curve on Fig. 22 shows the performance of our vacuum phototube in the same range of load resistances. This broken-line curve is taken from Fig. 17.

For all combinations of illumination levels and load resistances with which curves for the gas phototube of Fig. 22 are above the curve for the vacuum phototube this particular gas tube would produce greater changes of voltage for any given change of light flux than would the particular vacuum phototube considered.

The gas phototube is more effective than the vacuum phototube with all load resistances less than about six megohms, regardless of the illumination level. Also, the gas phototube is more effective than the vacuum type at low levels of illumination, regardless of the load resistance until we reach resistances around 70 megohms (Fig. 21). It is general practice to use gas phototubes when the changes of light must occur at low levels, and to use vacuum phototubes for higher illumination levels. And it is general practice to use gas phototubes when the load resistance may be no greater than 10 to 20 megohms, and to use vacuum phototubes when the load resistance may be greater than these values.

Vacuum phototubes have the advantages of maintaining their sensitivity better than gas types over long periods of use, and of being less subject to damage from excessively high illumination and from anode voltages higher than normal values.

Frequency Effects.—When light on the cathode of a phototube is not steady, but varies at differing amplitudes above and below some average value we have the same type of conditions as when an alternating signal potential is applied to the control grid of an amplifier tube. The phototube, in effect, amplifies variations of light with an output consisting of voltage variations across the load resistance. Phototubes are used in this manner for "sound on film" reproduction of sound in motion pictures, and in any other applications where rapid variations of light are to cause corresponding variations of voltage or current in an electric circuit.

Gas phototubes are in common use for sound reproduction, because of the high sensitivity of such tubes at low levels of illumination. A gas phototube depends on ionization for its high sensitivity. Ionization is not an instantaneous process, although nearly so. Deionization requires much longer than ionization, but still may take less than one thousandth of a second. A greater delay results from the time required for positive ions to travel to the cathode, where they promote electron emission. As a result of these processes in ionization the gas phototube cannot respond instantaneously to changes of light.

At light frequencies lower than one or two hundred cycles per second the delay in response of a gas phototube hardly is meas-

urable. At higher frequencies the delay results in a loss of sensitivity. Fig. 23 shows this loss for a typical gas phototube. The decrease of sensitivity is shown in decibels of voltage "down" from the zero reference level, this being a convenient means of measurement since the effect is important chiefly in the repro-

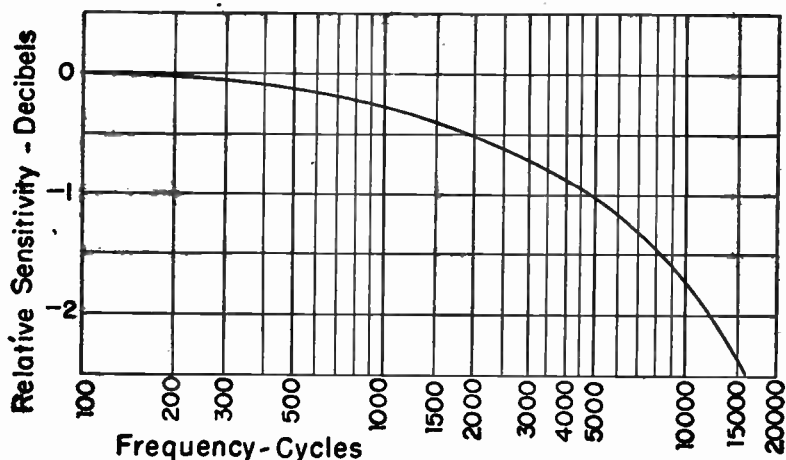

Fig. 23.—How sensitivity of a gas phototube drops off with increasing frequency of light variations.

duction of audio frequencies. An a-f amplifier may be given a rising frequency characteristic to compensate for the drop in phototube output.

In vacuum phototubes there is no ionization, or, at most, a negligible amount. Consequently, the vacuum phototube will respond with nearly constant sensitivity at frequencies even into the radio range. However, the circuit used with a vacuum phototube may not have uniform frequency response. The high resistance of the load in combination with the effective anode-cathode capacitance of the phototube may give a rather long time constant. Were the tube capacitance 2.5 micro-microfarads, a fairly typical value, and were the load resistance 50 megohms, the time constant would be 0.000125 second. This is a time period corresponding to a frequency of 8,000 cycles per second. Capacitances of socket and wiring may further increase the time con-

stant with both vacuum and gas phototubes. Long time constants tend to even off the variations of output voltage and to thus reduce the sensitivity of the circuit when there are rapid changes of light.

Phototube Ratings and Characteristics.—In the descriptive listings of phototubes published by their manufacturers are various specifications and limits within which operation must be maintained to avoid permanently damaging the tubes. Some or all of the following items may be covered.

1. *Voltage.* Either the maximum anode voltage or the maximum supply voltage. This voltage limit refers either to a d-c voltage or to the peak a-c voltage. An r-m-s or effective a-c voltage must be only 0.707 of the peak a-c voltage listed when the voltage is of sine wave form.

2. *Current.* Either the maximum current in microamperes per square inch of cathode surface or else the maximum microamperes with some specified portion of the cathode area in use.

3. *Load resistance.* The minimum load resistance to be used with certain voltages and sometimes with certain limiting values of light flux.

4. *Dark current.* When voltage is applied to a phototube with no light on the cathode there is normal leakage current of a small fraction of a microampere. This is called dark current. The same information may be given as leakage resistance in megohms, from which it is possible to compute the dark current when knowing the anode voltage.

5. *Capacitance.* The capacitance between anode and cathode of the phototube usually is on the order of 2.0 to 2.5 micro-microfarads.

6. *Temperature.* The ambient temperature, which is the temperature of surrounding air and nearby objects. The limit usually is 100° C, which is 212° F.

7. *Cathode surface.* The kind of cathode surface with reference to its response to various wavelengths of radiant energy. Type numbers of surfaces would refer to response curves such as shown by Fig. 8 in this chapter.

8. *Luminous sensitivity.* The sensitivity in microamperes per lumen with certain specified operating voltage, light source, and lumens of flux on the cathode. Without knowing the conditions

with which the sensitivity is measured its value has little real meaning. Luminous sensitivity usually is specified for zero cycles, meaning light of unchanging value, and also at certain frequencies up to 10,000 cycles. These latter values would give information such as shown by Fig. 23.

9. *Radiant sensitivity.* Sensitivity in microamperes per microwatt of radiant energy either within or outside of the visible spectrum. Conditions of measurement must be specified, just as for luminous sensitivity.

10. *Gas amplification factor.* Either the maximum gas amplification factor which may be used without danger of glow discharge damaging the cathode surface, or the factor at which the tube is operated for some of the listed values.

11. *Cathode area.* The height and effective width of a semi-cylindrical cathode, the diameter of a circular (end-on) cathode, or other dimensions from which may be computed the area of the sensitive surface exposed to light. With semi-cylindrical cathodes the measured width is from side to side at the edges, not the distance around the curved surface. The effective area of

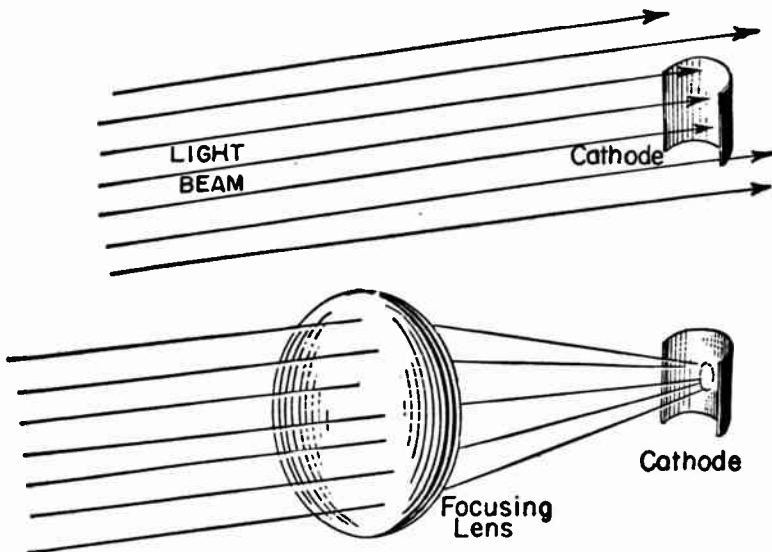

Fig. 24.—A cathode may intercept only part of a light beam, or a greater part of the beam may be focused onto the cathode.

a half cylinder would be the height by the diameter, not the height by half the circumference. It is "projected" areas which count.

Cathode Areas and Lumens.—At the top of Fig. 24 is shown a phototube cathode on which falls light from a beam in which the rays are practically parallel, as would be the case with light from a distant source. Light such as this usually is measured with a photoelectric light meter whose scale is graduated either in lumens per square foot or in foot-candles, which mean the same thing. The cathode does not intercept the whole light beam. To measure illumination on the cathode we would hold the light meter as near as possible to the cathode and point it toward the source of light. Were the reading of the meter in foot-candles the number of lumens on the cathode could be determined from this formula.

$$\text{Lumens on cathode} = \frac{\text{foot-candles} \times \text{cathode area, sq. inches}}{144}$$

When light comes solely from a single lamp bulb the illumination at three feet from an ordinary 100-watt inside frosted incandescent lamp is about 23 foot-candles. From a 60-watt lamp the illumination at three feet is about 11.5 foot-candles, and from a 40-watt lamp it is about 6.7 foot-candles. Probably you can turn on one or the other of such lamps to see just what these illuminations look like.

Cathode areas in types of phototubes most often used range from 0.2 to 2.0 square inches. This is the effective or projected area, as it would appear looking straight toward the open side of the cathode. Supposing we are using a phototube having a cathode area of 0.5 square inch at three feet from a 60-watt incandescent lamp furnishing 11.5 foot-candles of illumination at this distance. Placing these values in the formula gives,

$$\text{Lumens on cathode} = \frac{11.5 \times 0.5}{144} = \frac{5.75}{144} = 0.04 \text{ lumen, approx.}$$

With this computed value of luminous flux we could go to the anode characteristics of our tube, draw suitable load lines, and find how the tube should perform.

At the bottom of Fig. 24 we have placed a focusing lens be-

tween the light source and the phototube cathode, and are focusing a beam of light onto a small spot on the cathode surface. Let's assume that the exposed diameter of the lens is 2.5 inches. Then the exposed area is about 4.9 square inches. If the illumination at the lens position is 11.5 foot-candles, as at the cathode in the preceding example, we may use lens area instead of cathode area in our formula to determine the lumens of flux falling on the lens.

$$\text{Lumens on lens} = \frac{11.5 \times 4.9}{144} = \frac{56.35}{144} = 0.39 \text{ lumen, approx.}$$

Cathode areas on which light beams are focused often are about 0.2 square inch. With 0.39 lumen of flux on 0.2 square inch of cathode the rate would be 1.95 lumen per square inch, well within the permissible cathode loading for any phototube. But the flux on the cathode would not be as much as 0.39 lumen because all lenses absorb more or less light energy. Depending on the quality and number of elements in the lens assembly the absorption may be from 10 to 50 per cent, leaving from 90 to 50 per cent of the original light to fall on the cathode surface.

Phototube Amplifiers.—Variations of phototube current resulting from changes of illumination are only a few microamperes at most. These currents may be read directly with a sensitive microammeter or galvanometer. Appreciable variations of output voltage are obtained only with loads of high resistance, with which the shunting effect of any ordinary voltmeter prevents useful measurements. The phototube load resistor may be connected across the input of any direct-current type of electronic voltmeter, and if the input resistance of the voltmeter is several times the load resistance the voltage readings will follow changes of illumination. With many of the circuits used for electronic voltmeters the phototube load resistor may form the resistance across the first control grid circuit of the voltmeter itself. Then the change of voltage in the load resistor is measured by the electronic voltmeter without any reduction due to having the load resistor and voltmeter input resistance in parallel with each other.

There are a number of fairly simple and inexpensive phototube amplifier circuits employing a single amplifier tube whose

plate current changes are great enough to read on a milliammeter or to operate a sensitive relay. Either vacuum or gas phototubes may be used. Amplifier plate current may be made to either increase or decrease with increase of illumination on the phototube, and a relay may be made to close with either increase or decrease of phototube illumination.

Fig. 25 shows a circuit which may be used with either a vacuum or a gas phototube. The amplifier tube should be a sharp cutoff voltage amplifying pentode, with the screen grid connected to the plate and the suppressor grid connected to the

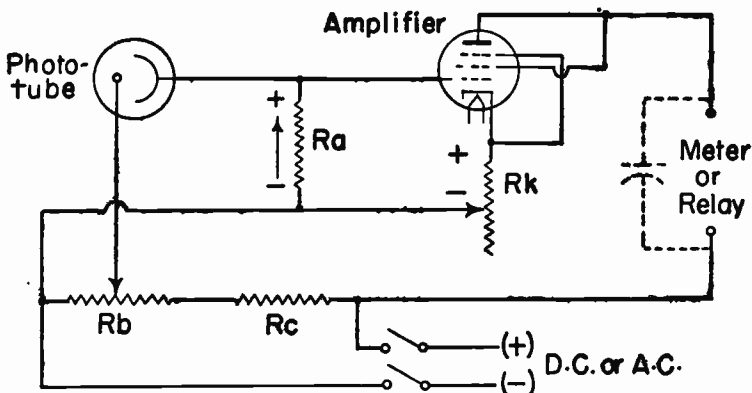

Fig. 25.—A phototube amplifier of the forward type, with which plate current increases with light.

cathode as indicated. Resistor Rk provides adjustable cathode bias for the amplifier tube. A d-c plate power supply source may be connected between the two lower outside terminals with polarity as indicated. Otherwise these two terminals may be connected to a 110-120 volt a-c lighting circuit.

When operating from an a-c line we are making use of the rectifying properties of the amplifier and the phototube. Electron flow in the tubes can occur only while the amplifier plate and phototube anode are positive with reference to the cathodes. Consequently, there will be electron flow only during the a-c half-cycles in which the lower right-hand terminal is positive and the left-hand terminal negative. During the opposite half-cycles

of supply voltage there is no electron flow. Thus the output for the meter or relay in the amplifier plate circuit consists of one-way pulses of current at the supply frequency. The output is pulsating direct current. To prevent vibration of the meter pointer or chattering of the relay contacts it may be necessary to use a smoothing capacitor of one mfd or greater capacitance as shown by broken lines.

With no light on the phototube cathode the amplifier plate current is dependent on plate voltage and the negative grid bias furnished by resistor Rk . The phototube cathode is connected through load resistor Ra to the negative side of the power supply. The phototube anode is connected to the slider of voltage divider Rb , consequently is positive with reference to the cathode. When light reaches the phototube cathode surface the electron flow in the phototube circuit is upward through Ra and from cathode to anode in the phototube. The upper end of Ra becomes positive with reference to its lower end. Both Ra and Rk are in the control grid circuit of the amplifier tube, with the potential across Ra opposing that across Rk . The greater the luminous flux on the phototube cathode the greater is the voltage across Ra , and the control grid of the amplifier becomes proportionately less negative with reference to the amplifier cathode. Then amplifier plate current increases with increase of illumination on the phototube.

For a vacuum phototube Ra may be of 10 to 30 megohms resistance, and for a gas phototube of one to 10 megohms resistance. Bias resistor Rk should be adjustable between 200 and 2,000 ohms. Power dissipation in Rk will be less than one watt. For a gas phototube Rb is 5,000 ohms and Rc is 5,000 or 5,200 ohms, each of 2-watt rating. For a vacuum phototube Ra is 2,000 ohms, 1 watt, and Rc is 8,000 or 8,200 ohms, 2 watts.

Either Rb or Rk or both may be adjusted to vary the sensitivity, by which we here mean the change of amplifier plate current for a given change of phototube illumination. For maximum sensitivity the resistance required at Rk will increase with increase of load resistance at Ra . Resistor Rk varies the sensitivity by changing the amplifier grid bias and mutual conductance, while Rb acts to change the voltage applied to the phototube.

Fig. 26 shows a circuit with which amplifier plate current

decreases when phototube illumination increases, and vice versa. Note that here the phototube anode is connected to the amplifier control grid, which is a common characteristic of "reverse" phototube circuits with which amplifier plate current changes oppositely to phototube luminous flux. In Fig. 25 the phototube cathode is connected to the amplifier control grid, which is characteristic of "forward" circuits with which illumination and amplifier plate current change in the same direction.

The circuit of Fig. 26 may be used with either vacuum or gas phototubes. The amplifier again is a sharp cutoff voltage amplifying pentode. Values of phototube load resistor R_a are the same as with Fig. 25. The power source may be either a d-c type or a 110-120 volt a-c lighting line. Total voltage from the source now

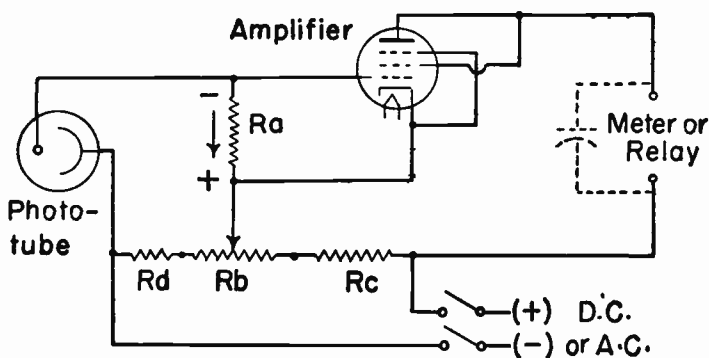

Fig. 26.—A reverse phototube amplifier, with which plate current decreases as light increases.

is divided between the amplifier plate-cathode path and the phototube anode-cathode path. Adjustable resistor R_b varies the division of supply voltage between the two tubes and controls the sensitivity or the ratio of amplifier plate current change to phototube luminous flux change.

With no light on the phototube of Fig. 26 there is negligible current in R_a and there is zero grid bias for the amplifier tube. Amplifier plate current is limited by the low anode-cathode voltage, which is the voltage drop across resistor R_c and the portion of R_b which is between R_c and the slider on R_b . When light reaches the phototube cathode there is electron flow from cathode

to anode and downward through load resistor R_a . Since R_a is in the amplifier control grid circuit the control grid thus is made more negative and the amplifier plate current is reduced as phototube illumination increases.

For operation on a 110-120 volt a-c line, with either a vacuum or gas phototube, adjustable resistor R_b may be 5,000 ohms, 4 watts. Resistor R_c may be 4,700 ohms, 2 watts, and R_d may be about 250 ohms, $\frac{1}{4}$ watt. Amplifier cathode current flows in R_b and R_d , but not in R_c . All wattage ratings mentioned for this and other circuits are at least twice the actual power dissipation, for cool operation.

The values of resistors R_c for gas phototubes in the photo-amplifier circuits are such that the peak a-c voltage on the phototube anode-cathode path cannot exceed 90 volts. With a 120-volt r-m-s or effective a-c value the peak is nearly 170 volts, and only a little more than half of this may safely be applied to the phototube. Therefore, nearly half of the applied a-c voltage must be dropped in R_c before reaching the phototube anode-cathode connections.

Relay Operation.—When using a voltage amplifying pentode tube as in Figs. 25 and 26 the *changes* of plate current as measured by a low-resistance meter will be on the order of 1.0 to 2.5 milliamperes with a *change* of 0.02 to 0.03 lumen of flux on the phototube cathode. These values are secured only when using phototubes of types having high luminous sensitivities. If a relay is used instead of a meter in the amplifier plate circuit the resistance of the relay winding will reduce the changes of plate current. As a general rule relays requiring more than five to ten milliwatts of power cannot be actuated by the plate current changes. Such relays, and those more sensitive, are quite costly.

The logical type of tube for relay operation is a thyatron. Fig. 27 shows a photo-relay circuit which includes a gas tetrode such as the type 2050. Since the phototube cathode is connected to the thyatron control grid this is a forward circuit which actuates the relay upon increase of phototube illumination. Phototube electron flow is upward through load resistor R_a which is in the control grid circuit of the thyatron. At some certain illumination, depending on adjustments, the thyatron control grid is made sufficiently positive or enough less negative to cause

breakdown, whereupon the thyatron passes a current much greater than may be had with vacuum voltage amplifiers.

The circuit shown is designed for operation on a 110-120 volt a-c lighting line. Conduction in the thyatron and phototube occurs only while their anodes are positive. Therefore, conduc-

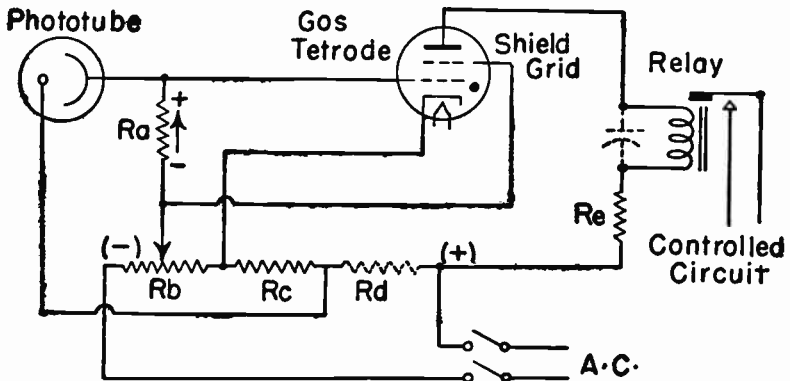

Fig. 27.—A forward photo-relay circuit employing a gas tetrode.

tion will continue and the relay will be pulled in only so long as the phototube maintains the thyatron grid sufficiently positive to cause breakdown on every positive half-cycle of supply voltage. When the grid is less positive, due to less illumination on the phototube, ionization ceases on the first negative half-cycle and does not recur until the grid again is made positive.

Anode-cathode voltage for the thyatron is the voltage drop across resistors Rc and Rd in series. The shield grid is connected to the slider on resistor Rb . Moving the slider to the left makes both the shield grid and the control grid more negative with reference to the cathode, while moving the slider to the right makes both grids less negative. Thus breakdown of the thyatron is brought within the range of voltage changes on the thyatron control grid which are available from phototube current in Ra . The more negative the shield grid the greater must be the change of voltage on the control grid to cause breakdown. With some thyatrons the shield grid may be connected directly to the cathode and Rb used only for varying the degree of negative bias on the control grid.

To adjust this photo-relay the phototube is illuminated to the degree which is to cause operation of the relay. Then the slider on R_b is adjusted so that the thyatron just breaks down. With any less light on the phototube the relay will not be actuated, and with any more light the relay will be actuated.

The resistance at R_a should be no greater than 10 megohms with either vacuum or gas phototubes. Adjustable resistor R_b should be 5,000 ohms. Its power rating depends chiefly on relay and thyatron current which is carried through the left-hand end of this resistor, plus about 6 milliamperes of supply line current. Ratings of two to ten watts will be required here. For a gas phototube resistor R_c is 6,000 or 6,200 ohms, 1 watt minimum, and R_d is 9,000 or 9,100 ohms, 1 watt. For a vacuum phototube R_c is 15,000 ohms, 1 or 2 watts, and no resistance is used at R_d . With a low-resistance relay resistor R_e is of such value as will limit the current to the safe maximum for the relay winding. As a general rule no resistance is needed at R_e .

Fig. 28 shows a reverse phototube circuit using a gas tetrode of the 2050 type. Note that the phototube anode is connected to the thyatron control grid, so that increased phototube illumination makes the thyatron grid sufficiently negative to prevent conduction. Thus the relay drops out with increase of illumination. The values of all resistors may be the same for either vacuum or gas phototubes, although R_a often is made less than 10 megohms for gas phototubes and 10 to 20 megohms for vacuum types. Resist-

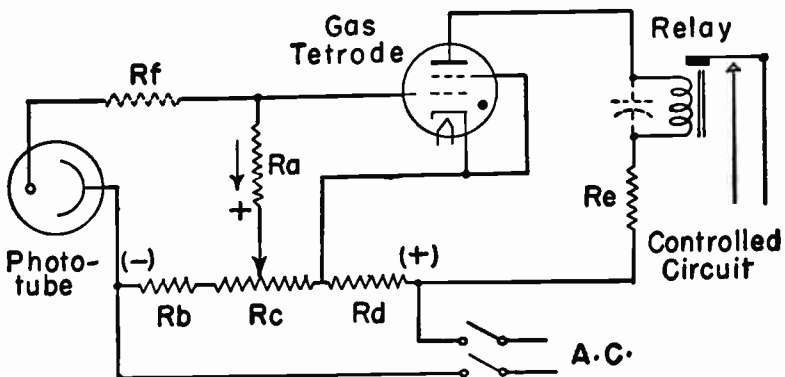

Fig. 28.—A reverse photo-relay circuit employing a gas tetrode.

or R_b may be 250 to 500 ohms, 1 watt. Adjustable control resistor R_c is of 1,000 ohms, 2-watt rating. Resistor R_d is 18,000 ohms, 2 watts. Resistor R_e , which limits relay current and thyatron plate current, is of a value suited to the relay, or this unit may not be required with relays having more than two or three thousand ohms resistance in the winding. Resistor R_f is used only with gas phototubes to prevent a glow discharge due to excessive voltage with the phototube illuminated. This resistor should have a value between 0.2 and 0.5 megohm, the higher value being needed when load resistance R_a is in the neighborhood of 10 megohms.

In all of the amplifier and relay circuits the phototube load resistor, which is in the amplifier grid circuit, should be of the least resistance which will give satisfactory operation at light levels to be employed. Even in the vacuum types of amplifier tubes there are traces of gas which may be ionized. Resulting small gas currents in high resistances of the grid circuit tend to make the grid positive. Likelihood of ionization is lessened by low voltages on plates and screen grids of amplifiers, and by operating cathode heaters or filaments at voltages slightly less than rated values. But no matter what the operating conditions for the amplifier, high resistances in the control grid circuit may cause unstable operation.

The phototube may be used on the end of a two-conductor cable leading to the amplifier and the meter or relay. With a d-c supply for the phototube the cable may be of almost any length provided it has good insulation. With self-rectifying operation

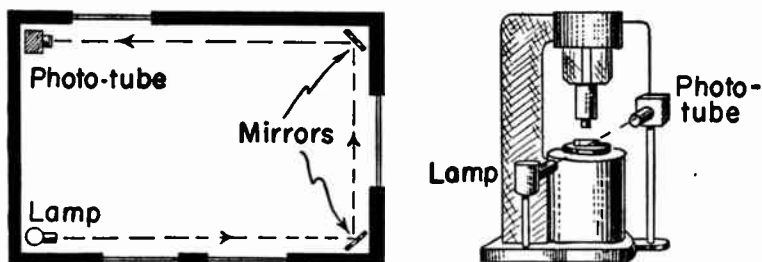

Fig. 29.—A phototube burglar alarm (left) and safety guard for machines (right).

to anode and downward through load resistor R_a . Since R_a is in the amplifier control grid circuit the control grid thus is made more negative and the amplifier plate current is reduced as phototube illumination increases.

For operation on a 110-120 volt a-c line, with either a vacuum or gas phototube, adjustable resistor R_b may be 5,000 ohms, 4 watts. Resistor R_c may be 4,700 ohms, 2 watts, and R_d may be about 250 ohms, $\frac{1}{4}$ watt. Amplifier cathode current flows in R_b and R_d , but not in R_c . All wattage ratings mentioned for this and other circuits are at least twice the actual power dissipation, for cool operation.

The values of resistors R_c for gas phototubes in the photo-amplifier circuits are such that the peak a-c voltage on the phototube anode-cathode path cannot exceed 90 volts. With a 120-volt r-m-s or effective a-c value the peak is nearly 170 volts, and only a little more than half of this may safely be applied to the phototube. Therefore, nearly half of the applied a-c voltage must be dropped in R_c before reaching the phototube anode-cathode connections.

Relay Operation.—When using a voltage amplifying pentode tube as in Figs. 25 and 26 the *changes* of plate current as measured by a low-resistance meter will be on the order of 1.0 to 2.5 milliamperes with a *change* of 0.02 to 0.03 lumen of flux on the phototube cathode. These values are secured only when using phototubes of types having high luminous sensitivities. If a relay is used instead of a meter in the amplifier plate circuit the resistance of the relay winding will reduce the changes of plate current. As a general rule relays requiring more than five to ten milliwatts of power cannot be actuated by the plate current changes. Such relays, and those more sensitive, are quite costly.

The logical type of tube for relay operation is a thyatron. Fig. 27 shows a photo-relay circuit which includes a gas tetrode such as the type 2050. Since the phototube cathode is connected to the thyatron control grid this is a forward circuit which actuates the relay upon increase of phototube illumination. Phototube electron flow is upward through load resistor R_a which is in the control grid circuit of the thyatron. At some certain illumination, depending on adjustments, the thyatron control grid is made sufficiently positive or enough less negative to cause

breakdown, whereupon the thyatron passes a current much greater than may be had with vacuum voltage amplifiers.

The circuit shown is designed for operation on a 110-120 volt a-c lighting line. Conduction in the thyatron and phototube occurs only while their anodes are positive. Therefore, conduc-

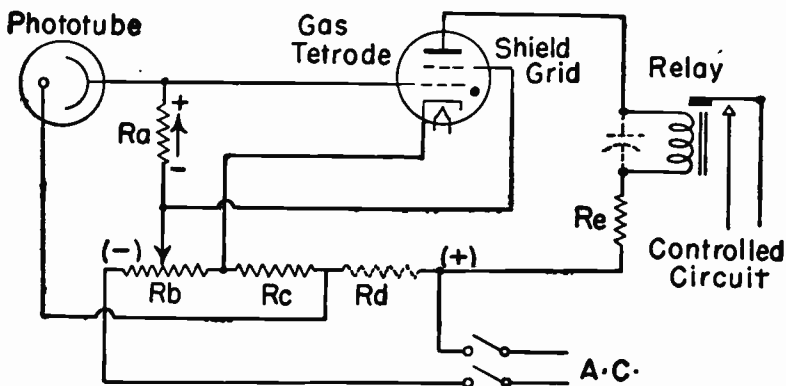

Fig. 27.—A forward photo-relay circuit employing a gas tetrode.

tion will continue and the relay will be pulled in only so long as the phototube maintains the thyatron grid sufficiently positive to cause breakdown on every positive half-cycle of supply voltage. When the grid is less positive, due to less illumination on the phototube, ionization ceases on the first negative half-cycle and does not recur until the grid again is made positive.

Anode-cathode voltage for the thyatron is the voltage drop across resistors R_c and R_d in series. The shield grid is connected to the slider on resistor R_b . Moving the slider to the left makes both the shield grid and the control grid more negative with reference to the cathode, while moving the slider to the right makes both grids less negative. Thus breakdown of the thyatron is brought within the range of voltage changes on the thyatron control grid which are available from phototube current in R_a . The more negative the shield grid the greater must be the change of voltage on the control grid to cause breakdown. With some thyatrons the shield grid may be connected directly to the cathode and R_b used only for varying the degree of negative bias on the control grid.

or R_b may be 250 to 500 ohms, 1 watt. Adjustable control resistor R_c is of 1,000 ohms, 2-watt rating. Resistor R_d is 18,000 ohms, 2 watts. Resistor R_e , which limits relay current and thyatron plate current, is of a value suited to the relay, or this unit may not be required with relays having more than two or three thousand ohms resistance in the winding. Resistor R_f is used only with gas phototubes to prevent a glow discharge due to excessive voltage with the phototube illuminated. This resistor should have a value between 0.2 and 0.5 megohm, the higher value being needed when load resistance R_a is in the neighborhood of 10 megohms.

In all of the amplifier and relay circuits the phototube load resistor, which is in the amplifier grid circuit, should be of the least resistance which will give satisfactory operation at light levels to be employed. Even in the vacuum types of amplifier tubes there are traces of gas which may be ionized. Resulting small gas currents in high resistances of the grid circuit tend to make the grid positive. Likelihood of ionization is lessened by low voltages on plates and screen grids of amplifiers, and by operating cathode heaters or filaments at voltages slightly less than rated values. But no matter what the operating conditions for the amplifier, high resistances in the control grid circuit may cause unstable operation.

The phototube may be used on the end of a two-conductor cable leading to the amplifier and the meter or relay. With a d-c supply for the phototube the cable may be of almost any length provided it has good insulation. With self-rectifying operation

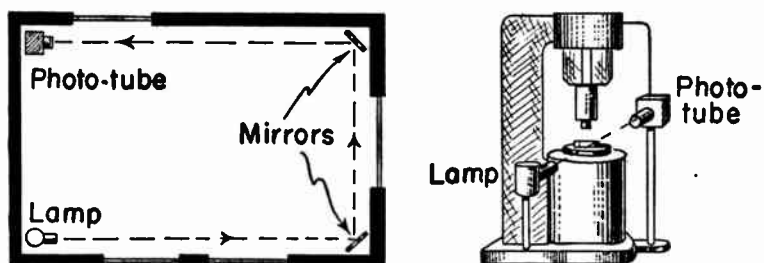

Fig. 29.—A phototube burglar alarm (left) and safety guard for machines (right).

from an a-c line the cable length should not exceed about ten feet to avoid difficulties due to cable capacitance.

Phototube Applications.—One of the best known applications of phototubes is in operating a bell or other alarm upon the entrance of any intruder into a guarded area. The principle, as applied for doors and windows of a single room, is shown at the left in Fig. 29. The beam from a lamp is focused onto a mirror and is reflected from this to other mirrors until reaching the phototube. The beam crosses all possible entrance points. The alarm would remain inoperative, with its relay open, until any object interrupts the beam at any point. The beam usually is infra-red or ultra-violet so that it cannot be seen, yet will actuate the phototube.

At the right in Fig. 29 is a light beam extending in front of the dies of a punch press. Power can be applied to operate the press only while the phototube receives the light beam to hold a relay and power contactor closed. Should the operator's hands or any part of his body be near enough to the dies to interrupt the beam it would be impossible to operate the press. Any areas of personal danger may be guarded in similar fashion.

At the left in Fig. 30 the beam from a lamp to the phototube is directed across the space through which must pass any articles traveling on a conveyor belt. If the beam is close to the belt this arrangement may operate a relay attached to a counter for recording the number of articles passing. Sorting as to height might be done by raising the beam so that it would be interrupted only by articles higher than some minimum. The relay could then actuate a solenoid and plunger to push all the high articles to one side, into a container or onto another belt.

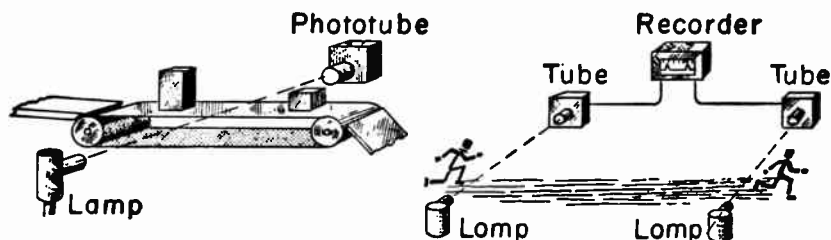

Fig. 30.—Phototube counting or sorting (left) and timing of a race (right).

At the right in Fig. 30 is an arrangement for timing a race. When a racer crosses the left-hand beam the left-hand phototube sends an impulse to a tape recorder whose tape is moving through the recorder at a known time rate. When the racer interrupts the second light beam the right-hand phototube sends another impulse to the time recorder. This principle is used also for automobile "speed traps." If the space on the time tape is less than that corresponding to minimum permissible time and maximum speed between the two beams the automobile is traveling too fast.

At the left in Fig. 31 a phototube is inspecting packages to make certain that a label is attached and correctly placed. The label is shown as of light color, so would increase the luminous flux to the tube. This arrangement might be used with the one of Fig. 30 (left) to energize the phototube or lamp of Fig. 31 each time an article passed a given point at which labels are to

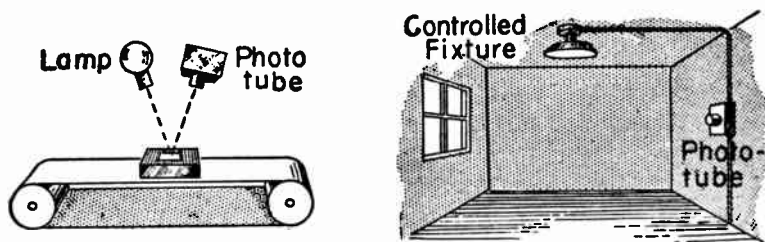

Fig. 31.—Phototube inspection of labels (left) and control of indoor lighting (right).

be inspected. Unlabeled articles could be kicked off the belt with a solenoid plunger.

At the right in Fig. 31 a phototube is being used to turn on the lamps in a ceiling fixture when daylight coming through the windows falls below a certain number of foot-candles of illumination. With light from outdoors above this level the phototube relay is held open or the lamp switch is held open. Sometimes a resistance-capacitance time delay circuit is used to prevent turning on of the lamps while a cloud crosses the path of sunlight.

At the left in Fig. 32 a phototube is actuated by light trans-

mitted through gases or liquids passing through an enclosed space. This principle is used for smoke recorders and smoke alarms on factory smoke stacks. Excessive smoke in the stack so reduces light flux to the phototube as to change the position of an inked pen on a recording tape, thus showing the degree of smoking and the time. Otherwise the phototube may turn on an alarm in the furnace or boiler room. The same general method is used for checking the "turbidity" of liquid solutions during processes of manufacture, for measuring light transmission through photographic films for timing exposures in printing, and for many other purposes.

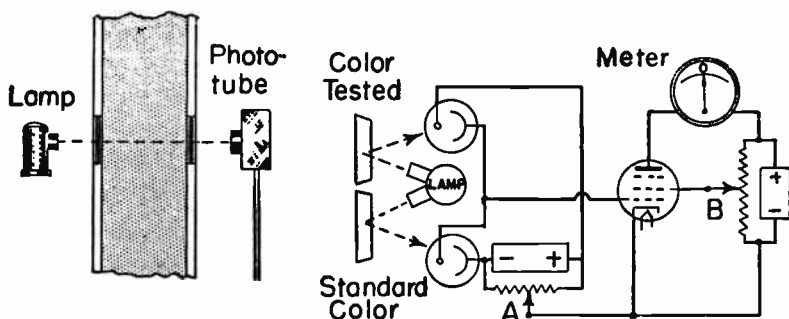

Fig. 32.—Phototube inspection for smoke or translucency in any space (left).
Phototube color matching (right).

The principle of one method of comparing colors is shown at the right in Fig. 32. With no light turned on, adjustment *A* is set to bring the meter pointer to the center of its scale. Adjustment *B* keeps meter current within the range of the meter with maximum illumination on the phototubes. If the sample of color being tested matches the color of the standard sample the meter pointer will stand at center scale. Otherwise the pointer will deflect to one side or the other.

The applications shown by Figs. 29 to 32 are but a few of the almost unlimited uses for phototubes. Most applications fall into one or the other of the following five general classes. 1. Complete interruption of a light beam, as in Figs. 29 and 30. 2. Light

varied by condition of a surface, as at the left in Fig. 31. This principle could be used for checking rust spots, checking the degree of polish on metals, and so on. 3. Gradual changes of light intensity, as at the right in Fig. 31. 4. Changes of transmitted light due to varying opacity or translucency of gases or liquids, as at the left in Fig. 32. 5. Variations or changes of color, as at the right in Fig. 32.

There are few things in industry, commerce, or any other activities which cannot be made to cause one or the other of the five kinds of change in light. Consequently there are few things which cannot be measured and controlled by means of phototubes. In addition to the five types of light change mentioned, it must be remembered that these changes may be brought about by light emitted from a source such as a lamp, by light reflected from any surface, and by light transmitted through various substances.

REVIEW QUESTIONS

1. Which has shorter wavelength, blue light or orange light? Which of these colors has the higher frequency?
2. If luminous flux of 50 lumens reaches a surface whose area is 10 square feet, what is the illumination in foot-candles? With illumination of 10 foot-candles what is the luminous flux on a surface of $1/10$ square foot?
3. If anode characteristics for a phototube are practically flat, or horizontal, above some certain voltage, is the tube a vacuum type or a gas type?
4. Is the greater sensitivity of gas phototubes, compared with vacuum types, more useful at high or low levels of illumination?
5. Would higher or lower source voltage be used with a vacuum phototube when there is (a) high level of light flux, (b) small load resistance?
6. Which maintains its sensitivity more uniformly with increase of audio-frequency changes of light, the gas phototube or the vacuum phototube?
7. When a phototube cathode is directly connected to an amplifier control grid, will increase of phototube illumination cause an increase or a decrease of amplifier plate current?
8. In a phototube amplifier would you use a vacuum pentode or a gas tetrode (a) for measurement of light by readings on a meter, (b) for operating a power relay?

INDEX

A

- A or A1 class amplifier, 70
- A2 class amplifier, 72
- AB1 class amplifier, 76
- AB2 class amplifier, 77
- Adjacent channel selectivity, 150
- Amplification, coupling capacitor effect on, 6
 - gas factor, 307
 - grid resistor effect on, 10
 - load line measurement of, 145
 - load resistor effect on, 4, 21
 - tests of, 142-145
- Amplifier, audio-frequency, 1-36
 - frequency response of, 4
 - hum in, 172
 - class A or A1, 70
 - A2, 72
 - AB1, 76
 - AB2, 77
 - B, 74
 - C, 79
 - currents in, 87
 - direct-current, 26-28
 - gain test of, 184-189
 - grounded grid, 287
 - high-frequency, 265-287
 - capacitors for, 266-271
 - parts for, 277
 - intermediate-frequency, selectivity test of, 157
 - output measurement of, 124-127
 - phototube, 226-229
 - potentials in, 87
 - power, 37-56
 - classification of, 70-80
 - degeneration in, 57-68
 - oscillation in, 55
 - performance of, 58-82
 - push-pull, 40-56
 - push-pull, 40-56
 - driver for, 80
 - harmonic distortion in, 183
 - output transformer for, 54
 - phase inverters for, 44-53
 - resistance coupled, 1-36
 - cathode bias in, 18-20
 - coupling capacitor for, 6
 - frequency response of, 4, 23
 - grid resistor for, 10
 - high-frequency compensation in, 29
 - load resistor in, 4, 21
 - low-frequency compensation in, 24-36
 - phase inverters for, 44-53
 - radio-frequency, 20-26
 - shunt capacitances in, 13-17, 24
 - sensitivity tests of, 184-189
 - tests of, 121-146
 - tracking test of, 133
 - tuning range test of, 132
 - wide band, 23-36
 - Amplitude distortion, test for, 177
 - Angstrom unit, 294
 - Arc discharge, 206-207
 - Attenuation of filter, 110-111
 - Attenuator, signal generator, 123
 - Audio-frequency amplifiers, 1-36
 - hum in, 172
 - Automatic volume control, test of, 130

B

- Ballast resistors or tubes, 230-234
- Band-pass filters, 117
 - stop filters, 118-120
- B class amplifier, 74

- Bias, cathode, 18-20
 - degeneration with, 63-67
 - power tube, 53
- Breakdown voltage, 206
- Bucking, hum, circuits for, 174
- Bypass, cathode bias, 19
 - capacitors for, 91-94
 - high-frequency, 276
 - plate, 94-98
 - screen, 94

C

- Capacitance, alternating current affected by, 87-91
 - alternating potential affected by, 87-91
 - direct current affected by, 87-91
 - direct potential affected by, 87-91
 - reactance at audio frequencies, 3
 - at various frequencies, 92
 - output, tube, 14
 - shunt, 13-17, 24, 31
 - tube, 13-17
- Capacitive reactance, frequency effect on, 90
- Capacitors, bypassing, 91-94
 - cathode bypass, 19
 - ceramic, 269-271
 - coupling, 6
 - electrolytic, bypassing of, 95
 - fixed, high-frequency, 269
 - high-frequency, 266-271
 - reactance at audio frequencies, 3
 - at various frequencies, 92
 - temperature compensating, 270
 - trimmer, ceramic, 270
 - tuning, high-frequency, 266-271
- Cathode bias, 18-20
 - degeneration with, 63-67
 - follower, 140-142
- C class amplifier, 79
- Cell, photoelectric, see Phototube.
- Cements, high-frequency, 279
- Ceramic capacitors, 269-271
- Choke coils, decoupling, 98
- Class A or A1 amplifier, 70
 - A2 amplifier, 72
 - AB1 amplifier, 76
 - AB2 amplifier, 77
 - B amplifier, 74
 - C amplifier, 79
- Coils, choke, decoupling, 98
 - high-frequency, 272-275
 - powdered iron core, 274
 - shielding of, 106
- Cold cathode rectifiers, 217
- Color matching, phototube, 335
 - temperature, 302
- Combination currents and potentials, 87-91
- Compensating capacitors, temperature, 270
- Compensation, frequency, 32-34
 - high-frequency, 29
 - low-frequency, 34-36
 - shunt, 29-32
- Connections, dressing of, 99-103
- Contact rectifiers, 235-242
- Control remote, 224-284
- Copper oxide rectifiers, 235-242
 - sulphide rectifiers, 235-242
- Counting, phototube, 333
- Coupler, cathode, 140-142
- Coupling, capacitor for, 6
 - amplifier stages, 83
- Cross modulation, test for, 100
- Crystal detectors, 242-245
 - diodes, 245-249

Current, capacitance effect on, 89-91
feedback, 63-67
inductance effect on, 87-91
regulator tubes, 230-234
resistance effect on, 87-91

D

Dark current, phototube, 323
Decibels, load corrections for, 186
measurements in, 127-132
zero volts for, 133
Decouplings, 83-103
capacitors for, 91-94
choke coils for, 93
plate, 94
principles, of, 87
screen, 94
Degeneration, 18
current feedback for, 63-67
gain affected by, 62
harmonics affected by, 182
polarities for, 85
power amplifier, 57-63
voltage feedback for, 67-69
Detectors, crystal, 242-245
crystal diode, 245-249
germanium crystal, 245-249
superregenerative, 281-285
Dielectric loss factor, 263
Diodes, crystal, 245-249
Direct-current amplifier, 26-28
power supply, selenium rectifier for, 289
Discharge, arc and glow, 206-207
Discriminator, f-m, crystal diodes in, 247
Distortion, amplitude, test for, 177
fidelity, test for, 187-191
frequency, 187-191
harmonic, 179-184
degeneration effect on, 69
push-pull effect on, 43
tests for, 184-187
modulation, 177-179
non-linear, 179-184
phase, 192-198
limits of, 194
tests for, 195
push-pull effect on, 43
tests for, 177-197
waveform, 179-184
Dopes, high-frequency, 279
Dressing, wires and parts, 99-226
Driver stage, 80
Dry rectifiers, 235-242

E

Electrolytic capacitor, bypassing of, 69
Electron loading, 263
velocity in tubes, 261
Electrostatic shielding, 105
Emission, photo, 297
Energy, quantum of, 297
Even harmonics, distortion effect of, 182
Eye, human, color sensitivity of, 209

F

Feedback, couplings for, 83
current, 63-67
negative, see *Degeneration*.
voltage, 67-69
Fidelity, see *Distortion*.
Filters, attenuation of, 110-211
band-pass, 117
-stop, 118-120
high-frequency, 276
high pass, 115-117

Filters—(Cont.)

low pass, 112-115
mercury vapor rectifier, 216
transmission of, 110-111
wave, 109-120
Fixed capacitors, high-frequency, 261
Flux, luminous, 294-296
F-m discriminator, crystal diodes for, 249
Follower, cathode, 140-142
Foot-candles, 297
phototube cathode, 324
Frequencies, image, 161
middle, 4
phototube affected by, 320
quench, superregeneration, 228
reactances at, 8, 92
test, standard, 122
wide band, amplifier for, 23-26
Frequency distortion, 187-191

G

Gain, see also *Amplification*.
degeneration effect on, 62
formulas for, 18
tests for, 134-189, 142-145
Galena crystal detector, 243
Gas amplification factor, 307
filled rectifiers, 215
tubes, 201-234
phototubes, 306-310
tetrode, 226-230
photo-relay with, 329
triodes, 217-226
Gases used in tubes, 205
Generator, signal, attenuator for, 190
Germanium crystal diodes, 245-249
Glow discharge, 206-207
Grid, grounded, amplifier with, 287
resistor, 10
Grounded grid amplifier, 287

H

Harmonic distortion, 179-184
degeneration effect on, 69
effects of, 181
push-pull effect on, 43
tests for, 184-187
Hearing aid tubes, 252-254
High-frequency amplifiers, 245-297
hy-passing, 276
compensation, 29
coils for, 272-275
filtering, 276
inductors for, 272-275
materials for, 277
receivers, 279
shielding, 276
tubes, 251-254
High-pass filters, 115-117
Hum, a-f amplifier, 172
bucking, circuits for, 174
modulation, test for, 171
push-pull effect on, 43
residual, test for, 172
voltage, causes for, 168
tests for, 166-171

I

Ignition voltage, 206
Illumination, 296
foot-candle of, 297
phototube control of, 324
Image frequencies, 161
interference, test for, 169
Impedance, input, tube, 258

Inductance, affected by currents and potentials, 87-91
Inductors, see Coils.
Infra-red radiations, 298
Input impedance, tube, 258
Instrument rectifiers, 237
 crystal diode for, 248
Interference, cross modulation, 100
 hum voltage, test for, 168-171
 image, test for, 160
 intermediate frequency, test for, 108
 modulation hum, test for, 171
 two-generator test for, 153
 wiring pickup, test for, 163-166
Intermediate-frequency amplifier selectivity, 157
 rejection, tests for, 162
Interstage couplings, 83
Inverters, phase, 44-53
Invisible radiations, 292-297
Ionisation, 208
 gas triode, 218
 phototube affected by, 220
 thyatron, 218
Ions, 208
Iron core coils, high-frequency, 274
 pyrites crystal detector, 244

L

Labeling, phototube control of, 204
Leads, dressing of, 99-108
Light, 292-297
Lighting, phototube control of, 224
Load line, gain measured from, 145
 phototube, 211
 resistance, high-frequency amplifier, 31
 phototube, 210
 resistors, amplifier, 4, 21
Loading, electron, 263
Loss factor, dielectric, 263
Loud speaker field, hum winding on, 174
Low-frequency compensation, 34-36
Low-pass filters, 112-115
L-section filters, 112-120
Lumens, 294-296
 phototube cathode, 224
Luminous flux, 294-296
 sensitivity, 299

M

Magnetic shielding, 105
Measurements, see Tests.
Mercury-vapor rectifiers, 215
Meters, rectifier, crystal diodes for, 208
Middle frequencies, 4
Miniature tubes, 252-254
Modulation, cross, test for, 100
 distortion, 177-179
 hum, test for, 171
Multi-lead tubes, 259

N

Negative feedback, see Degeneration.
Noise, 198-200
 causes for, 199
 measurement of, 198
Non-linear distortion, 179-184

O

Odd harmonics, distortion effect of, 201
Oscillation in power stage, 55
Oscillator, frequency test of, 134
 gas triode type of, 222

Oscilloscope, harmonic distortion test with, 185
 hum voltage test with, 168-171
 phase distortion test with, 196
Output, amplifier, measurement of, 124-227
 capacitance, tube, 14
 decibel measurement of, 127-132
 transformer, push-pull, 54

P

Parallel power tubes, 28
Phase distortion, 192-198
 limits of, 194
 test for, 195
 inverters, 44-53
 shift in amplifier, 25
Photo-cell, see Phototubes.
Photo-emission, 297
Photon of light energy, 297
Phototubes, 289-326
 amplifiers for, 325-329
 applications of, 328-336
 cathode areas of, 324
 illumination of, 324
 characteristics, 322
 dark current in, 322
 forward circuits for, 323
 frequency effects in, 320
 gas types of, 306-310
 ionisation effects in, 320
 load lines for, 311
 resistance effects in, 310
 luminous sensitivity of, 299
 radiant sensitivity of, 323
 relays for, 329-332
 gas tetrode, 230
 ratings, 322
 reverse circuits for, 323
 sensitivity of, 298-302
 vacuum types of, 302-305
Pi-filters, 112-120
Plate bypass, high-frequency, 94-98
 decoupling, 94
 resistance, 201
Polystyrene characteristics, 278
Positive ions, 203
Potential, affected by capacitance, inductance, resistance, 87-91
Powdered iron core coils, 274
Power amplifiers, 27-56
 classes of, 76-80
 degeneration in, 57-63
 oscillation in, 55
 performance of, 52
 push-pull, 40-56
 supply, selenium rectifier, 200
 tubes, 37
 biasing of, 53
 parallel, 38
Push-pull amplifier, driver for, 80
 output transformer for, 54
 phase inverters for, 44-53
Pyrites crystal detector, 244

Q

Quantum of energy, 297
Quench frequency, superregeneration, 202

R

Race timing, phototube, 322
Radiant sensitivity, phototube, 299
Radiation, infra-red, 293
 visible, 292-297
Radio-frequency amplifier, resistance coupled, 20-26

Reactances of capacitors at various frequencies, 8, 92
 Receivers, see also *Amplifiers*.
 gain test of, 184-189
 high-frequency, 279
 output measurement of, 124-127
 sensitivity test of, 184-189
 tests of, 121-146
 tracking test of, 133
 -transmitter combination, 235
 tuning range test of, 132
 Rectifiers, cold cathode, 217
 contact, 235-242
 copper oxide and copper sulphide, 235-242
 crystal diode, 245-249
 dry, 235-242
 gas-filled, 215
 germanium crystal, 245-249
 instrument, 237
 crystal diodes for, 245
 mercury-vapor, 215
 selenium, 235-242
 power supply type, 239
 Regeneration, polarities for, 85
 Regulators, current, 230-234
 voltage, 207-215
 Relays, gas triode operated, 233
 phototube, 329-332
 gas tetrode, 230
 Remote controls, 224, 234
 Residual hum, test for, 172
 Resistance coupled amplifier, see *Amplifier*,
resistance coupled.
 currents and potentials affected by, 87-91
 plate, 201
 Resistors, ballast, 230-234
 cathode bias, 18-20
 grid, amplifier, 10
 load, amplifier, 4, 21
 Ripple voltage, causes for, 300
 tests for, 166-171

S

Screen decoupling, 94
 grid thyatron, 226-230
 Second channel selectivity, 180
 Selectivity, 147-159
 adjacent channel, 150
 constant signal test for, 156
 curves showing, 148
 i-f amplifier tested for, 157
 i-f rejection test for, 162
 image interference test for, 160
 radio-frequency amplifier effect on, 300
 second channel, 150
 test for, 148
 two-generator test for, 153
 wiring pickup test for, 163-166
 Selenium rectifiers, 235-242
 power supply types, 239
 Self-resonance, tube, 260
 Sensitivity, human eye, 300
 luminous, 299
 phototube, 298-302
 radiant, 323
 receiver, test of, 184-189
 Series compensation, 32-34
 Shield grid thyatrons, 226-230
 Shielding, 109-109
 electrostatic, 105
 high-frequency, 276
 magnetic, 105
 metals used for, 104
 stage, 109
 Shift, phase, high-frequency, 35
 Shunt capacitance, 13-17, 24, 31
 compensation, 29-32

Signal generator, attenuator for, 120
 strength, test for, 123
 Silicon crystal detector, 245
 Smoke detection, phototube, 335
 Sorting, phototube, 333
 Speaker field, hum winding on, 174
 Spectrum, visible, 293
 Speed, electron, 261
 Standard test conditions, 131
 Starting voltage, 206
 Subminiature tubes, 252-254
 Superheterodyne receivers, high-frequency,
 279
 Superregeneration, quench frequency for,
 282
 receivers employing, 281-285
 remote control with, 284

T

Temperature, color, 302
 capacitors for compensating, 270
 Tests, receiver and amplifier, 121-146
 automatic volume control, 139
 frequencies used during, 122
 gain versus input, 142-145
 oscillator frequency, 134
 tracking, 133
 output, 124-127
 selectivity, 146
 sensitivity, 134-139
 signal strengths for, 130
 tracking, 133
 tuning range, 132
 voltages used during, 130
 Tetrode, gas, 226-230
 control of, 227
 photo-relay with, 230
 Thyatrons, 217-230
 ionisation in, 218
 photo-relays with, 329
 shield grid type, 226-230
 triode type, 217-226
 Time, transit, tube, 260-263
 Timing with phototube, 333
 Tracking, test for, 133
 Transformer, hum bucking, 174
 output, push-pull, 54
 shielding of, 107
 Transceivers, 285
 Transit time, tube, 260-263
 Transmission of filters, 110-111
 Transmitter-receiver, 235
 Trap, wave, test of, 162
 Trimmer capacitors, ceramic, 299
 Triodes, gas, 217-226
 controls for, 219
 oscillator using, 222
 relay with, 223
 remote control with, 224-224
 uses of, 221
 T-section filters, 112-120
 Tubes, ballast, 230-234
 capacitances of, 13-17
 current regulator, 230-234
 gas-filled, 201-234
 rectifier, 215
 triode, 217-226
 gases used in, 205
 hearing aid, 252-254
 high-frequency, 251-264
 input impedance of, 253
 ionisation in, 203-207
 low plate voltage types, 254
 miniature, 252-254
 multi-lead types of, 259
 output capacitance of, 14
 phase inverter, 44-53

Tubes—(Cont.)

- photo, see *Phototubes*.
 - plate resistance of, 291
 - power, 27
 - biasing for, 53
 - parallel, 38
 - rectifier, cold cathode, 217
 - gas-filled, 215
 - mercury-vapor, 215
 - regulator, current, 230-234
 - voltage, 207-215
 - self-resonance in, 260
 - shielding of, 106
 - special purpose, 251-264
 - subminiature, 252-254
 - thyatron, 217-230
 - transit time in, 260-263
 - triode, gas-filled, 217-226
 - ultra-high frequency, 255
 - vapor-filled, 201-224
 - very-high frequency, 255
 - voltage regulator, 207-217
 - wide band amplifier, 29
- Tungsten lamp light source, 302**
- Tuning capacitors, high-frequency, 206-271**
 - range, test of, 132
 - tracking test for, 133
- Two-generator selectivity test, 153**

U

- Ultra-high frequency tubes, 255
- Unit, Angstrom, 294

V

- Vacuum phototubes, 202-205
- Vapor-filled tubes, 201-224
- Velocity, electron, tube, 261
- Very-high frequency tubes, 255
- Visible radiations, 292-297
 - spectrum, 293
- Voltage, breakdown, 206
 - decibel zero for, 123
 - feedback, 67-69
 - hum, test for, 166-171
 - ignition, 206
 - output, measurement of, 124-127
 - regulator tubes, 207-215
 - action of, 208
 - connections for, 211-213
 - current maximum in, 210
 - protective resistance for, 211
 - ripple, test for, 116-171
 - starting, 206
 - test, standard, 122
- Volume control, automatic, test of, 120

W

- Wave filters, see *Filters*.
 - trap, test of, 162
- Waveform distortion, 179-184
- Wavelength, light, 294
- Wide band amplifiers, 23-26
- Wires, dressing of, 99-103
- Wiring, interference pickup test of, 103-106

