

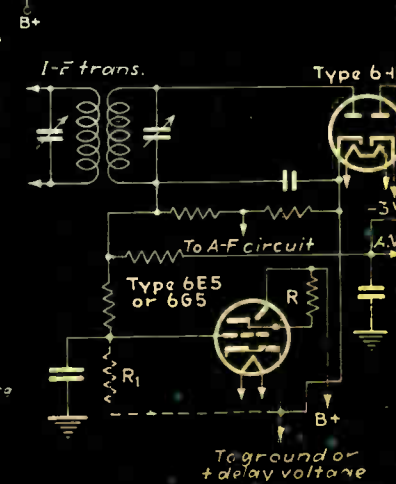

RADIO RETAILING'S TRICKS OF THE TRADE

Revised and Enlarged - Third Edition

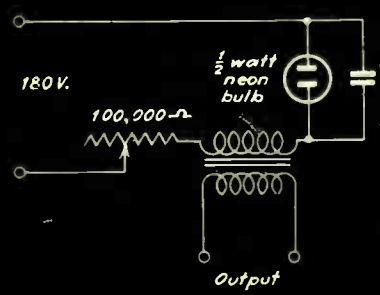
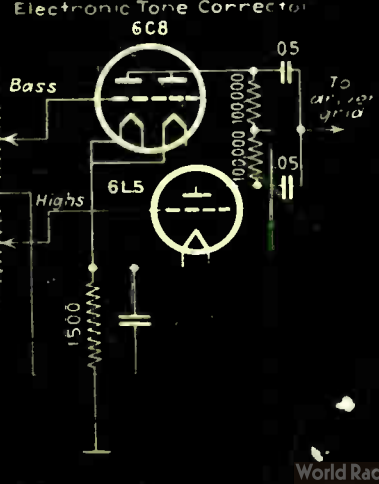
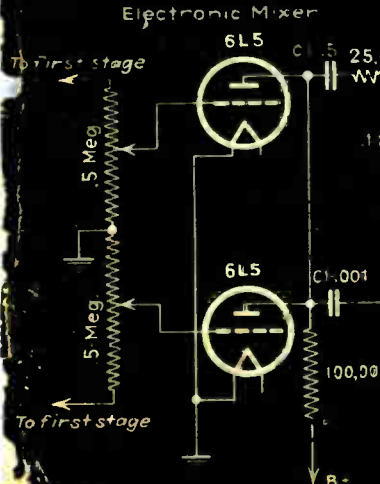
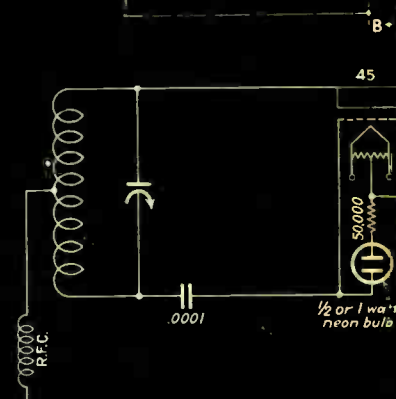
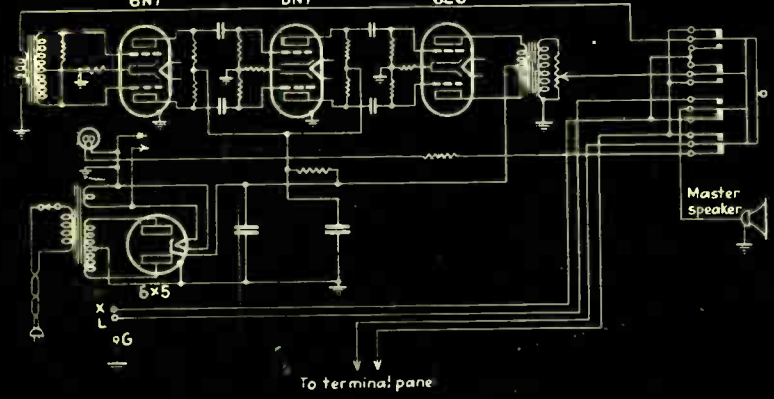
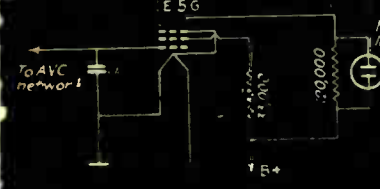
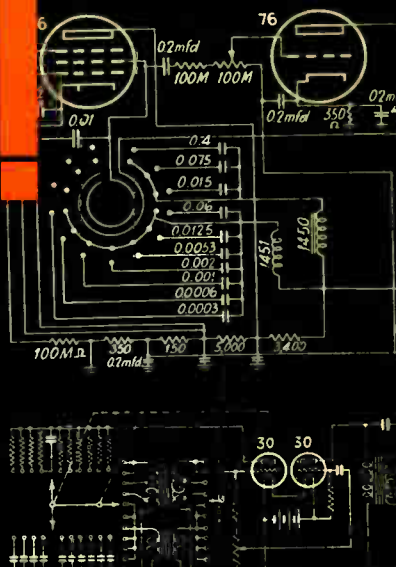
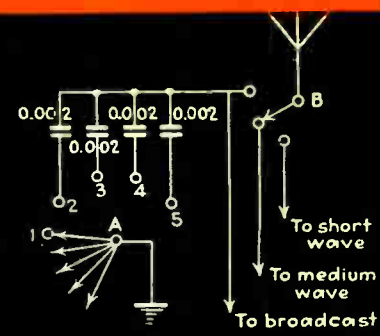
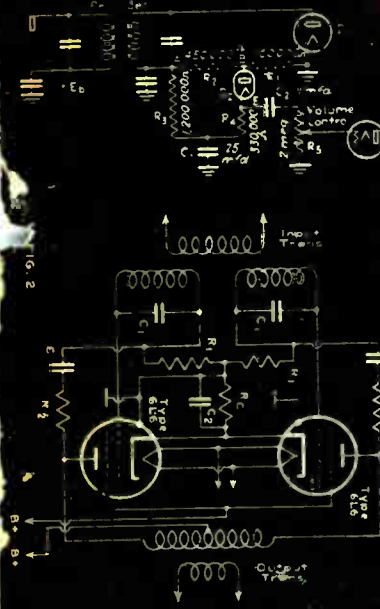
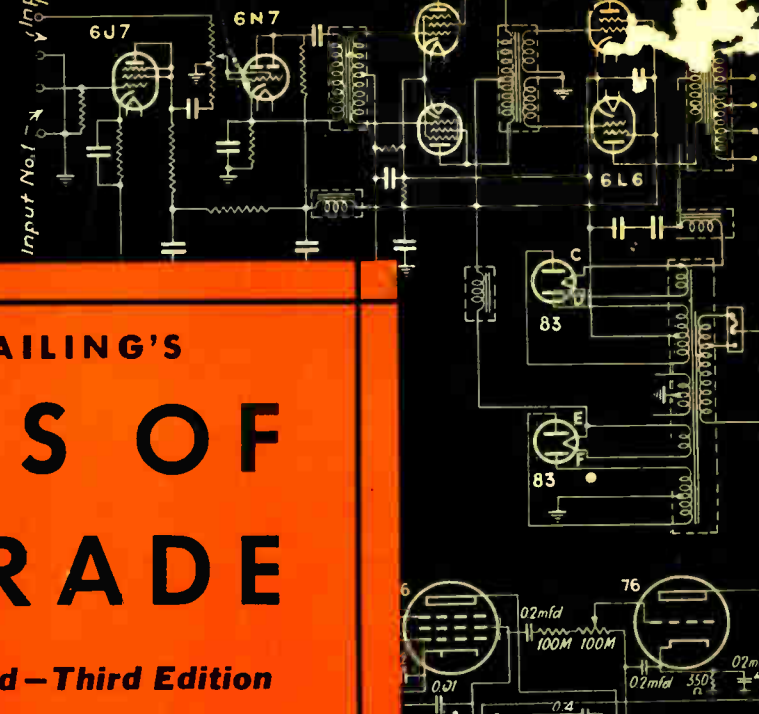
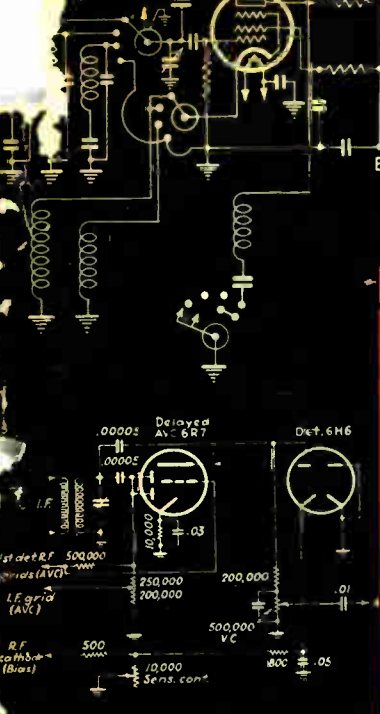

25,000 OHMS PER VOLT

-In Model 1200-E

Volt-Ohm-Milliammeter

Model 1200-E
-DEALER

...\$31¹⁷



- Resistance Readings to 40 Megohms

- For All Radio Measurements Not Requiring a No Current Draw Vacuum Tube Voltmeter

READINGS: D.C. Volts 10-50-250-500-1000 at 25,000 Ohms per Volt . . . A.C. Volts 10-50-250-500-1000 . . . 50 D.C. Microamperes, 1-10-50-250 Milliampere. Resistance 0-1000 Low Ohms; Backup circuit; 0-40,000 Ohms; 4 and 40 Megohms.

A Master Unit by TRIPLET

Triplet brings a new order of precision testing in this 25,000 Ohms per volt tester. Modern radio sets that require delicate balancing can be easily and

quickly adjusted. Model 1200-E has separate A.C. and D.C. instruments in Twin Case with tilting feature for accurate reading.

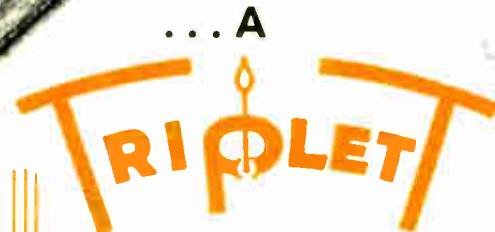

... A MASTER UNIT

Another of the series of popular co-related single unit testers, made in standard sizes, the most economical method yet devised for completely equipping the all-around radio service shop with high quality instruments. Catalog gives complete information regarding other Triplet Volt-Ohm-Milliammeters.

New LABORATORY TEST BENCH PANEL CONTAINS:

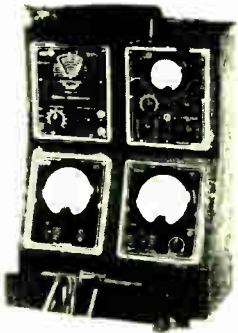

MODEL 1
DEALER PRICE \$92¹⁸
(complete less lamp)

- 1210-A Tube Tester
- 1232 Signal Generator
- 1209-A A.C. Voltmeter
- 1209-D D.C. Volt-Ohm-Milliammeter

Other Laboratory Models

Model 1402 with compartments for any two DeLuxe Testers; Model 1403 with accommodations for any two Master Units and one DeLuxe Tester.

FILL IN — CLIP — MAIL NOW!
THE TRIPLET ELECTRICAL INSTRUMENT CO.

40 Harmon Ave., Bluffton, Ohio

Please send me more information on..... Triplet
Model 1200-E..... Model 1404.

Name

Address

City

State.....

**For More Information
SEE YOUR JOBBER**

... OR MAIL COUPON TODAY!



"TRICKS OF THE TRADE"

**Revised and Enlarged
Third Edition**

**Practical "bread and butter" tips for radio dealers and
service men on how to find and repair the most common
troubles peculiar to specific models of receivers**

plus

Reference Charts of permanent value and use.

**Published by
RADIO RETAILING
33 West 42nd Street
New York City**

Copyright 1937, 1936

FOREWORD

THE enthusiastic reception accorded the first edition of "*Tricks of the Trade*" and its subsequent reprinting was most gratifying. Radio servicemen and dealers throughout the world were unstinting in their praise of this novel reference aid.

Letters poured in from radio men who had found in the pages of the first "*Tricks of the Trade*" book the happy solutions to what might have been annoying problems. And what letters they were. Such phrases as—"greatest time-saver I've ever had"—"worth all other service books put together"—"wouldn't take \$50 for my copy unless I could get another"—"I save the cost of *Radio Retailing* every day in the year"—spurred us on to revise earlier editions and incorporate in this third edition more than 250 more "*Tricks*" and some new reference charts.

We hope that you find this book as helpful as we know thousands of other radio men have found theirs. *Radio Retailing* will continue to hold its leading position as the best radio magazine in the field through the calibre and excellence of its editorial contents.

Your comments and suggestions will be welcomed at any time and we sincerely thank you for your subscription order.

THE EDITORS

INDEX TO ADVERTISERS

	<i>Page</i>
Condenser Products Company.....	9
Consolidated Wire and Associated Corporations.....	57
Hickok Electrical Instrument Company.....	43
Jackson Electrical Instrument Company.....	11
P. R. Mallory and Company.....	36-37
Muter Company, The.....	13
Operadio Manufacturing Company, Inc.....	7-15-55
Raytheon Production Corporation.....	<i>Outside Back Cover</i>
Supreme Instruments Corporation.....	35
Triplett Electrical Instrument Company.....	<i>Inside Front Cover</i>

Why GOOD SERVICE CAN'T BE CHEAP

The Simplest Repair, On the Smallest Radio, Requires:



CONTINUAL STUDY

Good servicemen know the engineering principles of your set. They spend at least 1 hour a day reading technical magazines and books

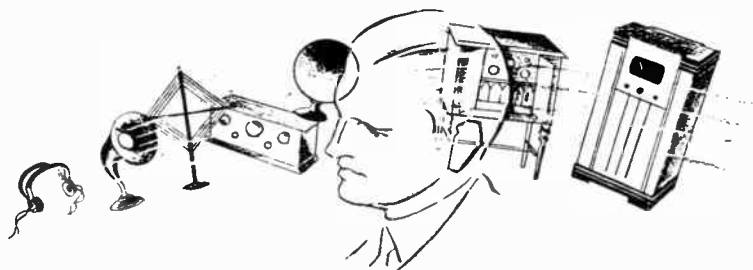

LONG EXPERIENCE

Good servicemen have a practical knowledge of other receivers like yours. The average has been in business 7 years



ADEQUATE STOCK

Good servicemen keep a costly supply of standard parts on their shelves. Thus they may render quick as well as reliable service

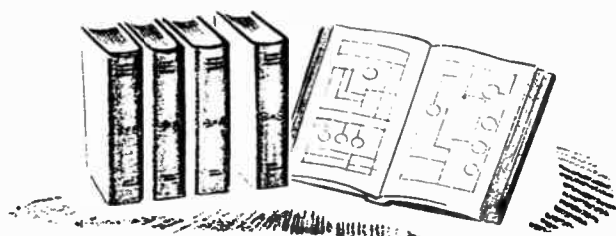

MANY DIAGRAMS

Good servicemen maintain manuals containing 8300 or more individual data-sheets so that they may know each intricate detail of every manufactured receiver

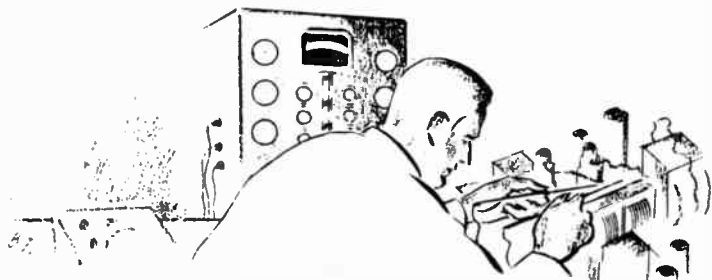

TEST EQUIPMENT

Good servicemen have \$200 or more invested in delicate measuring instruments necessary for accurate diagnosis of trouble. They improve and replace this equipment frequently

Well-Trained and Well-Equipped Servicemen Fix Radios So They Stay Fixed Saving You Time, Trouble and Money

**RADIO
RETAILING**

RADIO RETAILING'S "Tricks of the Trade"

AC-DC SETS

AC-DC SETS. Of 175 "universal" receivers serviced by a Baltimore correspondent 93 needed new filter condensers, 62 high-capacity, low voltage condensers used between cathode and ground, 12 resistors, 1 field-coil and seven small fixed condensers.

ACE AC-DC MIDGET. Crackling and sputtering . . . One or possibly two of the a.c. wires running from the plug at the rear of the chassis touching under the choke. Remove choke and place wires around instead of under it.

This space was left blank so you may paste in additional "Tricks of Trade" as they appear in the monthly issues of Radio Retailing.

AIR LINE

AIRLINE. Fluctuating filament voltages in older models using 26's, or failure of r.f. tubes to light at all. Caused by loosening of riveted junction between binding posts and power transformer lead soldering lugs, due to shrinkage of mounting strip. Remove transformer and flood riveted junction with solder. Some local-distance switches test all right on 110 volts but fail to make contact when in actual use. Clean hardened flux or grease from contacts.

AIRLINE BATTERY 5. Improving sensitivity and tone . . . Replace detector 34, unshielded, at rear of chassis, with a 32 connecting the grid return directly to minus C9 volts. (Brown lead.) This eliminates the 1 meg resistor in this lead. The grid lead is originally connected to the plus filament.

AIRLINE 05BA. Oscillation after several months of use . . . Substitute .01 condenser for .002 detector plate capacitor. If still troublesome connect another .01 from choke coil to chassis.

AIRLINE 40, 40A. Whistle near 800 kc. . . . Replace oscillator grid leak with 40,000 ohms. A lower resistance causes cutoff near 1,400 and a higher value is the cause of the original trouble at 800.

AIRLINE 62-22. Distortion and overloading on locals, receives dx ok, a.v.c. plate voltage somewhat high when first turned on . . . Look for open circuited resistor between oscillator and r.f. screens to plate of a.v.c. tube, also look for open in "localizer." It sometimes lets go on the cathode side of the control. The divider should be 4,300 ohms overall, tapped at 1,100. Tests should be made to cathode instead of from suspected point to ground. Fading, intermittent reception . . . Check for open cathode bypass condenser in i.f. stage.

AIRLINE 62-68. Intermittent reception . . . Due to periodic opening of 3,200 ohm candohm resistor furnishing cathode and suppressor grid bias to the 57 first detector-oscillator. Replace with 1 watt unit.

AIRLINE 62-76. To improve bass response and avoid overloading of paralleled 47's . . . Change resistor in plate circuit of 57 first a.f. stage from 50,000 to 25,000 ohms. This will probably make set screech when volume is full on and tone control is in treble position, so shunt a condenser of from .005 to .01 capacity (a .006 is usually best) from the variable arm of the manual tone control potentiometer to the high potential end of this same potentiometer.

AIRLINE 62-97, 62-99. Blown .1 mfd. condensers in plate circuit of 58's . . . Some sets left factory with 200 volt units. These should be replaced with condensers having a 400 volt rating.

AIRLINE 62, 123, 131, 133, 142, 144. Failure to operate when new and in use only a short time . . . Most likely trouble is defective two-section armored wire-wound resistor. Replace with a 1-watt, 25,000-ohm and a 2-watt, 16,000-ohm type. (I.F. 456 kc.)

AIRLINE 64. Inoperative tuning meter and weak signals. Place finger on control grid cap of first r.f. 58. If volume increases meter is burned out. It may be shorted without affecting set operation until a replacement can be obtained.

AIRLINE 77-95. Poor tone quality noted after replacing defective 19 tube . . . Change bias from 6 to 4½. If in cable disconnect from 6 volt pin and connect to 4½ volt pin. Static-like noise . . . Replace push-pull input transformer. IF: 175.

AIRLINE Alexander. If you can't align check center-tap resistor of 2½-volt winding. It should be 150-ohms but sometimes changes value enough to cause oscillation.

AIRLINE, GULBRANSEN 9. Severe cases of oscillation are curable by removing the gang-condenser rotor-rod, sandpapering it where it contacts the frame, sandpapering spring contacts and adjusting screw.

AIRLINE 62-70, 62-72

Intermittent fading . . . Replace .04 coupling condenser between 56 detector and 47.

AIRLINE 62-99

Inoperative . . . poor 32 oscillator tube. Try several tubes. A slight readjustment of plate and screen voltages is sometimes helpful.

AIRLINE 62-134

Intermittent high pitched whistling . . . defective oscillator grid leak. This is a 100,000 ohm resistor.

AIRLINE 182

Power transformer heats badly after a few minutes operation . . . filament leads to various tubes are twisted together and bunched close to chassis, sometimes shorting to it. To test unsolder centertap of filament winding from ground and check continuity. Any reading indicates a short.

AIRLINE T.R.F.

Poor tone . . . connect a 10,000 ohm resistor across primary of p.p. input. Also .02 mfd from plate terminal of primary to one side of secondary.

AIRLINE 1955

Intermittent . . . replace .01 mfd. coupling condenser between oscillator plate and grid. This condition can be checked by testing for oscillator signal.

This space was left blank so you may paste in additional "Tricks of Trade" as they appear in the monthly issues of Radio Retailing.

Add more "Tricks" to this Service Manual. They appear in every issue of Radio Retailing.

ALL-AMERICAN MOHAWK

ALL-AMERICAN MOHAWK 70, 73, 75. To reduce hum level . . . Change the location of the gridleak, which sometimes picks up hum from the a.c. filament leads.

AMRAD

AMRAD 81. If hum develops after about 30 minutes of operation replace the two 18 mfd. electrolytic sections with paper condensers. The breakdown rating need not be high as this circuit feeds only screens and the detector plate. Reforming the electrolytic rarely gives permanent results as the voltage is not high enough to keep it active.

APEX

APEX 8A, 10. Distortion, after set has played for about 30 minutes, 47 grid gets red . . . Caused by open 47 filament center-tap. Usually it is just an intermittent open. Sudden increase in volume, or decrease, when nearby light is turned on . . . Generally caused by an open .5 mfd. condenser connected between r.f. cathode and grid return of r.f. and i.f. coils. Replace with 400 volt unit

APEX 27. Intermittent oscillation. Increase the r.f. by-pass condenser from $\frac{1}{2}$ to 1 mfd.

APEX 41, 42 Oscillation over entire scale. Try 2,000 ohm resistor in second r.f. grid lead.

APEX 46. Distortion on low volume after tubes are replaced. Remove old volume control, which is simply a cathode resistor in the 24 circuits, and replace with 10,000 ohm tapered unit, connecting one side to antenna lead, center arm to ground or chassis, other terminal to cathodes of 24's through 250 ohm fixed resistor. Break in wire wound resistor where old control was connected should be closed with jumper.

APEX 46, 47, 48. When these models lack volume screw a small piece of tin under stator supports of tuning condensers. Tune as trimmers by raising up or down. No plate voltage on one 45 indicates blown audio choke. It may be shunted with no appreciable change in tone. Smoke from power transformer, set dead. Unsolder rectifier leads and run them through spaghetti. Resolder.

APEX 10

Inoperative, normal with 27 a.v.c. tube out of socket . . . replace 1800 ohm section of Candohm resistor at rear of chassis.

APEX 26

High screen voltage on detector tube . . . replace 2640 ohm section of armored resistor with 2,500 ohm 10 watt wire wound resistor.

APEX 32

Fading, intermittent howling. . . . Flat bypass condenser can containing 6 condensers has poor ground connection. Can is common, solder can to tube shields.

APEX 36

Normal or excessive volume at high end of dial, weak on other end . . . replace open antenna choke and realign set.

This space was left blank so you may paste in additional "Tricks of Trade" as they appear in the monthly issues of Radio Retailing.

ARVIN

ARVIN. Excessive vibrator hum in 1935 models of these car sets . . . Move large yellow "A" wire running from volume control switch to power supply compartment as far as possible from second i.f. coil.

ARVIN 7, 17, 27, 37. Intermittent oscillation or motor-boating . . . Replace twin a.v.c. condenser located between the 78 socket and the antenna coil. In the model 7 the condenser is located between the 6F7 socket and the antenna coil.

ARVIN 10A. Bad howl when set is very cold . . . Reverse reflexed audio transformer primary leads. Bad howl at any time . . . Replace 12 mike, 25 volt electrolytic condenser. Bad hum after replacing 84 tube . . . Put metal shield over tube and ground.

ARVIN 17, 27. Oscillation while tuning . . . Condensers No. 17-4731 and No. 17-4712 may be making poor ground contact through metal collar to chassis. Replace with new type No. 17-14020 and No. 17-14007 equipped with separate ground leads. Ignition noise . . . See that cables are grounded. Some came through without lugs.

ARVIN 20A, 30A. No reception although set sounds alive . . . Inspect r.f. chassis unit and if tube heaters are not lit repair broken "A" choke in audio unit. Tubes in r.f. chassis light but vibrator is not heard . . . Check same choke for break at opposite end. Set overloads on powerful local signal . . . Replace 75 with 85, which will cut sensitivity somewhat but give better tone.

ARVIN 25. Set completely dead . . . Check for shorted tone control. This is a tapped condenser type. Intermittent reception . . . Replace dual .015 mfd. antenna coupling condenser. No reception, vibrator sounds weak . . . Check for shorted dual .02 condenser used as a buffer across power transformer secondary.

ARVIN 35. Poor tone . . . Replace both .01 mfd. audio coupling condensers with mica moulded types of same value.

ARVIN 41, 51. Distortion at low volume control settings, on strong signals . . . Due to overbias of 6F7 grid. Remove 100-ohm resistor from cathode of this tube and connect the cathode to ground through an 800-ohm resistor. The volume control, in other words, should affect bias on the 6A7 only, rather than on this tube and the 6F7 together. The 6F7 should be fixed biased all by itself.

RADIO RETAILING'S "Tricks of the Trade"

ARVIN 62

Noisy when tuning dial is rotated. . . . Solder bottom arm on planetary drive system to bracket at bottom front end of condenser gang.

ARVIN AUTO RADIOS

Ignition interference . . . In most cases, this is caused by chassis pickup. It can be overcome by removing the front cover and cleaning the surface of the joints with fine sandpaper to provide greater area of metallic contact. Also check the acoustinator plug to see that a good ground contact is obtained.

On the model 65, check the right hand breather screen for ground. Spotting it with solder to the housing is sufficient to prevent interference from feeding in at this point.

ARVIN AUTO RADIO

Mechanical hum . . . vibrator chatters against chassis. This may be eliminated by removing vibrator and increasing the tension on the vibrator grounding spring cup.

ARVIN 1936 SERIES

Vibrator hash . . . Make sure chassis is well grounded to firewall and use shakeproof washer. Make sure good ground is obtained for transmission line box. Ground the box to the frame of the car if an under-car antenna is used, or, if a top antenna is used, ground the box to some metal part known to be at the same r.f. potential as the firewall. Remove front cover from set and tighten four screws holding power transformer in place. Wiggle vibrator in socket and make certain that each grounding tooth makes contact with the sides of the vibrator case. Try a condenser in addition to the generator or dome condenser, across the car's A circuit, placing it directly on either terminal of the ammeter or fuse block. Solder a 1½-inch piece of shielding from the 6A7 grid cap tube shield to the frame of the variable condenser. Check to see that transmission line shielding is firmly contacting plugs at both ends.

This space was left blank so you may paste in additional "Tricks of Trade" as they appear in the monthly issues of Radio Retailing.

ATWATER-KENT

AK. Noisy wire wound volume controls. Clean contact arm and winding with alcohol. Using No. 1 soft lead pencil, fill in spaces between windings at contact edge until surface appears level and smooth.

AK. Volume controls which become noisy need not always be replaced. Remove them from the chassis, swab the winding with a cloth saturated with alcohol, bend the slider arm so that it makes firmer contact with the winding and also tighten it against the tension spring.

A.K.

Flat ribbon drives can be replaced with phosphor bronze dial cable. Solder cable to pin on pulley that originally went through belt.

AK 7D, 217D, 427D, 667D.

Squealing at low volume levels . . . Replace condenser C18 as it has probably developed leakage. Use an 8 mike, 400 volt unit. Sometimes one section of the i.f. transformer T5 will also be found open.

AK 30 SERIES. Improving sensitivity, selectivity . . . Replace antenna choke with a compensator coil, a center-tapped coil with one end to grid, one to ground and the tap to the antenna post.

AK 30, 40. A common headache is shorting of the wire-wound resistor beneath the chassis to ground. The fibre base warps, causing the trouble, which can be corrected by sliding a piece of fiber under the unit. No reception: Check the speaker filter condenser.

AK 35, 45, 52. Lack of volume. Drill one eyelet on second r.f. transformer support and turn just far enough out of line to keep set under oscillation at high frequencies.

AK 37. Intermittent reception and rasping. Press rear of chassis. If this causes noise insulate shielded antenna cable leading from rear of metal cabinet to front of chassis. It frequently touches the bare ends of the power cable.

AK 37. To increase selectivity . . . Mount three-gang trimmer on top of tuning gang and re-balance with these trimmers connected in the circuit. Make sure that the rotor section is well grounded. Stunt also ok on Model 40.

AK 37, 40. Oscillation, after replacement of r.f. and detector tubes . . . Bend a piece of brass about 1½ in. square in the form of an "L." Drill a hole through it and bolt it in place between the first and second stage tuning condensers.

A. K. 37, 40

Dead . . . replace 0.3 mfd speaker bypass condenser.

AK 37, 40

Installing pilot light in these metal-encased sets . . . Remove the metal cover from the powerpack. Connect two wires to the 1½ volt winding, or terminal strip for the 26 tubes. Connect these two wires to a miniature porcelain base socket and use a 2.2 volt bulb. By means of a small metal clamp, the socket may be placed at any point along the front of the set. Just raise the lid and slip the clamp beneath it.

AK 37, 38, 40, 42. Wire on flat-strip volume control breaks . . . Remove control, solder break and bend flat strip in opposite to original direction so that contact arm rides on unused surface.

AK 37, 38, 40, 42. Low power stage plate voltage or none at all . . . Disconnect one speaker lead and plug analyzer into 71A socket. If plate voltage now appears normal replace speaker output condenser.

AK 37, 38, 40, 42. Use of a 1 mfd., 400 volt condenser between the filament of the 280 where it connects to the first choke and ground increases pep and reduces hum. Try it next time it is necessary to rip open one of the cans.

Add more "Tricks" to this Service Manual. They appear in every issue of Radio Retailing.

RADIO RETAILING'S "Tricks of the Trade"

AK 37, 40, 41, 42, 43, 44, 53, 54, 55, 55C, 60

Installing volume control strips . . . Connect replacement strip across 110 volt, a. c. line in series with a 75-watt lamp for one minute. This will make the strip pliable so that it can be inserted in the control shell without breakage.

AK 37-60. New, double-spring contact arms are available at the factory and make it unnecessary to change entire volume controls unless the wire is shot. Clean the winding with alcohol.

AK 37 to 60. When dial belts are not obtainable use heavy dial cable. Anchor to pulley-pins, spot with drop of solder. Move condenser to take up slack.

AK 40. When biasing resistor strip under terminal board is defective and original replacements can not be obtained use one 750 and one 3,500-ohm type.

AK 40. Oscillation during warming up period . . . Shunt the secondary of the first a.f. transformer with a 250,000-ohm resistor.

AK 40. Fading and low volume, especially where 26's are old . . . Put on additional filament leads from power pack through a hole drilled in side of pack case to filament lugs of first r.f. socket. This will lower drop in leads, raise voltage on 26's and improve performance.

A-K 40, 42. Weak reception. May often be pepped up by replacing detector resistor, which is of glass, grid-leak type, with a variable unit taken from an old B-eliminator.

AK 40, 42. Excessive hum . . . Look for poor connection between ground terminal under resistance strip in power-pack and wire going through insulating compound into pack.

AK 40, 42, 44, 46, 53. To check or replace filter condenser sections . . . Looking from front, panel-side of set, block is at extreme right, next to choke assembly. Three leads connect from block to chokes, blue, yellow and white. Stick a pin into each lead so that it contacts the wire and with an ohmmeter check from pins to ground for short. After locating defective section clip its associated lead close to block, leaving remainder of lead attached to choke assembly. Attach positive side of replacement cartridge type electrolytic to lead and ground negative to chassis.

AK 55 (Early). Intermittent operation after a few minutes of use, reception gradually fading out completely with a buzz . . . Open secondary in second r.f. transformer. Plate lead of 24 comes through this coil and as fault is intermittent it is usually difficult to hit the open period when checking socket voltages. Application of heat from a 60 watt lamp will hasten the opening if this condition exists.

A-K 55. Dead, or almost inaudible. Check detector coupling resistor, which frequently fails. Replace with 25,000 ohm unit. Value not critical.

AK 55. Weak and distorted reception . . . Check two resistors across speaker field. Center tap between them goes to center tap of a.f. input transformer secondary. Value of resistors should be 9,500 ohms.

AK 55, 60. Aligning condensers . . . When pulleys are completely disconnected from shaft and condensers aligned replacement of pulleys generally throws the job out again. To overcome this loosen one screw completely and then loosen the other very slightly, just enough to allow the condenser shaft to turn when the pulley is held in place.

AK 55, 60. Fading can often be traced to loose rivets on wire-wound resistors. In most cases re-clamping them with pliers effects a repair. Check particularly bleeder No. 1, r.f. bias and 1st a.f. bias units, as these work loose more often than other units at the rivets.

AK 55, 60. Motorboating, all parts in detector and a.f. check ok and all condensers working properly . . . Make careful resistance check of all choke coils in r.f. system. A short of only 2 ohms in just one choke will cause this trouble.

AK 55C

Intermittent operation, component parts apparently ok, voltages normal . . . Check secondary of output transformer by temporarily substituting a magnetic speaker. Trouble frequently does not show up on continuity test. Disconnect voice-coil while making this test.

Public ADDRESS HEADQUARTERS

The Operadio line is the profit line. It is priced right. And it is unequalled for completeness . . . including public address systems, speakers, amplifiers, paging systems, microphones and all component parts and accessories. Address Public Address Headquarters . . . Dept. TT for Catalog.



Model 855, The Aristocrat of Base Type Amplifiers, 55-80 Watts



Model 835, Base Type Amplifier 35-52 Watts



Model 124-W, Portable Unit 22-40 Watts



Model 117, Portable Unit 14-26 Watts

OPERADIO
MANUFACTURING COMPANY
ST. CHARLES • ILLINOIS
EXPORT DIVISION: 145 WEST 45TH STREET NEW YORK CITY

RADIO RETAILING'S "Tricks of the Trade"

AK 55 TO 67

Fading, intermittent reception . . . Often due to poor connections at various tubular condensers. Also, resistors are mounted on insulating strips, the connecting lugs being integral parts of these strips. Resistors of metallized variety with solder ends are soldered to rather gingerly by factory to avoid melting and poor connections frequently develop. Test all resistor connections mechanically and electrically, moving them while ohmmeter is attached. Connect ohmmeter prods to lugs rather than to resistors.

A.K.60

Inoperative . . . 1050 ohm flat wire-wound resistor located under red and yellow resistor mounting open. Cut lead where it solders to condenser terminals. Replace with 1 watt carbon unit soldered from this condenser to ground.

AK 50, 60C. Low plate voltage, noisy reception, little volume . . . Check two a.f. grid resistors. One should be 40,000 ohms, the other 65,000. They have a habit of dropping in value.

AK 61. Noisy after about 2,000 hours of use . . . Three filament resistors wound on iron strip commonly overheat, burning insulation and shorting to iron.

AK 80 Series. Hum and distortion not due to condensers or resistors . . . Replace grid resistor in 47 input, also coupling condenser to detector plate.

AK 80. *When volume controls become noisy raise the end of the contact with long-nosed pliers and bend in toward the winding slightly, then clean the strip with alcohol.*

AK 80. Intermittent operation . . . Rub pencil eraser around top of tube sockets before looking elsewhere for trouble. Twisting of tubes on socket in order to find the correct position removes enough solder from the tube prongs to make a high resistance short between socket holes and this is frequently enough to kill the oscillator tube.

AK 80, 82, 83, 84, 85. Intermittent whistle near 700 kc. . . . Replace resistor from grid of 27 oscillator to ground with 50,000 ohms.

AK 82. Oscillation . . . Try replacing a.v.c. plate by-pass with a new $\frac{1}{2}$ or $\frac{1}{4}$ mfd. unit. Intermittent reception . . . Replace screen by-pass condenser.

AK 82. Very poor reception, oscillation, cutting in and out of signals . . . Check mica of i.f. stage plate trimmer. It sometimes either rots or carbonizes and leaks badly, later shorting and then opening. The condenser is one of two trimmers on top of the i.f. transformer, completely inclosed in shield can.

AK 83, 85. Poor tone, low volume and little response with tone control turned to bass. Look for open r.f. choke in pentode control grid circuit. Analyzers miss this one.

AK 84. Weak reception on strong locals, voltages and current ok See if excess wax from field coil has worked into armature, freezing voice coil.

AK 84. Poor volume, or intermittent normal and low volume . . . If all voltages are normal check for an open in the i.f. stopping choke. The leads frequently break under the protective wax where they are soldered to lugs.

ATWATER KENT 84

Dead . . . shorted oscillator plate tuning condenser at right of chassis looking from front. Motorboating . . . suspect second detector bias and screen resistor.

ATWATER KENT 84

Inoperative . . . shorted oscillator plate tuning condenser at right of chassis.

AK 96, 99. Set dead, neon tuning indicator inoperative, 180 volts on i.f. tube grid. Remove coil shield, i.f. shield, and look at the small grid resistor tucked in near the first detector plate coil. Its insulation frequently breaks down, permitting a short. Wrap it in cardboard or fibre.

AK 99. High potential on one control grid cap. Remove i.f. cans, insulate resistors which touch coil forms. Trouble causes neon light to be inoperative and kills all signals.

AK 145

Audio squeal, unaffected by touching 2A7 or 58 grid caps but aggravated by touching 2A6 grid cap . . . Unsolder, remove and throw away metal clamp around 2A6 grid lead at point of grounding. Solder the wire twisted around the grid lead to the point at which clamp was soldered. It is impossible to detect this trouble with instruments.

AK 155. Hum and distortion in these a.c.-d.c. midgets . . . Check dual and triple filter condensers for bad leakage and if it is found replace with 8 mike sections. Also see if volume control has changed value from normal $\frac{1}{2}$ megohm. Before delivering to customer adjust trimmer between tuning condensers and speaker, at top front of chassis, to loudest point.

A.K. 155

Weak, distortion . . . replace .5 meg metalized grid return resistor from 42 grid to ground.

AK 246. Bad audio howl as volume control is advanced with tone control in low position . . . Generally due to defective volume control. Replace.

AK 246. Set stops playing suddenly . . . Check for poor contact on filter choke, where it connects to plate of first detector 58. The brads that hold the connection on both sides of the coil loosen and corrode.

A.K. 275

Bad hum . . . Connect a lead from common ground point to chassis. This set does not use the chassis as a ground return, consequently stray currents picked up in the shields and chassis are carried around to all parts of the circuit.

A.K. 317, 337, 637

No broadcast reception . . . check voltage on oscillator section of 6A8. This should be approximately 185 volts. If lower replace 30,000 ohm plate dropping resistor.

AK 416-446-136

Intermittent or weak . . . shorted .1 mfd. condenser (marked No. 102) between 6F6 cathode and .1 meg. resistor, replace.

Add more "Tricks" to this Service Manual. They appear in every issue of Radio Retailing.

RADIO RETAILING'S "Tricks of the Trade"

A.K. 435

Dead, constant hum. . . . Check for open .05 mfd. bypass in 6K7 i.f. grid circuit. This condenser is C5 in schematic.

AK 465Q. Distortion, sounds like speaker out of adjustment . . . Caused by an open 8 mike electrolytic connected from B-plus at speaker cord to ground. This open also causes howling at times and is almost always diagnosed at first as speaker trouble.

AK 469

Distortion, weak on low frequency end or fades out . . . replace .00145 mfd. fixed padder located under osc. coil with .001 and a small trimmer and tune same as regular low frequency trimmer; I.F. 130 K.C.

AK 511W TUN-O-MATIC. Automatic feature won't shut off, tuning condensers swing to 1,600 kc. ok, but line is not cut . . . Look at nine point normal, off, and automatic switch at right on front panel. Switching blades are a little too wide and sometimes contact two points at once, preventing opening of the circuit. File blades down a little or replace with later type switch available from factory. No reception . . . Look for leads soldered to tone control switch touching housing of volume control and grounding out. These two are mounted so close together on front panel that sometimes the rubber insulated pieces on the tone control leads slip off from vibration. Slide them back in place or bend leads back. Hum not due to circuit faults . . . May be due to reversal of antenna and ground. 5Z3 rectifier and 2A3 tubes also seem critical. Change them when looking for hum.

A-K 612. Distortion on low volume, clear on high volume . . . Due to an open volume control in most cases. Excessive sensitivity (some people object to interference from "honky-tonk" dx) . . . Substitute an 80 for the 83 feeding r.f. stages. Lowering of voltages in this manner does not affect locals.

AK 665. Oscillation . . . See that screen grid stage control lead spring, which serves as a shield, is kept away from the 2A5.

A.K. 810

Motorboating and audio howl check $\frac{1}{2}$ watt carbon resistors, connected from plates of 6F6 tubes through .01 mfd condensers to ground. Open 10 mfd electrolytic condenser across bias has caused excessive a.c. to pass through these resistors, causing them to heat and change value. Replace resistors with 1 watt 10,000 ohm units, condenser is 10 mfd at 200 volts.

AK 812. Bad tone and blocking when volume is turned up 500,000 ohm potentiometer connected to diode plate. 2 of second detector has changed value to about 1 megohm. Shunt with fixed resistor to restore value to normal. Balancing double-spot tuning trimmer, fourth on 5 gang unit Set for minimum signal with oscillator running at 1400 and set dial at 1240.

This space was left blank so you may paste in additional "Tricks of Trade" as they appear in the monthly issues of Radio Retailing.

AUDIOLA

AUDIOLA. Oscillation when tone control is in treble position. Replace .01 mfd. condenser connected from plate to filament.

AUDIOLA 7330. Oscillation. Graphite from tuning gear works under the condenser gang wipers. When replacing wipers, after cleaning, pressure is critical. They should be tight enough for good contact but not so much so that friction is excessive.

AUDIOLA, Jr. Oscillation after some time in service, not curable by re-balancing . . . Insert .0001 fixed condenser between detector plate and ground and then re-balance. To increase volume . . . Disconnect 50,000 ohm resistor section in series with screen-grid lead and replace with 35,000 ohms, raising screen potential.

AUDIOLA 31

Intermittent fading, weak at low frequency end of dial . . . high resistance contact between stator section of gang condensers and lugs. Tighten screws, taking care not to throw stators out of alignment.

INTRODUCING



"A FIXED CONDENSER THAT STAYS FIXED"

KEEP your customers satisfied! Ninety per cent of service calls are caused by condenser breakdown, so why jeopardize customer good will and create a flock of profitless "callbacks" by using inferior condensers.

Use GLASSMIKE the condenser that's absolutely impervious to moisture, and *guaranteed* for a year. It's new, different, sealed in a glass tube, and it costs no more than ordinary condensers.

Ask your jobber for GLASSMIKE—write today for descriptive circular with specifications.

**ASK YOUR
JOBBER
to show you "GLASSMIKE"**

CONDENSER PRODUCTS CO.
1369 NORTH BRANCH STREET
CHICAGO • ILLINOIS

RADIO RETAILING'S "Tricks of the Trade"

BALKITE

BALKITE 60, 70. Alignment data . . . Remove cap of 6A7 and place output wire from oscillator on this cap through .01 condenser. Ground other oscillator terminal to frame of variable condenser. Set dial at 550 kc. with switch in broadcast position. Set oscillator at 456 kc. and, with volume control of set on full, using output meter, align first and second intermediates in the order named. Repeat this for accuracy. Remove oscillator lead from 6A7 and connect it to the antenna post. Set test oscillator frequency at 1400 kc. and align trimmers on variable condensers. Set dial and oscillator at 600 kc. and adjust 600 kc. padder located at side of set for maximum output indication. Repeat high frequency alignment for accuracy. Best results are obtained on shortwave alignment by experimentation. Adjust front coil trimmer at about 15,000 kc. and rear at 6 mc.

BELMONT

BELMONT 71C. Audio frequency modulation of oscillator, audible all over dial . . . Replace 56 grid leak with proper size. It has probably increased in value.

BOP

BOP. Strain on speaker cable breaks connection inside female plug . . . Connections usually broken are either 89 plate lead or B-plus center-tap of output transformer. Indicated by lack of plate voltage on one or both 89's. To repair, slip back shielding over cable about 1 inch, turn the plug cover and slip it back, exposing the lugs and the broken connection. Chevrolet set and some United Motors models require connection from speaker frame to radio chassis when placed on bench. Similar in this respect to older Sparton multi-unit models of home radios. The two wires carrying "A" current in the cable are "hot" A and switch leads. The "A" return is made through the metal firewall of the car.

BOSCH

AMERICAN BOSCH R6, R7. Lack of selectivity . . . Disconnect antenna and ground. Connect short length of wire to antenna post. Tune to a signal between 1400 and 1500 kc. Select a weak enough signal so that the volume control may be operated at maximum. Bring signal to maximum with all trimmers and then go over them a second time. The first trimmer (extreme left from back) is extremely critical. Without moving the dial reduce the volume control and connect the regular, long antenna in place of the short wire. Then re-tune the first trimmer. Advise the user to employ a short antenna, if possible as the set trims up better on one.

BOSCH 28

Intermittent . . . leads from stators of tuning condenser shorting to metal frame of tube and coil assembly at points where leads pass through openings. Replace with new leads.

BOSCH 28. Easy volume control replacement. Remove all old drive gear. Install standard 250,000 ohm unit and hook in circuit so that it will vary B plus voltage to r.f. plates. B plus lead from pack is the one going to one end of the resistor in clips near 26. Hook 1500 ohm grid suppressor resistor from grid of first r.f. to stator of first variable gang condenser in place of original control. Result: greater sensitivity, easier to neutralize.

BOSCH 28, 29. Set completely dead, all voltages normal . . . Check rubber covered wire from antenna variometer to volume control. It sometimes shorts to chassis when passing through drilled holes.

BOSCH 48. Noisy tuning. Clean wipers on variable condensers and don't overlook the one hidden under the mounting of the variometer which turns with the rotors.

This space was left blank so you may paste in additional "Tricks of Trade" as they appear in the monthly issues of Radio Retailing.

BOSCH 58, 60. Replacing dial cables . . . Cut stock 32½ in. long, make loop in each end, 1½ in. in each. Cable should now be 29½ in. overall. Turn condenser gang all the way out, to minimum capacity, then place loop over screw on right side of large drum and bring cable down to threaded spool. Turn spool so that setscrew is facing bottom of chassis and start winding cable at first clear thread above screw, winding on 7½ turns. Bring cable up over idler pulley and insert piece of sponge rubber between threaded spool and its bracket. Run end of cable down around drum and catch loop with piece of stiff wire, hooked on end. Pull cable up into place, making sure it is in groove on drum. Hold good strain on cable and with left thumb press down on spring on drum until the hooked end engages the loop in the cable. Remove hooked wire and sponge rubber.

BOSCH 60. Loss of volume and distortion may often be traced to poor contact at the phono switch which is supposed to cut out the r.f. when the tuning condenser plates are disengaged.

BOSCH 140. Failure of plug-in type vibrator, indicated by continuity between two or more of the five prongs at base (except between those corresponding to grid and cathode of a 27) . . . Due to shorted .01 mfd. condenser inside unit. Open by removing three screws at base and slipping off sponge rubber casing. Replace with small tubular type.

BOSCH 140. Audio-feedback . . . See if grid lead for 75 brought up from below between this tube and the 41 is too close to the latter. Make it hug the 75 by twisting the grid clip, or shield and ground it under one of the feet of an adjacent i.f. can.

AMERICAN BOSCH 150. Short-wave signals in center of dial . . . Check i.f. frequency and oscillator condenser, making sure that coil and tube shields are tight. (I.f. 175 kc.)

AMERICAN BOSCH 242, 243. To improve tone and volume . . . Remove the .05 (C23) audio coupling condenser between detector and first audio. Remove the 1 megohm resistor (R11) in the plate circuit of the 56 detector. This leaves two open leads, one from the volume control and one from the 56 plate. Connect them together.

BOSCH 350. Hum modulation of signal . . . Generally caused by faulty grounding rivet in common return of filament supply and various grid returns. Located approximately in the middle of the chassis shelf, fastening one of the tube sockets in place.

Add more "Tricks" to this Service Manual. They appear in every issue of Radio Retailing.

RADIO RETAILING'S "Tricks of the Trade"

JACKSON

Radio Testing Equipment

MODEL 680 DYNAMIC ANALYZER

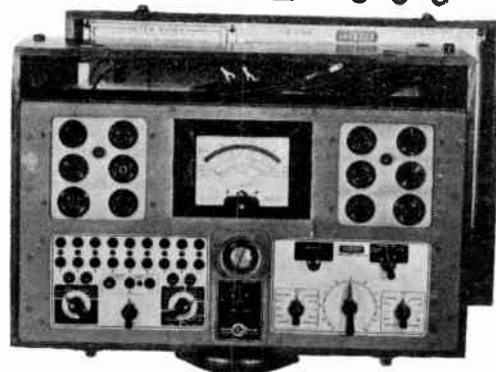

Complete with all Accessories

The Model 680 is a complete "Dynamic Output" tube tester which also includes full provision for radio set testing.

The New FULL-VISION Jackson Meter is an exclusive built-in feature of this tester. This new meter measures 6 inches over flanges. Dial is illuminated. There are scales for A.C. and D.C. volts, megohms, low resistance, microfarads and decibels. All meter ranges are selected by means of a special 18-position switch.

TUBE TESTING—contains a complete "Dynamic Output" tube tester with all of the finest features. Tests all tubes including gas rectifiers such as OZ4, etc. All readings are direct on "Good-Bad" scale. A complete test is provided for all types of ballast tubes. Equipped with DUAL NEON TEST elements. The well known "Dynamic Output" test method assures excellent accuracy in tube testing.

METER RANGES—A.C. Volts: 0-15/150/1500
 D.C. Volts: 0-7½/75/150/300/750/1500
 D.C. Milliamperes: 7½/75/150
 Ohms: 0-100/100,000/1 meg./10 meg.
 Mfcs.: .001 to .15/.01 to 1.5/.1 to 15
 Decibels: minus 10 db to plus 18 db

CIRCUIT ANALYSIS—In addition to point to point tests, the Model 680 may be used for socket analysis of any radio receiver. The instrument has a complete set of sockets and "cut-in" jacks for this purpose. These jacks are numbered to standard R.M.A. tube base pins. A standard 8-wire analysis cable plug and associated adapters is used to connect to the radio receiver. This plug and adapter set is furnished with the instrument.

CONSTRUCTION—Main panel is one piece cast aluminum 19 inches long, 10½ inches wide. Control panels are etched metal having a white background and black characters. Case is genuine oak, measuring 19¾ inches by 13¾ inches by 6 inches.

ACCESSORIES—Furnished complete with one 908 C.N. Cord and Plug Kit for receiving testing; also test prods, jumper leads and batteries—nothing else to buy.

MODEL 680—DYNAMIC ANALYZER \$69.50

THE JACKSON ELECTRICAL INSTRUMENT COMPANY - - DAYTON, OHIO

BOSCH 350. Low filament voltage. hum, pilot light flicker . . . One side of a.c. filament is grounded to lug on rivet holding 2A6 tube socket and base of tube shield to chassis. Imperfect connection at this point causes trouble.

AMERICAN BOSCH 360 SERIES. Intermittent oscillation . . . Tube shields are made of aluminum composition and after being in service for some time corrode where they fit on the shield base. Drill a small hole through the side of each shield and through the base, then insert a small self-threading Parker Kalon screw and the oscillation will generally cease.

BOSCH 370
 Hissing and weak signals . . . open primary in antenna coil.
 Weak oscillation . . . open bypass condenser in same circuit (C33)

This space was left blank so you may paste in additional "Tricks of Trade" as they appear in the monthly issues of Radio Retailing.

BRUNSWICK

BRUNSWICK. Where sets having limited output transformer space burn these units out try a G.E. output unit. Melt it out of its can and insert it in the original container.

BRUNSWICK. Noisy and irregular reception in certain models using rubber tube-covered volume controls . . . Caused by dampness. Replace tube with catheter purchased at drug store if duplicate tube is not obtainable.

BRUNSWICK AC10. Weak signal, all voltages ok . . . Voice coils commonly blow.

BRUNSWICK 11, 12

Shorted tuning condensers caused by broken porcelain insulators in turret assembly . . . use fiber insulators of the same thickness for replacement.

BRUNSWICK 11, 12, 16, 17, 18, 24, 25, 33. Poor volume or entirely inoperative . . . All models use a screen supply resistor of 14,000 ohms, 2 watts, followed by a 1/3 watt, 5,000 ohm unit in the case of the 24 oscillator and another 1/3 watt, 5,000 ohm resistor as a bleeder to ground. These resistors commonly become charred and their values drop to as little as 500 ohms. or they burn out entirely. Replace them with a 15,000 ohm, 2 watt and two 5,000 ohm, 1/3 or 1 watt units. No control of volume although control itself tests ok . . . Look for grounded grid returns in r.f., mixer and i.f. stages. These frequently short to hold-down clamps, cutting out a.v.c. and manual control action. (I.F. 175 kc.)

BRUNSWICK 11, 12, 16, 33, 24, 25. Dial slips . . . To correct loosen and remove nut above the center of condenser assembly. This permits removal of the planetary dial arm. Loosen the two screws holding the tuning knob, tone control and volume assembly. Place cardboard spacer 1/8 in. thick underneath the assembly and tighten again. Replace planetary dial arm.

RADIO RETAILING'S "Tricks of the Trade"

BRUNSWICK 514

Noise and motorboating . . . replace grid leads from condenser stators to tube grids, increase tension on phone switch blades. Dead. . . . Inspect local-distance switch.

BRUNSWICK 15

Noisy, changes volume . . . replace 35,000 ohm screen grid resistor.

BRUNSWICK 15

Oscillation . . . open .1 mfd. condenser across speaker socket. This condenser in condenser pack, green leads.

BRUNSWICK 15

Squealing . . . Usually due to poor contacts at condenser rotor. Contacts are very inaccessible. Drill a hole sufficiently large to permit insertion of a screwdriver through drum and chassis in line with the contacts.

BRUNSWICK 15. Full reception when set is first turned on, gradually fading out. Look for open 25,000 ohm orange resistor in screen-grid supply circuit.

BRUNSWICK 15. Distortion on all stations, reception otherwise ok. . . . Check detector screen by-pass. This often shorts out without affecting voltage readings enough to notice. Check the condenser with a neon lamp to be sure of it.

BRUNSWICK 15. Intermittent reception. Check bypass condenser just behind 45's against back wall of chassis, down inside.

BRUNSWICK 15, 22. Noisy or intermittent reception . . . Check .02 mfd. coupling condenser in a.f. circuit and give set thorough mechanical inspection.

BRUNSWICK 15, 22, 32. Rushing sound like steam escaping, particularly noticeable on lower end of dial . . . Remove shunt condenser from local-distance, push-pull type switch.

BRUNSWICK 15, 22, 42. Noisy volume controls. Unsolder the pigtail from the second r.f. variable condenser stator, remove the rubber sleeve and blow out the powderlike substance found in it. Wipe powder off pigtail and replace sleeve, resoldering.

BRUNSWICK 16. No reception, voltages normal . . . Oscillator screen resistor has probably changed value and the tube won't oscillate. Replace with 5,000 ohm $\frac{1}{2}$ watt unit. The original was a $\frac{1}{2}$ watt size. Distortion, voltages below normal . . . Check same resistor for abnormally low value, practically shorting screen to ground. Inadequate volume . . . Try changing the screen bleeder resistor from 14,000 to 10,000 or 7,500 ohms. Fading or abrupt interruption of reception, voltages normal . . . Check 10 mmf. coupling condenser between r.f. tube and first detector. This is mounted on bottom of one of the turret condensers with a machine screw. The screw loosens and causes trouble.

BRUNSWICK 17. No reception . . . Check for grounding of 14,000 ohm screen resistor at right of chassis between two coil shields, also for .5 mfd. condenser in oscillator plate circuit. These are common faults.

BRUNSWICK 83. Hum and reduced B voltage. Either shorted 45 C bias resistor or charred braided tubing on push-pull transformer leads to resistor strips, forming high resistance shorts to chassis. Lack of sensitivity. Found principally in sets with serial numbers below 80,000, especially those with brown crackle finish. Voltages check ok. Signal can be built up by reducing screen grid cathode 100 ohm wire wound resistor to 25 or 50 ohms, by heating wax off and reversing r.f. choke and antenna loading coil leads to position of maximum signal strength or, by re-aligning condenser gang. Motor-boating. Caused by open circuit in small .1 mfd. tubular condenser fastened to large $\frac{1}{2}$ mfd. tubular condenser mounted under r.f. section. Open circuited $\frac{1}{2}$ mfd. unit causes oscillation. Well over 50 per cent of trouble in the 83 is due to shorted or grounded pig-tailed carbon resistors.

This space was left blank so you may paste in additional "Tricks of Trade" as they appear in the monthly issues of Radio Retailing.

CHEVROLET

CHEVROLET. No signals in this auto-radio, all voltages and circuits ok . . . Replace small, blue Sprague .002 condenser across the lower end of the voltage divider.

CHEVROLET. Intermittent spark noise, not traceable to faulty suppression . . . After a year or so in use, especially in 1931 and 1932 models, the beading along the top pulls away where the side beading connects with the beading across the front. Electrically make a good connection between the open ends with a piece of copper braid and ground to the top of the door post on each side of the car. This should be tried when noise disappears with the antenna disconnected, dome light is cut loose and antenna shield is well grounded to the instrument panel bolt.

BOP CHEVROLET. Pronounced vibrator buzz . . . Remove 75 tube. If noise stops replace tube and short screwdriver across grid to ground. If buzz continues equally loud place 4 mike condenser across B plus to ground. Trouble is due to opening up of filter output condenser.

CHEVROLET 1929, 30, 31, 32. Obstinate cases of ignition interference . . . Bond the body to the frame, or chassis, at both sides, in the front. Right about at the bulkhead is a good spot to do this. This is particularly effective when the car has run up a lot of mileage. Use a piece of heavy shielding and self-tapping screws both in body and in frame. In extreme cases of noise move the electrolock cable and wire up ignition like later model, with one switch in hot lead.

1933 CHEVROLET. To completely eliminate generator interference . . . Connect condenser to second field wire of the generator. Stop-light noise . . . Bridge switch with a 1 mfd. condenser, connecting from terminal to terminal, instead of from terminal to ground, the usual method.

'33 CHEVROLET. Noise, disappearing when antenna is disconnected from set . . . Generally picked up by shielded antenna lead which runs behind instrument panel and is frequently in inductive field of cable running from key to coil. Run antenna lead at right angles.

CHEVROLET 364441 (1933). Oscillator dead on all or part of dial . . . First section of candohm strip, 4,200 ohms, .002 condenser across this resistor and tube all ok. Replace oscillator coil even though continuity test reads perfect.

Add more "Tricks" to this Service Manual. They appear in every issue of Radio Retailing.

RADIO RETAILING'S "Tricks of the Trade"

CHEVROLET '33. Noise, when passenger is seated in front . . . Place shield plate of tin beneath floor boards where feet rest and ground.

1933 CHEVROLET. Remove ignition coil from bulkhead and fasten to motor using valve inspection plate bolt.

CHEVROLET 60049. Severe chassis pickup of noise . . . See if the ground lead is connected to the lighting switch. If so move it to one of the door jamb bolts, or bond the dash to the door jamb bolts and to the fire wall with heavy conductor. The dash is generally a poor ground without this bonding.

This space was left blank so you may paste in additional "Tricks of Trade" as they appear in the monthly issues of Radio Retailing.

CHRYSLER

CHRYSLER "AIRFLOW." Failure to find built-in antenna lead . . . It is brought down the right front corner post, as usual, but is then carried several inches farther, down toward the floor inside the post and then brought out. Necessary to remove screws holding leatherette covering post, reaching behind it for wire. Sets are easily mounted on upper part of bulkhead. Care should be taken that mounting bolts do not extend over one-half inch beyond engine side of firewall as this will prevent opening and closing of hood. In most cases no bond between motor block and frame is necessary. Shield antenna lead up to 1 inch within corner post.

CHRYSLER. Static discharge due to drag emergency brake on driveshaft, occurring whenever motor is not actually driving the car . . . Mount holder for small carbon brush so that it makes contact with the emergency brake drums, insert a brush and ground the holder.

CLARION

CLARION. Broken flexible leads in models having moving dial lights . . . For permanent repair remove clip holding leads to front of condenser gang, loop the leads loosely around condenser shaft once and resolder.

CLARION. Dead set or cutting in and out, late models . . . Antenna connection is extremely close to chassis. Examine it for short before removing set for examination.

CLARION 40. Loud "pop" while set is warming up . . . Replace grid resistor of the 47 with a half-meg instead of the one meg unit originally used.

CLARION AC 40.

Oscillation . . . Place .002 from one side of power line to chassis.

CLARION AC 51

Low volume, low voltage . . . Check 1 mfd. condenser across 900 ohm output bias resistor for short.

CLARION 52, 53. Squeals . . . Clean wipers on condensers, or put them in if they are not already there to facilitate balancing.

CLARION 60, 61. No reception. Check a.f. transformer primary, replace with factory original to insure good tone. Noise, intermittent signals, examine local-dx switch for loose contacts.

CLARION 61. No detector plate voltage. Usually due to open push-pull input transformer. Repair of this special unit often possible. Remove transformer and take off wrapper. Corrosion generally breaks lead from winding.

CLARION 70. Poor selectivity . . . Check for burned out antenna coil. Rewind with silk-covered wire if necessary. Also check volume control for short circuit.

CLARION 100 SERIES. Failure to tune down to 1,500 kc. after few months use. Substitute 2,000 ohm resistor for 4,000 ohm unit in cathode circuit of oscillator-1st detector.

CLARION 220. Dead, 11,000-ohm and 4,100-ohm sections of divider ok, primaries of i.f. transformers ok . . . See if 4,000-ohm bias resistor of 24 autodyne has changed value, preventing tube from oscillating. This is half-watt carbon unit located near and soldered to one end of chassis, bypassed with .001-mfd. condenser. It often increases in value.

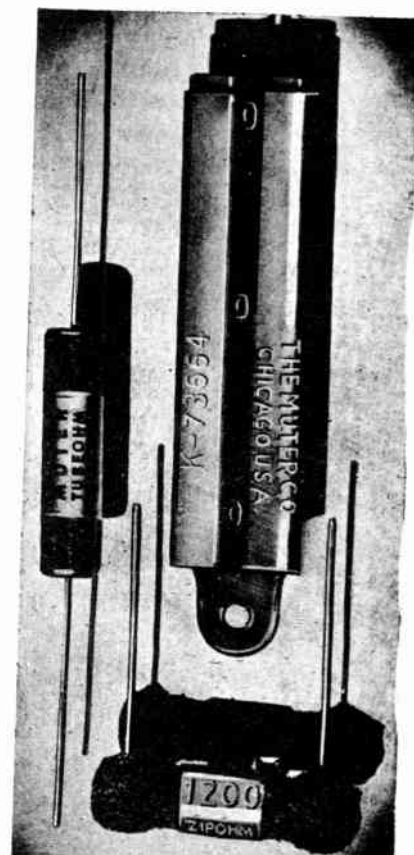

SPECIFY THESE LABELS

WHEN YOU BUY RESISTORS

TUBEORHM — A recently developed 1 watt, wire-wound insulated resistor, low in price. Easily installed. Half inch leads, tinned for easy soldering. Noiseless, Compact. Enclosed in impregnated tube, perfectly sealed against humidity. Values up to 4,000 ohms — each clearly marked.

ZIPORHM — For quicker, better, more profitable wire-wound resistor replacements. Both 5 resistor replacements. Clearly marked. Values up to 25,000 ohms. Shaped flat, for tight places. Leads adjustable, easily soldered. Noiseless. Permanently accurate within 5%. Perfectly moisture and heat-proof.

THE MUTER COMPANY 1255 S. Michigan Ave., CHICAGO, ILL.

RADIO RETAILING'S "Tricks of the Trade"

This space was left blank so you may paste in additional "Tricks of Trade" as they appear in the monthly issues of Radio Retailing.

CLARION 220. No reception . . . Very often traceable to an open control grid clip to the 24A detector-oscillator. The connection between clip and tuning condenser is short piece of 1,000-ohm wire inside a sheath. An open is not readily noticed except by a complete analysis. To remedy, use a 1,000-ohm, $\frac{1}{2}$ -watt resistor in series with a new lead.

CLARION 220. No reception . . . Often traceable to break in sheath-covered 1,000-ohm wire running between grid clip of detector-oscillator 24A and tuning condenser. Replace with fixed resistor and wire.

CLARION 240. Insufficient volume on shortwaves . . . Shunt the 200 ohm fixed i.f. bias resistor with a 75 ohm unit. At police band position on selector switch one contact is not used. Run a wire from this terminal to the terminal of the detector coil next to the antenna. This shorts out the antenna choke.

CLARION 260, 280, 300. These models may be equipped with phono pickup by simply inserting a 5,000 ohm type in the grid lead to the audio type 56. Place a switch across the pickup so that it may be shorted out when not in use.

CLARION 320. If "motor-boating" develops connect the suppressor grid of the 58 i.f. tube to the cathode instead of (early models) to ground.

CLARION 320. Intermittent reception. Replace fixed condenser in 57 oscillator-detector cathode lead with .0008 mica.

CLARION, JR. 320. Speaker rattle . . . Insert a few drops of light oil between pole piece and voice coil. Use it sparingly and there is little danger to coil.

CLARION 360. Excessive bass response . . . Remove permanent tone control condenser and resistor from across output circuit, use variable tone control alone.

This space was left blank so you may paste in additional "Tricks of Trade" as they appear in the monthly issues of Radio Retailing.

COLONIAL

COLONIAL 31AC.

Set dead, no bias on r.f. tubes even though bias resistor checks ok . . . Diagram shows r.f. filament winding in power transformer as being center tapped. Actually, a center tap wire wound resistor is sealed in the transformer case and these open up. Replace with an external 10 or 20 ohm center tapped resistor mounted on transformer terminals.

COLONIAL 31 DC. Set plays with switch off. Disconnect ground lead. If set cuts out trouble is shorted condenser in series with this lead. It is one of three capacities at left of chassis when set is turned upside down on bench with back of set forward.

COLONIAL 32. Loss of volume accompanied by poor tone is usually due to an open first audio bias resistor. These are of the flexible type and breaks generally occur near either end. Unwind a few turns of resistance wire to cut out the break and resolder.

COLONIAL 33-34

Intermittent . . . shorted or broken phono switch controlled by tuning condenser, replace.

COLONIAL 35 AC. Failure of this model to tune between 550 and 500 kc. is due to shorting out of the phono switch by the dial itself. Loosen the nuts holding the switch and push it farther back.

COLONIAL 85

No reception. . . . Remove speaker plug from chassis and test for continuity between two smaller prongs. These are the primary lead of the output transformer which is subject to burnout due to heavy current of parallel 47's.

COLONIAL 600A

Intermittent . . . replace solid grid lead of 6A7 with flexible wire.

COLONIAL C-995. A hi-lo sensitivity switch, which will cut down interstation noise when tuning locals with this a.v.c. model, may be added by removing wire lead between lugs 1 and 2 of the Candohm resistors, connecting a 100 ohm type between the lugs, cutting the ground connection to lug 1 and grounding lug 2. Drill a hole in the right side of the cabinet to receive a switch and connect the switch across the new 100 ohm resistor so that it may be either shorted out or placed in the circuit.

Add more "Tricks" to this Service Manual.
They appear in every issue of Radio Retailing.

RADIO RETAILING'S "Tricks of the Trade"

This space was left blank so you may paste in additional "Tricks of Trade" as they appear in the monthly issues of Radio Retailing.

CROSLY

CROSLY. Slipping of dial on lower-priced models using friction drive . . . Remove dial and note if tension spring is held by washer headed onto shaft. Knock off washer and remove spring and back piece of brass. Note whether or not a shoulder has been worn in the brass. If so, file or grind this off, replace and rehead the washer onto the shaft. If impossible to rehead push washer down tight on spring, hold and solder. If it seems impossible to remove spring and brass piece take the friction part and fit a piece of stove pipe wire into the slot into which the dial edge fits. Be sure it is cut in such a length as will fit snugly and force it in tightly.

COLUMBIA

COLUMBIA SG-8

Oscillation when volume control is advanced . . . insert a 5000 ohm resistor in the grid circuit of the detector.

COURIER

COURIER 65. Oscillation, all usual remedies fail . . . Connect .1 condenser from contact of volume control (opposite the grounded contact) to ground on chassis.

PEERLESS COURIER. Incomplete volume control . . . Replace 800 cathode bias volume control with 5,000 or 10,000 type.

CRANE

CRANE 5. Distortion, intermittent reception . . . Check 500,000 ohm, $\frac{1}{2}$ watt resistor in first a.f. and output stage. Replace with same value but in 2 watt size.

CROSLY. Certain Mershon condenser models hum and may be repaired by drilling a $\frac{1}{4}$ inch hole in the bakelite top of the electrolytic unit, being careful not to damage the "innards," filling with distilled water to a point about $\frac{1}{2}$ inch from the top and closing up the hole again with sealing wax. Discharge the condenser before drilling.

CROSLY BAND-BOX. Variables slip on their shaft in this model, making the set squeal and howl. Trouble is often difficult to find as condensers are mounted upside down.

CROSLY FIVER. Be sure 6.3 volt and not 2.5 volt pilot is used as reduction in heater drain caused by use of smaller bulb permits voltage to rise and causes erratic oscillator operation, frequently intermittent reception.

CROSLY Roamio. New sets which are insensitive except at trimming adjustment points should be examined for reversal of first detector antenna and grid coils. These are small units of the choke type.

CROSLY SHOWBOX. Fading. Try soldering a piece of wire on bottom of aerial lug and fastening the other end under the screw at the top of the aerial and ground strip. Distortion or dead set. Apply heat with soldering iron to the case of the a.f. condenser. Then push back high potential terminals.

CROSLY Showbox. No r.f. plate voltage. Shorted 5 mfd. condenser bypassing B-supply lead is reported as most common cause.

CROSLY Totem. Smoke. Heat from filament resistor melts filter condenser compound. Re-mount resistor and plate choke. Takes 20 minutes.

Do You Know
this about
**OPERADIO
SPEAKERS?**

Operadio is probably the largest producer of speakers in the world.

Our output this year will be around 2,000,000 speakers.

The facilities of two large factories are devoted almost exclusively to the manufacture of speakers and component parts.

In radio sets everywhere, in countless P. A. Systems, you will find Operadio speakers doing a good job of reproduction. Carrying the most complete line of P. A. and radio replacement speakers on the market today, you can serve yourself and your customers best by letting "Speaker Headquarters for the Nation" supply your speaker needs.

Address Dept. TT for data on our complete line of speakers.

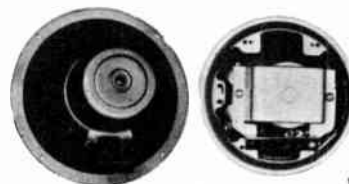

SPEAKER HEADQUARTERS FOR THE NATION ! !

OPERADIO
MANUFACTURING COMPANY
ST. CHARLES • ILLINOIS
EXPORT DIVISION 145 WEST 45TH STREET NEW YORK CITY

RADIO RETAILING'S "Tricks of the Trade"

CROSLEY MUSICONES and DYNA-CONES. Repair data on types A to F, inclusive . . . If cone is crushed . . . Remove from speaker. Iron out with fairly hot flatiron, holding point of iron snugly in center of cone. Swing back of iron from side to side, pivoting on point. Iron out only a small portion at one time, shifting cone around. A large magazine should be placed under the cone. Do not use water to dampen as it may cause blisters. Too hot an iron will burn cone. Before replacing unit always straighten out the armature pin, put a drop or two of oil on the adjusting screw, center the adjusting screw accurately. After replacing cone be sure that base seats snugly without having a tendency for "star" to crush into it, or cause cone to bulge. Adjustments . . . Have speaker playing. Screw in until it rattles. Screw out until it rattles. Count the number of turns between these two adjustments and turn the screw back in half that number of turns. This centers armature.

CROSLEY 5M3

Dead . . . shorted section of electrolytic condenser in can above chassis.

CROSLEY 7H3

Motorboating . . . Frequently caused by high-resistance ground connection in the shielded wire going to the grid cap of the 6B7.

CROSLEY 7, 10. Tube hiss . . . Connect 2 or 3 meg. resistor in series with screen of first detector 58, bypassing with 400 volt, .01 condenser. For better high-frequency audio response . . . Clip one lead of dual condenser used in tone control circuit. On dual 10 clip tinned wire coming out of end of condenser nearest tone control. On dual 7 clip tinned bare wire from end of condenser to plate of 2A5. This does not affect tone control operation.

CROSLEY 8H1

Excessive hissing between stations . . . Change 6F7 cathode resistor, a small, flexible type mounted on the back of the chassis, from 500 to 250 ohms. Also, shunt a 2,000 ohm resistor across the cathode bias resistor of the 6D6, nearest the power transformer.

CROSLEY 8H1. Common trouble . . . Balancing condensers located on top of i.f. coil cans short out to mounting screws, due to plates of condensers being out of line. Thus, when moved out of their original position they touch the grounded mounting pillars.

CROSLEY 27, 28. No reception, weak signals or intermittent reception . . . Check for faulty 1 mike bypass connected between s-g of 32 detector and ground. It is in a can, with two terminals exposed. Each terminal is a separate condenser with the common connection to ground.

CROSLEY 30S. Failure of replacement volume control to permit reduction of level to minimum required . . . Short 3,500 ohm resistor, in series with the control, completely out of the circuit.

CROSLEY 30S, 31S, 33S. Improving volume and tone . . . Put a 15,000 ohm resistor between positive side of the 55,000 ohm detector plate resistor and ground.

CROSLEY 30S, 31S, 33S, 34S. Common trouble which should be checked before wasting time on analysis . . . Sockets readily short to chassis as holes in chassis admitting them are too small for safety.

CROSLEY 30S, 31S, 33S, 34S

Apparent shorted coupling condenser . . . Check socket prongs to ground. Chassis socket holes sometimes are too small to clear prongs.

CROSLEY 40S. *When tone is bad, pep lacking and an analyzer check shows positive bias on the first audio tube, replace the by-pass condenser connected between the detector and the first audio grid.*

CROSLEY 41S

Noisy and distortion at high volume . . . replace 440 resistor under chassis. Check first r.f. coil for intermittent short.

CROSLEY 42

Insensitive, low volume . . . replace large 6000 ohm carbon resistor with wire wound 10 watt unit. The value of the original resistor has increased greatly due to overload.

CROSLEY 42S. Low bias voltage on the detector, distortion . . . Frequently due to leakage between sections of the dual .5 condenser by passing detector and first a.f. bias resistor.

CROSLEY 42S. Over-sensitivity . . . 5,500 ohm bleeder frequently opens; raising all voltages.

CROSLEY 53, 54, 57. Noise and distortion, sounding like defective speaker. Look for trouble in coupling condenser between detector plate and 45 grid. Replace with unit which will withstand 300 volts.

CROSLEY 58

Dead . . . Suspect metal cased condenser containing r.f. plate, screen and cathode bypass (part #W7753). It frequently shorts out, sometimes burning one or both of the Candohm resistors at the back of chassis. As a safety first measure solder the speaker plug to its socket connections under chassis. This is a constant source of noise and intermittent reception as plug often works loose.

CROSLEY 58, 59. Hum, not traceable to filter trouble . . . Replace 1 megohm resistor in 47 grid circuit, connecting to high-voltage secondary tap.

CROSLEY 72AF

Oscillator will not track . . . replace mica condenser connected across oscillator trimmer. Condenser open or making poor contact.

CROSLEY 77, 84, AMRAD 84. Fading in and out . . . The remedy is often simply replacement of .1 mfd. condensers coupling r.f. coil sections to ground. It is rarely necessary to replace more than one.

CROSLEY 120

No reception, crackling . . . shunt 2000 ohm resistor across divider section supplying oscillator plate.

CROSLEY 120

No reception, background noises but not signals. . . Shunt 2000 ohm resistor across divider section supplying oscillator plate.

CROSLEY 122. Type 24 oscillator fails to oscillate at low frequency end of dial and new 24A won't work at all in this dynatron circuit . . . Shunt a 1-watt, 750-ohm resistor across 650-ohm volume control and 24A will go to work.

CROSLEY 124. Fading. Look for cold-soldered joint on i.f. transformer lug.

CROSLEY 124

Oscillation, sounds like loose voice-coil, small capacity from 47 grid to 47 grid clears it up . . . Caused by inductive pickup by leads of 47 tube grids from audio transformer secondary. Remove leads from present position between detector and i.f. sockets and fasten with string or tape to mica condenser on side of chassis.

Add more "Tricks" to this Service Manual. They appear in every issue of Radio Retailing.

RADIO RETAILING'S "Tricks of the Trade"

CROSLY 124. Breaks into oscillation when light is snapped on or off anywhere in house . . . Move wires leading from a.f. transformer to grids of 47 from between socket terminals of 27 detector and 51 i.f. screen terminal and tie them near the detector choke.

CROSLY 124-1. Fading and intermittent reception . . . Generally due to high leakage in one of the four .1 condensers located in condenser-block No. W22412. Also check the two .25 mfd. units and the .5 mike in block No. W23736 for high leakage. (IF 175 kc.)

CROSLY 124-1. Fading, signal returns to normal volume if set is switched off then on again, or if tube is pulled out and then re-inserted . . . Replace condenser block W22412 which contains four .1 condensers.

CROSLY 127. Sudden drop in volume accompanied by failure of the tuning meter. Partial short in the i.f. transformers.

CROSLY 129. Oscillation at high frequencies after usual tests have shown up nothing . . . Check value of fixed portion of volume control. It should be 200 ohms and is critical. If necessary, put in a 25 ohm resistor in series, raising the value of the fixed unit to 225 ohms.

CROSLY 130. Oscillation, lack of volume, hum . . . Check for failure of 4 mfd., 300 volt section of dual cardboard type dry electrolytic. Use a 450 volt job in this position.

CROSLY 130. Dial off frequency, or frequency settings "drift" . . . Do not adjust oscillator trimmer until you are sure the dual filter and screen grid 8 and 4 mfd. condenser is not leaky or open. Original unit breakdown voltage is 300 for the filter section, 150 for the screen. Replace with 450 volt and 200 volt sections. (IF 181.5 kc.)

CROSLY CHIEF 132. When this 12-tube super plays, but volume is shy and all tubes, voltages check ok . . . Unsolder .0001 condenser between cathode of 56 used as diode detector and 5 meg. resistor and check it for a short. This trouble is difficult to locate and relatively common.

CROSLY 146. Local stations received weakly, voltages ok . . . Look for open 12 mike condenser section of dual filter and cathode 6 mike cardboard encased unit. Replace, if "out" with 12 mike 400 volt job. Lower breakdown units will not last.

CROSLY 148-FIVER.

Set dead below 1,200 kc., volume control inoperative after half revolution, oscillation over entire band . . . Suspect the 6-8 electrolytic and substitute another for test as it sometimes shows up ok with respect to leakage and still causes trouble. Use a higher breakdown type.

CROSLY 148. Dead, or weak signal . . . Generally due to increased value of wire-wound, impregnated resistor under chassis from i.f. coil to plate and cathode of 58. Replace with two-unit type with an 8,500 ohm and a 25,000 ohm resistor, 10 watt types.

CROSLY 148, 167, 169. No reception, voltages ok . . . Sometimes due to shorting of intermediate transformer tuning condenser suspended in square hole cut in chassis between 58's. Caused by puncture of mica spacer when screw is driven down too tight. Slip small piece of mica under hinge part of condenser plate and re-align. Also check for similar trouble in the other postage-stamp condenser located on top of the chassis. Oscillation . . . Try a .02, 600 volt condenser from ground to power transformer side of a.c. switch. Never use a 2.5 volt pilot in chassis having 42 tube as this causes fading; stick to 6.3 or 6.8 lamps.

CROSLY 148

Intermittent reception . . . High resistance short often develops in the padding condenser due to entry of dust and dirt. Clean with carbon tetrachloride.

CROSLY 148. If set cuts out or works poorly on low line voltage replace 2.5 volt pilot with a 6-volt bulb. The pilot is wired across the 6.3 volt tube circuit and sometimes reduces heater voltage to below normal.

CROSLY 148. Periodic drop in volume, distortion. See if the twin cub condenser in resistance-coupling network between detector and a.f. is reversed. The .03 should be the coupling condenser between 57 plate and 42 input grid. One terminal of the .001 should be grounded and the other connected to the detector plate. Some condensers have wrong markings and the .001 is incorrectly connected between ground and a.f. tube grid.

CROSLY 156. Failure to oscillate, regardless of volume control or regeneration control setting. Remove regeneration condenser and bend plates away from each other.

CROSLY 158. Local stations barely audible with volume on full . . . Look for open 750 ohm resistor connected from grid of 58 to ground.

CROSLY 160. Poor tone and lack of volume . . . See if 59's are matched. If trouble is experienced in matching push-pull stage plate currents connect a 100 ohm, $\frac{1}{2}$ watt resistor, preferably non-inductive, in series with each control-grid right at the sockets.

CROSLY 167. Set works on high frequency end but dies out on low, or cuts in and out . . . The .1 mfd. condenser across the 3,500 ohm resistor in the cathode circuit of the first 58, the first detector-oscillator, shorts out and sometimes partly shorts.

CROSLY 167. Low volume and distortion . . . Frequently traceable to leak between filter condensers and cathode by-pass section for the 2A5.

CROSLY 167

Oscillation all over dial when volume is turned on full, noise like foghorn with control at minimum . . . Look for open or lowered value electrolytic filter block on underside of chassis directly beneath power transformer. To locate defective unit shunt 8 mike, high voltage test unit across one at a time.

CROSLY 168. Pronounced hiss in background, on all stations, even when correctly tuned . . . Try several new 2A6's, 56's and 2A5's. If this does not help put from 400,000 to 100,000 ohms across the primary of the first i.f. transformer, using the highest permissible value.

CROSLY 170. Improving tone and volume . . . Connect a 2 to 4 mike bypass across the a.f. stage bias resistor. Improving sensitivity . . . Reduce value of diode load resistor from .5 meg. to .35 or .4 meg. This will also reduce background noise.

CROSLY 170. Repeated burning out of 80 rectifier . . . Cause is electrolytic condenser, part 29097, which shorts and then cleans itself. Replace it.

CROSLY 170, 171.

Loss of volume and noisy operation . . . Examine .0005 tubular condenser in series with antenna coil.

CROSLY 171

Q. A. V. C. won't work, poor volume . . . Bad section in candohm resistor part number W28471.

RADIO RETAILING'S "Tricks of the Trade"

CROSLLEY 515

Weak, or intermittently weak . . . Section 7Z (.02, 200 v., 6D6 cathode bypass) of part W28623 dual tubular condenser is probably at fault regardless of how it may test. Snip leads and substitute a single replacement unit.

CROSLLEY 601. Filament rheostat shaft shorts to metal panel, heating wire and destroying fiber insulation without damaging wire itself. Equip shaft with insulating bushing, fill in between wire turns where charred with heat resisting cement and pulverized asbestos, smearing mixture on wire to hold it firmly. When dry, scrape mixture from contact surface with knife.

CROSLLEY 608 GEMBOX

Common faults, in order of occurrence in the field . . . Failure of 0.5 condenser under chassis, power transformer lamination hum. To cure such hum loosen several lockbolts, hit laminations gently with hammer to set them. When hum stops carefully tighten bolts, tapping again while this is being done if hum reappears. Noisy volume control. Clean or replace. Gentle sanding with 0000 sandpaper and rub with vaseline cleans many satisfactorily. Freezing of dial. Replace drive gear or repair by smoothing burrs on gear and holes where it turns. Freezing of regeneration control. Replace. Poor tuning, cuts off near 100 on dial. Check tuning condensers for spacing and tracking. Burrs frequently short condensers when over half meshed.

CROSLLEY 610

Fading, hum . . . loose rivet on filament centertap resistor. Remove resistor and clamp rivet tighter in vise.

CROSLLEY 706. No plate voltage on r.f. tubes. Caused by shorting of .5 mfd. condenser.

CROSLLEY 706

Fuse blows . . . replace fiber bushings on field supply.

Voltage divider gets extremely hot . . . replace .5 mfd. condenser from center arm.

Noisy tuning . . . burrs on stator tuning plates. Can be cleaned off with long sharp knife blade.

Dial light flickers, noisy . . . replace A.C. switch.

Poor tone, volume increases when one output tube is removed . . . Small wires on "F" type speaker unit broken.

CROSLLEY 706-60. Excessive hum despite ok circuit check. Replace 27 detector with a 56 and connect 1/10 mfd., 200 volt condenser from chassis to detector heater at fourth terminal from front of chassis on brass strip connecting pack with chassis.

CROSLLEY 715

Intermittent reception accompanied by oscillation. . . . If set operates normally when finger is placed on grid cap of 2B7 tube at rear of chassis replace defective 3 section filter condenser (part #36056).

CROSLLEY 715

Intermittent reception accompanied by oscillation . . . if normal when finger is placed on grid cap of 2B7 at rear of chassis replace defective 3 section filter (part No. W-36056).

CROSLLEY 814

Distortion, poor volume and sometimes no signal . . . Open 10,000 ohm candohm resistor section. This is from screens to ground.

This space was left blank so you may paste in additional "Tricks of Trade" as they appear in the monthly issues of Radio Retailing.

This space was left blank so you may paste in additional "Tricks of Trade" as they appear in the monthly issues of Radio Retailing.

DAYRAD

DAYRAD 381. Burnout of the input voltage control by insertion of tubes in incorrect sockets may be avoided by wiring a 2½ volt pilot light in series with one side of the line. In addition to its fuse action the lamp also shows when the meter is on and off. A 110 volt neon glow lamp wired across the line after the control resistor makes a good adjustment indicator. It glows when at 110, goes out on less and is too bright above.

DELCO

DELCO 630, 500. Common complaint is lack of reception on stations that are not local, but which should nevertheless be within range . . . Due to blocking of weak signals by noise-suppression circuit. To correct make the following simple wiring change: Remove the wire connecting the ground end of the volume control to the chassis ground. Connect this ground lug of control to cathode of 6D6 tube. In some instances it is found that the above change results in the appearance of vibrator noise not bothersome before. To eliminate it after making the suggested change connect a 100-ohm resistor in series with the 275 ohm common bias resistor for the 6D6 and 6B7 tubes. Put it between the cathodes and the old resistor, re-connecting the bypass condenser across both the old and new resistors. Connect the lead from the volume control to the junction between the resistors.

DELCO R-1119

Repeated blowing of line fuse during warm up period . . . Replace 3 mfd. 250 volt electrolytic condenser with 400 volt unit.

DE WALD

DE WALD 61

Distortion, hum . . . look for short between cathode of 41 and positive filament of 37 socket.

Add more "Tricks" to this Service Manual. They appear in every issue of Radio Retailing.

RADIO RETAILING'S "Tricks of the Trade"

EARL

EARL 21, 31

Noisy reception . . . Variometer used in these sets is insulated from chassis by means of a narrow bakelite strip. This strip and the variometer itself are held in place by two screws. Tighten these screws.

EARL 31, 32. Replacement dial assembly . . . Where an original replacement cannot be obtained, and it rarely can be, substitute a Philco 90 dial assembly. The only change in construction necessary is the filing off of five rivets holding the dial scale of both units, fitting the Earl scale to the Philco mechanism.

ECHOPHONE

ECHOPHONE S-5. No signals . . . Remove cardboard cover from coils at end of chassis. Move coils close and keep at 90 degree angle.

EDISON

Edison. Where 24's and 27's have sub-normal plate voltages check back from them to resistor terminals and remove the r.f. amplifier can with its associated resistors. Open can and isolate shorted by-pass condenser. Reassemble unit and rewire. Connect a tubular .1 or .5 mfd. condenser from the high side of the resistor to ground.

EDISON, SPLITDORF. When double-section carbon volume controls connected across two plate coils fail a good replacement repair can be made by grounding the center arm of a 10,000 ohm, variable-taper potentiometer, connecting the off-side point to the antenna post through a shielded lead and the on-side point to the end of the 600 ohm bias resistance on the 226's which formerly went direct to ground. The leads to the plate coils from the original controls could be cut off and taped. Then the regeneration switch control should be converted into a local-distance switch, throwing a .003 condenser across antenna and ground to provide control on loud locals.

EDISON R1, R2, C1, C2. Three major weaknesses . . . 12,500 ohm series plate, 1500 ohm c.t. 50 bias and 25,000 ohm loss resistor. The first two have asbestos washers at the ends. These absorb moisture and transmit dampness to resistors, shortening life. Replace with bakelite washers. The third resistor should be replaced with a 10 watt job whether it tests ok or not.

EDISON R1, R2, C2. Weak reception, set will not regenerate around 550 kc., even though regeneration switch is in proper "up" position with all voltages, tubes and circuit parts checking ok . . . Look for poor ground from two 1.5 mike plate bypasses located in center part of chassis near volume control coupling shaft. Solder flexible lead from their common ground to chassis. Also pigtail rotor of tuning gang, tighten antenna binding post (or solder it directly to the post itself), tighten all bolts in gang and tighten two bolts in single turn voice coil under speaker. When drawing up bolts on gang use extreme care not to move stator sections out of alignment.

EDISON R1, R2, C2. To pep up these receivers and reduce hum . . . Replace 27 detector and 25 first audio with 56's, using the 2.5 volt filament winding originally supplying the detector. Remove gridleak and grid condenser and bias the new 56 detector with a 40,000 ohm, 1 watt cathode resistor, by-passing with .1 mfd. This should feed the detector plate about 150 volts. Bias the first audio 56 with 2,700 ohms in the cathode circuit, by-passing it properly.

EDISON R1, R2, C2. Intermittent operation . . . Most common causes are either one of the three 600 ohm grid suppressors opening or a shorting trimmer condenser on the gang. Quickest way to locate these faults is to tune in a station, turn the volume control to maximum and then with insulated tool move each trimmer slightly, then move the suppressors, noting if there is any change. No signal, all resistors check ok, power transformer, audio units likewise ok and no grounds anywhere . . . Often caused by open 3 mfd., 1000 volt filter section. Connected from one side of high voltage secondary to 81 center tapped filament. Intermittent distortion and weak signals . . . Sometimes due to loose screws connecting speaker voice coil to output transformer. Tighten them with wrench and screwdriver. Weak reception is also due in some cases to slightly weak 26's, too short an antenna or improper alignment. The nut holding lug to antenna binding post sometimes comes loose.

EDISON R4

Installing dial cable . . . Remove two gang condensers on the left, also tuning mechanism and dial. Tearing of the cable is often due to insufficient turns on drum shaft. Drum should have 4 or 5 turns on it. No reception . . . Aluminum wires on cone sometimes open up.

EDISON R4, R5, C4. Steady crackle regardless of volume control setting . . . Detector choke is usual offender. Fine wires ground partially to case. Choke may be left out temporarily, replaced later with 50 to 65 millihenries. Regeneration at low kilocycle end of dial . . . Open .001 condenser from detector plate to ground. Located under detector hum adjuster and choke sub-panel. Regeneration at high kilocycle end although properly neutralized . . . Check by-pass condensers on top chassis, especially .1 mfd. unit from 2nd and 3rd r.f. cathodes to 2nd and 3rd r.f. plate circuits. Apparent impossibility of neutralizing first r.f. stage . . . Check .1 mfd. condenser from 1st r.f. cathode to 1st r.f. plate circuit and if ok check other capacitors in same container. Distortion at low volume on weak stations . . . Usually thin edge of Jensen speaker cone rubs on pole or field housing, or filings in field housing at voice coil clearance points. Remove speaker head assembly and sandpaper all fuzzy material and wipe out voice coil space. Distortion on powerful stations at low volume . . . Defective 10,000 ohm section of volume control. Ordinary ohmmeter will not usually show it up. Shrill sound started by snapping room lights on or off . . . One of power tubes is not drawing enough plate current, either because it is a weak tube or because low voltage is applied to it. Tubes should draw not less than 25 mills. Rapid deterioration of 27 tubes, tone not just right . . . Trouble usually starts with open 10,000 ohm (8,000 in 25 cycle) loss resistor which is located in power pack. Plate voltage rises to around 150 volts instead of the normal 115 and by-pass condensers of top chassis frequently break down. This resistor should be checked annually, especially in damp locations. Burning out of detector hum adjuster . . . Usually caused by a short between primary of power transformer and 2.5 volt filament winding. If another transformer cannot be purchased easily the set can be kept in operation by disconnecting the hum adjuster entirely, replacing the detector with a tube of later design. Installing new tone control . . . Remove on-off switch and install control of approximately 15,000 ohms, switch type. Connect one side of control to ground and other side through .1 (or .05 if less depth required) to 1st audio plate. In this position it will not reduce volume as much as if the conventional grid circuit connection is used.

EDISON R6, R7

Pronounced rumbling or drumming when very low-frequency bass is being reproduced . . . Voice-coil strikes field housing at bottom of voice-coil passage. Remove speaker head assembly and insert thick, cardboard washer to give the coil more travel distance.

RADIO RETAILING'S "Tricks of the Trade"

EDISON R6, R7. Weak signals, low plate voltages on all r.f. tubes, 1,000 ohm resistor in detector circuit gets hot (detector filter resistor is the left of the three square units in top chassis) and 3,500 ohm, 2 watt resistor in power chassis heats . . . Common cause is shorting of .05 condenser located in detector filter unit and connected from 3rd r.f. plate to ground. Weak, or no signals, low or no screen voltage on r.f. stages and hot 17,500 ohm, one watt resistor in r.f. filter unit (R.f. unit is the center unit of top chassis) . . . Invariably caused by shorted .5 mike condenser connected between 2nd and 3rd r.f. screens to ground, located in r.f. filter unit. Pronounced rumbling or drumming sound on low audio frequencies . . . Commonly caused by voice coil striking field housing at bottom of voice coil passage. Remove speaker head assembly and insert thick cardboard washer to give voice coil more travel distance.

This space was left blank so you may paste in additional "Tricks of Trade" as they appear in the monthly issues of Radio Retailing.

EMERSON

EMERSON T, TS. Improper detector 24 plate and 47 plate current . . . Replace coupling condenser, grid to plate, with .01. Noisy tuning . . . Bend up contact springs on rotor or attach pigtail to chassis, not to end plates. Failure of TS to oscillate on shortwaves . . . Attach lead to grid of 24 and bend in place near or around coil mounted on back of 24 shield. Adjust until oscillation occurs uniformly across dial.

EMERSON 5A

Insensitive . . . replace 14,000 ohm cathode resistor on 85 tube. Resistor has greatly changed value.

EMERSON U6D. Frequency drift, requiring constant retuning in the broadcast range . . . Frequently trouble will not appear when chassis is removed from cabinet and placed on bench but will reappear again in the cabinet. Trouble is in midjet type compensating condenser in series with broadcast oscillator coil. Drill $\frac{1}{4}$ inch holes in the cabinet base near this condenser to ventilate it and drift, due to heating, will disappear.

EMERSON M-AC-7. Hum, after being in service several months, not due to open filter or other common causes . . . Check high voltage winding of power transformer with an ohmmeter. The winding sometimes partially shorts, throwing the center-tap off.

EMERSON 20A, 25A. Excessive oscillation . . . Remove antenna wire coil from inside case. Even a small amount within chassis causes trouble.

EMERSON 26. Complete or partially distorted output, intermittent distortion or whistling . . . Defective 15,000 ohm, $\frac{1}{2}$ watt resistor dropping screen voltage of 57 second detector. Replace with 1 watt unit. (I.F. 456 kc.)

EMERSON 26

Overloading on strong signals . . . second detector plate resistor has greatly increased value: replace with lower value.

EMERSON 30 AW, 33 AW, 250 AW, 321 AW, 350 AW

Motorboating, intermittent . . . Replace .01 mfd. coupling condenser on grid of 43. Also change $\frac{1}{2}$ meg. grid resistor to 100,000 ohms.

EMERSON 32

Hum, no reception . . . open in condenser block beneath chassis. Shunt an 8 mfd condenser across terminals.

EMERSON 36

No screen voltage . . . shorted or leaky .02 mfd. screen bypass. Often this causes the 9000 ohm section of the voltage divider to burn. If damaged replace divider with 9000 ohm 2 watt and 27,000 ohm 1 watt.

EMERSON 107-W

Distortion . . . check resistance from 43 grid to ground, should be approximately 1 meg. Lower reading indicates breakdown in C22, a .1 mfd condenser.

This space was left blank so you may paste in additional "Tricks of Trade" as they appear in the monthly issues of Radio Retailing.

ERLA

ERLA, BRANDES. Cutting out often caused by defective local-distance switch. Contact material becomes loose in spring. Put contact in tapered hole and centerpunch around edge to re-tighten.

EVEREADY

EVEREADY 1, 2, 3. No voltage on r.f. tubes. Look at large Pyrohm in B lead. Volume controls may be replaced without using the old pulley and cable arrangement by placing the new control where the old control arm was fastened, lengthening the leads and re-neutralizing.

EVEREADY 30, 40. Oscillation at high volume level . . . Check line voltage. If ok adjust variometer on end of condenser gang shaft by loosening mounting screws and turning variometer stator.

EVEREADY 50

Economical repair when high resistance section of dual volume control burns out or goes bad mechanically . . . Remove defective section and substitute a 50,000 or 75,000 ohm, 2-watt fixed resistor. Control will be satisfactory in most locations.

EVEREADY 50 SERIES

Motorboating at high volume . . . Check screen grid divider (part No. 2996). Replace with a 20 watt wire-wound unit.

EVEREADY 52. Intermittent or continuous a.c. hum . . . Poor contact between common ground return of filter condenser block and its can. Wire is found just inside end of can where cover is soldered, to tin box.

Add more "Tricks" to this Service Manual. They appear in every issue of Radio Retailing.

FADA

FADA. Slipping dial on early models having separate driving drum. Loosen setscrews and give drum half-turn. This brings unused portion into play. If drum is worn all around remove and file down on one end of bushing. This permits it to slip farther into drive unit and cures trouble.

FADA. Slipping dials are the pet weakness of some of the older models. Remove the drum from the condenser shaft and lay it flat on its wide side. File about 1/4 of an inch of metal off the flat side of the dial "neck" which normally rests against the spacing collar. When replacing it push it hard against the spacing collar before tightening the set-screws. This causes the edge of the drum to be firmly wedged in between the plates of the drive assembly.

FADA. Some of the older models use special knobs equipped with tension springs which fit in a notch cut into the shaft. To hold these in place while replacing knobs first put a little soft pitch or candle tallow in the notch.

FADA RA. Weak reception, voltages ok. . . . Try another 56 oscillator, no matter how high the old one tests. Noisy volume control . . . Try a new 56 in the first a.f. socket before replacing control. Continuous "static" . . . Cut out primary of push-pull transformer and couple with 25,000 or 50,000 ohm resistor and .01 condenser from plate of 56 to grid of 47. If customer likes a nice rain-barrel tone use .1 mfd.

FADA 25-Z

Dial slips check clearance between dial drum and volume control.

FADA 25-Z

Volume control inoperative Green 20,000 ohm resistor grounding.

FADA 25-Z

Weak, poor tone replace .25 mfd. 400 volt condenser from ground to green resistor at center bottom of chassis with 8 mfd. electrolytic unit.

FADA RK 100

Interference check leads from power unit to receiver. They are in a metal shield which should be grounded to car frame.

FADA 66.

Oscillation on one of more shortwave bands Connect 300 ohm, non-inductive resistor in series with the control grid lead to the 24A first detector-oscillator.

FIRESTONE

FIRESTONE 1322. Speaker rattle Look for loose solder in speaker. Microphonics Loosen condenser rubber washers and tighten all nuts and screws. Case buzz and rattle Loosen Parker-Kalon screws, take cover off, bend, replace.

FORD

1933 FORD. To get suppression at coil remove the three screws and terminal nut and take the coil off. Pull out the carbon brush and spring, saving the spring and discarding the brush. Make a suppressor from a 40,000 ohm one watt carbon resistor of good quality by cutting it to the same length as the old brush. Clean off paint and file recess in one end to accommodate the spring and re-assemble the coil, using the suppressor as a brush. 40,000 ohms is recommended as the resistance is reduced by cutting and filing.

F O R D - MAJESTIC. Persistent motor noise when antenna is off Due to leakage through ventilating louvres in back of case. Cut piece of copper screen same size as back of chassis and fasten to case over louvres with self-threading screws holding the case together.

FORD-MAJESTIC. Set performs ok on bench, but when lid is pressed down, in car, cuts in and out while riding Put paper discs in top of tube caps so that these cannot short to shields.

FORD-MAJESTIC. In types using separator vibrator, blown fuse or heavy "A" drain Probably due to blown .01, 1000 volt condenser located across power transformer secondary. Replace with .01, 1200 volt unit made up of two .02, 600 volt tubulars if single unit is not on hand. Can containing transformer, rectifier tube and vibrator unit easily removed by unscrewing nut and lock washer holding down unit and lifting out. Before replacing check contacts for burned wires. Excessive current sometimes melts solder and burns two vibrator wires. File points, resolder and remount. Failure of 6Y5 in models using this type Replace with 84, changing socket to 5 pin type and discarding wire originally connected to spray shield. If excessive noise is heard connect .25 or .5 mike low voltage paper capacitor directly across filament of rectifier. If filter blows replace with dual 4, 4-6 or 4-8 dual as value is not critical.

This space was left blank so you may paste in additional "Tricks of Trade" as they appear in the monthly issues of Radio Retailing.

FAIRBANKS MORSE

FAIRBANKS-MORSE 238T32. Noisy reception Due to vibrator unit being tightly mounted to the chassis. The factory uses only one screw in mounting this unit although it is drilled and tapped for two. Insert 1/4 inch of sponge rubber washer between the metal washer under screw head and bottom of chassis. The marked improvement is well worth the trouble.

FAIRBANKS MORSE CONSOLE MODELS

Acoustic feedback insert 1/4 in. rubber grommets on screws between tone projector and speaker.

RADIO RETAILING'S "Tricks of the Trade"

FORD-MAJESTIC. Repeated breaking or fraying of cable where set is mounted in floor . . . Use number 10 spring-steel piano wire, fishing this through from control head end of sleeve to replace old stranded cable. With this new wire slack, a troublesome feature of the stranded stuff, disappears.

FORD-MAJESTIC. Set completely dead . . . Plug in and note ammeter drain. If abnormally high remove transformer pack and replace small vibrator condenser at side of transformer. If screen voltage is absent remove speaker and plate cover to right of speaker and then replace the brown resistor.

FORD-PHILCO N. No signal, voltages and tubes ok . . . See if padding condenser soldering lugs mounted on tuning condenser frame have punctured through insulating paper glued to fixed condenser can beneath, grounding out i.f. Slip new piece of heavy insulating fibre under the lugs, if this is the trouble, and bend the lugs up.

FORD-PHILCO 1934. Periodic drop in volume accompanied by sharp click . . . Look for wires to terminals on inside of i.f. coils touching trimmer rivets and changing condenser capacities. (I.f. 260 kc.)

1935 FORD. Noise from ignition after all usual methods of clearing it up in these cars fail. . . Scrape paint off under side of hood where it fits on the cloth head of the body. Wrap bare copper wire around head and ground it at each speed screw fastening the head in place. The hood will then make good electrical contact with the body and frequently clears up radiation of the racket to the antenna.

FORD 35. Dial jumps calibration . . . Remove cog-wheels from dial assembly. Lightly beat out cog-wheel which holds pointer with hammer until it thoroughly meshes with intermediate driving gear.

1935 FORD. Inability to quiet ignition noise, despite standard suppression . . . A 1 mike condenser from the hot storage battery connection on the gasoline gauge to ground is essential. Other filtering tricks suggested are: Complete shielding of hot A lead from battery to set and shielded wire from resistor connection on instrument panel to distributor, removing old wire. Ground shield to cowl, engine and body.

FORD 35. Low volume, sensitivity ok, cuts on and off . . . Header speaker code leads often short to steel spring used as their support. Remove leads from support to remedy.

FORD III. Lack of sensitivity at high-frequency end . . . Replace 8,000 ohm cathode resistor in 38 autodyne circuit with 6,000 ohms.

FORD V-8 NOISE ELIMINATION

Ignition interference . . . insert r.f. choke, made by winding 12 to 14 turns of 14 d.c.c. wire on $\frac{1}{2}$ in. form, directly at the fuse terminal with other end direct to lead to set. This "Hot A" lead should be as *short as possible* and shielded right down to the set, grounded only at the set end. Try several small mica condensers from 50 to 250 mmf. between r.f.c. and open end of shield.

This space was left blank so you may paste in additional "Tricks of Trade" as they appear in the monthly issues of Radio Retailing.

GENERAL ELECTRIC

GE, RCA. In avc equipped models locals sometimes snap in and out as they are tuned-through. Substitute a new 35 for those in RF and IF stages until the trouble is found.

GE C14. Operates at low volume on long antenna and will not play at all on regular car type, volume control has no effect . . . Check for open .02 (C16 on diagram) mfd. condenser connecting diode section of 6B7 through variable arm of control to grid of triode section of same tube.

GE H31, H51. Intermittent reception . . . Check primary of i.f. transformers. Trouble is usually in the second. Distortion at low volume settings of the volume control on locals . . . Usually caused by drop in value of 110,000 ohm unit on resistor strip.

GE 40. Noise after standard suppression has been installed. Ground rubber-mounted triangular plate of tuning control sheath to side of chassis.

G. E. K-40A

No volume . . . worn insulation on antenna lead where it passes through chassis.

GE K40A. Weak and distorted reception . . . Most common cause is excessive leakage or total shorting of double 4 mike electrolytic condensers. The most troublesome unit is the one connected in the 25Z5 circuit, the next best bet the one in the 77 or 78 cathode circuits. Sometimes the set does not operate after these condensers are replaced. If this trouble is encountered, try changing the 25Z5 tube even though it shows up ok in a checker. If the rectifier is causing trouble usually the 38's plate current will be abnormally low while other voltages seem to be about right.

GE B40, RCA M34

Hash, difficult to remove even with all condensers replaced and vibrator points functioning properly . . . Be sure screws holding vibrator in place are tight, shielding of cable to control head is ok and securely soldered to base of vibrator. Shield ends of two screws holding red and green wires coming out of vibrator base. Make this extra shield in form of box without lid, soldering to chassis at end of terminal board over screws. Depth of box should be sufficient to clear the screws nicely as they are at high potential.

FREED

FREED M89-90

Fading . . . replace .02 coupling condenser between 55 and 56. Vibration or tapping will cause this condenser to short.

FRESHMAN

FRESHMAN G60. Critical volume control and fluctuating volume with control set near maximum . . . Connect jumper from filament end of control to arm, or ground to chassis. This also gives smoother than original control.

Add more "Tricks" to this Service Manual.
They appear in every issue of Radio Retailing.

RADIO RETAILING'S "Tricks of the Trade"

GE 40B (RCA). Loud roar after set warms up . . . Check for arcing at vibrator points. If found, connect 500,000 ohm resistor across transformer secondary, the terminals of which are brought out to two insulated screws. Connect two .01 mfd. condensers across secondary, in series, grounding midpoint between them. Use 600 volt capacitors.

GE B40 (RCA M30). Fuses blow immediately upon being installed . . . Most often caused by shorted .03 mfd. condensers in vibrator base.

GE 5-42B (RCA R-43)

Distortion at high volume . . . a few shorted turns on one side of primary of input transformer (No. 7265). Check by inserting milliammeter in each of p.p. plate leads and compare current peaks on loud signal. Any marked difference indicates defective transformer; replace.

GE S42. Noisy, or cuts out when jarred . . . Before removing chassis try removing 35 i.f. tube and 24 first detector and tightening bolt between them. It works loose quite often and inasmuch as it holds the oscillator coil in place and provides a ground for this coil trouble may be this alone.

GE K43.

A.c. hum, especially noticeable on stations, in early models . . . Connect 500 ohm resistor from set side of .01 antenna condenser to chassis. Later models came through with an r.f. choke in this position.

GE K50P, K54P, K60P, K65P.

Shortwave switch does not fall in place when knob is turned . . . Due to falling out of clip which fits into slot on shaft, holding the shaft in place. Leave out clip and, instead, cut a slot in the end of the shaft so that a floor nail can be fitted into the slot. Solder the nail to the shaft. When the switch is turned the nail will fall against either one side or the other side of the protruding bakelite wall, holding the switch in place in either position.

G.E. L-50

Dead, low B voltage . . . open 8 mfd tubular voltage doubling condenser mounted under chassis.

GENERAL ELECTRIC A54.

Oscillation or distortion at low frequency end of broadcast band when tone control is in high, counter-clockwise, position and not when it is in low . . . May be due to open in capacitor C27 or high resistance solder joint to this condenser.

GE K62, RCA R11

Motorboating . . . Connect a .1 across the resistor mounted inside the antenna coil.

G.E. 63, 65

Intermittent on one band only. . . . Small insulating ceramic bushing on band switch broken. These bushings are held into switch by pressure and may be replaced easily.

GENERAL ELECTRIC A63, A65.

Distortion . . . Open or partly open 6F5 plate resistor, R8 in diagram, 250,000 ohms.

GENERAL ELECTRIC A64, A66, A67.

Severe a.c. hum . . . Accidental contact between high voltage a.c. terminal of the 5Z4 tube socket and the electrostatic shield of the cartridge by-pass condenser C23 causes a hum unlike poor filtering.

GENERAL ELECTRIC A67.

Noise, resembling interference gradually becoming distortion . . . Defective 500,000 ohm, 6F6 grid resistor. Sometimes hard to locate as it measures correct value when set is turned off.

G. E. A-67

Poor tone and distortion . . . change output grid resistor from 500,000 to 150,000 ohms.

GE J80-RCA R8

Crackling and weak reception . . . first audio primary. There are two transformers sealed in can, no room to mount another. Change to resistance coupling. Substitute 100,000 ohms for primary and 300,000 for secondary, couple det. plate to audio grid through .05 condenser.

GE K80X, K80, K85. Failure to operate at high-frequency end of "C" and "D" bands, or even failure to operate over these bands at all . . . Try several new 2A7's in oscillator socket. Oscillation howl on strong signals . . . Enclose grid lead of 2B7 second detector inside cylindrical tube shield.

G.E. E81, E86

Loud background noise . . . Change cathode resistor of 6K7 first i.f. to 25000 ohms.

G. E. A-82, A-87

Weak . . . The fixed padder (C-46) across the secondary of the second i.f. transformer should be 65 mmf. In a few instances this condenser has changed value sufficiently to throw this stage out of alignment. The trimmer (C-45) will not peak and all signals will be weak. Replace C-46 with another 65 mmf. capacitor.

GE J83. Fading . . . Replace 50,000-ohm resistor under r.f. coil with a 60,000-ohm unit and resolder all oscillator coil connections.

G. E. 86

Static but station cannot be tuned in. . . . Shorted condenser in sentry box under 6A8 tube. To replace, unsolder all leads on sentry box, remove front dial screws, lift up dial assembly, pull out band shaft, remove front section of sentry box from bottom.

G.E. E91, E95, E101, E105, E106, R155

High noise level . . . break cathode connection of 6K7 first i.f. and bias through 10,000 ohm half watt resistor. Bypass with .05 mfd. condenser.

GE J100, J105. 10 mike capacitor with yellow lead to lug on volume control opens, causing oscillation . . . When replacing watch polarity as ground is positive in this circuit.

G. E. 105

Off calibration . . . check afc. 6J7 and 5Z4 tubes before adjusting trimmer condensers.

GE M106 Sensitivity poor on shortwaves all or part of time . . . Check r.f. and detector condensers by-passing coil returns to ground. Dial slips on fast speed knob setting . . . Remove chassis and bend down three contact springs on tuning knob shaft.

GENERAL ELECTRIC J107.

Stuttering, volume same as when avc tube is pulled out . . . Replace C38, C21, C19, C36, C35. These are, in the same order, 10 mikes at 200 volts, .5 at 600, .1 at 600, 10 at 400 and 10 at 400. Trouble is due to high resistance short between capacitors.

GE 118.

Continual frying noise with volume control either at minimum or at maximum . . . Frequently due to induction from the a.c. transformer leads running under the resistors. Using an insulated screwdriver, move the leads down or out until the noise stops.

RADIO RETAILING'S "Tricks of the Trade"

G.E. A-125

High sensitivity, crackling, no AVC . . . shorted .05 mfd on screen of 6K7 AVC amplifier stage. This is a 200 volt unit, replace with higher voltage rating.

G.E. 155

Motorboating, normal operation for a few minutes then a thump followed by poor quality. . . . Look for poor ground connection of triple section condenser in corner close to 6L6 tubes. This connection is under a group of bypass condensers and is welded instead of soldered.

GE 1937 MODELS

Pilot light burnouts . . . insert 150 ohm resistor in centertap of high voltage winding, also 15 ohm resistor in series with colorama lights. This offsets high line voltage.

This space was left blank so you may paste in additional "Tricks of Trade" as they appear in the monthly issues of Radio Retailing.

GENERAL MOTORS

GM. Where tone quality of models using horizontal tuning dials is bad although plate potentials on final 45's checks O.K. do not condemn the push-pull transformer. Look for a defective tone control variable resistor. Replace it with a 500,000 ohm unit.

GM 50 SERIES. Volume weak, plate voltage low . . . Look for leaking or shorted r.f. plate condenser. It is generally the top one in the 3-pile assembly that goes bad so don't unsolder the others until the top one is tested.

GENERAL MOTORS 110

Mushy tone. . . . Replace 250,000 ohm detector load resistor.

GM 120, 130. Hum, reception normal . . . Replace .1 mike condenser located under a.c. terminal strip.

GENERAL MOTORS 120, 130, 140.

Weak reception or dead set in serial numbers below 29100A or 1700B, all voltages, condensers and resistors apparently ok . . . Strap a 200 ohm, 10 watt resistor across the 240 ohm section of the voltage divider used for bias to decrease control grid voltage of tubes and snap up sensitivity.

GM 120, 130, 140. Intermittent drop in volume but set does not go dead . . . Tighten screws holding stator plates on gang condenser. Both top and bottom screws should be tightened. Or, solder wire lead between top and bottom lugs. Same trouble common in other sets, such as U. S. Radio 27, where grid lead is connected to one side of stator plates and coil is connected to opposite side.

GENERAL MOTORS—LITTLE GENERAL

Intermittent oscillation or fading. . . . Check all resistors and condensers, ground variable condenser rotor.

This space was left blank so you may paste in additional "Tricks of Trade" as they appear in the monthly issues of Radio Retailing.

GLORITONE

GLORITONE. Oscillation at high frequencies despite cleaning of tuning condensers and wipers and checkup of by-passes, voltages, etc. . . . Put two turns of wire around control grid lead of tube not shielded and ground to frame.

GLORITONE 26. Cutting in an out, accompanied by oscillation or howling. Usually caused by open screen-grid or cathode resistor by-passes. These are all in one can beneath r.f. coil shields. Cut old leads off to condensers and mount separate .25 mfd. unit between r.f. cathodes and screen to frame. When making this repair it will be necessary to run a new wire direct between cathode terminals on the sockets and another wire between screens on sockets.

GLORITONE 26, 26P. Howling or whistling . . . See that lead from antenna post to volume control runs from post to corner of chassis and from this point to next corner, thence to control. Slide it under all other wires so that it rests directly on the metal chassis all the way around.

GLORITONE 26

Low volume . . . change 45 output tube to 2A5. Bias resistor should be 400 ohms at 2 watts. Bypass with 5 mfd 35 V. electrolytic condenser.

US GLORITONE 27.

Low volume . . . Frequently due to defective speaker field. Coil may test ok with an ohmmeter but opens under load. Test by touching metal screwdriver to core with set in operation, note magnetism.

GLORITONE 27. Installing pilot light . . . Remove chassis from cabinet and note small opening just below volume control and just over the dial. In this opening solder a pilot light socket to the chassis so that the bulb will set over the dial. The chassis furnishes one current lead. Carry the other to the proper filament prong of the 45 and install a 1.25-volt bulb.

GLORITONE 99 (APEX). Distorts at high volume level . . . Usually due to open 4 mike electrolytic. Also check 400,000 ohm resistor from 47 grid to voltage divider for change in value or open circuit causing high pentode plate current. If 47 is weak, other tubes ok, this may be the cause.

Add more "Tricks" to this Service Manual.
They appear in every issue of Radio Retailing.

RADIO RETAILING'S "Tricks of the Trade"

GREBE

GREBE SK4. Oscillation between 550 and 750 kc. Tighten all contact clips on variable condenser rotor shaft down all the way. If this cures the trouble release them enough to permit easy operation of the dial. Clean with pipe-cleaner dipped in alcohol and align.

GREBE SK-4

Annoying 60-cycle hum, filter condensers ok . . . Replace 0.1 condenser mounted at detector tube.

GREBE S.K.4

Low volume . . . Check aligning condenser at extreme right of tuning gang for high resistance leak. Distortion at low volume is caused by .25 meg. resistor from c.t. of p.p. input changing value.

GRUNOW

GRUNOW. Capacity of condensers marked only with part number:

NUMBER	CAPACITY	VOLTAGE
28717	.002	700
28719	.004	700
28720	.005	700
28721	.01	500
28722	.04	400
28723	.05	400
28726	.1	400
28729	.5	100
28876	.02	500
29135	.1	100
29170	.017	500
29453	.01	400
29564	.075	100
29567	.02	400
29662	.15	200
29812	.04	500
29813	.004	700
29818	.003	700
29990	.02	400
30143	.05	100

GRUNOW 5E

Motorboating, intermittent . . . Replace part No. 28726, a .1 mfd 400 v. plate filtering condenser.

GRUNOW 6C, 60

Distortion . . . a.f. coupling condenser leaky. As a matter of routine it is advisable to replace this condenser regardless of complaint.

GRUNOW 6D

Hum . . . Late models used 12 mike condensers across the 6000-ohm bias resistor connected to 75 cathode. In early models this was omitted and hum developed later. Install low voltage 12 to 20 electrolytic. Voltage is only 2 or three volts across the bypassed resistor.

GRUNOW 6D.

Intermittently refuses to start once it is turned off . . . Replace 75.

GRUNOW 7A. Intermittent or no reception . . . Common cause is defective .1 condenser in block back of tuning gang, identified by green lead which, with two red leads, is connected to a common terminal at the left rear of the shortwave switch. Use a 600-volt replacement. Also replace 1,000-ohm resistor located nearest filter condensers on resistor bank, as this is usually ruined by failure of the condenser described above.

GRUNOW 7-A. Volume drops intermittently but set does not go completely dead . . . Check two .1 mike condensers connected between lower end of r.f. coils and ground. Located in small can fastened to bottom of coil shields. Lugs on the can are blanks. Connections made by wire leads inside shield.

GRUNOW 7A. Motorboating and blocking . . . Due to two large square coil shield cans mounted together under condenser gang working loose. Ground with heavy wire from each can to chassis.

GRUNOW 8A

Low volume, high plate current on output tube . . . Low resistance short of the output tube's bias resistor due to leakage from filter condensers through fibre protective covering to close-fitting can.

GRUNOW 11A. Oscillation . . . Drill out rivet used for mounting shield and socket of 6C6, replacing the rivet with a 6/32 brass machine screw. The placing of a soldering lug under this screw on the underside of the chassis and grounding of this lug to chassis does the job without disfiguring the radio.

GRUNOW 660, 661, 662. Bad distortion when volume is advanced . . . Suspect high resistance leak in .01 audio coupling resistor, sometimes of the order of 5 megohms. A neon tester will catch this trouble but an ohmmeter will frequently pass it up unless used on an extremely high range.

GRUNOW 660

Mushy reception01 mfd. coupling condenser between plate of 75 and grid of 42 leaking. Resistances as high as 5 to 10 megs is sufficient to impair reception. Replace with 600 volt type.

GRUNOW 1101. Volume on full all the time, no control . . . Replace remote control cable or remove short between blue wire and metallic shield over black wire. (IF 262 kc.)

GRUNOW 1191, 1291

Low volume, volume control ineffective except in extreme off position . . . high resistance short in control. Oil from shaft has leaked on element.

GRUNOW 1191, 1291

Set dead but tuning eye operates . . . Check for open 205 ohm 6F6 cathode bias resistor.

For high pitched tone check speaker terminal strip. One lead from output transformer broken.

GRUNOW 1291

Part of dial dead . . . dial shorting one lug of volume control.

This space was left blank so you may paste in additional "Tricks of Trade" as they appear in the monthly issues of Radio Retailing.

GULBRANSEN

GULBRANSEN 9. Fading is usually due to defective local-dx switch. Move the wires leading to it and if fading occurs replace switch.

GULBRANSEN 75. "Static" on all stations, tubes and voltages ok . . . Traceable, as a rule, to defective plate choke coil in 24 detector circuit.

GULBRANSEN 92, 93. Tubes burned out for no apparent reason . . . Note position of B-limiting resistor connected from socket of 33 to filament prong of second detector. Arcs occur between this resistor and a nearby filament wire. IF: 175.

RADIO RETAILING'S "Tricks of the Trade"

HALSON

HALSON AC-DC

Difficulty in obtaining dial lights for these and similar sets using the pilots in series with tube filaments . . . Shunt 25-ohm resistor across pilot socket and replace bulb with 6-8 volt pilot. Set will thereafter continue to operate even though pilots burn out.

HALSON N.S.40

Burns out 25Z5 and pilot light . . . replace 25Z5 socket which has blown over to ground. Pilot light is the 2.5 volt variety.

HOWARD

HOWARD 67

Low volume and poor quality . . . High resistance leak in 0.25 condenser by passing 6F5G plate resistor to ground is most common cause.

HUDSON

'34 HUDSON. Noise suppression . . . Install a dual condenser on the generator, one directly on the temperature indicator at the radiator, another directly on the oil gauge connection at the bottom of the motor pan and also one on the gas gauge directly on the top of the tank. This can be reached back of the rear seat as there is a door for access. Also use condensers in the dome light lead and coil supply lead right at the coil. It is also frequently necessary to shield the high tension lead from the coil right up to the fire wall. And the low tension lead from coil to distributor should be removed from the spark plug duct and shielded.

This space was left blank so you may paste in additional "Tricks of Trade" as they appear in the monthly issues of Radio Retailing.

INTERNATIONAL

INTERNATIONAL J. Hum . . . Test for defective resistor connected to plate of second detector 24 and in series with 60,000 ohm resistor to screen of 35 r.f. tube. Replace with 500,000 ohms if defective.

INTERNATIONAL KADETTE.

Voltages normal but no reception . . . Insulating washers between gang condenser and chassis often slip, allowing condenser to short. Loosen screws, re-set washers and tighten.

KADETTE 1200, 2200

Distortion on strong locals . . . no a.v.c. is incorporated in original wiring causing first detector to overload. Insert .0001 mmf condenser between grid of this tube and condenser gang. Also connect 2 meg. resistor from grid to ground and 1 meg. from grid back to i.f. transformer side of second detector load resistor. This procedure will supply an a.v.c. voltage to first detector.

This space was left blank so you may paste in additional "Tricks of Trade" as they appear in the monthly issues of Radio Retailing.

KELLOGG

KELLOGG 533-536. Sudden or gradual decline in volume, returning to normal with sharp click. Check small blocking condensers mounted on variable condenser gang. Replace with identical values.

KELLOGG 523, 526

Hum . . . Connect a .02 600 volt condenser from high voltage contact on 80 tube socket to ground. Try both contacts as one is more effective than the other.

KENNEDY

KENNEDY AC-DC. Audio howl not due to tubes . . . See if one connection of volume control is touching speaker frame intermittently at frequency of howl.

KENNEDY 4 AC-DC. Trouble on 25-cycle lines . . . Always use a voltage regulator and set it on the lowest voltage tap provided. Without this the set will almost always develop hum ripple, completely blurring out reception.

KENNEDY 4-TUBE AC-DC.

Balancing . . . Set should be balanced in its metal case. Drill small hole in metal case just over the balancing screw in the condenser gang. It will be scarcely noticeable and helps you do a real job.

KENNEDY 20. Oscillation . . . Usually traceable to defective bypass in detector plate output filter. If present at only a few points on the dial test all bypass units and if none are defective wind a few turns of bare copper wire around the flexible control grid cap of the second r.f. tube, terminating one end of the wire just within the coil shield. Or, lower screen voltages by unsoldering supply lead and re-soldering it to the unused tap next to the original tap on the divider.

KENNEDY 52. Microphonics . . . Not due to tubes, as might be expected but to r.f. currents being picked up by speaker leads. Run the leads in grounded braid, or, cut the string holding these leads together and wind the ground lead around them.

KING 94

Dead . . . check tubular r.f. plate bypass for short. There are three condensers, one adjacent to each r.f. coil. Pitch in defective unit often bulges out.

Add more "Tricks" to this Service Manual.
They appear in every issue of Radio Retailing.

RADIO RETAILING'S "Tricks of the Trade"

KOLSTER

KOLSTER-BRANDES B15, B16.

Poor volume . . . Replace all wire wound grid resistors with new 3,000 ohm units.

KOLSTER K20 SERIES

Oscillation, howling at high setting of volume control; stations near high frequency end of dial apparently go off scale . . . Look for break in grid circuits of r.f. amplifier. Resistors in these circuits are wound of delicate wire, easily corroded and open-circuited. Replace, if defective, with wire-wound resistors.

KOLSTER K23

Noisy, even when all r.f. tubes are removed . . . Clean grid leak clips and replace leaks with new ones.

KOLSTER 42. Weak signals with volume full on, voltages and tubes ok . . . Replace leaking grid condenser in detector circuit with .0025 mf.

KOLSTER K43. Excessive hum, filter ok . . . Look for defective 250,000 ohm (orange) resistor between one terminal of first a.f. transformer secondary and center-tap of hum adjustor control.

KOLSTER K45. Distortion at high volume level is sometimes due to loosened voice-coil windings, these rubbing against the field coil core.

KOLSTER K140. Weak reception, fading . . . R19, a 1-watt resistor of 25,000 ohms, in screen circuit, located at the end of chassis farthest from power transformer and R21, a 10,000-ohm, 1-watt unit located near it, change value. Replace both with 10-watt units. Difficulty in aligning receiver due to unstable i.f. amplifier . . . Align all transformers exactly to 175 kc., find the one which seems to be least stable and turn its trimmer all the way in. This seems to give better selectivity and stability than staggering. To locate unstable stage place screwdriver near each, noting the one in which most change is introduced.

KOLSTER International. Fading, after a few minutes of operation . . . Often caused by shorting of resistor located near volume control to one of control terminals.

KOLSTER, ZENITH. Where sets of this type, using filament rheostat for volume control in 26 circuits do not provide satisfactory volume variation . . . Remove volume control entirely, solder filament leads to control together. Use a 500,000 ohm potentiometer across output of first a.f. transformer, center tap of potentiometer to succeeding tube grid. The rotor of the potentiometer should be insulated from the grid.

This space was left blank so you may paste in additional "Tricks of Trade" as they appear in the monthly issues of Radio Retailing.

LYRIC

LYRIC J. Distortion . . . Usually caused by 500,000 ohm center-tapped resistor located near power transformer opening. Replace with two 250,000 ohm, 2 watt types in series.

LYRIC S6. Tone distorted, everything appears to check ok . . . Replace 200,000 ohm resistor in circuit of unshielded tube on rear of chassis if value is materially higher than this. Plate voltage will appear normal on an analyzer.

LYRIC S6.

Distortion at low volume control settings, clear reception when control is advanced . . . Defective 1 megohm resistor located on power transformer; colored brown, black and green.

LYRIC S7. Blare, muffled reception . . . Replace 250,000-ohm resistor in 47-pentode circuit and $\frac{1}{2}$ -mfd. condenser in plate of screen-grid circuit.

LYRIC S-8

Low volume accompanied by crackling . . . Replace .002 mfd. condenser connected from second detector plate to cathode. Excessive oscillation on high end of dial can be remedied by replacing 0.1 mfd. condenser connected to oscillator coil at top between first detector grid and oscillator coil. Realign set.

LYRIC S8, K69. Weak signals. Look for shorted 5 mfd. condenser in screen grid circuit.

LYRIC U55. Oscillator refuses to work consistently . . . Shunt the 4,000 ohm resistor, in the center of the chassis underside, with 7,500 ohms, raising the oscillator plate voltage.

LYRIC K69. Muffled tone, low volume . . . Check 1-mfd. condenser in detector circuit, one of two next to filter block. If shorted replace both, as second usually causes trouble later. Weak reception, tone ok . . . Check for partial short in screen-grid condenser.

LYRIC 70, 73, 75. Hum is commonly traceable to shorted 0.5 mfd. by-pass located in filter pack and connected to red 25,000-ohm resistor. Condenser is not connected to common ground so external replacement is simple. Hum, with distortion is traceable to short of either 0.5 mfd. audio by-pass units. Locate by tracing lead to green 1,200-ohm resistor connected to cathode of first audio.

LYRIC S80. Low volume, fading and generally poor reception . . . Common fault is change in value of 16,000-ohm resistor connected from plate circuits to screens and 15,000-ohm resistor connected from screens to cathodes. Use 10-watt replacements.

LYRIC 90, 96. Excessive plate current in the push-pull stage is often caused by the socket prongs shorting to chassis. Analysis generally fails to show up this trouble as the tester plug pushes the lug away from the metal. The 0.5 mfd. section in the bypass can beneath the chassis usually fails before others. Intermittent or noisy reception is generally due to an unsoldered lead from r.f. choke to plate prong on socket, or to unsoldered grid leak lead to detector grid prong.

LYRIC 450

Weak, insensitive . . . Corrosion at lugs of first r.f. coil. Clean lugs and leads and resolder.

LYRIC L6RT, 454A

Short waves dead except for 19 meter band . . . do not touch padders on oscillator. Replace 2 mfd. 350 v. condenser as this unit has lost capacity. To check, bridge the new capacitor across the old unit.

LYRIC V-500

Hum . . . line resistor under chassis leaking to ground through asbestos insulation. Insulate metal retainer from chassis with fiber washers.

RADIO RETAILING'S "Tricks of the Trade"

MAJESTIC

MAJESTIC. Models using pilot as resonance indicator. Set dead or distorted. Look for open or shorted winding on center leg of indicator transformer in r.f. and i.f. plate circuits. Replace. For temporary repair short out winding by bridging two outside terminals and using 3.2 volt pilot.

MAJESTIC. No signal or signal produced when set is jarred, types having speaker mounted on chassis. Look for broken lead to voice-coil. Vibration frequently breaks these.

MAJESTIC

Weak, crackling . . . check spray shield on all tubes to see if shield makes good contact with base pin. If poor connection is found, a small wire wound around tube where the base joins the glass will bond the base pin wire to the shield.

MAJESTIC 9P3

Detector plate choke frequently opens . . . Can be replaced with a 25,000 ohm, 1-watt resistor.

MAJESTIC 15

Irregular volume, dead spots . . . replace G51 tube with '24 and ground cathode.

MAJESTIC 15

Dead . . . check .1 mfd. condenser in plate circuit of oscillator-detector. If this is shorted it burns the 2000 ohm plate draping resistor.

MAJESTIC 15, 55

Restoring lost sensitivity . . . Connect fixed condenser of about .0005 between the two stator sections of the pre-selector and tuning sections of the gang condenser. In other words, between the grid of the first tube and the secondary of the pre-selector coil. Re-align.

MAJESTIC 15. Set dead although voltages check ok . . . Place blanket over back and let run from 3 to 4 hours.

MAJESTIC 15. Operates satisfactory only at certain positions of the dial . . . Try changing first detector-oscillator cathode resistor to 5,000 ohms, instead of the original 10,000. The tube is probably overbiased.

MAJESTIC 20. Testing with separate meters . . . Cut loose 3 wires on end of chassis running to by-pass condensers. Solder 8 inch jumpers between ends of severed leads. Then clip the string cabling these leads and the bottom can be pulled far enough away to give complete access to voltage divider and other parts.

MAJESTIC 20

Weak or no reception, low voltage . . . shorted .1 mfd. condenser in first I.F. transformer can. It is unnecessary to melt tar; remove can and slit on side near red lead. Bend metal back and cut loose offending condenser. Replace can and install new .1 mfd. 600 v. condenser on outside.

MAJESTIC 20. Section of voltage divider heats excessively . . . Probably a shorted .1 mfd. bypass condenser in the intermediate transformer. Connect new unit externally.

MAJESTIC 20. Continuous sizzling . . . Open chassis at left side from rear (tone control side) by taking out side flap. (Bottom cannot be removed without unsoldering chokes.) Clip tone control condenser lead. Although switch cuts this out many users don't know it is a tone control and it is usually jammed on low tone shortly after the purchase. Replace, if tone control is used, with 03 mfd., 600 volt tubular.

MAJESTIC 50. Set dead, no plate voltage on second detector but all other voltages only about 15 volts below normal . . . Do not remove bottom plate from chassis. Instead, remove the small plate at back of chassis directly below the deck upon which is mounted the 80 and 45 tubes. Look for a charred 25,000 ohm resistor. Replace it and the associated 1 mike condenser, which has shorted, causing the resistor to burn out.

MAJESTIC 50

Fading. . . Check first audio transformer which is condenser-choke coupled.

MAJESTIC 50. Replacing dial bulb without removing two knobs, screws and other miscellaneous parts. . . Remove dial escutcheon held by 4 small nails. Turn dial to 1,500 and remove end screw that holds dial strip. Insert bulb and backtrack process.

MAJESTIC 55. Fading and intermittent reception . . . Usually due to high leakage condensers in block, located on outside of chassis, near speaker. Also check tubular condensers for opens as some have loose ends that cause noise when switch is first turned on.

MAJESTIC 55

Crackling, noisy . . . oscillator primary winding breaking down. Replace with new unit (I.F. 275KC).

MAJESTIC 55, 15. Oscillation not traceable to filter condensers or resistors . . . Replace detector coupling condenser behind resistor board rear wall with 05, 400 volt type.

MAJESTIC 60

Dead . . . Check for shorting of lead from 80 filament terminal to ground or to the 110-volt line. The rubber covering of this wire softens from heat or the line voltage taps cut through it. The set may test ok when checking with an analyzer and still not play.

MAJESTIC 60. Set stops playing suddenly, tuning meter pointer swings clear over to stop. Cause is shorting of by-pass condenser in plate circuit of i.f. tube. Unsolder leads from i.f. transformer, remove it from chassis and heat to melt wax. Remove can and melt wax from red lead with iron. Cut this lead, re-assemble the transformer with it projecting from case and mount replacement by-pass unit externally.

MAJESTIC 60, 70, 80. To increase sensitivity and volume . . . Place a 250 mmf. mica condenser between the contact arm of the 10,000 ohm volume control and the low end of the variable r.f. coil in the first r.f. stage. Noise will also be reduced by this addition.

MAJESTIC 66. No screen voltages. Check 10,000 ohm resistor just below 6E7 and 6C7 and if burned out replace with one having higher wattage rating. Plate and screen voltages below normal. Check center tapped filter choke (underneath set about and inch away from the A battery female cable connector). If grounded side is open or partially open there is no grid return to ground for the output tube and lack of bias boosts plate current to point where drop through choke becomes abnormally great.

MAJESTIC 66. Installation hints . . . To greatly reduce motor noise pick-up conducted to chassis by pilot light lead, make it easier to remove the set, permit the use of the set without the pilot light burning in daylight proceed as follows: Before making the installation remove the remote control pilot light feed wire from the chassis by unsoldering it inside or cutting it off just outside the case. When the remote control unit has been mounted connect the pilot lamp wire to the tail lamp post on the lighting switch by holding wire to each post and snapping switch through its various positions.

MAJESTIC 66

Low or dead filament circuit . . . high resistance between fuse clips and riveted lugs. Solder each of the fuse clips to their mounting lug.

Add more "Tricks" to this Service Manual.
They appear in every issue of Radio Retailing.

RADIO RETAILING'S "Tricks of the Trade"

MAJESTIC 66. Vibrator adjustment . . . Connect d.c. ammeter (0-5 or 0-10, low resistance) in series between pigtail terminal on vibrator and battery wire which was connected to this terminal. Connect 0-300 d.c. voltmeter, 1,000 ohms per volt type, between ground and the B side (red lead) of audio output transformer. Connect 0-100 d.c. milliammeter between ground and grounded end of B filter choke (which is first removed from ground). Now, with a good A battery at 7.3 volts there should be 5.7 volts at the vibrator terminals. With normal tubes which have been heated for at least one minute the following values should be read when the vibrator is properly adjusted: Input: 5.7 volts at from 3.8 to 4.1 amperes. Output: 200 volts at 53 milliamperes. If voltage measured at vibrator is higher or lower than 5.7 then the other readings will be correspondingly more or less. Readjustment of the vibrator will be necessary if, for the above input values, the output current and voltage are down or if the input current is over 4.1 amperes.

Vibrators which have seen any appreciable amount of service will not retain readjustment unless the points are dressed or replaced with new ones. Experience has shown that it is much cheaper for the average service man to replace the vibrator head with a new head which has been adjusted and run-in at the factory. In dressing the points remove the armature from the vibrator assembly. In removing the armature, loosen only one pivot screw in order that the other may remain in position and properly locate the armature when it is put back in the frame. Before removing the armature take note of the side play on the pivots as this same amount of side play must be obtained when the unit is reassembled. In reassembling, be sure that the pivots do not bind the armature and that the side play does not exceed .003 in. to .005 in.

A file is practically useless for dressing the contact points, especially for the tungsten on the brass studs. A fine carborundum stone should be used for acquiring a final finish. When work on the contacts is finished they should be washed in alcohol (never use Ethyl gas) as any carborundum dust left on the contacts will cause rapid failure after adjustment.

In disassembling the vibrator unit never disturb the spring tension adjusting screw, as this screw has been set at the factory at that point which will place the spring under a tension of 30 grams. It is very hard to guess what this tension is and if spring gauges for measuring this tension are not available it is apparent that the tension adjustment ought not to be disturbed.

The contact which is opposite from the tension spring is called the primary contact, that on the same side as the tension screw, the secondary contact. In adjusting the vibrator, set the primary contact all the way out so that it does not make contact to the armature. Con-

nect the battery and after the tubes and rectifier are heated, turn the primary down until the armature begins to clatter against the core, then back it off about a half turn so that the clatter stops. Tighten the lock nut on the primary contact and then turn down the secondary until the ammeter reading begins to make an abrupt rise and at this point adjust to 3.8 to 4.1 amperes. Note that a point will be reached in this adjustment at which the output current and voltage do not increase, even though the input current rises as the contact is turned. The point at which input current is a minimum for a standard output voltage, is the point of correct adjustment. Do not attempt to turn any adjusting screw without first loosening the lock nuts and do not try any one adjustment as final without tightening the locknut as tightening the nut is apt to change things. When the vibrator is properly adjusted, clearance of the normally opened contact is .010 in. to .015 in. In attempting to measure this clearance with a feeler gauge one must rely on sight and not feel because if the gauge is thicker than the clearance of the contact, it will force its way in because of the flexibility of the spring on which the lower contact is mounted. If the gap is too small, turn the spring tension screw down a half turn. The armature may now clatter against the core and if it does, turn the primary contact back about one-quarter turn. Recheck adjustment of the secondary contact as described before.

If, on inspection of the vibrator unit, it is seen that the armature spring is badly discolored, it is an indication that the vibrator has been operated under improper conditions, as follows:

- A: Tampered adjustment.
- B: Incorrect battery polarity.
- C: Operated at no load condition.
- D: Operated at overload.
- E: Operated at too high a primary voltage.

MAJESTIC 66. Troubles due to wetting through cowl ventilators, water entering set through ribbed cover openings . . . Check screen voltages by listening for clicking sound which should be heard when contacting control grid of i.f. tube. If not heard check wire-wound 10,000 ohm resistor in series with screens of r.f., oscillator and i.f. tubes located directly above oscillator socket on under side of set, rivetted to chassis sidewall. Look also for electrolysis on red lead going into B choke which opens up soldered joint inside choke. Symptom is high-voltage on control-grid of 89. This will cause slight shock when fingers are placed from grid to chassis. Cut into first layer of choke insulating paper if repair is necessary and re-solder joint. Wetting also causes rectifier socket terminals to arc to chassis and carbonize, necessitating new socket.

MAJESTIC 66. Normal voltages, vibrator ok but set don't play . . . Try removing shield of i.f. coil, placing insulating paper around coil frame.

MAJESTIC 66. Fuse blows regularly, voltages test ok . . . Look for bad 6Y5. Sometimes test ok in checker but change it anyway. (IF 175 kc.)

MAJESTIC 66. Intermittent operation when car is operated over rough roads . . . Look for broken shielded ground wire leading inside of plug at rear of set. Take off plug and unscrew, soldering wire.

MAJESTIC 66. No reception, voltages ok . . . Look for open grid return condensers across the 300,000 ohm a.v.c. resistors (marked C1 and C2 on manufacturer's diagram). These are the small tubular type of .03 mfd. condensers found hanging across the first two r.f. coils. They open, due to vibration. Excessive current drain, vibrator works erratically . . . Change "Globar" resistor across vibrator transformer secondary. Testing B voltage . . . Bottom cover need not be removed. Simply put plus end of meter to the i.f. trimmer condenser terminal on top of set. Reception ok with cover off, distorted with cover, especially on low volume . . . Tap metal spider of speaker lightly downward, re-centering cone. New sets sometimes come through bad as they are tested at the factory with the cover off and then packed. Set alive from grid of 6C7 only, dead from preceding tubes . . . Look for open second i.f. transformer secondary. Squeals and oscillation on lower wavelengths, from about 1,100 kc. up . . . Change 6A7. The tube defect will not show up in a checker.

MAJESTIC 70. Holding dial shaft from turning while replacing cable . . . Fasten one end of the new cable to its spindle and wind it until the dial is tight against its stop. To hold it there, while the other end of the cable is being adjusted, clamp a small Stillson wrench to the tuning shaft on the outside of the chassis and brace the wrench handle against the volume control shaft.

MAJESTIC 70. Fading . . . Don't trust plier-tightened knurled nuts on powerpack terminal strip. Remove top strip and tighten all hexagonal nuts on the bottom mounting. If these are loose screw heads underneath will not make contact with lugs. Open a.f. 26 bias resistor . . . remove knob from hum control at rear of chassis. Remove nut holding hum control and insulating bushing. Replace without insulating bushing and set will play with good volume but bad hum. Sell customer replacement control job. Intermittent buzzing . . . Generally a cathode to heater short in 27 tube, when heated.

RADIO RETAILING'S "Tricks of the Trade"

MAJESTIC 70. Dial cable replacements are easily made if the proper template is used. Cut a 36 in. length, 4 in. wide from $\frac{1}{4}$ to 1 in. thick board. Drive a wire nail almost home in the exact center of the broad side and one near each end, $15\frac{1}{2}$ in. from the center. Lay a length of suitable cable material alongside the nails and form and solder two single and one double loops around the nails to match the anchor pins on cable sheaves.

MAJESTIC 70, 90. Frying noise, sounds like noisy audio transformer but is not . . . Often due to corroded and loose leads in the ballast unit. Take cover off, loosen resistance wire leads, clean them well and replace, tightening contacts well.

MAJESTIC 70B. No grid reading on 71's . . . Check pilot light socket. It frequently shorts to ground.

MAJESTIC 70, 71

Weak, intermittent . . . Look for a fungus growth or mould on fabric insulation of R.F. wiring, no rubber under fabric of wire. Rewire with rubber and varnished cambric insulated wire.

MAJESTIC 70, 90

Neutralizing tool on hand too large in diameter to go through condenser adjustment holes at top of chassis . . . Remove hex bolts from neutralizing condensers and saw slits so that they may be turned with an insulated screwdriver.

MAJESTIC 90

Loud, irritating buzz occurring at short intervals . . . Frequently caused by poor connection where resistance wire of ballast unit is attached to the prong. Clean and tighten.

MAJESTIC 90

Antenna choke tuned by a .001 condenser frequently opens up . . . Can be replaced with the good coil section of a 175 kc., i.f. transformer from an old Radiola 80. Saw through the center of wooden spool and mount good coil in chassis. A hole is already there.

MAJESTIC 90. Violent oscillation, especially on high frequencies, when volume is turned up on station . . . Shunt a $\frac{1}{2}$ to $\frac{1}{4}$ mike condenser across each of the r.f. bypasses located beneath the chassis. These are large, inclosed in tin.

MAJESTIC 90. No plate voltage . . . Generally due to shorted filter condenser (2 mfd) in pack, connected from black lead to green lead through 2,000 ohm choke to red lead. Breakdown usually ruins choke. Replace both.

Add more "Tricks" to this Service Manual. They appear in every issue of Radio Retailing.

MAJESTIC 90

Lacks pep. . . Check cable and connections between power pack and chassis. Often sections of this cable are open.

MAJESTIC 90. Set plays for about an hour then fades in volume, though stations are still heard weakly . . . Look for partially shorted r.f. 5 mike condenser located at front of chassis, with chassis upside down, on left side.

MAJESTIC 90. "Burping" on dance volume . . . Usually due to poorly matched 45's. Speaker rattle . . . Smear the overlap of the cone with collodion. Sometimes it is necessary to remove the wires which normally hold the overlap in place.

MAJESTIC 90. Intermittent reception . . . If complete set of new tubes does not cure this replace 2.5 mfd. condenser located on inside of chassis wall. These open intermittently.

MAJESTIC 90. Common troubles are the shorting of the detector filter condenser or opening of the 2,000 ohm filter choke. A 2,000 ohm resistor can be substituted for the choke.

MAJESTIC 90. Carrier hum. Remove receptacle plate on floor outlet from which set gets power and fasten ground lead to Gem B box by means of mounting screw. Such a ground is a positive remedy where iron conduit is well grounded.

MAJESTIC 90, 90B. Hum, sounds like noise from small motor . . . See that antenna and ground wires have not been reversed, or that ground connection has not gone bad.

MAJESTIC 90B, 100B. Noise, motor-boating. Generally traceable to defective .5 mfd. r.f. by-pass condenser.

MAJESTIC 90, 90B, 100B. Rejuvenating the appearance of the dial . . . Remove all paint with alcohol and wipe the dial dry. Then repaint with black Duco. Let the paint dry and then rub it with fine steel-wool dipped in crude oil. The raised numbers will shine like a new assembly. Where numbers are stamped in with a sharp indentation the paint may be cut out with a knife if a black body and light scale is wanted. Or the dial may be rubbed down, giving a brass body and black numbers. This process can be used on other makes of receiver, for example, the Stromberg 335, 338, 41 and 42 has a stamped dial.

MAJESTIC 90, 91, 92. If analysis shows no detector plate voltage clip the wire between the second and third lugs from the top of the condenser block for a temporary repair with slightly reduced volume.

MAJESTIC 90, 92. No signal. Check variable resistor located on end of condenser gang. Many sets work better when resistors are removed and loose wire carried to ground.

MAJESTIC 90B. Intermittent reception . . . Sometimes defective choke in r.f. lead. To remedy, short out choke. Performance is not noticeably impaired.

MAJESTIC 90B. No plate voltage, trouble apparently in powerpack . . . Disconnect leads between pack and set, turn current on for 45 seconds.

MAJESTIC 90B. Fading . . . Replace detector cathode bypass condenser. Check 27's.

MAJESTIC 90B

Hum, fading . . . lift rubber covered wires of cable so as to clear 116 ohm non inductive centertap resistor.

MAJESTIC 91, 92. Motorboating. Inspect flexible lead soldered to sliding arm attached to trimmer cup. After a time this wire wears, breaks.

MAJESTIC 100B. Ok on phonograph side of switch but n.d. on radio . . . Bare, twisted wire which connects inside the switch to chassis, for ground, breaks. Caused by continuous use of switch. Solder lead from terminal 1 to ground. Switch is numbered from 1 to 12.

MAJESTIC 100B. Cutting in an out. Check by-pass condensers across cathode resistors to ground. There are two in metal containers. Replace defectives with 1 mfd. units.

MAJESTIC 102, 103. Fading. Traceable to pickup transformer located on right of cabinet midway between shelves supporting chassis and speaker. If cardboard covering one end of unit is found to be warped one of the terminal lugs generally makes contact with the transformer core. Vibration from speaker thus causes trouble. Unsolder the lead from the terminal lug and bring the wire up directly through the hole in the cardboard and resolder in place.

MAJESTIC 116

Weak, checks normal . . . replace G58AS in the second i.f. amplifier stage with a 78.

MAJESTIC 130A

Fading . . . Defective .04 condenser bypassing 500-ohm resistor between secondary of last r.f. transformer and chassis. Located under tuning condensers, accessible by removing tuning condenser shield. The resistor is inside the r.f. coil.

RADIO RETAILING'S "Tricks of the Trade"

MAJESTIC 130A.

Flat tone and loss of volume, all voltages correct . . . Check speaker field coil for open. An analyzer will not show this fault if tests are run from the chassis.

MAJESTIC 200 SERIES.

Generally poor reception . . . R1, a 15,000-ohm, and R2, a 20,000-ohm resistor, both in the voltage divider, connected from plates to screens and from screens to cathode coil of the first detector, change value. Replace with 10-watt type. Also replace entire can containing C5, .03 coupling condenser, .04, a .1 mike first detector cathode bypass and C3, a .25 mike r.f. cathode bypass. Leakage is common between these units and is sometimes of the order of two to three megohms.

MAJESTIC 290. Volume cannot be cut down sufficiently . . . Look for defective 10-mike condenser from cathode of 57 to plate of 58 noise-suppressor tube. Open circuiting is common.

MAJESTIC 290.

Inoperative suppressor control . . . Caused generally by leaky or shorted 10-mike, 50-volt condenser marked C-8 on diagram and connected from G57 audio tube cathode to one end of volume control. Distortion . . . If present only when volume control is advanced look for leaky C-10 or C-20 audio coupling condensers.

MAJESTIC 300 SERIES. Weak signals, heard only at critical point of volume control . . . Condenser can marked C and D houses two capacitors, C17 a .1 mfd. and C24, a .25 mfd. A leak of one or more megs from C17 to ground or to C24 causes trouble. Ordinary ohmmeters will not detect it. Cut both leads coming out from holes in can marked C and D and connect a good .1 mfd. unit externally in its place. For solution of other troubles in this series check each $\frac{1}{2}$ watt carbon resistor for more than 25 per cent change in value. (I.F. 175 kc.)

MAJESTIC 300. Whistling and squealing on each station tuned in; also low volume . . . Generally due to open condenser C10, a .1 mike unit in plates of push-pull detector circuit. Replacing original Majestic tubes in i.f. and r.f. circuits with standards . . . Cover glass of conventional tubes with shellac, then stick tinfoil over glass, forming close-fitting shield. Twist piece of bare copper wire over foil just above tube base and attach to cathode of tube.

MAJESTIC 300

Motorboating when volume is advanced . . . replace 10 mfd electrolytic, C3 in schematic.

MAJESTIC 300

Overload with volume all on, still not enough volume . . . high resistance leak in coupling condenser connecting to tube side of volume control.

MAJESTIC 300A. Volume low, peaking at midpoint of volume control setting . . . Replace .1 condenser in square can. This unit has white rubber covered leads and connects between one end of the volume control and the grid circuits of the r.f. and i.f. tubes. Set plays for moment when first turned on but then quickly chokes off . . . Replace .25 condenser in same can as above, one side grounded, red lead.

MAJESTIC 310A. Lack of sensitivity . . . Try placing 20,000 or 30,000 ohm resistor across grid return of i.f. transformer to ground. Cutting in and out . . . Look for high resistance connection between poorly cleaned enameled voice-coil wire and leads.

MAJESTIC 370. No local reception with grid cap off i.f. tube . . . Cause is generally shorted i.f. coil. Remove it from case, bend back the lug and put a piece of fishpaper between coil and case.

MAJESTIC 380

Low volume, hum . . . check G57 AS and G58AS tubes. These tubes cannot be replaced with G57S or G58S. The "AS" series are 6.3 volts at 4 amp filaments.

MAJESTIC 381. Poor selectivity, volume. Many men remove the metal shield on the bottom of the chassis. Oscillation is kept under control by proper use of the volume adjustment.

MAJESTIC 400 SERIES. Low volume despite satisfactory r.f. pickup . . . Check for open speaker field coil, a common failure. No signal from first 57A detector-oscillator, i.f. and other tubes alive . . . Test for grounded i.f. transformer. There should be no reading from control grid of i.f. 58A to transformer can. If there is remove coil from can, wrap with fish paper and replace. Set completely dead from grid of the 43 output tube . . . Nine times out of ten the C-bias resistor in cathode circuit is open. Replace with 700 ohms. Pronounced hum . . . Look for shorted electrolytic across 43 bias resistor.

MAJESTIC 400A SERIES. "Gurgling" variety of hum . . . Replace 6D7 detector with new tube, trying several and choosing best. Intermittent reception . . . Often due to loose filament in 46A or 46B ballast tube. Hitting set shows it up.

MAJESTIC 440, 460. Oscillation . . . Almost invariably due to defective 6F7, which is critical in this set. Motorboating . . . Open 1 meg. resistor located in grid return of 6F7 triode section and shown on diagram as R9. High-plate voltage on all tubes, no signal . . . Look for open 41 cathode resistor, which should be 500 ohms. Failure of oscillator to work . . . Generally caused by poor soldered joint at third grid return 150,000 ohm resistor associated with 6A7.

MAJESTIC 460A

Motorboating and no reception . . . High resistance connection between grid lead of 58 I.F. and lug on I.F. transformer.

MAJESTIC 500. Poor selectivity . . . Drill hole in top of second i.f. transformer case and mount a balancing condenser in this position, connecting it across the transformer primary. Adjust for maximum selectivity.

MAJESTIC 500. Nothing coming through tubes ahead of 42 . . . Look for open coupling condenser, tubular type .05 going from triode plate of 6F7 to control grid of 42. Motorboating, all voltages ok . . . Change 3rd i.f. transformer. Trouble is usually primary to secondary short. Set stops when nearby light is turned on or off . . . Short out a.v.c. 300,000 ohm resistor in grid return circuit of 6A7. Trouble is due to over-biasing of 6A7 by surge, paralyzing its action.

MAJESTIC 520. Replacing 25 with easier-to-obtain 19 . . . Looking at bottom of six-prong socket, reading clockwise from filament prongs, connections originally are as follows: Filament, filament, plate, diode, diode and grid. Change circuit connections so that the grid lead goes to the old diode prong immediately next to the plate while the diode lead removed from this prong is carried to the old grid connection. The prongs should now read: Filament, filament, plate, grid, diode, diode. (I.F. 175 kc.)

MAJESTIC 500

Inoperative over part of the dial . . . replace 50,000 ohm oscillator grid-leak connected from cathode to grid of 6A7. This resistor often will increase greatly in value.

RADIO RETAILING'S "Tricks of the Trade"

MAJESTIC 500

Motorboating when tuned off resonance . . . Replace .25 mfd. bypass on 6A7 and 6F7 cathodes. Condensers are in one container of four .25 mfd., one .03 mfd. and one .06 mfd. capacitors.

MAJESTIC VIBRATORS. Notes on adjustment . . . Loosen screws 2 and 3 until there is a fairly large gap between contact points a and b and c and d. Then adjust screw 1 until the distance between points e and f and g and h is equal. In other words, see that the armature balances equally on both sides of the pivot. Now adjust screw 3 until contacts c and d touch, then tighten set nut 3a. Finally adjust screw 2 until there is a small gap between contacts a and b. Tighten set nut 2a and the job is done.

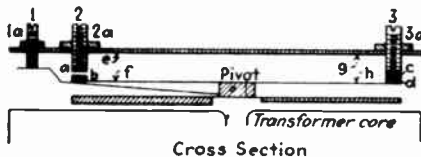

This space was left blank so you may paste in additional "Tricks of Trade" as they appear in the monthly issues of Radio Retailing.

MIDWEST

MIDWEST 16-34.

Poor selectivity and weak reception . . . This model does not hold its alignment due to shifting of windings on coils. Coat all coils with wax or liquid cement and realign all trimmers. Go over all trimmers a number of times to uncover interaction between circuits. Before realigning install a 3 or 4 plate variable midget condenser in place of the tone control assembly. Tone control assembly can be mounted on the side of the cabinet. Parallel this variable condenser to C19, which is an adjustable coupling unit between oscillator circuit and mixer grid. This condenser affects tuning of various bands and by having it variable from the outside efficiency will be considerably increased. While aligning set at 450 kc. have the newly installed condenser set at about $\frac{1}{2}$ mesh and screw C19 to minimum. Unstable operation . . . Ground more thoroughly all shielded cables of this receiver. Double ground the three coil and trimmer frames. Do not depend on rivets. Realign.

MIDWEST 11

Poor operation05 condenser from grid coil return to ground omitted in diagram and set, install and realign for increased gain. Replace the two $\frac{1}{2}$ watt carbon resistors across the lugs of the speaker socket with 1 watt, orange resistor is 3 meg and blue 6 megs, check .1 mfd connected from their common ground for leakage.

MISSION BELL

MISSION BELL 17A. Failure of KR1 rectifier to light up . . . Often caused by shorting of elements by mercury. Place the tube in a tester and apply 6 volts d.c. to its filament.

MONTGOMERY WARD

MONTGOMERY-WARD 62-11, 12. Lack of sensitivity may be corrected by removing the filter choke and 25 mfd. shunt condenser entirely from the circuit, then removing the second dry-electrolytic filter condenser and replacing this with a 4 mfd., 450 volt type.

MOTOROLA

MOTOROLA 1935. Installation in 29, 30 and 31 Chevrolets . . . Bond all metal in overhead frame of car, such as the windshield adjustment and corner braces. Run antenna lead in shield to within 6 inches of antenna. Bond antenna lead to dash and dash to bulkhead. Run bond from firewall up right front post to border on top members. Place grounded screen on floor boards and bond motor and all choke and throttle rods running from motor to driver's compartment. If care is taken no suppressors are needed.

MOTOROLA TWIN 8. Excess vibrator hash . . . Screw in bottom of set holding pack in place should first be tightened well. If this fails to remedy noise put a .5 mfd. automotive type condenser on the hot A lead where it fastens on terminal lug and ground to case of set.

MOTOROLA TWIN-8, DUAL-6. Buzzing noise from vibrator pack audible through signals, or with volume control off . . . Tighten self tapping screw which holds the vibrator pack in its housing. This is located on the bottom of the set and also holds the cover on.

MOTOROLA 34

Noisy . . . tighten i.f. coil shields. These are fastened to the chassis with self tapping screws.

MOTOROLA '35-'36

Jumps station on bumpy road . . . loose drive gear. Take out chassis reset drive gear and tighten.

MOTOROLA 44. Power supply unit hums but set does not play . . . Take vibrator unit apart. Find 2 small, flat condensers on top of reed unit. The reeds may be identified from the outside by tracing red and green rubber covered wires. Remove original condensers. Solder a .01, 1600 volt d.c. tubular unit externally to each lead, joint the two together and ground the midpoint.

Add more "Tricks" to this Service Manual. They appear in every issue of Radio Retailing.

RADIO RETAILING'S "Tricks of the Trade"

MOTOROLA 50

High background at low frequency end . . . shorted antenna series padder. Metallic shavings between segments cut through mica.

MOTOROLA 55. Vibrator hash and mechanical rattle . . . Remove powerpack can enclosing vibrator and power transformer, turn over and mount securely on chassis with self-threading screws. Replace vibrator and cover and reverse "A" leads to correspond with car battery polarity. Discard tin cover but place rubber bands around pack before putting chassis back in case.

MOTOROLA 55. Elkonode unit is short-lived . . . Connect 50,000 ohm resistor across output of replacement unit.

MOTOROLA 60

Volume cutting in and out . . . speaker field wires loose. These joints appear to be welded instead of soldered.

MOTOROLA 75

Intermittent01 coupling condenser (marked 1518) between 75 plate and 41 grid shorting, replace.

MOTOROLA 77A. Loud whistle and distorted reception in early models . . . Generally caused by breaking of solid wire connection between tone control and small fixed condenser mounted on chassis directly behind control. The wire is covered with cotton braid and frequently appears to be ok. Continuity test shows up defect. Replace with flexible wire, such as is used in later models. Dead set . . . Suspect the vibrator first. Remove from housing and check the two .007 condenser shunted across the rectifying vibrator points. They frequently short. Replace with 1600 volt, .007, oil-filled units. Static when car is in motion . . . Sometimes caused by broken soldered joint between antenna coil shield and chassis. Or by corrosion of spring contact grounding the variables. Bond rotors to chassis for permanent repair.

MOTOROLA 80

Dead, draws high current . . . replace .008 mfd. buffer condenser from plate of 0Z4 to ground.

This space was left blank so you may paste in additional "Tricks of Trade" as they appear in the monthly issues of Radio Retailing.

OLDSMOBILE

33 OLDSMOBILE. Noise pickup, after standard suppression is completed . . . Run shielded antenna down left front door post to floor and under mat to set, shield high-tension and battery supply wires and coil. Keep control cables away from ignition coil and use a battery supply filter condenser and dome light filter.

PEERLESS

PEERLESS 20. Intermittent reception . . . Nearly always due to defective condenser connected from detector grid coil to ground.

PEERLESS AC SPEAKER.

Fields ok but speakers refuse to operate . . . Although transformers check ok they are generally defective. Remove speaker from iron base. Remove transformer, remembering the order of the parts to facilitate replacement. Pry open heavy copper single turn secondary and slip it off. Remove screws holding iron core and slip leg holding coil out. Then remove coil. Cut off old primary, saving the form. Wind new primary using number 38 enameled wire. Scramble winding is ok. Wind on 800 ohms. Re-assemble and center cone.

PFANSTIEL

NATIONAL PFANSTIEL. Frequent trouble in midget model using an 80, 47, two 35s . . . Enamel winding on oscillator coil burns due to insufficient insulation on high voltage lead to coil. Inductance changes, so to be sure to check condition before re-aligning. If found a new coil is advisable.

PHILCO

PHILCO. When shot friction drive allows dial to slide off new allwave models . . . Make a small dog-ear on each end of track engaged by driver and it won't run off the track again.

PHILCO. High and low frequency trimmers can be adjusted without an output meter on sets equipped with Shadowgraph tuning indicators by first tuning a station operating on 1,400 kc. and adjusting for narrow shadow and then repeating the process on a low-frequency signal.

PHILCO. Where dial cables show a tendency to slip at several points smear the cable with rosin.

PHILCO. When "Shadowgraph" tuning indicators fail to indicate check up on the antenna. If it is too short, or so inefficient that it does not pick up strong signals this will happen.

PHILCO PHONO-COMB. Hum not traceable to poor tubes or defective parts. Ground frame of motor to set chassis.

PHILCO, AK, MAJESTIC 500 MIDGETS. To eliminate slipping of the tuning gang assembly . . . Remove the flange that holds and bears on the three ball-bearings that gear the rotor. Place on bench, then place washer from a snap-switch over same and tap evenly with a socket wrench of the correct size. Assemble and gang will not slip.

PHILCO 1937 MODELS

Distorted, fuzzy . . . Check the voice coil gap for steel filings. This is quite a frequent trouble. Filings get behind the heavy cardboard spacer and gradually work into the voice coil.

PHILCO MIDGETS

Vernier inoperative due to wear in ballrace . . . remove collar, pull out shaft being careful not to lose ball bearings, place small end of shaft on flat of vice and give several good taps with large hammer after having made sure condenser proper runs free in its own bearings.

PHILCO T-2

Motorboats while heating then dead . . . check for short between windings of second i.f. transformer by measuring the 75 diode plates to ground. Should be zero with aerial disconnected, negative with signal. If otherwise, remove coil and tape coil leads to prevent shorting.

RADIO RETAILING'S "Tricks of the Trade"

PHILCO 5. Frying or crackling in early serial numbers. If not in eliminator remove grid clip from 6A7 cap and remove lead from clip. Using same size stranded wire with good insulation wind r.f. choke of five turns on clip, re-connect lead. For obstinate cases wind thirty turns number 16 solid, cc wire around pencil. Withdraw pencil and place choke so formed in A lead between low voltage r.f. choke and heater terminal of 84. Keep choke in the vibrator section of base. Solder and tape splices. Late serial numbers have these chokes.

PHILCO 5, 7. Scratching noise when tuning . . . Tighten volume control nut in chassis and be sure it is well grounded.

PHILCO 5. Oscillations and code signal interference between 500 and 750 kc. in Transitone model . . . Usually due to defective condenser connected between plate of output 41 and ground, located directly beneath socket. Replace with .006.

PHILCO 5. No volume, eliminator output only 95 volts. Push down on upper vibrator contact so that spacing is equal between armature and both contacts. Erratic vibrator action. Make sure resistor across contacts is 50 ohms. Buzz, for which vibrator is not responsible. Replace 2A7.

PHILCO 10. Audio howl over entire dial . . . Generally caused by loose shield over i.f. tube 39 or 44.

PHILCO 11. Set blows fuses and vibrator is found to be ok . . . Check for short between speaker field housing and on-off switch mounted on volume control. Tape section of field close to volume control and also cover switch assembly with insulating material.

PHILCO T-II

Boomy tone . . . replace 0.1 m.f.d. tone control condenser with .01 m.f.d.

PHILCO 14 (Early). 36 autodyne first detector does not oscillate stably at lower frequencies, changing of oscillator coils and bias resistor does not affect permanent cure. Nor does replacement of tube, mica in tuning gang trimmers or

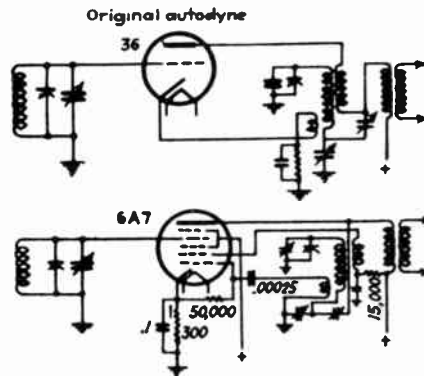

cloth covered wiring . . . Substitute 6A7 for 36, employing new circuit diagrammed. The same oscillator coil is used, but the various windings employed differently. Slight retrimming of all condensers associated with circuit is all that is necessary when revamping has been done.

PHILCO 15. Cuts on and off . . . Replace resistance-condenser combination No. 24 on schematic. This is the cathode resistance and bypass. Use 200 ohms and .1 mike.

PHILCO 16. R.f. dead; i.f. ok . . . Generally caused by ground of wire from first section of condenser gang being pulled too tight against chassis. Dead, no i.f. . . . Checking from grid cap of 77 tube in right hand front corner, audio squeal showing a.f. ok, i.f. transformer first facing front of chassis grounded high voltage lead (black wire). This does not affect audio. Sometimes the compensators in top of i.f. can ground to can. Scale dead from 11 to 26 mc. . . . Replace condenser from lug 1 on bottom of wave switch to ground marked with orange and yellow dots with one of the lug type (value 700 mmfd.). This is due to poor connection internally in pigtail condenser, which stops oscillation. Hum in early series . . . Due to a.c. switch jumper from switch through terminal lug mounted on condenser at back of set. Use shielded wire, grounding the shield.

PHILCO 18. Intermittent fading . . . Primary of first i.f. transformer opens up. (I.F. 260 kc.)

PHILCO 18

Dead . . . check tone control condenser for short.

PHILCO 18

Oscillation over entire dial for removing grid cap on 78 i.f. set returns to normal . . . connect .005 mfd. 300 volt condenser from center lug of 3615 AA narrow bakelite condenser to ground.

PHILCO 18. Cuts out for short interval and then resumes playing . . . Examine a.v.c. coupling condenser for leaks or broken wire connection in bakelite case, causing it to make or break contact. Tape wooden or rubber handle of screwdriver and tap all bakelite cased condensers while set is in operation, note if volume changes. Where condensers are faulty the pitch is usually melted through the connection hole.

PHILCO 18. Shadow indicator extremely wide and no signal . . . Voltages are usually all ok in this condition and the trouble is probably shorted trimmers. Bend plates up and insert larger insulating washers.

PHILCO 19. Set dead, voltages ok. . . . Check 15,000-ohm, 1/2-watt resistor on resistor and condenser block. Apparently it changes value badly when current is applied. Replace with 1-watt unit.

PHILCO 19, 89. Intermittent operation . . . Try new oscillator tube, or change cathode bias resistor from 15,000 to 10,000 ohms. Examine mica of oscillator high-frequency compensating condenser. If cracked replace as moisture sometimes gets in and stops operation. (I.F. 260 kc.)

PHILCO 19-89

Intermittent, returns to normal when line switch is cut on and off . . . re-solder oscillator cathode bypass condenser. Poor joint causing intermittent.

PHILCO 19, 89. Intermittent cutting in and out, no voltage changes noticed . . . Replace condenser number 30 (3903T) and number 27 (3903AB). They can be bridged with a 600 volt, 0.5.

PHILCO 20. Bad tone, pitched higher than normal. Replace old cone using solidified disc with new spider type cone.

PHILCO 20, 70, 90. Tuning shaft wears grooves where bathtub serves as end bearing for rotor . . . The back bearing may be given a new working surface by beating in the end of the tub for about 1/16 inch. The front bearing is not so easily fixed. Take the old dial (a new one is usually needed anyway) and cut out a piece as shown in the accompanying drawing. Drill holes in the

Add more "Tricks" to this Service Manual. They appear in every issue of Radio Retailing.

AUTOMOBILE AERIALS

There Are Types for Every Car and Every Radio

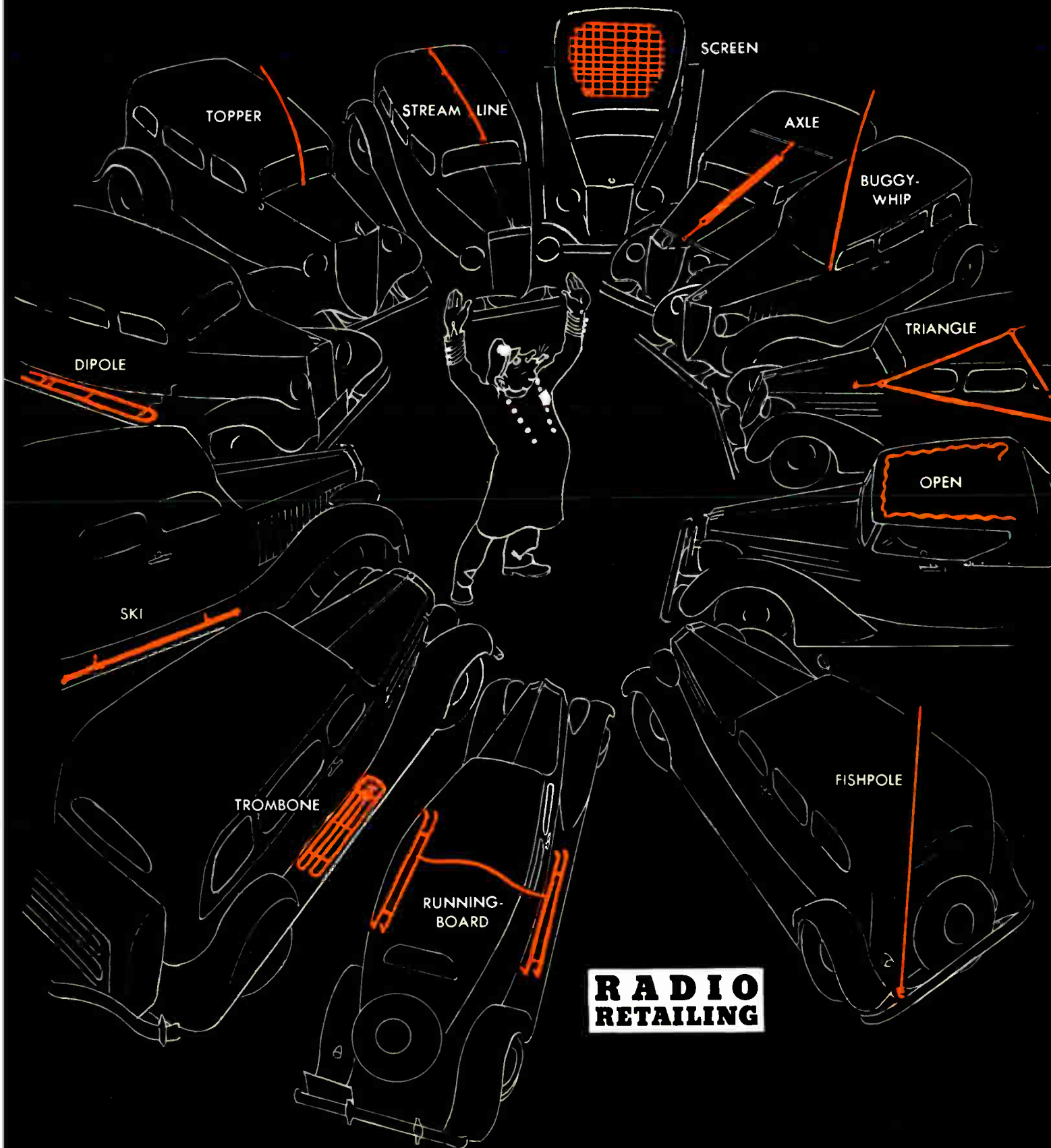

**RADIO
RETAILING**



**"YOUR
NEW MODEL 502
HAS ALMOST
SUPER-HUMAN
ABILITY!"**
SIGNED
Lee de Forest

LEE DE FOREST LABORATORIES
GREENWOOD, MISSISSIPPI
June 1st, 1937

Supreme Instruments Corporation
Greenwood, Mississippi

Gentlemen:

I have this opportunity to congratulate you on the excellent work you have done in the development of the Model 502. I have used the Model 502 in my laboratory for some time and have found it to be a most valuable instrument. It is particularly well adapted for the testing of vacuum tubes. The work done in the research and development of this instrument is particularly interesting and I am sure that you will find it to be a most valuable addition to your laboratory.

I have also used the Model 502 in my laboratory for some time and have found it to be a most valuable instrument. It is particularly well adapted for the testing of vacuum tubes. The work done in the research and development of this instrument is particularly interesting and I am sure that you will find it to be a most valuable addition to your laboratory.

I am, Sir, very truly yours,
Lee de Forest



MODEL 541
Here is the sweetest and fastest little Set Tester ever offered a serviceman at any price. Measuring only 7 1/4" x 10 1/4" x 1 1/2" and weighing but 9 pounds, 20 ranges and functions are at your finger tips on a single selector switch.
Here you have 2 to 1400 A. C. volts in four ranges; 2 to 1400 D. C. volts in four ranges; 2 to 1400 D. C. mils in three ranges; 2 to 1400 A. C. volts in four output ranges; 1 ohm to 20 megohms in five ranges (all self-contained)—and look at the price!
Dealer's Net Cash Price..... **\$26.95**
Or, \$4.00 cash and 7 monthly payments of \$3.67

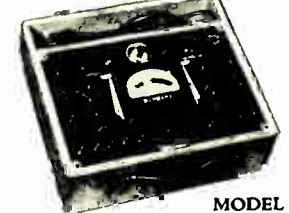

MODEL 501
Test your customer's tubes more accurately—all more tubes! That's SUPREME'S new Electro-conductance tube tester. This excellently engineered unit tests tubes for (1) Inter-element leakage between any two elements, (2) open test in any element, (3) short check between any two elements, (4) quality test of complete tube and (5) in the case of tubes having two or more sections, separate sectional quality tests. 5 TESTS ON EVERY TUBE!
Here is value unsurpassed! Trick tubes won't bother you—new tubes won't bother you. If you don't know all about SUPREME'S exclusive "floating filament" tube testing circuit be sure to write today.
Dealer's Net Cash Price..... **\$36.95**
Or, \$4.00 cash and 10 monthly payments of \$3.66

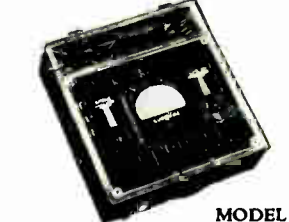

MODEL 551
To the serviceman who appreciates the truly time saving ability of SUPREME'S "Free Reference Point" system of analysis, we say "Buy the Model 551 Analyzer!" Use it as a multimeter—or use it as an analyzer! For here you have all the point-to-point functions and ranges of the Model 541 Set Tester PLUS the ability to make all resistance, voltage or current measurements between any two tube elements, or between any tube element and ground or chassis. Why "Get out and get under" the radio chassis?
Instead, using the Model 551, the serviceman literally spreads out the radio receiver's circuit on the analyzer panel, eliminating costly delays in physically breaking each individual circuit for current measurements, or fishing around underneath the chassis for point-to-point tests.
Dealer's Net Cash Price..... **\$38.95**
Or, \$4.25 cash and 10 monthly payments of \$3.86

When we say that this model is a serviceman's dream come true, we mean just that. Imagine having the Model 501 Tube Tester described at right PLUS nineteen additional ranges and functions of 2 to 1400 volts in four ranges; 1 ohm to 20 megohms in five ranges; 2 to 1400 A. C. volts in four ranges; 2 to 1400 D. C. volts in four output ranges, PLUS an Electrostatic capacity leakage test on a neon bulb and PLUS an Electrolytic filter capacity leakage test on a "Good-Bad" English reading scale. A complete, quality tube tester and set tester in a space 10 1/2" x 14 1/2" x 5", weighing only 16 lbs. at this new low price.
Dealer's Net Cash Price Model 502..... **\$49.95**
Or, \$5.50 cash and 10 monthly payments of \$4.95

Everybody is talking about the new 1938 SUPREME instruments—the HIT of the Chicago Radio Show!
Both servicemen and jobbers alike are loud in their praise of these smaller, lighter and more compact instruments!
Each designed around SUPREME'S new flush-panel meter, built to new high standards of precision by Westinghouse. Beautifully modeled in antique Bronze panels with Golden Oak carrying cases. Perfectly engineered, these SUPREME instruments are destined to sweep the service industry like wild fire, and bring you a complete new conception of operating ease and accurate results that COUNT!
Never before has so much instrument been offered for so little money. And remember, these new SUPREME instruments are all available on the S. I. C. Payment Plan—the world's easiest installment terms!

SOLD ON SUPREME S.I.C. TERMS—THE WORLD'S EASIEST INSTALLMENT TERMS

SUPREME INSTRUMENTS CORP.
GREENWOOD, MISSISSIPPI
Export Dept., Associated Exporters Co., 145 W. 45th St., New York City
Cable Address LOPREN, New York

Experienced Radio Dealers Recommend the Kind That Suit Your Needs

Serviceman says we'd have
to send out the army and
the navy to get back his copy
of the

MALLORY-YAXLEY Radio Service Encyclopedia

When Byford Dunn—proprietor of Dunn's Radio Shop at Carrier Mills, Ill.—likes something he doesn't mind saying so.

"A word about your Mallory-Yaxley Radio Service Encyclopedia," writes Mr. Dunn. "It is the last word in 'Labor Saving Machines'. The only way to get mine back would be to trade me a better one—or send out the army and navy! If I had not had that book I would have been up in the air a few days ago. A boy brought in a radio he had taken the old volume control out of and with the wires cut where they fastened in the radio and not on the control. With my Mallory-Yaxley Radio Service Encyclopedia I had it going in a few minutes—and there was the price of my manual!"

F. C. Robinson, of Livingston, Montana, is equally enthusiastic. He writes: "The Mallory-Yaxley Radio Service Encyclopedia is a fine book and well worth much more than was charged for it. It will help many a serviceman

out of a tight place!"

Read this . . . from Sanford Helt, Chief Engineer of the American Broadcasting Corp., at Lexington, Kentucky . . . "In my fourteen years of radio, I've never seen anything to equal your Mallory-Yaxley Radio Service Encyclopedia. I bought the volume as soon as it came out as I wanted it in my technical library."

Interesting reading, these comments from other men in the field! But—how about you? When are you going to save those extra hours and make those extra dollars that other men are saving and making with this great book that completely covers Schematics-Circuits, Volume Controls, I. F. Peak Frequencies, Transformer Circuits, Condensers, Tubes and Vibrators?

You'll have to act promptly, for there are only a few copies left. See your Mallory-Yaxley distributor right away about this greatest help a serviceman ever had!



Use
MALLORY
REPLACEMENT
CONDENSERS...VIBRATORS

P. R. MALLORY & CO., Inc.

INDIANAPOLIS • INDIANA

Cable Address—PELMALLO

Use
YAXLEY
REPLACEMENT
VOLUME CONTROLS

RADIO RETAILING'S "Tricks of the Trade"

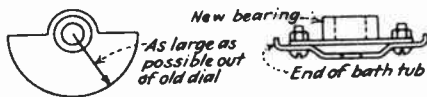

front end of the bathtub (taking care not to damage the stator) and fasten this piece over the shaft in such a position that the shaft runs true and does not bind when rotated. The machine-screws holding this bearing in place must be secured with lock washers. Of course, the rotor and tubes must be removed during all this violent treatment. Greater precision may be secured if the holes in the piece of dial supporting the new bearing are drilled after the part is in place. This can be done by aligning all the parts in their final position and using one or small C clamps to hold the parts while the drilling is in process.

PHILCO 29.

Audio whistle and bubbling hum . . . Common bias by-pass, a .09, for the two 39's opens.

PHILCO 29

Fading after short period of operation. . . . Check 350,000 ohm volume control, may vary up to several megohms intermittently.

PHILCO 30

Dead, no screen voltage . . . Common cause is shorting of .25 condenser connected from choke to chassis. This is one section of a dual unit in a metal can near the choke terminals.

PHILCO 30

Intermittent . . . broken flexible wire under cover of grid control leads. Check from condenser to ground shows good contact but a check from inside of rubber control grid caps shows open.

PHILCO 30. Thin, metallic quality . . . If circuit, tubes and speaker seem to be functioning as well as sets known to be in good condition trouble is probably characteristic "stiffness" of speaker cone. This may be remedied, if the customer will pay for it, by a little careful cone-cutting. Free edge by cutting out between points where screws are necessary for support. Cut slots in the apex member of the voice coil to give it greater flexibility. Spiral slots, starting at the center and winding out near the edge are suggested. Three are usually sufficient.

PHILCO 37-10

Intermittent oscillation . . . check 32,000 ohm resistor under the oscillator coil section for increase in value. Replace with new 32,000 ohm unit.

PHILCO 37-610

No short wave reception . . . small mica condenser (part No. 20) soldered to tuning condenser worked loose. Resolder and bend to clear plates of variable condenser.

PHILCO 38

Oscillator dead . . . Remove oscillator coil and heat thoroughly to drive out moisture. Dip in a 50/50 preparation of beeswax and paraffin, when cool replace.

PHILCO 41DC. Pronounced nasal quality and choppy reception. Replace 500,000-ohm first audio stage grid coupling resistor with 100,000-ohms and insert a 3,000 current-limiting resistor in series with the primary winding of the push-pull input transformer.

PHILCO 45. No plate voltage on 75 tube . . . Bad .1 mfd. plate condenser, part No. 30-4170. When replacing use a higher voltage unit. Intermittent reception, especially when tuning . . . Bolts that hold tuning condenser to the chassis may be too long or too tight, shorting to the stator section. This is a hard one to find if you don't know about it. Loosen bolts or cut off ends to correct.

PHILCO 45

Low volume during warmup, then increases . . . replace wave trap.

PHILCO 45. Continual failure of type 80 . . . Replace filter No. 30-2028 with new part No. 30-2079.

PHILCO 45, 145. Distortion or no signals, trouble not due to tubes . . . Replace bypass number 30-4170M with 05, 600 volt.

PHILCO 46 D.C. Replacing type 14 and 17 tubes with others more easily obtainable . . . Include 75 ohm, 10 watt resistor in series with speaker field and use 39's in the r.f. stages, 36 in the detector, 37 in the audio.

PHILCO 50, 50A. Set becomes noisy and goes into oscillation at low frequency end of band . . . Ground the speaker.

PHILCO 54. Hum . . . Eliminate grounds to chassis, generally at network of a.v.c. resistors or grid lead of 75 tube.

PHILCO 54, 80, 81, 84. Weak First look for poor 77, then for open i.f. pickup coil. The one that is bank-wound is most deceptive as the set balances without it. (I.F. 460 kc.)

PHILCO 54

Fading, motorboating, dead on part of dial . . . replace coupling condenser, 51000 and 5000 ohm resistor of oscillator circuit.

PHILCO 54

Unstable volume . . . replace dual condenser No. 54 located behind 43 tube. Heat from tube damages this condenser.

PHILCO 57C. Intermittent or no reception . . . See if white lead on coil is shorted to chassis. It passes over metal bracket holding coil in place. Re-run it under the coil bracket if frayed.

PHILCO 59. Fading . . . Replace second detector 77. Also check i.f. transformers.

PHILCO 59C, 59S.

Low volume, no reception on low frequencies . . . Take out antenna and oscillator coils and resolder all connections, tighten all screws on tuning condensers. Replace 6,000 ohm resistor and 1,400 mmfd. condenser. Align.

PHILCO 59

Can't tune in stations; cuts out when jarred . . . tighten oscillator and i.f. shield cans nuts. Make sure there is a lock washer under each nut.

PHILCO 60

Intermittent or low volume . . . Check for high resistance open in secondary of antenna coil.

PHILCO 60. Intermittent loud buzzing similar to outside motor interference but originating in set . . . Replace 6A7 oscillator-first detector even though it tests ok.

PHILCO 60

Motorboating . . . cut green lead from bypass can to trimmer condenser. Connect 0.1 mfd. 600 volt condenser from trimmer to ground.

PHILCO 65

Fading . . . intermittent open in speaker field. This field should have a resistance of approximately 3000 ohms.

PHILCO 70

Hum on stations near the center of the band . . . Look for trouble in the condensers seriesed across the power transformer primary.

RADIO RETAILING'S "Tricks of the Trade"

PHILCO 70. Set impossible to balance so that stations come in on proper dial settings . . . When all else fails remove gang condenser. It will usually be found that the front end of the shaft has dropped a fraction of an inch although this is not visible from the top. Replace with new gang unit.

PHILCO 70. Howl or microphonics when tone control is in left counter-clockwise position . . . Inspect .00025 mfd. phone condenser connected to plate of second detector. It has a yellow dot on one side and frequently opens or changes value.

PHILCO 70, 70A. Replacing dual volume control with single, tapered unit, giving even smoother control. Circuit is self-explanatory. The 200 ohm fixed resistors are 1 watt types.

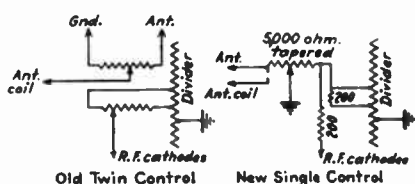

PHILCO 70, 70A, 370. Impossible to align circuit at 1400 kc. . . Look for open .00011 condenser between oscillator coil and plate of oscillator. Replace with .0005 and the set will align and be more selective than originally. Where this trouble exists reception will be ok below 850 kc. but will fall off rapidly at higher frequencies.

Philco 70, 71, 90, 91. Fading of locals is usually due to failure of a 1 mfd. condenser. Use sharply pointed test probes to locate the defective unit, gently lifting up the wires that come out of the hard-rubber case which houses the condensers.

PHILCO 70, 90. If airport beacons operating on 260 kc. cause interference, readjust the i.f. compensating condensers and the oscillator compensating condenser to either 250 or 270 kc.

PHILCO 70, 90. Feedback not traceable to missing rubber cushions or floating condenser gang . . . Drop wad of paper into oscillator coil form, mounted on the chassis by means of a bracket, and, with set upside down, drop catacomb wax onto paper off soldering iron point. Feedback is due to vibration of oscillator coil itself.

PHILCO 70, 90. Slipping dial drive shaft . . . Pull shaft down tight. Solder thin washer to bracket.

PHILCO 71.

Intermittent operation, volume dropping 50 per cent, proper operation restored the instant an analyzer plug is inserted for test . . . Check voltage divider section between screen grid and cathode of second detector.

PHILCO 76. Hum starts about 15 minutes after set is turned on, then all reception stops . . . Look at r.f. coils. Wire comes loose on form and drops or soldering lugs at bottom coils, shorting primary to secondary. Loosen wire with thinner and push back in place, then cement.

PHILCO 76, 77

Hiss on all stations . . . May be reduced by raising the value of the detector cathode resistor.

PHILCO 80.

Loose rotor on condenser gang . . . Remove assembly and take off rear bearing plate. Center punch the depression on this plate so that it protrudes further against shaft. If plates are out of line when the unit is assembled they can be realigned by loosening set screws holding them to shaft.

PHILCO 80

Insensitive . . . replace 240,000 ohm plate resistor. This unit has greatly increased value.

PHILCO 80. Volume control does not cut down smoothly on strong locals and on some stations will not attenuate to zero . . . Change volume control circuit, using No. 3793B part. Original control had one terminal to ground, the other to the antenna post and the variable arm to the antenna coil. Using new part place one end to the antenna post and also to the antenna coil, the other to the i.f. grid return and the variable arm to ground. The i.f. grid return end goes to the 2nd detector, anchored on cased condenser lug to one side of chassis. Remove lead from condenser.

PHILCO 80.

To improve volume and quality, especially in models with a star stamped on chassis . . . Change 1 meg. grid resistor to 0.5.

PHILCO 80 AC. Noise . . . Plate lead from i.f. transformer to first 36 rubs coil base and insulation is punctured. Or, grid resistor number 26 for 42 tube, lying close to socket, shorts to ground.

PHILCO 81

Fading . . . Usually caused by failure of one of the condensers in the a.c. line or in the center-tap of the power transformer. Opens are the most common failure. Usually attended by a hum or squeal, depending upon which condenser opens.

PHILCO JR 81. Oscillation of intermittent nature . . . Replace condenser 3793R, which acts as bypass for 42 output tube and also bypasses one side of the a.c. line.

PHILCO 84

Oscillation . . . connect .05 mfd. from high voltage to ground.

PHILCO 84

Sudden drop in volume . . . dual condenser bypassing screens of 77 tubes shorting: replace.

PHILCO 86. Low hissing which persists even with known-to-be-good tubes . . . Often caused by defective first audio transformer. Don't rely on tests. Substitute new unit.

PHILCO 87. Low volume or fading . . . Look at r.f. trimmers. Metal eyelets in insulators supporting these may have temporary short to trimmer stators. Remove screws through eyelets and slip thin piece of insulation under them. Remove adjusting nuts and give trimmer stators an upward bend. This tension will hold them in place.

PHILCO 87. Instability, will not neutralize . . . The first, second and third r.f. plate circuits include resistors wound directly on .1 mfd. condensers. The .1 mike units are connected between the resistors and the r.f. primaries. Usually the first one is open, causing excessive oscillation. Check all three.

PHILCO 87

Hum control ineffective . . . shorted twin .25 mfd. condensers across 1½ volt filament. Replace condensers, set hum control. Condensers are in long can on front of chassis.

PHILCO 89. Voltages check ok but set refuses to operate over entire dial . . . Try reversing primary leads of the first i.f. transformer.

PHILCO 89. Dead . . . Usually grounded compensator at back right hand side of set. Remove and insulate.

Add more "Tricks" to this Service Manual. They appear in every issue of Radio Retailing.

RADIO RETAILING'S "Tricks of the Trade"

PHILCO 89B

Low volume and noisy . . . defective second I.F. transformer. This unit will check o.k. on voltage test.

PHILCO 90.

Microphonic howl, stops if oscillator or i.f. coil cans are pressed or squeezed . . . Remove coil assemblies and melt paraffin over the forms to hold leads solidly in place. Paper around the coils frequently becomes loose, vibrates and moves leads sufficiently to cause trouble.

PHILCO 90. Fading, periodic program interruption. Replace all three 3903 (L.M.R) condensers extending one behind the other from tone control to speaker plug for permanent repair.

PHILCO 90. Audio howl not due to microphonic tubes . . . Check for control shafts or chassis touching front of cabinet, and also for correct functioning of rubber cushions. Vibration frequently causes oscillator plates to vibrate, causing tuning change and howl.

PHILCO 90. Oscillation between 1,100 and 1,500 kc. when trimmers are adjusted to resonance. Shunt a 0.1 mfd., 200-volt condenser across first r.f. (24) and oscillator (27) 5,000-ohm cathode resistors.

PHILCO 90. Intermittent reception . . . Generally due to trouble in coupling condensers between first and second 27's or between second and third 27's, or between third 27 and 47 final amplifier. The first one is hard to test and it is best to insert a new one and try the receiver.

PHILCO 91. Gradual widening out of the shadow tuning indicator after ten or fifteen minutes of operation . . . Replace two 44 a.f. and i.f. tubes. They may test ok but due to gas gradually draw higher and higher plate current, eventually burning out the indicator through which this current flows.

PHILCO 91X. Hum, developing after few hours of use, accompanied by distortion . . . Replace input push-pull audio transformer. Secondaries are sometimes faulty.

PHILCO 95, 96, 112

Blocking, similar to very slow recovery of avc, set otherwise normal . . . replace volume control. Ringing sound in speaker when set is removed from cabinet . . . Same cause, volume control. Static similar to that caused by bad a. f. transformer . . . Check same control

PHILCO 95. Intermittent reception volume increases to high level and drops back to normal when test instruments shock circuit . . . Look for intermittent trouble in bypass condenser on low side of volume control. The lead to this condenser goes from control, through a cable, and connects to filter block. Cut off wire at both ends where it emerges from cable and resolder a .5 tubular between low end of volume control and grounded lug of nearest trimmer.

PHILCO 96

Intermittent operation for short periods, any attempt to make tests restores operation . . . replace 30,000 ohm metalized resistor in plate of first audio.

PHILCO 96. Serious oscillation not traceable to open condenser or resistor . . . Replace screen feeder resistor with 50,000 ohm, 1 watt replacement and bypass with 2 mfd. Bypass the a.c. line with .001. Add a .1 mike to center of grid resistor network in the audio channel.

PHILCO 111, 112. Poor sensitivity and tone . . . Replace resistor number 8 with 75,000 ohms. This peeps up both models.

PHILCO 111, 111A, 211, 211A

Low volume, all voltages check . . . Change $\frac{1}{2}$ meg. resistor (#44) in plate circuit of '27 detector.

PHILCO 111, 111A, 211, 211A

Cutting off of signal followed by oscillation . . . intermittent opening of .05 mfd. condenser between cathode and low end of first detector grid coil.

PHILCO 112, 112A, 212, 212A

Oscillation and distortion when sensitivity switch snapped to maximum . . . open .5 mfd. condenser located in filter block bypassing screens of first detector and i.f.

Weak or dead . . . check 15,000 ohm resistor between minus of speaker field and chassis for decrease in value. Replace with 5 watt unit.

PHILCO 112

Poor tone . . . check 5 watt carbon resistor between speaker return and ground for drift from original value of 15 M. If necessary to replace use wire-wound unit.

PHILCO 112X. Slight, continuous whistle . . . Move plate wires away from compensating condenser.

PHILCO 116

Intermittent oscillation over entire dial . . . replace 10,000 ohm resistor in voltage divider section. To test, turn volume up full, tune off station and tap resistor, listen for crackle. This resistor is diagram #96 part #3524.

PHILCO 116B

Oscillation . . . push hot grid lead on volume control close to chassis.

PHILCO 212

Fading . . . Replace bypass connected to low side of volume control. This is a tone compensator condenser for increasing bass response at low volume.

PHILCO 511. "Quivery" reception . . . Check for partial open in voltage divider section feeding the r.f. plate.

PHILCO 511. Excessive hum. Where parts check ok hum can be removed by shielding the detector, grounding the shield.

PHILCO 600

Fading . . . leaky twin .09 mfd. Bakelite housed condenser bypassing screen of 6A7 mixer and 77 detector. Replace with two .1 mfd. 400 volt units.

PHILCO 610

Chirping oscillation, decreases in intensity when tone control is on full . . . replace volume control.

PHILCO 623

Low volume . . . replace '30 second detector even though original tube tests O.K. Grounding the grid of the '34 through a 1 meg. resistor will also increase volume.

PHILCO 635

When replacing tubes in this set be sure the grid cap lead of the 75 tube is inside the tube shield otherwise "birdies" will be present at one setting of the volume control.

PHILCO 650

Erratic volume control operation . . . Put a .00005 condenser between the tap of the control and ground.

PHILCO 806, 807, 808, 809, 816, 817, 818, 819

Vibrator hash . . . insert an iron core "A" choke in series with the speaker field. Choke must be of low resistance and a few henries inductance.

RADIO RETAILING'S "Tricks of the Trade"

PHILCO 806. Rattles . . . Bond all ground terminals riveted to sockets to chassis.

PHILCO TRANSITONE. When installing set in 1934 Chevrolet do not mount on right side near coil if this is avoidable as it is practically impossible to remove motor noise due to chassis pickup. The battery lead on the model 10, cut to fasten to the ammeter or starter, is the guilty wire. Shielding don't help. Lengthen the lead, shield it and then run it directly to the battery, connecting the lead to the negative and the shield to the positive post.

PHILCO TRANSITONE 5, 10

No voltage, vibrator tubes and filter check o.k. . . . replace .01 mfd. condenser connected between plates of 84 tube.

PHILCO TRANSITONE 5. Oscillation "birdies" in older models . . . Generally curable by pulling 15,000 ohm resistor in 2A7 circuit up toward front of set. Tendency to "swish" . . . Change 78.

PHILCO 1936 TRANSITONE.

Intermittent reception . . . Loose antenna plug insulator should be filed to almost the level of the plug as it is too long, preventing good contact.

PHILCO CUSTOM AUTO RADIOS.

Burning of wires to control head . . . Two wires coming from the tuning head are held in position by a thin clamp. This is not necessary and in some cases where the U clamp is drawn tight it punctures the insulation.

PHILCO AUTO RADIOS

Burned fuse and power transformer . . . vibrator sticking caused direct short on power transformer. Bend right angle lip on vibrator reed enough to clear magnet.

PHILCO DODGE

Insensitive on rod antennas . . . remove shield can on side of set to which antenna is connected and short small choke found in series with antenna lead. Realign first r.f. stage.

FORD-PHILCO 1934

Distinct vibrator buzz that is hard to correct . . . Take out 75 second detector-a.v.c. tube. If noise stops suspect shaft collar holding volume control to case. Another check for this trouble is to find low settings of volume control more noisy than higher settings. Give collar another hard turn with a wrench to dig through paint and slight corrosion and also run a heavy, short piece of braid from low point of volume control to case and solder well. This will eliminate all buzz from this source.

FORD PHILCO (1936)

Volume decrease when control turned on full, distortion . . . open secondary on second i.f.; replace.

This space was left blank so you may paste in additional "Tricks of Trade" as they appear in the monthly issues of Radio Retailing.

PIERCE-AIRO

PIERCE-AIRO 724. Weak reception with oscillation. Before making any adjustments look for open cathode by-pass condenser in first and second radio stages. These are single unit. Turn chassis upside down, look on radio-frequency coil partitions. Unit is one located nearest rear of chassis. Use 0.5 mfd. replacements.

PILOT

PILOT 93. When this a.c.-d.c. superhet seems to be out of alignment, whistles all over dial . . . Before attempting to realign check by-pass condensers 3x.1 in one can just below 170-ohm filament resistor. Heat from resistor frequently causes the block to leak or open and also causes fading. Replace with separate tubular condensers.

PILOT DRAGON 10.

A.c. hum level abnormally high . . . Look for ground at the reflector mounted behind the pilot light. Sharp corner of this reflector frequently pierces the small piece of fibre insulation included to prevent shorting of filaments to ground.

PLYMOUTH

PLYMOUTH,
New radio installed has little pickup on top antenna installed by car manufacturer, although antenna is not grounded . . . Trouble lies in the fact that these cars use chicken wire and examination discloses that it is too close to body of car. Clip it free all around and then clip out a strip about 1½ inches wide all around. Drive staples into wood supports and lace strong cord through staples and wire to replace the cut away wire.

PLYMOUTH 6. Persistent generator noise, despite installation of cutout condenser . . . Eliminated by making sure that the condenser is fastened under the cutout screw next to the engine, rather than under the one next to the hood.

Add more "Tricks" to this Service Manual. They appear in every issue of Radio Retailing.

RADIO RETAILING'S "Tricks of the Trade"

PONTIAC

1933 PONTIAC. On this and all other cars having shielded lead down right side post and requiring set installation on driver's side carry extended antenna lead in shielding under floor boards rather than under dash to complete noise suppression.

RCA-VICTOR

RCA. Noisy or erratic reception in recent models using a 745 mmfd. fixed condenser as oscillator coil padder . . . Replace with condenser of same value removed from oscillator grid lead and replace grid condenser with stock unit having approximately same value. Padder condenser value is critical and stock replacement will not do while grid condenser value is not critical.

RCA (GE). Slipping dial on rubber friction type dial models . . . Slip $\frac{1}{8}$ in. bushing from an old knob over shaft. Solder it to shaft where rubber gasket originally appeared. Now slip AK 55 dial drive rubber over bushing.

RCA, GE. Many recent models using Bradleyometer variable resistors. If these become noisy remove the covers, with cloth, apply vaseline.

RCA "MAGIC EYE." Fluorescent glow crosses over on strong stations, or does not change enough on any station . . . Change value of resistor connected from ray control electrode to ground. Make it larger if the ray crosses, smaller if it doesn't change enough.

RCA C6-12

Low Volume . . . Check volume control for grounded center arm.

RCA VICTOR 6-K-2

Intermittent cutting off of set and dial light . . . small rivet in center of band pilot light shorting to ground.

RCA T7-5

Distortion, high plate current in 6F6 output stage . . . Increase bias resistor to its normal value and distortion will disappear.

RCA R7 (WESTINGHOUSE WR10, GE S22). Slipping dial . . . Groove wears in rubber friction roller but not exactly in middle. Remove dial, loosen screws holding shaft to chassis, remove roller from shaft and reverse. Replace dial while holding shaft and roller firmly down against dial and tightening shaft holding screws. (I.F. 175 kc.)

RCA-VICTOR R7. Cracking . . . Frequently due to eyelet in chassis through which grid lead to 24 is brought up. The eyelet is not in any electrical circuit, but when it works loose the capacity of the grid lead passing through it varies with respect to ground. Remove or solder the eyelet.

RCA R7. (WEST. WR10, GE S22)

Rubber friction roller of dial wears out . . . Remove tuning dial by loosening its two setscrews and remove roller from shaft. Cut off a piece of rubber tape, not friction tape, $8\frac{1}{2}$ inches long and $\frac{1}{8}$ inch wide and wrap it tightly around the shaft, in the position of the old roller, layer over layer. The tape will form a new roller.

RCA T-8-14

Oscillation. . . Grid leak on rear top of main tuning condenser has changed its resistance. Replace with identical unit.

RCA D9-19

Weak, tuning eye will not function, second i.f. trimmer will not peak . . . This is a radio-phono combination, examination of the second i.f. transformer disclosed the trimmers soaked in oil that had dripped from the phono motor. Clean trimmers thoroughly and realign. Use oil sparingly on the motor.

RCA 11. Set stops playing at intervals after 27 a.v.c. tube has been replaced . . . Use an old type, straight-sided '27 in this position. Excessive heating is probably at the root of the trouble.

RCA-VICTOR C11, C13. Intermittent reception, volume periodically rising sharply to nearly full output and then dropping back to normal . . . This is "cut in" rather than "cut out" trouble and to cure it replace audio coupling unit at the front right of dial, looking at the top of chassis. Tone compensation condensers open up. Be sure to get the improved unit for replacement as an original would probably have the same trouble eventually. Do not cut the leads as new leads come with replacement. Unsolder old leads at volume control and tone switch arms.

RCA R-11

Fading after few minutes operation . . . Replace '27 in A.V.C. socket with Sparton 485.

Where
QUALITY, ACCURACY
and DEPENDABILITY
are important

use



Test Instruments

ZERO CURRENT
VOLTMETERS
VOLT OHM MILLIAMMETERS
SET TESTERS
TUBE TESTERS
OSCILLATORS
OSCILLOGRAPHS
MODULATORS
APPLIANCE TESTERS
PANEL METERS

MODEL 4900
ZERO CURRENT
VOLTMETER



Size—12 $\frac{3}{4}$ " x 10" x 5". Weight 12 Lbs.

This instrument measures voltage at infinite ohms per volt in high resistance net works as well as usual A.C. and D.C. volts, milliamperes, decibels, inductance, impedance resistance and capacity.

Built-in power supply furnishes balancing voltage — adequately filtered — so instrument may be connected to grid in any circuit without disturbing operation of the set.

Write for information on the complete line of HICKOK TEST EQUIPMENT.

THE HICKOK
ELECTRICAL INSTRUMENT CO.

10411 Dupont Ave.
Cleveland, Ohio

RADIO RETAILING'S "Tricks of the Trade"

RCA R11

Distortion on powerful locals, a.v.c. doesn't generate sufficient voltage to keep r.f. from overloading detector . . . connect 2 meg. resistor between junctions of R10 and R11 and R16 and R17.

RCA-VICTOR C11-1

Set changes volume badly when speech-music control is varied . . . Install new capacitor pack. This pack is on the front of the chassis and connects to both volume and speech-music controls.

RCA R11-GE 62

Intermittent . . . replace C 18 a .1 mfd. condenser in A.V.C. network. This condenser located in capacity pack and can be distinguished by white lead that goes through resistor board.

RCA R12. Motorboating . . . Replace type 47 tubes and connect a 5,000 ohm resistor in series with the screens to prevent recurrence of the trouble.

RCA C13-2

Excessive hum level . . . open 8 mfd. a.f. plate bypass. Replace with 8 mfd. 250 volt unit, clipping red lead on capacitor.

RCA VICTOR 15K

Magic eye inoperative, lights up but does not close . . . movable arm of tuning tube control shorting to metal cover. Due to the design of this control the clearance at this point is very small when the arm is put under tension. Take control apart and bend arm so it clears

RADIOLA 17

Bad hum that cannot be taken out by hum controls . . . shorted filter choke; replace.

RADIOLA 17, 18, 50

Repeated breaking of condenser drive cable . . . Due to scraping of cable on edge of drum. Install new cable, rotate control knob fully in one direction and then the other several times. If scraping is noted remove dial scale from drum and file edges to assure better clearance. When replacing scale put it slightly off center, more toward the edge of the drum on which no filing has been done.

RADIOLA 18

Oscillation when new tubes are installed . . . locate neutralizing condenser under chassis and turn counter clockwise till oscillation ceases.

RADIOLA 18 D.C.

No plate voltage . . . Open 1,000 ohm plate resistor located in power unit. Connect a 20-watt, 1,000 ohm replacement from binding post 7 to binding post 9 for permanent repair without necessity of removing and replacing chassis.

RADIOLA 21, 22. Apparent short between red and maroon B plus lead and chassis. If short develops when tube is inserted and disappears when the tube is removed from 22 sockets look at plate prongs to see if these touch chassis. Screws holding sockets down loosen due to speaker vibration and sockets shift.

RCA D-22-1 Volume Expander

Lack of expansion, drop in volume when expander is turned on . . . replace part #11608 consisting of two 1 mfd and one 4 mfd condensers. These are C-208, C-209, and C-210 in the schematic. Also check R-203, a 100,000 ohm resistor in the plate circuit of the 6L7 for drop in resistance. If operation still unsatisfactory check C-201, C-202, and C-206.

Excessive hum with switch in phone position can be remedied by replacing C-106. an 18 mfd condenser (part #11496) in the plate circuit of the 6C5 first audio stage.

RCA RO23

Weak . . . replace 8000 ohm resistor connected between screen and cathode of rf. and if.

RCA 26

A.V.C. action weak, noisy. . . Check a.v.c. plate choke. Also check C 18, C 20, C 21 for shorts.

RCA R27

Speaker rattle after a few months of use . . . Remove set from cabinet and glue two pieces of cork at top and bottom of place where speaker cone comes. These should be just thick enough to come in contact with the cone, forcing it back slightly.

RCA R-28. Speaker rattle, sounds live voice coil striking pole, but is rarely this . . . Cone is screwed to speaker frame only at bottom, allowing top part to vibrate against frame on loud signals. Screw top edge of cone to frame with short 4/36 machine screws and nuts. Holes are already in frame, so no drilling is required.

RCA R-28, R-28 BW

Oscillation . . . Replace. two mfd. screen and plate voltage bypasses.

RCA R28.

Loud "putting" noise despite good tubes, correct voltages . . . Caused in many cases by oscillating mixer section of 2A7. Remove wire feeding screen voltage to this tube section and insert an r.f. choke in series, bypassing from the screen to ground with a .5 condenser.

RCA VICTOR R-28-P. Set operates ok on broadcast but is dead on shortwave band . . . Look for shorted trimmer condensers on band-change switch. Mica frequently breaks.

RCA R28P. Violent oscillation all over dial . . . Probably an open circuited 4 microfarad electrolytic screen by-pass condenser. It is mounted under the chassis in a common container with a second 4 mike unit. Change both to prevent a call back.

RCA R28, R28P (GE K50, K50P). Noise, sounding like loose connection . . . Probably one of flexible leads of the 57 plate choke rubbing against green 500 ohm 2A5 cathode resistor between r.f. choke and rear of chassis. Gurgle and squawk after tubes heat . . . Probably open filter block. (I.F. 175 kc.)

RCA M30. Faulty control of volume . . . Usually caused by change in resistance of carbon unit located in remote control box. The correct value is 70,000 ohms. Check the volume control resistance before installing the carbon unit as its value may have changed necessitating some compensating difference in the fixed unit. The control should check at 50,000 ohms. Use a slide resistor to determine the correct total resistance.

RCA M30. Lack of complete manual volume control is usually an indication of trouble in the a.v.c. circuit.

RCA 30, 30A. Burned out 876 ballast tube . . . When customers refuse to spend money to replace it wire two lamp sockets in parallel in its place. Place a 75 watt electric bulb in one and a 100 watt size in the other.

RCA-VICTOR R32. Neutralizing adjustments . . . Some of these sets do not have holes in the top of the chassis to permit entry of insulated screwdriver. Sets frequently neutralize perfectly without plate but oscillate all over the place when it is replaced, especially when new tubes have been installed. Most trouble is at high-frequency end of dial. Grasp the rear 26 nearest the 27 detector while the metal plate is off and oscillation will occur. Neutralize while holding this tube, carefully adjusting the neutralizing screw nearest detector, and the set will operate ok when the plate is put in place.

Add more "Tricks" to this Service Manual. They appear in every issue of Radio Retailing.

RADIO RETAILING'S "Tricks of the Trade"

VICTOR 32. Open speaker fields are often easily repairable. Remove cover and look for burned or broken wire. Usually these are accessible.

VICTOR RE 32, 45. Background noise, lack of sensitivity . . . Replace 27 detector with a 56.

RCA R32, RE45, RE52. Low volume, all plate voltages ok . . . Check for loose connection on power plug into pack from chassis. Spring contacts on female section frequently corrode sufficiently to reduce heater supply values.

VICTOR R32, RE45, 57. To repair cones take an old one and cut out a piece $1\frac{1}{8}$ round. Take a piece of old panel and cut out two pieces the same size, drilling a $\frac{1}{8}$ hole through the center of both. Coat the cone with glue. Now take the two panel pieces and put over the cone with the piece of old cone. Put a $\frac{1}{8}$ bolt through the center holes, tighten and let dry.

RCA R32, R52, RE45. Intermittent reception, little volume, voltages ok . . . See if cone has become torn around fibre washer at center. It will be necessary to remove the speaker to discover such a break.

RCA R32, R52, RE45, RE75. Whistle in background on all stations, reception otherwise ok . . . Generally due to open 500,000 ohm resistor across half second ary winding of interstage push-pull audio transformer.

VICTOR R32

Noisy volume control . . . when replacing controls in this set use a 10,000 ohm unit. Disconnect the brown resistor that biases the 26 r.f. tubes and connect to one side of new control. Connect antenna to other side, ground center arm. This change will increase selectivity and give the control longer life.

RCA M34

Noisy . . . Check volume control cable shield at chassis for poor ground connection. It frequently loosens or breaks off near base of vibrator.

RCA M 34 Vibration loosens mounting. Secure two pieces of rubber or felt about $\frac{1}{2}$ inch thick. Place these behind set on bolt, one each side of bulkhead, compressing tightly with nut. On Chrevrolts and other cars having light bulkheads which permit shimmying of chassis place 6 by 8 inch steel plate under smaller one furnished by manufacturer, holding it in place with 8/32 bolts passed through holes drilled in four corners.

RCA M 34, GE B40. Set starts late, or only after racing motor . . . Replace 6A7. Cuts out permanently after starting up ok, or no reception though set sounds alive . . . Resolder connections on oscillator coil farthest from antenna lead, being careful not to overheat or short lug to frame. Volume ok on high-frequency end but poor at low . . . Replace antenna coil if trimmers seem ok. No sensitivity on high end . . . if trimmers are ok check .5 mfd. condenser across cathodes of 78 and 6A7, which also causes intermittent noise pickup from vibrator when poorly connected. Howl on strong carriers similar to microphonic tube . . . If replacing 6A7 causes no change replace 400,000 ohm yellow resistor on resistor board with 500,000 ohms and connect .0001 condenser across this resistor if set lacks punch. Extreme lack of sensitivity . . . Replace 400,000 ohm resistor with 250,000 ohms. Lack of audio punch . . . Replace 60,000 ohm resistor across a.f. transformer secondary with 100,000 ohms. Pronounced buzz from vibrator and no signal . . . See if oscillator tube filament prong is shorting on diode prong of 6B7. To mount set on Model A Ford where no heater is used . . . mount between choke rod and accelerator rest with speaker facing seat, cutting off extension gas cutoff lever. This is a tight but neat fit. Do not mount this set in any but vertical position as vibrator unit will bear against container causing unstable operation and contact sparking.

RCA R34, R35, R39, RE57. 90 per cent of the trouble experienced with these receivers may be traced to the 70,000 ohm red and green resistor in the plate circuit of the first audio stage, the $1\frac{1}{2}$ meg. red and white resistor in the detector control grid circuit and the $1\frac{1}{2}$ meg. blue and green resistor located under the resistance board.

RCA M34, GE B40. Speaker rattle or sizzle. Try centering cone. Remove from case and look for filings at pole pieces. If there is no hole in screen for centering punch one $\frac{1}{8}$ before re-installing as drawing speaker up with nuts on face of chassis may twist frame and throw cone off center. If voice coil glue loosens don't try repair. Replace. Vibrator works ok but set is dead. Place paper scraps between all contacts and check from each high side to ground on chassis. Shorts indicate blown condensers across contacts. If found, replace vibrator base. If no blown condensers check for one between B plus lead on speaker (2nd from right looking into back of set) and chassis ground. If dead short is found trouble is usually in intermediate cans shorting to coils or blown 4 mike in pack. To insulate cans, glue cardboard discs inside covers. Rattle. Tighten eyelet in center of speaker screen. Unstable vibrator operation. Check small rivets holding arma-

ture to channel section of springs and tighten by pounding if loose, removing armature for job. Field current and pilot current on but tubes don't light. Poor soldered joint between small r.f. choke L₂ and field wire lead.

VICTOR 35. Low volume or no reception. Turn on set and permit tubes to warm up, setting dial on strong local. Remove detector and then replace quickly. If set plays for few seconds and then fades out replace detector screen resistor.

VICTOR R35. Weak reception. Commonly either open detector screen resistor or first a.f. plate resistor. The first is located under resistor board on chassis. To replace connect pigtail unit of $1\frac{1}{2}$ megohms to two inside lugs on side of board toward the center of chassis. To replace a.f. unit loosen pack but do not remove and tip up bottom sufficiently to clip out green and red pigtail resistor on terminal strip, replacing with 70,000 ohms.

VICTOR R35. Weak, distorted reception. Examine resistor R14 mounted on filter-capacitor block between terminals 6 and 7. Correct value is 70,000 ohms.

RCA R37. Gradual loss of volume . . . Control grid lead to 2B7 is rubber-covered wire, shielded. It passes close to bleeder resistors and heat sometimes melts rubber, permitting short to shield. Rewire with cotton insulated wire. (I.F. 175 kc.)

RADIOLA 41 AC. Microphonic howl and low audio howl. May be caused by open by-pass condenser across secondary of first a.f. transformer

RCA 42, 48. Defective volume control. Check r.f. 24's for plate to screen short to avoid repetition of the trouble. Such shorts put abnormal current through the controls but otherwise affect reception very little.

RCA-VICTOR 44.

Fading on locals . . . May be due to corroded center friction contact of volume control arm.

RADIOLA 44, 46

Difficulty in aligning . . . Probably due to shorted turns on the small, universal-wound plate coil. Replace this coil.

RADIO RETAILING'S "Tricks of the Trade"

RCA 44, 46. Loss of volume, selectivity, sensitivity after several years of use. If voltages and tubes check ok trouble is usually caused by wear in the gang condenser, permitting the rotor sections to shift. Re-align these by means of the adjusting screws at each end of the stator sections. Select a station between 600 and 650 kc. and adjust for maximum volume. Then adjust the trimmers at the 1,500 kc. end and repeat both operations once again. A 235 in the 2nd r.f. stage will improve tone on local stations and low volume settings.

RCA 44, 46. To tune in police calls . . . Trimmers may be adjusted to pick up 1712 kc. stations and still get 95 per cent of the broadcast band. Trimmers are hidden at front of set chassis and it is necessary to remove the chassis from the cabinet to adjust them. Right hand trimmer, on the detector, has a habit of shorting. Install slightly thicker piece of mica and re-align.

RADIOLA 44, 46. Set plays on one or two stations but it seems impossible to align tuning condenser . . . Replace the first, unshielded, r.f. coil, which is frequently affected by moisture and climatic conditions.

RADIOLA 44, 46, 47. Squeals and howls . . . Check contact made by little wiping clips fastened to bottom of stage shields and see if they have sprung or are dirty.

RADIOLA 44,46 AC. Low, or no plate voltage. Often due to grounded coupling reactor in detector plate circuit. This is in small, brown housing beneath tuning unit and is insulated by thin pitch coating. Slip insulation between choke and chassis.

VICTOR RE45, 52, 75. Chassis shorts. Often caused by steel needles falling down from phonograph compartment and shorting socket lugs to ground.

RCA 46. Oscillation experienced, identified as too small an antenna load . . . Make sure all shields and grounds are ok, then connect a .001 or .005 condenser from antenna to ground and re-align antenna stage. Tighten up entire condenser gang while set is open as shifting of either rotor or stator plates is quite common.

RCA-VICTOR 47.

Fades on locals, volume can be brought back by snapping a.c. switch on and off . . . Plate supply of first and second r.f. tubes feeds through phonorecord switch and poor contact here is usual cause of grief.

RCA 48. Cutting in and out of reception is sometimes caused by sluffing off of the plating on tuning condensers. Hum, noticeable only when records are played, is cured by a 5,000 ohm resistor shunted across the secondary of the pickup input transformer.

RADIOLA 48

Intermittant . . . examine plates of variable condenser for filings. The plates of this condenser are made of a magnetic material and should be kept clear of filings. Blow out thoroughly with air pressure.

RADIOLA 50, 80

Distortion . . . replace 110,000 ohm resistor from B plus to cathode of second detector. This resistor decreases in value and supplies excess bias voltage to this tube.

RCA-VICTOR R50, R55, RAE59

Distortion and lack of volume . . . Check primary of interstage transformer. The winding with the yellow lead opens up. Disconnect the yellow lead from the number 5 terminal on the 8-terminal strip of powerpack. Continuity test will probably show open or high resistance.

RCA R50, GE H32, R55, RAE59.

Sets play only when 27 a.v.c. tube is removed . . . Look for open resistor in a.v.c. return, also for high negative bias on r.f. and i.f. control grids. Oscillation . . . Usually caused by open circuit in .1 mike screen by-pass condenser. Fading . . . Look for open or leaky .1 by-pass across resistor in a.v.c. circuit, usually found in the power pack connected to the blue lead from the condenser block.

RCA 50, 55, 59. Poor volume, no dx. Remove a.v.c. 27. If volume immediately improves disconnect .1 mfd. condenser in power pack fastened to one end of 1 meg. resistor and usually wired with blue lead. Connect new condenser from this point to ground. For temporary repair simply omit condenser.

RCA 55. No reception except powerful locals, voltages, tubes ok . . . Check, preferably by substitution, .1 mike condenser connected between blue and black leads, located in capacitor pack mounted on separate power unit. Cut loose blue lead at resistor mounting board and substitute 600 volt tubular replacement from vacated terminal to ground. Trouble is generally high resistance leak of the order of 1/10 megohm, which upsets a.v.c. circuit. (IF 175 kc.)

VICTOR RE57. Set dead . . . Remove panel mounting rivets carefully, turn panel over and check value of 2 watt resistor in detector circuit. It should be 1 or 1½ megohms.

RCA RAE59. Flat tone quality when used close to high-powered local stations . . . Trouble is in a.v.c. action. Over control is exerted. Look for 500,000 ohm resistor from plate of a.v.c. tube to ground. Open the ground end and insert a 300,000 ohm resistor in series, replacing the ground connection. Now release the r.f. and i.f. leads from the plate of the a.v.c. tube and place them at the junction of the two resistors, by-passing this junction to ground with a ¼ mfd. condenser.

RCA 60. Low volume or no signals and low plate voltage . . . Measure resistance of black carbon 20,000 ohm bleeder resistor in pack. Usually has decreased in value. Replace with 3 or 5 watt unit.

RCA 60. Noisy reception . . . Look for bad r.f. plate choke in r.f. transformer assembly.

RCA 60, 62. Low volume. Check for decline in value of the 20,000-ohm bleeder resistor located beneath the pack.

RADIOLA 60, 62, 66, 17, 18, 33. Rear bearing for gang condenser shaft is simply hole drilled in plate. Wear permits wobble and resulting frequency change sounds like motor-boating, especially at high-frequency end. Secure piece of brass 3/64 in. thick, ½ in. wide and 3½ in. long. Bend it at right angles ¼ in. from one end. Holding the brass horizontally, the short "leg" down, insert it from side to side under the shaft between the second and third condenser, jamming it firmly between shaft and base.

Add more "Tricks" to this Service Manual.
They appear in every issue of Radio Retailing.

RADIO RETAILINGS "Tricks of the Trade"

RADIOLA 67. No control of volume . . . Nearly always traceable to open 310 ohm end section of voltage divider, located in tuning chassis. Difficult to check because placing of an ohmmeter across this section will not show it up as one side is grounded and the other is only about 4,000 ohms above ground. Use a 25 watt replacement.

RCA 78 (GE 125). Defective detector reactor choke in square can fastened to chassis side . . . Replace with 5,000 ohm audio transformer, wiring primary and secondary in series aiding. Or use the secondary alone.

RADIOLA 80. Noisy reception is complaint . . . Examine i.f. transformer coupling 1st detector to 1st i.f. stage. This unit has a copper shield disc between its windings. If disconnecting the control grid connection of the 1st i.f. tube does not eliminate the noise replace the transformer. Other transformers sometimes cause similar variety of noise but the one mentioned is the most frequent offender.

RCA 80-82-86

Continual rasping of speaker . . . 600 kc. trimmer loose from chassis vibration.

RADIOLA 80

No control of volume . . . Open 18,000 ohm resistor in screen grid circuit of 1st r.f. Check 14,300 ohm and 110,000 ohm resistors in same circuit before installing replacement as new unit will burn out again if these have dropped materially in value.

RADIOLA 80

Fading, especially at low frequency end of dial while tuning . . . Remove flaked cadmium finish from variable condenser gang plates by disconnecting leads, flashing with 300 to 400 volts d.c.

RCA 80, R50, R55. Static-like noise when volume control is in off position . . . Due to breakdown of interstage transformer and may only show up after set heats. Replace interstage output, housed in one assembly.

RCA 80-82. Loss of volume and poor tone. Examine black enamelled bias resistor for 45's, under chassis, for bad soldered joint.

RCA RE81

Motorboating . . . Clean condenser wipers, install .1 mfd. condensers between junction of R14 and R15. Connect 10 mfd. 50 volt electrolytic from green lead on volume control to ground. Positive foil of this condenser goes to ground.

RCA TMV-97-C.

When using this oscillator be sure the shielded lead from the output connection is fabric-covered or the B-battery will run down in the event the shielding touches the output jack.

RCA 100B SPEAKER. Burned out coil . . . Re-wind bobbin full of No. 26 d.c.c. copper wire, then use a dynamic speaker output transformer with a low impedance secondary. This will give improved tone and volume.

RCA VICTOR 100

Low volume . . . leaky antenna coupling condenser which blocks the a.v.c. action. Replace with similar higher voltage unit.

RCA M101, M104, M108, M109

Noisy . . . Replace leads from stators of condenser gang to grid caps.

RCA 102. Line cord burned out . . . When replacing with new cord be sure to roll a piece of mica over the resistance asbestos and tape, allowing mica to be $\frac{1}{2}$ in. larger than the resistance wire. This wire runs to the socket of the 37 and when set is moved around the socket lug frequently cuts into the asbestos, shorting the wire. Mica goes into the set under the socket. Tape or tie line cord so that it stays fastened to the chassis.

RCA 106. The a.c. model can be used with single pentode output tube models with considerable improvement in tone. The field is about 450 ohms. Use it as the bias resistor.

RCA 110. Tracking condenser shown on circuit diagram as number C-31 appears to be missing . . . This condenser has a minimum of 15 and a maximum of 70 mmf. Try inserting one small enough to be placed between oscillator coil and chassis. Adjustment to about 50 mmf. will give maximum deflection at 600 kc. while rocking tuning condenser. Sensitivity will be uniform over entire dial. Apparently this condenser is occasionally omitted through error in production.

RCA 118, 211.

Intermittent operation or fading .015 coupling condenser C28 partially opens. In later production this is a .02. Replace with .02, 600 volt. Connects from 42 grid to 6B7 plate and is located under main resistance strip. Align at 460 kc.

RCA VICTOR 120

Motorboating, no signals . . . check for open condenser in three section electrolytic block located to right of gang condenser. The offender is usually the screen grid bypass.

RCA 121. Motorboating . . . Open 4 mike section of capacitor pack (I.F. 175 kc.).

RCA 121 (GE K-64)

Motorboating . . . If fingertip on control grid of rearmost 58 stops oscillation, remove red lead coming from C-28 in 3 section electrolytic pack and replace with single 8 mfd. unit.

R.C.A. VICTOR 143

Noisy, intermittent hum . . . replace 500 ohm cathode resistor on 76 tube.

RCA 143, 242

Periodic hum accompanied usually by distortion . . . Replace (C45) cathode bypass on first audio with 10 mfd. 50 volt unit. Also replace (C46), a 4 mfd. 450 volt electrolytic connected from same cathode to B plus.

RCA 221

Bad hum . . . leaky 4 mfd. cond. in capacity pack, No. 6703—C 22, disconnect blue lead and replace.

RCA 233

Ballast tubes burn out quickly . . . replace ballast with 125 watt house lamp. This is a 32 volt set and will receive the correct filament voltage when the 125 watt lamp is substituted for ballast.

RCA 241B. Intermittent reception . . . Corrosion where leads are welded to coils, both input and output transformers.

RCA VICTOR 261

Distortion, weak signals. . . Look for 60,000 ohm 1 watt plate resistor overload. Usually caused by leaky or shorted 4 mfd condensers (red leads) located in capacitor can and connected to each end of this resistor. Replace resistor with a 2 watt unit, connect two new 4 mfd. dry electrolytics in place of suspected condenser, after clipping off red leads close to can.

RADIO RETAILING'S "Tricks of the Trade"

RCA 281, 262

I.F. won't hold alignment . . . solder leads from r.f. transformer to insulated eyelets through which they pass.

Oscillation on high frequency end with sensitivity control advanced . . . replace i.f. cathode and screen bypasses.

RCA 321. Phonograph plays but not the radio . . . Check for short in condenser having blue lead to terminal near oscillator padding condenser. When replacing be sure to include 30,000 ohm resistor in original position. Use 4 mike unit with 500 volt rating.

RCA 331

Strong buzzing . . . connect a .001 mfd condenser from center terminal of volume control to the side lug of control that connects to 60,000 ohm resistor. This will bypass excess r.f. currents.

RCA DUO 380HR. To test neon level indicating lamps . . . Connect suspected lamp, in series with 200,000 ohm fixed resistor, across source of a.c. voltage. This may be the regular 110 volt supply line shunted by a suitable voltage dropping potentiometer. Connect high resistance a.c. voltmeter across output of potentiometer and vary this adjustment. The lamp should not light before 52 volts is applied and must not require more than 64. If otherwise they are defective.

This space was left blank so you may paste in additional "Tricks of Trade" as they appear in the monthly issues of Radio Retailing.

SENTINEL

SENTINEL AC-DC 560. No signal . . . Check for open 8 mike section in 8-8-4 block connected as follows: Black, common negative. 8 mike positive to one side of filter choke. 8 mike positive to other side of choke. 4 mike positive to cathodes of 25Z5. All negative connections are, incidentally, independent of chassis.

SILVER

SILVER 30. Dial belt will not stay in groove . . . Chip "V" deep enough to allow cable to come flush with surface of pulley, wrap fine wire around ends of cable, then tin. Also tin the "V" cut in pulley, then solder cable to ends of "V."

SILVER-MARSHALL

SILVER MARSHALL. To make replacement of dial cable a half-hour job . . . Remove all tubes, then remove shield around r.f. section. Now unsolder all connections to gang condenser. Remove three screws holding down condenser and remove entire gang with the drum. String on new cable, time about 5 minutes, and replace the assembly. Any other way takes about three times as long.

SILVER-MARSHALL R (10 Tube).

No signal when set is turned on, gradually starts to play during first 5 or 10 minutes . . . Replace 1st filter condenser with 8 mike electrolytic. Improper filtering in this circuit acts as a signal on the a.v.c. grid. Check for this trouble by removing a.v.c. tube (1st 227 of three in a row, next to 551). If volume booms up and distorts on locals trouble is as above if no signal or very little signal is heard before this tube is removed. For improved punch . . . Replace two 27's in parallel as detectors (second) with 56's. Motorboating or excessive hum . . . Usually caused by excessively high resistance in tone control (which is plate resistor in detector circuit). If control checks ok try replacing .5 mike condenser from lower contact to ground with .25 and connecting .25 megohm resistor across outer points of tone control.

SILVER MARSHALL 36A. Breaks into oscillation after operating satisfactorily for a short time, insertion of analyzer cable in any socket clears up trouble and makes test difficult . . . Trouble is defective r.f. choke in series with first i.f. amplifier tube's cathode.

SILVER MARSHALL 37, 38, 39, 782.

Distortion at low volume level on local signals . . . Replace second 24 from front of set with 35 or 51, change minimum resistor to 100 ohms (on Bakelite strip with one end grounded and other to volume control) and connect a 25,000 ohm resistor between screen of 35 and high voltage side of volume control.

SILVERTONE

SILVERTONE field-coil resistance data:

	Number	Ohms
King-made Silvertone	90	2500
	94	2500
	95	2500
	100	2500
	111	750-750
	111B	750-750
	112	750-750
Colonial No.	36	1150 9000
	41	1152 1450
	41C	1154 1450
	38	1170 9000
	41	1174 1450
	42	1174 1450
	39	1250 2500
	49	1252 2500
	41P	1260 9000
	36P	1260 9000
	37	1310 1450
	37	1312 1450
	47	1320 1450
	47	1322 1450
	47	1324 1450
	47	1326 1450
	37P	1330 1450
	46	1370 2500
	44	1390 2500
	44	1400 2500
	44	1402 2500
	44	1404 2500
	44	1406 2500
	44	1408 2500
	41	1420 1450
	42	1420X 1450
	50	1430 1450
	48	1450 1450

Add more "Tricks" to this Service Manual.
They appear in every issue of Radio Retailing.

RADIO RETAILING'S "Tricks of the Trade"

SILVERTONE 42.

Unsatisfactory reception from 950 to 540 kc., noise and whistles accompanying signals . . . Ground one side of the antenna coil to the chassis. Connect external ground to chassis after this is done to further improve dx reception and reduce hum.

SILVERTONE 110, 111. Defective volume control. Replace with 10,000-ohm unit and ground through 5 or 10 watt, 500-ohm resistor in series with the cathode circuit to give better control on locals.

SILVERTONE 110

Unstable . . . tighten all ground screws throughout chassis, also those on gang condenser. Pigtail gang rotor. Replace 9000 ohm 5 watt carbon resistor (black and red) and 10,000 ohm 3 watt with a 10 watt. Also connect .002 condenser from detector plate to grid to reduce R.F. component in audio; reneutralize.

SILVERTONE 110

Hum, weak . . . check 8 mfd wet electrolytic on top of chassis for low capacity and leakage.

SILVERTONE 172, 36, 41, 37. To increase pep in these sets, volume controlled by primary coil movement into secondaries . . . Loosen setscrew on volume control shaft on rear of condenser gang and move primaries $\frac{1}{4}$ to $\frac{1}{2}$ in. farther into secondaries. Tighten screw, align trimmers on gang to cut out oscillation and insert 35 type tubes in r.f. sockets instead of 24's.

SILVERTONE 821, 1827 (COLONIAL 656)

Abnormal hiss on all stations except strong locals . . . poor contact on rotor wiper springs. Clean and bend for better tension and realign set. (i.f. 480 k.c.)

SILVERTONE 1506. No reception . . . Look first for a shorted .01 mfd. bypass between the 47 plate and grid. This is a common ailment.

SILVERTONE 1570

Weak . . . Look for corrosion around control grid of second detector where it goes through hole in chassis; slip spaghetti over lead to insulate from chassis. May be further pepped up by substituting almost any 175 k.c. 4 lead I.F. transformer for resistance first and second I.F. network. Leave 20M resistor previously used as a filter with the addition of a .1 mfd. paper tubular to bypass this resistor or the increased gain will cause motorboating.

SILVERTONE 1570. Trouble due to electrolysis . . . To completely cure this for all time use a dpst switch to replace the spst switch in order that the B minus lead as well as the A positive may be broken. Change oscillator coil to one using bakelite form or lay Empire cloth between form and winding.

SILVERTONE 1570, 1574. Electrolysis in output transformer . . . Commonly encountered due to use of paper winding form which evidently contained some chemical heightening this effect. Use a bakelite form when repairing or place Empire cloth between winding and paper form. Pre-heating and sealing in some moisture-proof compound also recommended.

SILVERTONE 1580. Improving sensitivity . . . Use 200 ohm resistor in place of 400 ohms found in series with volume control.

SILVERTONE 1584. Continual blowing of .003, 600 volt condenser connected across primary of power transformer . . . Due to surge built up in primary winding when line switch is opened. Use an 800 volt condenser as a replacement, connecting it between the line side of the on-off switch and the chassis.

SILVERTONE 1640. Improving tone and reducing hum . . . Use .001 condenser in place of original .003 tone control unit. Replace 100,000 ohm resistor and .1 mike condenser in lead to midpoint of driver tube's gridleak with .5 mike condenser from gridleak midpoint to ground. Use .003 condenser instead of .02 from one leg of power transformer primary to ground. Use grounded electrostatic shield between primary and secondary of power transformer if set operates on 25 cycles. The 60 cycle jobs do not need such shields and if shields are provided they should be disconnected. Replace 8 mike, 475 volt electrolytic condensers with a 14 mike, 440 volt unit. In replacing power transformer use one with a separate filament winding having a 20 ohm adjustable center tap resistor across it for one of the 46 driver tubes. The adjustment is quite critical. To impart greater brilliancy to tone replace auto-transformer found mounted on 12 inch speaker with a new auto-transformer having fewer laminated core sections. Failure of volume control to reduce volume to zero is due to coupling between second i.f. and detector grid leads, under the chassis. The i.f. lead connects from coupling choke and detector grid lead from tuning condenser. Spread these leads far apart.

SILVERTONE 1640. Blurring at high volume levels . . . Reverse transformer secondary leads to grids of 46's.

SILVERTONE 1640. Undesirable time lag in a.v.c. system, weak stations interrupted during static bursts . . . Replace the .1 mike fixed condenser in the a.v.c. circuit with .01. Hiss or feedback in 283 tube . . . Insert r.f. choke in red plate lead of tube. If one does not cure trouble put another in the other plate lead. This noise may affect nearby sets as well as the receiver itself.

SILVERTONE 1652, 1654. Poor selectivity in models equipped with .005 condenser in i.f. stage . . . Remove second i.f. untuned transformer underneath chassis and replace with part R6415A, a tuned i.f. transformer. Realign both i.f. stages. If set oscillates reverse connections on plate coil in second i.f. stage, being careful not to disturb connections to trimmer from plate and B-plus. Rotor must go to plus. Any good tuned i.f. input transformer which peaks at 175 kc. can be used if a Colonial part is not easily obtainable.

SILVERTONE 1711. When changing to standard tube types . . . Replace 951's with 32's. Replace 950's with 49's, not with 33's as the latter draw excessive filament current and will blow ballast tube.

SILVERTONE (Sears-Roebuck) 1712, 1713. Distortion, weak signals . . . With batteries disconnected check with ohmmeter from B minus (red and black) to chassis. It should read 700 ohms. If less test 35 mike, 20 volt condenser across 700 ohm, 1 watt carbon resistor for full or partial short. It is found, together with two 8 mfd. capacitors, in a square cardboard box bolted to chassis. Leads are brown and black. Fading . . . Sandpaper band change switch contacts. (I.f. 175 kc.)

SILVERTONE 1732. To increase "pep" . . . Install a 10,000 ohm resistor in the screen-grid lead instead of the 15,000 ohm unit normally used in this position. Screen voltage should increase from 60 to 80 volts.

SILVERTONE 1801 AC-DC.

Undue hum after regular filter replacement . . . Tie the cathodes of the 25Z5 together. The filter arrangement of this set is identical with that of a Sparton 57 so that a filter block for this latter make will work quite satisfactory if the original replacement is not obtainable. Care must be exercised because the color coding of the leads supplied with the two blocks is not identical. Both schematics must be on hand to avoid wiring error.

RADIO RETAILING'S "Tricks of the Trade"

SILVERTONE 1802A, 1803A, 1807

No reception at high frequency end. . . . Open 2 mfd. tubular cond. from oscillator coil to ground. Set dead. . . . Check open 17M and 32M ohm sections of Candohm voltage divider.

SILVERTONE 1824-1830

Weak or dead . . . check 4 mfd. cond. from 78 screens to ground. Also check tuning meter for open. Wave change switch dirty; clean with alcohol and small brush.

SILVERTONE 1926

Code interference. Repeak at 445 kc. (originally 480). Retrim the two padding condensers mounted on gang at 1500 kc., also repad 600 kc. trimmer while rocking selector knob.

This space was left blank so you may paste in additional "Tricks of Trade" as they appear in the monthly issues of Radio Retailing.

S. M.

S-M "Q." Motorboating or distortion when volume is turned full on . . . Defective cathode bias resistor in i.f. stage. It will probably check ok on an ohmmeter but should be replaced. (I.f.-175 kc.)

S-M Mdl. Q. Don't mistake the i.f. frequency for 175 kc. It is 465 kc. and the set will not work properly with any other adjustment.

SM Q25. I.f. trouble sounding like oscillation or motorboating . . . Moisture is a common cause. Cover back of set with blanket and let it run for 8 or 10 hours.

SM 30. When there is no reception look first for a punctured filter condenser, usually the green lead coming out of the can.

SM 30B. No reception. Check 300,-000 ohm resistor in the detector plate circuit.

SM R, T. Low volume, fading, distortion, volume control does not work . . . Due to partially shorted bypass condenser C11 located at resistor terminal strip, connected from ground to one terminal of tone control. Replace with .5 mfd., 250 volt unit. Distortion, meter does not swing high enough . . . Test a.v.c. 27, or switch it with oscillator 27

SONORA

SONORA. Avoiding high price of replacing special tubes . . . Rewire for 27's in the r.f. detector and first a.f. and a 45 in the output. Place five-prong wafer sockets over regular four-prong types in r.f. sections. Fasten with small bolts. Bring up connections. Carry cathode leads from chassis through holes in rivets holding coils. Make cathode return to powerpack through one side of unused filament wiring. Install new transformer with following specifications: 700-volt c.t. secondary, 2.5-volt c.t. filament secondary and 5-volt secondary. Change bias for 27's to 500 ohms and place grid return to 45 in filament center tap. Discard ballast tube. Job costs less than half the price of new special tubes.

SONORA. Mushy tone, poor audio quality in this and other sets using Peerless dynamic speakers . . . Burnish contacts of voice coil bands to heavy copper strip (secondary) of output transformer. Re-assemble and tighten well.

SONORA 28. Frailty of chassis permits plate coil in first r.f. transformer to twist out of line. Symptom is oscillation with volume control full on. Twist coil back into line.

SPARTON

SPARTON I. F.'s

MODEL	MODEL	MODEL
9-X	172.5 35	172.5 75 456
10	172.5 36	172.5 75-A 456
12	172.5 44-P	172.5 75-AX 456
13	172.5 45	172.5 75-B 456
14	172.5 46-P	172.5 76 456
14-A	172.5 53	456 77 345
15	172.5 56	172.5 78 172.5
15-X	172.5 57	456 80 456
16	172.5 58	456 81 456
16-AW*	172.5 60	900 81-A 456
17	172.5 61	456 82 456
18	172.5 62	456 83 456
25	172.5 63	456 84 456
25-X	172.5 63-AX	456 85-X 456
26	172.5 65	456 86-X 456
26-AW*	172.5 65-T	456 104 456
27	172.5 66	456 111-X 172.5
27-A	172.5 66-T	456 134 456
27-X	172.5 67	345 333 456
28	172.5 68	345 475-A 456
28-X	172.5 70	345 475-AX 456
30	172.5 71	456 478 172.5
30-A	172.5 71-B	456 620-X 172.5
30-B	172.5 72	172.5 691 345
30-C	172.5 72-PQ	172.5 750-A 172.5
33	172.5 73	456 750-X 172.5
33-A	172.5 73-AX	456 870-A 172.5
33-B	172.5 73-BX	456 870-X 172.5
34	172.5 74	172.5

*The short-wave superheterodyne converter in these models operates on an intermediate frequency of 900 kc.

SPARTON AIRPLANE DIALS.

Microphonic trouble . . . See that there is clearance between dial and cabinet. It may also be advisable to put a coat of clear lacquer on wires passing through oscillator coil so that these will not vibrate.

SPARTON. Breakdown of tubular condensers . . . Replace with 400 volt types for permanent repair.

SPARTON EQUASSONNE A.C. MODELS.

Routine trouble tests from specialist's notebook . . . Temporarily short terminals 1 and 2 with tip of screwdriver. If pronounced click is not heard from speaker check speaker connections and main filter condenser block. If power unit is ok loosen and remove terminal screw on .25 mfd. condenser shown in diagram. If set continues to operate after removal of screw replace it. On some models in which original condenser is still in place the following test may be used instead of above. This older style condenser has metal top with screw through center. Momentarily short top of condenser to side of amplifier. If spark occurs the unit is ok. If not, replace. This may usually be done without removing amplifier from cabinet by removing bottom screw going through terminal on side of condenser and bending terminal up against side of condenser, then turning condenser counter-clockwise. To install unit reverse this procedure.

Turn volume control completely off. If noise similar to static results check detector plate choke before suspecting control. If new choke cannot be obtained remove all wire from old choke form and scramble-wind the form full of No. 36 enamelled wire. Solder ends to terminals and do not use anything but

SIMPLEX

SIMPLEX MIDGET. Oscillation, immediately upon connection of antenna . . . Remove the 350 ohm resistor in series with B and ground. Ground B minus. Place 350 ohm resistor in series with cathode of 2A5.

SIMPLEX PA. Dial slips in this dual band Aircell battery type . . . Quickest permanent cure is to slip a $\frac{1}{8}$ by $\frac{1}{8}$ rubber grommet over the shaft and wind cord around this grommet instead of the bare shaft, as originally equipped.

Add more "Tricks" to this Service Manual. They appear in every issue of Radio Retailing.

RADIO RETAILING'S "Tricks of the Trade"

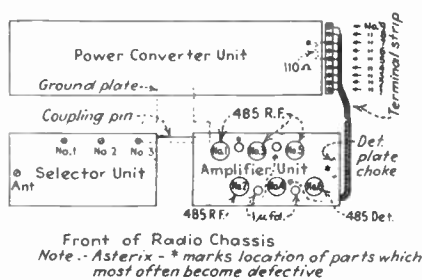

pure rosin flux. Impregnate choke with commercial r.f. coil dope or something similar. If set operates but volume is low and decreases after passing half-way point on control trouble is usually due to open in 110-ohm wire-wound resistor connected between terminals 5 and 7.

By placing volume control full on (if set does not operate) and touching antenna to coupling pin between selector can and r.f. amplifier can the set should pick up some signals. If so, trouble is indicated in selector can, either a defect or bad alignment. The pin referred to is directly under the back of the drum dial. Without the selector stations will naturally be jumbled together.

After above routine tests and with volume control full on pull extra 485 tube used on selector can as amplifier almost out of socket and work it up and down so that it makes and breaks contact with the socket terminals. There should be loud clicks. If not, check for open plate choke or condenser beneath socket.

Location of tubes in amplifier unit for best reception and freedom from oscillation at 900 kc. . . . After testing tubes place best one in 1st r.f. position, next in order, 3rd r.f., 4th r.f. and finally the poorest tube in 5th r.f. When aligning select some frequency above 1,000 kc., about 1,300 is preferable. With oscillator connected to antenna posts adjust trimmers as follows No. 3 first, then No. 2 and finally No. 1. Check back second time. Now connect antenna to selector unit and tune in some station around 1,300 and adjust antenna trimmer. If antennas are changed, re-adjust this trimmer each time.

SPARTON 14. Intermittent reception, operation restored by jarring cabinet . . . This is a common trouble which may be attributed generally to a single cause in these models. The wire running from the intermediate transformer to the 58 looses some of its insulation where it passes under the shield-can. The short is very difficult to actually see and may be guarded against with a short length of spaghetti on the lead.

SPARTON 16. Extreme motor-boating . . . Insert a static shield between the oscillator stator and the adjacent r.f. stator on the tuning condenser gang. This in no way impairs performance as far as selectivity and sensitivity are concerned. The undesirable condition is due to r.f. from the oscillator getting to the second detector, blocking the set through a.v.c. action and releasing periodically.

SPARTON 16. Intermittent noise, erratic operation, become increasingly noticeable if any part of chassis or tubes is tapped . . . Due to looseness of condenser rotors on shaft. Rotor hubs are cast. Drill and tap, with a bottoming tap, the hub of each rotor for two short 6/32 setscrews. Or solder one end of each hub to the shaft with a large, hot iron and spatterless flux. Also desirable to ground center of shaft with flexible pigtail in place of original brush.

SPARTON 26. Fading caused by mechanical contacts, all shields and obvious parts apparently tight . . . Die-cast rotors of condenser gang frequently make high resistance contact to shaft, this resistance showing up only on Wheatstone bridge analysis. Drill and tap holes in each rotor through to shaft and insert setscrews.

SPARTON 36. Short-lived vibrators . . . Connect .01 mike, 1600 volt condenser across secondary winding of power transformer in the eliminator unit. Install the condenser in all sets serviced as precautionary measure, adding cost to bill.

SPARTON 36

Vibrator burns out . . . connect a .01 mfd 1600 volt condenser across secondary winding of power transformer.

SPARTON 40. No a.v.c. action . . . Try replacing a.v.c. 37 first. If this does not cure trouble check the 160 ohm resistor connected to r.f. cathodes, chokes and ground.

SPARTON 40. B-battery dead, or heavy current drain on eliminator . . . Replace shorted 1 mfd. condenser used to by-pass screen of 438 power tube.

SPARTON 61, 62.

Tunable squeal all over dial in these a.c.-d.c. models . . . Check 5 mike, 165 volt section of filter condenser block for leakage. If present, cut green lead and replace with 8 mike, 200 volt unit.

SPARTON 61, 62. Distortion, not due to bad tubes or incorrect voltages . . . Check 5 mfd. section of filter condenser. It is across the speaker field and tapped filter choke and is equipped with a yellow lead coming out of the block.

SPARTON AC7, 62, 63. Replacing worn-out friction dial drives . . . Remove chassis from set. Remove spring tension arrangement from shaft and replace with brass rod or old variable condenser spacer tube, drilled to fit snugly over shaft. File brass rod down until it is spool shaped, similar to spools used on sewing machines. This may be done by putting the rod of spacer tube on a small bolt, rotating the bolt in an electric drill and holding a file against it. The spool should now be covered with tape and metallic-xed (a cement) in place. It should then be soldered to the knob shaft, easily removed by lifting the spring before the tape is ce-

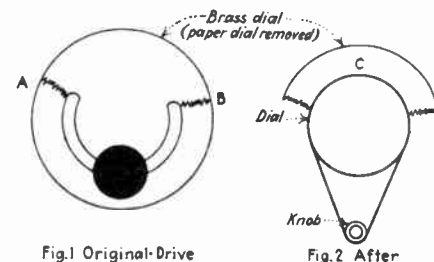

Fig. 1 Original-Drive

Fig. 2 After

mented to the shaft. Remove the paper dial from the set by taking out the round brass clip holding it in place. Cut the slotted brass disc at A & B, shown in diagram, wrap piece of dial cable around the drum portion of dial as shown in 2. Solder in place at spot marked C and wrap two turns around spool on shaft. Splice or solder ends at C, replace paper dial and the job is done.

SPARTON 65, 66. Oscillation . . . See if metal braid shielding on control-grid lead of type 78 tubes, either one, has been pushed down accidentally when removing or installing tube packing, or changing tubes. If so, pull shields up to their full length.

SPARTON 65, 66. Improving selectivity . . . Remove L5 (part A-11041) and install new L5 (part A-11535). Remove C3 (part A-10973) and install new C3 (part A-11474). Connect one condenser of C3 across primary and connect other condenser across secondary of L5. Remove resistor R-11 (part B-5243-34) and install part B-5458-1 2,200 ohm., .25 watt unit. Remove resistor R-15 (part B-5458-33) and install part B-5458-31 (30,000 ohm) .25 watt unit.

SPARTON 67, 68, 691. Vibration . . . Remove small piece of rubber in middle of rear edge of chassis base plate and place small strips of one inch masking tape along edges of base plate, preventing plate from vibrating against chassis frame. Stick one end of tape to top side of plate and fold the other end around so that it sticks to the bottom. Masking tape is obtainable at most hardware or paint stores.

RADIO RETAILING'S "Tricks of the Trade"

SPARTON 69, 79, 79A, 89. (Number terminal strip posts 1 to 9, from front to back.) Detector plate voltage, terminals 1 to 2, should be 180 with pickup inserted in jack . . . If 90 to 135 check 20,000 ohm resistor and its bypass between a.f. transformer primary and filter choke. Detector bias, terminals 2 to 9, should be 14 to 20 . . . If not check 1,200 ohm resistor from phono jack to terminal 2. With pickup in use voltage should be from 3 to 5 . . . If not check 1,000 ohm resistor between jack and terminal 2. R.F. plate voltage, terminals 5 to 6, normally 90 to 135 . . . Check 3,000 ohm resistor or its bypass between filter choke and terminal 6, in filter block. R.F. bias voltage, terminals 5 to 9, voltage normal between 3 and 5 . . . When otherwise check 110 ohm resistor between terminals 5 and 7. A.F. plate voltage, normal between 145 and 185. A.F. bias, normal between 27 and 41 . . . Trouble sometimes develops in 1,700 ohm resistor between ground and c.t. of filament winding. Lack of voltage at any terminal that can be restored by removing cable wire is caused by shorted bypass condenser in associated circuit of r.f. amplifier. Adjust screw on top of tuner, left side, for best response between 1,250 and 1,500 kc.

SPARTON 69A, 79A, 930, 931, 301. Fourth section of band-pass selector, just preceding r.f., sometimes cannot be tuned to resonance with first three sections, producing weak reception and loss in selectivity. Give first, second and third selector trimmers 3 turns clockwise. This makes slightly less tuning capacity necessary for given frequency and fourth section selector can now be adjusted for resonance. Balance set in customary manner with oscillator and output meter and re-adjust kilocycle scale on dial by loosening it on shaft and re-setting.

This space was left blank so you may paste in additional "Tricks of Trade" as they appear in the monthly issues of Radio Retailing.

SPARTON 79A, 89A, 930, 931, 301, 109, 110, 740, 750, 589, 25, 26. Partial or complete open-circuit in r.f. chokes composed of very small enamelled wire wound on bobbin in all band-pass selector and fixed r.f. amplifier models . . . Break most often occurs at point where winding is soldered to ferrules at end of bobbin. This is detectable with an ohmmeter and small pocket magnifier. Remove a few turns of wire, clean with fine sandpaper, then warp a half dozen turns around the ferrule and solder with rosin core. Most of the chokes have a d.c. resistance of about 3,000 ohms and a hundred turns more or less seems to make no difference.

SPARTON 79A, 109, 110, 930. Oscillation "growl" while tubes are heating when using 485's in r.f. stages. Place quick-heaters in first and second r.f. sockets and detector socket, using slow heaters in third, fourth and fifth. If only one quick heater is used place it in the detector socket. If more than three are available place them in third, fourth and fifth.

SPARTON 80, 83, 84. Burning out of 3,000 ohm resistor part B-6061-3 (5,000 ohm part B-6060-5 in later serial numbers) . . . Usually due to failure of .2 mfd., 200 volt condenser connected from plate of a.v. controlled tubes to ground, shown as C8 in diagrams. Replace resistor and replace condenser with 600 volt unit.

SPARTON 80, 83, 84, 85X, 86X, 104, 835. Improving tone of cabinet models . . . Remove screws holding speaker baffle in place. Insert $\frac{1}{8}$ inch spacers under screws, replacing only those at four corners.

SPARTON 89A, 79A. R.f. oscillation in serial numbers using 485 tubes. Re-adjust trimmers to exact resonance. If trouble persists replace .5 m.f.d. B bypass in r. f. amplifier with .25 mfd., 400 volt tubular unit. Some late chassis have it.

SPARTON 333. Intermittent or noisy reception . . . Frequently caused by breaking of stator connections underneath condensers. Replace such leads with stranded push-back wire. (I.F. 456 kc.)

SPARTON 333. Hum . . . May be a floating ground at the eyelet of the 42 tube. One side of the heater circuit is grounded at this point and if the eyelet loosens an intermittent or fading hum of the same pitch as the vibrator will result. Correct by soldering two additional ground connections of the same type and in the same circuit, one at the 6F7 socket and one at the 78 socket. A grounding wire should also be run from the ground circuit heater terminal of the 75 socket over to the resistor mounting plate, which should be grounded.

SPARTON 333. Reception of code or police signals . . . Often caused by breaking of wire which runs from antenna equalizing condenser to r.f. section of the condenser gang. To correct, remove broken wires and solder in 6 inch length of flexible wire. Form a loop in this wire by winding a few turns around a lead pencil. This will allow slack and avoid further difficulty. In the event that the wire connecting the grid cap of the 6F7 first detector-oscillator to the antenna equalizer breaks replace with longer flexible wire run from the grid cap down under the gang condenser and thence to the equalizer.

SPARTON 410. No plate voltage on i.f. tubes and oscillator. Replace tubular condenser attached to front panel with .5 or 1 mfd., 400 volt capacity.

SPARTON 410. Type 45 power tubes may be substituted for the 183's by rewiring the output stage filaments in series, including a half-ohm resistor in the circuit.

SPARTON 410. Set breaks into oscillation after warming up although all voltages, bypasses and ground connections are ok . . . Try two new 183 type tubes.

SPARTON 589. Weak reception and low speaker field current . . . Replace defective resistor with brown and silver ends, connecting primary of a.f. transformer to ground.

SPARTON 930. Fading and cutting out . . . Replace detector plate choke coil.

SPARTON 930, 931. Reception only between 1500 and 850 kc., voltages, condensers, tubes ok. Check for cold soldered joint at 1st r.f. plate choke. While the set is open check value of 15,000 ohm bleeder resistor. They sometimes creep up as high as 67,000 ohms when heated and if found in this condition should be replaced.

SPARTON 930, 931. Replacing 483 power tubes with 45's . . . The usual method is to rewire the filaments in series to reduce voltage from 5 to 2 $\frac{1}{2}$. This usually results in hum. A better method is outlined here: Remove the bias resistor from the center lead of the power transformer. Transfer one of the filament wires from the outer tap to which it is normally connected to the center-tap. Remove the old hum balancing potentiometer and install a 20 ohm center-tapped resistor across the filament circuit. Connect the opened end of the bias resistor to the midpoint.

Sparton 930, 931, 589. When plates of the 485's show low or no potential remove screw at side tab of cylindrical condenser at rear left of amplifier can. Remove responsible condenser by unscrewing with upward twist. Replace. Job can be done in 10 minutes without removing chassis from cabinet.

Add more "Tricks" to this Service Manual.
They appear in every issue of Radio Retailing.

RADIO RETAILING'S "Tricks of the Trade"

SPARTON 931. Thin tone and oscillation accompanied by high plate voltage readings and low speaker field current. 15,000 ohm bleeder has increased in value due to age. Replace with 10 to 25 watt unit.

SPARTON 931, 301. Hum is generally caused by nothing more serious than poorly matched push-pull 182's.

SPARTON 931. Distortion, inability to handle power . . . Look for shorted cathode by-pass condenser in block mounted in base of external audio unit. Quick repair can be made without removing block by cutting shorted condenser lead and connecting a midget 1/10 mfd., 200 volt condenser across the cathode resistor, tucking it in the bottom of the base. If slight attenuation of low frequencies is caused and customer objects mount a 2 mfd., 200 volt non-inductive replacement externally.

This space was left blank so you may paste in additional "Tricks of Trade" as they appear in the monthly issues of Radio Retailing.

STEINITE

STEINITE. Improving volume control in models using control across primary of r.f. coil, with tapped antenna coil . . . Leave tapping switch as is. Use 5,000 ohm tapered control to perform two functions at once, i.e.: reducing r.f. voltage across plate coil and at the same time introducing resistance in the plate circuit. This may be done by connecting the two fixed terminals of the control across the primary of the r.f. coil, carrying the variable arm to B plus and inserting a .1 mike, 300 volt by-pass condenser from B plus to ground. Or one fixed terminal of the control may be connected to plate, the variable arm of the control connected to the low end of the primary and the other fixed terminal to B plus, with a .1 mike condenser from B plus to ground.

This space was left blank so you may paste in additional "Tricks of Trade" as they appear in the monthly issues of Radio Retailing.

STEWART-WARNER

STEWART-WARNER. Loss of volume or sensitivity after defective by-pass condenser is replaced . . . Sets are critical as to by-pass condenser values. Use exact original value of tubular type condenser, avoiding metal-cased replacement units.

STEWART-WARNER.

Some models of auto-radios have loud hum when volume control is at low setting . . . Looser, the r.f. coils and shield wire from volume control to a coupling condenser located under these coil cans on the bottom of the chassis. The shield should be soldered to the grounded terminal of the volume control. Hum is caused by inductive pickup from the A wire to the vibrator being alongside the wire to be shielded. Loud hum and chattering of relay, weak, distorted reception . . . Open plate circuit to one plate of 84. May be bad socket contact.

STEWART-WARNER Converter. No reception . . . Remove both tubes and clean prongs thoroughly with sandpaper. Also see that 27 oscillator shield is not touching condenser gang. Crosstalk from broadcast band while listening to shortwaves . . . See that broadcast receiver dial is set just above 1,000 kc. and make the connecting wire from output of converter to antenna post of bc job as short as possible.

STEWART-WARNER R100A, R100B, R100E. Distortion . . . Check 27-plate current and voltage, which should be about 3 mils. at 115 volts. If low voltage and higher mils., replace .1-mfd tubular coupling condenser, probably leaking. Regular 100,000-ohm ohmmeter will not show it up. Condenser is connected between detector plate choke and first audio grid. It is also a good idea to replace 45,000-ohm (red), 1-watt carbon resistor connected between r.f. plates and ground (bleeder) with a 2-watt carbon job while the chassis is open, as this is a common cause of low voltage and weak reception.

STEWART-WARNER 102A. Quality poor, no volume . . . Check .1 mfd. condenser near 51 tube socket, detector audio coupling .02 and 2 megohm screen-grid second detector resistor.

STEWART WARNER R-102A

Overload on strong signals . . . try different values cathode resistor (original 45,000) as this value often critical.

STEWART-WARNER 110. Loud crackle when set is first turned on (early production models) . . . Don't look for death and destruction in the powerpack. The noise is normal, emanates from electrolytic condenser film breakdown on high starting voltages and the film quickly reforms.

STEWART-WARNER 112. Noise after standard suppression has been installed. Shield tone control and pilot leads from tuning head to chassis with metal braid, grounding at head. Bond shield of antenna lead to metal case of chassis.

STEWART WARNER 116. Hum . . . Check for following possibilities: Poor contact at grounding lug of vitreous voltage divider resistor. To cure, tighten screw used to hold down the grounding terminal and solder it in place. If this does no good cut the 230 ohm negative section out and use a separate 230 ohm unit. To cut out section unsolder from the negative terminal of the divider both the wire leading from the power transformer and the small, red resistor within the insulated sleeving. Re-solder these wires to one end of the 230 ohm resistor. Solder the other end of the resistor to ground. The grounding lug located below the shortwave switch is convenient for grounding. Keep power cord away from the .05, 100 volt isolating condenser. See that green speaker field coil lead goes to the front electrolytic condenser, the white lead to the rear.

STEWART-WARNER R116. Set gets off calibration and loses power on lower end of dial . . . Trimmers on gang are soldered, poor connections develop here. Look for opens or high-resistance, resolder and balance.

RADIO RETAILING'S "Tricks of the Trade"

STEWART-WARNER R116AH. I.f. trimmer requires frequent adjustment Caused by expansion and contraction due to temperature. Readjustment required every 2 to 3 months where weather varies widely.

STEWART WARNER R-116X

Weak and distorted . . . Shorted 0.1 mfd. condenser between positive terminals of electrolytic condensers shorting speaker field. Replace with 600 volt unit.

STEWART-WARNER R-136, R-137, R-138. Insensitive above 12 mc. despite perfect alignment and correct voltages, shadow-meter on last two chassis mentioned contracts as if station was tuned in when set is switched to this high-frequency range . . . Due to stray coupling within set wiring. Sets up spurious oscillation of the 6A8, causing the control grid to draw current, producing an a.v.c. voltage and reducing sensitivity. To eliminate trouble isolate grid return of the 6A8 from the a.v.c. system by returning it directly to ground. The grid coil of this tube is tuned by trimmer condenser 11 in the 136, by trimmer 15 in model 137 and trimmer 16 in the 138, referring to the diagram. Shortwave section is the one wound with heavy, bare copper wire and grid return is at the top, the lead running down the full length of the coil before it is soldered to its terminal lug. The simplest way to isolate the grid return circuit is to cut the heavy coil wire as close to the lug as possible. Be careful not to cut the fine wire from another winding soldered to this same terminal. After cutting the heavy wire merely re-solder it to the grounded, threaded support lug of the coil. Re-align the set after change is made.

STEWART-WARNER R136, R137, R138.

Poor sensitivity at low frequency end of broadcast band, inability to align or calibrate at 600 kc., oscillation at low frequency end of broadcast band . . . Almost always due to large change in capacity of small bakelite fixed condenser connected across oscillator shunt padding trimmer. Unit colored brown, brown, black. Replace with .000Q11 original replacement number 85434.

STEWART WARNER R147

Station hum . . . replace .1 mfd. screen bypass on 6A8 with .5 mfd. unit.

STEWART WARNER R 149

Hum on stations . . . connect 6K7 and 6J7 screen grids together. Remove .01 mfd. condenser and 110,000 ohm resistor connected to i.f. circuit.

Add more "Tricks" to this Service Manual. They appear in every issue of Radio Retailing.

STEWART-WARNER R301, R301A, R301B, R301E. Inoperative, especially on high frequency Check voltage of 27 oscillator. If less than 100 converter is probably cutting out. If series resistor, usually 17,500 ohms, is used in series with red plate lead, remove this resistor entirely or substitute one of lower value to supply 100 volts to plate. While chassis is open resolder connections to coils and other high frequency connections. Slipping dial mechanism Twist thin rubber band around each rubber pulley. Also check for leaky 2-mfd. plate, by-pass condenser, even though it functions ok. Leak of approximately 150,000 ohms indicates unit will soon break down. Condenser is cased and connected between 25,000-ohm, 1-watt plate supply resistors and ground.

STROMBERG-CARLSON 846A

Whistling and motorboating . . . Frequently caused by defective 10-ohm center tapping variable rheostat across filament winding of detector tube. Wire on this rheostat takes solder so carefully solder wire ends to lugs and center lug t case of rheostat.

STEWART-WARNER 950 SERIES. Burned out volume control. Measure voltage across control and if in excess of 70 replace 20,000 ohm, three watt resistor with new unit.

STEWART-WARNER 950, R100. Poor sensitivity and low volume. Check red resistor 66326 for low value or charring. This resistor shunts r.f. plates to minimize effect of variation in plate current when different tubes are used and if low increases load and reduces screen voltages.

STEWART-WARNER 950. Set dead or no pep with excessive hum . . . Check $\frac{1}{2}$ mfd. condenser in cathode circuit of detector, speaker field resistor and filter condensers.

STEWART-WARNER 950. Oscillation at low frequencies. Clean variable condenser contact clips and bend them to increase pressure. Oscillation at high frequencies. Look for open .25 mfd. r.f. by-pass condenser located close to r.f. coils. Tone distorted, set oscillates. Try replacing .25 mfd. r.f. grid by-pass condenser. If set oscillates when quick-heater tubes are used replace .25 mfd. screen-grid by-pass with .5 mfd. or more.

STEWART-WARNER 1121, 1122.

To increase volume and improve tone . . . Disconnect B-plus (yellow and red lead) from side of output transformer from screen grid terminal of output tube and connect it to the high voltage side of the combination relay and filter choke. The most convenient point to connect is the cathode terminal of the rectifier tube. This raises plate potential about 40 volts. Change the grid resistor of the 41 from 510,000 ohms to 250,000. It is inclosed in a piece of large spaghetti and is connected from the 41 grid to ground. Change the permanent tone control condenser which is connected to the plate of the output tube from .01 to .006, 600 volts. It may be necessary to readjust the spring of the relay as output tube plate current no longer passes through it. Reduce the tension of the relay spring, which tends to keep the contacts closed, by stretching it slightly.

STEWART-WARNER 1171. To reduce brilliancy of pilot light . . . Replace 15 ohm pilot light resistor with 35 ohms.

STEWART-WARNER 1181, 1182.

Bell-like rattle . . . Traceable to tubular condensers inside power transformer cover. These units break off and strike against cover. Remove four screws, pry off cover, resolder and tape condensers to transformer and replace cover. Set inoperative except for faint response on powerful locals . . . Look for broken lead on coupling condenser connected to movable arm of volume control. Mounting hint . . . Sets are equipped so that speaker may be pointed outward but trouble will be experienced in this position due to the horizontal position of the vibrator and tubes. Use side or end mounting with speaker downward.

STEWART-WARNER 1181, 1182, 1183. Won't play unless local switch is clicked on and off . . . Change 50,000 ohm resistor on 6A7 socket to 60,000 ohms. If set goes into oscillation put a .25 mike condenser from cathode to ground on the 6A7.

STEWART WARNER 1236-B

Oscillation . . . replace 4 mfd filter condenser in can with audio bypass with higher voltage type.

This space was left blank so you may paste in additional "Tricks of Trade" as they appear in the monthly issues of Radio Retailing.

RADIO RETAILING'S "Tricks of the Trade"

STROMBERG

STROMBERG 10, 11.

Fading, making it necessary to operate volume control well up . . . Seven hundred ohm section of voltage divider opens commonly. Replace with 10-watt unit.

STROMBERG-CARLSON 25, 26. No reception . . . Examine chassis bolts. Frequently one of these extends too far and touches voltage divider.

STROMBERG-CARLSON 25, 26.

Set starts and stops playing . . . Look for loose wire in tuning condenser compartment. Usually still in place but not well soldered. Also check 100,000 ohm fixed resistor in series with center lug of volume control. This sometimes loosens and shorts to ground.

STROMBERG 29. On-off switch and tone control unit is electrically and mechanically identical to the phonograph and pickup switch and volume control unit. When on-off switch contacts are discovered to be burned out, and the set is not equipped with a pickup, interchange the two units, making sure that the "jumper" across the pickup input is in place. This saves \$1.95 until the customer wants to use a pickup.

STROMBERG 635, 636. "Mushy" or choked reception . . . See if pilot light socket shorts to chassis.

STROMBERG 641.

Intermittent reception or fading . . . Often caused by loose lugs on 800 ohm volume control.

STROMBERG 641, 642. Noisy volume control . . . Replace rear unit. Fading . . . Try replacing the front volume control unit. Continual static . . . Discard primary of push-pull transformer and go to resistance coupling, using 25,000 or 50,000 ohm plate resistor and .01 blocking condenser. Peculiar buzz or hum . . . See if 25 cycle transformer has been installed (several New York chains sold sets of this type) and if so tighten transformer laminations or replace.

STROMBERG 846, 848. Periodic fading, antenna control fails to function properly . . . Check small wire-wound resistor in series with antenna control, in turn shunted across antenna coil. Disconnect resistor and tighten up rivet holding one end.

T. C. A. CHASSIS

TCA CHASSIS.

Used in Temple 10, Brunswick 10, Clarion 40, Bulova M501, Columbia SC31, this chassis has a tuned filter system with all inter-connections inside a can. When any section fails the entire block must be replaced. Exact duplicates are difficult to obtain so the following is sometimes used as a substitute: Connect a .0005 from the 47 control grid to chassis, a .01 from one side of switch to chassis, a 12 mike electrolytic from high voltage end of Candohm resistor to chassis, an 8 mike electrolytic from 80 filament to center-tap of high voltage winding. A tone condenser may be connected between the tone switch and chassis if desired but in most instances this has been omitted by repairmen as it is rarely used. Capacity, .02. Scratchy sound similar to defective audio transformer . . . Usually found in the Candohm. Cut wires inside unit for a considerable distance in each section with sharp knife, then solder a 10,000 ohm, 10 watt resistor across the high voltage section and a 5,000 ohm 10 watt unit across the low voltage section. The original terminals make excellent anchor lugs.

TEMPLE

TEMPLE 8-60, 8-80, 8-90. Hum. Poorly matched 45's is usually the cause.

TEMPLE. Repair parts, circuit diagrams can be obtained from Lester A. Bolden, 2515 West 59th St., Chicago

TRAVELER

TRAVELER. Noise in models using a yellow coated, heavy bus wire around an r.f. coil for coupling . . . Remove heavy bus wire very carefully and see if insulation is not worn off, shorting to windings of coil underneath.

TRAV-LER C.

Weak . . . Check yellow resistor under chassis, mounted with a red and blue resistor. Increases in value sufficiently to almost stop reception.

YOU SEE IT FROM THE
Back
BUT IT HAS KEPT
MILLIONS OF RADIO SETS
In Front

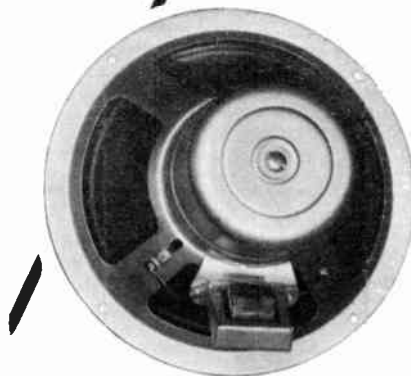

One of the first things many radio set engineers do when confronted with a speaker problem, is to consult with Operadio engineers.

Whenever a masterpiece of radio set craftsmanship is in the making, it is not unusual for the engineer to be working with this organization to give the set the final touch of perfection that only a *good* speaker can provide.

While you can see them only from the back . . . set engineers and manufacturers know that *Operadio* Speakers do a good job of keeping their radios *in front*.

You get the same high type reproduction and satisfaction in use when you use *Operadio* Speakers for your replacement and P. A. jobs.

Address Dept. TT for data on our complete line of speakers

SPEAKER HEADQUARTERS FOR THE NATION
OPERADIO
MANUFACTURING COMPANY
ST. CHARLES • ILLINOIS
EXPORT DIVISION: 145 WEST 45TH STREET NEW YORK CITY

RADIO RETAILING'S "Tricks of the Trade"

TRUETONE

TRUETONE O52 SERIES (Wells-Gardner). Weak reception . . . Check .1 mike condenser from 35 screen to ground. Replace 250,000 ohm, eighth watt resistor from 2nd detector 57 plate to 80 filament even if it tests ok. On load it sometimes drops plate volts from 180 to 100. Use a one-watt carbon replacement. (I.F. 262 kc.)

This space was left blank so you may paste in additional "Tricks of Trade" as they appear in the monthly issues of Radio Retailing.

U. S. AIRCELL

U. S. AIRCELL SETS. Models built for Gloritone, Apex, U. S. Radio and Montgomery-Ward develop trouble in speaker coils due to penetration of moisture to fine wire of windings . . . Magnetic speakers have two-coil driving unit designed to operate direction in plate circuit of 33. When replacement coil is received coat it with white shellac and dry.

US BATTERY SUPER. Persistent howling . . . Connect 2 mfd. condenser across B-batteries, mounting it in the chassis for convenience.

U. S. 8. Excess oscillator plate voltage, or none at all, is traceable to change in value of 50,000-ohm plate resistor. Replace with unit having 2-watt rating, instead of original 1-watt size. Drifting of i.f. transformers due to moisture absorption is also reported.

US RADIO 10. Jumpy volume control. Look for gassy 27 in first a.f. socket.

US 10

Overloading . . . Check 200,000-ohm resistor in plate circuit of a.v.c. tube, also condenser from plate of this tube to cathode. Erratic reception . . . Examine resistance strip mounted tight against side of cardboard electrolytic upon which the a.v.c. circuit resistors are mounted. There is often sufficient leakage between the resistance strip and the condenser to cause trouble. Insulate with cardboard.

U. S. RADIO AND TELEVISION 10. Hum, volume control will not reduce volume to zero . . . Replace the 8 mike condenser under the resistance strip in the center of the chassis. It frequently opens, causing this trouble.

Add more "Tricks" to this Service Manual. They appear in every issue of Radio Retailing.

U. S. 24

Volume control ineffective on strong signals . . . Replace control with good left hand tapered 5000 ohms carbon control and reverse center and high leads. In the original the antenna went to center arm.

U.S. 27

Intermittent . . . leakage in wet electrolytics. Liquid on top of can causes short between positive terminal and can. Mount with vents on top. If boiling still persists replace both 8 mfd sections.

US RADIO 48. Oscillation. Check bypass condensers and also detector r.f. choke located beneath chassis in right rear corner when looking from front. Men report difficulty in re-aligning this model as it oscillates when condenser gang cover is removed. Rotate the cover plate half way around, after it is removed and then place it on top of the chassis so that the tube shield plates are placed between control grid leads of screen grid tubes, at the same time moving it back far enough to leave the condenser gang uncovered.

U. S. WASHINGTON

US WASHINGTON 34. Intermittent reception. Change 200,000 ohm grid filter resistor between 35 grids and a.v.c. tube plate to 100,000 ohms.

This space was left blank so you may paste in additional "Tricks of Trade" as they appear in the monthly issues of Radio Retailing.

UNITED MOTORS

UNITED MOTORS 2035. Vibrator test . . . Connect 8 volts to battery leads, remove 5 ampere fuse in 84 filament lead and shunt an ammeter across the fuse terminals. Place a good 84 in the rectifier socket. The meter should jump to 10 amperes and then drop back to 4.5 if unit is normal. Voltage from plate of 84 to ground is 300 a.c.

UNITED MOTORS 4038 (CHEVROLET 600249, 600565, BOP 980459). Low or intermittently low volume accompanied by poor quality and missing bass notes . . . Check primary of push-pull input transformer carefully. Trouble is deceptive as voltages are not affected.

WELLS-GARDNER

WELLS GARDNER OEL

Distortion on strong stations when tuned exactly to resonance, reception normal when detuned slightly. . . Balance i.f. as one transformer is badly out of alignment.

WELLS GARDNER 5E

Noisy . . . Replace the 50 mmf. condenser between plate of 34 I.F. and grid of second detector. This is a special wire wound capacity but can be replaced with a 100 mmf. mica.

WELLS-GARDNER 20 (GULBRANSEN 23). Failure of 40,000 ohm yellow resistor mounted on voltage divider . . . Due to overload, substitute 2 watt unit. The resistor goes from first a.f. plate transformer B plus to B plus of power pack or to low voltage end of field used as choke and is a filter unit.

WELLS-GARDNER 20 (Gulbransen 23, Griffith 20). No volume . . . Check 40,000 ohm carbon resistor attached to end of Candohm, wired between plate of 1st a.f. 27 and grid of 47's. If defective, replace with 5 watt size of same resistance and replace .5 mfd. bypass, in the condenser block (red wire) with external .5 mfd. unit rated at 600 volts. Intermittent or fuzzy reception . . . Check and, if necessary, replace .1 mfd., 600 volt and .05 bypass condensers.

WELLS GARDNER 24

Poor tone, weak . . . replace .01 mfd. 360 v.d.c. condenser (part No. 46 x 120) with 600 volt unit.

WESTINGHOUSE

WESTINGHOUSE WR5 (Graybar 800, GE H31). To snap up sensitivity . . . Remove shield from first intermediate frequency transformer.

WESTINGHOUSE WR5, 6, 7, 8. Poor quality and low volume . . . Look for grounding of strip of resistors under chassis, lowering C bias to power tubes. Grounding occurs when heat expands resistors.

WESTINGHOUSE WR24

Noisy, when walking across floor or bumping the set . . . Socket prongs lose their tension and fail to make good contact with tube pins.

RADIO RETAILING'S "Tricks of the Trade"

WURLITZER

WURLITZER SA120. Dead or weak or motorboating when inter-station silencer is turned to extreme left Look for trouble in one of three 5 mfd., 50-volt condensers. It is often best to replace all three with new units having higher voltage rating.

WURLITZER SUPERHETS

Noisy . . . I.F. coils wound with 6 strand litz, failure of one strand won't show up on ohmmeter but increases R.F. resistance. Cut leads, fray and scrap each strand separately and resolder.

ZENETTE

ZENETTE CH SERIES.

Excessive regeneration and no volume . . . Often due to defective electrolytic located in square can at far end of chassis (left side) bypassing choke located underneath chassis. Choking up when volume control is advanced or tuning dial shifted . . . Caused by 500,000-ohm plate resistor in a.v.c. tube dropping in value.

ZENETTE A, B, C, D. Erratic operation, squeals, overall efficiency loss . . . Replace 25,000 ohm series plate resistor with same value in 10 watt size. Check all high value resistors in detector plate circuits for 25 per cent change in value, also 1 megohm resistor in first r.f. grid return. If set is radio-phonograph combination keep wire from phono switch as far away from receiver circuits as possible. Put .00025 condenser from detector choke to ground for greater stability.

ZENITH

ZENITH 4B131

Oscillator dead . . . Remove oscillator coil, place eighth inch composition spacing washers over mounting lugs and reassemble.

ZENITH 4T-26, 56

Oscillation, hum . . . replace condenser block 22-407. Shorted or open condensers are very common at this point.

ZENITH 4V131, 4B31

Inoperative. . . . This set will not operate if pilot light is burned out. It is connected in series with the two 15 tubes. Replace with a 2.9 volt bayonet type bulb. Must be exact replacement for proper operation.

Noisy. . . . Replace 15 tube in first r.f. stage. Many times this tube tests perfect, replacement is only way trouble can be found

ZENITH 6B129

Distortion. . . . Replace 8 mfd. filter condenser in power pack. Capacity of this unit has decreased.

ZENITH 6D, 70

Weak signals accompanied by strong A.C. hum . . . half of filter condenser across speaker field shorted: replace.

ZENITH 6M-90, 6M-91, 7M-91

Dead, intermittent or noisy when jarred . . . Look for broken connection from bottom of condenser gang to oscillator or first detector coil.

ZENITH 6-M-90, 6-M-91, 7-M-91

Noisy, inoperative at times . . . Check the 600 k.c. padder and tuning condenser. The ground lead to these units often breaks loose. Resolder for a permanent cure.

ZENITH 12U158-159

Distortion at low volume . . . replace 1 watt 400 ohm cathode resistor on 6F6 with 5 watt wire-wound unit. Check cathode bypass condenser for leakage.

No reception on lowest wave band . . . untwist grid lead wires from screw on gang condenser. Realign, using .0001 mfd. mica condenser from oscillator to antenna.

Weak reception, high noise level . . . check r.f. alignment, also fixed condenser grouped around volume control.



RED HEAD BRAND CONDENSERS

Precision built of the finest materials and constructed to the highest standards of engineering practice — yet, they cost you less, enabling you to realize a bigger profit on your condenser replacements.



A PRECISION QUALITY PRODUCT for the SERVICEMAN

Red Head Condensers bring you the utmost in serviceability and dependability. Their popularity in all branches of the Radio Industry has been attained solely on the basis of performance. Scientific control in manufacture coupled with materials of the highest purity imparts to "Red Head" Capacitors unquestioned quality. "Red Head" Capacitors are available in all standard sizes and capacities — Bypass and Electrolytic—high and low voltage. Start using "Red Heads" now — save the difference.

SPECIFICATION SHEETS ON REQUEST

CONSOLIDATED LEADS THE FIELD IN—

- RADIO WIRES AND CABLES
- AUTOMOBILE ANTENNAS
- AERIAL KITS
- TESTING EQUIPMENT
- INSULATORS
- LIGHTNING ARRESTORS
- RADIO SPECIALTIES OF ALL KINDS

FROM YOUR DEALER

CONSOLIDATED
WIRE AND
CORPORATIONS

512 SO. PEORIA ST., CHICAGO, ILL.

RADIO RETAILING'S "Tricks of the Trade"

ZENITH 33X. Reception faint, audio ok . . . Look under chassis near the antenna compensating coil (movable). Here you will find a 2,000 ohm resistance from ground to coil. It is often left open. It may usually be simply left out. Tone raspy . . . Change over 171 to 112 tube.

ZENITH 35-P, 40-P. Noisy reception . . . Look for high resistance ground on secondary of original a.f. transformer. Green corrosion is frequently found under the terminal lugs. Ohmmeter tests rarely show up this grief.

ZENITH 50 SERIES. Pronounced hum not due to trouble in filter . . . Apparently due to pickup of hum inductively from the filter choke by the a.f. transformer between the first and final a.f. stages. It will be found that first a.f. stage plate is fed through .1 meg. resistor, a.f. passing from this plate through a blocking condenser to the audio transformer primary, the low end of which is connected to the cathode. Remove the blocking condenser and shunt the transformer primary with a .1 megohm resistor. Connect the low end of this resistor to ground through a 2 mike by-pass. Now feed plate voltage to the low end of the transformer primary, through an additional .1 megohm resistor. The connection from the B plus transformer terminal to cathode is, of course, removed.

ZENITH 50

Loud hum, all parts and tubes check O.K. . . . Connect a .25 meg. resistor between grids of second audio stage.

ZENITH 50 SERIES. Loud hum, all parts and tubes checking ok . . . Connect 250,000 ohm resistor from grid to grid of push-pull second audio tubes.

ZENITH 50 Series. To simulate a.v.c. . . . In re-setting the automatic tuning levers first throw the antenna trimming control to the extreme left and leave it there. Tune the weakest station of the selection as sharply as possible and set the volume control until the volume is barely audible, about one or two db. Leave the volume control alone from then on. In setting each of the other stations, detune them so that the volume is the same as it was on the weakest station and lock the lever at this point. In this way, as each lever is pressed all stations come in with equal volume, the volume equalizing being done by the lever automatically detuning the correct amount. Do not try this on supers of a later series as serious distortion will result. In the tuned r.f. sets the selectivity is not so great as to cause appreciable distortion.

ZENITH 50, 52. Loss of sensitivity at one end of dial. Remove can from condenser gang, remove screws holding stators in place at each end, place lock-washer under these and tighten. When screws loosen re-aligning only unbalances set at other end of dial.

ZENITH 50, 60, 70. Persistent hum. By-pass detector cathode to ground with 1 or two mfd. condenser, supplementing the one already in the circuit.

ZENITH 70. Volume dies down after set is in operation for a few seconds, requiring readjustment of volume control. Replace detector (white) plate resistor. Correspondents report other troubles traceable to resistors, some replacing all 10.

ZENITH 70. Where trouble is experienced in cutting down the volume of loud locals connect the unused "off" position lug of the r.f. gain control resistor (not the antenna resistor section) to one of the 27 first audio grids. This provides antenna, r.f. and a.f. volume control.

ZENITH 70. Fading or intermittent reception. Look for open or shorted .25 mfd. dual plate by-pass condenser located on the first and second r.f. stages, or .03 mfd. by-pass condenser located between the plate of the first a.f. tube and the primary of the first a.f. transformer. If signals vary from weak to normal suspect the first. If they are always weak check the second.

ZENITH 70. Intermittent reduction in volume accompanied by sharp click and ragged tone. Replace first audio plate blocking condenser with 300 volt, .5 mfd. paper type.

ZENITH P-71

Dead . . . shorted filter section on either side of choke coil. Cut shorted lead, connect 8 mfd electrolytic with *negative* side to choke; positive lead goes to connector strip.

ZENITH 91, 92

Inoperative until 24A a.v.c. is removed . . . open a.v.c. voltage divides connect 15,000 ohm 1 watt wire wound resistor across that section which is between cathode and screen grid tops.

ZENITH 705

Broad, insensitive . . . remove cathode resistor and bypass on 2A7 mixer. Ground cathode, then repeak I.F. and R.F. stages.

ZENITH 730 SERIES

Intermittent or inoperative . . . shorted I.F. bypass from primary to secondary or shorted I.F. winding. Also to improve performance remove fine stranded enameled wires of I.F. coils where they pass through eyelets at base of coil form and run externally through spaghetti, sharpening I.F. resonance peak due to reduced coupling, realign. I.F. frequency is .485 K.C.

ZENITH 750. Set inoperative, i.f. tube grids heat red hot . . . Look for shorted i.f. transformer. This is caused very often by the leads of one winding touching those of the other side of the winding.

ZENITH 755. Oscillator fails to operate below 850 kc. . . . Antenna coil frequently absorbs moisture and should be rewound or replaced, carefully doped with good coil dope to avoid repetition of trouble.

ZENITH 760.

Hum, after regular values of filter condensers have been installed . . . May be reduced by bypassing the .5 bypass condenser next to primary of input transformer with 8 mike electrolytic. Distortion . . . Bypass center-tap of volume control to ground with .00015 mica unit. This removes the r.f. load on the grid of the first a.f. tube and allows greater a.f. amplification.

ZENITH 880.

Distortion and AVC blocking . . . Shorted .0004 condenser, part 22-285 in first r.f. coil can.

ZENITH 1937 MODELS

Strong motor-boating with switch in distance position . . . replace screen grid and plate bypass condensers marked C 4 in schematic.

ZENITH FORD AUTO RADIO

Dead, tubes do not heat, switch must be snapped several times to start . . . replace volume control and switch. The trouble is in the switch only, but the control is usually worn also. Use a D.P.S.T. switch for longer life. Connect the poles in parallel.

This space was left blank so you may paste in additional "Tricks of Trade" as they appear in the monthly issues of Radio Retailing.

Add more "Tricks" to this Service Manual. They appear in every issue of Radio Retailing.

COMMON TROUBLES, STAGE-BY-STAGE

(Compiled from *Radio Retailing's* "Tricks of the Trade" File)

SYMPTOMS

Inoperative	Oscillator plate resistor open First I. F. transformer primary open Shorting, or open oscillator trimmer Open plate choke	Plate load resistor open or shorted Shorted trimmer condenser Control grid lead shorting to shield Open plate filter choke	Shorted electrolytic condenser Filter choke open Open voltage divider Shorted or open power trans...er secondary	Open voice coil Secondary of output transformer open Voice coil leads open Voice coil leads shorted to pole piece
Intermittent Fading	Poor insulation on oscillator trimmer Open grid return resistor High resistance at lugs of oscillator coil Dirty band switch contacts	Defective volume control Lead resistor bypass shorting High resistance in I. F. secondary R. F. bypass condenser shorting	Shorted or leaky filter condenser Loose contacts on voltage divider Defective line switch Filter choke shorting to ground	Voice coil lugs making poor contact Metal filings grounding voice coil Secondary of output transformer opening Field coil connections making poor contact
Oscillation Noisy	Open grid coil Cathode bypass open or leaky Shield on grid leads corroded or open Decoupling resistor shorted	Open plate or grid bypass Defective volume control Out of alignment Defective plate load resistor	Open filter condenser Defective voltage divider Filter choke leaking to ground Leaky bypass from rectifier to ground	Metal filings grounding voice coil Warped cone Voice coil rubbing on pole piece Voice coil winding loose
Distortion Hum	Leaky plate bypass condenser Shorted or leaky cathode bypass Open grid filter condenser Oscillator misaligned	Defective volume control Leaky audio coupling resistor Plate load resistor too high Leaky plate bypass condenser	Open or shorted primary bypass condenser Centertap on filament windings open Open or leaky output filter condenser Grounded pilot light bracket	Field coil open or shorting Hum bucking coil shorted or reversed Voice coil rubbing on pole piece Unfiltered field supply

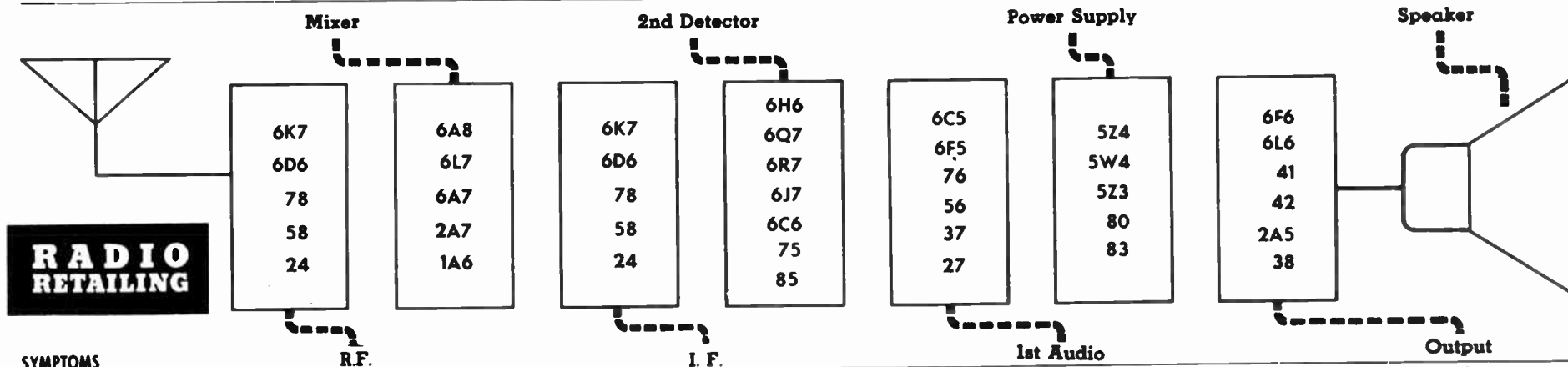

SYMPTOMS

Inoperative	Open or shorted R.F. coil Band switch contacts dirty Shorted tuning or trimmer condenser Open plate decoupling resistor or choke	Open I. F. coil Plate decoupling resistor open Shorted trimmer condenser Primary and secondary bypass shorted	Plate load resistor open Open audio coupling condenser Shorted plate load bypass Open cathode resistor	Primary of output transformer open Open cathode bias resistor Shorted audio coupling condenser Secondary of output transformer shorted or open
Intermittent Fading	Shorting trimmer condenser Loose connecting lugs on R.F. coil Leaky plate or screen bypass Band switch making poor contact	Open or shorting grid bypass Litz wire on lugs corroded Trimmer condenser shorting A.V.C. network defective	Defective audio transformer primary Open volume control Leaky grid or plate coupling condenser Defective plate load resistor	Defective primary on output transformer Open cathode bias resistor Shorting audio coupling condenser Open secondary on input transformer
Oscillation Noisy	Rotor contacts on tuning condenser dirty Open cathode or screen bypass Shorted bias resistor Aligned too sharply	Screen bypass open I. F. out of alignment Shorted cathode bias resistor Poor coil contacts at lugs	Shorted cathode bypass Plate decoupling resistor shorted Open plate bypass condenser Primary of coupling transformer opening	Open cathode bypass condenser Defective cathode resistor Leaky audio coupling condenser High resistance from primary to secondary
Distortion Hum	Shorted filament bypass Antenna too long, causing overload Shielding making poor contact Shorted antenna coupling condenser	Open cathode bypass Stage out of alignment Too sharply tuned, oscillation High resistance between primary and secondary of I. F. transformer	Shorted grid or plate coupling condenser Cathode bypass shorted Audio transformer open or shorting High resistance from primary to secondary of audio transformer	Shorted cathode bypass Screen grid circuit open Shorted turns on output transformer If pushpull, tubes are unbalanced

Socket Tops

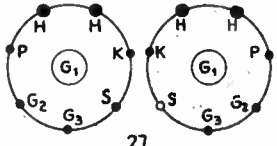
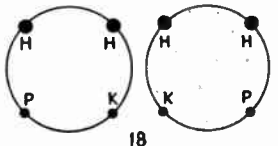
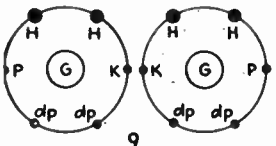
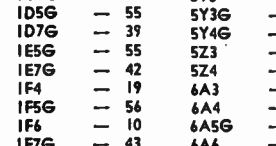
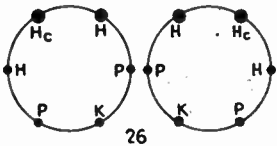
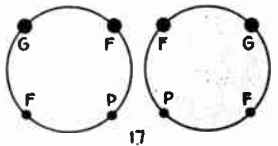
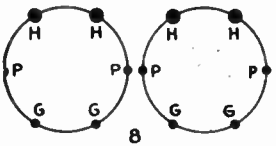
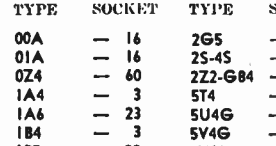
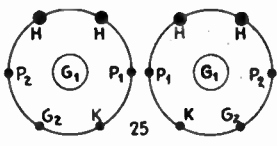
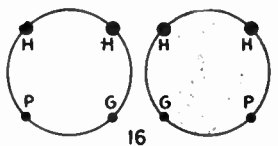
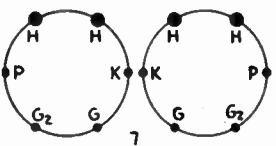
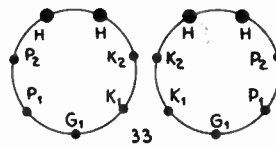
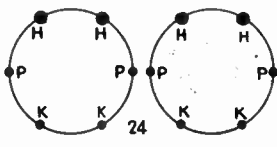
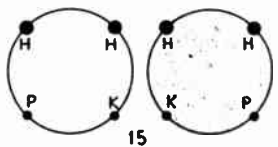
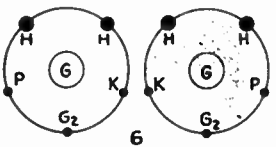
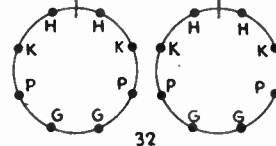
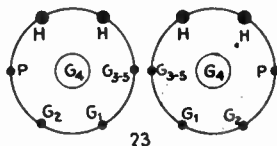
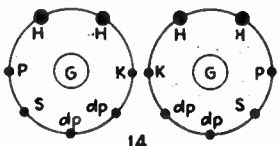
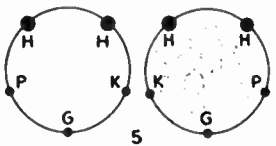
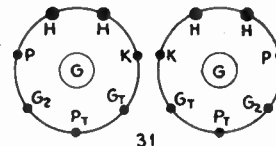
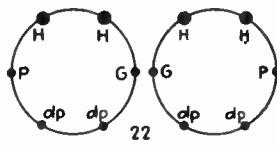
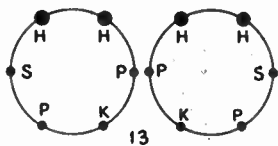
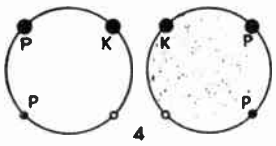
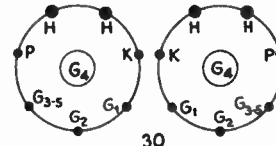
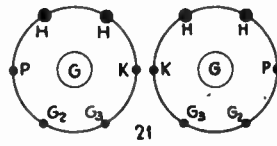
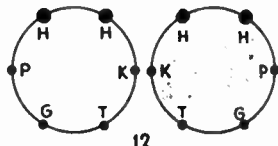
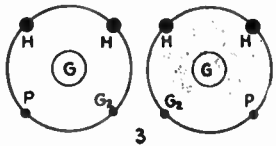
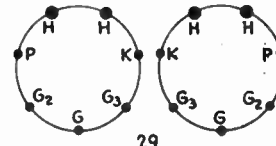
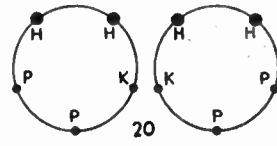
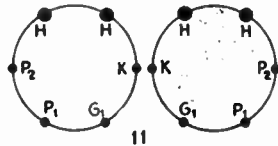
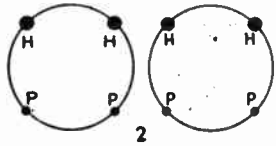
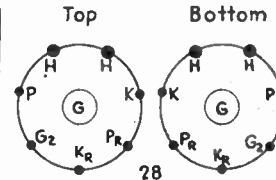
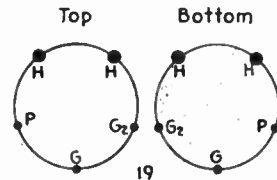
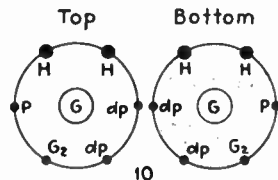
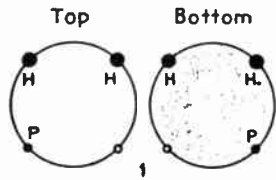

©Radio

TYPE	SOCKET	TYPE	SOCKET	TYPE	SOCKET
00A	— 16	2G5	— 12	6D5	— 37
01A	— 16	2S-4S	— 20	6D6	— 21
0Z4	— 60	2Z2-G84	— 1	6D7	— 27
1A4	— 3	5T4	— 45	6D8G	— 39
1A6	— 23	5U4G	— 54	6E5	— 12
1B4	— 3	5V4G	— 54	6E6	— 34
1B5	— 22	5W4	— 45	6E7	— 27
1C6	— 23	5X4G	— 64	6F5	— 38
1C7G	— 39	5Y3	— 45	6F6	— 61
1D5G	— 55	5Y3G	— 54	6F7	— 31
1D7G	— 39	5Y4G	— 64	6G5	— 12
1E5G	— 55	5Z3	— 2	6H5	— 12
1E7G	— 42	5Z4	— 45	6H6	— 53
1F4	— 19	6A3	— 16	6J5G	— 37
1F5G	— 56	6A4	— 19	6J7	— 52
1F6	— 10	6A5G	— 37	6K5G	— 50
1F7G	— 43	6A6	— 34	6K6G	— 51
1H4G	— 57	6A7	— 30	6K7	— 52
1H6G	— 44	6A8	— 39	6L5G	— 37
1J6G	— 58	6B4G	— 57	6L6	— 51
1V	— 15	6B5	— 11	6L7	— 59
2A3	— 16	6B6	— 40	6N5	— 12
2A5	— 7	6B7	— 35	6N6	— 61
2A6	— 9	6B8	— 43	6N7	— 46
2A7	— 30	6C5	— 37	6P7G	— 47
2B6	— 33	6C6	— 21	6Q6G	— 63
2B7	— 35	6C7	— 14	6Q7	— 40
2E5	— 12	6C8G	— 66	6R7	— 40

a n d B o t t o m s

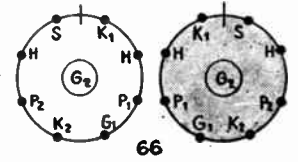
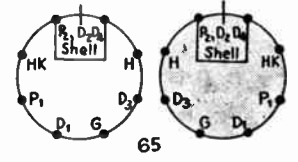
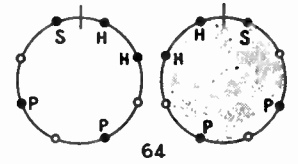
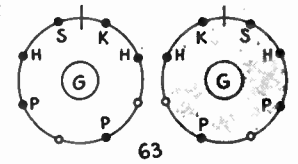
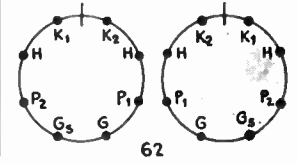
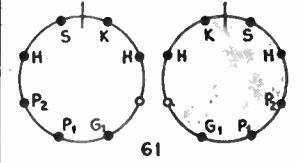
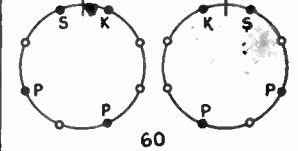
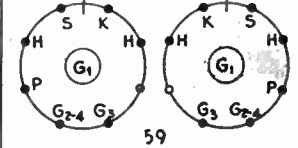
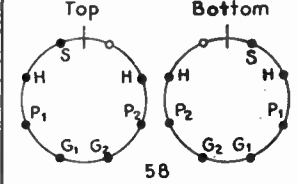
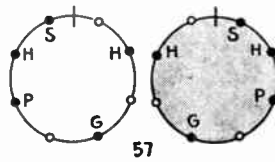
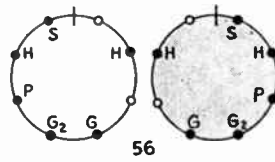
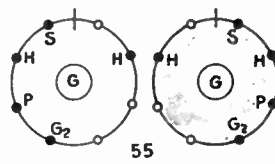
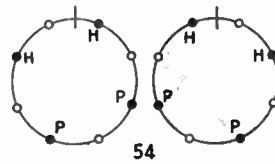
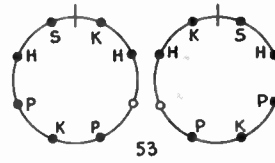
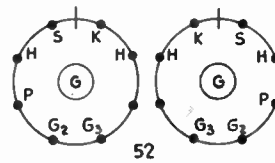
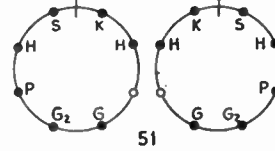
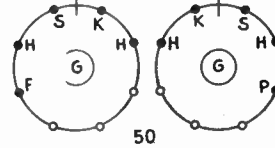
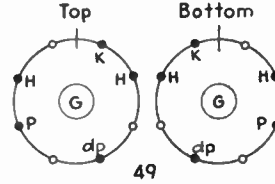
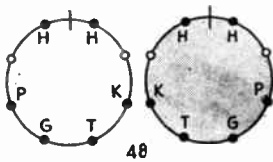
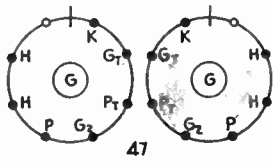
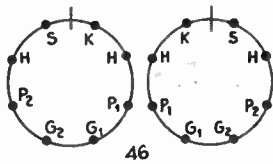
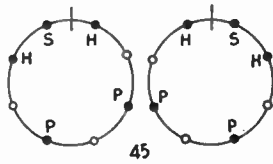
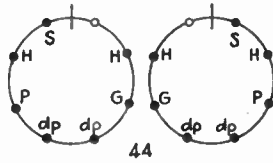
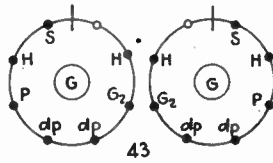
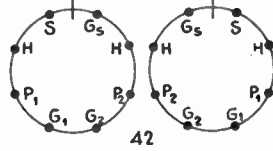
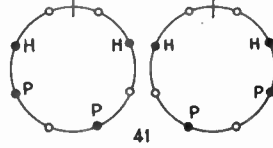
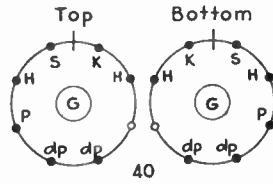
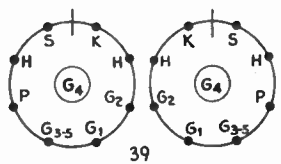
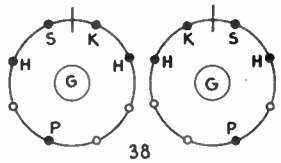
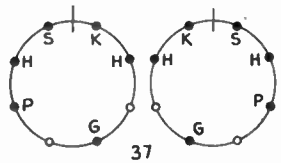
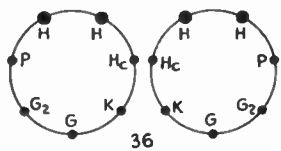
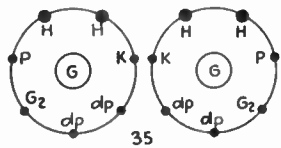
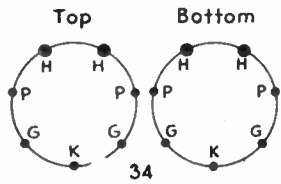

Retailing

TYPE	SOCKET	TYPE	SOCKET	TYPE	SOCKET
6S7G	— 52	26N6	— 41	55	— 9
6T5	— 12	25Y5	— 24	56	— 5
6T7G	— 40	25Z5	— 24	57	— 21
6U7G	— 52	25Z6	— 53	58	— 21
6V6G	— 51	26	— 16	59	— 29
6V7G	— 40	27	— 5	71	— 16
6X5	— 43	30	— 16	75	— 9
6Y5	— 13	31	— 16	76	— 5
6Y7G	— 46	32	— 3	77	— 21
6Z5	— 26	33	— 19	78	— 21
10	— 16	34	— 3	79	— 25
11	— 17	35	— 6	80	— 2
12	— 16	36	— 6	81	— 1
12A5	— 36	37	— 5	82	— 2
12A7	— 28	38	— 6	83	— 2
12Z3	— 15	39	— 6	83V	— 2
15	— 6	40	— 16	84	— 20
18	— 7	41	— 7	85	— 9
19	— 8	42	— 7	89	— 21
20	— 16	43	— 7	V99	— 17
22	— 3	44	— 6	X99	— 16
24A	— 6	45	— 16	182B	— 16
24XH	— 65	46	— 19	183	— 16
25S	— 22	47	— 19	485	— 5
25A6	— 51	48	— 7	913	— 65
25A7	— 62	49	— 19	950	— 19
25B5	— 11	50	— 16	BR	— 4
25L6	— 51	53	— 4	LA	— 19

ACTUAL SOCKET VOLTAGES

(Measured to chassis with 1000-ohms-per volt D. C. instrument)

	A C	AC-DC		A C	AC-DC	
38 Audio	145 to 170 150 to 185 0 11 to 14.5	105 to 115 95 to 105 0 9 to 11		0 to 1 26 to 4 65 to 75 0 26 to 4	0 to 1 2 to 3 65 to 85 0 2 to 3.5	6J7 Detector
77 Mixer	240 to 277 0 to 7 100 to 110 0 7 to 20	80 to 115 0 105 to 115 0 17.5 to 22		231 to 265 1 to 25 91 to 110 0 1 to 3.5	99 to 110 0 to 3 105 to 115 0 0 to 3	6K7 R. F. Amplifier
78 R. F. Amplifier	245 to 275 0 160 to 170 0 0 to 31	105 to 120 2 to 2.5 85 to 95 0 2 to 2.5		Not used	93 to 102 102 to 111 0 to -0.6 10 to 12.5	25A6 Audio
6B5 Audio	225 to 285 215 to 265 0 0 to 4	90 to 105 90 to 105 0 0 to 2		Not used	105 to 115 90 to 115 0 0	25B5 Audio
6C6 Detector	35 to 40 0 20 to 26 0 3 to 5	18 to 22 0.1 to 0.5 12 to 15 0 17.5 to 22		240 to 265 0 0 -1 to -2.5	105 to 118 0 0 -1 to -2	6E5 Tuning Indicator
6D6 R. F. Amplifier	240 to 265 4 to 7 80 to 110 0 2.5 to 7	105 to 118 2.5 to 3.5 90 to 118 0 2 to 5		245 to 265 0 0 -1 to 3	105 to 118 0 0 -1 to 2.8	6G5 Tuning Indicator

ACTUAL SOCKET VOLTAGES

(Measured to chassis with 1000-ohms-per-volt D. C. Instrument)

6J7
Oscillator

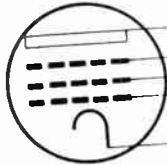

AC.Sets	AC-DC.Sets
150 to 220	75 to 90
0	0
150 to 200	70 to 90
-15 to -12	-5 to -9
0	0

6K7
I.F. Amplifier

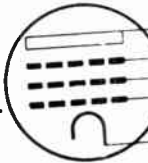

AC.Sets	AC-DC.Sets
230 to 255	90 to 107
0 to 7	0
100 to 125	90 to 107
0 to -3	0
0 to 8	3 to 7

6L6
Output

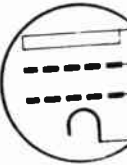

AC.Sets	AC-DC.Sets
255 to 280	90 to 107
250 to 256	90 to 107
0 to 16	0 to 11
0 to 15.7	0 to 10

6R7
Detector-
Amplifier



AC.Sets	AC-DC.Sets
130 to 175	55 to 75
Small	Small
3 to 5	1 to 2

6Q7
Detector-
Amplifier



AC.Sets	AC-DC.Sets
40 to 130	55 to 75
Small	Small
2 to 65	1 to 2

6N6
Output



AC.Sets	AC-DC.Sets
220 to 285	90 to 105
230 to 290	90 to 105
0 to 4	0 to 2

AC.Sets	AC-DC.Sets
245 to 260	82 to 107
95 to 130	50 to 65
0 to -0.2	
130 to 165	82 to 100
-5 to -20	
0 to 4.5	0 to 2

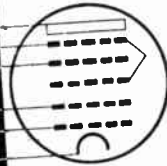

6A8
Mixer

(Trans)	(Res)
245-270	90-100
0	0
7-9	5

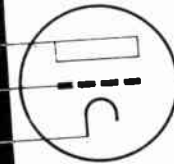

6C5
Amplifier

(Trans)	(Res)
125	75
150	90
0.2	0.2
0	0
1.5	1.5

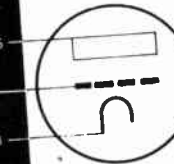

6F5
Amplifier

AC.Sets	AC-DC.Sets
225 to 245	90 to 107
250 to 260	90 to 107
-0.2 to -0.5	-0.1 to -0.2
0	0

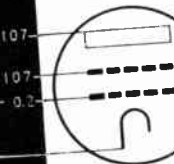

6F6
Output

(Signal Volt.)	(Signal Volt.)
-0.4 to -3	-0.1 to -1
-0.3 to -3	-0.1 to -1
0 to -3	0 to -1
0 to -3	0 to -3

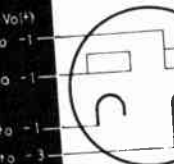

6H6
Detector-
A.V.C.

AC.Sets	AC-DC.Sets
250 to 270	85 to 105
75 to 100	50 to 65
-0.4	-0.2
-2 to 7	
0	0

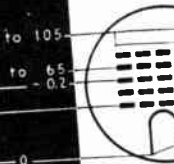

6L7
Mixer

Here's a new **RADIO RETAILING** service chart idea designed to speed up location of set trouble
95% of all receivers using the tubes illustrated apply voltages within the limits shown

ACTUAL SOCKET VOLTAGES

(Measured to chassis with 1000-ohms-per volt D. C. instrument)

6A7
Mixer

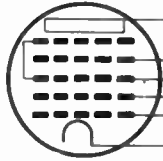

AC.	AC-D.C.
230 to 265	97 to 134
0	0
90 to 110	63 to 80
137 to 180	80 to 112
-3 to -7.5	-2.6 to -8
2.5 to 5	2 to 2.6

6B7
Detector
Amplifier

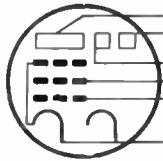

AC.	AC-D.C.
115 to 135	25 to 45
0	0
0	0
75 to 105	20 to 35
0	0
1 to 2	1 to 15

6C6
Detector

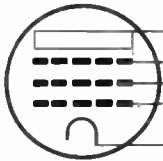

AC.	AC-D.C.
0 to 30	0 to 22
0 to 2.6	0 to 2
25 to 75	18 to 45
0	0
0 to 2.6	0 to 2

6D6
I.F.
Amplifier

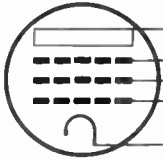

AC.	AC-D.C.
225 to 265	97 to 105
2.8 to 6.6	3 to 3.5
90 to 120	97 to 105
0	0
2.5 to 6.6	3 to 3.5

6F7
Detector
I.F.
Amplifier

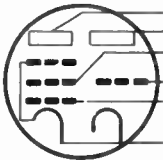

AC.	AC-D.C.
110 to 135	83 to 105
118 to 140	20 to 35
45 to 60	70 to 105
0	0
0	0
0 to 15	0

41
Output

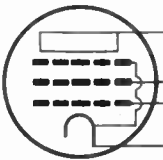

AC.	AC-D.C.
220 to 245	75 to 105
225 to 255	95 to 110
-1 to -6	-0.3 to -15
0	0

AC.	AC-D.C.
225 to 247	75 to 105
240 to 260	80 to 110
-1 to -7	-0.3 to -15
0	0

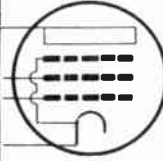

42
Output

AC.	AC-D.C.
Not used	75 to 105
	95 to 120
	-0.3 to -17
	0

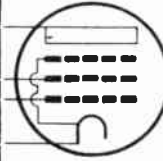

43
Output

AC.	AC-D.C.
80 to 95	30 to 35
-0.1 to -0.2	0
-0.1 to -0.2	0 to -0.1
0	0
0	0 to 1

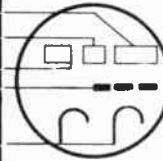

75
Detector
Amplifier

AC.	AC-D.C.
115 to 140	35 to 48
0	0
72 to 10	35 to 48

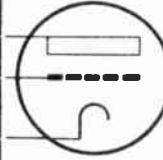

76
Audio

AC.	AC-D.C.
225 to 250	107 to 120
2.7 to 6.5	2 to 2.6
30 to 115	80 to 107
0	0
2.5 to 6.5	2 to 2.6

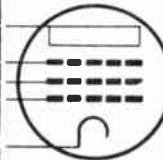

78
I.F.

AC.	AC-D.C.
118 to 135	40 to 48
0	0
2 to 25	0 to -0.1
-0.01	0
5 to 17.5	0 to 1

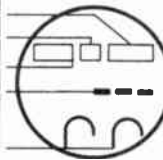

85
Detector
Amplifier

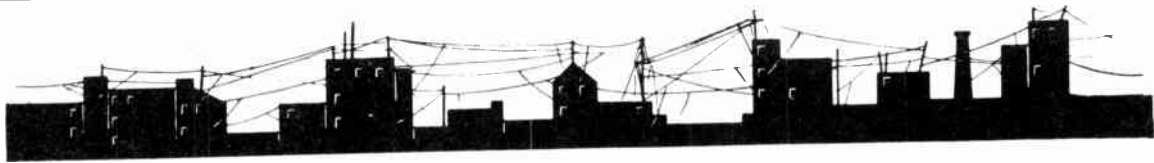

CHOOSING AN ANTENNA

"No Radio Can Be Better Than Its Antenna"

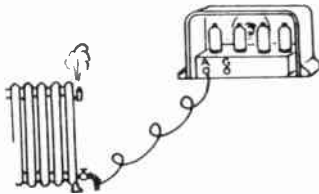

GROUND AS ANTENNA—Fair reception on local broadcast stations in some homes. Seldom satisfactory in suburban areas and useless for shortwaves. Use only where other systems cannot readily be installed, or for temporary service.

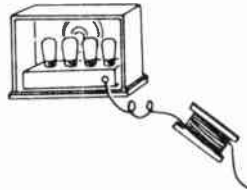

BUILT-IN WIRE—Good reception on local broadcast stations in all but extremely noisy buildings. Receives reasonably distant stations when used on upper floors in electrically quiet areas. Rarely effective on shortwaves and invariably noisy in large apartment houses.

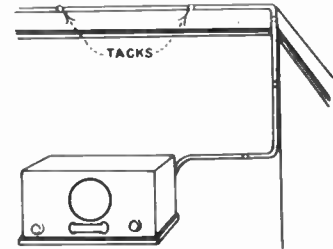

MOULDING STRIP—Good reception on local broadcast stations in all but extremely noisy buildings. Receives reasonably distant stations when used on upper floors in electrically quiet areas. Rarely effective on shortwaves and invariably noisy in large apartment houses.

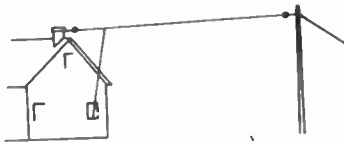

ORDINARY OUTDOOR SYSTEM—Excellent on both broadcast and shortwave bands when building and vicinity are electrically quiet. Recommended for homes away from trolley-lines, high-tension wires, motors and busy roads.

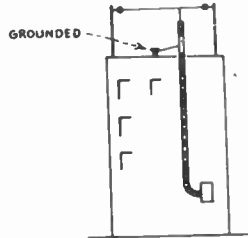

SHIELDED LEAD-IN—Reduces noise pickup by download where this wire must pass through electrically disturbed areas. Good reception on broadcast band but not recommended for shortwaves. In common with other noise-reducing types, must have antenna proper mounted out of noisy area for maximum benefit.

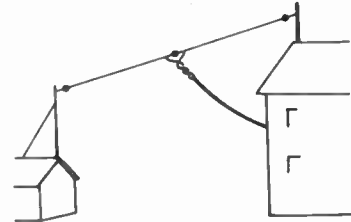

SIMPLE DOUBLET—Reduces noise pickup by download where it must pass through noisy areas. Good reception on shortwave band and satisfactory for broadcast reception. Especially efficient at certain frequencies, which may be those most often desired.

TYPICAL MODERN ALLWAVE MATCHED TYPES

Matched to reduce losses in the transmission line between the antenna proper and the set and designed, also, to give good reception over the entire broadcast and shortwave range, or in those portions of the

spectrum in which programs of major interest are found, these modern types and variations of them represent the last word in modern radio design.

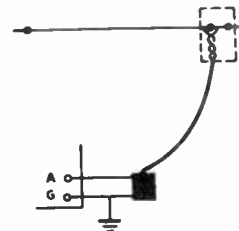
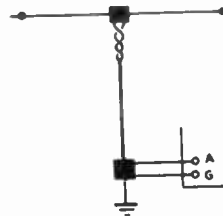
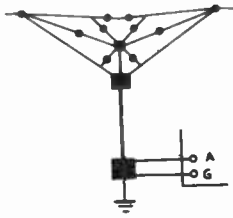
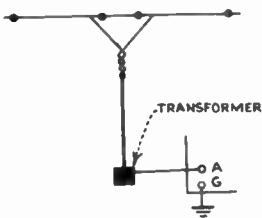

THINGS TO AVOID



Electric Socket "Adapter"

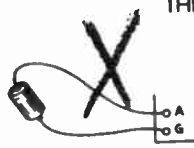

Aerial "Eliminator"

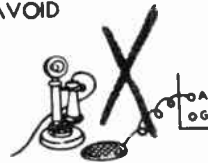

Telephone Connection

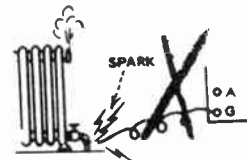

Grounding AC-DC Sets

Sales Ammunition from RADIO RETAILING

1937 AUTO IGNITION CIRCUITS

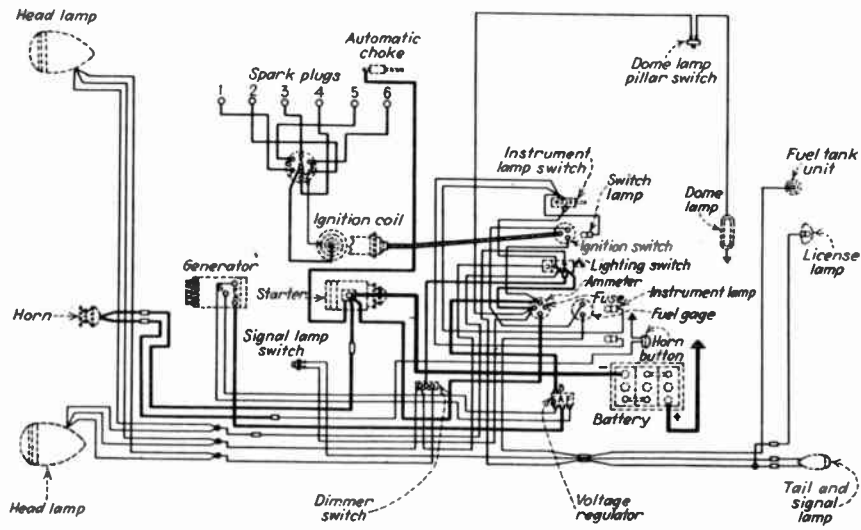

Dodge 6

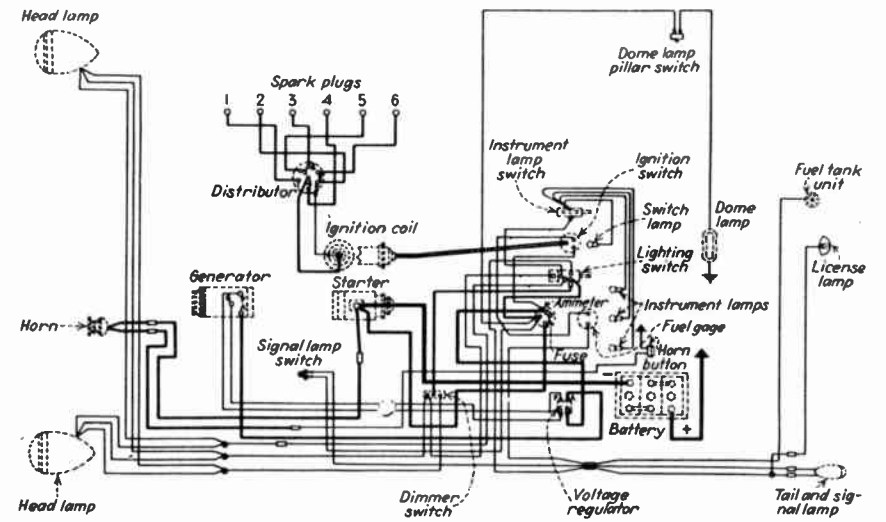

Plymouth DeLuxe

RADIO RETAILING

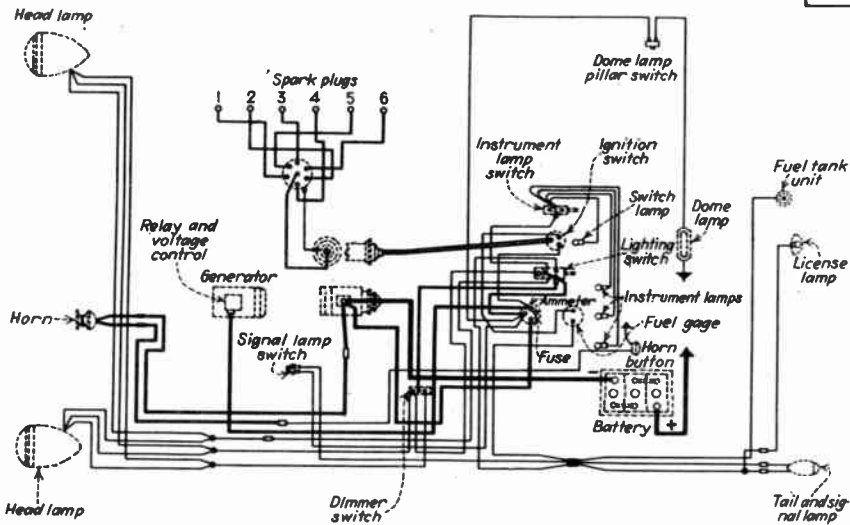

Plymouth Business 6

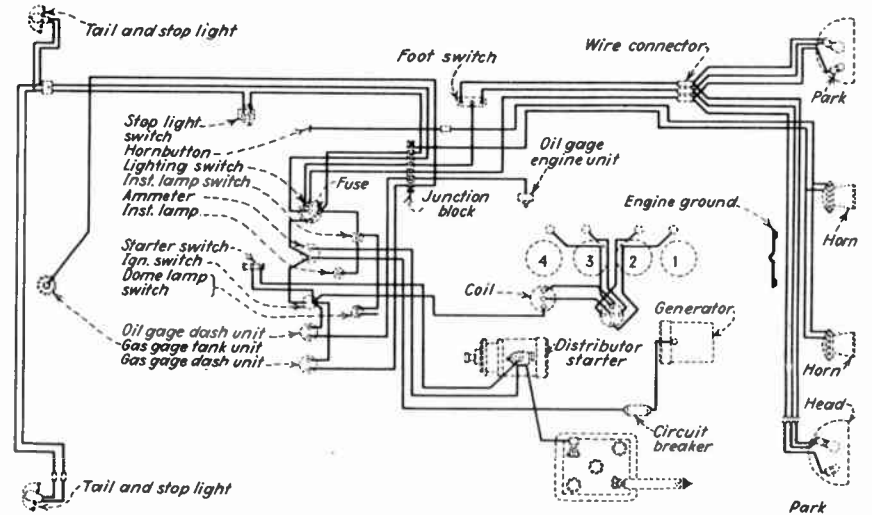

Willys 37

TO BE CONTINUED

1937 AUTO IGNITION CIRCUITS

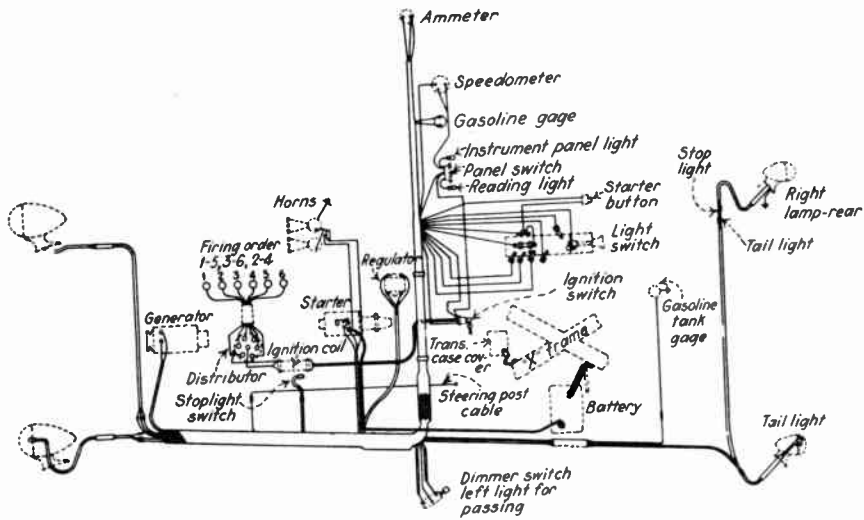

Packard Six

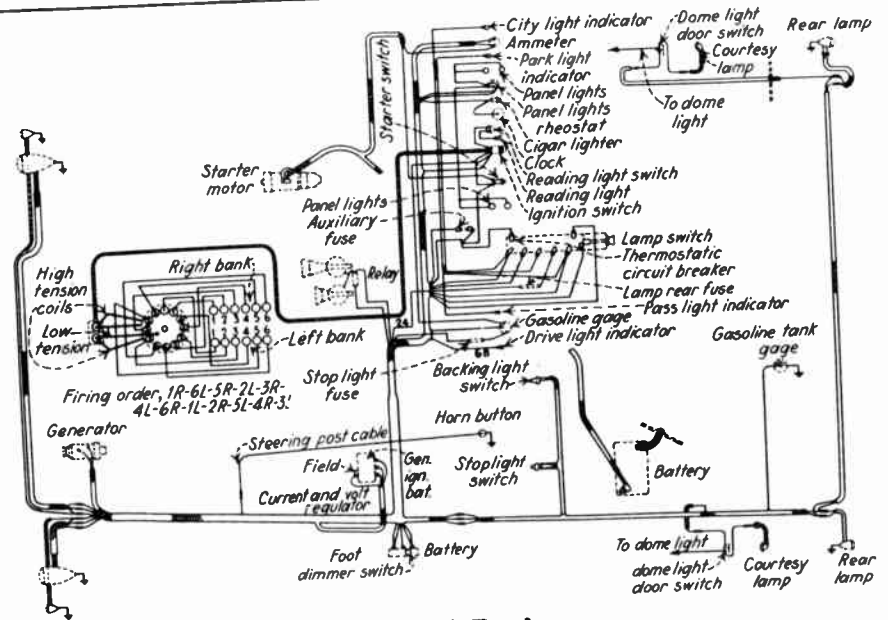

Packard Twelve

RADIO RETAILING

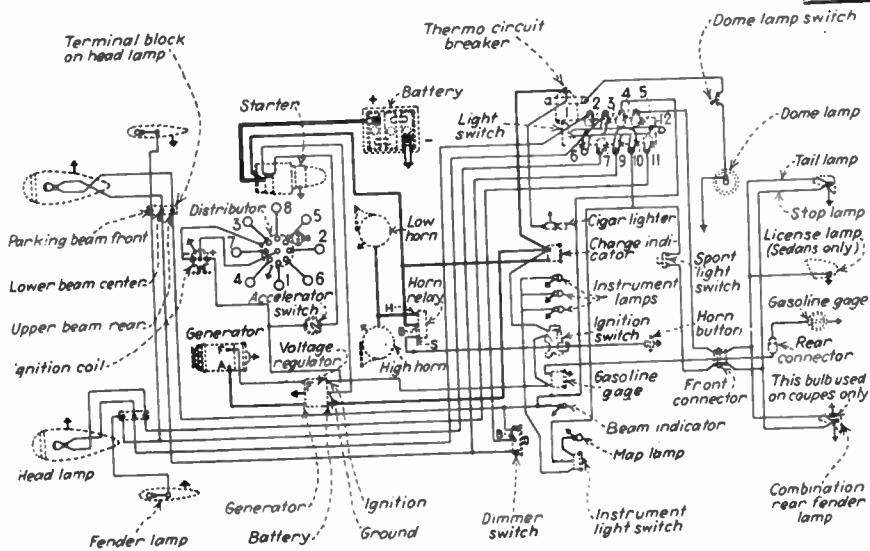

Buick 40

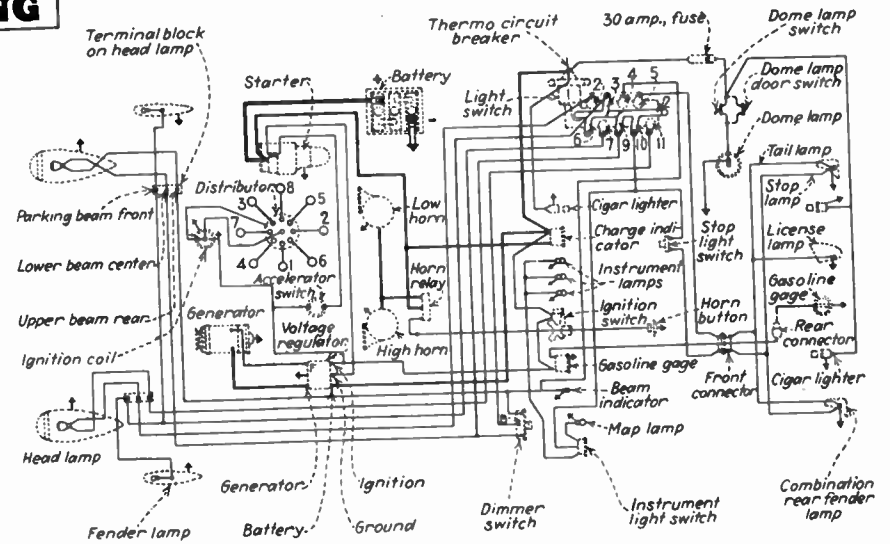

Buick 60-80-90

1937 AUTO IGNITION CIRCUITS

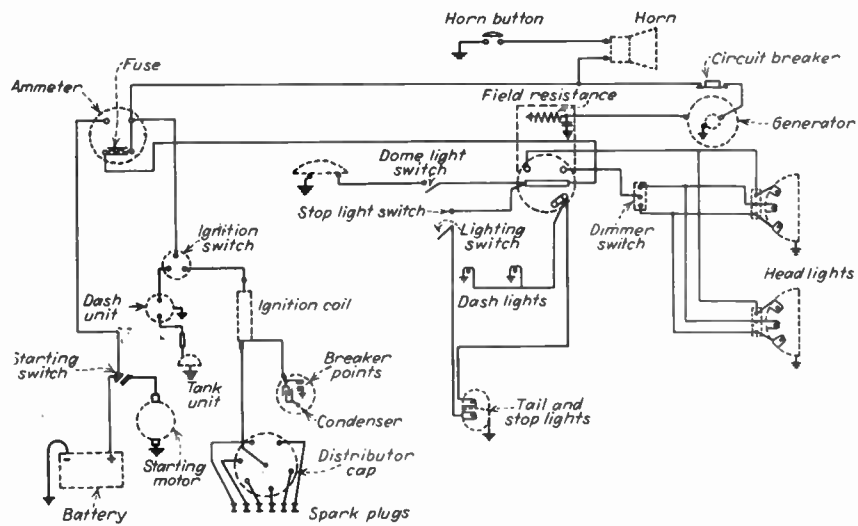

Chevrolet

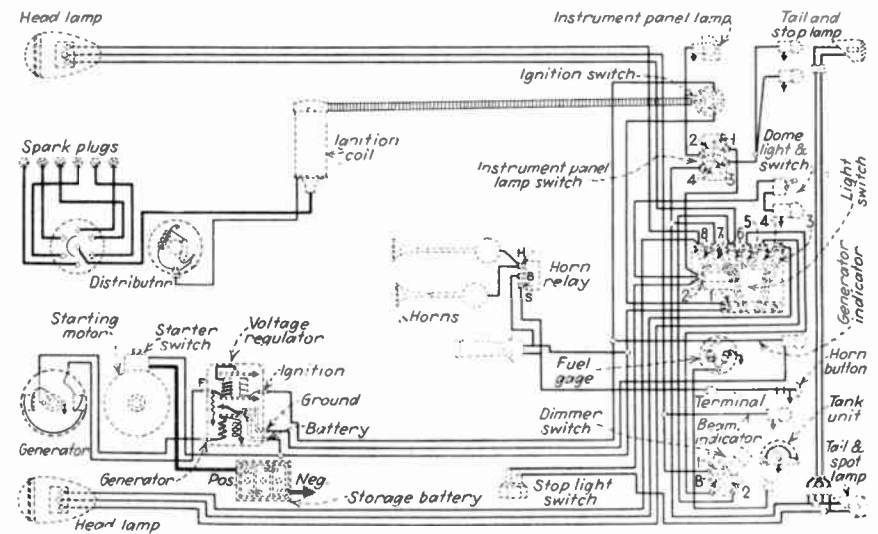

Pontiac 6

RADIO RETAILING

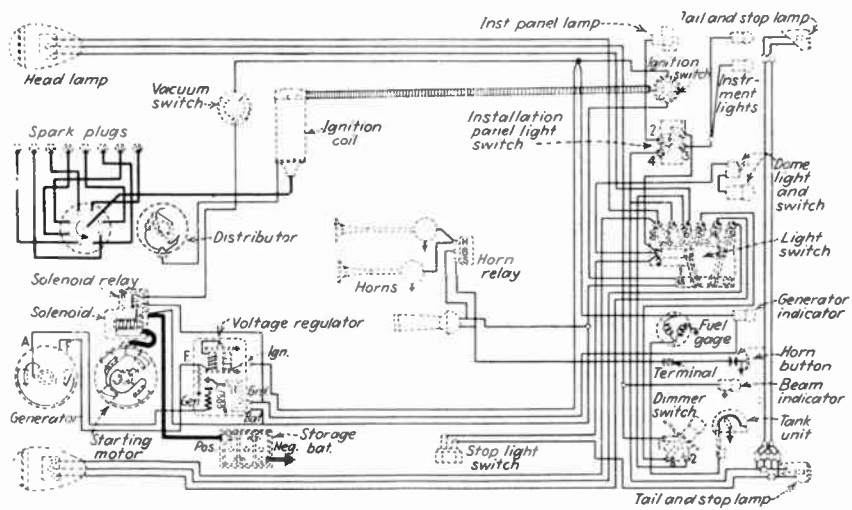

Pontiac 8

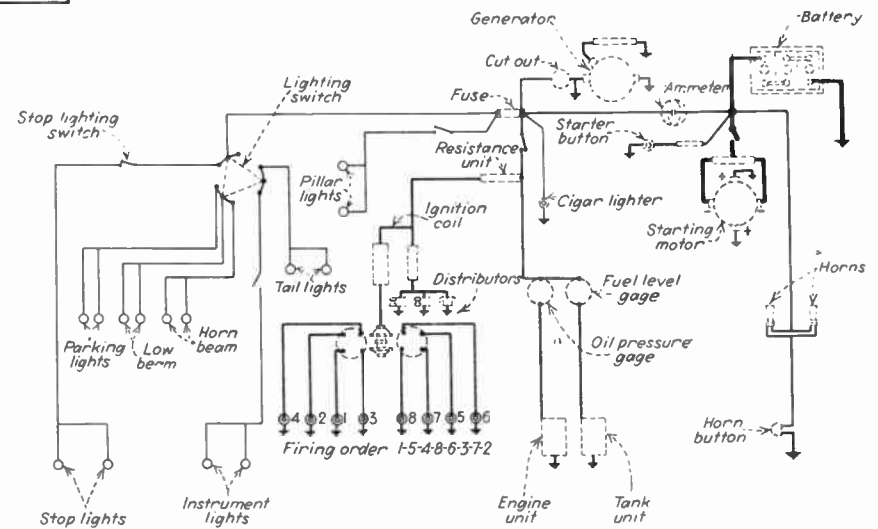

Ford 85 - Ford 60

1937 AUTO IGNITION CIRCUITS

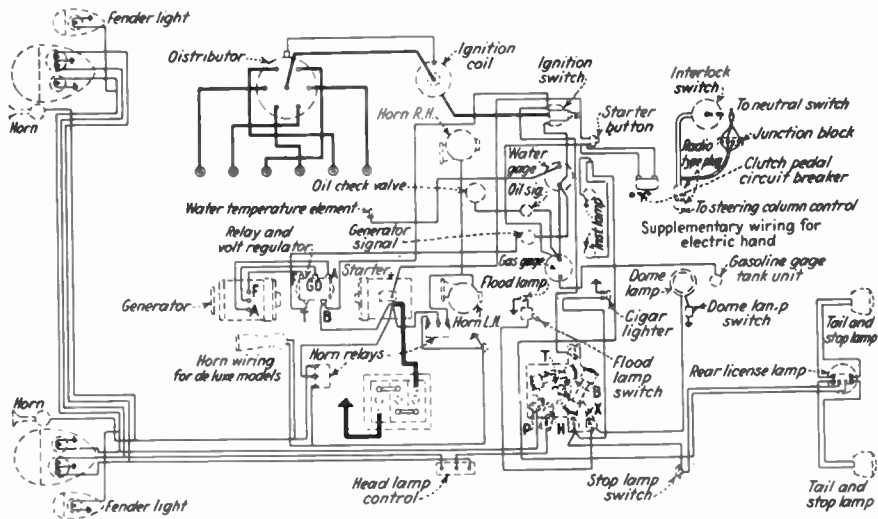

Terraplane

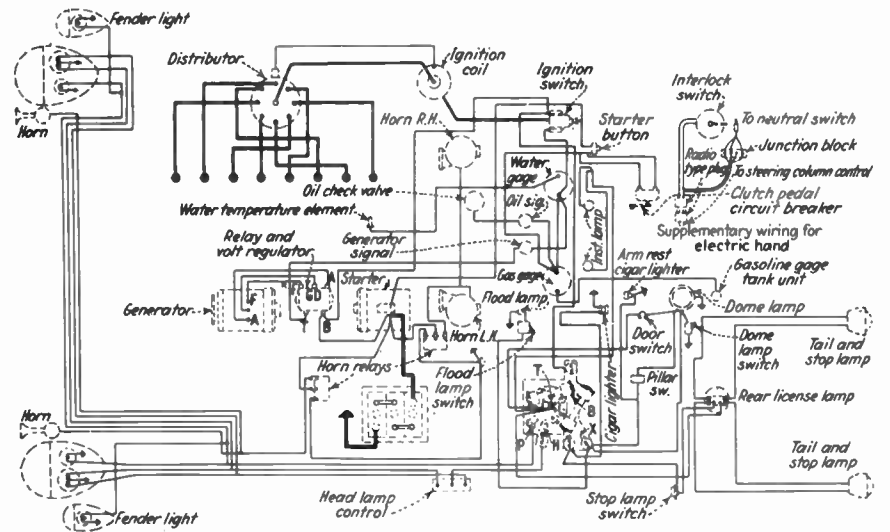

Hudson 8

RADIO RETAILING

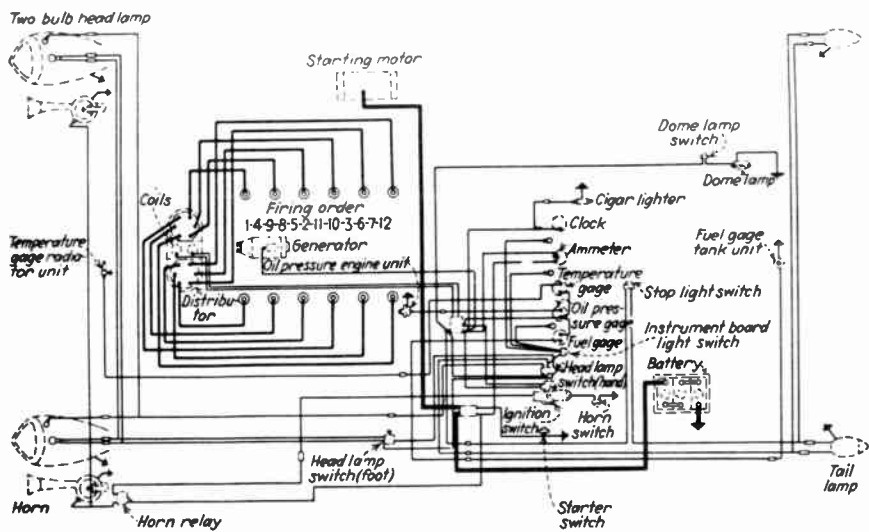

Lincoln Zephyr

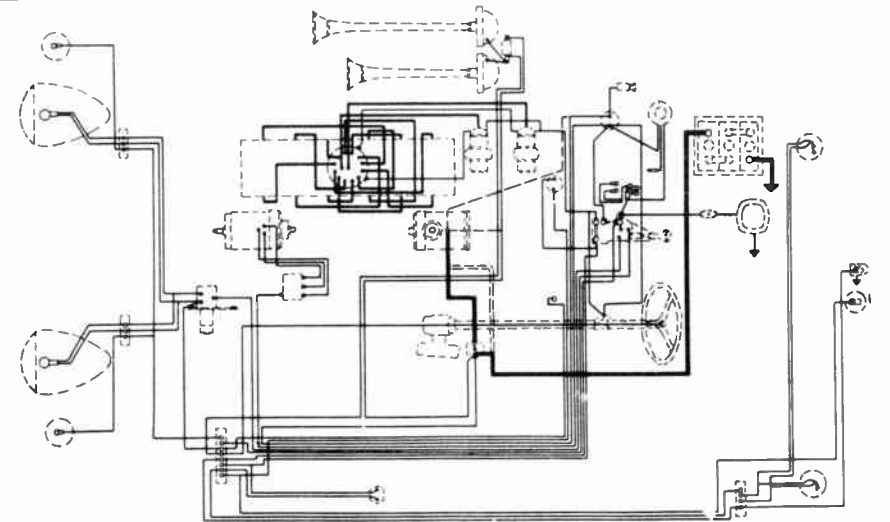

Nash Ambassador

CONCLUDED
(12 diagrams appeared in March)

1937 AUTO IGNITION CIRCUITS

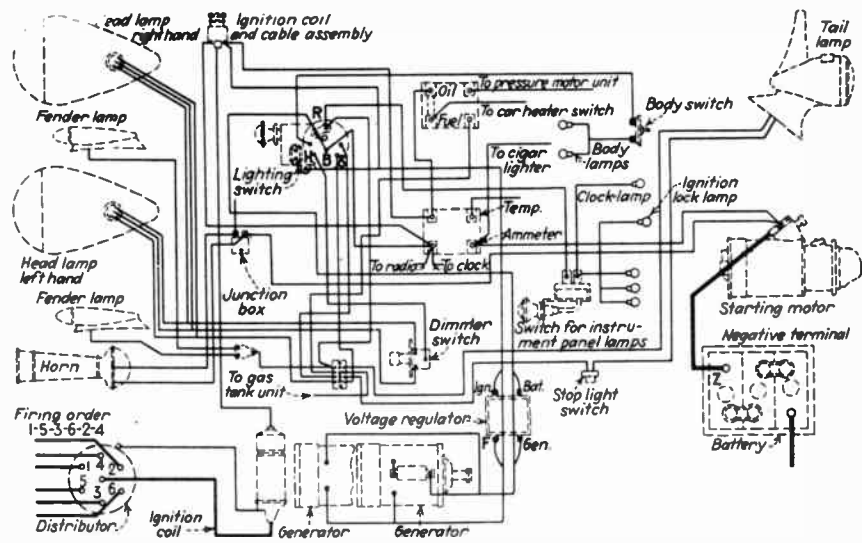

Graham Paige

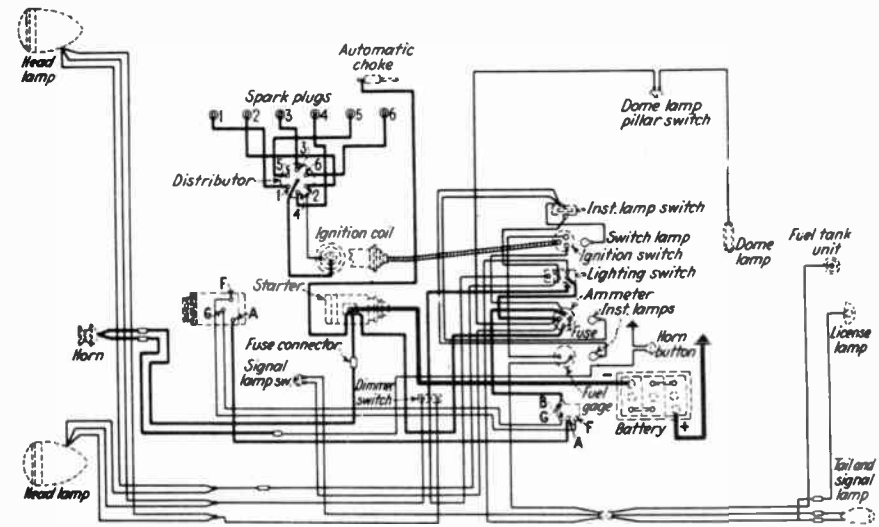

DeSoto

RADIO RETAILING

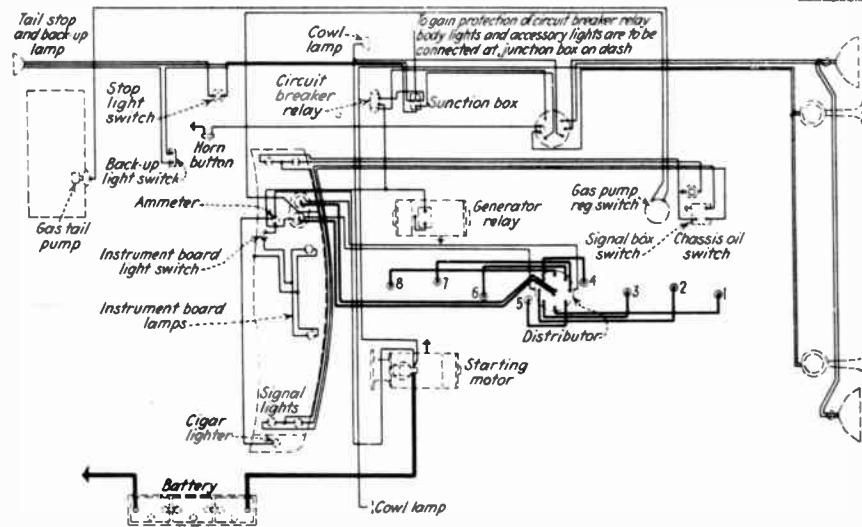

Duesenberg

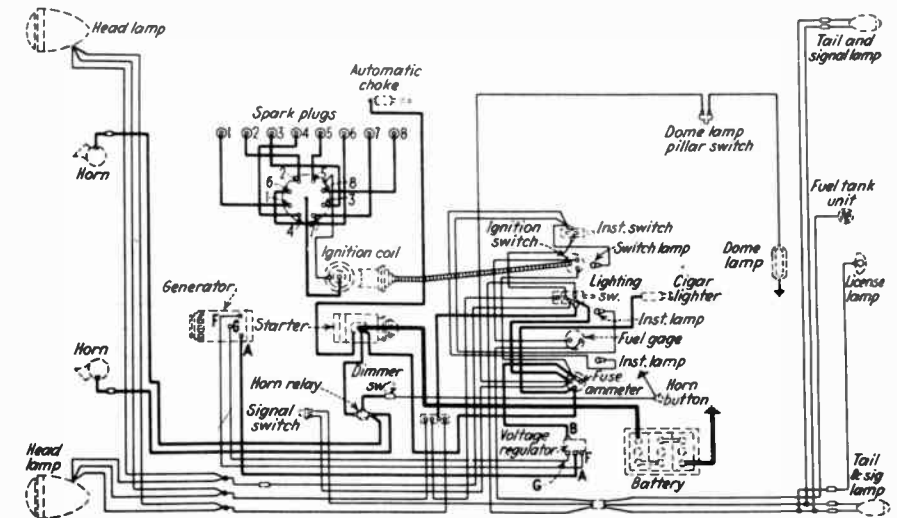

Chrysler Imperial

1937 AUTO IGNITION CIRCUITS

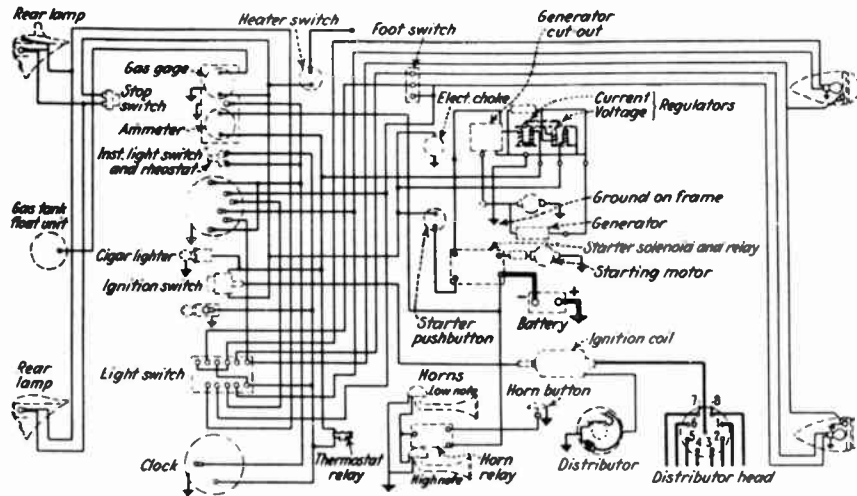

Cadillac LaSalle 37

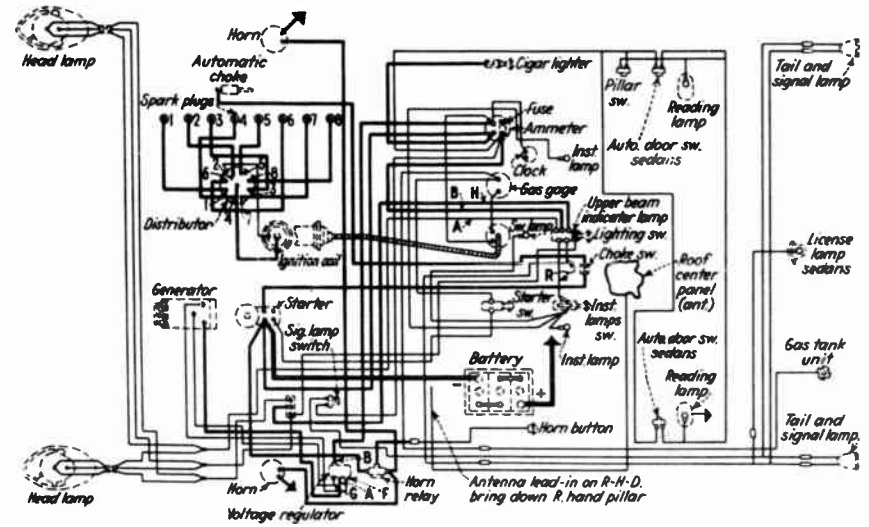

Chrysler Airflow

RADIO RETAILING

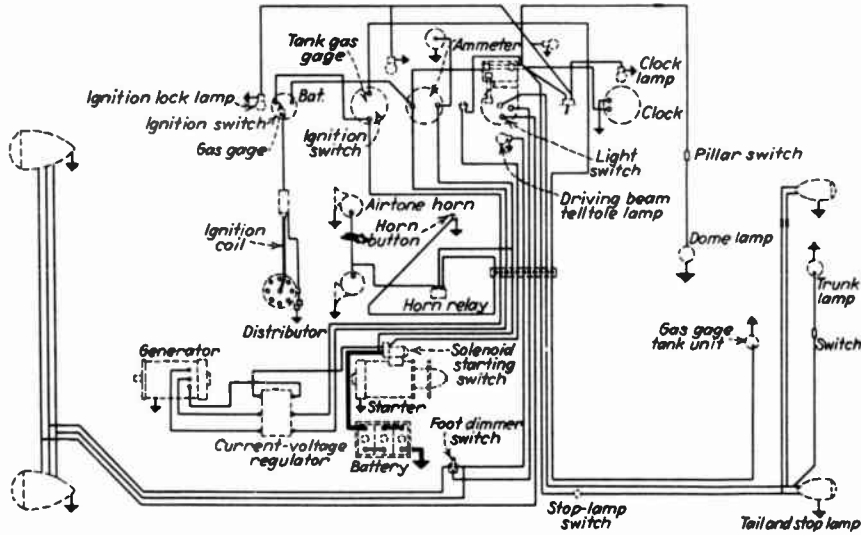

Studebaker 8

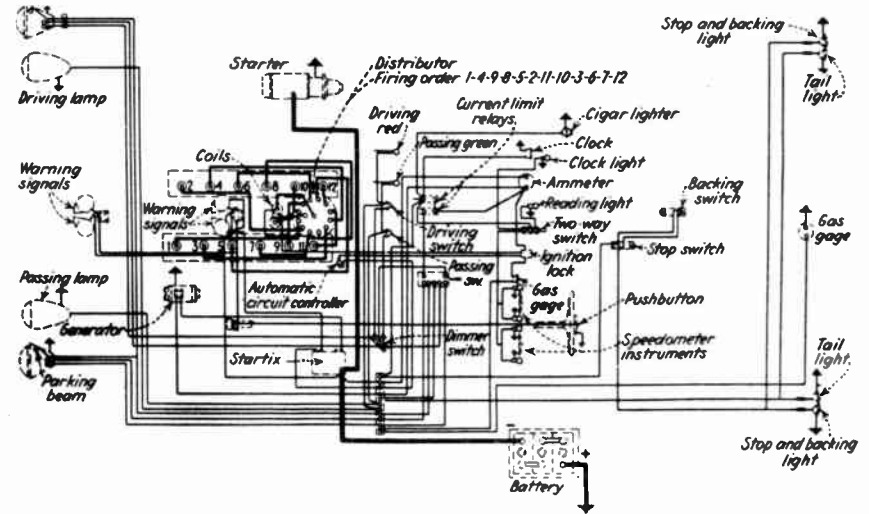

Pierce Arrow 12

HOW MUCH ELECTRICITY?

SMALL AC-DC MIDGET
(4-5 tubes)

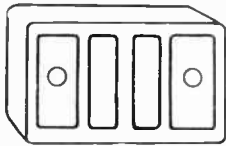

Average drain 55 Watts
Average Cost 2 10-cent per hour

SMALL AC MIDGET
(4-6 tubes)

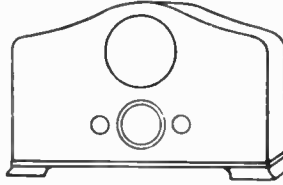

Average drain 65 Watts
Average Cost 3 10-cent per hour

SMALL AC CONSOLE
(5-9 tubes)

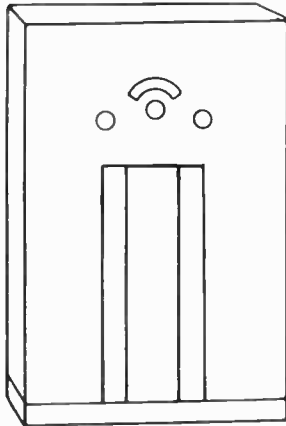

Average drain 95 Watts
Average Cost 5 10-cent per hour

LARGE AC TABLE MODEL
(6-8 tubes)

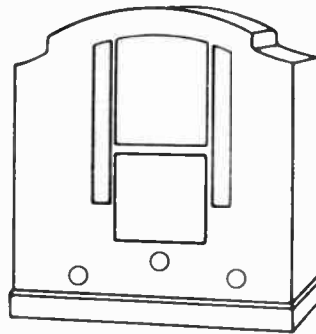

Average drain 85 Watts
Average Cost 4 10-cent per hour

LARGE AC CONSOLE
(9-16 tubes)

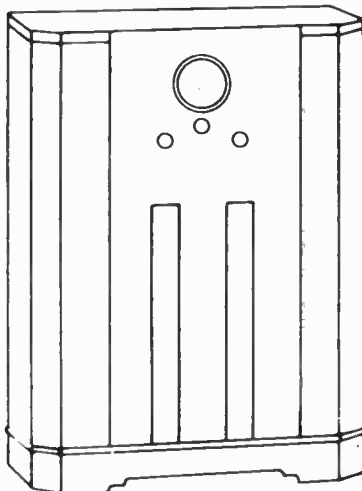

Average drain 115 Watts
Average Cost 6 10-cent per hour

COMPARISON OF APPLIANCES

Appliance	Est. Annual Use (kw. hrs.)	Average Annual Bill
Cleaner	36	\$ 1.91
Clock	18	.95
Heater	50	2.65
Iron	50	2.65
Ironer	125	6.62
Oil Burner	240	12.72
Percolator	50	2.65
RADIO	75	3.97
Range	1750	44.75
Refrigerator	550	22.00
Toaster	50	2.65
Washer	24	1.27
Water Heater	3000	60.00

E. E. I.

SALES AMMUNITION from Radio Retailing

Why GOOD SERVICEMEN CHARGE FOR INSPECTION*

It Often Takes Longer To Find The Trouble In A Radio Than It Does To Fix It

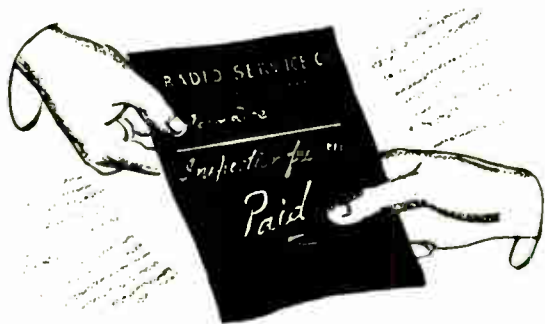
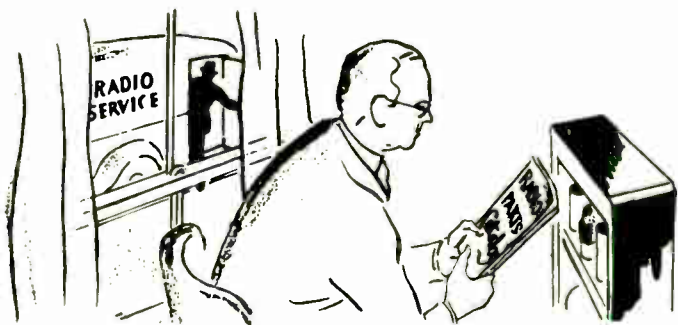
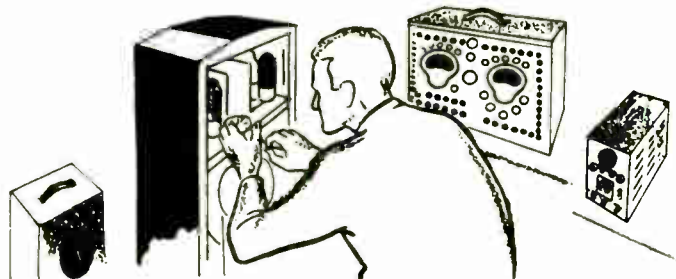

ACCURATE ESTIMATES

Paid for his time and gasoline, the repairman can afford to make a complete, careful circuit-check, rendering a low, accurate estimate rather than one padded to cover possible oversights

NO FORCED SELLING

It is unnecessary for the servicer receiving such a cost-covering fee to rely upon his ability to sell the customer merchandise or work not actually needed in order to make a living

REDUCES REPAIR BILLS

Elimination of "free" diagnosis prevents unscrupulous customers from running up overhead by securing expert advice, using this to obtain repairs elsewhere at cut prices

NO OBLIGATION

If, on receipt of the paid servicer's diagnosis, the customer prefers to postpone repair, he need not feel obligated to the technician as this advice has been paid for

*The inspection fee is cancelled if a charge is made for repairs.

Time is Money to the Technician, Who Cannot Give It Away and Remain in Business

FACTS ABOUT

RAYTHEON

Important Reasons Why Dealers and Servicemen Use and Profit with Raytheon Tubes

- 1. MEETS EXACT STANDARDS OF CHIEF ENGINEERS.** RAYTHEON makes tubes for a majority of licensed set manufacturers! For that reason, RAYTHEON tubes meet not only the exacting standards of more Chief Engineers than any other tube—but they must perform in more diversified circuits than any other tube!
- 2. THE ONLY COMPLETE LINE.** RAYTHEON makes the only Complete Line of tubes for replacement purposes. All the standard Glass, Metal and Octal Base types, plus a full line of Majestic shielded types and resistance tubes! There is a RAYTHEON tube for any replacement.
- 3. PREFERRED ON LAND, SEA, OR AIR.** RAYTHEON tubes are preferred by the commercial air lines and are used in ships, railroad trains, busses, trucks and police cars—where abnormal conditions prevail—because of their dependability and longer life.
- 4. USED IN GOVERNMENT DIVISIONS.** The Navy, the Army, in their aviation divisions and all their other branches are constant users of RAYTHEON tubes. Why? Because RAYTHEON tubes have the quality and the dependability that stand up under the roughest usage.
- 5. FIRST IN AUTO-RADIO USE.** RAYTHEON has led in adapting tubes to auto-radio use. More auto-radio manufacturers use RAYTHEON tubes than any other make, because they give long outstanding performance in close, cramped quarters. One of the most outstanding research developments by RAYTHEON in auto radio has resulted in the OZ4 and OZ4G—filamentless gaseous rectifier—in keeping with the demand for higher output and lower battery drain. The OZ4 and OZ4G are being universally used and adopted in the 1937 and 1938 program of leading auto radio manufacturers.
- 6. PIONEER OF TWO-VOLT BATTERY TUBES.** Over ten years ago, RAYTHEON developed and pioneered the now familiar 2-volt battery-type tube which improved farm radios tremendously! Since then, there has been no outstanding developments in this type of tube until RAYTHEON recently announced the new LOW-DRAIN cathode-type tube which permits AC operation from battery sets without excessive battery drain.
- 7. WORLD'S LEADING MAKERS OF AMATEUR TUBES.** RAYTHEON has constantly led the way with the first important improvements in amateur tubes. The first efficient triode, the first transmitter pentode, and the first zero bias Class B Modulator. Known as "RK" tubes, RAYTHEON Amateur Tubes are used by the world's leading amateurs, University Laboratories and the great broadcasting chains! RAYTHEON does not bring out experimental tubes, but only tubes that are a contribution to Science—designed to help the amateurs' problems.
- 8. NATIONALLY ADVERTISED.** Over \$5,000,000.00 has been spent in the last seven years to make consumers conscious of the fact that RAYTHEON is THE quality tube!
- 9. FREE TECHNICAL ADVICE.** RAYTHEON employs a large staff of leading radio engineers whose sole job is to act as a consulting laboratory for servicemen. This service is absolutely FREE to any dealer or serviceman. They can use it as they like—without charge or obligation!
- 10. NOT SOLD AT "CUT PRICES".** RAYTHEONS are sold exclusively through legitimate jobbers to responsible dealers and servicemen. They sell for standard list prices—not at "cut prices"—giving dealers absolute profit-protection.
- 11. UNIFORM GUARANTEED QUALITY.** To insure uniform quality of raw materials, RAYTHEON employs metallurgists, physicists, chemists and engineers of all kinds to check and re-check every piece of material used in a RAYTHEON tube. Every RAYTHEON jobber will accept any RAYTHEON tube found defective, subject to guarantee. Seldom is this necessary, however, for every RAYTHEON tube is tested 87 times during production, and is pronounced perfect before leaving the RAYTHEON factory. With RAYTHEONS you get "top" quality always.
- 12. POWERFUL DEALER AND SERVICE HELPS.** Free, colorful window display materials, mailing post cards, newspaper mats, repair tickets and other sales helps are available to RAYTHEON dealers. All materials are designed to bring in customers and help step up tube sales. Free folder illustrates all sales helps available.
- 13. EXTRA PROFIT-PROTECTION PLAN.** RAYTHEON offers the finest quality tube made—at cash prices (jobbers' regular terms) that save money for the dealer every time he buys RAYTHEONS, and gives him an extra profit. With RAYTHEON'S fair list prices . . . powerful consumer acceptance . . . a RAYTHEON dealer can sell RAYTHEON tubes at a full profit all the time.
- 14. INCREASING DEMANDS FOR RAYTHEONS.** Because of the unusual demand for RAYTHEON tubes, particularly in the past few years, it has been necessary to build a complete additional factory during 1936—thereby increasing RAYTHEON manufacturing facilities by 35%. This guarantees that even during the months when the demand is at its peak, RAYTHEON orders can always be filled promptly. The dealer who ties up with RAYTHEON, ties up with a leader who is steadily marching forward.
- 15. EFFICIENT PERSONAL SALES COOPERATION.** RAYTHEON has a highly efficient national sales organization, dealing direct and through the jobber, and is in constant touch with important outlets by informing them of all new promotional plans. This vitally important personal contact with the trade is influential in helping increase tube sales and assure a maximum turnover on a RAYTHEON tube investment.

RAYTHEON PRODUCTION CORPORATION

World Radio History

445 Lake Shore Drive, Chicago, Illinois
555 Howard Street, San Francisco, Cal.
420 Lexington Ave., New York, N. Y.
55 Chapel Street, Newton, Mass.
418 Peachtree Street, N. E., Atlanta, Ga.