

1932

MODERN RADIO

EDITED
BY
ROBERT
S.
KRUSE

CONTENTS

	Page
Modulated Tubes without Batteries	3
R. F. Amplifier Tubes	7
1933 C. W. Tuner	8
Radio Olympia	10
Modernizing Amateur Receivers	11
A Traffic Record	14
General Purpose R. F. Choke	15
Accurate High- Range Ohm-meter	18
Allied Art	20
Reviews	22
R. C. A. 48 Tube	24
Quiz-Matics	26
Short Circuits	29

Copyright 1932 by Modern Radio Co. All rights reserved



November

Number 17

20 cents

MODULATION METER

The Radio Research Company Modulation Meter represents a distinct step in advance in the field of instruments for Radio Telephony.

- 1. Measures and indicates **simultaneously** both **positive** and **negative** peaks.
- 2. Modulation is indicated **directly** on **meter**. No dials to work in operation.
- 3. Requires **small input**. Can be used on a **5-watt** or **50,000-watt** circuit with equal accuracy.
- 4. Engineers pronounce it more **accurate** than an **oscillograph** under ordinary conditions.
- 5. Reads as **easily** and **rapidly** as a volt-meter.
- 6. Shows **negative** cut-off as well as positive over-modulation.
- 7. Indicates 1% with the **same accuracy** as 100%.
- 8. "Carrier Balance" obtained **quickly, easily** and **completely**.
- 9. Permits analysis of **all circuits** even on **low level modulation**.
- 10. A typical Radio Research Company Instrument. **Better and Cheaper**.

You will want to know more about this instrument.

SEND FOR ADDITIONAL INFORMATION TO:

RADIO RESEARCH COMPANY, Inc.

1204 Irving Street, N. E.
WASHINGTON, D. C.

Amateur Radio Clubs: Write for our special "Ham" proposition.

The Modulated Tube Without Batteries

In certainly three-quarters of the radiophone transmitters examined in the last two years the customary grid bias battery of the modulated r.f. amplifier has been more or less at fault. Being subjected to a constant reverse current (or charging current) flowing through it from grid to filament, this battery tends to rise in voltage, become erratic, noisy and short-lived.

It is not at all uncommon to find a battery no more than 30 days old producing a bias 30% higher than the voltage

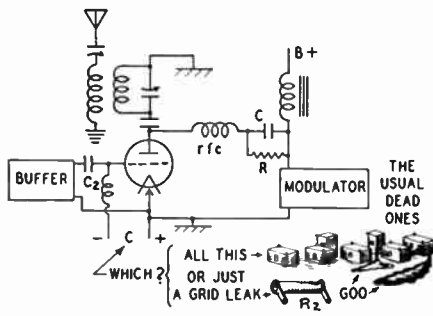

Fig. 1.

rating, even though it looks o.k. and—when the set is shut off—measures nearly right.

One naturally thinks of replacing the battery with a rectifier-filter rig (which is complex, costly and productive of hums), or of borrowing the bias voltage from the B-minus line—which isn't practical because the tube is being modulated and all sorts of weird distortions may follow.

Our Old Friend

At about this point we began to wonder why a simple old-fashioned grid-leak wasn't the answer—and on trying it, we found it was.

As you know, a tube which is to be modulated must be provided with very high r.f. grid input from the buffer-



amplifier (Fig. 2), in order to make sure that there will always be enough carrier to "fill up the envelope" when the plate voltage is swung upward by the voice-frequency input to the plate. This r.f. grid input is supposed to be perfectly

Examples of Bias Battery Misbehavior

The modulated tube was a 203A.

Rated. Bat. Voltage	Measured Bias	Remarks
100	100	New battery, carrier cut off
100	114	Same, carrier on
110	143	60 days old, carrier on
100	jumping 135-180	Bat. 4 mos. old, carrier on
100	blocking	Bat. 8 mos. old, carrier on

steady, therefore the resulting grid current is also steady and can be sent through an appropriate grid leak to manufacture grid bias, the proper value being obtained by changing the resistance of the leak. The adjustment is very uncritical, and about the only un-

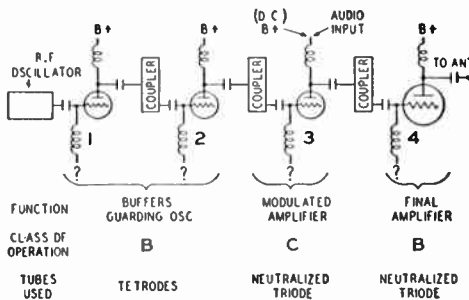

Fig. 2. The grid circuits 1, 2 and 3 have constant r.f. input, therefore may be leak-biased with saving of space, cost and trouble. If there is a final Class B r.f. tube AFTER the modulated tube it is, of course, necessary to use a bias source on grid 4, as its input is not a steady r.f. stream. Most transmitters now being built avoid such stages—see "The Unprofitable Class B r.f. Amplifier", April, "Modern Radio", page 13.

usual requirement is that the r.f. feed (or stopping) condenser between this grid and the buffer tank must be good.

Advantages

The leak bias automatically compensates for line-voltage variations, it backs up the r.f. choke most nobly, it does NOT leak corrosive liquids into the vitals of the transmitter, does not need renewal except in case of accident, and

bias? To answer this, tests were made at three amateur stations, W1BNR, W1FG and W1BTZ, most of the work being done by Mr. L. E. Toth. The three stations were chosen because each had a different line-up. W1BNR uses a Class A prime push-pull pair of 845 tubes to modulate

a 203A by means of a special transformer, all tubes being at the same plate voltage. W1FG uses a pair of Class A 50's to modulate a 210, while W1BTZ uses a 203A modulated by a single 845 with the common resistance-capacity type of coupling, shown in Fig. 1.

In all three stations the fidelity with grid-leak bias was equal to, or better than, that with battery bias on the Class C modulated tube. At W1FG the carrier was materially quieter with leak bias. Since the leak had been put inside the copper can which surrounds the modulated tube it was suspected that the batteries and their leads picked up the noise and (in spite of a filter in the C leads) sent it into the box. Tests showed that absolutely new batteries were quiet but that the noise began when the batteries had been used a short while—or when as little as 25 ohms of resistance was put into a C lead—showing that

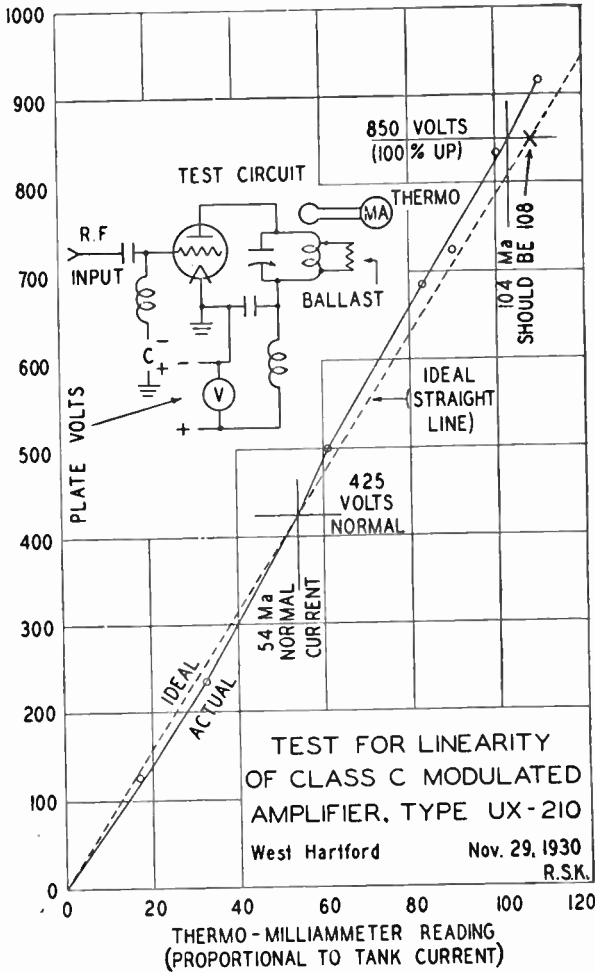

Fig. 3. When this tube was leak-biased the curve was between the "Actual" (battery bias) and "Ideal" (theoretical) curve—in other words it was better than with battery bias.

finally, it puts somewhat more load on the final buffer tube and assists most pleasantly in stabilizing that tube.

Making Sure

The question of course comes up—where's the joker? Does the stage MODULATE as well as with battery

increased battery resistance had something to do with it. The C line, by the way, had both an r.f. and an audio filter.

At W1BNR a curious "echo" disappeared from the voice when the leak was installed, and the buffer (210)

Operation of Class C Modulated R.F. Amplifiers Using Grid Leak Bias

Class C Tube	Type of Coupling	Power Supply Volts	Carrier Watts (Note 1)	% Mod.	Class C Plate Volts	Class C Ma. (Note 2)	Grid Leak (Note 3)	Drop Resistor	Coupling Transformer	Modulator Tube	Mod. Plate Volts	Mod. Plate Ma.
'10	(R-C)	500	7-8	90	300	40	20,000	5,000	None	50(A)	500	50
"	(Trans.)	425	14-16	100	425	50	15,000	None	Note 4	2-UX ⁵⁰ (A)	425	2 X 50
"	"	"	17-19	90	"	60	"	"	Note 4	"	"	"
"	"	350	9-11	100	350	45	"	"	Note 5	2-45 (A Prime)	350	35 (V)
2 X 210 (P. P.)	"	425	24-28	100	425	2 X 50	7,500	"	Note 6	2-46 (B)	425	(X)
"	"	500	30-35	100	500	2 X 50	"	"	Note 7	2-50 (A Prime)	500	50 (V)
"	"	"	30-35	100	"	"	"	"	Note 8	2-10 (B)	500	(X)
203A	(RC)	1,000	25-30	100	600	67	25,000	9,000	None	1-845 (A)	1,000	75
"	"	"	30-36	"	"	80	15,000	7,500	"	"	"	"
"	"	1,250	36-42	100	700	86	"	6,500	"	"	1,250	65
"	"	"	42-50	90	800	90	20,000	5,000	"	"	1,250	"
"	"	1,000	48-56	100	800	100	10,000	2,000	"	2-845 (Par.)	1,000	2 X 75
"	"	1,000	56-67	90	800	120	5,000	1,500	"	"	1,000	2 X 75
"	"	1,250	96-112	97	900	140	3,500	2,500	"	"	1,250	2 X 65
"	(Trans.)	1,000	200	100	1,000	2 X 150	3,000	None	Note 9	2-203A (B)	1,000	(X)
"	"	1,000	100	100	1,000	150	3,500	None	Note 10	2-845 (A Prime)	1,000	2 X 70 (V)

(A) Operating Class A, see DeForest or R. C. A. leaflets for operation.

(A Prime) Operating Class A Prime. See "Modern Radio" "Class A Prime Audio", page 6, August, 1932, also "Modern Radio", July, 1932, page 18.

(B) Operating Class B. For 46 tube see "Modern Radio Serviceman's Pocketbook", page 4. For '10 see "Modern Radio" for May, page 12. For 203A see Note 6.

(R-C) This is the bypassed drop-resistor method of coupling, sometimes still used.

(Trans.) Audio-frequency transformer whose secondary is in the Class C plate supply line (or it may be used to shunt-feed this tube), while the primary is in the modulator plate circuit—or circuits.

(V) The plate current of a Class A Prime tube rises on large audio swings but not enough to require separate plate supply.

(X) Varies widely. Separate plate supply needed to prevent interaction with other stages.

Note 1. Depends on plate circuit efficiency. Values shown are for 60% and 70%.

Note 2. Correct Class C plate current is obtained by adjusting coupling of tank circuit to antenna. Where the modulated tube is used to feed a final r.f. amplifier, move the grid clip on the Class C tank, or provide an adjustable load resistor across the tank.

Note 3. Use value given or next convenient higher value, provided increase is not over 50%.

List of suitable transformers. If any difficulty is met in obtaining any of these, "Modern Radio" will advise or forward orders.

Note 4. Thordarson type T-2880, Silver-Marshall 231, Sangamo CX-171 or Pilot 430, used as in Fig. 4.

Note 5. Silver-Marshall special. See Fig. 4.

Note 6. National type Class B 210 size may be used for 46's. Connections essentially as in Fig 5. Socket connections for 46 tubes as given on page 4 of "Modern Radio Serviceman's Pocketbook" under "46 Class B Triode".

Note 7. Silver-Marshall type 10287 used as on page 6, "Modern Radio" for August, 1932. Class C amplifier may be either 203A as shown there or p.p. pair of '10 tubes as now suggested. In either case adjust load so total Class C plate current will be 100 Ma. at 500 volts or 80 Ma. at 600 volts. Also see Fig. 4.

Note 8. National type B0 as in Fig. 5.

Note 9. R. C. A.-Victor Class B modulation transformer.

Note 10. Toth special Class A Prime transformer. Toth Radio Service, Unionville, Connecticut. General nature of circuit as in Fig. 4.

"Modern Radio Serviceman's Pocketbook" or any of the issues referred to are available at usual price.

neutralization became less critical.

Since listening tests are inexact, and the familiar "22% rise" rule is most misleading when used with voice, we ran "static" linearity curves on some of the modulated tubes—that is, we varied the d.c. voltage on the modulated tube

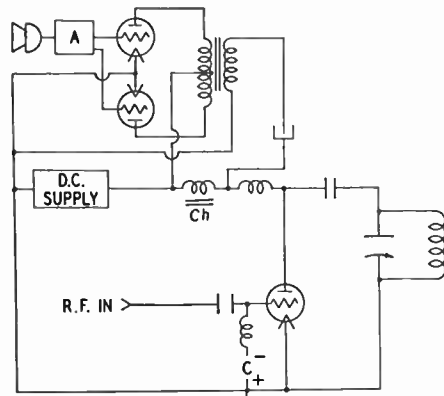

Fig. 4. The Howard Fast circuit arrangement for push-pull Class A or Class A prime modulation transformers feeding Class C plate circuits. This applies to transformers listed in the table under notes 4, 5, 7 and 10. The iron-core choke must show 30 Hy. or better, the condenser in series with the transformer secondary should be 4 mikes min. and the stopping condenser between Class C plate and tuned tank should not exceed .001 ufd.

to find out if the carrier varied in proportion, as it should. In Fig. 3 is shown

shown at all, because it lay BETWEEN the two curves shown. This means that it was better than the curve shown, and almost as good as the dashed line—which is pretty good in any sort of company.

"Dynamic" Tests

There is, of course, some question about such a test. It is possible for a set to give a good static curve (though hardly as good as this one) and still be wrong when audio voltages are fed to the Class C plate from the modulator. To make a long story short—both 60 cycle and 1,000 cycle tests showed this fear to be ungrounded.

Adjustments

Correct bias voltage on a Class C tube does not result in correct plate current until the r.f. grid input and the plate load (coupling to the antenna) have been adjusted correctly. This statement holds with either battery or leak bias. With battery bias excessive plate current calls for LESS antenna coupling, MORE bias, or LESS r.f. input. In the case of leak bias the adjustment of r.f. input is not at all fussy and the adjustment of plate current is made largely by changing the antenna coupling. It is of course necessary to use the right gridleak, as shown in the table.

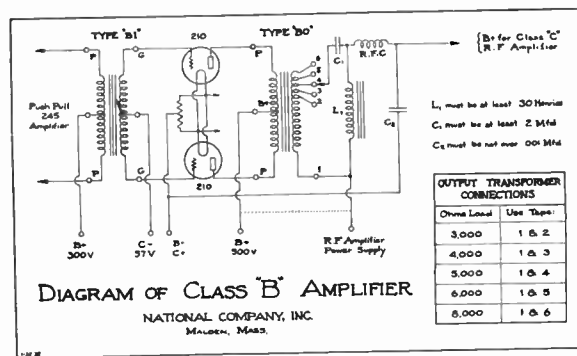

Fig. 5. Circuit for note 8, to be modified as to voltages when used for note 6. The dotted connection MAY be used but a separate B supply for the modulators is strongly recommended.

(solid line) the curve taken on the W1FG Class C tube when using battery bias. The dashed line is a "perfect" or "ideal" curve—which is to say a straight line. Now our gridleak curve is not

Precautions

It is assumed that the buffers are decently neutralized, that the B supply is really able to keep up its voltage

(Please turn to Page 17)

R. F. AMPLIFIERS

(FOR LEAK OR BIAS DETECTION WITH THESE TUBES SEE PAGE 5 OF MODERN RADIO SERVICEMAN'S POCKETBOOK)

TYPE	222 Tetrode	224 and 24A Tetrode	232 Tetrode	234 R. F. Pentode	235 Vari.-Mu R. F.	236 S. G. Tetrode	239 Vari.-Mu. R. F. Pent.	44 Vari.-Mu. Pentode	551* Vari.-Mu. R. F.	55* Diode Triode	57 Special Pentode	58 Vari.-Mu. Pentode	85* Diode Triode
Bulb.....	S-14	S-14	S-14	S-14	S-14	S-14	S-12	ST-12	S-14	ST-12	ST-12	ST-12	ST-12
Base.....	4 Pin	5 Pin	4 Pin	4 Pin	5 Pin	5 Pin	5 Pin	6 Pin	5 Pin	6 Pin	6 Pin	6 Pin	6 Pin
Pin No. 1.....	Screen	Screen	Screen	Screen	Screen	Screen	Screen	Screen	Screen	Plate A	Screen	←	Plate A
* No. 2.....	Plate	Plate	Plate	Plate	Plate	Plate	Plate	Plate	Plate	Plate	Plate	←	Plate
* No. 3.....	F +	F + or -	F +	F +	F + or -	F + or -	F + or -	F + or -	F + or -	F + or -	F + or -	←	F + or -
* No. 4.....	F -	"	F -	F -	"	"	"	"	F	"	"	←	"
* No. 5.....	None	Cathode	None	None	Cathode	Cathode	Cathode	Cathode	Cathode	Cathode	Cathode	←	Cathode
* No. 6.....	None	None	None	None	None	None	None	Suppressor	None	Plate B	Suppressor	←	Plate B
Cap.....	Grid	Grid	Grid	Grid	Grid	Grid	Grid	Grid	Grid	Grid	Grid	←	Grid
Filament V.....	3.3	2.5	2.0	2.0	2.5	6.3	6.3	6.3	2.5	2.5	2.5	←	6.3
Filament A.....	0.132	1.75	0.06	0.06	1.75	0.30	0.30	0.30	1.75	1.0	1.0	←	0.30
Grid Bias.....	- 1.5	- 3	- 3	- 3 Up	- 3 Up	- 3	- 3 Up	- 3 Up	- 3 Up	- 20	- 3	- 3 Up	- 20
Mu.....	290	615	580	Down	370	370	Down	Down	370	8.3	1,500	Down	8.3
Plate Res.....	600,000	600,000	1,150,000	1,000,000	350,000	350,000	750,000 Up	605,000 Up	350,000	8,000	1,500,000 Up	800,000	8,300
Mutual Cond.....	480	1,025	505	Down	620*	1050†	1,000	1,050	1,050	900	1,225	1,600‡	1,000
Plate V.....	135	250	135	180	250	180	Down	Down	Down	250	250	Down	250
Plate Mils.....	3.3	4	1.4	2.8	2.5	3.1	180	250	250	8	2	3 Max.	7
Screen Volts.....	67.5	90	67.5	67.5	90	90	90	65 Max.	2.5	100	100

* Drops to 15 if bias is raised to - 22.5 volts.

† " " 15 " " " " - 50 "

‡ " " 10 " " " " - 40 "

§ See detector table for operation. (page 5)

|| " " chart. (page 5)

(This material is from the "Modern Radio Serviceman's Pocketbook". All rights reserved.)

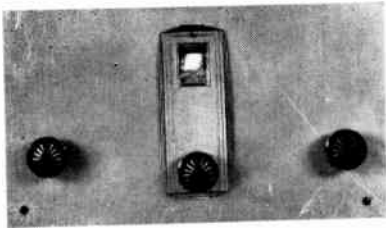

The 1933 C. W. Receiver

Simple, Selective, free from Local Interference

By Frank C. Jones*

The writer likes to work a shortwave transmitter but in the past often gave up in despair because of interference, key clicks and strong-signal detector blocking. The present receiver entirely changes the story—even in the early evening, reception is a pleasure.

Having studied the reduction of cross-talk while designing broadcast receivers, the idea presented itself of using some of the same principles in a shortwave code receiver. The comparison is not far-fetched. The ordinary shortwave c.w.

responds to it we will, of course, use some audio selectivity.

Now with this direct comparison possible, let us see what is done in a broadcast receiver to prevent cross-talk and other first-detector distortion.

1. The first detector is of the bias type, the bias being high enough so that the signal voltage, plus the oscillator voltage will not be enough to cause grid current.
2. The oscillator r.f. voltage is always made larger than any signal voltage.

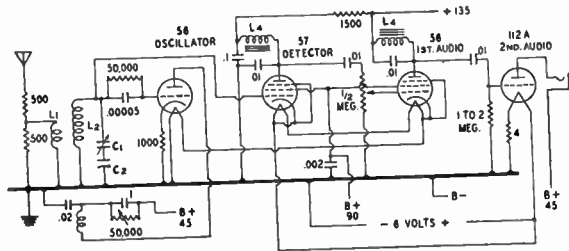

Fig. 1. The Special Heterodyne Circuit.
 L₁, L₂, L₃—Windings of plug-in coil, see Fig. 3.
 L₄—Iron core coil tuned to 800 cycles.
 C₁—50 ufd. band-spreading condenser.
 C₂—100 ufd. tuning condenser.
 (The band-spreading feature may be omitted or obtained in any of the usual ways.)

receiver consists of an oscillating detector and audio amplifier (with perhaps an r.f. amplifier). The detector action resembles that in the broadcast super-heterodyne because in both the signal is heterodyned to a lower frequency. This frequency is around 800 cycles in the c. w. receiver and the audio amplifier may be compared to the i.f. amplifier in the broadcast set, but since 800 cycles can be heard directly there is no need of a second detector as is the case for the b.c. receiver with its 175,000 cycle (175 kc.) amplifier. Most of the selectivity of the broadcast "super" lies in the i.f. system and since our audio system cor-

In a short wave receiver on the contrary the detector itself is WEAKLY oscillating and a strong signal or static, or key thump causes it either to stop oscillating or else tends to pull it into the signal frequency whereupon the beatnote disappears.

Why not avoid these difficulties by using a bias (or plate circuit) detector and a separate oscillator in a short wave receiver? This method functions well in a broadcast receiver and excellently in a c.w. short wave receiver. The sensitivity is less but this can be made up easily because a grid leak detector is similar to a plate circuit detector plus a poor audio amplifier stage, so a little additional audio amplification makes the

* 1152 Grizzly Peak Boulevard, Berkeley, Calif.

plate or bias detector equal in sensitivity to the grid leak detector. Having separated detection from oscillation we may now allow the oscillator to oscillate strongly, which is to say, stably.

This means (1) no pulling in on strong signals and (2) since a bias detector is used, key clicks, etc., are nearly absent. (3) The antenna can be coupled into the oscillating circuit and the latter used to select the desired signal for the detector, hence no additional tuned circuits are necessary and (4) the bias detector does not load the oscillator circuit enough to cause any difficulty in maintaining oscillation on any of the desired amateur bands.

The Circuit

The circuit shown in Fig. 1 is one that the writer uses as it required little effort to convert the old receiver into the new

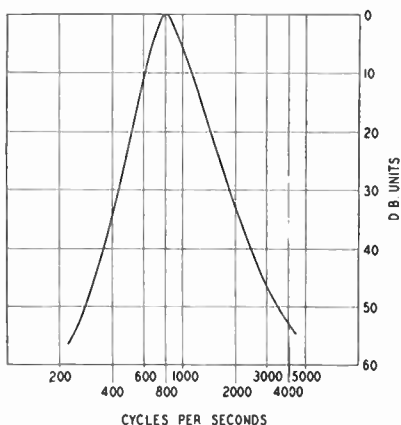

Fig. 2.

one. Audio and detector bias voltages could have been obtained by cathode bias resistors, bypassed, of course. The scheme shown in Fig. 1 eliminates these by proper connection to the filament circuits. There is 1-volt negative bias on the second audio, 2 volts on the first audio and 6 volts on the detector. Probably a.c. could be used on the heaters if separate resistors and bypasses were used, though the audio amplification is extremely high and stray a.c. fields are bothersome. In my receiver it was necessary to inclose the oscillator, detector, and first audio circuits in one large aluminum shielding can to prevent signal and stray a.c. hum pick-up.

Adapting Present Receivers

Nearly any short wave receiver can be converted to a separate oscillator and bias detector, the latter being biased

from 4 to 6 volts negative with respect to filament or cathode. The oscillator circuit shown is very stable with respect to frequency due to the use of a grid leak and condenser and also a cathode resistor. The latter, NOT bypassed, is common to the grid and plate circuits and so acts as a stabilizer. A receiver with a good stable oscillator makes nearly all signals sound like "crystal control", and is certainly a revelation to the listener.

Measurements with a v.t. voltmeter while experimenting with the plug-in coils, indicated that a value of 4 volts of oscillating voltage was desirable to use when the detector was biased 6 volts. This gave fine results in eliminating interference of all kinds. A 4-volt detector bias and 2 volts from the oscillator gave a little more gain but was not as free from interference. The variable resistance in the oscillator plate supply was not necessary for normal use but shows up the ill effect of too little or too

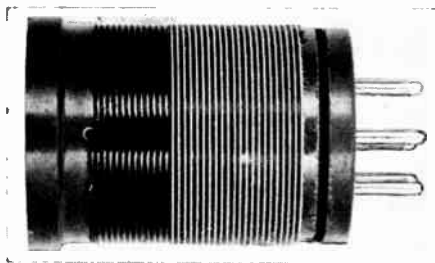

Fig. 3. The familiar 6-prong National plug-in coil may be used in the circuit with the lower "slot" winding serving as L_{01} , the heavy winding as usual being the tuned winding L_{22} and the fine-wire winding interwound with L_{22} serving L_{11} .

much oscillator output voltage. The oscillator circuit and coils were such that the r.f. voltage was nearly constant at 4 volts over all ranges.

A screen grid r.f. amplifier either tuned or untuned should be used to prevent radiation, though a resistance pad, such as shown in Fig. 1, functions well. Isolation also prevents signal variation from oscillator frequency change due to a swinging antenna in windy localities.

In Fig. 1 it will be noted that the first audio amplifier input and output circuits are both tuned to 800 cycles in order to

(Please turn to Page 28)

RADIO OLYMPIA 1932

By W. F. Cotter*

The leading radio show of the English industry, just concluded at Olympia Hall in London, was highly successful, judging from the size of the exhibition, the large public attendance, and the trade enthusiasm following. While published reports reaching this country to date are not complete, they serve to point out the new technical developments and to indicate how closely they parallel our developments.

The feature of last season's exhibition was the general changeover to a single control station selector, the radio set including two or three multi-tuned radio frequency stages employing the screen-grid tube. The power pentode, with indirectly-heated cathode, was usually used as an output tube.

This year indicates the same type of receiver brought to a greater degree of refinement, and employing the recently introduced, variable μ , screen-grid tube. One observes with much interest, however, the re-introduction of the super-heterodyne, brought up-to-date, with single station selector, variable μ tubes in the high frequency sections, and adequate selectivity against images and other forms of interference common to poorly designed super-heterodynes. Inasmuch as two bands of wavelengths must be provided for—1500 to 550 kc. and 350 to 150 kc.—the intermediate frequency for super-heterodynes is usually located between 110 kc. and 135 kc.

The stenode, an English development, is displayed by only two firms. The sets take the form of highly-selective super-heterodynes, with audio-frequency correction introduced to compensate for side-band (!?) attenuation.

As seems usual practice, tone control is now in the hands of the advanced experimenter who "rolls his own", and has found no general application in manufactured sets. There may be some explanation for this, however, in that sets must have a minimum of three controls,

namely, station selector, wave-band selector, and volume control. Hence the reluctance to add a fourth control.

One prominent firm displays a T.R.F. set in which efforts have been made to obtain ultra efficiency. Models are provided with three tuned circuits and four tuned circuits, the dynamic resistance of the individual circuits being given as 500,000 ohms. Making a rough approximation of the circuit constants, one arrives at a Q of 500, which represents, indeed, a highly efficient circuit.

No startling innovations are to be noted in an inspection of the variety of vacuum tubes offered. The variable μ tube is seen in types for a.c., d.c., and battery use. The d.c. type for direct connection to the mains, employs a heater consuming one-tenth ampere at twenty volts. For use in battery sets, a tube is offered which operates nominally at 100 volts plate, 70 volts screen, and zero volts bias on the control grid.

The price at which radio sets are offered will be of interest. They are given converted into dollars, computing the English pound at par, since this approximates the position of the purchaser. Also, it must be borne in mind that sets are necessarily more elaborate due to the need of provision for reception on two wave bands, and the connection for the inevitable phonograph pick-up. A four to five-tube T.R.F. set of the table type, including a dynamic speaker, will list between \$50 and \$75. A six or seven-tube super-heterodyne will list between \$100 and \$130. An elaborate eight-tube super-heterodyne in a console type cabinet may be had for \$150. A complete radio phonograph, including record-changing mechanism, is priced between \$250 and \$450.

Mr. Cotter's next article will deal with the "Great German Radio Fair."

The fellow who used to go around pulling wool over people's eyes wants it back: This may be a cold winter.

* Radio Engineer, United American Bosch Corporation.

? ? ? ? ?

03-10-11-24-27-30-31-32-33-34-35-
36-37-38-39-41-42-44-45-46-47-48-
49-50-51-52-53-55-56-57-58-59-60-
61-64-65-66-69-69B-80-81-82-83-85-
?*-#;-??-Mu-Gm-\$\$-Ma.-% Mod.-6
pin-A prime-but mainly ??????



Bringing the Amateur Receiver and Transmitter Up to Date*

By Robert S. Kruse

The amateur receiver and transmitter can be most easily and amazingly improved by using the new tubes—and in many cases cash and power are saved.

Clearing the Air

Such a fog of senseless tube numbers has blown up that we must first line the things up and let a little light come through. This is the easiest to do if we talk about the receiver first—then the transmitter.

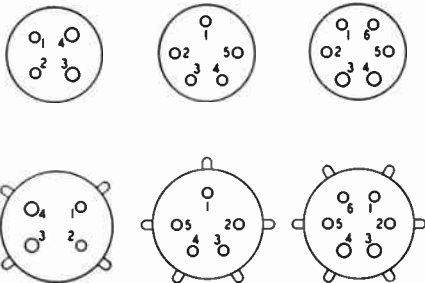

Fig. 1. The New Standard method of numbering base pins and socket prongs.

For amateur reception we can ignore one or two regiments of the new fellows and pay attention to:

1. Variable-mu screen-grid (tetrode) tubes.
2. Variable-mu r.f. pentodes.
3. Special detectors.

* Abstracted from a paper read before the 1932 Amateur Radio Convention at Topeka, Kansas.

Try to keep your eye on this classification and don't be worried by swarms of filament voltages—and 5, 6, 7, or 9 pin bases. You KNOW what kind of filaments you want—and the base business isn't important. A 6-pin has just one extra prong; you solder No. 5 and No. 6 together (see Figure 1) and it's almost as good as a 5-pin base. A 7-pin base is a nightmare in which the top cap has crawled underneath and turned into a central pin! Any other doubts will be cleared up by pages 3, 4 and 7 of the "Modern Radio Serviceman's Pocket Book" or any other complete tube table.

Snapshot Review

As you know, the variable-mu tube was designed to be a non-overloading r.f. amplifier—in other words, to be worthless as a detector. None the less it makes the very best detector we have IF used as in the following paragraphs; it is quieter, gives smoother regeneration, and is less fussy in a super. By all means use a variable-mu tetrode (screen-grid tube) or pentode for GRID-LEAK DETECTION (especially regenerative or oscillating) and in the FIRST detector socket of supers.

The r.f. pentode differs from the screen-grid tetrode in having a lower

plate resistance while retaining the same high "mu". Therefore, it will provide a little more amplification and demand more plate current in about the same proportion. Usually both are about double that gotten for the equivalent screen-grid tetrode.

Both tetrodes and pentodes are recommended in the variable-mu form because they are quieter, and there's less cross-modulation and other overloading.

Triode Detectors—Gridleak Type

Gridleak triode detectors (except second detectors of "supers") should be

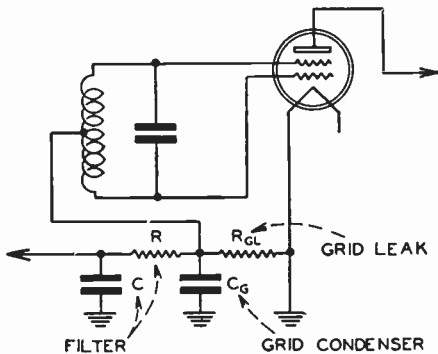

Fig. 2. Using the Wunderlich tube as an A. V. C. source. The rectified carrier produces both audio and d.c. voltages across R_{GL} . The d.c. voltage is proportional to the carrier and therefore useful as an A. V. C. control bias when filtered and sent back to the r.f. grids—left arrow. The audio voltage across R_{GL} of course causes the two grids in parallel to modulate the d.c. plate current and we have an audio amplifier—output through the right arrow.

replaced by a variable-mu r.f. pentode, of which the 58 (2½-volt filament type) and the 39 (6-volt a.c. or d.c. filament) are to be preferred while in the 2-volt types one must go to the 34. If the old detector was meant to oscillate, reduce tickler turns, fix the by-pass and plate voltage, and then control regeneration by means of a variable screen voltage. This may be taken from the slider of a potentiometer connected from B minus to plus 90 in the usual way, the screen being by-passed to chassis, or not, as one prefers. It it's a battery set, provide a switch to cut off the pot when not receiving. For c.w. reception leave the old audio coupling alone, the mis-matching of impedances serves to drop out low-pitched noises. By the way—Philco's 44 will serve as well as the 39.

Page Twelve

Bias Triode Detectors

Bias-type triode detectors—for some insane reason mis-named "power detectors"—are generally found in the second detector socket of a "super". Leave them alone! If you love trouble we can't stop you.

Gridleak Screen-Grid Detectors

Screen-grid detectors of the leak variety can be changed as follows:

222 or 322, replace by 232 with 70 ohm series filament resistor to reduce microphonic effect. Better yet, use the 234 the same way. If 6-volt supply available use the 239 without filament R.

24 or 24A, replace by 51 or 35 without circuit change. Less noise.

36 (6-volt 24), replace by 39—less noise.

NOTE—The 39 has—Allah be praised—a 5-pin base and hence requires no scissoring or tailoring of the set. If one does not mind changing a number of things the 6-pin 58, 2½-volt r.f. pentode is still best for any of these replacements. Incidentally, Philco's 44 requires the base-bonding trick mentioned before when used to replace a 36. Sometimes it is handiest to use the 5-pin, 6-volt 39 and to add to the set's transformer an extra filament winding to drive it, grounding one side of it to stop hum.

Disobeying the Rules

In the first-detector or "mixer" position of a shortwave superheterodyne or converter the variable-mu tubes, notably the 58, show up to best advantage. Excessive oscillator input does not cause

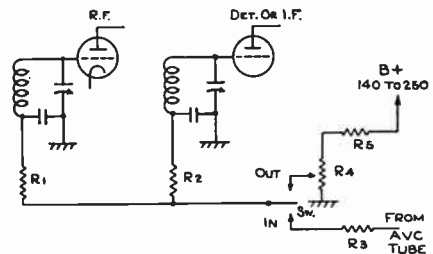

Fig. 3.

the usual high noise level. Do not run the tube in accordance with the instruction sheet, but keep the screen voltage down. For instance one normal set of voltages for the 58 is 250 plate and 100 screen. For the best weak-signal effect

use instead 250 and 35 or 180 and 25. Similarly run the 39 tube at 180 and 35 instead of its rated 180 and 90.

The 58 at home,
or is it
a 57
or possibly
a 44?



Variable-Mu Tetrodes

So far we have by-passed the 551 and 235 variable-mu screen grid tetrodes—and we shouldn't, they are just as fine in an amateur receiver as in a broadcast receiver—always remembering to make sure that their larger plate current hasn't upset things in a set meant for 24 tubes. If there are no resistors in the plate current path—USE the 551 and 35. However, see the later remarks on volume control when we get to them.

Oscillators

If there is equipment for making such measurements, it is an excellent idea to so adjust the oscillator (first one) of a "super" as to make the r.f. peak voltage in the first detector grid just a bit less than the d.c. bias. If you prefer lots of controls, make this adjustable and change it to suit the signal as it comes in. If there's much amplification ahead of the first detector then the "weak signal" rules of the last paragraph are off and normal screen voltage is to be used.

R.F. Amplifiers

In an r.f. amplifier—or an i.f. amplifier—variable-mu tubes should by all means be used. Mostly they can be plugged in with little change, except perhaps socket-jumpers as explained before—or in the volume control as explained later—and an amateur receiver without a volume control is a back number of the worst sort. That goes for c.w. sets, too.

Old Tube	Suggested Replacement
21 or 24A	35 or 51 (better 39 or 58)
32	34
36	39
57	58

Automatic Volume Control

One might think of automatic volume control as highly desirable for fading shortwave signals—and so it would be if one heard but one signal at a time, as in broadcast reception. However, the catch is that the STRONGEST signal that breaks through is the one that controls volume in an automatic system, hence a strong INTERFERING signal will push down a moderate DESIRED signal, merely increasing the difficulties of reception. With amateur phones overlapping like shingles on a roof, one can't tune out anything without tuning out most of the sidebands of the next station—and selectivity becomes rather helpless. Thus a.v.c. (pet name for automatic volume control) is a bit hopeless and one had best build it in the cheapest way and then be ready to switch it out. About the simplest form is that of the Wunderlich tube, (Figure 2) where the grid-leak voltage is used for a.v.c. This voltage varies with the incoming carrier can be used as a self-adjusting volume-control bias on the r.f. or i.f. tubes in the general manner of Figure 3, assuming the switch to be in the down or "in" position, whereupon the gridleak voltage shown in Figures 2 and 3 flows through the filter resistor R3—if one can talk about the flowing of a voltage—and the decoupling resistors R1 and R2 to the grids to be controlled. The varying carrier is thus sent back as a varying bias to the r.f. tubes whose amplification is thereby raised and lowered as needed. Those of you who have been reading "Modern Radio" will recognize this as a much-condensed version of Mr. Hatry's explanation—and remembering his articles will see why I hesitate to try to explain the details in a paragraph. However, with patience it can be done in any receiver—but I recommend for reasons just given, that there be added the switch of Figure 3 and the alternative hand volume control R4 and R5. There are, of course, many other possible switch schemes.

(To be Continued)

Page Thirteen



THE SUNFLOWER STATE CLAIMS A WORLD'S RECORD



Through Kansas summer static, and in weather ranging up to 120 degrees, one amateur-operated station working at 80 meters in 28 days handled more than 6,200 messages totaling over 90,000 words.

Every message sent was originated and every message received was delivered.

Routine message-traffic reports are pretty dry reading for those not in the group that put them through—but when someone does a really new thing, calculated to help amateur radio along, then "Modern Radio" desires to whoop. W6USA did such things at the Olympic games, not only in handling messages but in doing the thing with just that touch of style which made the big international camp respect the station and the men who ran it. Fine! We only regret that we didn't know about that feat in time to tell the story first.

This is another story. We tell it as it was told to us by Special Assistant Adjutant General W. F. McFarland.

The Job

"If you had to design a transmitter and receiver and choose a frequency that would CERTAINLY get and keep communication with a number of points within 200 miles of your station and to be CERTAINLY able to exchange messages, thousands of them, EVERY DAY and EVERY HOUR OF THE DAY, what data have you to refer to? To make the problem more difficult suppose this communication had to be maintained during the ENTIRE MONTH of August. This is the problem that had to be solved to make possible the radio telegraphic communication between the National Guard station at Camp Whiteside, Fort Riley, Kansas and eighteen cities within the state of Kansas, during the period

July 21 to August 28, 1932, inclusive. During that period a total of 6,256 messages were sent and received by this station—that is 3,948 sent and 2,308 received. Claim is hereby made of a world record. One amateur radio station actually handling 6,256 messages in 28 days! Furthermore these messages averaged a text of over 15 words each.

The transmitter at the camp was a "glorified" push-pull, with tuned-plate-tuned-grid circuit, using two fifty watt-ers with 1,000 volts on the plates. Nothing unusual. However the antenna was unusual for amateur transmission. It was 396 feet long not counting the 75-foot double wire feeders.

THE RECORD

Daily Schedules were kept with these stations from July 31 to August 28, inclusive.

W9GWN, R. C. Livingston, Great Bend.....	47
W9EVM, T. C. Dawson, Emporia.....	91
W9AGL, C. R. Armour, Fort Scott.....	68
W9GKJ, H. H. Hess, Fort Scott.....	235
W9FRC, W. A. Beasley, Topeka.....	428
W9DVQ, W. J. Fisher, Arkansas City.....	345
W9PB, Harry Legler, Hiawatha.....	402
W9DEB, Frank Tiffany, Topeka.....	256
W9BYM, C. C. Coffelt, Askanas City.....	113
W9ABW, A. H. Rose, Jr., Hutchinson.....	95
W9FLG, O. J. Spetter, Topeka.....	721
W9KG, E. Crockett, Jr., Kansas City.....	226
W9BSK, F. R. Davis, Hutchinson.....	30
W9EIB, Walter Klassen, Kansas City.....	375
W9IGQ, Wilhelm Wesenick, Jr., Humboldt.....	58
Dean Rounsavelt, Humboldt.....	1
W9EYY, H. L. Richardson, Ottawa.....	39
W9BNU, Len Hoops, Kansas City.....	166
W9YAB, C. L. Omer, et al., Lawrence.....	758
W9BDB, K. E. Keller, Wichita.....	408
W9NI, H. Thompson, et al., Topeka.....	357
W9BEZ, William Obrist, Wichita.....	283
W9HTF, J. B. Law, Wichita.....	200
W9CYV, L. E. Hauck, Newton.....	178
W9CPY, Albert Poth, Newton.....	158
W5ZZD, W. B. Kendall, Kingman.....	70
W9CSD, C. E. Butrum, Holton.....	50
W9IPD, E. Thompson, Iola.....	49
W9EFE, R. E. McCullough, Coffeyville.....	24
W9FIW, C. E. Campbell, Council Grove.....	24

Total messages in 28 days..... 6,256
Average traffic per day—223.4 messages.
Average traffic per station—178.8 messages.

A GENERAL PURPOSE SHORT WAVE CHOKE

A really good r.f. choke must not only be effective in the working range, it must also be small enough to permit mounting where it will be out of the way of couplings which may—and often do—cause the choke to be much worse than useless. This is especially important in shortwave receivers, where space is always dear, because leads must be short. Here—and in other shortwave work, a mounting is often hard to find unless one adds metal parts whose capacity will be troublesome and may bypass the choke partly. A choke light and small enough to “hang by its leads” is the thing—and such a one is now offered by National Company. They can be used in numbers because of a wide effective frequency range.

The choke winding has 4 sections, each of the “Universal” type. For receiver and other low-power work over all amateur bands this has advantages over a

Dana Bacon who has done the work on the type 100 choke.

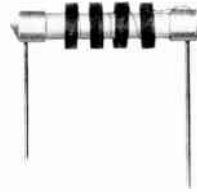

The National Type 100 Choke

Inductance, 2 mh.
Resistance, 50 ohms.
Distributed capacity 1 $\mu\mu\text{fd}$.
Maximum current carrying capacity, 125 ma.
Natural period about 80 meters.

“Among the tests to which we have subjected this choke was one in which we connected it directly across an oscillatory circuit operating at five meters. Outside of a very small tuning effect caused by the choke capacity, this circuit operated exactly as before and we took this to be an indication that the choke was very efficient at frequencies in this range.

“We do not recommend it for use on wave lengths above 200 meters since the impedance at this point is only about 20,000 ohms. As a matter of fact, the choke should really be considered suitable for high frequency work only, say below 100 meters.

“We regret that we have had no opportunity to run an impedance curve over the entire high frequency range, but from the practical standpoint such a curve is often very misleading because in a large number of applications, such as the shunt-fed Hartley circuit, any distributed capacity in the choke is not really harmful in that it probably is simply added to the tuned circuit capacity.”

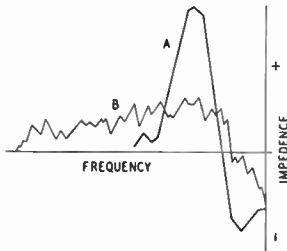

Fig. 1. Typical choke coil impedance curves.

1-layer choke. Referring to Fig. 1, the curve A is typical of a good 1-layer choke. At the best point the impedance is extremely high, well above 100,000 ohms. It is thus a fine device to use in a transmitter working in one band—but as we know from experience—that is about the limit.

The sectionalized multi-layer choke, on the other hand, tends to have a curve like B—lower but much more uniform. Unless the r.f. voltages are very high the lowering of impedance can be tolerated and the comparative uniformity is a great advantage. Quoting from Mr.

Careful statistics show that nine* out of ten banks that fail display the maxim “A penny saved is a penny earned.”
Footnote: *Corrected for normal seasonal variations and wishes.

PRESENTING

the pictorial
INDEX
to the new

SUPREME

Testing Instruments
"SUPREME BY COMPARISON"

* * *

1933 CATALOG NOW READY



Supreme Diagonometer
AAA 1—\$147.50

ALL PRICES
Dealers' net prices,
f.o.b. Greenwood, Miss.



Model 66 Tube-O-Meter, \$59.75
With Stand, extra, \$7.50



Model 33 Ohmmeter, \$26.75
Portable, extra, \$2.25



Model 77 Universal Analyzer Converter, \$18.50
Portable, extra, \$2.25



Model 90, Set Analyzer
\$78.50



Model 56, Set Analyzer, \$56.25



Model 75, A.C.-D.C. Volt-Ohm-Milliammeter, \$46.50. Portable, extra, \$2.25



Model 62, Tube Testing Power Unit, \$16.95. Portable, extra, \$3.00



Model 40, Tube Tester, \$30.00. Portable, extra, \$3.00



Model 88, Electrolytic Capacitor Tester, \$20.50
Portable, extra, \$3.00



Model 44, D.C. Volt-Ohmmeter, \$30.00
Portable, extra, \$2.25



Model 57, Decade Resistance Bridge, \$19.75
Portable, extra, \$2.25

Supreme Instruments Corp.,
146 Supreme Bldg.,
Greenwood, Miss.

Please send me without obligation the new Supreme 1933 Catalog.

Name

Address

City..... State.....

Jobber's Name

Address

.....

.....



Model 70, Shielded Oscillator, \$49.75. Output-Ohmmeter, \$30.00. Portable, extra, \$5.00

(Continued from Page 6)

when one modulates, and that the audio amplifier can have its gain control run fairly well open without going into a howl. These are merely the ordinary requirements of a fone—though surprisingly few seem to worry about B supplies that “dive” when modulating. While the gridleak will help stabilize the buffer, there isn't any sense in making it do the work of the neutralizing condenser. After the leak has been installed, re-neutralize carefully, for very probably the removal of the long battery leads has changed things.

It is also necessary to be sure that there is no leakage through the feed condenser between the buffer tank and the Class C grid—this is the condenser to the left of the choke in Fig. 1. Leakage that might not have done any harm with a NEW C battery will raise the deuce when allowed to work up positive grid voltage by flowing the wrong way through a grid leak. The only safe arrangement is to use an air condenser of about .00015 ufd. in series with the mica fixed condenser, the latter being kept to take care of flashovers. Set the

air condenser too high rather than too low. That's about all there is to it, except to adjust the antenna coupling to produce the plate current shown in the table for your particular tube combination. Oh yes—the old C batteries make good antenna counterweights.

Universal Microphone Co., Inglewood, Calif., has issued its 1933 catalog in the form of a 29-page booklet fully illustrated and including descriptive data on all its lines. This marks the fifth year of the pioneer firm which is said to be the world's largest exclusive manufacturer of microphones. By the way, in the future all Universal microphone stands will include call letter name plates as stock equipment, unless specifically ordered to the contrary. Though radio stations, chains and talkie newsreels have used the name plate for some time, it has not been a universal practice with others. The California factory will include name plate for desk, amateur, banquet and floor stands. Letters may be cemented or painted on the plates.

OSCILLOGRAPHIC EQUIPMENT

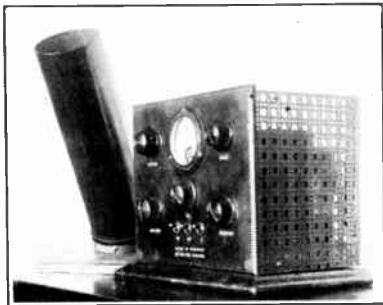

TYPE CPT-700 OSCILLOSCOPE

With cathode ray tube, gas-filled timing wave oscillator tube.

(Extras required—280 tube, 57 pentode, a small C battery, and the mounting base for the cathode ray tube.)

Correspondence invited on the above, and on any special equipment required for special tests, such as special amplifiers, magnetic deflection coils, rotating mirrors, etc.

RALPH R. BATCHER
St. Albans, Long Island, N. Y.

For many laboratory experiments and industrial tests, a Cathode Ray Tube has no substitute. This outfit is simple to operate and is inexpensive to use, enabling its use in continuous and routine tests.

The CPT 700 equipment shown at left contains both a power supply for the tube, and a timing oscillator and may be operated directly from the AC line. Supplied with a rugged, long-life tube having a screen over three inches in diameter.

The MS 3 mounting stand shown has a heavy steel shield which prevents false deflections from external fields, but is removable when desired. Equipped with output cable.

A portable outfit containing an AC operated power supply and tube mount in a carrying case can be supplied complete with the above tube. (Does not have a timing wave oscillator.)

An Accurate High-Range Ohmmeter

We will describe briefly a type of ohmmeter which will show continuity through resistances up to 3 megohms, readings at 1 megohm and thoroughly good readings up to 500,000 ohms. It is easily built, using standard parts, and is very useful, especially in servicing a.v.c. sets.

The device is really two ohmmeters, each complete with battery, series resistor and adjustable meter-shunt, but for economy the meter itself (Weston Model 301 with range of 0-1 Ma.) is switched from one circuit to the other, using a double-pole double-throw switch.

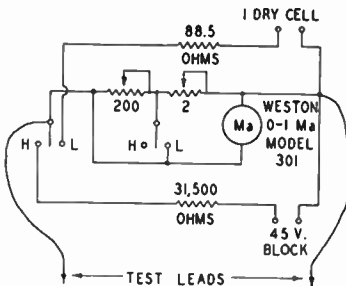

Fig. 1. Two-range circuit. Switch blades must operate together. Left position for high range, right for low range, both off in center.

connections, Figure 1, are such that accidents are very unlikely. The switch may be an ordinary knife switch or a GOOD sub-panel cam or jack switch—look out for leakage here.

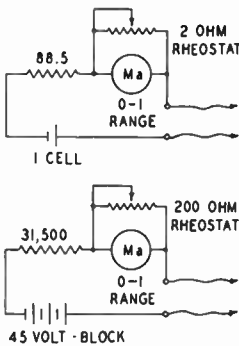
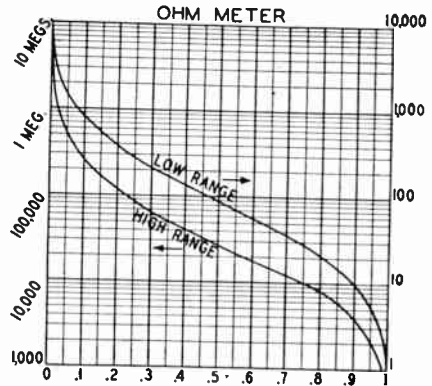

Fig. 2. Single-range circuits, low range at top.

If preferred, the meter can be built for one range, using the circuits in Figure 2. The constants are not changed.

In both figures it will be noticed that the calibrating (series) resistors are of

Page Eighteen



— METER READING —
BEFORE USING, TOUCH PRODS TOGETHER AND ADJUST METER READING TO FULL SCALE (1) BY MEANS OF THE RHEOSTAT SHUNT FOR THE RANGE USED. WHEN THIS IS NOT POSSIBLE FOR ONE RANGE THE BATTERY SHOULD BE REPLACED.

The calibration chart, correct for all meters of this type.

odd values. Accurate resistors of these values can be had on short notice at practically the list price of ordinary stock values from Shalleross and others. If there is any uncertainty or delay, please ask "Modern Radio". The shunting rheostats may be of any good wire-wound type but MUST be connected as shown. If the slider is not bonded back to one end of the winding, there is an excellent chance to burn out the meter. Fuse protection of the meter is not practical as the low-resistance range is spoiled by the resistance of the fuse.

Accuracy of Calibration

Two meters of this type were carefully compared by having their curves graphed on a sheet 12 x 24 inches. The two lines did not vary by more than $\frac{1}{2}$ " at any point on either scale. Thus it is safe to use the ready-made scale shown. Since the calibration curve printed here is small, "Modern Radio" will furnish to readers clean-cut blueprints or photostat copies of the scale from the original tracing, if desired. These trim nicely to about 6" x 7 $\frac{3}{8}$ ". The photostats are black with white lines and do not soil readily.*

Mounting

A very convenient case for the ohmmeter is a card-file box meant for 5" x 7" cards. It is somewhat deep but can be cut down if desired. The calibration chart can be put into the cover.

* Blueprints, 20 cents; photostats 50 cents; both postpaid.

LITTELFUSE HINT

A new Fusible Jack permits use of the correct fuse for each terminal of a multi-range meter. The Jack is secured under the binding post and carries a "Littelfuse" inside its screw-apart barrel. Connections are made by a solderless pin-plug which fits the jacks. Jack and fuses are due to Littelfuse Laboratories,

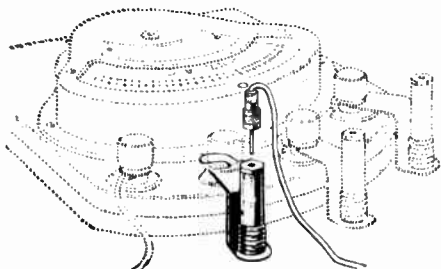

1772 Wilson Avenue, Chicago. As you know, the fuses are available in 1/100, 1/2, 1/10, 1/8, 1/4, 3/8, 1/2, 1 and 2 ampere rating but the fuse rating may be much above that of the meter, which is saved by inertia—the fuse—as Mr. Sundt says "Is quicker than a short-circuit."

In transmitting circuit carrying both d.c. and r.f. a "Littelfuse" will "blow" by reason of the r.f. current. Therefore shunt it with a mica condenser—one rated for twice the voltage that will be across it when the fuse goes away.

COMING!

AUTOMATIC TEMPERATURE COMPENSATION FOR CRYSTALS. (no thermostats)—by John L. Reinartz.

TAPPED COILS FOR SHORTWAVE CONVERTERS, by R. F. Shea. (This is really something.)

A BY-PRODUCT OF RADIO. (This is funny.)

A COMPLETELY NEW SORT OF GRID MODULATION, by Boyd Phelps.

A SET ANALYZER THAT NEVER GETS OUT OF DATE! By L. W. Hatry.

A NEW RADIOPHO—nope, we won't let you in on that yet. But you'll be surprised—and then some.

AN IMPROVED TEST FOR AMATEUR RADIOPHONES. (Simpler than you would think possible.)

FOR BETTER RECEPTION

Order a Set of Centralab Motor Radio Noise Suppressors

They're 50% to 500% more efficient in reducing spark noises. We're having a real job keeping up on production! They **MUST** be good . . . that's the only way we can explain their increasing popularity.

RETAIL PRICE	YOUR PRICE
set of 5 for 4 cyl. car	
\$2.00	\$1.10 net
set of 7 for 6 cyl. car	
\$2.75	\$1.50 net
set of 9 for 8 cyl. car	
\$3.50	1.90 net

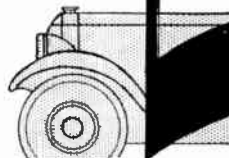

Centralab

CENTRAL RADIO LABORATORIES
MILWAUKEE, WIS.

PLUGS AND JACKS

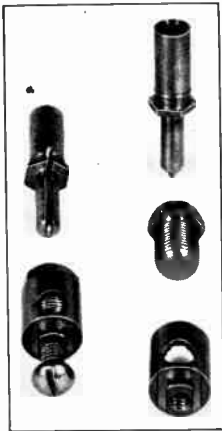

For Transmitting Plug-in Coils

These heavy, high-current plugs and jacks make QSY easy. Take copper tubing, work in High-C circuits. Unplugs easily and makes firm contact. Jack mounts nicely on insulating strips. See "Modern Radio" for September, page 24.

Parts Jobbers Write for
Discounts.

LIST PRICES

Complete Plug 30c
Complete Jack 35c

NATIONAL AGENT

Hatry & Young
203 Ann St.
Hartford, Conn.

Page Twenty

Allied Art

AN EXPOSURE METER

The Weston Model 617 exposure meter is a direct descendant of the illuminometer described on page 22 of our August issue. The photographer holds it in the position shown here and sights at his subject through the V sight-notch at the center. Two "photoronic



cells" on the far side stare at his subject and the light they see causes them to send a current through the milliammeter which faces the operator. He uses the circular slide rule at the left to convert the meter readings into shutter speed and diaphragm opening with due regard for his plate or film speed. The device should be lasting as the photoonic cell is a stable type of iron-selenium cell which seems to keep its original sensitivity of 1 microampere per foot candle, even when strongly lighted while short-circuited.



BRILLIANT!

The lighting bug's a silly bird,
It has not any mind.
It wanders through existence,
With its headlight on behind.

But the Burgess Battery Company has a creature that is a lot smarter; it carries its headlight in front, shining right down its long smooth nose, and the nose is a screwdriver. The handle is insulated for quite a lot of volts.

The meek shall inherit the earth:
i.e., what Krueger left of it.

WHAT—AGAIN ?

Please—oh please, don't be persuaded to use paraffined wood spreaders in your 2-wire feeder system, at least if it is one of the tuned systems such as the so-called "Zeppelin" arrangement.

Take the word of those who have tried it that after a few weeks sun, wind and rain remove enough of the paraffine so that your feeder current goes up and the antenna current goes down. Nearly any sort of bakelite is better, and good

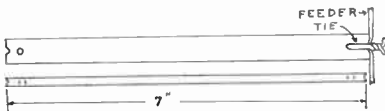

bakelite is far-far better. Make it up in the form sketched and your troubles are over unless the power peaks run above 300 watts, in which case you are in the high-hat class anyway and positively must not use home-made spreaders.

Meanwhile—the wood is still good for kindling—ask W8CXH, W1BTZ, W1FG, W1BNR, or any of the others that have tried both.

IMPROVED PRECISION DIAL

The well-known National type N precision dial has been redesigned. The vernier (and we don't mean the reduction gear) is now "engine divided" and accurate 1/10 division readings may be made, especially as the new construction permits the vernier to be flush with the dial and to remain so. This new construction provides separate bearings for the dial which no longer "floats" and touches the vernier scale. The shaft-bushing is now insulated so that shocks or burns from "hot" shafts may be prevented by grounding the dial itself—which then also acts as a shield. The new construction also takes care of small shaft misalignments.

A particularly putrid pun is technically named a "phewn." For example: (This is pun on you.) Hen's teeth are phewn and far between.

BUILDING YOUR OWN ANALYZER?

See "Modern Radio" for December—build the analyzer that will NOT become obsolete, or rebuild your present analyzer to this modern type. This isn't "another analyzer"—it is a new idea. Complete wiring diagram and all constants. Two range ohmmeter. Accommodates any type of tube.

BLILEY CRYSTALS / Quartz and Tourmaline

Powerful - Accurate - Uniform - Dependable Quartz Crystals supplied at your dealer close to specified frequency, 0.05% calibration: 1750, 3500Kc bands, \$5.50; 7000Kcs, \$9 Quartz mounting, \$2.50. Tourmaline Discs: 7Mc band, \$12; 14Mc, \$14. Special Tourmaline mount, \$2.50. 525Kc Lamb-super mounted crystal, \$9.50, 100Kc Std. Freq. mounted bar, \$12.00.

BLILEY PIEZO-ELECTRIC COMPANY
Masonic Temple Bldg., Erie, Pa.

NEW I R C

COMBINATION KIT

Containing:
1/2-Watt, 1 Watt and 2-Watt
METALLIZED RESISTORS
and
5-Watt and 10-Watt
POWER WIRE WOUND UNITS

These include the popular ranges—the ranges of the resistors that are most needed in radio replacement work today. We are combining them in one handy Kit for the convenience of Servicemen. Together with other I. R. C. Handy Kits, it is now on sale at your jobbers. Write us for folder giving full information—also new complete 16-page catalog on I. R. C. products, just off the press.

International Resistance Co.

2006 Chestnut St., Philadelphia
74 Wellington St., West, Toronto, Ont.

Metallized

Power and Precision Wire Wound

RESISTORS

THESE FEW ROSES

"Modern Radio's" thanks are hereby publicly given to the following gentlemen for aiding us in various ways. Dr. Lee DeForest, Mr. Robert Gowen, Mr. D. E. Replogle, Mr. Paul Findley, Mr. John C. Warner, Mr. Harry R. Lubcke, Mr. Frank C. Jones, Mr. William Beasley and Mr. W. F. McFarland.



Reviews

BINDERS

FOR MODERN RADIO

HOLDS 12 COPIES

*Each Copy Removable Alone
No Perforating, No Mutilation
Installation Without Tools
Removal Easy, Ruggedly Made
Finished in Leatherette
Durable, Beautiful
Protects the Magazines*

MODERN RADIO CO.

\$1.95 each

"Servicing Receivers by Means of Resistance Measurements", by John F. Rider, 200 pages, 96 illustrations.

In writing this latest of his many service helps, Mr. Rider has concentrated on the importance of resistance determinations in receiver servicing. To the experienced serviceman there may be little news in the supreme importance of the ohmmeter above all other service instruments, but to the beginner it may be most valuable information. Even the more experienced man will find much useful matter in Mr. Rider's presentation of the idea.

We would have given a whole chapter to the construction of ohmmeters. It is possible that most servicemen prefer to buy these things, but some instruction in the use of ohmmeters in measuring resistors above one-half megohm would even then be useful.

We would also wish to have materially more complete and specific instructions as to the proper conditions for measuring electrolytic condenser capacity and leakage.

These are, however, isolated points. The book, as a whole, is sound and well illustrated, just as one would expect in a work by Mr. Rider. The book is available through "Modern Radio's" book department at \$1.00.

"R9"

"R9" is published at Hollywood, California, and in its first number carries a policy announcement based on—

HAMS PARADISE

Largest Assortment of Reliable
Standard Parts on the Pacific Coast
WE HAVE THE GOODS IN STOCK
WE GIVE YOU MAXIMUM DISCOUNTS

Our Service is Fast and Reliable
Technical Advice by Experts Free to All
EVERYTHING FOR

TRANSMITTING and RECEIVING
Radio Kits, Sets, Tubes and Accessories

WEDEL CO., Inc.

Seattle, Wash., Portland, Ore.

ADVERTISING RATES

MODERN RADIO

PAGE	\$40.00
1/2 PAGE	25.00
1/4 PAGE	15.00
1/8 PAGE	10.00

RATE CARD ON REQUEST

"an open forum for amateur radio". The issue carries articles on amateur radio policy by Louis R. Huber, C. R. Cannady and Colonel Clair Foster, also excerpts from the latter's report of the annual board meeting of the American Radio Relay League and a tribute to the late Everett J. Trout. The progress of our new contemporary will be watched with the greatest interest by the staff of "Modern Radio".

"TICKLER"

We are indebted to Lieutenant W. F. Grimes, C-V(S) U. S. N. R., Commander, V. C. R., Eleventh Naval District, for a file of "Tickler", the semi-monthly publication of the United States Naval Volunteer Communication Reserve and Radio Amateur Net for the Eleventh Naval District. The district's communication office is at San Diego.

Like "QRX", of the Ninth District (see "Modern Radio" for August, page 27), the "Tickler" is well worth reading, even if one is a hopeless landlubber like 70% of the "Modern Radio" staff. We've a strong suspicion as to the identity of "Tickler's" editor, who does a good job, and makes it better by running first-rate cartoons by Kirkhart of W6HU, otherwise Radioman Second Class in the Communication Reserve.



The "Boot"—"Boy. they can't fool ME twice. I saluted one of them doormen once before."—Kirkright in "Tickler".

"MODERN RADIO'S" ANSWER FACTORY

How?—What?—Why?—Who?—When?

- A—Letter with one question \$.50
No charge for small incidental pencil sketches.
- B—Additional questions, each25
- C—Schematic diagrams of battery-driven receivers up to 6 tubes, transmitters up to 5 tubes, antennas (other than beam types), switching schemes, metering, and power circuits of reasonable simplicity75
- D—Matters such as given under C, where all constants are desired . . . 2.00
- E—a.c. or d.c. socket-power receiver circuits without constants 1.50
- F—Same as E but with all constants 3.00
- G—Transmitter diagrams of greater complexity, bibliographies, operating instructions, analysis of complex operating difficulties in apparatus, and other questions not covered by the above will be estimated on receipt of a clear and complete statement of the problem.

NOTES

1. Keep a copy of your letter, including diagrams, numbering questions 1, 2, 3, 4 and lettering diagrams a, b, c, d.
2. The right is reserved to return remittances for any questions which it is impossible to answer.
3. No attention will be paid to radio-grams, telegrams or letters (other than those under class G) which are not accompanied by a remittance. Please use money order—loose cash may not arrive.
4. Address letters, "Modern Radio", 101 Allyn Street, Hartford, Connecticut.



AGENTS WANTED

Sell subscriptions for "Modern Radio". Every experimenter, serviceman and amateur is a prospect. Cash commissions.

Radio clubs should write for group prices.

Schools, or student groups get special rates.

MODERN RADIO Co.

101 Allyn St., Hartford, Conn.

THE R. C. A. 48

An Audio-Frequency Screen-Grid Tube!

In 110-volt d.c. receivers one is always cramped for plate voltage and filament current, especially at the output tubes. For instance a pair of 45 tubes with filaments in series take $1\frac{3}{4}$ amperes from the line—and that's 192.5 watts of which nearly all has to be wasted in a resistor. You can run a fair stove with 200 watts!

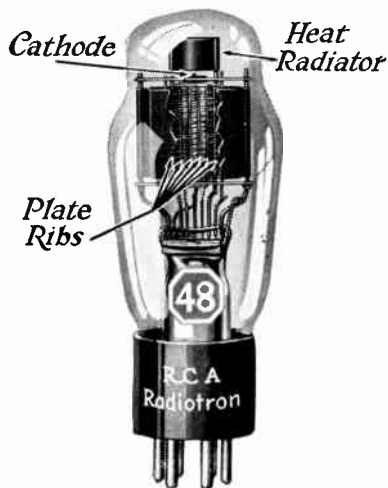

The 48 Output Tetrode

Filament 400 Ma., 26-39 volts.
Plate 47 Ma. at 95 volts.
Screen 9 Ma. at 95 volts.
Mu 28.
Mutual, 2,800.
Plate R., 10,000 ohms.
Load R., 2,000 ohms.
Output autobias, 1.6 watts.
Output battery bias, 2.5 watts.
Bias, 20 volts.

The 48 fits in here. It is a screen-grid tube which acts like a pentode. The structure is unique because of the need for drawing large plate current at low voltage. Screen current is unavoidably high, also the grid becomes so hot that it has been given heavy supports with a radiator (honest) at their upper ends in the dome of the tube. To permit adequate plate current the screen is run pentode-fashion, at the plate voltage. To prevent destructive secondary emission while keeping the plate impedance within reason the plate is ribbed, securing an action having some resemblance to that of the extra grid in the pentode. Un-

fortunately the tube resembles pentodes in the percentage of harmonic content—but who are we to resent that in the first tube that really delivers some audio power at 110 volts?

If C battery is used a precious 20 volts is saved for the plate and the output may be run up to 2.5 watts, the screen being left at 100 volts. If resistance bias is being used on one tube use a 360 ohm resistor and filter a la Phelps, Fig. 5, page 11, June, 1932, "Modern Radio". For push-pull omit filter and use 180 ohms.

"Only one invention in a million amounts to anything." Corrected version: Only the million in one invention amounts to anything.

DEVOTED PRINCIPALLY TO
THE INTERESTS OF
THE RADIO AMATEUR

R9

September
1932
September
No. 37
90c in U.S.A.

DEDICADO ESPECIALMENTE
A LOS INTERESES DE LOS
AFICIONADOS AL RADIO

"R9"—OF, BY, FOR HAMS

Temporary subscription rates: U. S. A., \$1.00;
Canada, \$1.75 (reason, tariff); Newfound-
land, Spain, and all independent American
countries, \$1.25; elsewhere, \$1.50 U. S.
currency.

Samples and single copies: Current issue,
U. S. A., 20c; elsewhere, 25c; back issue,
U. S. A., 25c; elsewhere, 30c.

Published by R9, Ltd.
Box 666, Hollywood

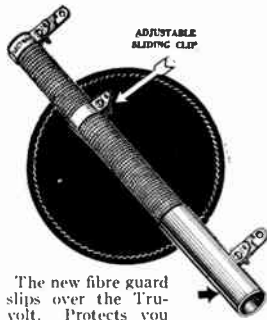

The new fibre guard slips over the Truvolt. Protects you and resistor from accidental contact with hands or tools.

New FEATURES

No other resistor has these TRUVOLT advantages:

- 1—Patented construction. Larger wire. greater radiation.
- 2—TRUVOLT construction insures better electrical contact.
- 3—Spiral winding provides finer adjustment.
- 4—Adjustable Clips for any desired voltages.
- 5—Full-length fibre guard prevents injury.

These *exclusive* features make TRUVOLT'S the most *economical* and *adaptable* resistors. All standard sizes.

VOLUME CONTROLS

Interchangeable Switch

The new ELECTRAD STANDARD VOLUME CONTROLS have removable end covers, which may be instantly replaced by a power-switch assembly, without disturbing control connections.

In addition, *long aluminum shafts are now standard—EASILY CUT TO DESIRED LENGTH.*

Whatever you need in Volume Controls, or Amplifiers, ELECTRAD makes it. *Ask your Dealer.*

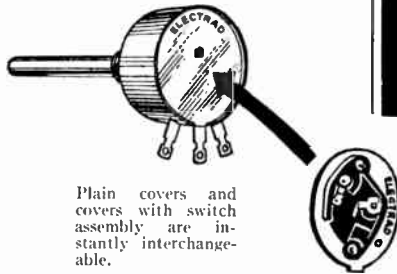

Plain covers and covers with switch assembly are instantly interchangeable.

175 Varick Street, New York

ELECTRAD
INC.

Write Dept. MR-11 for Complete
New Catalog of Electrad Products



Crystals

Precision ground, powerful oscillators
made from finest quality Brazilian Quartz
UNCONDITIONALLY GUARANTEED

AMATEUR CRYSTALS

80 and 160 meter bands "X" or "Y" cut—our calibrations guaranteed accurate to .001%:	
Random frequencies within the band, selected by us	\$ 5.00
5 kc. of frequency specified	7.50
40 meter band, "X" cut, within 1/2 of 1% frequency specified by you	10.00
40 meter band, "X" cut, random frequencies within the band, selected by us	8.00
1-inch oscillating blanks	3.00
Unfinished blanks	2.00
Plug-in dustproof holders	2.00

All calibrations made with General Radio Frequency Standard and checked with Bureau of Standards transmissions and U. S. Naval Observatory time signals.

175 kc. Stenode Crystals \$ 3.50
High or low frequency Crystals of all descriptions made to order.

TOURMALINE CRYSTALS and
BLANKS for frequencies up to 15
Megacycles—quotation on request.

BROADCAST CRYSTALS

Complete with Holder—Special, \$42.00
Ground close enough to insure quick adjustment to within 50 cycles of assigned frequency by varying the operating temperature between 45 and 55 degrees centigrade. Prompt shipment.

We Solicit Your Inquiries

Premier Crystal Laboratories, Inc.

55 PARK ROW

NEW YORK CITY

MODERN RADIO QUIZMATIC

And here's a quizmatic that's good for any transmitter man, either c.w. or fone. Please assume that the set has plenty of shielding, and that it is to work at 7,500 kc. (40 meters in United States' money). As it stands the carrier turned out by this set will not be stable, and the efficiency will be phooey, as they say in Delancy Street.

that might well be better.

As to the four runners-up, Great Scott, there are five men so closely bunched that it's no use and we hence are dealing out an extra six-month extension to make things even betwixt Messrs. D. R. Atkins, Sol. Shenker, A. K. McLouth, E. R. Ruland and J. P. Peckham.

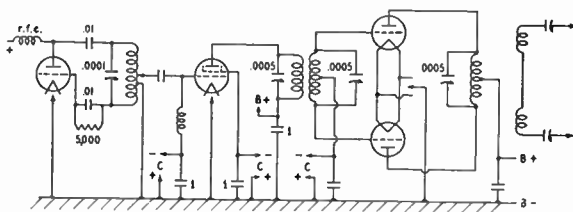

As usual, a year's sub. for the most to-the-point correction, 6 month's sub. to the next four, our judgment to be final.

By the way—don't worry about the arrows in the filament circuits; that simply means that the filament circuits are properly center-tapped and bypassed.

September Winners

First prize goes to Mr. Nathan R. Smith, Service Department of Western Wholesale Radio Co., Los Angeles, who spotted five of the seven possible errors

Now here's the diagram again and the story:

- 1—There's no r.f. filter after the detector, hence the r.f. from this tube will enter and overload the first audio tube.
- 2—The '50 bias resistor should be 750 ohms to permit full output, and decent fidelity.
- 3—The first audio tube hasn't enough plate voltage to permit it to drive the last stage fully—ought to be about 180 volts.

And if one wants to be fussy, the following need fixing:

- 4—Lower first audio grid-leak to prevent blocking on audio bumps.
- 5—For 180 volts it wouldn't hurt to use 2,500 ohms on first audio cathode.
- 6—Bypass the B supply of first audio to improve low notes and prevent motor-boating.
- 7—Increase size of first audio cathode by-pass for better low-note reproduction or use the scheme described by Phelps in June "Modern Radio."

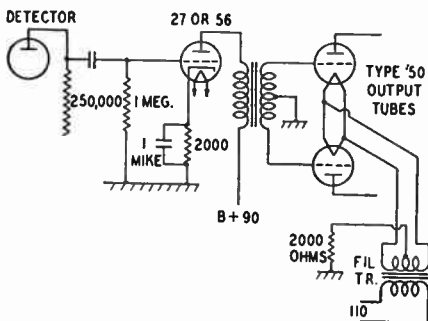

—did we say three? We impologize, we meant that three are hopelessly wrong, but there are four other things

"Healthy, wealthy, wise." Now reduced 33%, special for 1932.

Of Course

IT'S DIFFERENT



KRUSE! PHELPS! BATCHER! HATRY!—

Four well-known engineers, edit this "Modern Radio" magazine, make it the accurate, helpful and informative sheet it is.

Shorn of padding, concise in treatment, "Modern Radio" is as modern as its name. The busy man finds this compact, easily read, and well-filled journal the answer to his needs. Easy to carry, easy to read and of exceptional reliability, "Modern Radio" is the answer to your need for a magazine that gives a lot for a little time from its reader.

Full of news because the lack of "blah" gives space for facts. You can't afford to be without "Modern Radio". Pin two \$1 bills to the coupon, write your name and address and mail it now. Get real radio pleasure from the next 12 months.

SUBSCRIBE NOW, USE THE COUPON

PIN
HERE

I am tired of padded articles. I like "Modern Radio's" concise, snappy style. I like the tremendous amount of information you get into small space. In fact, I even like the man-sized coupon I filled in and pinned \$2 to for one year of "Modern Radio" starting.....

My Name.....

Address.....

TOO MUCH FOR US

Weston offers gratis an up-to-the-minute sheet showing just what adapter to use in any Jewell or Weston analyzer or tube tester in order to handle any of the swarms and swarms of the new tubes. The circular is so comprehensive that we can't reprint it. Write to our good friend John H. Miller, Radio Engineering Division, Weston Electrical Instrument Corporation, Newark, N. J., and ask for Circular D-10-B.

NON-COMMERCIAL SERVICE-MAN'S ORGANIZATION

The Institute of Radio Service Men was started last fall and now reaches into practically every state and several foreign countries in addition.

The institute has no examination, but requires of applicants a report as to service experience, training and references. The yearly dues are \$3.50, which include the journal. Institute sections are being formed in various cities.

Address correspondence to 538 South Clark Street, Chicago, Ill.

(Continued from Page 9)

secure high audio selectivity. Fig. 2 shows the measured selectivity curve of the audio amplifier and is the writer's favorite for the 7 and 3.5 mc. 40 and 80 meter amateur bands. Such selectivity is rather high for the 14 mc. 20 meter band and is not as practical as a broadly tuned or ordinary audio amplifier. The tuned transformers were each made with an .01 mica condenser and a choke constructed from an old No. 125, Samson r.f. choke, 250 millihenry originally but fixed up with "A metal" laminated cores which had adjustable air gaps in order to tune them to exactly 800 cycles after assembly in the receiver.

The idea of a bias detector and separate oscillator in the approximate form shown is advocated for more general use because of the fairly simple modifications in the usual short wave receiver. Single control tuning and inexpensive construction are advantages over the much more elaborate new quartz crystal super-heterodyne s.w. receivers.

Page Twenty-Eight

The ANSWER

I

Complete data on the latest tubes, six pages of tube tables alone.

II

Complete basic A. V. C. circuits, and how to service them.

III

Resistor wattages and currents, resistor color-code, proper cathode biasing circuits. Thirty-two pages of information ready right now.

IV

MODERN RADIO
SEVICEMAN'S
POCKET BOOK

25¢

Short Circuits

—BUT NOT FORGOTTEN

NAA Tested Galena.
 Paragon.
 Radak.
 VT2.
 Three-Circuit Tuners.
 Zincite-Bornite.
 Cerusite.
 Thermiodyne.
 Radisco.
 Silicon.
 Acoustats.
 \$22.50 Headsets.
 Moulded mud.
 Audion control panels.
 B battery potentiometers.
 Four-wire aerials.
 Electrose.
 The pencil rubber dial vernier.
 Rotaries.
 Pancake coils.
 Kick backs.
 Coherers.

The following comment on crystal cuts is from D. E. Replogle, Chief Engineer of DeForest Radio Co.

In the zero angle cut the crystal is manufactured from a quartz plate which has been cut through the plane perpendicular to the X-axis of the natural quartz crystal. The 30 degree crystal is, as its name implies, made from a quartz plate cut from a natural crystal along a plane 30 degrees from the X-axis.

Each cut has its advantages. The zero angle crystal is less likely to have spurious frequencies, while the 30 degree crystal is more active. From the manufacturing standpoint, the 30 degree crystal is the best product where immediate profit is concerned, since these crystals will generally oscillate readily and without a great deal of effort on the part of the grinder. These crystals, however, will frequently and without apparent reason shift their frequency of oscillation several kilocycles. This is particu-

larly true if the load on the crystal changes, or if the temperature of the crystal is subject to change. Proponents for 30 degree crystals admit that the possibility of spurious frequencies exists, but also claim that the spurious frequencies can be removed by proper treatment.

THE BEST 50-WATT SOCKET

Now way down in price!



Note exclusive *Double Contacts*. No more tubes wrecked due to contact resistance. Excellent porcelain insulation, cadmium plated soldering terminals, slotted knurled nuts, etc.

No. 211 Socket, new list price.....\$2.40
 Another new socket, very similar, but for UX base tubes. The best socket for '66 rectifiers, '52 and other transmitting tubes.
 No. 210 Socket, list price.....\$1.50

Why use bulky stand-offs?
 Those handy insulators you see everywhere are our No. 20, 2½" high, but only 1¼" by 1¼" base.
 No. 20 Stand-off Insulator,
 list price\$1.15



Your jobber can supply these and other
 JOHNSON Items
 at generous discounts, or order direct.

**E. F. Johnson Co.,
 Waseca, Minn.**

RICHARD F. SHEA
Radio Consultant

Specialist in manufacturers' design and production problems. Short-wave receiver design, laboratory and inspection equipment, power equipment. Component parts design. Broadcast and all-wave superheterodynes.

8419 101st Street
RICHMOND HILL, N. Y.
Phone Cleveland 3-4628

ROBERT S. KRUSE, E. E.
RADIO ENGINEERING SERVICE

Transmitter Improvements, Special Receivers, Measuring Devices, Radio Equipment Designed and Constructed.

103 Meadowbrook Rd., West Hartford, Conn.
Tel. Hfd. 45327

WHERE TO BUY
"MODERN RADIO"

ARIZONA
Nielsen Radio & Sporting Goods Co., Phoenix

CALIFORNIA
Associated Radio Buyers, Oakland
Jack Broadly, San Francisco
Coast Electric Co., San Diego
I. S. Cohen's Sons, Inc., San Francisco
El Cajon Radio Exchange, San Diego
Electric Supply Co., Oakland
High Frequency Engineering Lab., Los Angeles
Inter-City Radio Stores Co., Long Beach
Offenbach Electric Co., San Francisco
Radio Doc., Los Angeles
Radio Manufacturer's Supply Co., Los Angeles
Radio Supply Co., Los Angeles
Radio Technical Labs., Long Beach
Sea Cliff Radio & Elec. Co., San Francisco
San Francisco Radio Exchange, San Francisco
Warner Bros., San Francisco
Warner Bros., Oakland
Wenger-Brill Co., Oakland
Western Wholesale Radio, Inc., Los Angeles
Zach Radio Supply Co., San Francisco

CONNECTICUT
Hatry & Young, Inc., Hartford
S. S. Kresge Co., New Haven

ILLINOIS
Abbott's Sweet Shoppe, Berwyn
Chicago Radio Apparatus Co., Chicago

MARYLAND
Radio Electric Service Co., Inc., Baltimore

MASSACHUSETTS
T. F. Cushing, Springfield
Neisner Bros., Boston
Sager Electrical Supply Co., Boston

MICHIGAN
Radio Specialties Co., Detroit

MINNESOTA
Lew Bonn Co., St. Paul

MISSOURI
Stone Electric Co., St. Louis

NEW JERSEY
Kaltman & Kennyhertz, Newark

NEW YORK
Blan, the Radio Man, Inc., New York City
Jerry's Place, New York City
Leeds Radio, New York City
Roy C. Stage, Syracuse
Sun Radio, New York City

OREGON
Northwest Radio Supply Co., Inc., Portland
Guy B. Paine Co., Portland
Wedel Co., Inc., Portland

PENNSYLVANIA
Cameradio Co., Pittsburgh
Hall's, Harrisburg
M. & H. Sporting Goods Co., Philadelphia
Radio Electric Service Co., Inc., Philadelphia

RHODE ISLAND
City Hall Hardware Co., Providence
W. T. Grant Co., Providence

WASHINGTON
Spokane Radio, Inc., Spokane
Wedel Co., Inc., Seattle

FOREIGN
R. C. O'Connor, Tearo Book Depot, Wellington,
New Zealand
McGill's, Melbourne, Australia

MORE NEXT MONTH

RALPH R. BATCHER

Radio Engineering Consultant
Radio Receiver Designs, Testing and
Laboratory Equipment, Special
Apparatus and Models Developed
Member I. R. E.

113-35 198th St., St. Albans, L. I.

MODERN RADIO
ANNEX

This Booklet contains:

"A \$2.85 Oscilloscope
How to Make and Use It"
By John L. Reinartz

Also: "How to Pass Radiophone
Examinations"

25c

MODERN RADIO CO.
Hartford, Conn.

THE BAZAAR

Please abide by these rules:

1. 7c per word, payment with ad.
2. Ads for an issue must reach us the first of the preceding month.
3. Used, reclaimed or surplus items must be so described.
4. Please PRINT your name and address.
5. We reserve the right to refuse any part of an ad.
6. Ads designed to stand out cost extra. 10c a word all capitals.

SPEED TUBE HEADQUARTERS FOR SOUTH-ERN CALIFORNIA. WESTERN WHOLESALE RADIO CO., 1224 WALL ST., LOS ANGELES, PRospect 0450.

GUARANTEED MICROPHONE REPAIRS—ANY MAKE OR MODEL, 24-HOUR SERVICE, STRETCHED DIAPHRAGM DOUBLE BUTTON REPAIRS, \$7.50. OTHERS, \$3.00. SINGLE BUTTON REPAIRS, \$1.50. WRITE FOR 1933 CATALOGUE WITH DIAGRAMS. UNIVERSAL MICROPHONE CO., LTD., INGLEWOOD, CALIF.

Transmitters, receivers. "Built by a Ham, for Hams." Cheap. Ernest Ruland, W1EXP, Natick, Mass.

INCREASE YOUR OUTPUT !!

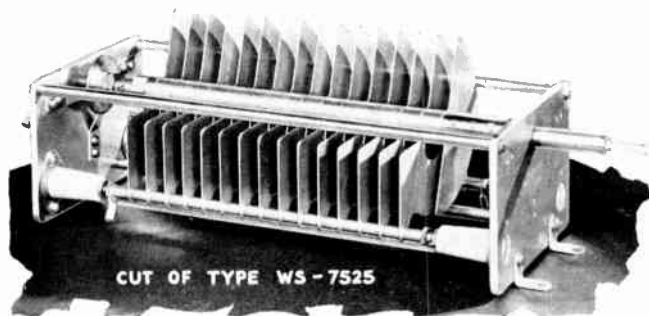

D X
with
Wireless
Shop
Condensers

7500 Volts! .00025 MF. List Price, \$18.00!

Even an 852 will handle the full 1000 watts allowed by the Federal Radio Commission
BUT WILL THE CONDENSER HANDLE IT?

Any amateur who has a type 852 should own one of these marvelous Wireless Shop Condensers—designed to meet the requirements of the present day amateur. The rigidity of the condenser, its extremely low losses, wide, tense, wiping contacts, all add to the output to be secured in the antenna.

BRUSHING is reduced to a minimum, due to the well-rounded plates, rounded with automatic rounding machinery.

BEAUTIFUL BEYOND COMPARE—BE PROUD OF YOUR TRANSMITTER, AND PROUD TO SHOW YOUR NEW HIGH-POWER CONDENSER.

FREE Catalog—Hams, just send your QSL card—we will mail the catalog postpaid.

DISTRIBUTORS—Inquiry invited.

MANUFACTURERS' AGENTS—Inquiry invited.

THE WIRELESS SHOP

150 Glendale Blvd.

(Since 1910)

Los Angeles, Cal.

« GOING FAST

MODERN RADIO
SERVICEMAN'S
POCKET BOOK

ORDER NOW

25¢
POSTPAID

Tube Base Connections,
New Tubes, Old Tubes,
Special Tubes, in
Six Tube Tables
Anti-Noise Antennas
Volume Control Replacements
Resistor Color Code

Electrolytic Condenser Tester
Automatic Volume Control
Improved Ohmmeter
Tone Controls
Hum Cures
Resistor Wattage Table
Improved Cathode Biasing

ALL UNDER ONE COVER

MODERN RADIO CO. 101 Allyn St. Hartford, Conn.

Page Thirty-One



LATEST & FINEST "Communication Type" H.F. Receiver

For amateurs who want the latest and finest in "communication type" HF Receivers, we now offer the NATIONAL AGS. The AGS has been developed in conjunction with the Airways Division of the U. S. Department of Commerce to comply with the exceedingly strict requirements of aviation ground-station service.

Nothing has been omitted to make the AGS the very last word in performance and reliability. It can be shifted from CW to Voice with the turn of one control. It is equipped with optional manual—or automatic-volume control. A ground-celluloid station chart on the panel allows for easy change or erasure in listing stations. Provision is made for either phone or speaker output. Tubes employed are four 236's, four 237's, one 238. Other special features of the AGS are:

1. Design to give image suppression, improved signal-to-noise ratio, improved weak-signal-response.
2. Single tuning-control with 270° precision vernier German-silver dial (straight frequency line tuning).
3. Calibration curves and station chart on front panel.
4. Coil-change from front-of-panel.
5. Extremely rigid mechanical construction.

NATIONAL "AGS"

Communication Type
SHORT-WAVE RECEIVER



Made by the Makers of
NATIONAL VELVET VERNIER DIALS

COUPON—National Company, Inc., 61 Sherman Street, Malden, Mass.

Please send me full particulars of the AGS Receiver and your new 18-page Catalogue.

NAME.....
ADDRESS.....

6. Relay rack mounting, size 8 3/4" by 19".
7. Frequency range 2400 to 15,000 kc. Additional coils available to extend range to 20,000 kc.

Operates on Full AC

New NATIONAL Power Units are available for operation of single units or pairs, permitting stand-by on two or more frequencies. R. C. A. Licensed.

We also Announce the NEW NATIONAL "58C" COMMUNICATION TYPE SHORT-WAVE RECEIVER

The SW-58, with its definitely superior signal-to-noise ratio, as compared with any other type of commercially available short-wave receiver, is now available for rack panel mounting with front-of-panel coil change. This adapts it for use in standard or transport communications equipment.

The 58C may also be obtained mounted in a walnut cabinet for table use. Standard coils cover frequency range of 2.6 mc. to 22 mc. Special coils available for extending range to include all frequencies between 150 kc. and 33 mc.

Send Coupon Below for Full Information and Prices.

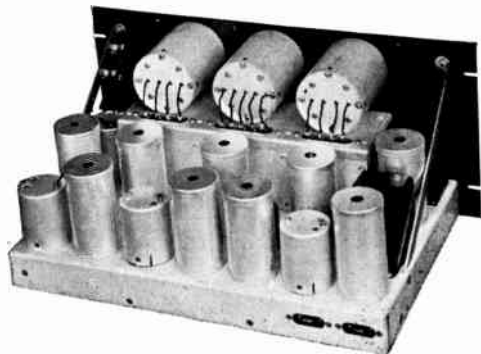

MR-11-32