

# MODERN RADIO

EDITED  
BY  
ROBERT  
S.  
KRUSE

## CONTENTS

	Page
An Improved Ohm-meter . . . . .	4
Class A Prime Audio . . . . .	6
New Tubes-41, 42, 44, 55, 83, 85, 89 . . . . .	9
Rectifiers . . . . .	13
Amateur Diamond Antennas . . . . .	14
Designing Diamond Antennas . . . . .	17
Sweep-Circuit Oscillators . . . . .	19
Temperature-maintained Crystals . . . . .	21
Allied Arts . . . . .	22
Editorial . . . . .	25
Short Circuits . . . . .	28

Copyright 1932 by Modern Radio Co. All rights reserved



August

Number 14

20 cents

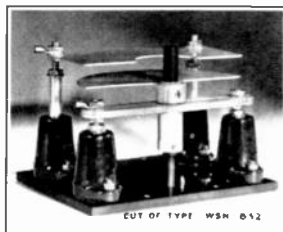
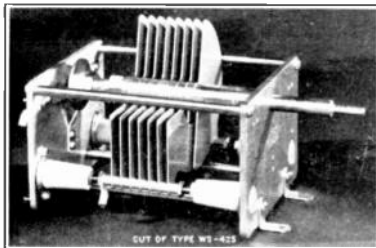
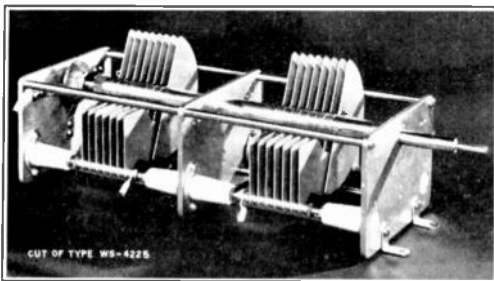
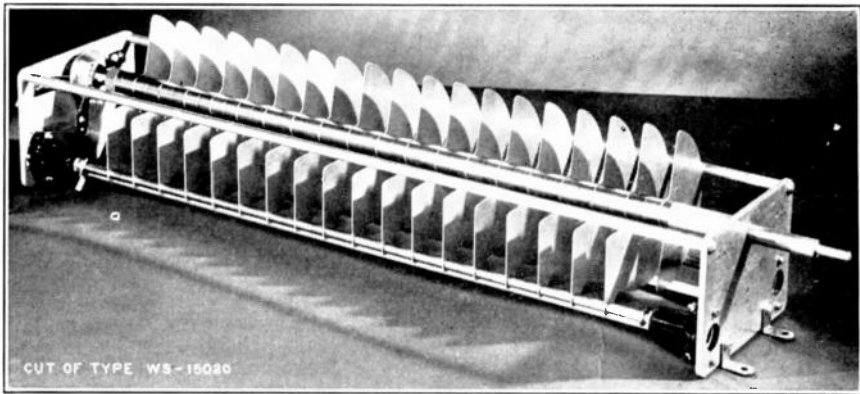

**THIS IS THE  
WHOLE FAMILY**  
from Little Neutralizing  
to  
The Old 15,000 Volt Grandpa  
and includes  
**The Siamese Twins**  
All are now equipped with  
**Coorsite Insulation**  
**AT NO INCREASE IN PRICE**  
Extreme Rigidity and Correct  
Design make this a  
**Superior Condenser**

**LIST PRICES**

Type	Maximum Capacity	Voltage	Overall Length	Price
WS 7510	.0001	7500	8 1/4"	\$16.00
WS 7525	.00025	7500	13"	18.00
WS 7535	.00035	7500	16"	19.50
WS 7550	.0005	7500	21"	23.00
WS 75210	2—.0001	7500	13"	20.00
WS 75225	2—.00025	7500	22 1/2"	25.00
WS 410	.0001	4000	6"	12.00
WS 425	.00025	4000	7"	13.00
WS 435	.00035	4000	7 1/4"	14.00
WS 450	.0005	4000	8 1/4"	15.50
WS 4210	2—.0001	4000	8 1/2"	15.00
WS 4225	2—.00025	4000	10 1/2"	19.00
WS 15010	.0001	15000	16 1/2"	20.00
WS 15015	.00015	15000	21 1/2"	24.00
WS 15020	.0002	15000	26 1/2"	28.00
WSN 852	.00001	7500	4"	5.00
WSN 204	.00003	7500	6"	7.50

NOTE -Types 75210, 75225, 4210 and 4225 are of the Split Stator Type for Push-Pull Circuits. Type WSN 852 is a neutralizing condenser for 852 tubes. Type WSN 204 is a neutralizing condenser for 204 and other high power tubes, having a grid to plate capacity under 50 micromikes.

**SPECIAL TO AMATEURS**

A Discount of 33 1/3% from list prices Shown  
Order from your Local Dealer who will give you  
your discount of 33 1/3% adding only actual  
transportation charges.

If your Local Dealer does not stock them, order direct from factory. Enclose check or P.O. order for list price less 33 1/3%. Shipment will be made express collect.

Manufactured By

**THE WIRELESS SHOP**

A. J. EDGCOMB

150 Glendale Blvd. Los Angeles, Calif.  
MANUFACTURING RADIO SPECIALTIES SINCE 1910

# OVER 40,000 CALLS

LISTED  
IN EVERY ISSUE



ALWAYS  
UP-TO-DATE

*Including New Call Letters  
Changes in Address  
Cancellations  
"Who's Who" on Short Wave  
International Calls  
and many other features*

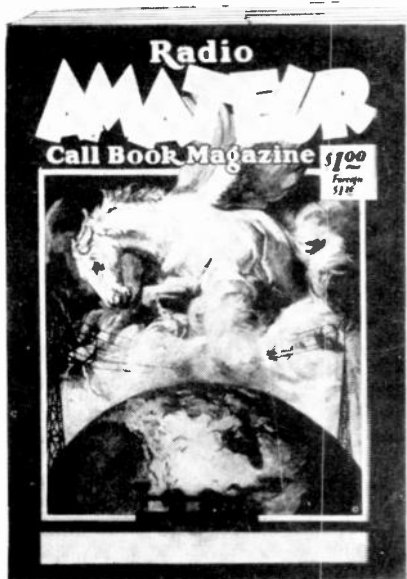

IF YOU ARE INTERESTED IN SHORT WAVE TRANSMITTING  
OR RECEIVING YOU CANNOT AFFORD TO BE  
WITHOUT THIS BOOK

Radio Amateur Call Book contains Up-to-the-minute Changes in listing new calls, changes in address, and cancellations for over 25,000 licensed Amateurs in the United States and possessions, and over 10,000 licensed Amateur Stations in more than one hundred different foreign countries.

Each issue also contains High Frequency Commercial Stations, Who's Who on Short Wave, Special Stations and Expeditions, International Call Letters, New Prefixes, High Frequency Press and Weather, and Time Signal Schedules.

TRULY THE GREATEST LIST OF CALLS PUBLISHED  
UNDER ONE COVER

SINGLE COPY \$ 1.00      ANNUAL SUBSCRIPTION \$3.25

Issued Quarterly—March, June, September and December

ORDER YOUR COPY TODAY!

## RADIO AMATEUR CALL BOOK, INC.

608 S. Dearborn Street

Chicago, Ill., U. S. A.

# An Improved Ohmmeter



A 2-range ohmmeter by G. H. Cooper. With a self-contained one-cell battery it gives useful ranges of 1 to 100 and 100 to 10,000 ohms. The upper tip-jacks are the ones labelled A and B in the diagrams and are for the high (series) range. The two lower jacks are for the low (shunt) range, the shunt circuit being made by the split jack D, as shown in the diagrams. The knob at the lower left is the clarostat used to effect zero compensation.

Commercial ohmmeters have an odd habit of costing money, and of not providing a sufficiently low range for much of the circuit work having to do with filament wiring, shorted windings (r.f. or power), or bad switch contacts. About the only simple way to gain two

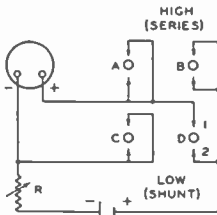
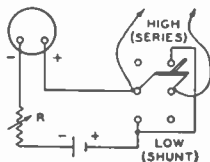

Diagram of the Cooper meter.



Equivalent diagram showing how a switch may replace the special jacks of the Cooper meter.

ranges that cover most of the ordinary problems is to use one series range (high) and one shunt range (low), as has been explained.

In the ohmmeter pictured in this article Mr. George H. Cooper of Hartford has provided two very useful ranges, (1 to 100 and 100 to 10,000 ohms) without any complications, with an extremely simple circuit and in most compact form. The diagrams and the photostats explain matters fully. The scale has been reproduced here so that others may build their own. It will be well to check a few points on each scale to make sure that nothing has gone askew. All zero adjustments are made with the clarostat so as to bring the pointer to the right end of the scale. This can be done either

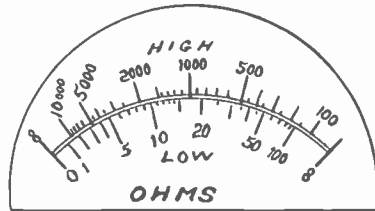

The scale of the Cooper meter. "Modern Radio" can supply these on heavy paper. Send five 3 cent stamps for any number up to 10. They fit the Weston 506 meter.

with the test leads plugged into the "high" tip-jacks and touched together, or else with the leads plugged into the "low" tip-jacks and separated. The same adjustment is usually good for both arrangements.

The scale is intentionally thrown off VERY slightly so as to allow compensation for any meter errors by using a shunt (fixed) of 250 to 1,000 ohms. Don't use the shunt unless you have really good resistors to check against and the clarostat does not suffice.

Observe, by the way, that the ranges given are the USEFUL ranges—not imaginary ranges that are at the extreme ends of the scale. A type which goes into the megohm region will be shown later.

The box is of  $\frac{3}{16}$ " ply-wood and measures  $3\frac{1}{2}$ " x 5" x  $1\frac{1}{2}$ " outside. The meter is mounted by small machine screws passing through drilled holes in the flange. To avoid this, increase the

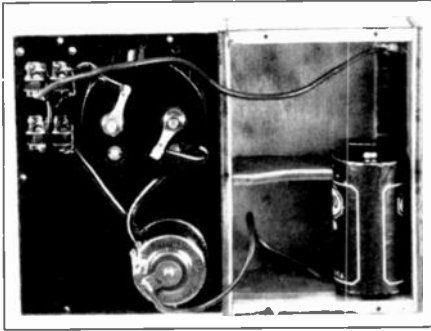

The inside of the ohmmeter, showing the two-spring jacks. Except for jack D the springs of each may be connected together to lower contact resistance.

box and panel to 4" x  $5\frac{1}{2}$ " and use the clamping ring supplied by Weston.

Three of the jacks could just as well be ordinary tip-jacks although they are actually made specially. The fourth jack has the two springs insulated from each other (D1 and D2) so that it closes the shunt-circuit for the low range when the cord tip enters and connects D1 to D2. The special springs can be obtained through "Modern Radio", but it is also possible to use an ordinary switch or else to rebuild a five-prong "wafer" tube-socket as shown in still another sketch.

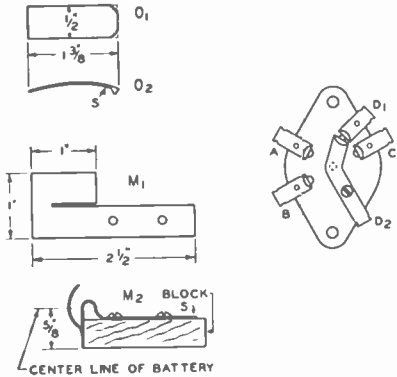

Dimensions of the brass contact springs used to hold the flashlight battery. M1 is bent to shape M2 and screwed to the block which measures  $\frac{1}{2}$ " x  $\frac{1}{2}$ " x  $\frac{1}{4}$ ". O1 is bent to shape O2. The wires are soldered on at the points S.

A 5-pronged socket with a special spring (X) added, will give the same action as the special tip-jacks. The lettering is as before. X is held by a screw through the unused prong-hole, and may also be secured at the center rivet (dotted) of the socket.

Mr. Cooper has agreed to supply panels to those not mechanically inclined. These will be 4" x  $5\frac{1}{2}$ " as above, with all drilling, counter-sinking and cutting done and the eight clips screwed into place, also the woodscrews supplied. The price is \$3.00. Having seen his work, we know it to be well worth the price and will be pleased to forward any orders. If it's inconvenient for a reader to secure any of the other parts, we will be pleased to advise.

### WHERE WERE YOU?

If this is your first look at "Modern Radio" there's an item of particular interest for you in the Bazaar on Page 30.

The Editorial—if it matters—is on Page 25.

*Editor*  
**ROBERT S. KRUSE**  
*Associate Editor*  
**L. W. HATRY**

*Published Monthly by*  
**MODERN RADIO CO.**  
 101 Allyn Street  
 Hartford, Connecticut

*Business and*  
*Advertising Manager*  
**N. T. YOUNG**  
 Tel 5-2733

*Contributing Editors*—BOYD PHELPS, PERRY O. BRIGGS, R. R. BATCHER.

For Advertising and Subscription Representatives, See Page 27

Entered as second class matter at the post office at Hartford, Conn. (permit application pending), June 20, 1931, under the act of March 3, 1879. Yearly subscription \$2.00 in U. S. only, \$3.00 in foreign countries including Canada. Single Copies, 20c.

Contributions not returned unless accompanied by stamped, self-addressed envelope.  
 Copyright, 1932, by Modern Radio Co.

Advertisements accepted only on terms stated on current rate card.

# A New High Efficiency Audio Power Stage

## For Modulation and Public Address Work

By Ralph P. Glover\*



Within the last few months, there have been outstanding advances in audio amplifier design. The trend has been toward increased power in the output stages of both radio receivers and general purpose audio amplifiers. This has usually been accomplished by the use of "trick" tubes (such as those of the zero-bias ilk) or by the drastic biasing of conventional tubes to plate current cut-off for the purpose of improving plate circuit efficiency. Both of the

istic for the pair of tubes which is only partially relieved by the push-pull form of circuit. Discontinuous characteristics are always synonymous with waveform or harmonic distortion.

In the July issue of "Modern Radio", McMurdo Silver described a "True Class A" mode of operation whereby an output of 8 watts was obtained from a pair of conventional '45 tubes with far less than tolerable distortion. This same system has also been applied to the well known "250" tubes, which, in the circuit described in this article, will easily turn out 30 watts with a maximum total harmonic content of 5 per cent.

What determines the amount of power which can be supplied to the loads by any particular vacuum tube or arrange-

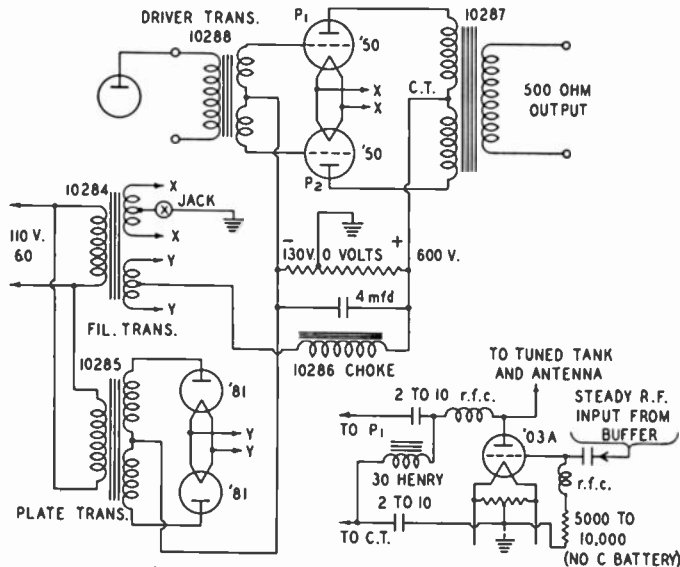

Fig. 1. The Class A prime 30 watt stage.

For public address work it is used as shown in the main diagram.

When used to modulate a 50 watt r.f. amplifier (Class C) the secondary of the 10287 output transformer is not used. Instead connections are

above expedients, at least with tubes and circuits thus far announced, result in a high order of harmonic distortion at low outputs. This is self evident, since there is a pronounced discontinuity in the grid voltage-plate current character-

istic for the pair of tubes which is only partially relieved by the push-pull form of circuit. Discontinuous characteristics are always synonymous with waveform or harmonic distortion. In the July issue of "Modern Radio", McMurdo Silver described a "True Class A" mode of operation whereby an output of 8 watts was obtained from a pair of conventional '45 tubes with far less than tolerable distortion. This same system has also been applied to the well known "250" tubes, which, in the circuit described in this article, will easily turn out 30 watts with a maximum total harmonic content of 5 per cent.

What determines the amount of power which can be supplied to the loads by any particular vacuum tube or arrangement of tubes? Let us neglect any consideration of the tube circuits and forget distortion for the moment. If we measure the power delivered to the plate circuit by the battery or rectifier system and then determine the amount of power delivered to the load circuit, there will

\* Sound Engineer, Silver-Marshall, Inc.

be a considerable difference between these two quantities. Some power always remains at the plate of the tube and is not available for the load circuit. This power appears as heat and raises the temperature of the plate structure in the familiar manner. The amount of power which can be dissipated safely by the plate is known as the maximum safe plate dissipation. Logically the ratio of the audio power in the load to the power supplied to the plate circuit, expressed in per cent., is known as the plate circuit efficiency. Thus, the power output of the tubes can be increased considerably as we increase the plate circuit efficiency, provided the maximum safe plate dissipation is not exceeded.

If we look at tube data for the 250 tube, we see that at maximum recommended plate voltage of 450, the plate current per tube is 55 ma. The product of plate voltage and plate current immediately gives us the plate dissipation (obviously all of this power stays at the plate) which is 24.8 watts or 25 watts in round numbers. This figure also happens to be the maximum safe plate dissipation as stated by the tube makers, which at once tells us why the limitation of 450 was placed on plate voltage; the tube insulation itself is adequate for much higher voltages. For conventional operation, it is a matter of experience that a pair of 250 tubes will turn out about 12 watts in push-pull. Assuming no increase in plate current, the power supplied in the plate circuit is 50 watts for two tubes. Thus the plate circuit efficiency is 12 divided by 50 times 100 or practically 24 per cent.

#### What is Meant by "Class A Prime."

The selection of the proper operating voltages and load impedance for the "Class A Prime" mode can now be considered. Evidently the choice must be based on both power and distortion determinations. The conventional attack on the problem consists of plotting a number of load lines on a family of plate voltage-plate (or grid voltage-plate current) current characteristics at successive operating points within the capabilities of the tube until a set of conditions has been determined which

results in maximum power without exceeding an arbitrarily imposed distortion limit. The method is exceedingly useful and practical when dealing with single tubes where the grid swing is necessarily restricted. The distortion in this case is largely second harmonic and is due almost entirely to non-linearity of the tube characteristic. With a pair of tubes in a symmetrical Class A circuit, however, there is nearly complete second harmonic cancellation in the plate circuit with the result that the useful power will be much more than that indicated by load-line calculations. On the other hand, we have another potential source of distortion in the high-efficiency type of circuit when the output tubes are swung into the grid-current region. This is due to the fact that the exciting voltage wave from the driver tube will have its peaks rounded-off somewhat on the portions of the cycle during which the output grids demand power even when

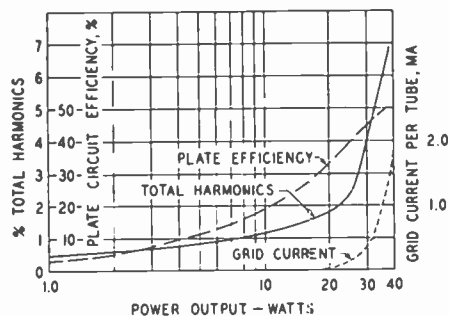

Fig. 2. Performance of Class A prime audio stage using 250 tubes.

the grid losses are small, as they are in the "Class A Prime" system. This is evident, since the currents abstracted from the driver tube must necessarily flow through the plate resistance of the tube and the windings of the interconnecting driver transformer. As a consequence it is essential to view the driver stage and the output stage as a unit when making performance determinations. The most satisfactory and direct method of design and analysis involves actual laboratory measurements of power output and harmonic content, supplemented by critical listening tests.

#### Choosing Constants.

Thus it is reasonable to select an ap-

plied plate voltage of 600—a figure which is perfectly safe from the insulation standpoint, and then determine the proper bias. The grid voltage we know must be sufficient to limit the plate current to a value corresponding to not more than 25 watts input per tube without excitation. This bias is approximately 130 volts. The value is only about 15% higher than would be the case if plate dissipation were entirely neglected.

#### The Circuit.

Figure 1 shows the circuit which is identical in appearance with the ordinary push-pull layout. The impedance reflected into the plate circuit by the output transformer is, as might be expected, quite high compared with the orthodox 8,000 ohms or so (about twice total tube impedance). From actual harmonic analyses and power measurements, the proper load proved to be 15,000 ohms, considered from plate to plate. The output transformer design was relatively easy (as contrasted with Class B) due to the fact that there is nearly complete balancing of direct plate current through the primary windings, thus avoiding air gaps. The driver transformer also deserves mention, as its design has an important bearing on the amount of distortion at maximum output. The windings are preferably of low resistance and low ratio, so that the total effective grid circuit resistance will be as low as possible. ONE 250 tube will

furnish ample grid swing for at least one "Class A Prime" output stage, at the same time complying with the requirement for low driver tube plate impedance. An ordinary push-pull '45 stage may be used instead, but in that case the type 10288 transformer must be replaced by a "Class B input" transformer and an additional plate supply source at about 275 volts becomes necessary. The '50 stage is simpler. Up to about six output stages of this type can be driven from any conventional amplifier ending in a pair of 250's.

#### Results.

Figure 2 shows the performance of the amplifier described. During tests the tubes were excited to an output of 37½ watts at which point the total harmonic distortion was only 7 per cent. The plate circuit efficiency at this output is 50 per cent. as compared with the 24 per cent. figure for conventional push-pull 250 tube. At the conservative rating of 30 watts, the total harmonic content is only 5 per cent. with a plate circuit efficiency of approximately 45 per cent. These figures were obtained on an experimental setup and it has since been found possible to reduce the stated distortion considerably. On the whole, the "Class A Prime" system, so-called because it combines high output power with the low distortion characteristic of all true Class A systems, appears to have outstanding points of superiority.



L. W. AUSTIN



# New Tubes—41, 42, 44, 55, 83, 85, 89

Once there was a time when a new tube happened very, very seldom, but that was before R. C. A. Radiotron down at Harrison, N. J., began to whiz. Now we are about three-fifths of a jump behind the tubes all the time.

## THE 55 TUBE, A "DUPLIX DIODE-TRIODE"

The 55 tube is a unique sort of a device. If a pentode is a 5-element tube then the 55 is a pentode—but that would be confusing, for this tube has only ONE grid and THREE plates! Astonishing combinations are possible. In Figure 1,

TYPICAL DUPLIX-DIODE TRIODE CIRCUITS WITH AUTOMATIC VOLUME CONTROL.

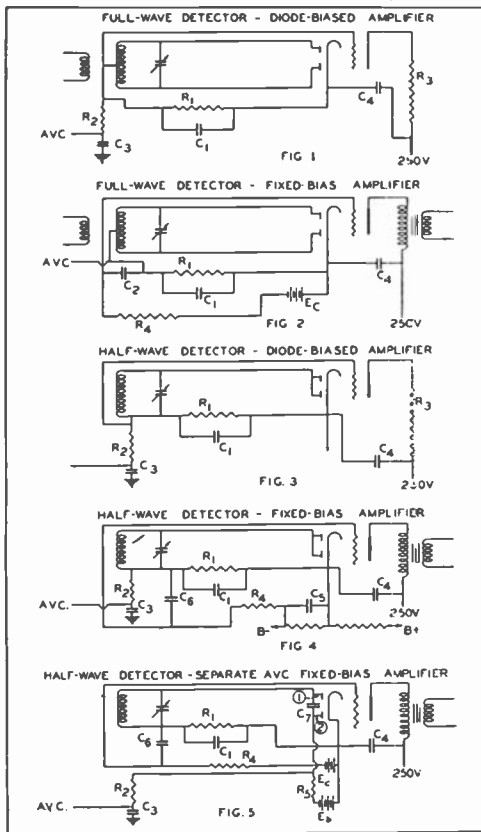

herewith, we have two of the plates used with the cathode as a push-pull diode

detector—in other words an r.f. rectifier working exactly as the 80 tube does at 60 cycles. The rectified output contains both audio and d.c. which flow through the ½ megohm resistor R1 whose by-

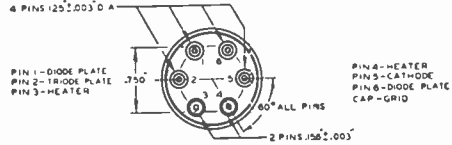

BOTTOM VIEW OF BASE

The base of the 55 is of the 6-pin type, with terminals as shown; the bulb is of the small "dome" sort used in the 57 and 58.

pass is about .00015  $\mu$  for broadcast frequencies or .006  $\mu$  for 175 kc. i.f. (second detector). The audio voltage across this resistor is accordingly in series with the grid and, therefore, the grid and the OTHER (the third) plate of the tube become an audio amplifier. The d.c. voltage across R1 not only provides the bias for this audio triode but at the same time can be fed back to the r.f. grids via the resistor R2 and condenser C3 (audio and r.f. filter) to provide automatic volume control. That's three jobs for one tube! The action should be compared with that of the Wunderlich tube described in a recent issue of "Modern Radio". R3 is an ordinary 100,000 ohm plate resistor used for coupling to the further audio amplifier that feeds the speaker. C4 is but a bypass.

In Figure 2 the bias of the audio system is differently provided, in Figure 3 the two r.f. plates are tied together for one-sided detection, while Figure 4 combines these schemes. In Figure 5 we use one of the r.f. plates for detection and the other for automatic volume control. C7 transfers the r.f. to the other plate. In Figure 2, R4 may be ½ megohm and C2 .01  $\mu$ . The other constants can be estimated from the tube constants and

from the a.v.c. articles in the past four issues of "Modern Radio".

### Constants of the 55 Duplex-Diode-Triode

Filament, 1 amp. at 2½ volts a.c. or d.c.  
 Terminals, grid at top, 6-pin base.  
 Plates:  
 Audio, 8 ma. at 250 volts.  
 R.F., ½ ma. maximum at 10 volts d. c.  
 Grid bias minus 20 volts.  
 Amplification factor 8.3 volts.  
 Power output (5% second harm.), 200 milliwatts.  
 Mutual conductance, 1,100 microhms.  
 Plate resistance, 20,000 ohms.  
 Cathode should be connected to center of heating transformer winding or heater biased negatively with respect to cathode to prevent hum.

### THE 85, ANOTHER DUPLEX-DIODE-TRIODE

The 85 is a 6.3 volt version of the 55, and also of the indirectly heated sort. The constants are as follows:

### Constants of the 85 Duplex-Diode-Triode

Filament, 0.3 amp. at 6.3 volts.  
 Plates: Audio 7 ma. at 250 volts.  
 Mutual conductance, 1,000 microhms.  
 Plate resistance, 8,300 ohms.  
 Everything else same as for 55 tube.

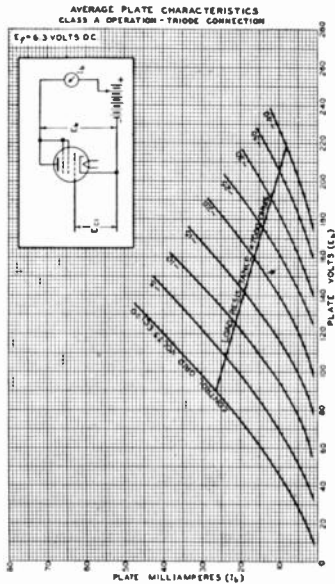

### The 89 as a Class A Triode (Distortionless Audio Amplifier)

Grids No. 2 and 3, tied to plate, input to grid No. 1.  
 Plate, 17 ma. at 160 volts.  
 Grid No. 1 biased minus 20.  
 Power output, 300 milliwatts.  
 Mutual conductance, 1,570 microhms.  
 Load resistance, 7,000 ohms.  
 Plate resistance, 3,000 ohms.  
 Load resistance when used to drive a Class B stage, 14,000 ohms.

Page Ten

### THE 89 TRIPLE-GRID TUBE

If anyone thought it was possible to have fun with the 46 convertible tube (Class A or B), there should be great joy at the sight of the 89 which can not only do these things, but is also perfectly willing to act as an output pentode and looks as if it would be a pretty decent screen-grid tube, a fair transmitting buffer—but this is too speculative and we must give the facts from the R. C. A. Radiotron release, in chart and data form.

It is not necessary to repeat the explanation of Class A, A-prime (see this

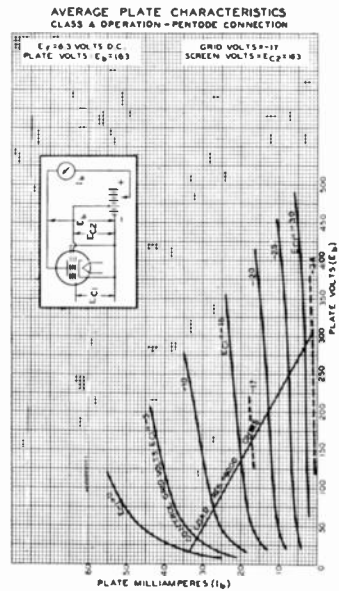

### The 89 as a Class A Pentode

Grid, No. 3 tied to cathode, No. 2 used as screen, No. 1 for input.  
 Plate, 17 ma. at 160 volts, 20 at 180.  
 Grid, No. 1 biased minus 18.  
 Power output, 1.25 to 1.5 watts.  
 Screen, 2.5 ma. at 163 or 3 ma. at 180 volts.  
 Mutual conductance, 1,600 microhms.  
 Load resistance, 8,000 to 9,000 ohms.  
 Plate resistance, 80,000 ohms.  
 Amplification factor, 125 at 163, 135 at 180 volts.

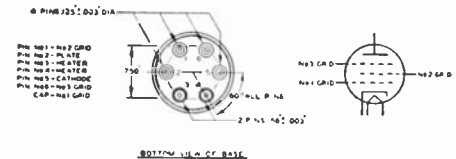

issue), B and pentode audio amplification here. Therefore, we give the con-



going back to the 5-volt filament used in the 80. The rectifier table, shown on the next page, will show how the larger emission thus provided permits a higher rating. The bulb is a new sort—a big brother to the domed 57 bulb.

---

## ARCTURUS TUBES

---

Arcturus has entered the transmitting tube field and is making the various 50 watt types under the designation E746, E711, E711E and 703A with a 4-support plate structure as shown herewith. The

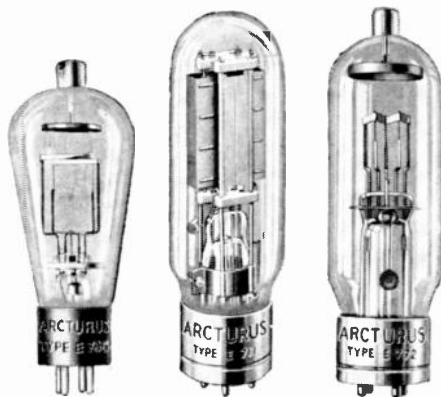

66 type of mercury-vapor-containing rectifier is also made under the designation of 766.

---

## PROPHECY

---

The latest '57 and '58 tubes are lined with a "carbon" (maybe) layer which prevents the accumulation of a charge on the glass and thus gets around a troublesome blocking action peculiar to the first of these tubes. Unfortunately it also damages the tube for 5 meter work. Thus we can quote from our May issue (page 2) "— and if the '57 and '58 are not as suitable for 5 meter work as we think—there will be another tube". Wait and see.

---

## UNRAVELED RADIOTRONS

By way of reducing the headaches, we here pass on some direct information from RCA as to which types of radiotrons are to be bought from what RCA branch.

*Page Twelve*

RCA Radiotron, Inc., sells to the trade the ordinary receiving tubes, including rectifiers and regulators. It also sells through the same routes the 210, 852, 865 and 866 tubes.

Other types of radiotrons bearing the RCA label are sold by the Engineering Products Division of the RCA-Victor Co. Details may be had by writing to Mr. A. H. Castor, RCA Victor Co., Inc., Camden, N. J. In general the types sold are the regular transmitting tubes and some special ones, all being sold direct to the customer under a limited sales agreement.

In addition, Radiomarine Corporation of America and RCA Photophone, Inc., supply some services in their fields on sales or lease basis. In some cases this, of course, covers sales of transmitting tubes.

Tungars, thyratrons, magnatrons, pliotrons, the FB-54 (see "Modern Radio", page 22, November), some photoelectric tubes, X-ray tubes, and some special industrial tubes are manufactured by the General Electric Co. and information on them is available through Mr. W. R. King, Industrial Control Department, General Electric Co., Schenectady, N. Y.

Finally, Westinghouse manufactures grid-low tubes, X-ray tubes, photoelectric cells and industrial tubes on which information is obtainable from Mr. J. K. Jayne, Commercial Section, Westinghouse Electric & Manufacturing Co., 150 Broadway, New York, N. Y.

Wow!

---

## FINE!

---

The R. C. A. Radiotron Handbook is so pleasantly different from advertising "handbooks", and so completely filled with absolutely necessary information, that every experimenter and engineer will find it thoroughly worth the \$3.50 for which it is offered by the Commercial Engineering Department of R. C. A. Radiotron, Harrison, N. J. The data and curves are vastly more complete than anything else we have seen, and a supplement keeps them so. Everything from a WD-11 to an 852 is there. Great!

# Comparison of Receiver and Transmitter Plate-Supply Rectifiers

Type Number	80	280M	82	83	81	R81	66	72 and R4	BA	BH
Half or Full Wave	Full	Full	Full	Full	½	½	½	½	Full	Full
Mercury Vapor	No	Yes	Yes	Yes	No	Yes	Yes	Yes	Gas	Gas
Filament Volts	5.0	5.0	2.5	5.0	7.5	7.5	2.5	5	None	None
Filament Amperes	2.0	2.0	3	3.0	1.25	.....	5.0	10	None	None
Max. R.M.S. Volts Per Plate	350 350**	600**	500	500	700	750			350	350
Max. Peak Inverse Volts	Does Not Matter	1,680**	1,400	1,400	Does Not Matter	1,960	7,500	7,500	.....	.....
Max. D.C. Load (Ma.)	135	200	125	250	85	150	.....	.....	350	125
Max. Peak Plate Current	.....	.....	400	800	.....	.....	600	2,500	.....	.....
Tube Voltage Drop	0 to 70	15	15	15	0 to 70*	15	15	15	0 to 200*	0 to 200*
Over All Length	5%*	5%*	4 1/2"	5 3/4"	6 1/4	6 1/4	6 5/8"	Same as	.....	.....
Max. Diameter	2 1/8"	2 1/8"	1 1/2"	2 1/8"	2 1/8"	2 1/8"	2 1/8"	as for	.....	.....
Bulb	S-17 Same as 10	S-17 Same as 10	S-14 Like 27 and 201A	ST-16 New Large Domed Type	S-19 Like 66	.....	S-19 Like 81	50 Watt Triodes	S-19 Like 66 and 81	S-14 Like 27 and 201A
Top Cap	No	No	No	No	Yes	.....	Yes	Yes	No	No

NOTE—The "B" tubes are known as "Raytheons", the "R" tubes as "Rectobulbs. An R3 Rectobulb is the same as R1 above but has a 10-volt filament.  
 \* Drop depends on load current.

\*\* When using this voltage the filter must begin with a choke, not a condenser.

Precautions—The mercury vapor tubes (280M, 82, 83, R81, 66, 72, R4) and the gaseous tubes (BA and BH) all create radio-frequency disturbances and the tube should be shielded (allow for ventilation) also r.f. chokes and small mica bypass (.005) provided ahead of the ripple-filter.

In no case exceed voltage or current ratings of mercury tubes. First filter condenser for these tubes should be 2 microfarad or less and preferably should be preceded by choke of at least 1 1/2 Henrys.

# Amateur Diamond Antennas

Directive antennas offer the amateur enormous advantages which cannot be obtained in any other way when attempting trans-continental or trans-oceanic transmission and reception. Unfortunately, the older sorts of directional antennas were such nightmares of complexity that few wished to build or adjust them.



AMATEUR DIAMOND ANTENNAS  
(Bracketed Dimensions in Meters, Others in Feet)

Center of Band (Meters)	Ratio of Directivity	Pole Height	Element Length (X)	Antenna Length (Y)	Antenna Width (Z)
40 (20 to 80).....	3 to 1	131 (40)	131 (40)	236 (72)	110 (34)
40 (20 to 80).....	7 to 1	131 (40)	262 (80)	472 (144)	220 (68)
40 (20 to 80).....	11 to 1	131 (40)	525 (160)	945 (288)	440 (136)
40 (20 to 80).....	15 to 1	131 (40)	1050 (320)	1890 (576)	880 (272)
All Below this Line Can Be Built for Amateur Use in Fairly Normal Locations.					
20 (10 to 40).....	3 to 1	66 (20)	66 (20)	117 (36)	55 (17)
20 (10 to 40).....	7 to 1	66 (20)	131 (40)	236 (72)	110 (34)
20 (10 to 40).....	11 to 1	66 (20)	262 (80)	472 (144)	220 (68)
20 (10 to 40).....	15 to 1	66 (20)	525 (160)	945 (288)	440 (136)
10 (5 to 20).....	3 to 1	33 (10)	33 (10)	60 (18)	28 (8.5)
10 (5 to 20).....	7 to 1	33 (10)	66 (20)	117 (36)	55 (17)
10 (5 to 20).....	11 to 1	33 (10)	131 (40)	236 (72)	110 (34)
10 (5 to 20).....	15 to 1	33 (10)	262 (80)	472 (144)	220 (68)
5 (2½ to 10).....	3 to 1	16½ (5)	16½ (5)	30 (9)	14 (4.3)
5 (2½ to 10).....	7 to 1	16½ (5)	33 (10)	60 (18)	28 (8.5)
5 (2½ to 10).....	11 to 1	16½ (5)	66 (20)	117 (36)	55 (17)
5 (2½ to 10).....	15 to 1	16½ (5)	131 (40)	236 (72)	110 (34)

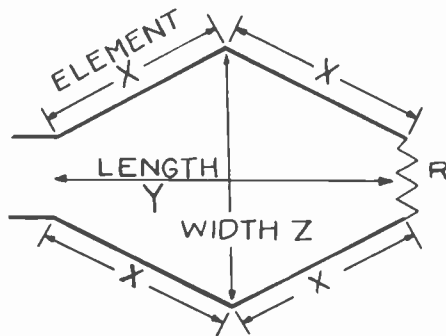

We are, therefore, pleased to offer data on the building and adjusting of a simplified form of the diamond-shaped antenna whose theory was outlined in our last two issues by Mr. Edmund Bruce of the Bell Telephone Laboratories. This antenna is very simple—and better than many of the complicated sorts. Try it and see.

It not only gives fine directionality, as in Figure 15, but is able to shoot upward at just the right elevation angle

(see Figure 16) to bounce the signal back down on to the distant receiver. The simplified method of adjustment is due to Mr. R. B. Bourne.

We will deliberately put the cart before the horse by first showing the antenna and then telling how it was calculated.

### Construction

The construction of the system is perfectly ordinary and normal. The insulation, the wire, and everything else can

be in accordance with ordinary short-wave practice, but the losses will be lower because the currents are smaller, and no standing-wave feed-line is used.

#### Wave Bands

As will be seen from the table of

can do. Suppose A is a simple oscillator using almost anything from a 201A to a 5-watter. It must be able to tune from half the wave the antenna is built for, to about twice that wave. This calls for a tuning condenser of about .0005, or else

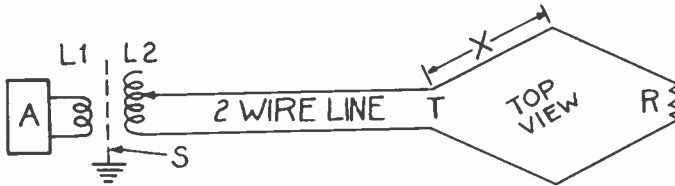

Fig. 10.

dimensions, the diamond antenna is not practical in the 40 meter band, but it is first rate in the 20 meter band, and there's a hopeful look about it for the 10 and 5 meter bands—especially as one built for 10 meters will work into both the 5 and 20 bands—and not be too large.

The simplified system is shown in Figure 10 and its direction of transmission or reception is off to the right. The feed line is shown in the same straight line with the antenna but that isn't at all necessary—simply easier to draw that way. The system works without change for either transmission or reception. The box "A" stands for any apparatus—receiver, transmitter or test oscillator.

Theoretically there should be an impedance-matching auto-transformer at T, but you can dodge it by simple flaring the feed wires apart gradually from a point about 10 feet from T. (With the sort of lines used at commercial stations the transformer is really necessary.) Furthermore the feed-line can be OF ANY LENGTH WHATEVER—you never even need to know how long it is.

#### Adjustment

The usual antenna is a resonant affair—but the diamond-shaped antenna is deliberately made non-resonant by means of R, in fact, its directional effect depends partly on just that. Incidentally, this has the nice advantage that the antenna is then equally good for from 1 to 2 octaves, as suggested before.

The value of R is around 600-700 ohms at radio frequencies. The correct value is found by a simple test which anyone

two sections of a broadcast tuning gang in parallel. The circuit may as well be Hartley, which is simple. No calibration is needed as long as the range is about right.

This oscillator is set up as in Figure 10, with the static screen S (described later) between L1 and L2. L2 can be anything for the moment, and the meter can be a thermo-milliammeter, or thermo-galvanometer (for once the trick

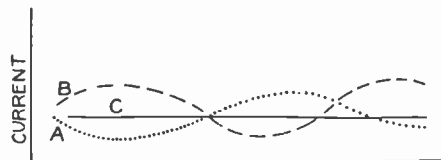

Fig. 11.

scale does no harm)—or even a flash-lamp or dial light. Set the oscillator at some place near center scale and adjust turns of L2 and distance separation from L1 to get a fair current indication. Now go out to the far end of the antenna and remove R altogether. This leaves a simple folded antenna which has the usual antenna resonances. Then when the oscillator knob is swung the meter (or lamp) will show rising and falling current as in Figure 11. This is wrong. Notice about where on the oscillator scale the currents are greatest and then shut down again and go out to the end of the antenna and short the ends together. And again watch the effect of the oscillator. The curve should have (nearly) turned over and be something like B of Figure 11—that is, bright

places where the current was lowest before. This is wrong, too.

Finally try R at some value that you think is correct and see if the current is steady as the oscillator is swung. If it isn't, try another value of R until it does stay put. Of course, the oscillator may be poorer at one end of its scale and, therefore, die down gradually—but there should be no “roller coaster bumps” as the knob is turned. It might not be a bad idea to check the oscillator by means of a single turn of wire and a lamp—while L2 is removed. The lamp should act much like the one in the antenna.

Now, then, we are rid of “standing waves” on both the antenna and the line; the power from the oscillator runs down the line, about half of it is radiated as it passes through the diamond-shaped antenna, and the rest is soaked up by

antenna with a tuned line of just such-and-such a length.

#### Static Screen S.

In Figure 10 the coupling between L1 and L2 must be purely magnetic, “static” coupling being prevented by the screen S. If L1 and L2 are “pancake coils” S is made by winding a layer of cotton-covered wire on a square sheet of cardboard, placing turns  $\frac{1}{8}$ ” apart and varnishing them down. When dry, solder the ground wire to all turns along one edge of the cardboard and cut each turn at the opposite edge, leaving a sort of comb.

If L1 and L2 are helices (cylindrical) S must be a cylinder pushed in between, and wound in the usual manner with the ground wire and the cutting running lengthwise on opposite sides. Better yet—wind through the cylinder lengthwise, then run the ground around

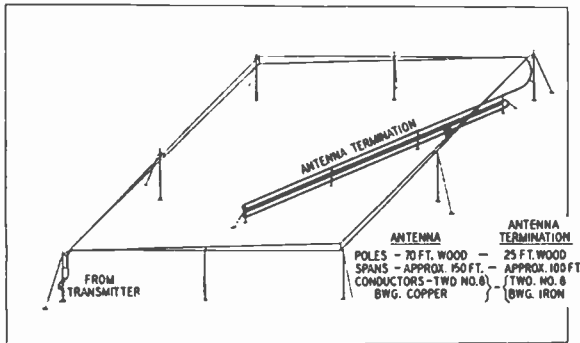

Fig. 12. A large commercial diamond antenna. In the amateur form the iron-wire “antenna termination” becomes a simple resistance as in Fig. 13.

R, and turned into heat. Don't mourn over the “wasted” watts, the remaining half is all headed toward the receiving station instead of being scattered all over the top side of the world.

#### Second Adjustment

It now remains only to get the best coupling to the line. If you are receiving this can be done by changing turns of L2 and distance between L1 and L2 while listening—or you may use an output meter on the receiver and work against some good steady signal.

For transmitting, one replaces the little meter with a bigger one and adjusts for the biggest current through the meter—that's all. Pretty simple compared to adjusting the usual amateur

one end (almost) and the cut around the other end.

The whole affair is now good for quite a long frequency range. In the table is shown one which is aimed at the 10 meter band and is workable in both the 20 and 5 meter band—with reasonable backyard or vacant lot dimensions. Of course, the popular belief is that “5” is good only for the neighborhood—but too little long-distance testing has been done with proper apparatus to make sure of just what is going on.

There is nothing the least bit speculative about the 20 meter possibilities—and you may now go out and try the tape line on the back yard, or stay with us for the mathematical part of the show.



# Designing the Diamond-Shaped Antenna for Amateurs

By Perry O. Briggs, Contributing Editor

In the two previous issues we have shown in theory the operation of a new and unique form of directive receiving antenna as expounded by Mr. E. Bruce of the Bell Telephone Laboratories. We

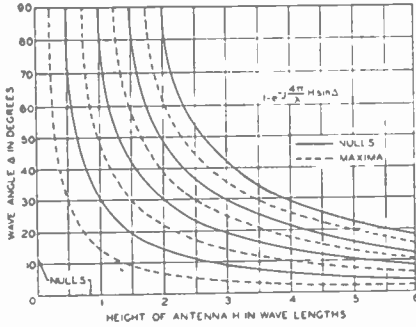

Fig. 13.

shall now endeavor to show how this type of antenna may be designed for amateur work. Although the application of this form of antenna to amateur use involves considerable work, some expense and a large place in which to maneuver, we feel that it opens up a new territory in the art of amateur design for both transmitting and receiving.

The following is abstracted from an article by Mr. Bruce in the August, 1931 Proceedings of the Institute of Radio Engineers:

As pointed out by Mr. Bruce, the general layout of the diamond-shaped antenna in its practical form is that indicated in Figure 12. That this form is most practical is readily seen in the following summary:

(a) The method of support is economical. It consists of four relatively short poles.

(b) The high angle directive characteristics of horizontal antennas discriminates against local noises originating near the ground.

(c) The directive qualities of the diamond-shaped antenna are sharpest in the plan of the antenna, and since the propagation of radio waves shows the greatest stability in the horizontal plane, it at once becomes evident that for best results, the plane of the antenna must

be horizontal.

(d) By altering the "tilt" angle Phi of the antenna, its directiveness may be aimed somewhat for optimum vertical angle.

(e) Greater signal stability, since the horizontally polarized wave component is less effected than the vertical by varying ground constants.

In the readjustment of the diamond-shaped antenna (it is necessary to determine four major factors:

1. Length of the element.
2. The angle Phi or "tilt" angle.
3. The height of the antenna above ground.
4. The terminating impedance.

Let us consider a case where the element length is an integral multiple of a half wavelength and the terminating resis-

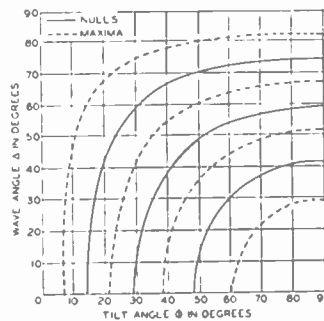
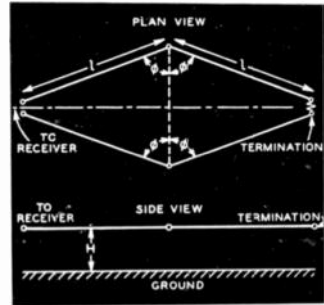

Fig. 14. The meaning of the "tilt angle" Phi, and its effect on the vertical directionality—angle of departure or arrival.

tance is the characteristic impedance of the system multiplied by the sine of the "tilt" angle. The characteristic equation of this setup is:

$$I_R = k [1 - e^{-j2\pi H \sin \Delta / \lambda}] \left[ \frac{1 + \cos \Delta}{1 - \sin^2 \phi \cos^2 \Delta} \right] [1 \pm e^{-j2\pi l \sin \phi \cos \Delta / \lambda}] \quad \text{Equation 1.}$$

H=Height above ground in wavelengths.

Delta=Wave angle from horizontal in the vertical plane.

Phi="Tilt" angle of elements.

l=Element length in wavelength.

k=Proportionality factor.

I sub R=Receiver current.

Lambda=Wavelength in meters.

In the plus or minus sign in the third bracketed quantity use minus when L is an even integral of Lambda/2 and plus when L is an odd integral multiple of Lambda/2.

Equation 2.

$$I_R = k' \left[ \frac{1 + \cos \beta}{\cos^2 \phi - \sin^2 \beta} \right] [1 \pm e^{-j2\pi l \sin (\phi + \beta) / \lambda}] \cdot [1 \pm e^{-j2\pi l \sin (\phi - \beta) / \lambda}]$$

Plotting wave angle Delta against height of antenna (H) for maxima and minima, as expressed in the first term of the above equation, we obtain a series of curves as indicated in Figure 13.

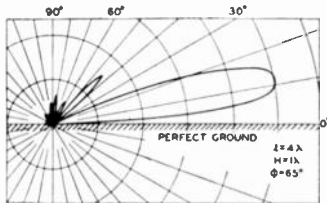

Fig. 15. Vertical Directivity.

Likewise plotting wave angle Delta against "tilt" angle Phi (for maxima and minima) as expressed by the product of the last two terms of the above equation, gives a series of curves as indicated in Figure 14.

From the above two sets of curves may be plotted the vertical directive labor of the proposed antenna.

Figures 13 and 14 are most useful in preventing errors in the plotting.

#### Horizontal Directivity.

It is of course desirable to know the horizontal distribution of the transmission or reception. For calculating this Mr. Bruce finds it practical to ignore ground effects and use the equation:

From measurements made over a long period of time, it has been determined that the angle of wave arrival in most cases is from 10 to 15 degrees from the horizontal.

Referring to Figure 13, it is noted that the optimum height H for a wave angle of 15 degrees is one wavelength.

Likewise referring to Figure 14, it is noted that the optimum "tilt" angle for this wave angle is 65 degrees.

It is desirable to use the largest angle of "tilt" possible in order to utilize the largest lobe of the directive diagram.

With the above mentioned dimensions, the directive diagram may be calculated and takes the form as indicated in Figure 15.

Beta=Wave angle (horizontal).

k'=Proportionality factor.

In the second and third bracketed quantities the plus-or-minus signs become negative when l is an even in-

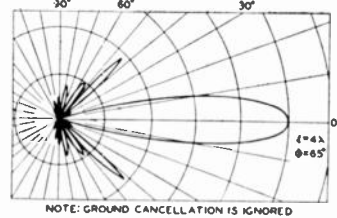
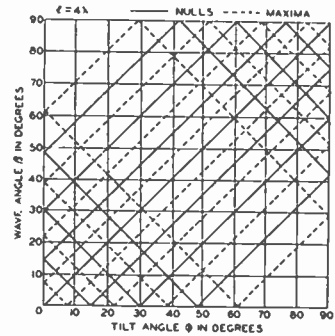

Figs. 16 and 17. Horizontal design chart and sample directionality curve.

tegral multiple of Lambda/2 and positive when l is an odd multiple of Lambda/2.

Working from this equation and Figure 16 one may then plot the horizontal directivity in the manner of Figure 17, which changes surprisingly little even when the frequency changes as much as 2-to-1.

# How to Use Cathode Ray Tubes—Part 3

By R. R. Batchert\*

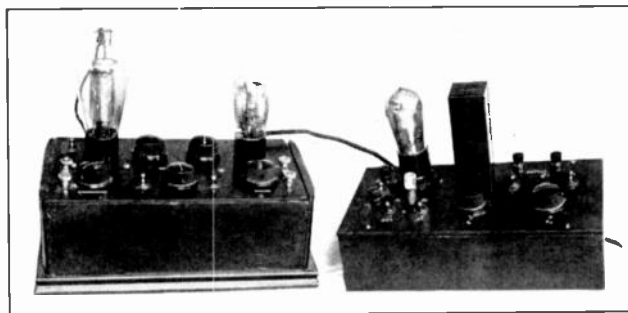

A pair of timing oscillators giving "saw tooth" output as in Figure 1. At the right is a neon oscillator of specialized type, at the left is the first form of extremely flexible thyatron oscillator described below. At the front, left to right, are the input posts (see Figure 3), a potentiometer across P1 and P2 (not used now), switch SA, synchroniz-

ing (or frequency control) potentiometer S, switch SB, "position" potentiometer P, and the output posts. In the rear row, SW2, the thyatron, a condenser switch (now omitted), the amplitude (and frequency) potentiometer R and the 27 ballast tube later replaced by a 24, as in Figure 3.

As previously explained considerable use can be made of cathode ray oscillograms in which two interrelated properties are compared. Such methods do not require a time base oscillator. However, many other tests require some sort of a timing circuit, and the problem will

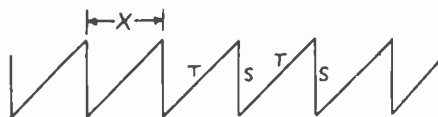

Figure 1. A "saw tooth" or snap-back timing wave. One cycle X consists of (1) a linear rise T during which the cathode ray is moved sidewise steadily. While the a.c. being studied vibrates the ray up and down, drawing a curve and (2) the "snap back" S during which the ray returns so fast as not to blur the curve.

be taken up where left off in the first (May) article. We are particularly interested in the "linear type" with the rapid "snap back", as shown in Figure 1.

This type of wave form is obtained with the usual neon lamp oscillator, Figure 2, with some types of multivibrator oscillators, with a dynatron oscillator with a resistance load, and with a certain form of "thyatron" circuit. Hundreds of articles have been published on

the neon lamp oscillator, but it is difficult with this device to secure sufficient amplitude of the output wave to swing the cathode ray more than an inch across the screen. Amplification can be added, but it is not a simple job, especially if the time base is to have a number of speeds. Probably the main merit of the neon-lamp oscillator is that the experimenter can set up such a circuit as in Figure 2 quite readily to become acquainted with the problem. A number of the neon lamps are available that may be used: The small neon night lamp such as G10; 874 regulator tube "Tunelite" (used for tuning adjustments on receiving sets); Raytheon type BH cold cathode rectifier tube, and others. The circuit Figure 2 is not very satisfactory

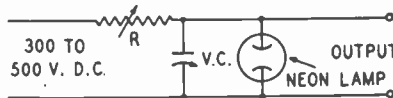

Figure 2. The ordinary neon oscillator. No constants can be given as much depends on the tube. The rheostat should range from 10,000 ohms up—the condenser may be a large air condenser. The output is limited.

for a time base oscillator but is an interesting one to use in studying its waveform.

The output of the thyatron oscillator is high enough and is satisfactory in

\* Consulting Engineer, 11335 198th St., St. Albans, Long Island, N. Y.



The frequency range, when unsynchronized, depends upon the amount of capacity in the plate circuit and the setting of S (also the setting of R). The setting of P shifts the location of the diagram on the screen.

The linearity of this oscillator (see May article) depends upon the output required. Unless the output required is



The G-10 neon bulb.

several hundred volts the waveform should be satisfactory. No resistances should be connected across the output terminals. The usual cathode ray tube deflection plates constitute an appreciable load and sometimes affect the linearity. It can be shown that this load

is somewhat unilateral (that is, the resistance across the plates is greater in one direction than in the other). Therefore, in making connections to the tube the leads should be reversed and linearity checked both ways. The capacity in the thyatron plate circuit should be high grade non-inductive condensers. Since the characteristics of small thyatrons, suitable for this circuit have not been generally standardized, it is not possible to give universal information as to the optimum adjustment. It might be mentioned that the exact center tap of the resistance across the thyatron filament must be used, or else the circuit might synchronize on 60 cycles or some sub-multiple.

Additional operating details and uses for this apparatus will be taken up in a future installment, together with a description of a complete portable cathode ray oscillograph.

The "General Radio Experimenter" for June, 1932, gives additional information regarding an outfit with similar characteristics known as the 506A Sweep Circuit.—Editor.

## "Temperature-Maintained" Crystals

By Howard F. Mason\*

A complete and accurately workable temperature control for the crystal of a low powered radio telephone or amateur installation is many times prohibitive in cost. These stations generally economize by using few intermediate amplifiers, and hence the crystal is operated at a rather high level which results in heating and frequency drift during the first part of the transmission period.

To date all efforts to minimize this frequency drift have centered on mounting the crystal in close association with a heavy bottom electrode plate and then attempting to hold the crystal temperature constant by stabilizing the temperature of the bottom plate. But when delicate thermostats, heaters, and relays are added they frequently constitute more sources of trouble, and heaven

knows the average transmitter is already too complicated anyway.

Any remedy would be better than a thermostat - heater - relay combination that does not work; and many of them do not, when installed where there is bad vibration, especially.

The scheme here proposed is to install a heater coil in close association with the bottom plate, and when the transmitter is turned off, turn the heater on. When the transmitter is on the crystal furnishes its own heat, so the heater can be turned off. If the crystal has the same number of watts heat loss as the heater; if the crystal cools down at the same rate as the heater becomes warm, and vice versa; if the heat is transferred from bottom plate to crystal and from crystal to bottom plate at the same rate; and lastly, if the whole is insulated from the effects of a varying ambient temper-

\* 1436 West 50th St., Seattle, Washington.

ature, within limits; then the device should hold the crystal at a fairly steady temperature. It is a nice problem in design figuring all this out, but amateurs won't be that critical, and can eliminate the temporary drift on starting transmission by making the heater dissipation something more or less than that of the crystal. This arrangement, of course, won't do when the crystal is being keyed. The crystal must run with an unvarying input and load.

Some automatic device is nice for turning the heater on, but connecting the heater across the receiver filament sup-

ply is O. K. While your tubes are warming up, so will the crystal. Auxiliary contacts on the carrier control relay can turn on and off the heater if it is a phone set. If a code set, connect the heater switch to open when you turn on the power to the transmitter.

Editor's Note. Mr. Mason, together with the Editor, copied the first crystal controlled message ever transmitted (from Newton Center, Mass., by H. S. Shaw). Since then Mr. Mason has used crystal control in amateur, broadcast and commercial work, also on two Wilkins Arctic expeditions and in Little America with Byrd. He has manufactured the crystal plates commercially—in short—knows about crystals under adverse conditions.

## Allied Arts

The "Allied Arts" page is herewith resumed as so many have requested. It will be back to full size and the regular style next month—too many new tubes this trip!

### A NEW ILLUMINOMETER

The Weston Electrical Instrument Corporation offers a new direct-reading illuminometer made possible by the photronic cell whose properties were explained on page 5 of our May issue. Reference to the curves in that article will show that the output of such a cell is directly proportional to the illumination in foot-candles, therefore it may be fed to a normal d.c. meter and when the combination is calibrated as a foot-candle meter an even scale will result.

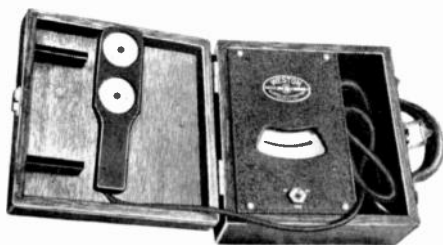

The Weston illuminometer. The paddle carrying the two photronic cells is provided with enough cord to permit convenient placement of the meter.

Only those who have done illumination surveys will appreciate the relief of being without batteries, sliders, calibrated lamps, or anything containing lenses and prisms. There are three scales on

the meter itself, permitting open figuring and close reading, especially as a mirror is provided below the needle to avoid the parallax so easily introduced when making hasty field-survey readings.



The three ranges are 0-10, 0-50 and 0-250 foot candles.

### A NEW LAMP CORD

The frayed lamp cord with the strands untwisted is to pass out at last in favor of the new rubber-jacketed type sketched here. The wires inside, as before are equivalent to No. 18 and are rubber insulated in just the same manner, but the individual strands of which they are



composed, are now No. 36 instead of No. 30, for greater flexibility. The grand improvement is in the jacket which isn't cotton or silk but of tremendously tough moulded rubber of a high grade with great strength, moisture proof, smooth and providing extra insulation. It is, of course a parallel pair cord, hence flat. The cover can be pushed back for making joints, but doesn't fall off.

## OUR AUGUST QUIZ-MATIC CONTEST

The amplifier diagram shown here will produce GOOD fidelity but LOW gain. That much as fact.

Now, then:

1. Why is the gain low? What ought to be done about it?
2. How will the amplifier misbehave on the usual B-sub?
3. What other changes would you recommend, and why?

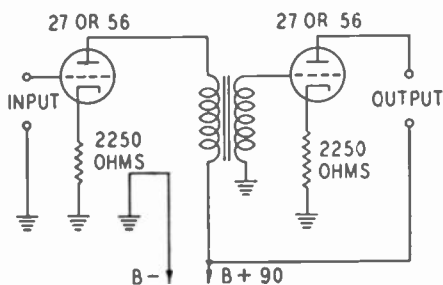

"Modern Radio" articles have answered these questions, but for the best answer received before our next issue closes we will give one year's subscription (or extension), also six months for each of the next four in rank. The editors do the judging, and may print the winning answer. Use diagram if you wish.

Another QUIZMATIC next month.

### NEW!

#### "MODERN RADIO ANNEX"

This Booklet contains:  
 "The Complete Reinartz \$2.85 Oscilloscope" Series  
 "How to Pass the New Radiophone Examination"  
 25c

At our Dealers or from  
**MODERN RADIO CO.**  
 Hartford, Conn.

## SHURE MODEL 5N

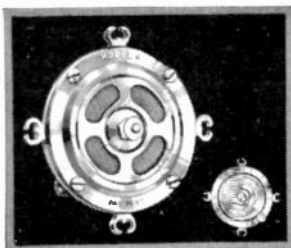

### 2-BUTTON MICROPHONE

FOR RADIOPHONE  
 FOR PUBLIC ADDRESS

The radio amateur may now have that clearness of reproduction of the speaking voice that makes it intelligible and easy to understand. Two buttons, push-pull microphonic action —no "squawk" or harshness. Very sensitive. Operates best at 6 to 8 M.A. per button. Resistance: 200 ohms per button. Highly nickel plated. One-year guarantee. **\$5.88**  
 No. 5N. Code: RUFAL.  
 List Price, \$10.00. Your Net Price

W9AFN Writes: " This model performed to every expectation. As a comparison other higher priced types of microphones were used. When listeners were asked for reports on quality of speech there was no noted difference and several said your unit seemed to give more natural reproduction. Sensitivity is excellent while still damped to the correct degree "

(Signed) P. B. Lovegren.

Write for our new free catalog of microphones (types to \$250.00), stands, cables, and other microphone accessories. Mention your call letters and name your jobber.

### SHURE BROTHERS COMPANY

Manufacturers - Engineers  
 S. N. SHURE, Pres.  
 337 WEST MADISON ST. CHICAGO, ILLINOIS

#### INTRODUCTORY FREE OFFER

\$1.00 6 Foot Microphone Cable Free if you enclose this coupon with your order.

SHURE BROTHERS COMPANY,  
 337 W. Madison St., Chicago, Ill.

Enclosed find \$5.88. Rush one of the new Shure Model 5N 2-Button Microphones and include the FREE 6-foot microphone cable (List Price, \$1.00) which you are including at no extra charge to readers of the August issue of "Modern Radio".

Name .....  
 Address .....  
 City ..... State .....  
 Name of Jobber .....

## TRIMM FEATHERWEIGHT EARPHONES



### SERVICEMEN, ATTENTION!

The Depression is over! The Hard of Hearing are demanding Earphones in Churches, Theatres, Lodges, etc. Unusually large profits made now before competition increases.

The TRIMM FEATHERWEIGHT phone with the Lorgnette handle is the best phone you can secure. Satisfaction Guaranteed or Money Back. Write for information.

TRIMM RADIO MANUFACTURING CO.,  
Earphone Specialists

Headphone Specialists

1528-38 Armitage Avenue Chicago, Ill.  
Western Representative, Don C. Wallace,  
4214 Country Club Drive, Long Beach, Cal.

## TEMPERATURE CONTROL

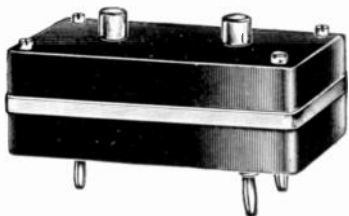

### DUPLEX CRYSTAL OVEN HOLDS TWO CRYSTALS

1° Variation—Ideal for  
Amateur Use

LIST PRICE—ONLY \$19.50

Amateurs write for special prices.

Dealers and Distributors Wanted

Factory Sales Representative  
DON C. WALLACE, W6AM-W6ZZA

WESTERN WIRELESS, Ltd.

95 Minna Street  
San Francisco, Calif.

## BINDERS

FOR MODERN RADIO

HOLDS 12 COPIES

*Each Copy Removable Alone  
No Perforating, No Mutilation  
Installation Without Tools  
Removal Easy, Ruggedly Made  
Finished in Leatherette  
Durable, Beautiful  
Protects the Magazines*

MODERN RADIO CO.

**\$1.95** each

The surest way to tell plants from weeds is to pull them all up. Those that grow again are weeds.—“Montreal Star”.

## CODE PRACTICE DEVICE

Bud Radio, Inc., of Cleveland, Ohio, offers an ingenious device which may be attached to any broadcast or other radio receiver with a push-pull output stage. Two wafer connectors are put under the tubes and their leads connected to a key.



Whenever the key is pressed a clear tone is emitted by the speaker of the set. The device includes a key which may be used as a straight key or turned on its side and used as a “side swiper”. Nice!

## NEW MIKES

Shure Brothers Co. of 337 West Madison Street, Chicago, is offering a new small two-button microphone of the non-stretched diaphragm type, known as type 5N, and priced at \$10, with a year's guarantee provided the device is not



mishandled. As shown in the photograph, the suspension is by means of quick-demounting hooks. Ample binding posts are provided. The normal operating current is 6-8 ma. per button, each of which has a resistance of 200 ohms. The device is neatly finished in nickel.



## Editorial

### The Sea Is Still Salty.

As the International Conference on radio at Madrid approaches there is apparent a tendency to confuse the radio problems of Europe with those of the two Americas, and to wander into the strange error that there must be uniformity between them.

The Atlantic, however, has not yet become a mill-pond. It is still an adult ocean and ridiculously little of either amateur or broadcast radio ever crosses it—despite all the hysterical news that's printed.

The American nations—whether they speak Portuguese, Spanish or English—have long tacitly recognized this by dealing liberally with the broadcaster and the amateur, while Europe has invented high-licenses, government ownership and outright suppression.

Let us hope that the delegates of the Americas remember that they are to represent the interests of the Western World, that their countries find it quite practical to determine their own needs and that it is a poor sort of loyalty to subserve those local needs to European local opinions, under which radio has lagged so painfully.

The stout old Monroe Doctrine, which has saved us so many woes, may serve well in radio—and the Atlantic is still there to substantiate it.



## Look!

We are about to let you in on:  
**A NEW MODULATOR**  
**A NEW IDEA IN TANKS**  
**A FIVE-METER DEVELOPMENT**  
 also  
**SOME REAL RECEIVER NEWS**  
 and a really simple  
**CATHODE RAY OSCILLOGRAPH**  
**WITH LOTS OF USES**  
**A REAL SHORT WAVE DESIGN**  
**CHART**  
**BETTER THAN BREAK-IN**

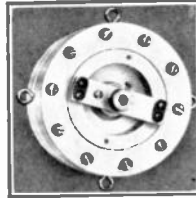

# A1

The finest double button microphone made. The diaphragm is of special duralumin .002 inch in thickness with pure gold-plated spots at each granule contact surface.  $3\frac{1}{2}$  inches in diameter and  $\frac{3}{4}$  inch thick. Frequency response 30 to 7,500 cycles. Polished nickel finish and beautiful design. This transmitter is comparable in fidelity to a condenser head. Fully guaranteed. Send for catalog on this and condenser microphones.

Usual Distributor and Dealer Discounts.

**THE AMERICAN MICROPHONE CO.**  
 253 WEST 58TH STREET  
 LOS ANGELES, CAL.

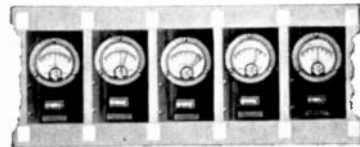

## SAFE vs SORRY

- The High Speed Motion Picture Camera shows this 30-0-30 Galvanometer with and without Littelfuse protection on a 1.5 volt D.C. short.
- Instrument Littelfuses are made in 1/100, 1/32, 1/16, 1/8, 1/4, 3/8, 1/2, 3/4, 1, and 2 amp. to protect any meter. Also made in the above rating from 1/16 amp. up in 1,000, 5,000, and 10,000 volt ranges to protect broadcast equipment.
- Your dealer or jobber has them or can get them for you. Write for folder "Littelfuse Goes to Hollywood" and Littelfuse catalog.

"QUICKER THAN A SHORT CIRCUIT"

**Littelfuse Laboratories**  
 1760 Wilson Ave., Chicago, Ill.

## FIVE-METER EQUIPMENT

A unique, and very interesting, 5-meter amateur transmitter is offered by the Radio Engineering Laboratories (Long Island City). The push-pull oscillator is contained in a cubical cast aluminum case about 6 inches on a side

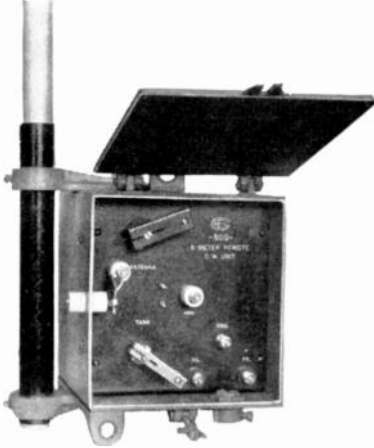

and carrying a  $\frac{1}{2}$  wave tubular antenna. It is intended to be installed in a "high and clear" location, either screwed fast or suspended by a halyard. A hoisting ring is provided. The set is tuned when 8 feet off the ground, then the rubber-gasketed door is clamped shut and the set goes aloft, trailing the 4-wire weather-proof cable through which it receives plate and filament supply from

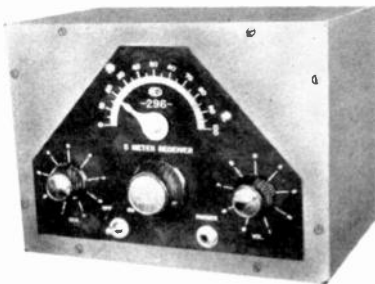

the operating room. Two tubes of any UX base type may be used. Obviously the plate supply may be modulated down in the station by either a key of an audio amplifier, hence either c.w. or voice transmission is possible. A suitable audio system is sold under the designation of "Cat. 301" modulator. If the outdoor unit uses a pair of 45 oscillators,

the 301 unit employs a pair of 47 pentodes as audio tubes (modulators). Even smaller tubes may be used in both units. The 301 audio unit weighs 11 pounds in its gray metal case which measures 13" x 7 $\frac{1}{4}$ " x 6". The price is \$25.50.

A receiver as a companion piece is the No. 296, 5-meter receiver which employs a pair of 37 triodes and a 38 pentode. A 6-volt battery and 135-volt plate supply are required. The case is uniform with the 301 unit and measures 9 $\frac{1}{2}$ " x 7 $\frac{1}{4}$ " x 6". The set weighs 9 pounds and costs \$20.50.

### Important Announcement!

#### MODERN RADIO'S RADIO-MAN'S QUICK REFERENCE POCKET BOOK

Due to unsuspected demand—and requests of buyers—the Pocket Book's publication has been postponed to permit increase in size and greater scope. The book has been replanned for new additions, a bigger value than ever.

Ready September 1st  
25c per copy, post-paid.

MODERN RADIO COMPANY  
101 Allyn Street, Hartford, Conn.

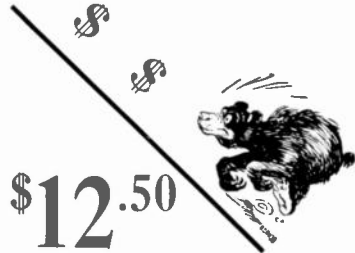

*The Depression Bear  
never chased the dollar to  
a higher buying peak. For  
only \$12.50 you can now  
get the famous*

## Gavitt Star

Double-Button Microphone  
Model C

GAVITT MFG. CO., Inc.  
Brookfield, Mass.

See "Modern Radio", April, page 30,  
for details.

## WRONG!

The Volunteer Communication Reserve of the Ninth Naval District publishes a mimeoed monthly which is always worth reading. The editors are Lieutenant Commander F. H. Schnell, C-V(S), U. S. N. R. and Ensign J. C. McManus, C-V(S), U. S. N. R., and the cartoonist is Don Hoffman. The cryptanalysis pages are beyond us but we like the editorials, the "Bally-Hooey" burlesques and the technical kinks. As we understand it, one subscribes by writing to Lieutenant Commander Schnell and asking for instructions as to enlistment.

On page 29 of July "Modern Radio" we reprinted a Don Mix cartoon from "QRX" and said the paper was due to the Fifth Naval District.

## ALL-PORCELAIN RHEOSTATS

The Ohmite Manufacturing Co., Chicago, offers a new line of rheostats in which the resistance wire is wound on porcelain and sealed into place with a vitreous enamel. This avoids the swelling and shrinking common to fibrous cores, also permits higher ratings. The

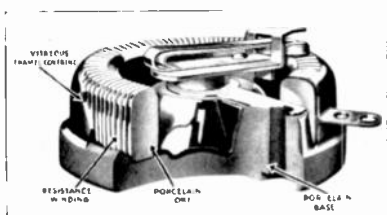

rotary type shown is obtainable in resistances of 1 to 35,000 ohms and with ratings 50 watts (diameter 2 1/4") and 150 watts (diameter 4"), with the full winding in circuit. There is also a tubular semi-variable resistor in 30, 55 and 75 watt sizes up to 50,000 ohms.

## Advertising and Subscription Representatives

CALIFORNIA, WASHINGTON and OREGON  
DON C. WALLACE  
4212 Country Club Drive, Long Beach, Calif.  
NEW ENGLAND  
R. T. PERRON  
32 Broadway, Providence, R. I.  
NEW YORK CITY, also NEW JERSEY,  
RALPH R. BATCHER  
11335 198th St., St. Albans, Long Island  
PENNSYLVANIA, and DELAWARE  
W. L. MARR  
Bourse Building, Philadelphia

## NEW SHALLCROSS PRODUCTS

The Shallcross Manufacturing Company is shortly to offer a cathode ray oscillograph for the measurement of spark voltages, a new capacity bridge, the parts of a student's Wheatstone bridge and of a set analyzer. Watch for them in "Modern Radio".

## EASTERN CRYSTAL HOLDERS

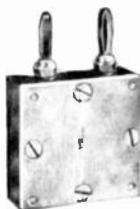

—have been designed for crystals from 1/5 to six mm. thick (20-600 meters)

TYPE A—for 1 inch crystals.

TYPE B—for crystals up to 1 1/8 inch.

A very important feature of the EASTERN holder is its perfectly lapped plates which is essential for proper

performance of the crystal stage. Despite its perfect quality and workmanship, it is popularly priced.

To be sure of getting an EASTERN holder, write for name of dealer nearest you or order direct.

Dealer Inquiries Solicited.

Price Each—\$2.50

## EASTERN COIL CO.

56 Christopher Ave., Brooklyn, N. Y.

## "MODERN RADIO'S" ANSWER FACTORY

How?—What?—Why?—Who?—When?

A—Letter with one question . . . . . \$ .50

No charge for small incidental pencil sketches.

B—Additional questions, each . . . . . .25

C—Schematic diagrams of battery-driven receivers up to 6 tubes, transmitters up to 5 tubes, antennas (other than beam types), switching schemes, metering, and power circuits of reasonable simplicity . . . . .75

D—Matters such as given under C, where all constants are desired . . . . .2.00

E—a.c. or d.c. socket-power receiver circuits without constants . . . . .1.50

F—Same as E but with all constants 3.00

G—Transmitter diagrams of greater complexity, bibliographies, operating instructions, analysis of complex operating difficulties in apparatus, and other questions not covered by the above will be estimated on receipt of a clear and complete statement of the problem.

### NOTES

1. Keep a copy of your letter, including diagrams, numbering questions 1, 2, 3, 4 and lettering diagrams a, b, c, d.

2. The right is reserved to return remittances for any questions which it is impossible to answer.

3. No attention will be paid to radiograms, telegrams or letters (other than those under class G) which are not accompanied by a remittance. Please use money order—loose cash may not arrive.

4. Address letters, "Modern Radio", 101 Allyn Street, Hartford, Connecticut.

# Short Circuits

The pleasantest story we have read for a long time related to an afternoon in the Sudan, with a temperature of 125 degrees.

Honestly now—can you name all the type numbers of the year's crop of vacuum tubes, tell what each one is—and be right?

We recently heard a United States senator lay a corner stone—a mason doing the actual work. The eagle was just beginning to soar into the blue sky of unlimited possibilities when it started to rain—and the Hon. got through in one sentence. How about a few sprinkler heads in the senate chamber ceiling?

With Bolivia and Paraguay making faces at each other, conditions may be regarded as about normal for South America.—“Christian Science Monitor.”

If this is a land of opportunity, what of France, where every little boy has a chance to grow up and be premier from five to fourteen times?

—“Des Moines Tribune.”

Are you old enough to remember when everyone used a head set and it was a great joke to fake a bum connection by putting a June bug in one of the “cans”? A cockroach was better, but none of you are supposed to know what a cockroach is.

There is only one reason for buying the best: The ability to recognize it.

## POWER RESISTORS

*Small . . . Compact,  
of high wattage capacity*

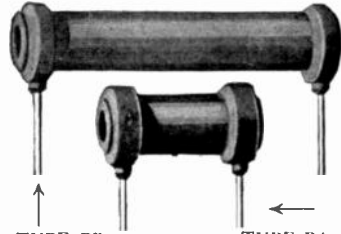

TYPE PB  
Power Wire Wound  
Resistor, 5 Watts  
(max.)

TYPE PA  
Power Wire Wound  
Resistor, 3 Watts  
(max.)

It is no longer necessary to use cumbersome, high-voltage wire wound units to take care of a 3-watt or 5-watt load. New I. R. C. Resistors of these capacities are now provided. Equipped with the new exclusive I. R. C. moulded contact. The two types sell for the same price. ALL RANGES. Ask your jobber or write for information.

International Resistance Co.  
Philadelphia, Pa. Toronto, Ont.

**IRC Metallized**

and Precision Wire Wound Resistors

## RALPH R. BATCHER

Radio Engineering Consultant  
Radio Receiver Designs, Testing and  
Laboratory Equipment, Special  
Apparatus and Models Developed  
Member I. R. E.  
113-35 198th St., St. Albans, L. I.

## ADVERTISING RATES

### MODERN RADIO

PAGE	\$25.00
½ PAGE	15.00
¼ PAGE	10.00
⅛ PAGE	6.50

RATE CARD ON REQUEST

Page Twenty-Eight

## UNIVERSAL BULLET TYPE MICROPHONES

Carbon Granule Type With  
Hiss Eliminating Filter.



A new Universal product designed to give the public address man the ultimate in appearance and proved UNIVERSAL performance at very reasonable cost. Elegant design. Rugged Construction. Special adjustment screw for adjusting microphone to varying acoustic conditions. Hiss level far below background noises encountered. Finished in highly polished Aluminum Chrome Plate. Available in Models BB, KK and LL.

UNIVERSAL MICROPHONE CO. Ltd.  
424 Warren Lane Inglewood, Cal., U. S. A.



# Crystals

*Precision ground, powerful oscillators*

UNCONDITIONALLY GUARANTEED

**AMATEUR CRYSTALS**  
 80 and 160 meter bands "X"  
 or "Y" cut—stated calibration  
 guaranteed accurate to  
 1/10 of 1% or better and  
 adjusted to within:  
 5 kc. of frequency specified \$ 7.50  
 1/2 of 1% of frequency speci-  
 fied . . . . . 6.50  
 Within 1% of frequency  
 specified . . . . . 5.50  
 40 meter band adjusted to with-  
 in plus or minus 1% of  
 specified frequency . . . . . 10.00  
 1-inch oscillating blanks . . . . . 3.00  
 Unfinished blanks . . . . . 2.00  
 Dustproof holders, with nickel-  
 silver electrodes . . . . . 2.50

175 kc. Stenode Crystals . . . . \$ 3.50  
 High or low frequency Crystals of all  
 descriptions made to order.

**TOURMALINE CRYSTALS** and  
**BLANKS** for frequencies up to 15  
 Megacycles—quotation on request.

**BROADCAST CRYSTALS**  
 Complete with Holder—Special. \$42.00  
 Ground close enough to insure quick  
 adjustment to within 50 cycles of assigned  
 frequency by varying the operating tem-  
 perature between 45 and 55 degrees  
 centigrade. Prompt shipment.

*We Solicit Your Inquiries*

**Premier Crystal Laboratories, Inc.**

72 CORTLANDT STREET NEW YORK CITY

## KRUSE! PHELPS! BATCHER! HATRY!—

Four well-known engineers, edit this "Modern Radio" magazine, make it the accurate, helpful and informative sheet it is.

Shorn of padding, concise in treatment, "Modern Radio" is as modern as its name. The busy man finds this compact, easily read, and well-filled journal the answer to his needs. Easy to carry, easy to read and of exceptional reliability, "Modern Radio" is the answer to your need for a magazine that gives a lot for a little time from its reader.

Full of news because the lack of "blah" gives space for facts. You can't afford to be without "Modern Radio". Pin two \$1 bills to the coupon, write your name and address and mail it now. Get real radio pleasure from the next 12 months.

PIN  
HERE

I am tired of padded articles. I like "Modern Radio's" concise, snappy style. I like the tremendous amount of information you get into small space. In fact, I even like the man-sized coupon I filled in and pinned \$2 to for one year of "Modern Radio" starting . . . . .

My Name . . . . .

Address . . . . .

Manufacturers of  
**RF Inductance Coils, Chokes**  
**J. W. MILLER COMPANY**  
 517 So. Main St., Los Angeles, Calif.  
 Uniformly Accurate—Quick Service  
 Standard and Special Types  
 We are now appointing a few  
 Manufacturers Agents, and Distributors.  
 Quotations to manufacturers gladly given.

**WHERE TO BUY  
 "MODERN RADIO"**

**ARIZONA**  
 Nielsen Radio & Sporting Goods Co., Phoenix

**CALIFORNIA**  
 Associated Radio Buyers, Oakland  
 Coast Electric Co., San Diego  
 I. S. Cohen's Sons, Inc., San Francisco  
 El Cajon Radio Exchange, San Diego  
 Electric Supply Co., Oakland  
 High Frequency Engineering Lab., Los Angeles  
 Inter-City Radio Stores Co., Long Beach  
 Offenbach Electric Co., San Francisco  
 Pacific Wholesale Radio, Los Angeles  
 Radio Doc., Los Angeles  
 Radio Exchange, Inc., Los Angeles  
 Radio Manufacturer's Supply Co., Los Angeles  
 Radio Supply Co., Los Angeles  
 Warner Bros., San Francisco  
 Wenger-Brill Co., Oakland  
 Western Wholesale Radio, Inc., Los Angeles  
 Zach Radio Supply Co., San Francisco

**CONNECTICUT**  
 Hatry & Young, Inc., Hartford  
 S. S. Kresge Co., New Haven

**ILLINOIS**  
 Abbott's Sweet Shoppe, Berwyn  
 Chicago Radio Apparatus Co., Chicago

**MARYLAND**  
 Radio Electric Service Co., Inc., Baltimore

**MASSACHUSETTS**  
 Ben's Tremont Electric Supply Co., Boston  
 T. F. Cushing, Springfield  
 Neisner Bros., Boston  
 Sager Electrical Supply Co., Boston

**MICHIGAN**  
 Radio Specialties Co., Detroit

**MINNESOTA**  
 Lew Bonn Co., St. Paul

**NEW JERSEY**  
 Kaltman & Kennyhertz, Newark

**NEW YORK**  
 Blan, the Radio Man, Inc., New York City  
 Jerry's Place, New York City  
 Leeds Radio, New York City  
 Maurice Schwartz & Son, Schenectady  
 Roy C. Stage, Syracuse  
 Sun Radio, New York City

**OREGON**  
 Johnson & Weller, Portland  
 Northwest Radio Supply Co., Inc., Portland  
 Wedel Co., Inc., Portland

**PENNSYLVANIA**  
 Hall's, Harrisburg  
 M. & H. Sporting Goods Co., Philadelphia  
 Radio Electric Service Co., Inc., Philadelphia

**WASHINGTON**  
 Spokane Radio, Inc., Spokane  
 Wedel Co., Inc., Seattle

**FOREIGN**  
 R. C. O'Connor, Tearo Book Depot, Wellington,  
 New Zealand  
 McGill's, Melbourne, Australia

MORE NEXT MONTH

*Page Thirty*

**BLILEY / Quartz and  
 CRYSTALS / Tourmaline**

Nationally recognized for their high standard of quality.

A power-type crystal scientifically manufactured and accurately calibrated in the 160, 80, 40, 20, 10 and 5 meter amateur bands. Available from your dealer at \$5.50 and up.

Crystals also manufactured to any precision and frequency requirements from .0 Kcs to 75 Mcs. Write for quotations.

**BLILEY PIEZO-ELECTRIC COMPANY**  
 Masonic Temple Bldg., Erie, Pa.

**ROBERT S. KRUSE, E. E.  
 RADIO ENGINEERING SERVICE**

Transmitter Improvements, Special Receivers,  
 Measuring Devices, Radio Equipment Designed  
 and Constructed.

103 Meadowbrook Rd., West Hartford, Conn.  
 Tel. Hfd. 45327

**THE BAZAAR**

Please abide by these rules:

1. 5c per word, payment with ad.
2. Ads for an issue must reach us the first of the preceding month.
3. Used, reclaimed or surplus items must be so described.
4. Please PRINT your name and address.
5. We reserve the right to refuse any part of an ad.
6. Ads designed to stand out cost extra. 7c a word all capitals, \$2.00 an inch for unfilled space.

SPEED TUBE HEADQUARTERS FOR SOUTH-  
 ERN CALIFORNIA, WESTERN WHOLESALE  
 RADIO CO., 1224 WALL ST., LOS ANGELES.  
 RProspect 0450.

"Modern Radio" back copies: A few November, December, 25 cents each; February, March and April, 20 cents each. Issues include Batcher's Perpetual Triode Chart, Progress in Converters, Painless Mathematician, Improved Anti-Noise Aerial, Stability Without Crystal, Super-Het First Detector Regeneration, Modulating Tetrodes, Making Output Meters, 500 Watts Direct from Crystal, Seeing Power Factor, Electrolytic Condenser Tester. For each January issue returned your subscription will be extended one month. "Modern Radio", Hartford.

Service work becomes more complicated. J. F. Furey has added a 20-gauge shotgun to his kit since a pair of hawks disapproved a plan for putting an antenna near their nest.

# More Than A Guarantee

## DISTRIBUTORS OF

Cardwell, Eveready,  
Electrad, Eby,  
R. E. L. National,  
Yaxley, Pilot,  
I. R. C., Littelfuse,  
Tung-sol Tubes,  
Weston, Jewell,

Thordarson,  
Insuline, Gavitt,  
Readrite, Bakelite,  
Bliley Crystals,  
Wright-DeCoster,  
Odeon, Aerovox,  
Ward-Leonard,  
Centralab, Frost,  
Trimm, Supreme  
Test Kits, Keys,  
Bugs, Buzzers,  
Relays, Chokes,  
Stancor Transformers.

Order It,  
We Have It.

More than a guarantee goes with new, standard merchandise. Behind it is the experience of years of performance and reliability. Guarantees protect one when defects require replacement. But replacement does not repay for lost time, inconvenience, extra work and poor performance. Behind every item Hatry & Young sells is H. & Y. experiment, test and experience. Used or surplus items of unknown reliability are not sold.

**Hatry & Young**  
203 Ann St., Hartford, Conn.



## SERVICE MEN

*Everywhere Praise*

## THIS BOOK

*Ask to see one*

A PERPETUAL GUIDE to correct resistor and volume control values—with diagrams, charts, set specifications and other valuable data.

Prepared by authoritative engineers and published by Electrad as a service to service men.

Loose-leaf pages, genuine Fabrikoid flexible cover. *Kept up to date by supplements four times a year.*

A small dollar investment that pays BIG dividends.

ELECTRAD, INC., 175 Varick St., New York.

Enclosed \$ \_\_\_\_\_ (check, currency or M. O.)  
for \_\_\_\_\_ copies and supplements (as published)  
of RESISTOR REPLACEMENT HAND BOOK,  
at \$1.00 per copy.

Name \_\_\_\_\_

Address \_\_\_\_\_

*Mail the  
Coupon*

175 Varick Street, New York

**ELECTRAD**  
INC

MR-8

*Page Thirty-One*

# "CONTROLLED SELECTIVITY" plus the New Short-Wave R. F. Pentodes-

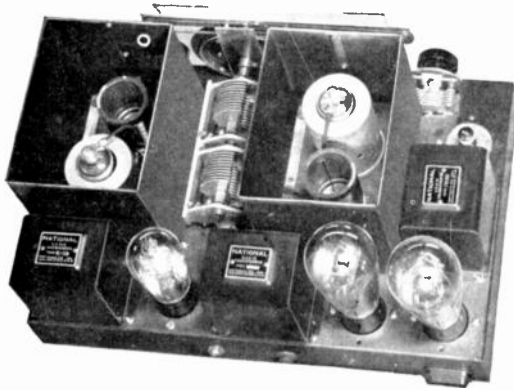

Result in performance surpassing even the high standards set by the NATIONAL SW-5 and SW-45 THRILL BOXES. The NEW SW-58 has an EVEN HIGHER SIGNAL-TO-NOISE-RATIO—higher than any other commercially available receiver.

If you require **UTMOST SENSITIVITY, EXTREMELY LOW BACKGROUND NOISE** combined with **UNEQUALLED FLEXIBILITY** and **EASE OF CONTROL**, the new NATIONAL SW-58 THRILL BOX is outstandingly in a class by itself. The TRF circuit is employed because of its definitely lower background noise, long recognized by experimenters, amateurs and professionals engaged in serious communications work. But the SW-58 offers a number of improved features, never before found in a short wave TRF receiver.

## GREAT R.F. GAIN, REAL R.F. SELECTIVITY WITH THE NEW 58 TUBES

The high mutual conductance and low output capacity of the new SHORT WAVE R.F. PENTODE 58 tubes give great R.F. gain, even on very short waves. Selectivity in the R.F. stage, heretofore impossible of accomplishment, is secured through the higher plate impedance of the new tubes.

## "CONTROLLED SELECTIVITY"

An entirely new feature found only in the SW-58. Allows receiver to be operated at the best selectivity consistent with signal strength and conditions of reception. Volume can be controlled on the R.F. circuit without affecting in the least degree the detector circuits.

## NEW NATIONAL ISOLANTITE SOCKETS

Coil and R.F. tube-sockets are the new NATIONAL design, made of Isolantite, reducing the often overlooked losses at these points.

## NEW ISOLATED-ROTOR GANG-CONDENSER

Prevents interlocking and is an essential contribution to this new order of isolation between R.F. and detector circuits.

## NEW FULL-VISION VELVET VERNIER DIAL

In keeping with the times, the SW-58 has a new Full-Vision Velvet-Vernier Dial with a linear scale of unusual length, so that the operator may see at a glance the approximate setting in the band being used at the moment. Has all the characteristic smoothness of the Velvet Vernier Dials.

## NEW TUBE-ISOLATORS AND STAGE SHIELDING

A new tube-isolator or shield is employed in the SW-58, especially developed to take full advantage of the new screening of the 58 R.F. Amplifier Tubes, R.F. and Detector Circuits are completely enclosed in individual compartments.

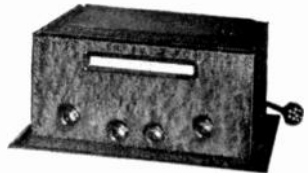

Send in this Coupon today!

## PUSH-PULL AUDIO, FULL A. C. OPERATION

The SW-58 has a push-pull audio output through two 245 tubes, assuring excellent quality and ample volume for loud speaker reception of short-wave broadcasts. Operation is full A.C. with a special SW Power Supply, with extra shielding and filter sections for humless operation. R. C. A. Licensed. Also made for battery operation.

## IMPROVED R-39-A LOW LOSS TRANSFORMERS FOR USE WITH 58 TUBES

A special type of R-39 transformer with materially higher plate impedance to go with new 58 tubes. A special NATIONAL 6-prong base isolates all circuits, to eliminate detrimental effects of coupling always found when an attempt is made to employ a 5-terminal connection for the three different windings.

NATIONAL CO., Inc.,  
61 Sherman St.,  
Malden, Mass.

Gentlemen:

Please send me  
 New NATIONAL CO.,  
16-page, 1932 Catalogue  
Free

Volume I—NATIONAL  
SHORT WAVE Manual,  
64 pages, Price 50c

Volume II—NATIONAL  
SHORT WAVE Manual,  
64 pages, Price 50c

Volume III—NATIONAL  
"BELOW 10 METERS"  
Manual, 68 pages, 50c

I enclose 50c for each manual ordered (stamps, coin or money order). (Cat. Free)

Name .....

Address .....



# NATIONAL

## A. C. SW-58 THRILL-BOX

Made by the makers of the Famous Velvet-Vernier Dials