

# MODERN RADIO

---

---

EDITED  
BY  
ROBERT  
S.  
KRUSE

## CONTENTS

	Page
Improved Transmitters . . . . .	2
An Oscilloscope for \$2.85 . . . . .	4
A Forgotten Chapter . . . . .	8
Coming in Modern Radio . . . . .	9
The Perpetual Triode Chart . . . . .	10
Progress in Converters . . . . .	11
We apologize . . . . .	13
More than a Monitor . . . . .	14
The Allied Arts	
Insulator Noise Tests. . . . .	16
"Fundamental Bass" . . . . .	16
Improved Service to Alaska . . . . .	17
Practical Advisor (Hum on Carrier) . . . . .	18
What's New . . . . .	21, 22, 23
Short Circuits . . . . .	26

Copyright 1932 by Modern Radio Co. All rights reserved

Number 8

February

20 cents

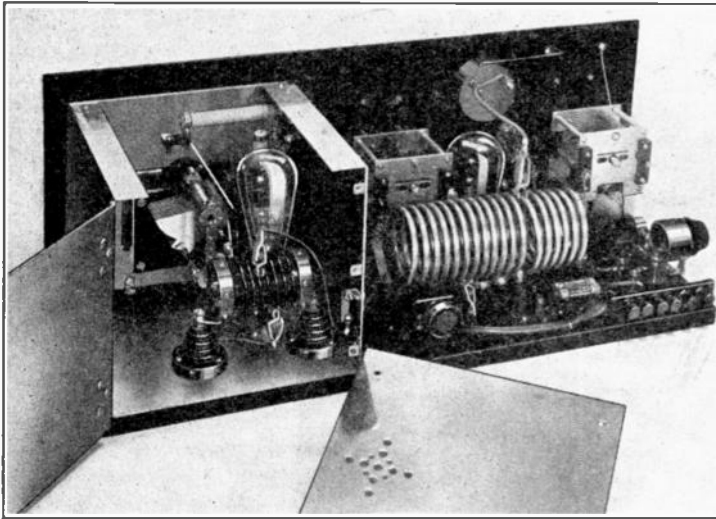

THE  
OSCILLATOR-  
AMPLIFIER  
TRANS-  
MITTER

## Improved Transmitters

Herewith are shown two transmitters built for Mr. Edward Madison of Waterbury, Connecticut. The smaller one is a portable set of a straightforward Hartley oscillator variety using a type '10 tube and intended for c. w. transmission in the 40 meter band. The pictures explain the construction and the circuit is familiar to all. Nothing more needs to be said except that the equipment at the right (rear view) is a keying thump filter.

The larger set is an oscillator-amplifier in which several pleasant ideas are

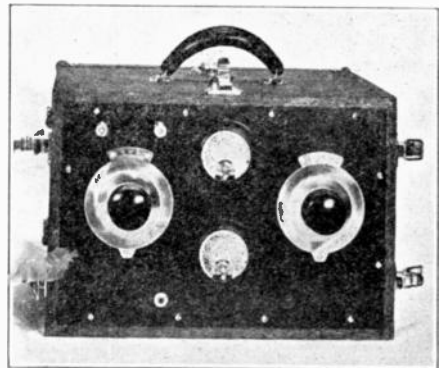

Front view of the portable Hartley-type c. w. transmitter. The back cover is removed to permit connection to the power supply. The key plugs into the jack at the lower left. The upper meter is a 2 ampere r-f. meter (antenna) and the lower one is a 200 Ma. plate meter.

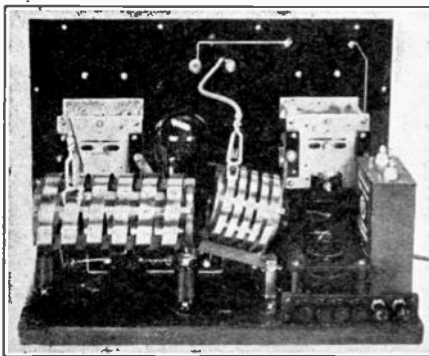

Rear view of the portable c. w. set.

incorporated. The oscillator is again of the Hartley type, using a '10 tube, but operating at a somewhat reduced voltage

by virtue of the resistors in the plate supply lead. Since a copper-tube coil would be so bulky as to create excessive coupling with the shield the inductance of the oscillator is instead wound with No. 12 enameled wire, well spaced. Look at the oscillator-amplifier, the oscillator shield is open, note that the oscillator is NOT made of trolley wire, but of normal No. 12, a construction which gives exactly as good stability, and better efficiency. In the

amplifier tank and the antenna coil it was mechanically convenient to use a self-supporting coil and for that reason alone the traditional fat copper tube was retained, the usual high eddy-current losses of such coils being reduced by

not work well into an antenna for closeness of antenna coupling spoils selectivity of the plate tank and fundamental passes through. This best can be avoided by interposing another amplifier. The neutralizing condenser knob is

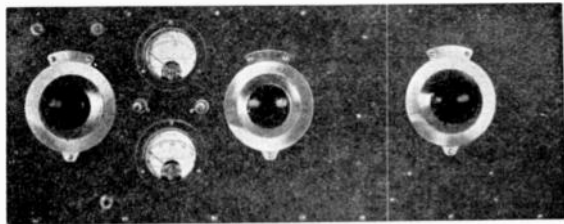

The oscillator-amplifier unit for c. w. and 'phone. The oscillator tuning control is at the right, next comes the amplifier tuner, then the antenna tuner. The milliammeter can be put in either the oscillator or amplifier plate-supply line by means of switches but this non-essential is not shown in the diagram.

spacing the turns.

The amplifier is the traditional neutralized triode (type '10) working "straight through", in other words without change of frequency. This is almost essential where this stage is to feed an antenna or to be modulated. However, the coils are interchangeable and if a following stage is at any time to be driven the amplifier may exactly as well be used either "straight" or as a frequency doubler. The unit is accordingly quite flexible in its uses and wavelength range. Unfortunately a doubler does

seen under the amplifier plate coil. The amplifier grid leak is under the antenna coil. The keying relay and click-filter are at the right. The oscillator box is provided with openings in the lid and the lower part of the sides so as to produce a chimney effect, giving self-cooling and improved stability. The resistors inside the oscillator shield are all of very low temperature coefficient (Electrad) to minimize drift, and the tuned circuit is kept well away from both tube and resistors to minimize heating drifts.

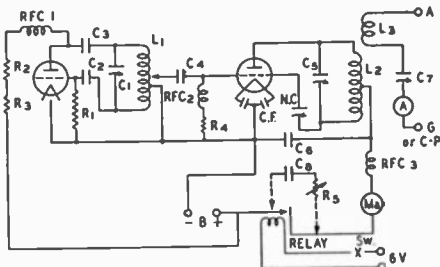

Diagram of the oscillator-amplifier. Both tubes are '10 type though the diagram works just as well with the 841, 245, 171 or 112A—assuming proper A and B voltages. C is automatic.

- R1—10,000 ohm, 25 watt gridleak.
- R2 and R3—Each 5,000 ohms, 50 watts.
- R4—100,000 ohms, 5 watts, cool.
- R5—10,000 ohms max.
- C1—Oscillator tuning.
- S2—Grid-stopping condenser, .00025 mufd.
- C3—Plate-stopping condenser, .0005 mufd.
- C4—Amplifier feed condenser, .0001 mufd.
- C5—Amplifier tuning condenser, receiving.
- C6—Plate-supply bypass condenser, .01.
- C7—Antenna tuning condenser, .00025 max.
- C8—Click-absorbing capacity, 2 microfarad.
- L1—Oscillator tuned coil. Diameter 2", spaced 1/2" center to center, length of winding 3", regardless of number of turns. Wire—No. 12 enameled. Number of turns, 20 meter band 3, 40 meter band 6, 80 meter band 12, 160 meter band 24.
- L2—Amplifier tuned plate coil. All coils have an inside diameter of 3" and winding length

of 5 3/16". 20 meter coil, 7 turns of 1/4" copper tube. 40 meter coil, 12 turns of 1/4" copper tube as shown. 80 meter coil, 24 turns of No. 10 copper wire, suitably braced. 160 meter coil, 48 turns of No. 16 enameled wire, same construction as oscillator coil.

- N.C.—Neutralizing midget, .00025 max.
- L3—Antenna coil. 5 turns of 1/4" copper tubing, 3" inside diameter, supported from one end and swinging to vary coupling.
- RFC1—Oscillator feed choke, RFC2 amplifier grid choke, RFC3 amplifier feed choke—all Hammarlund 85 millihenry, backed by resistance to "wash out" resonances, or placed (RFC3) so they have little to do.
- Ma.—For '10, 841 or '45 tubes, 0-150 Ma. For smaller tubes, 0-50 Ma.
- A, For '10, 841 or '45 tubes, 0-2 Amp. For smaller tubes 0-1 Amp.

NOTE—The amplifier grid isn't double-ended, that is merely permitted under our artistic license for 1932.

(Please turn to Page 25.)

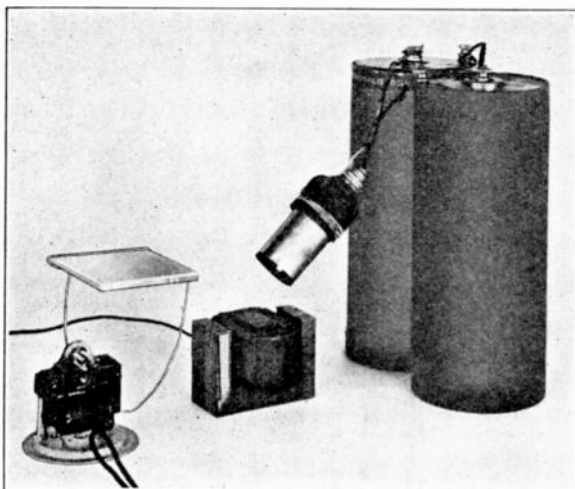

At the right is the  $2\frac{1}{2}$  volt flashlamp in its housing, lamp and all being suspended by the connecting wires from the dry cells which drive it. A transformer will serve if used with care as explained in the story. Just below the lamp-house is the vibrator-system and its driving choke-field. To the left is the rotating mirror and screen system.

## An Oscilloscope for \$2.85

By John L. Reinartz\*

Most of us have wished for some way of taking snapshots of the many things in our radio receivers and transmitters which happen too fast for our ordinary voltmeters, ammeters, wattmeters, and the like. If we could only see a picture of the bothersome hum, or motor-boating, or key thump, we would have some idea of the way to cure it—and of course we could then take more pictures and make sure that it really WAS cured. Now oscillographs designed to do just such work can be bought—if you have from \$300 to \$3,000! Who has?

Fortunately we can in one evening make a device that will serve most of our purposes for just about 1% of these prices. Like all amateur devices it has some limitations, hence judgment (and the precautions mentioned later) must be used. Still, one can put up with a few shortcomings for 99% of \$3,000—or even \$300. And make no mistake—the simple device we are to describe will teach you an amazing lot of things about your equipment.

### The Principal

All oscillographs and oscilloscopes must be FAST—because their only business is to make visible things that are so fast that they can't be followed by the needle of a meter. The reason that the ordinary meter cannot follow very

\*Electrical laboratory of John L. Reinartz, 176 Wadsworth Street, South Manchester, Conn. Copyright, 1932, by Modern Radio Co.

fast changes is that the needle has some weight, also it must be moved across the scale by small bits of machinery which also have weight. A meter movement which had no weight would be very fast—so that is what we try to approach when making an oscilloscope—which means nothing at all but “things to see oscillations with”. Instead of the usual aluminum meter needle we use a thin RAY OF LIGHT, which has exactly no weight at all. We move this weightless light needle by means of a tiny scrap of mirror (S in the diagram) and this mirror-scrap is almost weightless. From this simple beginning a useful oscilloscope can be built up as shown in the diagram and photograph.

### The Practical Device

The small flashlamp in the casing throws a  $\frac{1}{4}$ " pencil of reasonably parallel light rays through the holes in the diaphragms D1 and D2. This beam impinges on the tiny mirror S, attached to the vibrating iron strip V. (The way V is made to vibrate will be shown later). For the moment we only need to observe that as V moves to and from the reader a small portion of the light—a mere line or thread of light, barely visible at all—is moved back and forth on the surface of the rotating mirrors M. These mirrors again reflect the light to the underside of the ground glass

screen. Now if both V and M are stopped we will see a dot of light on the screen, the size and shape of this dot being determined solely by the size and shape of S.

If V is left stationary and the rotating mirror M is set to turning by starting the motor which drives it (more of that motor in a moment), the dot of light will be stretched out into a long line across the screen as shown in Fig 2A. If the motor be stopped in such a position as to put the light-dot on the center of the screen and V then be set to vibrating we will have a transverse light-line on the screen as shown in Fig. 2B. If BOTH M and V are set going—that is, if the motor is running and the strip vibrating we will see some sort of a wavy line on the screen AND THE SHAPE OF THE WAVES WILL TELL US HOW V IS VIBRATING—and that's exactly where the whole value of this device comes in. For instance, if the mirror were turning at an even speed and the strip were being vibrated by steady a. c. of a good wave-form (any good power-and-light system supplies such current) we would see such

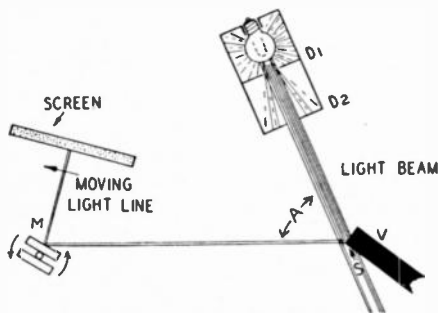

Fig. 1. The proper placement of the parts, which are somewhat wrongly placed in the picture to permit a clear photo. Increasing the distance between the motor and the vibrator will give a wider image on the screen, but also make the line fuzzy—work for a sharp, clean line.

a curve as is shown in Fig. 2C. The curve has the familiar sinusoidal wave shape—which is just what it should have, for that's the wave-form which we know the a. c. to have—but now we are SEEING it instead of reading about it in a book. If the curve is steady on the screen we know that not only is the strip V vibrating steadily, but the motor M is running IN TIME with the 60 cycle

line, so that each time its rotating mirrors throw an image on the screen it lands just where the last one was. Such a steady picture is very convenient, and

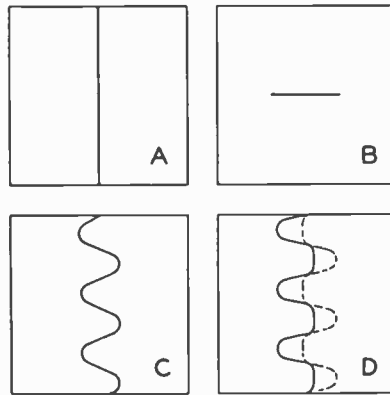

Fig. 2. A few oscillograms—hand drawings of the effects seen on the screen in 10 minutes of work. More will be shown next time.

since much of our radio work is done with 60 cycle current it is very convenient to have a motor which will turn in exact step with the 60 cycle line-current—and of course that's what we call a synchronous motor. If you have not guessed from the photograph where we get it, we will soon tell you.

#### The Vibrator

To make a working device we must evidently find ways to turn M at an even speed (synchronous if possible), and to make V vibrate in accordance with the effect (current—voltage or whatnot) we are trying to see.

V moves by virtue of magnetic attraction, the frequency (and wave shape) of which depends on the current which is sent through the coil around the filter-choke core (see photo) to which V is attached and by which it is attracted as the current magnetizes the core. In the particular device photographed a Philco B-eliminator choke was used. The straight part ("I side") of the core was removed, leaving the E shaped section, which is  $2\frac{1}{4}$ " wide,  $1\frac{1}{2}$ " high and 1" thick. The original coil was retained and gives satisfactory amplitude to the vibrator-strip when about 10 volts is applied to its terminals from the circuit to be—looked into. The vibrator-strip V was cut from a slip of .07" silicon core steel. Good (this is somewhat important) audio transformer cores will

supply material about .05" to .07" thick and a piece about  $\frac{1}{8}$ " x  $1\frac{1}{2}$ " is useful. It is NOT to be clamped to the core but is only glued by its lower end in the position shown in the photograph—or even stuck on with a drop of sealing wax and then bent slightly away from the core. The natural frequency of V is below 25 cycles and any mechanical resonances which might be expected at harmonic frequencies are considerably reduced by the "dead" material securing the strip in place.

#### The Small Mirror S

The mirror S will be the cause of most of your grief and when successfully attached will give you a measure of satisfaction—try it and see. We begin by finding a piece of discarded mirror and with a safety razor blade (Gillette or otherwise) scraping off some of the backing, while holding the mirror over a sheet of clean paper. Among the scores of pieces which fall off you will find a few that will suit you—pieces  $\frac{1}{64}$ " in diameter. The next job is to pick up such a tiny scrap of silver with its backing of paint, and secure it to the vibrator, for this is of course the mirror-scrap S. With the point of your knife carefully turn these pieces face downward, exposing the paint-backing. Now with a toothpick apply a tiny daub of LePages glue (advt.) to the middle of a 6 inch length of fine silk thread or No. 38 wire. Holding this thread stretched between your thumbs and forefingers—and holding your breath at the same time—cautiously approach the bit of silver and touch the gluey center of your

thread or wire to its back. By that means only pick the bit of silver up. Continuing to keep the thread stretched,



carry the bit of mirror to the strip V, turning the thread so that S is now right side up. Touch the glue-daub to V and then cautiously work the thread out by a sidewise sliding motion, finally patting the mirror into proper position with a toothpick. After several trials you will be successful in having S stick to V. If you now use the vibrator the mirror S will instantly be thrown off and you will never see it again. Better go to supper and let the glue dry for half an hour!

#### The Motor

Now for the mirrors M. We buy an electric clock for as little as possible—the local record so far is 77 cents. When the wife is away, quickly take this clock apart and if your luck is good it will turn out to be one of the sort that either has a fairly slow motor, or else has a geared-down shaft where we can get at it. In either case we hope for at least  $\frac{1}{4}$ " of unobstructed shaft, either between the bearings or extending beyond them. To this shaft we glue two small strips of mirror, about  $\frac{3}{16}$ " wide and as long as the clear part of the shaft permits. They are glued back to back as shown in the drawing. Care must be used to make them parallel, otherwise the picture will jump back and forth.

*Editor*  
ROBERT S. KRUSE  
*Associate Editor*  
L. W. HATRY

*Published Monthly by*  
**MODERN RADIO CO.** *Advertising Manager*  
101 Allyn Street  
Hartford, Connecticut  
Tel. 5-5326

*Contributing Editors*—BOYD PHELPS, PERRY O. BRIGGS

Advertising and Subscription Representative for California, Washington and Oregon,  
Don C. Wallace, 4212 Country Club Dr., Long Beach, California.

Entered as second class matter at the post office at Hartford, Conn. (permit application pending),  
June 20, 1931, under the act of March 3, 1879. Yearly subscription \$2.00 in U. S. only, \$3.00 in foreign  
countries including Canada. Single Copies, 20c.

Contributions not returned unless accompanied by stamped, self-addressed envelope.

Copyright, 1931, by Modern Radio Co.

Advertisements accepted only on terms stated on current rate card.

Better do a little trying before the glue is entirely hardened, and shift the mirrors if necessary. Do not start the motor at this time or you will again lose mirrors. A movie can be attended while this glue is hardening.

#### The Screen

The screen is simply a piece of ground glass as thin as possible so that little light will be wasted in its structure. It needs to be not more than 2" x 2". If you have no ground glass—make some from thin glass.



#### Setting Up

For clarity the parts have been shown somewhat out of position in the photograph. Actually the angle A should be much sharper and the parts should be located as shown in the drawing.

#### Operation

Setting up for the first time will require some juggling. Even in a dark room the little light-line which leaves S is invisible until it strikes something, therefore a bit of thin paper is used to trace its direction by putting the paper in the path of the light and following it. In this way M is located correctly and then turned until the light-spot is found on the screen. The screen-supports will probably require some readjusting—be patient. If everything appears to be in line we will begin by amusing ourselves by watching the antics of the little dot on the screen when we apply 60 cycle a. c. to the winding of the filter-choke. This will also give us a further opportunity to make such necessary alignment adjustments as are needed to provide us with the undistorted picture of Fig. 2C. Patience is the whole requirement—there's no magic about it. When you have finally caught the knack you will be astonished

at the clearness and sharpness of the picture—and the perfect way in which it stands still, thanks to the synchronous motor.

Now with the nice sinusoid of Fig. 2C on the screen we bring an ordinary permanent magnet (from a telephone receiver, a magneto—or the dime store) near V and find that we are able to change the wave form of the image, depending on the magnet's nearness to V. The wave will then look somewhat as

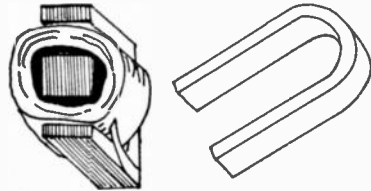

shown by the solid line in 2D, while if we turn the magnet over we get the opposite distortion as shown by the dotted line in 2D. If another winding is put on the filter-choke-core and d. c. is passed through that winding, exactly the same sort of picture will appear on the screen. The effect in both cases is clearly caused by a distortion of the magnetic waveform which drives V—whereby we have learned several things all at once. We now know that we CAN see wave forms with this simple contrivance, also that the vibrator V DOES follow changes in the wave form—and that we must be careful not to get stray magnetic fields from transformers, magnets and chokes too close to our oscilloscope or we will be seeing "things that ain't".

If you have followed this far, you have already spent several hours in an entertaining way—and made the whole family watch with you (Check—L. W. H. and R. S. K.) beside thinking of a dozen uses for the oscilloscope—and as many objections to it. How to use the oscilloscope most easily on your transmitter or receiver—and how to get around the objections, must be our next story. For this time it's enough to have saved \$293.15!

Next month also we will show you some pictures of key-thumps, motor-boating and bad filtering, and then show what happens when one starts to cure them.

# A Forgotten Chapter

Far back in tube history there was introduced a cheerful little tube named the UX-210, and amusingly rated as a 7½ watt oscillator. The UX-210 was a good fellow and chummed with everyone.

Meanwhile the high-mu brother of the 210, which was named the UX-841, lived a secret life and could be found only by climbing up a tall tower full of offices. So few succeeded that the 841 became a legend—like broadcasting without excessive advertising, and amateurs that never call CQ.

Well—the repression—or somepin'—appears to have driven the 841 down; it has decided to be folks, and is offering itself for sale as either a UX-841 or a CX-841; that is to say it is offered to "amateurs and experimenters". Let us hope this quoted phrase implies no delays, and proceed to the RCA-Cunningham news-release.



The tube is recommended for use in resistance and impedance coupled amplifiers, as a transmitting oscillator (self or crystal controlled) and as a frequency doubler. For most of these purposes EXCEPT self-controlled oscillation it offers distinct advantages over the 210. As a resistance-coupled amplifier the 210 is rather hopeless because of the excessive voltage and wattage loss in the coupling (plate) resistor. As a crystal-controlled oscillator—but there are two camps of crystal-oscillator men and each may buy their tubes (high-mu or low-mu) as they see fit without any objection from us. However, in a frequency doubler, or in even the ordinary transmitting sorts of r-f amplifiers (which are biased to cutoff or beyond) the 841 is certainly the better tube, simply because it requires less bias for the same result—and less r-f input voltage as well. Observe, now, how the 841 does the SAME jobs MORE easily.

### General Data

	841	210
Filament . . . . .	7½ volts, 1¼ amps	Same
Amplification (Mu) . . . . .	30	8
Interelectrode capacitances in micro-microfarads		
Plate to grid . . . . .	8	Same
Grid to filament . . . . .	5	Same
Plate to filament . . . . .	3	4
Safe plate dissipation (watts) . . . . .	15	Same
Bulb and base alike for the two tubes		
Max. r. f. grid amps. . . . .	5	Same

We shall now compare a 210 tube with an 841 for operation under the so-called "A", "B" and "C" conditions—though not having much enthusiasm for those headings.

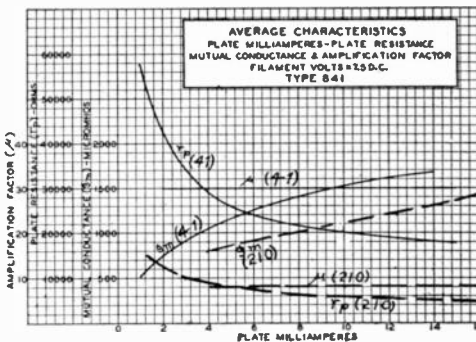
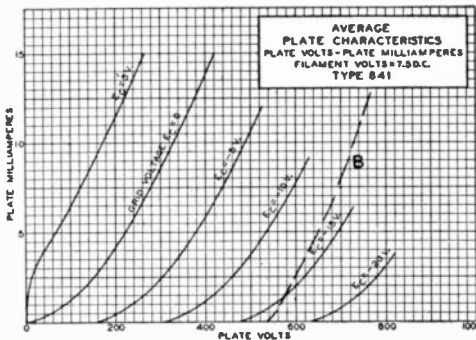

The B curve in the top chart is for a 210 tube with a 70 volt grid bias.

The dashed curves in the bottom chart are those of the 210.



Comparison in audio or other non-distortion amplification, where no grid current is drawn. (So called "Class A".) In general the 841 will be resistance-coupled and the '10 transformer coupled.

	210	841	841
Plate supply voltage	425	425	1,000
Grid bias	-39	-5.8	-9.2
Load resistance	10,200	250,000	250,000
Plate resistance	5,000	63,000	40,000
Mutual conductance (micro-mhos)	2,000	450	750
Peak grid swing needed (volts)	35	5.8	9.2
Plate current, milliamperes	18	0.7	2.2
Output volts (5% second harm.)	405	126	225
Output watts	1.6	.64	2



THE 841—AT LAST

Comparison in high-output (distortion) amplifiers, i.e., those operated with high bias and high a. c. (or r-f) grid input, the distortions being removed from the output by filtering or by push-pull connection. Examples are the usual r. f. transmitting amplifier and the recent push-pull modulators for 'phone transmitters. This is the so-called "Class B" service.

	210	841	210	841
Plate supply voltage	350	350	450	450
Grid bias	-39	-5	-62	-8
Plate current	43	43	36	36
Peak watts output possible	12	12	16	16

When amplifying 100% modulated carrier, the carrier watts are 1/4 of these values.

Comparison as r-f amplifiers, to be modulated by plate-voltage variation—the usual way. (So called "Class C".)

	210	841
Plate voltage	350	350
Grid bias	-100	-25
Power output when not modulating (watts)	10	10

Since this bias may be obtained from a grid leak the difference in bias voltage is here less important, one resistor being as cheap as another.

Comparison as plain self-excited and self-controlled oscillators.

Performance identical except that fewer grid turns are needed in the tuned system.

### BACK ARTICLES

Photostats of articles in back issues can be furnished at 50c per page. "Modern Radio" back copies are out of print except for Nos. 6 and 7.

It's allright to kiss the bride after the ceremony, but not too long after.—The Portico, Hartford Times.

Mr. Harry Reynolds of Buenos Aires gently reminded us that "American" is a title shared by some two dozen countries.

The slumber hour at WJZ is splendid—but I weary of getting up in the middle of the night to listen to it.

## Coming

- STARTLING CRYSTAL NEWS.  
(See Page 3, January issue.)
  - The Unprofitable "Class B" Amplifier.
  - It Isn't the Coil that's Wrong.
  - The Simplest Oscillator.
  - Our HATE!!!! Page.
  - Hum-m-m-m!
  - Better and Simpler.
  - High Grade Nothings.
  - A Poor Standard.
  - The "1,000-Ohm-per-Volt" Rule.
- All that, and much more is yours for \$1.25 if you take the Last Chance on page 25.

WATCH "MODERN RADIO"

Page Nine

# The Perpetual Triode Chart

A Batcher Abac.

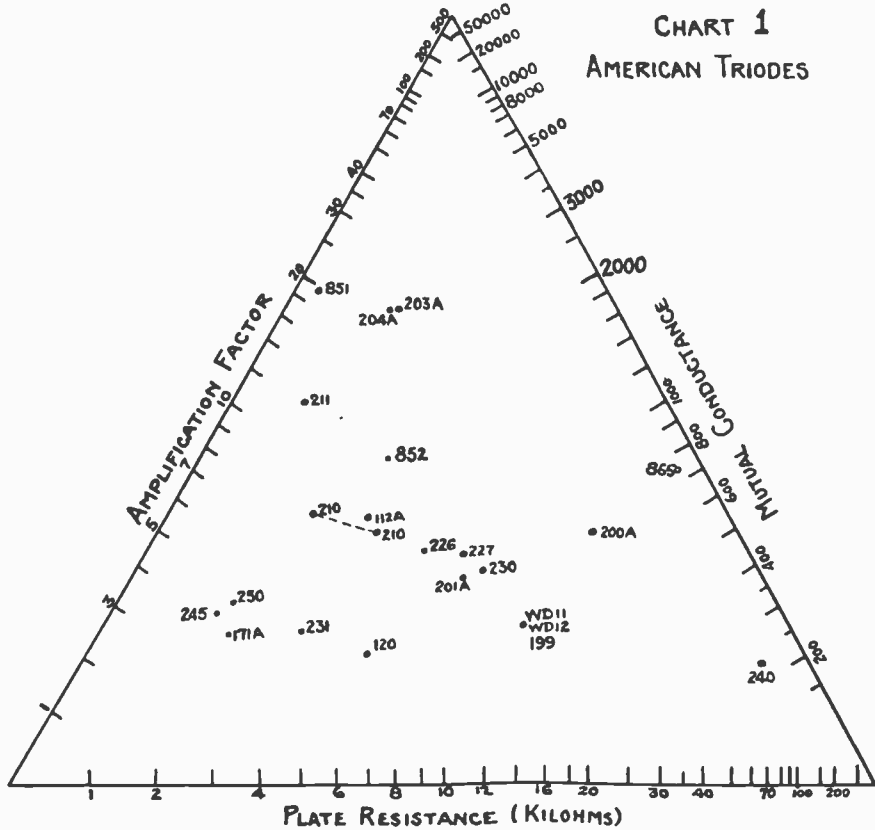

Fully copyrighted, Modern Radio Co., 1932. All rights reserved.

An R. R. Batcher self-calculating chart is something to cheer about. Many of us have completely worn out our copies of "Batcher's Prepared Radio Measurements"—and dodged hundreds of hours of exasperating mathematics thereby.

Do you—for instance—know what other tubes resemble the 226 in amplification constant, in mutual conductance, or in plate resistance? From this chart these things can be seen at a glance. First run a line from the lower right corner through the dot marked 226 to the Amplification Factor scale—all dots along that line belong to tubes with nearly the same  $\mu$ —and the value is 8.5, as is seen from the fact that the line strikes the  $\mu$  scale at that point. These tubes are more or less inter-

changeable as far as their  $\mu$  is concerned.

Again—run a line from the lower left corner through the 226 dot to the Mutual Conductance scale. It strikes at 940 and does not miss either the 231 or the 227 by a great deal.

Once more—drop a line from the top of the triangle down to the Plate Resistance scale. The reading is 8,600 ohms and again the similar tubes (as to plate resistance) lie along the line.

Finally—NEW TUBES MAY BE ADDED AT ANY TIME BY MERELY LOCATING A DOT FROM THE DATA GIVEN IN THE TUBE CARTONS AND DATA SHEETS. Thus the chart never gets out of date. Tetrode and other charts will come later.

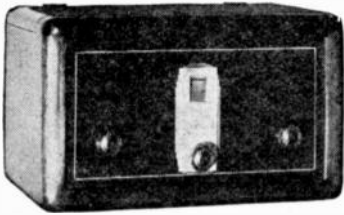

## Progress in Converters

By R. S. Kruse

As the owner of a Franklin motor car which will soon be antique, I am sympathetic toward those who desire economy—but have no great hope of seeing the present tubes used to produce a high-performance converter with but a detector and an oscillator. (Whether the power-supply rectifier is in the converter is immaterial.) The main claim that can be made for such simple converters

circuits quite apart from each other, as is proper in an oscillator-detector with small tuning capacities and no protection against the variations caused by assorted antennas. This device is, quite properly, given a complete metal enclosure. Once again—in the Silver-Marshall 739 converter provision is made for “trimming-out” (adjusting for) the antenna effect, and an ingenious mechanical arrange-

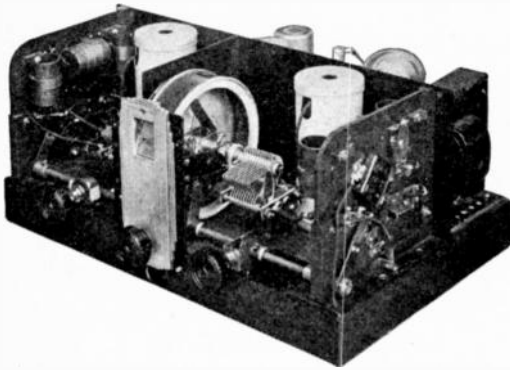

View of the National NC-5 Chassis.

In front is the cross-shaft, operated by the right-hand knob and operating the tuned circuit switches as well as a device which changes the color of the projection-typed dial as marked on calibration chart. The two insulating fences carry coils and switches. The metal fences reduce stray couplings between detector and oscillator, also to the r.f., i.f. and rectifier tubes and circuits at the rear of the chassis.

appears to be that they produce little noise—or signal! Support for that statement appears at the end of this paper.

### A Kind Word for the Detector-Oscillator

There has, of course, been some progress in the simple detector-oscillator variety of converter (the 2-tube sort if one neglects the rectifier). For example, the Stewart-Warner device makes a useful compromise between the '27 and the '24 detector by using a '24 with the screen tied to the plate, thereby gaining a special triode with low input capacitance, and also with a plate impedance which is within reason and gives a chance of transferring some r-f to the relatively low-impedance input circuit of the broadcast receiver. Again, in the National LC-3 converter the usual nuisance of interlocking tuning is evaded by coupling the oscillator and detector, cathode-to-cathode and keeping the tuned

ment of the tuned circuits permits unit assembly and with leads so short and rigid that variations during the general assembly are probably unimportant. Again a metal case is provided.

It is very probable that these and other refinements will further improve the 2-tube (plus rectifier) converter—

### Where to Place Amplification

None the less as long as the converter has neither an r-f amplifier ahead of its detector, nor yet an i-f amplifier after the detector the broadcast receiver must provide all the amplification. This the modern receiver is thoroughly capable of—but with a most distressing noise level as a result. Quiet reception comes with amplification early in the system—preferably ahead of detection. A set using detector and four audio stages would be—used to be—beastly noisy, but with two audio stages and two radio stages good reception was possible.

The same thing has long been admitted for the superheterodyne, which formerly had 3 or 4 noisy intermediate stages and no r-f whatever—but now has 1 or 2 i-f stages and 1 or 2 r-f stages up ahead.

From this it is fairly clear that we should provide amplification in the converter, either at the signal frequency (r. f. before the detector) or else at the

shortwave sets where the tuning condensers are small and easily overwhelmed. One stage will serve and in the National NC-5 here described such a stage is used.

The practice in broadcast superheterodynes has been to use inductive coupling between the oscillator and detector circuits, but this is not equally satisfactory

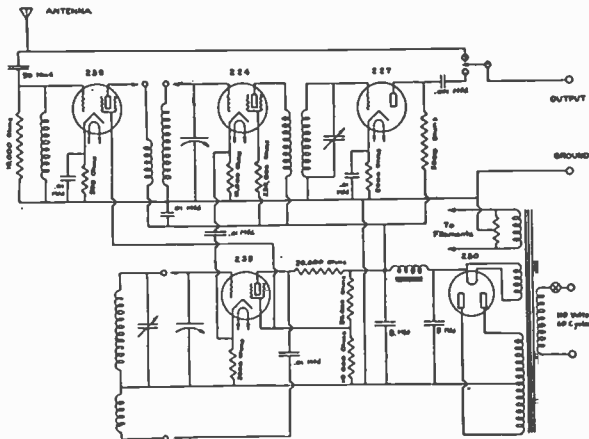

Circuit diagram of the NC-5. For simplicity only one set of coils is shown and the switches are indicated by arrow-circle combinations. The switch at the upper right puts the broadcast receiver through to the antenna.

intermediate frequency to which the broadcast receiver is tuned. The increased overall gain will cause more noise—just as any increase in sensitivity will bring in more noise. However, when the broadcast receiver is then cut down to give the same signals as before the noise will be MUCH LESS.

As was pointed out in "Modern Radio" for July, the mis-matching between a detector's plate circuit and a broadcast receiver's input system is extremely wasteful and demands excess gain in the broadcast receiver to compensate for the loss. When a fixed output i-f stage is added as an impedance-matcher the transfer-efficiency is so raised that the gain control of the broadcast receiver may be dropped back one-half to two-thirds, indicating an amplification increase of perhaps 250 times! However, impedance matching is the only excuse for the output stage and more than one tube is not desirable.

The addition of r-f amplification BEFORE the converter's detector can accomplish several things; it can place gain where gain is needed, and it can prevent the antenna from mis-tuning the input circuit—always a difficulty in

in a short wave device with much smaller tuning capacities and multiple ranges. In the current crop of converters a brute-force cure is frequently attempted by either using close coupling or providing detector trimming condensers almost as large as the tuning condensers. This combination results in an exasperating condition. All attempts to bring the detector into resonance cause the oscillator to shift, whereupon one loses the signal. The necessity is evidently for a tuning system having little or no coupling between the tuned circuits as such. The cathode-coupling system mentioned before and shown in the diagram meets the requirements.

The percentage-difference in the detector and oscillator tuning is much smaller at higher frequencies, therefore the oscillator curve can be allowed to depart a trifle from theoretical parallelism while still remaining within the high part of the resonance curve of the detector tuned-circuit, especially as a tuning range (max. to min. wavelength) of only about 2/1 is wanted instead of the 3/1 desired in ordinary broadcasting. Thus the various oscillator ranges need be provided only with shunt "padding"

condensers. Further study of the curves will show that some of the detector curves (notably the "yellow" one) are also flattened down by the use of shunt padding.

### Mechanical Considerations

Greater mechanical precision is needed than in the broadcast range. The coil-forms are accordingly moulded from the familiar low-loss special bakelite, R-39 after which threads are lathe-cut. R-39 is stubborn material and carballoy tools must be used. A set of coils is then assembled on an R-39 panel, wired to the range selector switch and padding condensers and adjusted at 3 points on the tuning scale, by comparison with a standard circuit. If a close agreement is not obtained the coils are rejected. This procedure permits the completed

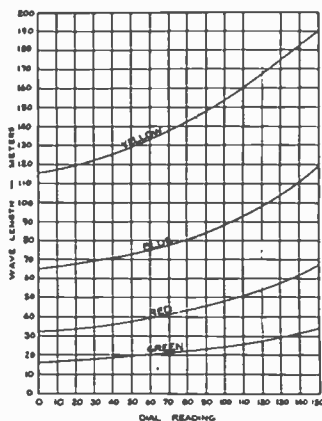

set to work without trimmers of any sort, which is to say that true single-control is provided. This seems unique amongst 1932 converters.

### COMPARISON OF COMMERCIAL SHORTWAVE SUPERHETERODYNE CONVERTERS

No.	Tube Equipment				Converter Gain	Stations Heard On Listening Tests			
	Input r-f Stage	Detector (Mixer)	Output i. f. Stage	Oscillator		Voice	Good Total	Good	Total Key
1. ....	none	'24	none	'27	minus 8	1	4	7	—
2. ....	none	'24	none	'27	minus 2	4	6	12	22
3. ....	none	'24	none	'27	minus 3.5	3	—	—	—
4. ....	none	'24	'24	'27	plus 21	6	—	—	—
5. ....	'35	'24	'27	'35	plus 30	8	13	35	154

### NOTES

1. Tests made into Bosch Model 48 T. R. F. receiver with tunable input circuit to provide best conditions for converters 1, 2 and 3.
2. Receiver gain adjusted at each point to produce 20 milliwatts average noise output.
3. Listening tests are average of results at five different times.
4. "Converter amplification" obtained by measuring overall, then measuring broadcast receiver alone.
5. Number 5 is the converter here described.

### WE APOLOGIZE TO THE MISSOURI VALLEY

Last August we offered 10 subscriptions to "Modern Radio", which were used as prizes in the Missouri Valley amateur radio convention. The convention management, despite repeated requests, has never given us the names of the winners. We have located a few but wish the rest would step forward and announce themselves—and also name all the others whom they are SURE of. Maybe it will not be a unanimous verdict—but at least we may hope for a reply.

Amen, Brother!

"I have never seen a billboard which I should care to classify as art."—Dr. William H. Fox, Director Brooklyn Museum.

As far as I know the Ford alone does not claim to be the best. Perhaps that is why so many buy it.

One trouble with America is the habit of using a \$2,000 dollar car to ride three blocks to the 10-cent store.—Los Angeles Times.

# More Than a Monitor

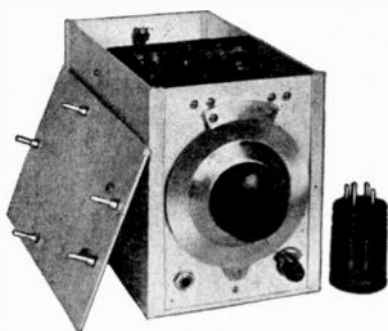

Calibrating a frequency meter to an accuracy of  $\frac{1}{4}$  of 1% is not difficult—but it is also not worth while unless the device is well-made enough to HOLD the calibration. Because there are ample

use, proper care, and attention to keeping up the batteries it will be dependable for closer work. A tube replacement will, of course, call for re-calibration.

The desirability of calibrating to  $\frac{1}{4}$  of 1% will hardly be argued when one recalls that a 1% error will carry about  $\frac{1}{4}$  of the way across the 40 meter band.

## Construction

Circuits are seldom as important as correct construction and constants. You need not use the circuit of Fig. 1; if you prefer a dynatron, go to it—but we offer no sympathy when it begins to miss at 40 meters and stops at 20. In any case the precautions of Fig. 1 should be observed. Briefly they are as follows. The

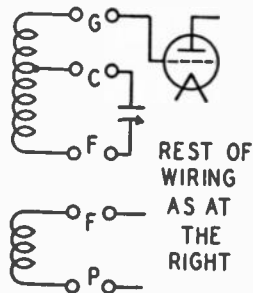

REST OF WIRING AS AT THE RIGHT

MODIFIED WIRING WITH TAPPED COIL TO SPREAD 40 & 20 METER BANDS

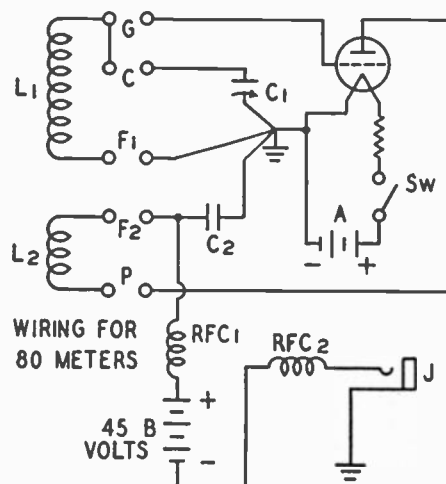

- L—Grid-winding of coil.
- L1—Plate or tickler winding of coil.
- C1—Cardwell 201e tuning condenser.
- L3—Hammarlund R. F. chokes.
- C2—.002 Mfd. Sangamo condenser.
- R—25 ohms for '99 tube run from  $4\frac{1}{2}$  v. "C" battery.
- 42 ohms for '30 tube run from  $4\frac{1}{2}$  v. "C" battery.
- 17 ohms for '30 tube run from 3 volts.
- 0 ohms for '99 run from 3 volts.
- S—Battery switch.
- J—Jack.

circuits have but one r. f. ground to the can, and that is at the condenser mounting where a ground is inevitable. (D. c. grounds are a different matter.) R-f chokes are used to filter out pickups from the 'phones or B battery, even though the latter is inside the shield. The oscillator is a unit built on its own front panel and removable after three screws are removed. A bottom shelf of bakelite carries coil and tube sockets on top and choke coils underneath. A small B and A battery (the latter is a 3 volt C battery) lies behind the bakelite partition which acts also as a terminal strip. These things, and the top

facilities for calibration, but not very many descriptions of substantial frequency-meter structures, we offer a description of an oscillating frequency meter which will easily hold a calibration of  $\frac{1}{4}$  of 1% over considerable periods of ordinary use. With moderate

bakelite strip are firmly connected with nicked brass angles so placed as to give a stiff structure, which is imperative if calibration is to be held.

The device is built in an aluminum box of the sort made familiar by Uncle Andrew Mellon's Aluminum Company of America. It is well known that the tongue-and-groove corners of these aluminum boxes lack rigidity and make unreliable contact, therefore the shield was bonded at 13 points with angles, machine screws and shakeproof lock washers. The bottom was also screwed to the corner posts by means of the

If the contacts in this shorted turn vary —what hope is there of keeping things constant inside?

The precision dial has a vernier that can be read to 1/10 of 1 division. At the high frequency end of the 40 meter band this permits reading to .6 kc. (600 cycles) since about 6 kc. are got per dial division. Thus the dial can be read closer than the long-time calibration accuracy warrants. Nevertheless two reasons justify the use of this dial: First, the percentages double at the other end of the scale, so that dial accuracy and calibration accuracy become

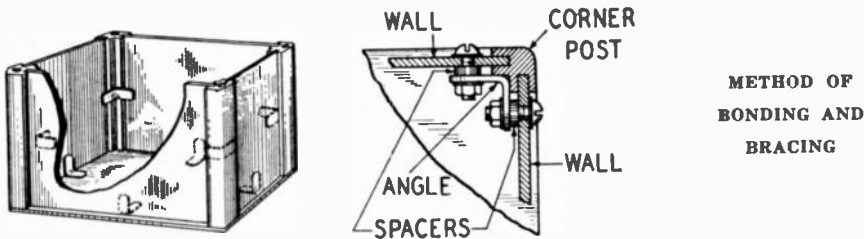

METHOD OF BONDING AND BRACING

corner screws as originally intended by the Aluminum Company. The top, however, was plugged in with a goodly number of General Radio's spring bananas, working into jacks whose location is seen in the photographs. Details as to the use of angles, and reasons for more than one lockwasher on each bonding screw, will be found in the line drawings.

more nearly equal, secondly, over short periods of time the oscillator stability is far better than 1/4 of 1%, so that a high-precision dial is really necessary to take advantage of the accuracy which is available for some time after a careful check against WWV or some other source of accurate frequency calibration. Oscillator calibration shifts are usually slow and over short periods of time may

The reason for bonding is that a shield

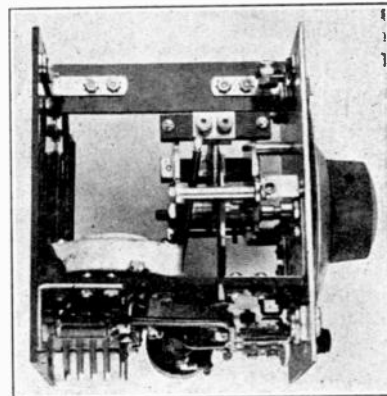
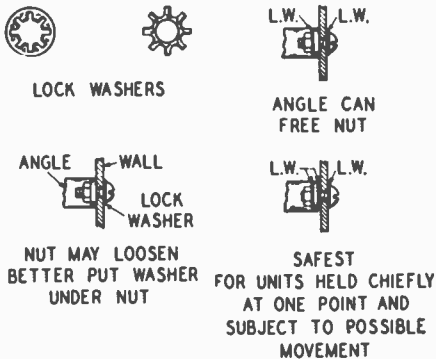

(Please turn to Page 29)

is a short-circuited secondary turn, wrapped around the apparatus inside.

# The Allied Arts



## INSULATOR NOISE TESTS

In the January issue of "Electrical Engineering" Mr. F. O. McMillan of Oregon State College, at Corvallis, described a somewhat detailed investigation of the same subject which was discussed in December "Modern Radio", page 21. Unfortunately he did not test the special "linepost" there described but worked entirely with orthodox pin-type high-tension insulators rated at 66,000 and 70,000 volts.

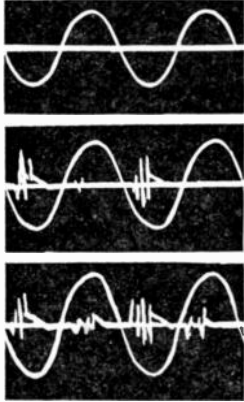

The results are a bit startling. Visible corona and radio interference began together on all the insulators tested (compare December special insulator)—and at distressingly low voltages, sometimes as low as 1/3 of the rating. Only by sealing the crevices with gummy materials was it possible to maintain peace until rated voltage was approached. None of the insulators tested—even those with shields—were quiet at rating.

The author's conclusions are, briefly, that normal pin insulators brush at 3 points (pin, cap and between petticoats), that the noise and the visible corona start together at a voltage below normal unless the design is materially modified, and that in general the noise is worse on the negative half of the cycle—for confirmation of which see the oscillogram herewith.

Page Sixteen

## "FUNDAMENTAL BASS"

A curious trick of the human ear frequently causes one to think that a radio set or phonograph can reproduce much lower notes than it is really capable of. Suppose we have a set that is deficient in its audio amplifier or speaker—usually the latter—and incapable of reproducing anything below 260 cycles—a condition that is common among midget receivers with speakers

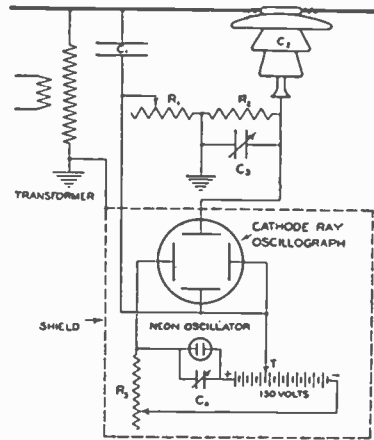

The Insulator Test Circuit.

the size of a doll's saucer. If a 150 cycle note is fed into this affair a surprisingly convincing sound comes from the speaker—though we absolutely KNOW that it is dead at 150 cycles. Investigation in the laboratory will invariably show that the test-note was not pure (few notes are) but had harmonics which ran somewhat as follows:

Second harmonic 300 cycles, third harmonic 450 cycles, fifth harmonic 750 cycles. Others are present frequently but these are enough for the moment. All of these harmonics ARE reproduced through the speaker and the ear obligingly sketches in the fundamental with disconcerting accuracy! In fact, the effect is rather good until through observation and experience one has learned to catch such "harmonic bass" and distinguish it from true fundamental bass. In a side-by-side comparison the difference is very large and no one would ever choose the "phoney" bass.



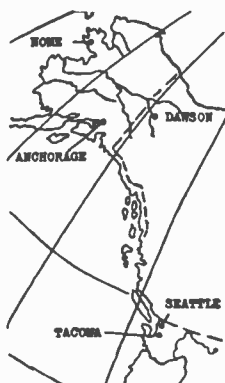

## IMPROVED SERVICE TO ALASKA

In the "Key Wagger", edited by Howard Mason for the Washington Technical Institute Radio School (Seattle) we find this interesting item:

"Ever since the days of the gold rush when the U. S. Army Signal Corps was called upon to string a telegraph line between the Nome and Dawson gold fields, and to provide a means of communication with the "outside", that branch of the Army has been identified with Alaskan communications.

"For many years all commercial communication with the northland was by cable from Seattle. This has recently been supplemented by radio and the opening of the new transmitting and receiving stations in Seattle is a part of the plan to eventually abandon the cable entirely. Besides handling Alaskan traffic the station acts as a part of the regular army countrywide network.

The transmitting station at West Seattle at present includes one General Electric l. f. transmitter rated at 10 kw., also two Westinghouse 10 kw. h. f. transmitters and one 500 watt h. f. transmitter. Call letters are WVD.

"Quite elaborate antenna systems are installed. The l. f. transmitter operates on 86 kcs. into a large "T" suspended between two 300 foot tubular steel towers, and a large fan-shaped counterpoise. The h. f. transmitters operate into directional arrays (beam antennas) pointing toward Ketchikan and Anchorage. The corresponding receiving station is located just north of Fort Lawton on the other side of the bay. Here special receivers built in the Signal Corps

shops at Seattle are installed. A diversity receiving system is being built which is expected to reduce short period fading and permit the adoption of high speed automatic transmitting and recording equipment. At present operation is entirely manual."

The Alaska end of the circuit is handled by complete receiving and transmitting stations located at Anchorage and Ketchikan, each employing equipment similar to that at the Seattle end. From these Alaskan towns traffic is routed to the 30 odd lesser stations operated in Alaska by the Signal Corps.

---

It is rumored that strong commercial objection has been made to the use of the U. S. Army's radio net for the handling of government business. Presumably the objectors wish the Army to play radio chess or to transmit riddles such as—"What's the good of a radio system that isn't in practice?"

P. S. There isn't any answer to the riddle.

---

### A NEW SERVICE MANUAL

Electrad has announced a new perpetual volume control and resistor guide, \$1 per copy. The information not only



covers the specific receivers and their details but circuits of a general nature to fit any problem. Supplements to keep the guide up to date are offered yearly.

---

### HOW SHORT WAVES HAPPENED

In the January, 1932, issue of the "Proceedings, Institute of Radio Engineers", W. H. Wenstrom gives the best shortwave history we have ever seen. By all means read it.



## THE PRACTICAL ADVISOR

### HUM ON CARRIER

This continues our simplified information for experimenters and servicemen.

The troublesome effect known as "hum on carrier" is usually due to ineffective r-f filtering of the power supply leads or to other stray regeneration, although excessive hum in the B-supply aggravates the matter. "Hum on carrier" takes the form that the hum in the set increases when a carrier is tuned in.

The user of the set usually assumes that the transmitting station has a "rotten carrier" and is very much startled to find that a battery driven oscillator sounds the same way though it is clearly humless.

The usual causes of hum-on-carrier are:

- 1—Stray feedbacks.
- 2—Overloading of the cathode, grid, screen or plate of a '24 tube.
- 3—Badly filtered plate supply.

In turn the cures are:

- 1—Assume the shielding to be o. k. and by trial find where improvement is made by a resistance-capacity decoupler such as described in August "Modern Radio", and in more detail in this paper.
- 2—Make sure that the '24 cathode resistors are normal (250-600 for one tube,  $\frac{1}{2}$  as much for two using the same resistor) and that the volume control does something besides raising the cathode resistance. If it doesn't, change to one of the first 7 circuits shown on page 11, December "Modern Radio", preferably No. 7. The constants are given in that article.

Page Eighteen

Obviously screen-overload is bad too, hence a screen-voltage control of volume is "out" in favor of such a one as just mentioned. Either set the old control at maximum gain or substitute a fixed resistance that will not be monkeyed with.

Plate-overload can also happen, usually where the tube is run on some absurdly low voltage through use of a resistance coupling fed from some point incapable of supplying more than 180 volts.

The moral is to go higher on the B supply for the feed voltage, or to combine this with the scheme shown in Fig. 2, using a series R of 2000 ohms for audio '27 tubes, and about 10,000 for r-f. '24 tubes. In either case put a bypass at the left end of the series R, 1 "mike" for audio, .1 to .3 non-inductive for broadcast radio, .01 to .1 mica for high frequency radio.

- 3—The cure for deficient filtering is obviously an improvement in the filter, the shifting of audio or power transformers or filter chokes, the tightening of cores to prevent vibration, and finally the replacement of dubious parts or tubes.

NOTE—This material is from *Modern Radio's Pocket Book* for Radiomen, see page 26, also page 17, December issue. All rights reserved.

### DUBILIER LOW- VOLTAGE CONDENSERS

The Dubilier Condenser Corporation offers electrolytic condensers in 25, 50 and 125 volt ratings of cartridge and can form. The 25 volt sort comes in 8, 10



and 20 mufd. sizes, the 50 volt sort in 4, 6 and 8 mufd. sizes and the 125 volt sort in 10 and 15 mufd. sizes. The can type is shown.

# BUILT FOR SERVICE!

Wherever Radio is known, the good, rugged CARDWELL has rendered valiant service under trying conditions. Your outfit may never be called upon to meet the test of salt water, salt air, extremes of heat and cold, shocks and unavoidable abuse, nevertheless a transmitter or receiver if worth building at all *deserves* CARDWELLS for efficiency and long service.

## CARDWELL CONDENSERS

For  
TRANSMITTING — RECEIVING — NEUTRALIZING  
Send for Literature

THE ALLEN D. CARDWELL MFG. CORP.  
Pearl and Prospects Sts. Brooklyn, New York

"THE STANDARD OF COMPARISON"

## OSCILLATING CRYSTALS

**RADIO SERVICEMEN:** Fully mounted superhet. testing crystals specially designed for portable oscillators. Can be mounted in ANY position. Supplied to specified frequency between 101 and 200 kc. within 0.1% . . . . . \$21.00  
**RADIO FREQUENCY STANDARDS:** Quartz bars calibrated and designed for this special service. Easily adjusted to standard frequency without grinding crystal.  
**COMMERCIAL FREQUENCIES:** Mounted crystals calibrated within 0.03%, 500 and 50 cycles of specified frequency.  
**AMATEUR FREQUENCIES:** One inch square power-type (X) ground to approximate specified frequency. The name BLILEY and EXACT FREQUENCY (accurate to better than 0.1%) on each crystal.

1750 kc. and 3500 kc. bands . . . . . \$5.50  
Dust-proof, plugin holders . . . . . \$2.50  
Constant-Temperature Equipment: Complete line specially designed parts. Request Bulletin No. 26.

We manufacture piezo-electric quartz crystals to all frequencies from 25 kc. to 6000 kc. Write for any further information.

All crystals fully guaranteed.

**BLILEY PIEZO-ELECTRIC CO.**  
MASONIC TEMPLE BLDG., M  
ERIE, PA.

## MULTIPLY YOUR METERS at little cost

With **I.R.C.** Precision Wire Wound Resistors



WW 2

I. R. C. meter conversion charts enable you to change a voltmeter into a multirange voltmeter; a milliammeter into a D. C. Voltmeter; a milliammeter into a high range reading milliammeter. They show the way also to make other valuable apparatus. These charts are free for the asking. Write for them today.

**International Resistance Co.**  
PHILADELPHIA TORONTO  
Also Makers of  
**I.R.C. Metallized Resistors**



### ELECTROLYTIC CONDENSERS

In single, double and triple units

### FIXED RESISTORS

Wire-wound Tubular  
Flat Strip—Flexible  
Grid Leaks



### FILTER BLOCKS

The Standard of the Industry  
Built to specification

### VARIABLE RESISTORS

Carbon Volume Controls  
Wire-wound Volume Controls  
Rheostats—Potentiometers



### BY-PASS CONDENSERS

In stock in all usual capacities

### TRANSFORMERS

Audio Transformers  
Power Transformers  
Standard Choke Units



### UNCASED PAPER CONDENSER SECTIONS

For repair work  
Ask about the special Polymet Condenser Repair Kit

### COIL WINDINGS

All Types of coils,  
except radio frequency,  
built to specification

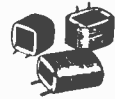

## POLYMET MANUFACTURING CORP.

World's Largest Manufacturers of Radio Essentials

834 East 134th Street    ::    ::    ::    New York City

## Volume Control    Fixed Resistors

We stock Frost, Yaxley, Electrad and Centralab lines.

Order from their volume-control guides or give following information and we will furnish suitable control:

Resistance of old control, what it does in circuit (such as controlling screen, bias, antenna, etc.), if it has switch attached, length of shaft, length of bushing.

Above information preferred: Otherwise name of radio, model number, tubes used, whether control is single or dual, if control has switch.

Centralab volume-control data book in stock. Electrad volume-control folders in stock. Usual discounts to servicemen, dealers and amateurs. Over 300 different controls in stock.

International Resistance Co. 1 watt, 30c list; 2 watt, 40c list, and auto suppressors. Electrad truvolt 25 watt, 50 watt, 75 watt sticks so useful for making up voltage dividers with extra clips—large stock. Usual discounts to servicemen, dealers and amateurs. Can be set to fit any divider problem. Measure resistance of dead sections and advise, we will send correct unit. Or state make and model number of receiver, voltages, and types of tubes.

Also the Polymet line of black enameled 10 and 20 watt resistor units. Ward-Leonard bleeders, line-voltage controls, transmitting transformer controls. For bias resistors, state number of tubes on resistor, type of tubes and voltages if possible. We will send correct wattage and resistance. Write for quotation on any item you need.

# Hatry & Young

203 Ann St.  
Hartford, Conn.

## MORE ON MODULATION IMPROVEMENT

General Radio is now ready with the push-pull modulation transformers for which so many of our readers have been asking since we began to talk about "Modulation Improvement". The transformers are so designed as to permit (if one wishes) the so-called "Class B" type of operation—meaning that one over-drives a pair of 210 tubes to the point where they not only will modulate a 210 but will actually modulate a 203A. The extreme distortions of the output wave must then be cancelled out by use of a proper push-pull output transformer. In "Modern Radio's" estimation too much mystery has been made over this thing and we will try to clarify it—modest, aren't we? However—the General Radio special output transformer is called 292-B and lists at \$10. Such stages of course draw grid current—which means power. The 210 push-pull modulator is therefore driven by a pair of 245 tubes. Ordinary 245 transformers have a low-voltage secondary winding to feed a dynamic speaker—which is all wrong for the present job, therefore a transformer called 292-A is offered to fit between the '45 stage and the '10 modulator. It is priced at \$7. All this will be clearer if one looks back at the various articles in our "Modulation Improvement" series.

## ELECTRAD CATALOG

Electrad, Inc., makers of resistors, volume-controls, variable T pads, direct-coupled amplifiers and small fixed condensers has a new catalog available on request. The lines are, from practical viewpoints, quite complete, and a feature of the catalog is the newly lowered prices of the power amplifiers. Transmitting grid-leaks in vitreous enamel up to 100 watts are also listed in several types.

We had just learned to make radio receivers with good fidelity when the public decided to stop paying for them.

Honestly now—have you heard a pentode output system that would fool anyone who had ever heard a good push-pull triode system?

## NEW WARD-LEONARD RELAYS

The new Ward-Leonard type A relays all take the general form shown in the drawing and range in price from \$5 to

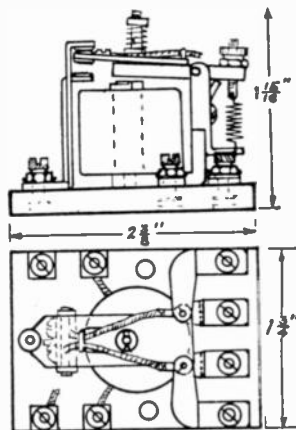

\$8. They are supplied for either a-c. or d-c. operation at voltages up to 115, all types having two pairs of contacts which may be used separately or as two breaks in series. In the first case each pair is rated at 1 amp. 110 volts d-c. or 4 amps. a-c. and in the second case the rating is 2 amps. d-c. or 6 amps. a-c. There is also a type especially for keying transmitters, and a 15 to 60 second time-delay type called TD-1A and listed at \$12.75, and several larger designs. A 15 ampere 110 volt type appears below.

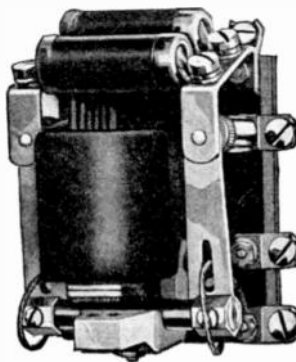

Synchronized operation permits two stations to muss each other up so the advertising becomes harmless.

Oh well; it takes high spots on both sides to make a depression.—Buffalo Courier-Express.



**OLD  
BUT  
STILL  
GOOD**

The diagram shows an indicator for wavemeters—or frequency meters if you prefer it so—which is old but still good. The meter can be any small d. c. milliammeter though a 0-1 or 0-1.5 is most convenient. The indicator is very sensitive and does not spoil the tuning as do neon or filament lamps. The pickoff coil usually needs but one turn and as this turn is changed when the main tuning coil is changed one can locate it properly for each coil and thus avoid the unsatisfactory compromise of an “average” setting that isn’t quite right for any of the coils. Possibly the best part of the

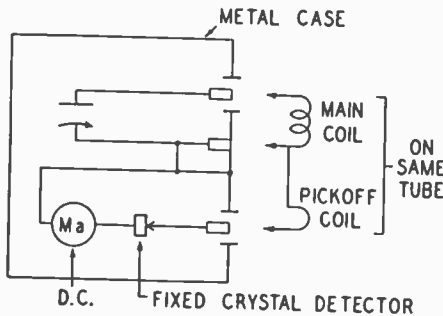

whole thing is that the pickoff coil is always at the same distance from the main coil. Combined with the sensitivity of the device this permits the calibration to “stay put”.

Now it is granted that one cannot read this sort of thing out to the fifth decimal place as is claimed for some beatnote devices, but during preliminary adjustments a beatnote meter is about as useful as a micrometer caliper is to a carpenter framing a house—he needs a plain ruler calibrated in sixteenths of an inch and able to stand the weather.

*Page Twenty-Two*

## A NEW PRECISION DIAL

The National Co. of Malden, Mass., offers a 6 inch German silver dial illustrated. The vernier provides readings to 1/10 of a division or 1/1000 of



the total range. The scale is accurately engine divided and the slow-motion has three ratios of speed controlled by a lever just above the control knob. The list price is \$9.

The variable condenser shown is of the type having two circular plates, establishing a high fixed minimum capacity of 35 micro-microfarads. The three shaped plates provide a variable capacity of 35 micro-microfarads, giving a total range of 35 to 70 micro-microfarads, a

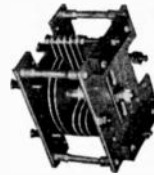

nearly ideal combination for the so-called “band-spread” tuning of receivers and oscillators. Well-spaced plates (about double usual spacing) allow good maintenance of calibration. List price \$4.50; made by the National Co., Malden, Mass.

You see, by saving you will have money to share with the fellow thrown out of work by your saving.—Publisher’s Syndicate.

# Shortwave Equipment-Tubes

## SHORT-WAVE CONVERTERS

Bud two-tube converter, net	\$14.50
Baird three-tube converter, net	\$16.50
National NC-5 five-tube converter, net	\$44.54

## SHORT-WAVE RECEIVERS

D. C. Super-Wasp in walnut cabinet with tubes and coils, in excellent condition. Original cost of kit, cabinet and tubes, \$48.50. Sell for \$19.50

R. E. L. four-tube D. C. compact, original cost, \$34.50, good as new, only	\$25.00
R. E. L. No. 278 bandspread	\$28.50
National A. C. SW-3	\$32.34
National D. C. SW-3	\$32.34
Power-pack	\$20.30
National A. C. SW-5	\$52.64
Power-pack	\$20.30
SW-45	\$52.64
45 Power Pk.	\$23.24

Above are net prices.

## MERCURY VAPOR TUBES

New Ceco 280M	\$1.98
New Ceco 866	\$2.95
Commander 210's, 250's and 281's	\$1.98
Odeon 280M	\$1.98
Odeon 866	\$2.85
Odeon H. D. 866	\$4.50
Odeon 281M	\$4.50

Above are net prices.

## RECEIVING TUBES

A twelve month test of the Tung-sol tube has convinced us that we can guarantee them to be superior in quietness and reliability. Complete line including Sparton types always in stock. Wholesale prices to dealers, servicemen and amateurs. All 224's are quick heaters. Tube service: Tubes of guaranteed mu and mutual conductance furnished, measurements made at cost. Tubes measured and duplicates of matched constants furnished. Estimates made.



TEL.  
5-2733

**Hatry & Young**  
203 Ann St., Hartford, Conn.

## TRUVOLT RESISTORS



**TIME**

*Save*



**LABOR**

*Save*



**EXPENSE**

**F**EWER resistors required in stock—and fewer sizes in the service man's kit. That's the happy situation when you use TRUVOLTS. And consider how easily repairs are made with TRUVOLTS—and the valuable time you save yourself and your customers. The exclusive TRUVOLT Adjustable Clips may be added, removed or set at any point for exact voltage values. Patented, open-air winding keeps TRUVOLTS cool.

MAIL COUPON FOR LITERATURE

175 Varick St., New York, N.Y.  
**ELECTRAD**  
INC.

ELECTRAD, INC., 175 Varick Street, New York.  
 Please send me complete TRUVOLT Literature and  
 special replacement volume control guide.  
 Name.....  
 Address.....  
 MR-2

MODEL "C"

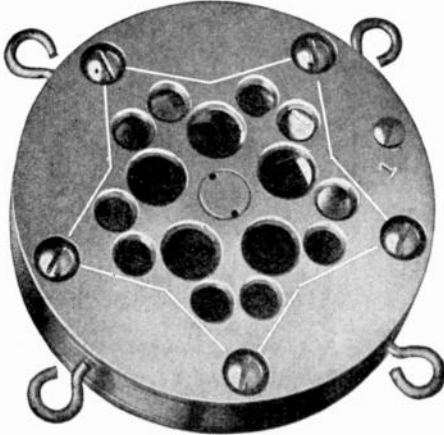

# NEW PRICE

Improved Double Button

## "STAR"

Microphone

Accepted as Standard  
from Coast to Coast

### NOW \$14.<sup>50</sup>

Satisfaction Assured, Sold on  
Money-Back Guarantee

THE GAVITT MICROPHONE has the following features:

1. Non-metallic diaphragm, not under tension.
2. Output level 12 to 20 D. B.'s higher than average microphone.
3. Flat output curve within voice frequencies.
4. Minimum carbon hiss due to non-metallic diaphragm.
5. Requires only 8 mils per button.
6. 200 Ohms per button impedance.
7. Solid brass construction, chromium plated.
8. Sufficient weight to damp out microphonics.
9. Diameter 3 1/4; 1/4 thick.
10. Packed in attractive plush-lined, steel pocket-carrying case.
11. Shipping weight four pounds.

## GAVITT MFG. CO., Inc.

BROOKFIELD, MASS.

# FREE 100 QSL CARS

Absolutely free with each year's subscription to the **AMATEUR RADIO BULLETIN** at only \$1.25.

This magazine is printed by hams, for hams, and for the benefit of amateurs. It is a get-together magazine for us hams, we take up where our big magazines leave off. Fiction, calls heard, technical articles, and a place to trade your junk off.

Send us a dollar and a quarter and we will do the rest.

## THE AMATEUR RADIO BULLETIN

Edited by George D. Tate

Box 536

Forest City, N. C., U. S. A.

## "MODERN RADIO'S" ANSWER FACTORY

How?—What?—Why?—Who?—When?

- A—Letter with one question . . . . . \$ .50  
No charge for small incidental pencil sketches.
- B—Additional questions, each . . . . . .25
- C—Schematic diagrams of battery-driven receivers up to 6 tubes, transmitters up to 5 tubes, antennas (other than beam types), switching schemes, metering, and power circuits of reasonable simplicity. . . . . .75
- D—Matters such as given under C, where all constants are desired . . . . . 2.00
- E—A. C. or D. C. circuits—without constants . . . . . .1.50
- F—A. C. or D. C. circuits with all constants . . . . . .3.00
- G—Transmitter diagrams of greater complexity, bibliographies, operating instructions, analysis of complex operating difficulties in apparatus, and other questions not covered by the above will be estimated on receipt of a clear and complete statement of the problem.

### NOTES

1. Keep a copy of your letter, including diagrams, numbering questions 1, 2, 3, 4 and lettering diagrams a, b, c, d.
2. The right is reserved to return remittances for any questions which it is impossible to answer.
3. No attention will be paid to radio-grams, telegrams or letters (other than those under class G) which are not accompanied by a remittance. Please use money order—loose cash may not arrive.
4. Address letters, "Modern Radio", 101 Allyn Street, Hartford, Connecticut.



## R. E. L. TUNER

Rear view of the new R. E. L. tuner, showing large plugin coil, untuned r-f stage, resistance-controlled regenerative detector and two-section variable condenser, one of which is driven by a



vernier dial for tuning purposes while the other is set for different minimum fixed capacities to give any desired spreading of a band.

(Continued from Page 3)

When in use the oscillator has both door and roof screwed fast for the sake of frequency stabilizing.

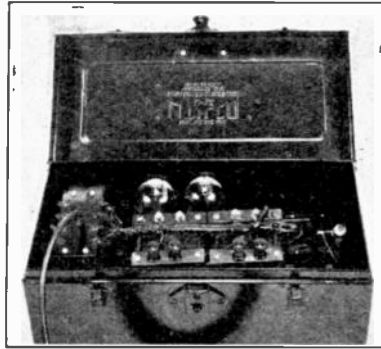

The power supply in its carrying case.

### Power Supply

Both sets can be operated on a portable power supply which consists of a steel carrying case in which is a normal A-B supply with a pair of '81 rectifiers, and a 2-section filter with a "bleeder" resistance.

# LAST CHANCE MODERN RADIO

AT \$1.25 PER YEAR

Subscribe or Renew Your Subscription at this Low Rate While You Can  
Only to March 1st

### COMBINATIONS—LAST CHANCE

*RADIO CRAFT*  
(Regular \$2.50) and  
*MODERN RADIO*  
\$2.85

*TELEVISION NEWS*  
(Regular \$2.50) and  
*MODERN RADIO*  
\$2.85

*SHORT-WAVE CRAFT*  
(Regular \$2.50) and  
*MODERN RADIO*  
\$2.85

*RADIO WORLD*  
(52 Issues, Reg. \$6.00) and  
*MODERN RADIO*  
(12 Issues)  
\$6.25

*CITIZENS AMATEUR CALL BOOK*—Reg. \$1.00  
and *MODERN RADIO* (Reg. \$2.00)  
Both \$1.99. ACT NOW!

(Offers Absolutely Void After March 1st)

MODERN RADIO CO., 101 Allyn Street,  
HARTFORD, CONN.

# Short Circuits



We don't know a millionth of 1 per cent. about anything.

*Thomas A. Edison.*

. . .

At last a use for dead spots—the radio field-strength car of the Department of Commerce works in cemeteries because the residents are not inquisitive.

. . .

A bargain is an article which is so little worth its original price that it must be sold for what it is worth.

. . .

A competent service-man with an ohm-meter seldom needs a receiver diagram. An ohm-meter, a little knowledge of circuits in general—and one can find the fault in almost any receiver. Of course finding the circuit doesn't do any good if one doesn't recognize the fundamental type it represents.

. . .

The best is cheapest in the long run; you only have to decide how long it must run.

. . .

Buenos Aires is larger than Chicago—and solvent.

. . .

Just when we begin to think the repair business is about ausgespielt—along comes the midget receiver.

. . .

Prosperity is a period during which money is worth so little that everyone has a lot of it and nobody will sell anything for less than a great deal of it; whereas depression is a time when everyone has very little money which is worth so much that anything may be bought with it.

*Page Twenty-Six*

Even though it be "dynamic", a speaker the size of a saucer is still a runt.

. . .

Brag—for the first time since 1492 the vicinity of Hartford is having a decent winter. There's been no snow in sight for weeks, and this is written on January 20th. Los Angeles papers please copy.

. . .

We are probably out of step—but we gaze with wondering amazement at \$111 stations sporting \$300 condenser mikes. The owner wants intelligible speech; he can transmit it with a good \$20 single button mike—and spends \$280 more for something he doesn't need.



**UNIVERSAL**

**2-Button  
Handi-Mike** **\$15.00**  
List

Maximum volume, minimum hiss, scientifically damped. Truly natural in tone and the most rugged microphone yet devised. No delicate parts to be damaged if dropped, jarred or roughly handled. For announcing, transmitting or home recording. Our Engineering Department is at your service. New catalog covers twelve models from \$5.00 up.

Universal Microphone Co., Ltd.,  
1183 Hyde Park Blvd., Inglewood, Calif.,

**MODERN RADIO'S  
RADIO-MAN'S QUICK REFERENCE  
POCKET BOOK**

for amateur, service man and experimenter. Usable Facts—not theories or arithmetic. Tells you what standard resistor, condenser, transformer, choke to use in  
**Building—Testing—Measuring—Repairing**  
—and tells you **HOW** to use them—  
(See Page 17, December)

Ready March 1st. Order now to avoid delay  
25c per copy, post-paid.

**MODERN RADIO COMPANY**  
101 Allyn Street, Hartford, Conn.

# STANDARD MERCHANDISE

## DISTRIBUTORS OF

Cardwell, Burgess,  
Electrad, Eby,  
R. E. L. National,  
Yazley, Pilot,  
I. R. C., Littelfuse,  
Tung-sol Tubes,  
Weston, Jewell,  
Readrite, Beede,  
Thordarson,  
Insuline, Gavitt,  
Polymet, Bakelite,  
Bliley Crystals,  
Wright-DeCoster,  
Odeon, Aerovox,  
Ward-Leonard,  
Centralab, Frost.

Order It,  
We Have It.

The chap wanting radio parts of national reknown, new, fresh from the factory and recently made, can order from Hatry & Young full of confidence. The entire H. & Y. stock consists of new, fresh parts in the current design, for certain items are renewed as many as twenty times a year.

Try H. & Y. You'll like our service and you can't beat our prices.



**Hatry & Young**  
Hartford, Conn.

Ask for Jewell, Weston or Readrite catalog

## Replacement Audio Transformers

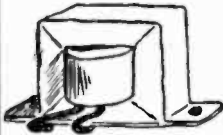

Style of All  
Replacement Types  
(See right.)

### PUSH-PULL OUTPUTS

1—247 into voice-coil of Dynamic. List \$4.00  
2—247's into voice-coil . . . . . List \$3.50  
1—245 into voice-coil . . . . . List \$3.50  
2—245's into voice-coil . . . . . List \$3.50  
As illustrated on left, excellent for midgets.  
Larger transformers, cased, \$6, \$8 and \$12 List  
according to grade—tone.  
Sizes for one or two 250's, 210's, etc., from  
\$3.50 to \$12 List. Sizes suitable for high-  
grade or public address amplifiers as well as  
all kinds of repair work.  
Also transformers for working into magnetic  
speakers from any of above tube combinations

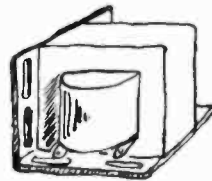

Optional Style  
of 3-1 A. F. and P. P.  
Inputs

at \$3.50 and up. Sizes for 112's and 171's  
in stock at similar list prices.

### OTHER AUDIO TRANSFORMERS

3—1 replacement A. F. . . . . \$2.25  
Push-pull input transformer . . . . . \$3.50  
Above transformers available in styles of both  
illustrations, specify, at List Prices given.  
Cased transformers—3-1 at \$2.50, \$4, \$5,  
\$6.50, \$10 List.  
Push-pull inputs cased at . . . . . \$6, \$10, \$12  
Push-pull interstages . . . . . \$12  
Grades for all purposes.

### MICROPHONE TRANSFORMERS

Single-button . . . . . \$ 5

Double-button . . . . . \$10  
Double-button best . . . . . \$20  
Exceptionally complete line of Audio Trans-  
formers of all types. Usual discounts from  
above List Prices to service-men, dealers,  
amateurs and experimenters. Prompt service.  
Polymet, Pilot, Thordarson, Sangamo, Amer-  
tran.  
Also replacement chokes 25-150 ma., power  
transformers for all tube combinations, in-  
cluding 250's, 281's, 484's. List Prices  
from \$1.50 on chokes, \$4.50 on transformers.  
Transmitting power transformers stocked. All  
types of filter condensers, etc. Try us—  
we have it.



TEL.  
5-2733

**Hatry & Young**  
203 Ann St., Hartford, Conn.



*Readrite*

NO. 550

## OSCILLATOR

(Licensed by A. T. & T. Co.)

**\$18** Net to dealer  
\$30 list

**\$21** Net to dealer  
with output meter

If not at your Jobbers we will ship direct when remittance accompanies order.

A sturdy modulated instrument carefully made. Completely shielded with separate battery compartment. Furnished with 22½-v. and 3-v. batteries and one '30 tube. Direct reading broadcast band (550-1500 kc.) and intermediate band (120-185 kc.). Also 260-262 kc. i. f. has sharp signals using second harmonic intermediate. Operating instructions attached in case cover with shielded wire leads. Very compact. In leatherette case, 6 x 11½ x 5½ in. Weighs but 8 pounds. Built to high standards.

Every serviceman should have the No. 550 oscillator to align r. f. gang condensers, locate defective r. f. transformers, adjust i. f. transformers, check oscillator stage and determine sensitivity of a receiver. A necessary instrument. Get yours today. Write for catalog of servicing instruments.

**Readrite Meter Works**

Established 1904

22 College Ave., Bluffton, Ohio

### ELECTRICAL LABORATORY OF JOHN L. REINARTZ, W1QP

Calibration of radio devices for the radio fan at ten cents a point for Wavemeters, Condensers, Inductances, Resistances. Correct to 1/10 per cent.

176 WADSWORTH STREET,  
SOUTH MANCHESTER, CONN.

### RALPH R. BATCHER

Radio Engineering Consultant  
Radio Receiver Designs, Testing and  
Laboratory Equipment, Special  
Apparatus and Models Developed  
To Order  
Member I. R. E.

113-35 198th St., St. Albans, L. I.

### ROBERT S. KRUSE, E. E.

RADIO ENGINEERING SERVICE  
Transmitter Improvements, Special Receivers,  
Measuring Devices, Radio Equipment Designed  
and Constructed.

Office  
101 Allyn St., Hartford, Conn. Tel. Hfd. 55326  
Laboratory  
103 Meadowbrook Rd., West Hartford, Conn.  
Tel. Hfd. 45327

### THE BAZAAR

Please abide by these rules:

1. 5c per word, payment with ad.
2. Ads for an issue must reach us the first of the preceding month.
3. Used, reclaimed or surplus items must be so described.
4. Please PRINT your name and address.
5. We reserve the right to refuse any part of an ad.
6. Ads designed to stand out cost extra. 7c a word all capitals, \$1.50 an inch for unfilled space.

WANTED—Microammeters or similar meters of 50 microamps. or less full scale (zero center galv. OK.). Resistance bridge units or complete bridge of standard make. State price, condition, etc. "Laboratory", care Modern Radio, Hartford.

WILL TRADE radio equipment for Winchester or Remington .22 Automatic Rifle. Gun must use standard cartridges. Pump or lever action considered. Want .25 Automatic Pistol. L. W. Hatry, 101 Allyn St.

The Bazaar sold a \$55 receiver for one amateur ten days after the issue carrying the ad was mailed. Try it, it can work for you. If the Bazaar does not produce results we'll refund. Your ad sent in now will appear in our March issue. "Modern Radio", 101 Allyn St., Hartford, Conn.

Big discounts on nationally known broadcast receivers. Write for price list. J. H. Barnes, 329 Washington St., Hartford, Conn.

(Continued from Page 15)

be quite negligible—assuming of course that ordinary judgment has been used to avoid the warming-up period, or other obvious sources of error such as taking the device from a cold to a warm room. Therefore a precise dial will permit one to measure small frequency variations in transmitters or in oscillating receivers during their normal operation. This is almost a necessity today.

### The Coil System

The coils are wound on National R-39 five-prong forms. The 80 meter coil was wound first. The number of turns on this coil and the moveable stator plate of the Cardwell 201e condenser were then adjusted to give 3,500-4,000 kc. between 20 and 80 on the dial. The same

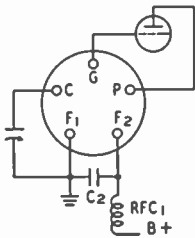

SOCKET  
WIRING

spreading was aimed at for the other bands by shifting the coil tap. This gave the coil dimensions as shown in the table.

### COIL TABLE

Band	20	40	80
Kc.	14,000-14,400	7,000-7,300	3,500-4,000
Dial range	19.5-82	16.5-79	19.5-83
L1 grid turn	12½	26½	43
L2 plate t'ns	5	11	15
Top	8¾	20½	none

Dial reading increases with frequency.  
All coils close wound.  
No. 22 D. S. C. meter grid coil.  
No. 24 D. S. C. 40 and 80 meter grid coils.  
No. 30 D. S. C. for all plate coils.  
Plate coil 5/16" from lower end of form.  
Space between plate and grid coil 1/8".  
Connection to grid of tube from top of coil in usual way.

My Grandmother occasionally ate a dill pickle, which she hated, just to keep her self-control working. On a similar basis the Commission might occasionally—but what a long vista that opens—

# A New Circuit

The Engineering Department of the Shallcross Mfg. Company has designed a general-purpose

## Combination Multi-Range Voltmeter and Milliam- meter, A.C. and D.C.

employing the new Weston A.C. and D.C. Type 301 Universal Meter and

# SHALLCROSS

## Super Akra-Ohm

Wire  Wound

# RESISTORS

The voltage range is from 5 to 1000 volts, 1000 ohms per volt and the current range is from 1 to 500 milliamperes A.C. and D.C.

A complete diagram and full information on the construction of this circuit are contained in our Bulletin 150-V, which also contains very useful information on the application of Akra-Ohm Resistors to multi-range voltmeters, ohm meters, etc.

*Our new Bulletin 150-V will be sent upon receipt of 4 cents in stamps.*

**Shallcross Mfg. Company**  
 ELECTRICAL SPECIALTIES  
 700 PARKER AVENUE  
 Collingdale, Pa.

# OVER 35,000 CALLS

LISTEN  
IN EVERY ISSUE



ALWAYS  
UP-TO-DATE

*Including New Call Letters  
Changes in Address  
Cancellations  
"Who's Who" on Short Wave  
International Calls  
and many other features*



IF YOU ARE INTERESTED IN SHORT WAVE TRANSMITTING  
OR RECEIVING YOU CANNOT AFFORD TO BE  
WITHOUT THIS BOOK

Radio Amateur Call Book contains Up-to-the-minute Changes in listing new calls, changes in address, and cancellations for over 25,000 licensed Amateurs in the United States and possessions, and over 10,000 licensed Amateur Stations in more than one hundred different foreign countries.

Each issue also contains High Frequency Commercial Stations, Who's Who on Short Wave, Special Stations and Expeditions, International Call Letters, New Prefixes, High Frequency Press and Weather, and Time Signal Schedules.

TRULY THE GREATEST LIST OF CALLS PUBLISHED  
UNDER ONE COVER

SINGLE COPY \$ 1.00      ANNUAL SUBSCRIPTION \$ 3.25

Issued Quarterly—March, June, September and December

ORDER YOUR COPY TODAY!

**RADIO AMATEUR CALL BOOK, INC.**

608 S. Dearborn Street

Chicago, Ill., U. S. A.

The Largest Exclusive Makers of Mercury  
VAPOR RECTIFIER TUBES

866 SPECIAL 90 DAY GUARANTEE \$2.<sup>85</sup>



ODEON LO-RIPLE  
Mercury Vapor Rectifier Tubes



Type	Filament		Plate Inv. Peak		Price
	Volts	Amps.	Volts	Amps.	
* 866 HEAVY DUTY	2.5	5	7500	.6	\$ 4.50
** 81M	7.5	5	7500	.3	4.00
*** 866B	5	5	7500	1.2	7.00
872	5	10	7500	2.5	12.00
875	5	12.5	15000	2.5	25.00
869	5	20	20000	5.0	100.00

\* THE HEAVY DUTY 866 is guaranteed to give the life of any two ordinary 866 tubes.

\*\* This 81M Tube has a higher rating than any similar tube made.

\*\*\* The 866B is our own design as an intermediate between an 866 and an 872. All Tubes guaranteed to reproduce low A. C. ripple.

Mercury Vapor Tubes built on order ranging from 1 Volt, 1 Amp., to 20,000 Volts, 30 Amps.

**COMPANION SPECIALS**  
R. C. A. Wave Traps.....\$ .65  
Swan Haverstick Antenna  
Sockets......45  
Excel Noise Filter..... 2.95

**R. C. A. High Voltage Surge Proof Condensers**  
0.5 Mfd. Cap...\$0.25  
1.0 Mfd. Cap... .30  
2.0 Mfd. Cap... .45  
4.0 Mfd. Cap... .80



**Utility Heavy Duty Power Transformer**  
85 Watts.....\$2.25  
Will handle 5 Heater Type Tubes.  
One 280 and two 245 or two 247 Tubes.  
Same in Metal Shell.....\$3.00



**New Loftin-White Direct Coupled Amplifier**

Completely Wired Fully Guaranteed  
Model 245, \$9.95  
Model 247, (Pentode) \$10.95



**Rectifier Charger Bulbs**

Six months guarantee.  
.06 Amp.....\$2.15  
2. Amp., both contacts..... 2.15  
5-6 Amp..... 3.85  
15 Amp..... 6.85

**SPEED-BUG TELEGRAPH**

**KEY**  
\$10.50

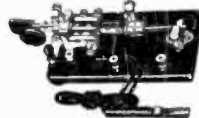

Made for and approved by U. S. Signal Corps. Clear, sharp, fast signals.

NOTE—All orders must be accompanied by 20% deposit, balance shipped C. O. D. If remitting in full or foreign order include postage.

MAIL TO  
**ODEON MFG. CO.**  
30 Clinton Street NEWARK, N. J.

# Powerful Short-Wave RECEPTION

## NATIONAL

### NC-5 SHORT-WAVE CONVERTER

#### NATIONAL NC-5 Short-Wave Converter Most Powerful Made

No trouble to connect this powerful NC-5 to any radio set. Simply move the antenna wire from the set to the proper binding post on the converter; connect the converter wire to antenna post on the set and plug the electrical connection into baseboard alongside the one that goes to your set. No need to disconnect when receiving ordinary broadcasts.

#### WORKS WITH ANY SET

Owing to the super-power of the NATIONAL NC-5 Converter (there are two extra stages of amplification), it will bring in broadcasts and code on short-waves from all over the world on any radio set.

#### SINGLE CONTROL TUNING

Specially designed to make circuits "track" each other accurately. No interlocking or "dead spots." Operation is stable over the range.

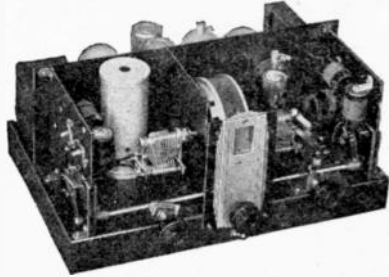

#### NO PLUG-IN COILS

The NC-5 Converter has a new coil-switching system with practically perfect results for converter use, but without the inconvenience of plug-in coils. The new design helps, but R-39, the remarkable low-loss dielectric really makes it possible. No ordinary insulating material works as well. There is no intercoupling between coils.

*A Change in Color of Dial-Light Indicates Which Coils are in Circuit*

Attractive—Compact  
Size, 8"x17½"x12". Standard Model 4  
In beautiful finished metal cabinet

#### DE LUXE MODEL

In hand-rubbed solid mahogany case with genuine inlay in front panel. Harmonizes with the most beautiful radio sets



## NATIONAL

### SW-45 A. C. & D. C. THRILL-BOX

For those who wish to go into serious short-wave reception of broadcasts or code, or for experimental purposes the NATIONAL SW-45 THRILL-BOX is recommended.

#### READ WHAT USERS SAY:

"Truly a masterpiece in the SW field." . . .  
"No comparison possible with other receivers."  
"Works perfectly and surely brings in the DX." . . . "Have had years of SW experience and I have never seen a receiver that nearly approaches the NATIONAL SW-45 THRILL-BOX in performance." . . . "5 continents and 23 countries received." . . . "They don't make SW Receivers better than the NATIONAL SW-45." (Names on request.)

#### HIGH-LIGHTS ON THE SW-45

Range 9-2000 meters. Extremely high signal to noise ratio. True single-knob tuning. Set and forget the antenna trimmer. Easy to log with NATIONAL projector Dial, type H, no parallax. Special 270° Type S. E. Tuning Condenser with insulated main-bearing and Constant-impedance pigtail makes gang-tuning possible on the short waves. Equipped with standard set of 4 pairs of R.F. Transformers covering range of 15 to 115 meters wound on forms of genuine NATIONAL R-39. Uses the new UX-235 Variable Mu tubes, giving improved sensitivity and less critical operation. Humless A.C. Power Supply with special

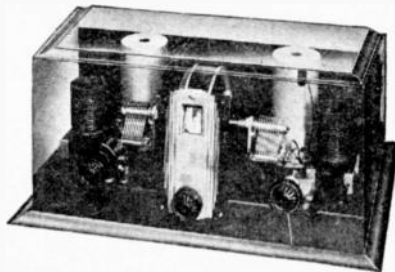

filter section. R. F. Filter on Rectifier Tube, and Electrostatic shield. R. C. A. licensed. Made also in low drain battery model.

NATIONAL COMPANY, INC.,  
61 Sherman St., Malden, Mass.

Gentlemen:

(Check which)

- ( ) Please send me complete information and prices on your new NATIONAL NC-5 Converter.
- ( ) Please send catalog sheets on the improved SW-45 THRILL-BOX.
- ( ) I enclose 50c (stamps or coin) for your 64-page Handbook of Short-Wave Radio, describing in full the latest and best short-wave receiving circuits, adapters, meters, etc.

Name.....

Address.....

MR-2-32