

IN THIS NUMBER  
**Television and the Telephot**

PRICE 10 CENTS

DECEMBER, 1909

Vol. II.

No. 9

# MODERN ELECTRICS

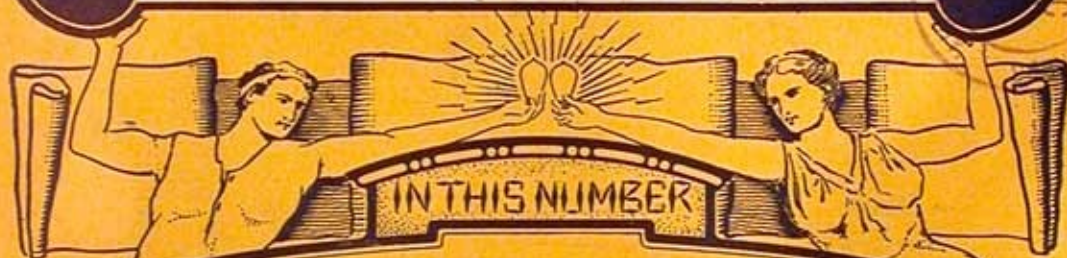

A collection of technical diagrams and illustrations. At the top left is a telegraph tower with multiple lines. To its right is a diagram of a battery connected to a light bulb. Further right is a diagram of a transformer or coil. On the far right is a diagram of a telegraph receiver or similar device. Below these are several other diagrams: a cylindrical component on a base, a rectangular box with a dial, a large rectangular device with a handle, and two circular components. The diagrams are arranged around a central text block.

**TELEVISION AND THE TELEPHOT**

By H. Gernsback

**HOW TO CONVERT A D. C. DYNAMO  
INTO AN A. C. ONE**

By H. W. Secor

**AIRSHIPS AND WIRELESS TELEGRAPHY**

By Our Berlin Correspondent

**BI-POLAR SELECTIVE SWITCH**

By Walter E. Keever

**SECONDARY COIL IMPREGNATION**

By C. C. Whittaker

**COLIN & JEANNE RADIOPHONE**

By A. C. Marlowe

**DETECTORS**

By George P. Worts

**MEASUREMENT OF ELECTRIC WAVES**

By M. A. Deviny

**WIRELESS ASSOCIATION OF AMERICA**

**"THE ELECTRICAL MAGAZINE FOR EVERYBODY"**

Copyright 1909, by MODERN ELECTRICS PUBLICATION.

N. S. E.

# FREE A BOOK OF VALUABLE IDEAS FOR BEAUTIFYING THE HOME



WE will send you free of charge our book "The Proper Treatment for Floors, Woodwork and Furniture," two sample bottles of Johnson's Wood Dye and a sample of Johnson's Prepared Wax.

This text book of 50 pages is very attractive—80 illustrations—44 of them in color.

The results of our expensive experiments are given therein.

There is absolutely no similarity between

## Johnson's Wood Dye

and the ordinary "stain." Water "stains" and spirit "stains" raise the grain of the wood. Oil "stains" do not sink below the surface of the wood or bring out the beauty of the grain. Varnish "stains" are not stains at all. They are merely surface coatings which produce a cheap, shiny, painty finish. Johnson's Wood Dye is a dye. It penetrates the wood; does not raise the grain; retains the high lights and brings out the beauty of the wood.

FOR ARTISTIC COLORING OF ALL WOODS IN THE FOLLOWING SHADES:

- No. 126 Light Oak
- No. 123 Dark Oak
- No. 125 Mission Oak
- No. 140 Manilla Oak
- No. 110 Bog Oak
- No. 128 Light Mahogany
- No. 129 Dark Mahogany
- No. 130 Weathered Oak
- No. 131 Brown Weathered Oak
- No. 132 Green Weathered Oak
- No. 121 Moss Green
- No. 124 Forest Green
- No. 172 Flemish Oak
- No. 178 Brown Flemish Oak
- No. 180 Silver Gray

## Johnson's Prepared Wax

will not scratch or mar. It should be applied with a cloth; dries instantly—rubbing with a dry cloth gives a velvety protecting finish of great beauty. It can be used successfully over all finishes.

We want you to try Johnson's Wood Dye and prepared Wax at our expense. Fill out the attached coupon being careful to specify the shades of dye wanted. We will mail you promptly the booklet and samples. Do not pass this page until you have mailed the coupon.

S. C. Johnson & Son

Racine, Wis.

"The Wood Finishing Authorities"

**Please use this FREE COUPON**

I accept your offer of Free Booklet Edition M. E. 12 and two sample bottles of Johnson's Wood Dye. Send me shades Nos. .... and one sample can of Johnson's Prepared Wax.

Name.....

Address.....



# Remarkable Sacrifice Sale of Valuable Books

**W**E are closing out, at a bargain, a few sets of the "**Makers of American History**," a library of popular biography which contains some of the most interesting and instructive reading ever published. In these 20 large and beautiful volumes will be found the life-stories of forty-two great Americans — men who moulded the history of the nation. Each biography is a complete story in itself, written by some eminent authority, such as Capt. A. T. Mahan, Gen. J. G. Wilson, Gen. Fitzhugh Lee, Prof. W. G. Sumner, James Schouler, and others equally well known. One volume is devoted to Abraham Lincoln, in whom centers special interest in this centenary year. The narrative of American history from the earliest times down to the close of the Civil war period is interwoven in these lives.

## No Other Work Like It

To read these volumes is to be grandly entertained and at the same time to come into intimate contact with the great heroic characters in American history. This is the only work which covers the whole field and is at the same time of distinguished authorship. For an hour's pleasant reading or for serious study no other work will compare with it. There is not a dull page in the entire 20 volumes, which are beautifully printed, bound in art cloth, and illustrated with portraits and other illustrations, maps, plans, etc. Every hero and patriot is treated, not in the dry and technical form so common to biography, but in a simple, fascinating style that will appeal to all who enjoy good, wholesome reading.

**20 Beautiful Volumes**  
**29 Able Authors**  
**42**  
**Popular Biographies**  
**7,568 Ample Pages**  
Actual Size of Volumes,  
7½ x 5½ in.

### Here's Our Great Offer

We have on hand a few sets of this splendid library which, from handling in our stock room are not in perfect condition. For all practical purposes they are as good as new; in fact, an expert could hardly tell the difference. The lot is so small we have decided to close them out for \$1.00

M.E.  
12-9.

down and \$1.00 a month until the full amount of the special limited clearance price, \$19.50, has been paid. The subscription price is \$30.00.

## FREE — for 5 Days

On receipt of the accompanying coupon, we will send you the complete set, 20 beautiful volumes, carriage paid, for five days' examination. Note our liberal offer. The books are subject to return at our expense if you do not find them, as we claim, a most unusual bargain. **Do you think you can afford to miss this chance?**

**THE UNIVERSITY SOCIETY,**  
44-60 EAST 23rd STREET,  
NEW YORK.

**SPECIAL COUPON**  
THE UNIVERSITY SOCIETY, New York.  
Please send me pre-paid, for examination, a slightly rubbed set of the "Makers of American History," in 20 volumes. If satisfactory, I will pay you \$1.00 on acceptance and \$1.00 a month thereafter until \$19.50 has been paid. If not satisfactory, I will notify you, so that you may arrange for its return at no expense to me whatever.

Name.....

Address.....

When writing please mention "Modern Electrics."

# MODERN ELECTRICS

Vol. II.

DECEMBER, 1909.

No. 9

## Television and the Telephot

By H. GERNSBACK.

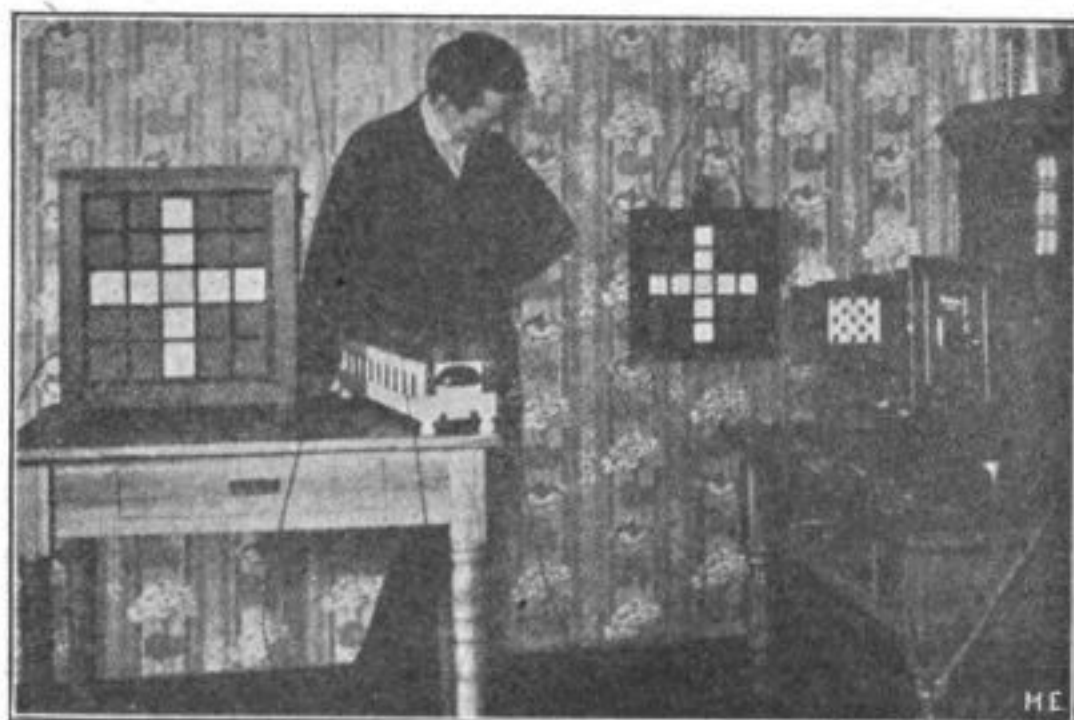

Fig. 2

Every now and then we see newspaper reports that Mr. So and So has discovered the real secret of television, only to be told again a few weeks afterwards that it has not been realized after all.

For 25 years almost, inventors all over the world have been working strenuously to solve the problem, but so far none succeeded, apparently because they all seem to work along wrong lines.

The principle of television may be briefly stated thus: A simple instrument should be invented which should reproduce objects placed in front of a similar instrument (called Telephot) at the other end of the line. In simple language, it should be possible to connect two mirrors electrically, so that one would show whatever object is placed before the other one and vice versa.

As in a mirror, the objects must be reproduced in motion (at the far-off station). The theory further requires that both instruments (one at each end) must be reversible, that is, each instrument must receive as well as transmit.

A good parallel of this requirement is found in the ordinary Bell telephone receiver. As is known, the Bell receiver (without the use of a microphone transmitter) will receive as well as transmit, that is, one can talk in a receiver and

also hear the other party, using one and the same instrument.

In the Telephot it should be possible to see the party at the other end while that party should see you, both through the medium of your Telephot.

Unlike the mirror, however, you should not be able to see your own picture in your own Telephot. In this the Telephot differs from the mirror analogy.

From this it will be seen immediately how difficult the problem becomes, as if you could see yourself in your own Telephot, as well as the picture of your friend, it is obvious that there would be a "mix-up" of personalities, the consequence being that you could not recognize your friend nor yourself, while your friend at the other end could of course not recognize you nor himself.

In the telephone the case is not so difficult, as it is absolutely necessary that one party talks while the other listens; if both talk and listen, none can understand, as the voices mix up.

In the Telephot this parallel does not hold good, as there is nothing to restrain you from looking at your friend at the same time he is looking at you.

Of course the problem can be simplified by getting the true parallel of the

telephone, thus: When you wish to see A you keep in the dark, while A stands in full light. If A wants to see you he turns off his light while you switch on yours.

However, this would be impracticable and is not the true solution of the Telephot.

So far most inventors seem to think that the problem can only be solved by means of the selenium cell, which being sensitive to light, can send out electrical impulses in the same ratio as the light falling upon the cell. Thus, if a strong light is thrown on a selenium cell a strong electric impulse is sent over the line which when operating a light relay (described below) can be made to throw a strong light upon a screen.

As a picture is made up of nothing but light and dark points it is easily to be seen that if several thousand very

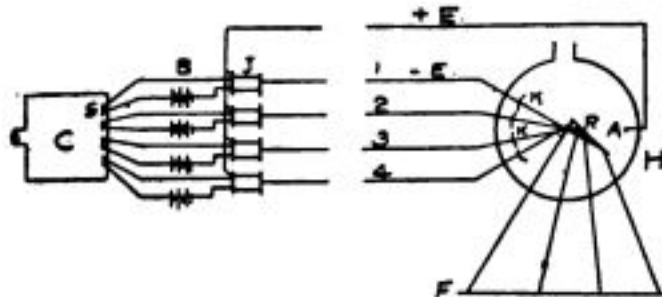

M.E.

-FIG 2-

small selenium cells were arranged in a plane and just as many light relays at the other end, a good picture could be projected upon a screen—in theory. The trouble is that it is practically impossible to make two selenium cells with equal sensitiveness and just this is the most important part, as if one is not as sensitive as the other, it will of course not transmit the same impulse as the former. It can be imagined easily what kind of a picture a station would transmit having several thousand selenium cells, all of a different sensitiveness!

Then the next trouble is that each cell at best requires one wire (the ground *might* be used as return). Think of two stations which, in order to work, require 3,000 to 5,000 separate wires! This seems to be as bad or worse than Sömmering's first telegraph (in 1809), which required 27 wires to operate. In Morse's subsequent telegraph only one wire is required, which unquestionably will be the case with the perfect Telephot.

Another great trouble with the selenium cell is that it works sluggishly, that is, its resistance will not drop instantaneously from the highest value to the lowest, which is a bad feature, as it would necessarily blur the picture at the other end. Furthermore, to work anywhere satisfactorily the selenium cell requires strong light.

The writer does not wish to throw cold water on selenium and selenium cells, as it is quite possible that the latter may be improved to such an extent as to do entirely away with the shortcomings mentioned above, although the greatest difficulty, the one that each cell requires at least one wire, is and will be the far greatest stumbling block.

Many different systems have been proposed in the past to solve the problem by means of selenium cells and although the list is quite long only a few will be mentioned in this article, as all systems are more or less on the same lines.

A. Knothe proposes to solve the problem as follows: C (Fig. 1), represents a camera into which the lines coming from the batteries enter. The space between each pair of wires is bridged by a selenium cell S. If now light enters the camera it falls on S (and all the other cells), and closes the current which operates the spark coils J. This furnishes a discharge as a single ray in the X-Ray pipe H at the receiving station E. This single ray is thrown as a single point on the fluorescent screen F.

It is understood that several hundred cells, spark coils and parabolic mirrors K are necessary to transmit a picture. The X-Ray tube would therefore necessarily be of monstrous dimensions. All the wires, 1, 2, 3, 4, up to several hundred, must of course, be well insulated, so that no sparking occurs between them.

All these requirements make the arrangement almost impossible and quite impracticable.

The latest "Telephot" has been designed by Mr. Ruhmer, the well-known Berlin expert. Last June Mr. Ruhmer demonstrated a working model, which although it did not transmit pictures, served well to demonstrate the usefulness of the selenium cell for certain purposes.

Fig. 2 shows the model clearly. The principle is as follows:

The transmitter has 25 squares, each containing a selenium cell. If any one

of the 25 cells is exposed to light, it operates a sensitive relay, which sends an alternating current of a certain frequency over the line.

At the receiving end one resonating relay is stationed for each selenium cell at the sending station. The impulse sent from the selenium cell therefore operates only that relay having the right frequency.

Each relay operates an incandescent lamp which is placed in the same square at the receiver as the selenium cell at the transmitter.

If several cells are exposed to light at the transmitter, several alternating currents, but all of different frequencies are sent over the line. These currents do not mix, but operate only the relays for which they are intended.

These in turn operate the lamps in the various squares, assigned to them.

Mr. Ruhmer has perfected the selenium cell a good deal, and as his model worked very rapidly, it will be seen that the sluggishness of the cells has been overcome to a certain extent.

Simple geometric figures were transmitted quite successfully as can be seen in the photograph, where 9 squares at the transmitter were lighted and the same amount, in the same position were reproduced at the receiver. This is quite remarkable if it is remembered that only *one wire* is used between transmitter and receiver.

Mr. Ruhmer intends to build a transmitter containing 10,000 cells, to reproduce pictures at the Brussels international exposition in 1910. The cost will be over one and a quarter million dollars and the writer is of the opinion that it is almost impossible to operate such a model on account of the 10,000 different frequencies necessary to accomplish the result.

A simpler way could be brought about by the idea proposed by the writer some eight years ago.

Fig. 3 represents the well-known electrical harmonica, which for the sake of those not knowing the instrument, is described herewith:

A musical steel harp H is fastened to a permanent magnet NS. If any one of the steel harp-prongs is touched it will swing back and forward, at the same time sending an induced current through the windings of the electromagnet E. If we connect a similar instrument H

through the line l, and ground LL' to H' it is evident that if we touch any of the steel prongs of one of the instruments, the same steel prong on the other will be made to swing. If we have 12 prongs on each instrument and we touch prongs No. 1, 6, 9, 12 of H', all at the same moment, prongs No. 1, 6, 9, 12 of H will be made to sound at the same time too, and so on.

Suppose we build such a harmonica having, say, 500 prongs P, Fig. 4, each responding readily at an extremely light touch.

Exactly over each of the 500 prongs we place a minute electromagnet E, 500 in all (only 6 shown in illustration), so when one of the small electromagnets is actioned by means of a weak alternating current flowing through same it will cause the prong underneath it to swing as long as current flows through the electromagnet.

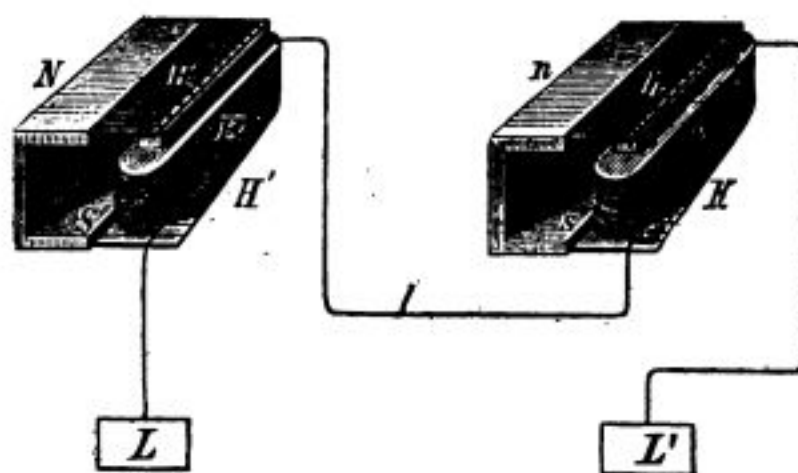

Fig. 3.

Now each of the small electromagnets is connected to a selenium cell of which 500 are placed in a plane.

It will be easily seen that if one or more of the selenium cells are acted upon by light, one or more of the small electromagnets is acted upon AND AS A PROPORTIONATE AMOUNT OF CURRENT IN PROPORTION TO THE INTENSITY OF LIGHT at the selenium cell flows through the small electromagnet, or electromagnets, it will cause the prong or prongs to vibrate IN THE SAME PROPORTION OF INTENSITY as the light falling on the selenium cell.

Thus if cell No. 1 is lighted with 10 C. P., assume that the small electromagnet connected to it causes its prong to swing through the distance of one millimeter. Then if cell No. 50 is only lighted with the intensity of 1 C. P., prong No. 50 will of course only swing 1-10 millimeter and so on. Thus each prong

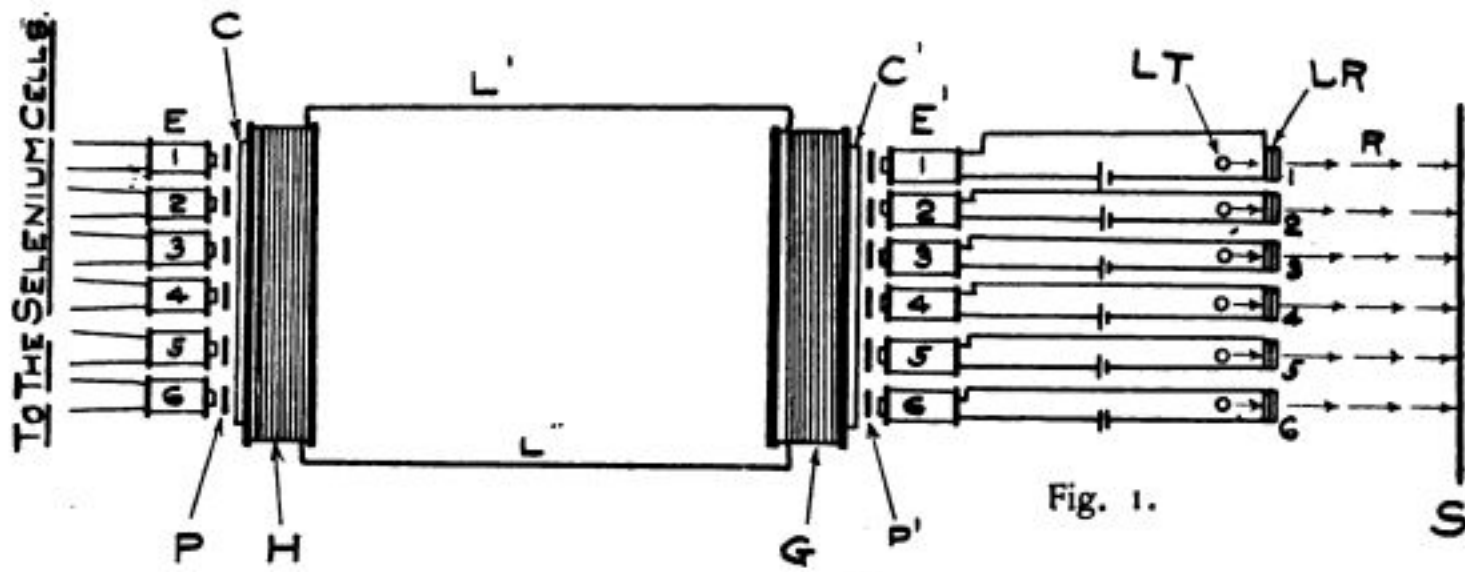

Fig. 1.

will be caused to swing in exactly the same proportion as the amount of light falling upon the selenium cell, to which it belongs.

As each prong swings it sends a current over the line L' L''. If now No. 1 and No. 6 of the electromagnets are energised through the selenium cells both cause their prongs to swing and send impulses over the line. At the receiving station G, prongs 1 and 6 must swing **IN THE SAME PROPORTIONATE**

energies and the screen is lighted with 100 energies and so on.

Thus it will be seen that if we have enough selenium cells at H and enough light relays at G any picture in motion will be transmitted correctly and reproduced in its true phases on the screen S.

It is only a matter of building the apparatus and instruments with sufficient precision.

The light-relay used in some of the writer's experiments is described here-with:

A light-relay is an instrument which has the purpose to utilize very weak electric impulses to throw a beam of light on a screen, which in intensity is proportionate to the strength of the electric impulses. In other words, if the impulses are strong, a large amount of light is caused to fall on the screen; if the impulses are weak, a small amount of light falls on the screen, and so on.

Fig. 5 shows the instrument in the perspective. Between the poles of a strong electromagnet NS, two extremely fine metal wires A and A', are stretched. The wires may be stretched more or less by the regulating screws o and o'.

The two poles N and S, are each provided with a hole O and O', through which light rays are sent in the direction p, p'. On the two wires, A and A', a very light piece of aluminum foil B is attached in such a way that no light can pass from O to O' normally.

If, however, a weak current passes from a to a1, the aluminum foil is deviated in the direction f or f1, as the case may be. In order to obtain very exact motions of the foil the thin wires are best replaced by fine metal bands 0.01 millimeters thick, 0.25 millimeters wide and about 6 centimeters long. The resistance of each band is about 75 ohms.

As far as the writer knows his plan so far is the only feasible one which can

(Continued on Page 416)

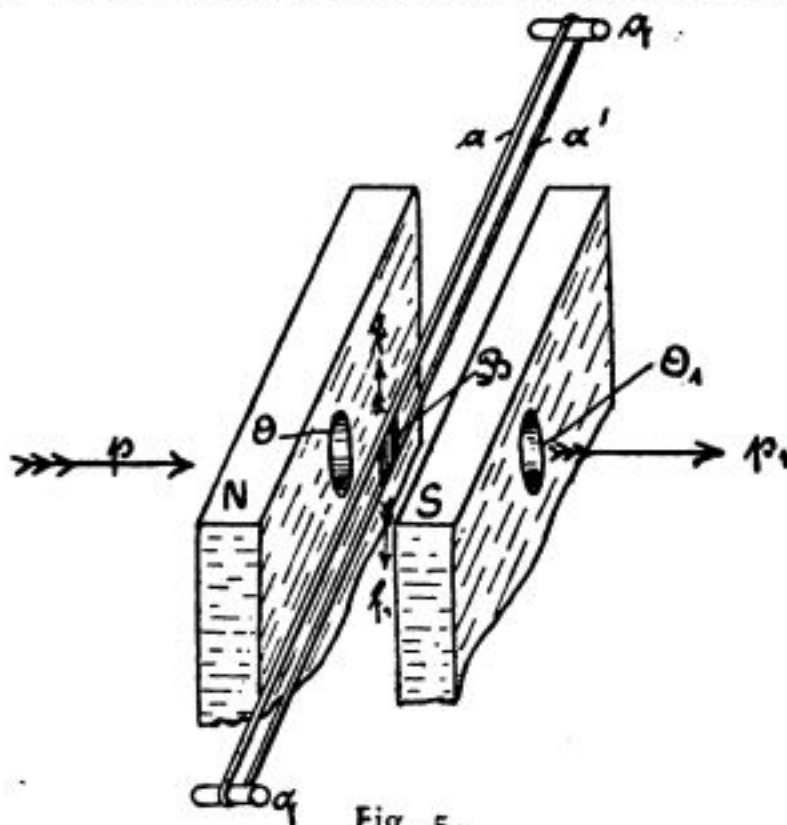

Fig. 5.

**INTENSITY** as the prongs at the sender H, consequently electromagnets E'1 and E'6 are energised (the prong acting as a telephone diaphragm, the electromagnets having for core a permanent magnet). E'1 and E'6 now operate the light relays LR1 and LR6.

Now, then, if the selenium cell connected to E1 is lighted with, say, 10 C.P., a proportionate amount of energy—call it 10 energies—are received at LR1. The light relay therefore passes 10 energies of the small tungsten lamp TL through its opening, and 10 energies are projected on the screen S. If the cell connected to E6 receives the light of 100 C. P. it is evident that LR6 receives 100

# How to Convert a D. C. Dynamo or Motor Into An A. C. One

By H. W. SECOR.

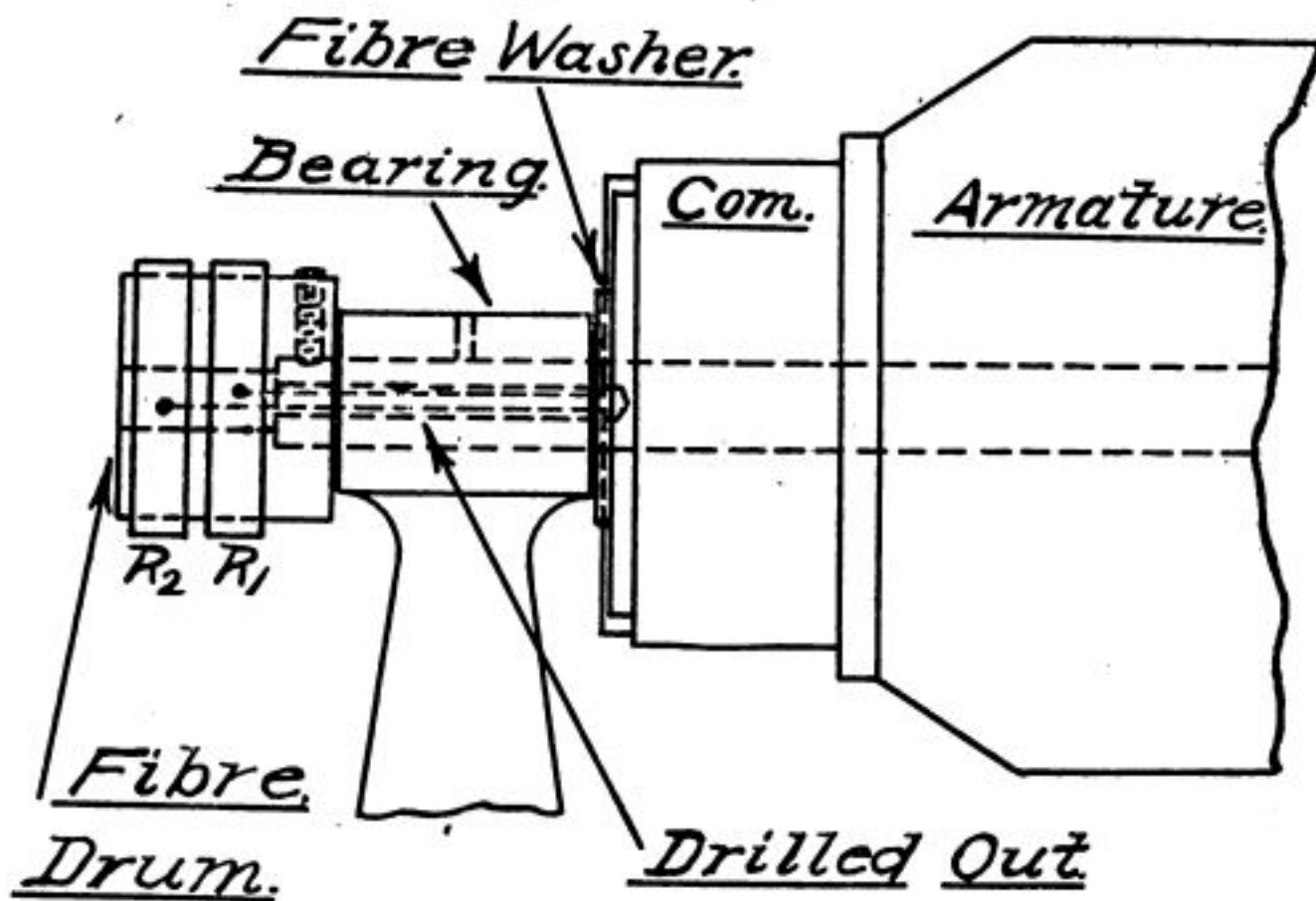

— Fig. 2 —

In the present article the writer will endeavor to describe some points about alternating current which may be of use to wireless experimenters.

The source of supply generally is from a commercial 110 vt. 60-120 cycle circuit, but this is not available by every one, and as the A. C. transformer has so many good points to commend it for use in wireless telegraphy, a method will be described for obtaining A. C. from a motor or dynamo wound for D. C. Many experimenters own a fair sized D. C. dynamo, say  $\frac{1}{4}$  to 2 H. P. which may be used to good advantage to supply A. C. when arranged as below.

It is advisable that the machine be wound for a voltage of anywhere from 80 to 220 volts. If not giving a D. C. voltage within the above limits, it should be rewound. To obtain a single phase A. C. from a two-pole or bipolar field D. C. machine, connect two brass slip rings, R, and R2 to two directly opposite points on the commutator, as shown in Fig. 1, where B and B2 are the D. C. brushes bearing on the commutator, and b and b2 are the A. C. brushes bearing on the two slip rings, which can be mounted and wired as shown in Fig. 2. The fibre

drum carrying the two rings is clamped onto the end of the armature shaft, by means of the set screw shown. A hole is drilled through the centre of the shaft to bring the two wires out to the slip rings. The wires are brought down through the fibre washer through two small holes in the side of the shaft into the large centre hole.

The connections for a machine having four field poles and a drum wound armature are given in Fig. 3. By connecting another set of slip rings to the points marked x, and x2 in Fig. 1, two phase A. C. can be taken from the machine. If three slip rings connected at points  $120^\circ$  apart on the commutator are utilized, it is possible to obtain a three phase A. C. Supposing, now, that the machine has been fixed up to supply A. C. The frequency of any pole machine will be, cycles per second = R.P.M.  $\times \frac{1}{2}$  No. field poles. For a bi-polar machine, running at, say, 3,600 R.P.M., or 60 R. P. second, the frequency will equal  $60 \times 1 = 60$  cycles per second, or 120 alternations.

The machine may be driven by its pulley from an engine or water-wheel, in which case 85 per cent. of the D. C. power rating will be available in A. C.,



i. e., if the D. C. rating was 10 H. P., the machine would give 8.5 H. P. in single phase A. C. The voltage is 70 per cent. of the D. C. voltage rating. If the D. C. voltage is 110 volts, the A. C. volts will be 77 volts. Another method of operating the machine is to supply D. C. to commutator brushes, running it as a D. C. motor, when A. C. may be taken from the slip rings. In this case it is evident that the machine must have sufficient power to equal the motor power + the generated power, or else the machine will be overloaded and burn out.

The machine may be operated as a synchronous S. P. A. C. motor from an A. C. circuit and supply D. C. power from its commutator brushes.

The A. C. is generally fed to a high tension transformer, with a suitable key for breaking up the current into dots and dashes, interposed in the primary circuit. See diagram, Fig. 4.

It is sometimes desired to run an ordinary induction coil on A. C. This may be connected up (with the vibrator cut out) to operate satisfactorily by putting an electrolytic interrupter in series with the primary circuit and the key.

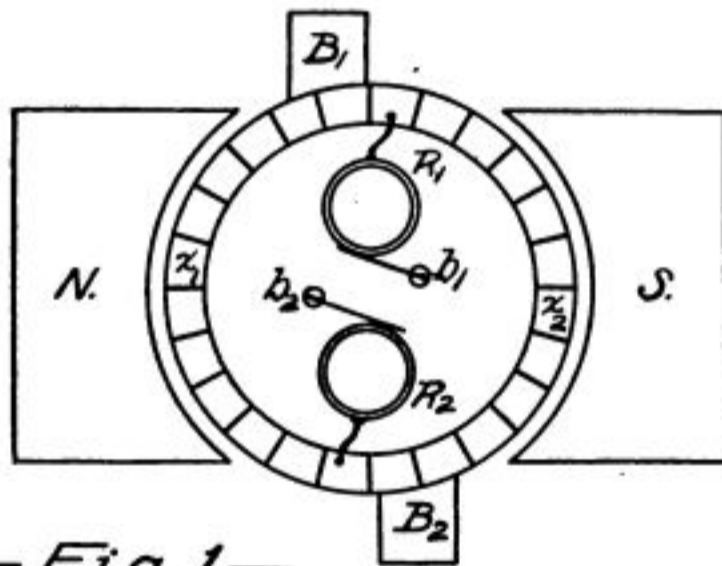

-Fig. 1-

A word may be said here as to the measurement of A. C. Many stations have an A. C. voltmeter and ammeter connected up on their A. C. supply circuit to show how much power is being used. But, here is where many a mistake is made in multiplying the volts by the amperes, as read off the above named instruments, to find the watts used. It is most always the case that this is erroneous, due to the E. M. F. and the current not being in phase, the current lagging behind, owing to inductive effects of the circuit. A compensated direct-reading wattme-

ter, if connected into circuit, will indicate the true or actual watts being used, while the volts resultant from the product of the volts by the amperes is what is known as the apparent watts, usually rated in kilovolt amperes, a kilovolt-ampere being 1,000 watts.

The true watts divided by the apparent watts gives a ratio called the

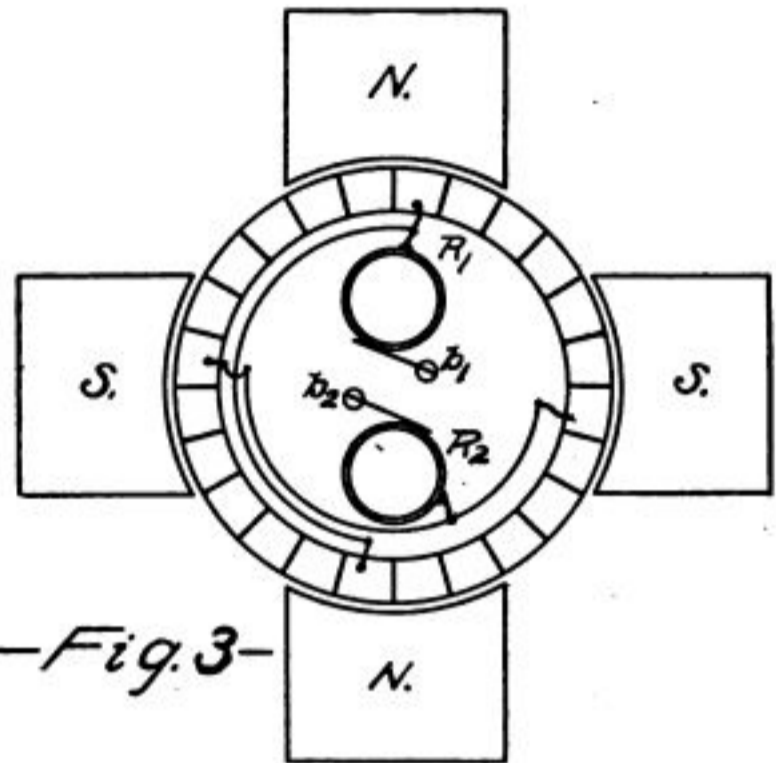

-Fig. 3-

power factor. From this it will be seen that, knowing the power factor and the apparent watts, the true watts can be found by multiplying the apparent watts by the power factor. Example:

An A. C. voltmeter and ammeter read respectively 110 volts and 20 amperes. The product of these is 2,200 watts, or 2.2 kilovolt-amperes. A watt-

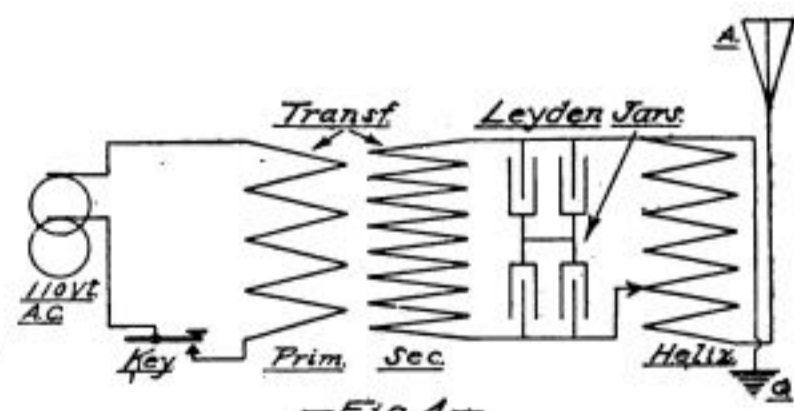

-Fig. 4-

meter is connected into circuit simultaneously, and registers 1,800 watts or 1.8 K. W. The power factor is then

$$P. F. = \frac{1.8}{2.2} = 0.81.$$

Now, 2,200 watts, multiplied by .81 = 1,782 watts, the actual watts being used. This latter does not quite balance, owing to the decimal places not being carried far enough in the power factor.

# Airships and Wireless Telegraphy

BY OUR BERLIN CORRESPONDENT.

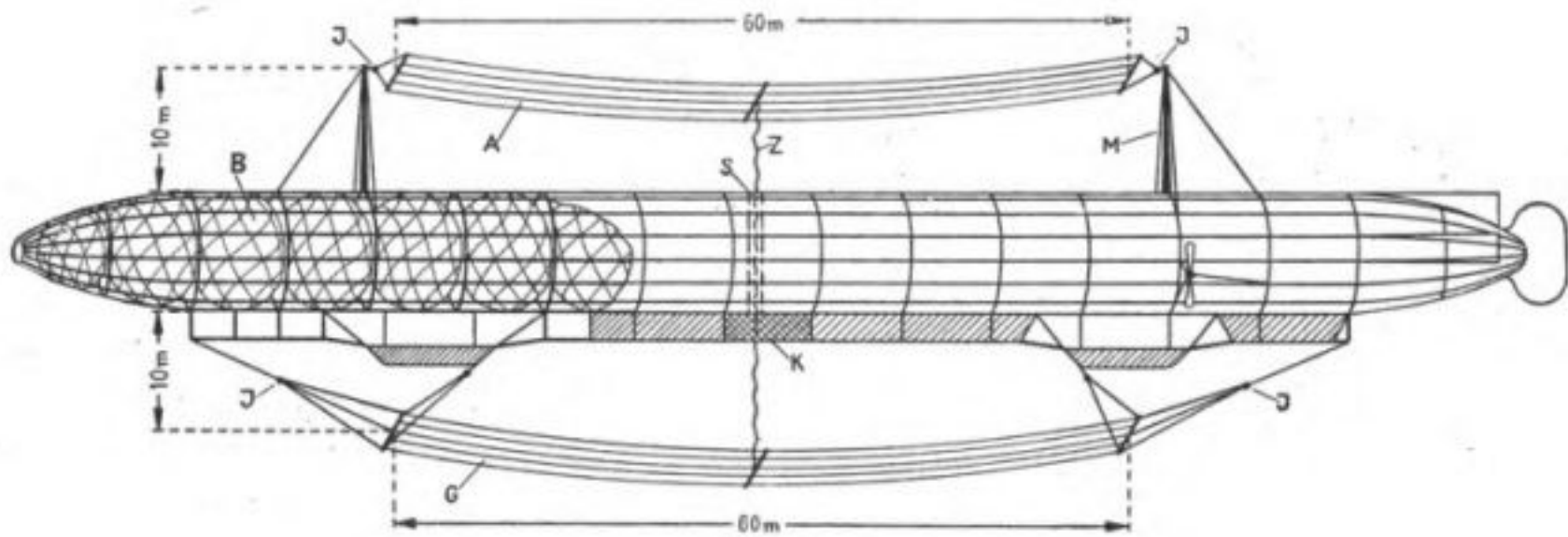

Fig. 1.

How serious the German people consider their present gas-carrying airships and how much they believe in the future of the Zeppelin airship type, is shown in a long article appearing in one of the German periodicals.\*

Although Americans have little or no faith in the Zeppelin and kindred airships, and firmly believe in the heavier-than-air machines, it is interesting to note how strenuously the Germans are trying to gain supremacy of the air by their present gas-carrying types, and they are already equipping their airships with wireless telegraphy in order to use them more efficiently in warfare.

Wireless telegraphy in airships is not a new idea. In fact, it was suggested already when Marconi telegraphed across the Channel, but aeronauts have been backward up to a few months ago, to install wireless apparatus in their cars, on account of the danger. It is not a very pleasant sensation to have a few thousand cubic feet of inflammable gas above one's head and work a key (which sparks), and look at the fiery spark gap which itself would immediately inflame the gas which leaves the balloon almost constantly.

Therefore most experiments with wireless telegraphy in airships were until recently confined to receive messages only.

It is not the danger of the direct spark of the spark gap that is so threatening, but the danger of stray sparks leaping from the metal skeleton to the gas bags as in the Zeppelin type shown in Fig. 1, that is to be feared mostly.

\*E. T. Z.

Mr. K. Solff, who suggests the various types of airship antennae in this article, does not favor the one shown in Fig. 1, as although it is the ideal one to use on account of being almost perfect from the electrical standpoint, there is still danger from stray sparks. Referring to Fig. 1 MM represent collapsible masts; A, flat-top aerial; G, counterbalance aerial; JJ, insulators; K, operating room; S, open shaft; Z, lead-in from aerials; B, gas-carrying ballonets. It is suggested to have both aerials 60 meters long and 10 meters high.

In Fig. 2, a simpler aerial system is shown. The aerial proper is suspended from the kite D, and is from 200 to 400 meters long. G again is the counterbalance aerial, while HH are insulating cords holding the wire G.

From the electrical point of view, the system shown in Fig. 1 is, of course, better.

Fig. 3 shows an aerial system for directional waves. AA represents the antenna proper, while GG shows the counterbalance. TT will be the direction of the outgoing waves.

While the three different systems shown may prove satisfactory in some cases, Mr. Solff forgets two important points.

He does not tell us what is going to happen when the antennae shown in Figs. 1 and 2 collapse and fall on top of the airship *while the operator in K is sending*. The sparking that will immediately take place will surely explode escaping gas or worse yet, will ignite one or more of the ballonets with disastrous results.

While this does not hold true so much for the antennae shown in Fig. 3, which the writer considers the only real safe one, to a certain degree, it rests to be seen just what is going to happen when the lower aerials of Figs. 1, 2, and 3 touch the ground when landing. The

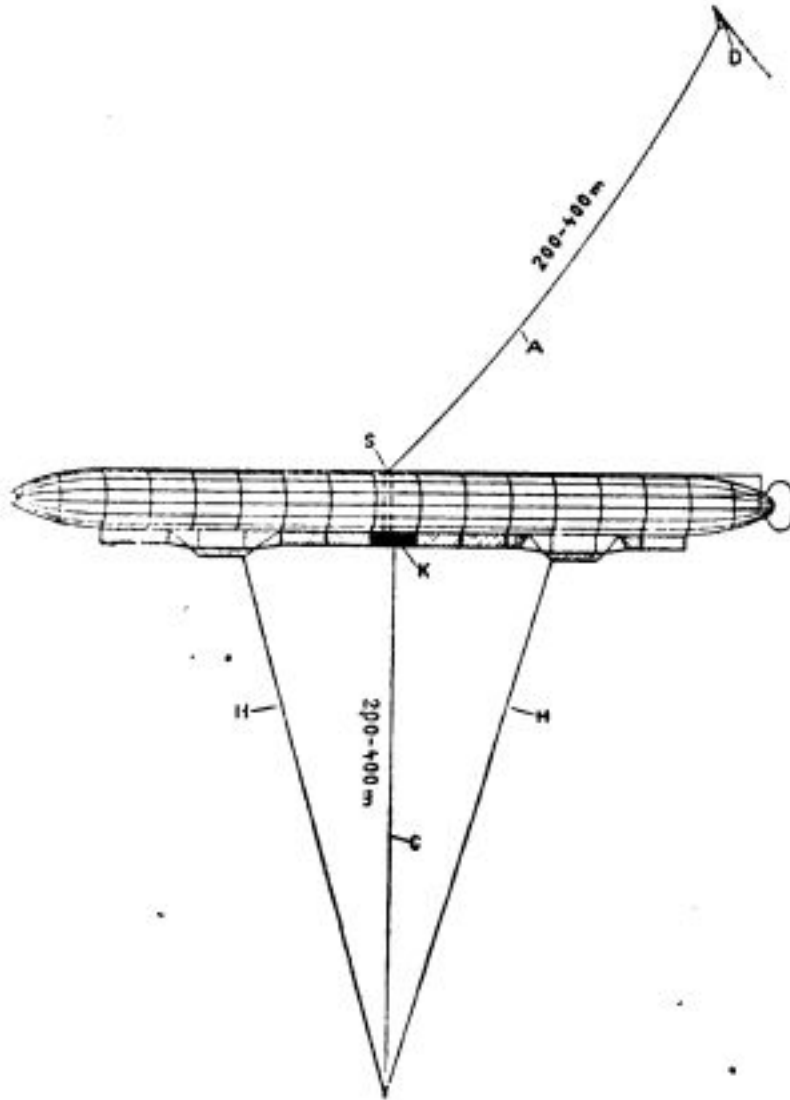

Fig. 2.

one shown in Fig. 1 will surely be damaged more or less. The ones shown in Figs. 2 and 3 are not quite as bad off, but might easily get entangled in tree-tops or objects on roofs when sailing low.

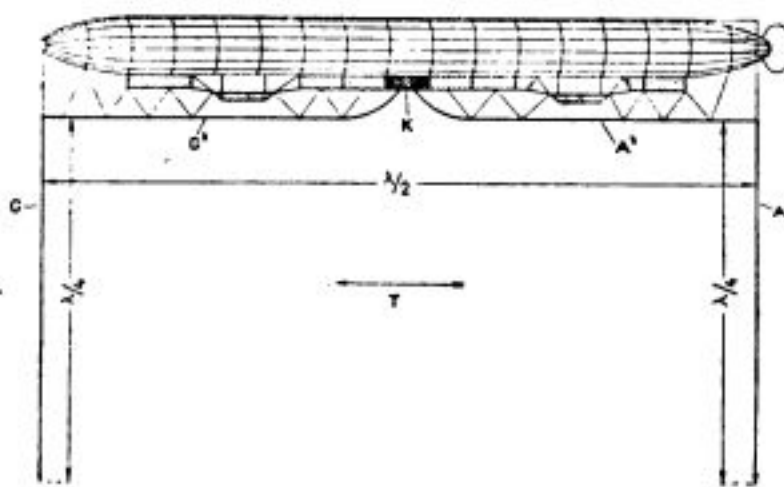

Fig. 3.

All in all, the writer is of the opinion that the aerial system illustrated in Fig. 3 is the most suitable for airships if by means of a motor driven drum the entire aerial can be rolled or hoisted up close to the body of the airship, within a few seconds.

This refers to G and A, as well as to G' and A'.

### NEW MAVER'S WIRELESS.

The long expected new edition of Maver's "Wireless Telegraphy" is now ready for delivery. The new title of the book is "Maver's Wireless Telegraphy and Telephony—A Handbook of." The book is now divided into two parts, Part 1 being devoted to wireless telegraphy; Part 2 to wireless telephony. An amateur wireless department has been added to the book, in which the arrangement of circuits and the construction of apparatus for amateur stations is described at length and in plain language. A valuable table of wave lengths is also given, from which any one knowing the inductance capacity of an aerial may at once ascertain the wave length in meters; or, knowing the wave length in meters desired, the capacity and inductance necessary to obtain such a wave length may readily be found in this table.

Full descriptions are given of latest improvements in all the important commercial wireless telegraph and telephone systems, including the Marconi, Telefunken, Massie, Stone and Poulsen wireless telegraph systems, and the Telefunken, DeForest, Ruhmer, Poulsen, Fessenden and Marjorana wireless telephone systems. The Telefunken and Lepel singing arc systems, and the directive wireless systems of Braun, Stone, Artom, DeForest, Marconi and Bellini-Tosi are also treated of in this edition. Many practical suggestions for the operation of wireless systems are also to be found herein. The clearness and completeness of the diagrams are a feature of the book. Nothing of importance contained in the first editions of this work have been omitted from the present edition, but an idea of the new matter contained in the new edition will be obtained when it is considered that 150 pages of new matter and 135 new diagrams have been added, making a total of 366 pages and 258 illustrations. In fact, as previously intended, this volume now constitutes three books in one, namely, Wireless Telegraphy, Wireless Telephony, and Amateur Wireless Telegraphy. The book is bound in cloth, and will make a valuable Christmas gift to friends. Price, \$3.00.

# Bi-Polar Selective Switch

By WALTER E. KEEVER.

Many experimenters in wireless, wishing to test and compare the efficiency of different types of detectors, find it decidedly inconvenient to disconnect their wiring and attach to each instrument as used. A single-pole selective switch is unsatisfactory because it leaves all of the detectors connected on one side, thus disturbing the balance of the circuit. To obviate this difficulty the writer has designed and constructed the bi-polar selective switch herein described, and finds it works very well.

Diagram shows a five-point switch, but more points may be added by simply using a larger base. For a five-point switch, cut a piece of oak 5 by 5 1/2 inches and about a half-inch thick. Smooth well, stain and shellac.

Fig. 1 shows the "ground plan." Dotted lines represent switch lever (de-

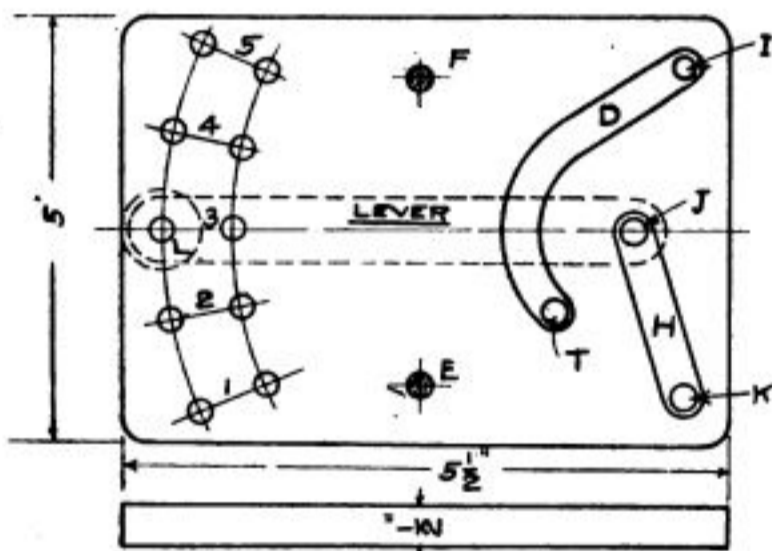

-FIG. 1-

M. E.

tailed in Fig 2), pivoted at J; handle at L. The conducting strips D and H, of thin sheet bronze or copper, are fastened down at one end by binding posts I and K. Curved strip D is fastened at inner end by an ordinary brass-headed upholstery tack, T. The straight strip H is fastened down, as shown in Fig. 2, by jamb-nut (under the lever) on pivot J, making good electrical contact.

In Fig. 1, the five pairs of switch points are shown—1, 2, 3, 4, 5—made of binding posts from "dead" dry batteries. All jamb-nuts shown are secured from the same source. The outer line of points should be one inch from inner line. Use a compass in laying off arcs. In boring holes be careful that each pair

lines up exactly with the pivot (J) of switch lever. Shove the binding posts up through holes and clamp firmly with flat nuts on top of base. Now screw on

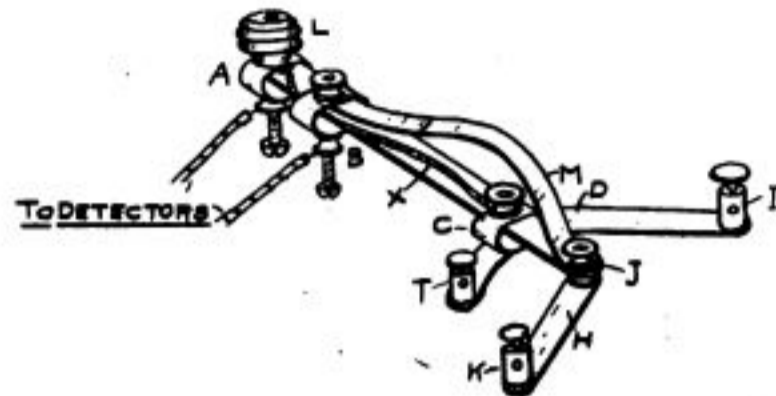

-FIG. 2-

M. E.



-FIG. 3-

the knurled jamb-nuts, first polishing both faces of each, as they serve also for contacts.

A, B and C, Fig. 2, are strips of thin sheet bronze or copper, one-half inch wide and 2 1/2 inches long, bent into an oval, with ends perforated and hooked over binding-post screws that run up through wooden switch lever. They should have sufficient spring to retain their oval shape and yet yield slightly to the pressure of lever, thus making up for any inequalities in height of switch points. B and C are fastened by jamb-nuts and A by knob L—a wooden teakettle knob, with bottom part sawed off and a jamb-nut sunk in top.

The bow spring shown in Fig. 2 is made of stiff, flat spring brass, 1/2 inch wide, with ends slotted to slip under jamb-nuts at B and J. This spring

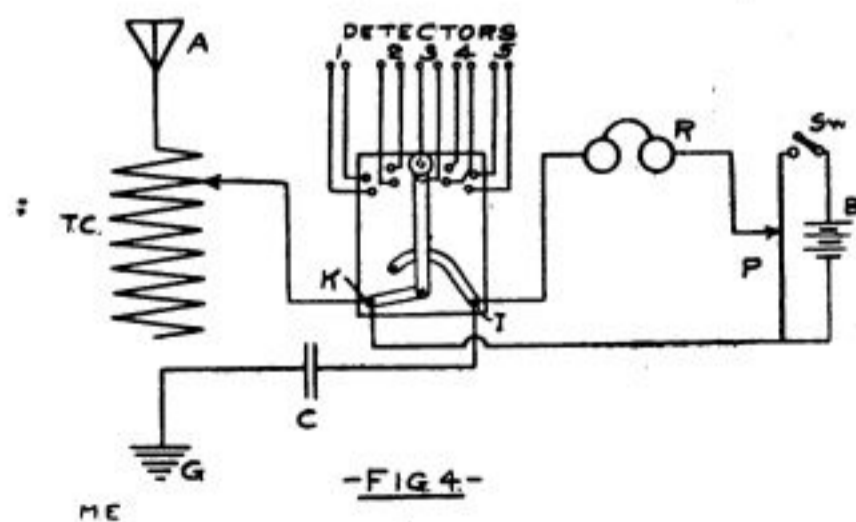

-FIG. 4-

M. E.

serves also as an electrical connection between B and K (through H and J). M

is a strip of copper running around end of lever to insure good connection between J and H.

The switch lever itself is made of hard wood and is  $\frac{3}{4}$  inch wide,  $\frac{3}{16}$  inch thick and 5 inches long.

Wire X connects contacts A and C (thence through strip D to binding post

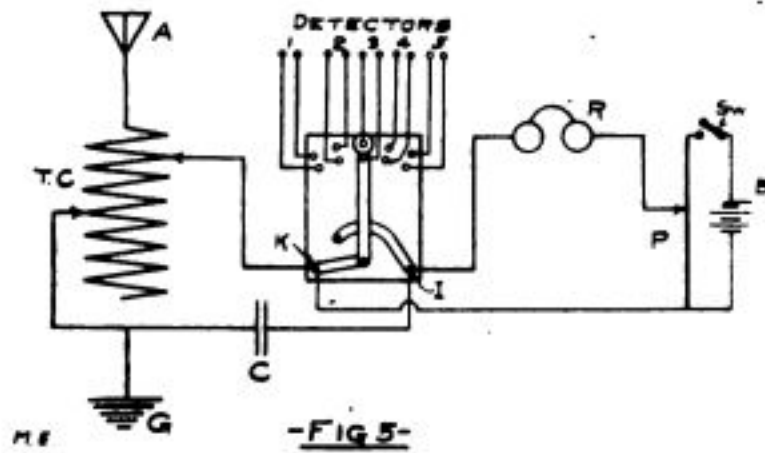

I). For sake of symmetry the writer used two wires, running one on each side of jamb-nut. One end of X is soldered to a copper washer which goes on top of A and is clamped down by L. Other end is soldered to slotted copper strip which slips under jamb-nut on C.

E and F, Fig. I, are small wooden posts one inch long, fastened with screws up through base. They merely serve as buffers, and are not absolutely necessary.

The completed bi-polar switch should be mounted on short wooden legs to raise it about  $\frac{1}{4}$  inch from table.

In wiring up, consider the switch as a detector and wire to posts I and K accordingly. If you intend to use battery with any of your detectors, I and K should be double binding posts, to accommodate two wires.

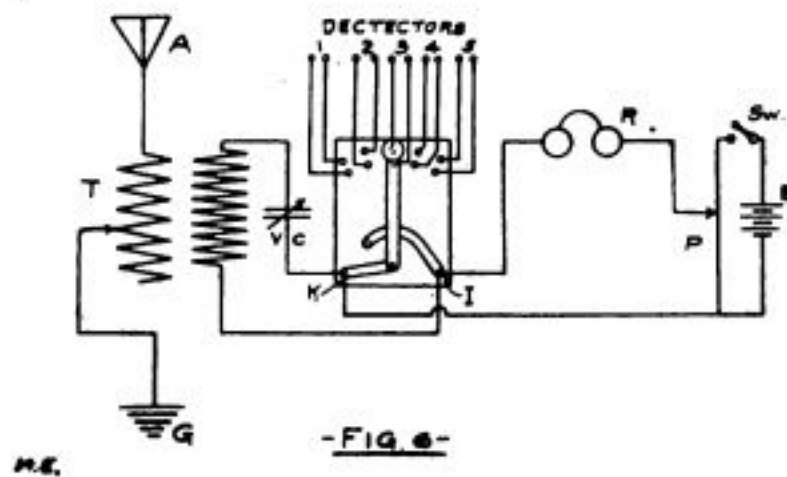

From each detector run two wires to its pair of points on the switch. All these wires should be of same size and length, and well insulated.

Using single slide tuner, connect instruments as shown in Fig. 4, for double slide tuner as shown in Fig. 5, and for receiving transformer as shown in Fig. 6.

## HEROES OF WIRELESS TELEGRAPHY.

Wireless telegraph operators on steamships appear to be the heroes of marine disasters nowadays, circumstances having compelled them to take the place formerly held by the gallant sailors and officers who stood at their posts in the hour of danger and refused to leave until passengers were rescued. "Jack" Binns, who figured so nobly and efficiently yet modestly in the Republic accident last January, and who by staying at the key and sending out the distress call of "C. Q. D." speedily brought help when it was sorely needed, was a type. Of similar mettle was George C. Eccles, wireless operator on the steamer Ohio, which was wrecked on the Pacific coast. Eccles made the trip unexpectedly. He had resigned and was about to accept another position, but yielding to importunities of the company, which was short of men, he consented to fill the position temporarily. He remained in the wireless station until the ship made the plunge to the bottom, and then leaped out, but too late. He had saved others, but he continued in that work of self sacrifice until it was impossible to find safety.

In quiet talks with these heroes of the "wireless" one gets a glimpse of their attitude toward their employment, their employers and the public they serve. To be sure, the fundamental principle is that it is "all in the day's work." Much as is the case with the trained professional soldier, they have well-defined duties to discharge and they accept the situation in the spirit in which the disciplined soldier or sailor carries out orders. Yet there is a wide difference, for it is the fundamental duty of the "wireless" operator to help and save and not to destroy. Perhaps the ethics of the matter cannot be summed up more effectively than in the simple, straightforward statement of "Jack" Binns himself, who, when asked if Eccles could have got out, replied instantly: "Get out? Why, it wasn't his business to get out. He couldn't get out till everybody else was saved. He was there to stick until his messages brought help for the passengers. That's the wireless game—to stick."

Binns steadfastly refused to be lionized when his exploit on the Republic brought fame and applause, and then and since has behaved in most manly fashion.

(Continued on Page 481)

## Secondary Coil Impregnation

By C. C. WHITTAKER.

The efficiency of a home-made induction coil, in nine cases out of ten, falls much below the estimated efficiency before construction. This is due to a variety of causes which the amateur instrument maker finds it difficult to overcome. Such difficulties as not being able to "lay" the adjacent coils of the secondary close enough together and of not being able to sufficiently insulate these are common annoyances which seem to be inevitable.

The practice of winding a secondary by first letting the cotton or silk covered wire run through molten paraffine certainly does insulate the wire, but it is practiced at great expense of space. A secondary wound with no paraffine and immersed in paraffine oil or linseed oil will behave well providing all the air can be expelled from the coils. The expulsion can best be accomplished by the aid of an air pump.

In the following paragraphs I shall endeavor to explain a method which is very satisfactory and easy to operate.

Looking at the illustration, the tank which contains the paraffine or oil should be one-half again as long as the assembled secondary. This will allow the whole secondary to be suspended by the rod, R, above the paraffine or oil while the air is being exhausted.

The tank itself should be made of material sufficiently heavy to withstand the atmospheric pressure to which it will be subjected. The bottom edges should be soldered to render the tank air-tight. The top edge is filed smooth so as to fit the plane surface of the top cover. This cover has the suspension rod running through its center and held in place by a set screw. Near one edge is soldered a small metal tube to serve as a connection for exhaustion.

This top is held in place by the atmospheric pressure from the outside. A soft rubber washer smeared with vaseline will effectually stop any air from entering while exhaustion is taking place. The suspension rod should also have a slight coating of vaseline.

The exhaustion can be carried on by any form of air pump. In case the experimenter has no pump at his command, the following description will be of interest to him:

A very efficient air pump can be made by the following directions with the aid of the illustration.

The T-shape tube containing the stop cocks A and B can be made either of glass or metal. It is connected to E by a piece of heavy rubber tubing. Another piece of tubing of the same diameter and about four feet in length extends from H to D. The end at D terminates in a funnel.

The operation of the pump is as simple as the construction. The tube H C D is filled with mercury. A is closed and B is open. The funnel is now

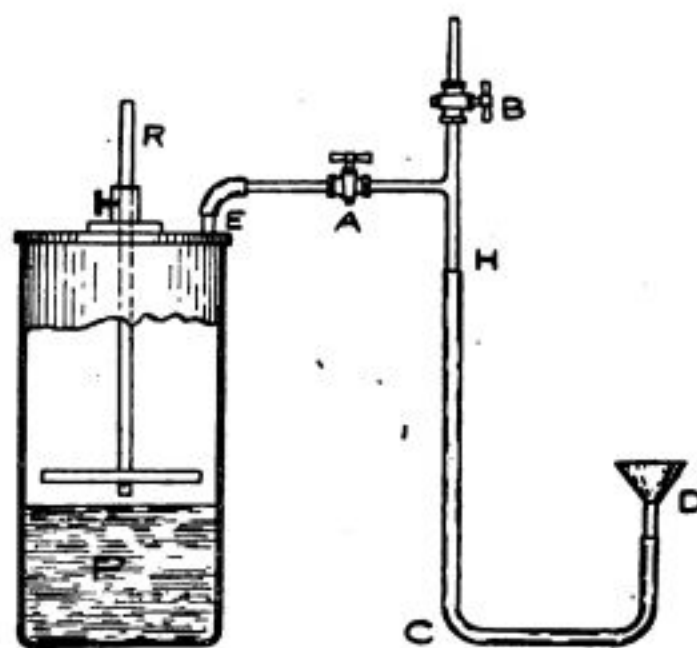

raised until the level of the mercury rises to the stop cock B, when it is closed. D is now lowered somewhat more than thirty inches below B. A nearly perfect vacuum now forms between the top surface of the mercury and B. If A is now opened and quickly closed, the air in the tank will expand and fill the vacuum. D is now raised to the level of B and B is opened to allow the imprisoned air to escape. When the level of the mercury again reaches B, the valve is closed and the process is repeated.

When the exhaustion has been carried on to a sufficient degree, the paraffine may be melted and the coil lowered into it by the rod R. After doing this it may be well to start the pump again on account of the gases given off by the hot paraffine.

After being thoroughly saturated, the coil may be lifted from the liquid and allowed to cool.

# The Colin & Jeance Radiophone

By A. C. MARLOWE.

Paris Correspondent MODERN ELECTRICS

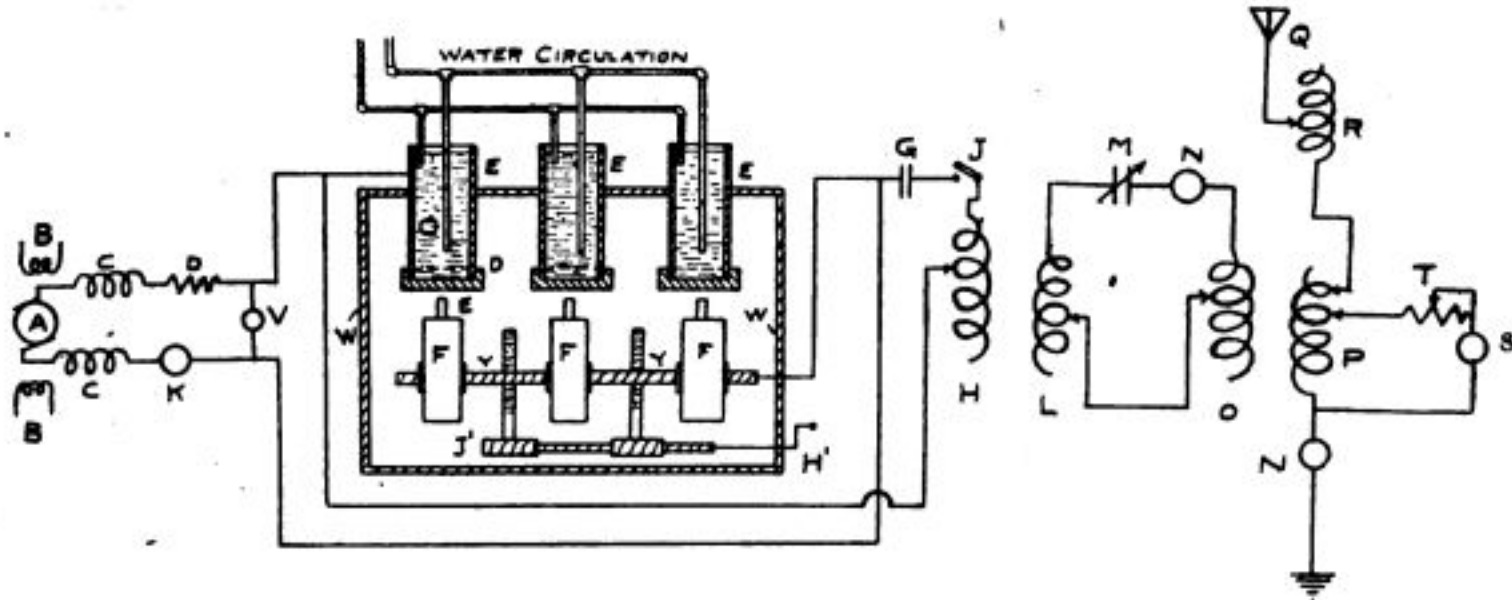

Our readers will remember the remarkable results in radiophone work which were obtained by Lieutenants Colin and Jeance, of the French Navy. The trials were carried out on the Mediterranean, using a shore post at Toulon, while the second post was mounted on the war vessel Conde. In this way they were able to cover the distance of 120 miles. While it was known that their apparatus was based on the use of arcs in series, combined with Tesla coils, a full description could not be obtained, owing to the fact that the inventors were connected with the government service, and for this reason it was desired to keep the invention a secret. Owing to the fact that the French patent law has just been issued, we are now able to give the following description of the apparatus:

Current is supplied from a generator, A, which has a variable field circuit, B, so as to change the voltage in the proper way, using the two choke coils, CC and the rheostat D, with the voltmeter, V and ammeter K. The apparatus for the arcs is enclosed in the box W, which is designed to contain either a gas or a liquid. The positive electrodes for the arcs are formed of the cylindrical reservoirs C, which are of copper and have a large diameter. They are cooled by a water circulation on the gravity principle, using the piping which is seen at the top. At the bottom of the electrode is the flat-surfaced cap D which is used for the arc. The lower electrode is formed of a thin carbon rod, E, which is from 1 to 3 millimeters diameter, and it is mounted on the top of a radiating

cylinder, F, of large size, which is provided with cooling wings. A large carbon can also be used here. A plate, Y, carries all three electrodes, which have a sliding fit, and the whole set of electrodes can be moved up and down by using the screw and worm-gear set, I', with the outside handle, H', so as to give the adjustment of the arcing distance. An automatic regulating device can also be used for the purpose. When the arcs are formed in free air the carbons E can be of larger diameter. A glass-covered eye-hole allows of looking at the arcs from the outside.

The first part of the circuit is made up of the arcs in series, also a variable condenser, G, a variable inductance coil, H, using the voltmeter V at the terminals of the arcs. The switch, J, breaks this first circuit. For the second circuit there is used the variable inductance coil L, which forms the secondary of a Tesla transformer, whose primary is the coil H of the first circuit. We have also the variable condenser, M, the ammeter N and the variable inductance coil, O, which forms the primary of a second Tesla transformer, with the variable self inductance P, this being the secondary of the transformer. It has one side grounded through the ammeter N'. A properly chosen point on the coil P is connected to the aerial Q through the entrance coil R, which is adjustable.

The microphone S is in a circuit, having one of its ends grounded and the other comes off from an adjusted point on the Tesla transformer. In it is the variable resistance T and an ammeter

(Continued on Page 481)

# Detectors

By GEORGE F. WORTS.

The wireless wave detector, indispensable to any wireless station, is, as is usually understood, the most delicate piece of apparatus in the whole outfit. Accordingly, it should receive careful attention. Detectors should be kept out of the sun and in a dry position. Their component parts should be kept in a perfect condition and covered up when not in use.

There has been a great deal of discussion lately concerning the relative sensitiveness of various detectors. Electrolytic, silicon, carborundum and perikon is the order in which they rank as to merit, according to the views of most experimenters.

The electrolytic detector, perhaps the most well known, exists in many forms, the simplest of which consists of a fine silver plated platinum wire, the point of which is immersed in an acid solution contained in a metal or carbon cup or a glass cup, with electrodes. Foreign nations use the electrolytic type of detector in many complicated forms. For delicate work a potential regulator capable of very fine adjustment is necessary. This is found in the potentiometer. For general use the electrolytic detector cannot be excelled except in vicinities where there is a great deal of local high power interference, in which case the platinum wire is eaten away rapidly and substitution of a different type of detector is necessary, such, for instance, as the thermoelectric.

The silicon detector is the most popular of all thermo electric detectors and unsurpassable for work with local high power interference. It should be used with the crystal fastened on lead and using a steel hair wire or a needle on a spring for the contact. Other thermo electric detectors are equipped with substances similar in function to the silicon, as molybendite, iron pyrite, etc. It is best to use a detector stand on which any crystal can be used.

The carborundum detector is one of the most popular of the crystal type. A battery and potentiometer are necessary

for its successful operation. The carborundum detector is as easy to work with as any other of the crystal detectors being used, and possesses the very desirable characteristic of remaining in almost permanent adjustment. Green crystals, as has been stated in a previous issue of this publication, are more sensitive than the blue crystals. The ground side of the crystal should be coated with tin or gold foil.

The perikon detector, composed of copper and zincite pyrites, has not come into general use as yet by amateurs. It is of the thermo electric type and has a very promising future. Records have been made along the Atlantic coast, a New York station having heard Key West (Marconi) several times with the perikon detector.

A good way to find the most sensitive point of a detector is to connect up a key sounder and battery near the detector. The key should be pressed several times. A sharp click in the telephone receiver, when the key is raised, will be heard when the detector is at its most sensitive point. This is due to the electric impulse sent out from the coils of the sounder when the current is quickly withdrawn from them.

A high capacity variable condenser should be shunted across the detector. By means of this very faint messages may be intensified or cut out, as desired.

While transmitting a switch should be cut in across the detector to prevent it from any danger of burning out.

The writer would suggest to amateurs to not be contented with receiving only with a well known type of detector, but, instead, experiment with different substances, and, perchance, discover some wonderful new material that would place fame and fortune at the feet of its discoverer or originator.

## NEW BATTERY ELECTROLYTE.

Attention is called to Patent No. 940,734 on this month's patent page. This solution we believe when used in bichromate of potash-style cells will give good results.



## Automatic Wireless Signaling

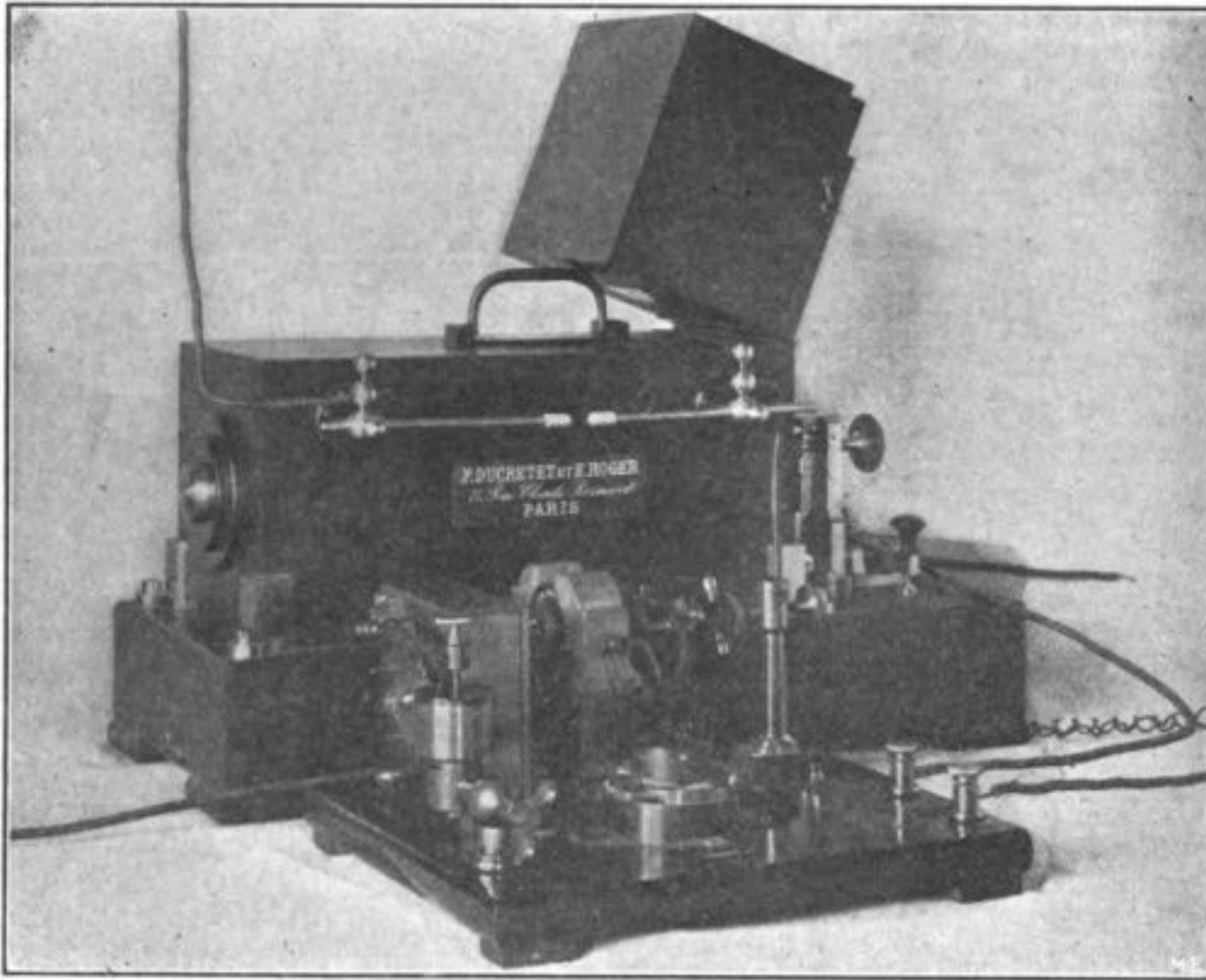

An automatic system of sending signals for wireless is brought out by the Ducretet firm of Paris. It is intended to be used for lighthouses and in similar posts where signals are to be sent to warn ships which come within range, or to give conventional signals of any

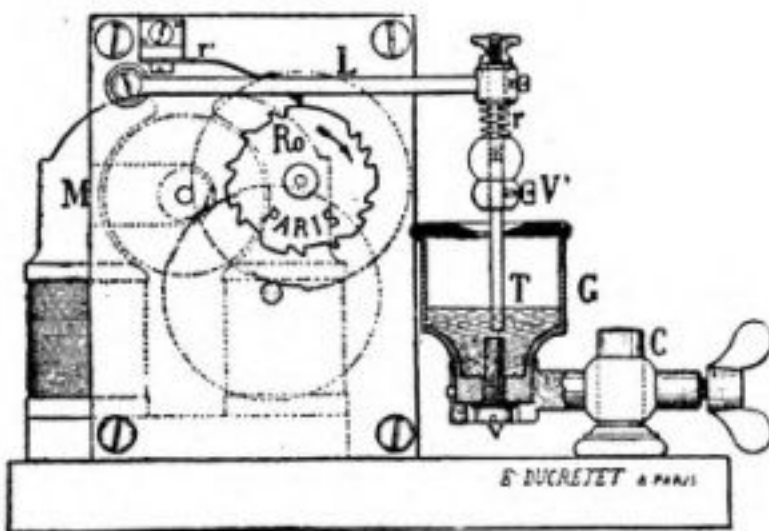

kind. The device is of a very simple operation, as will be noticed by the accompanying views. Such an automatic sending key was desired by Engineer Blondel, and afterwards applied by Captain Moritz, a naval officer. The present apparatus is an improved one of this kind. It has a cam wheel R which is interchangeable, and each wheel has a series of teeth corresponding to the

Morse signals for the name of the lighthouse or post, or any suitable signal. The cam wheel is operated by a set of gearing from a small electric motor, which is provided with an automatic speed governor. A condenser, or other suitable device, is used to cut down the sparking at the break, this latter being worked from the cam wheel by the lever L and rod T. We thus have the signals sent on the usual principle, but these are automatic, owing to the action of the cam device. The liquid used in G (to minimize the spark) is either alcohol or petroleum.

### TELEVISION AND THE TELEPHOT.

(Continued from page 406.)

be used to transmit objects in motion over a single wire and at the same time receive a proportionate amount of energy at the receiving end to that received by the selenium cells at the transmitter.

No patents were taken out on this invention by the writer, as he considers the device too complicated for general use. He shall, however, consider himself happy if it will be the means to bring us nearer to the practical Telephot.

## Paris Letter

### NEW MARCONI SPARK GAP.

A new form of spark discharger is brought out by the Marconi Wireless Company. The discharge is produced in the small spaces between sets of projecting points, and these latter are carried on two rotating discs (Fig. 1) in such way that the points lie facing each other. The two discs A A' are given a very rapid rotation and in the contrary directions. On the discs are noticed the two sets of contact projections B B'. Each of the revolving discs is mounted on a shaft C, which is held in bearings and rotated by the insulated pulley E. The bearings D are insulated from the ground. Current comes to each of the discs by the sets of brushes F. These brushes are connected to the circuit which is seen above the apparatus. The condenser G is connected through the self inductance coils K to the generator L, and this circuit is joined to the aerial J by means of the coupling at H. The whole thus forms an oscillating circuit. It is found good practice to use discs of 20-inch diameter, each carrying two projecting teeth and each disc is rotated at 3,000 revolutions per minute. Copper is the best material for making the projections, as has been found by testing

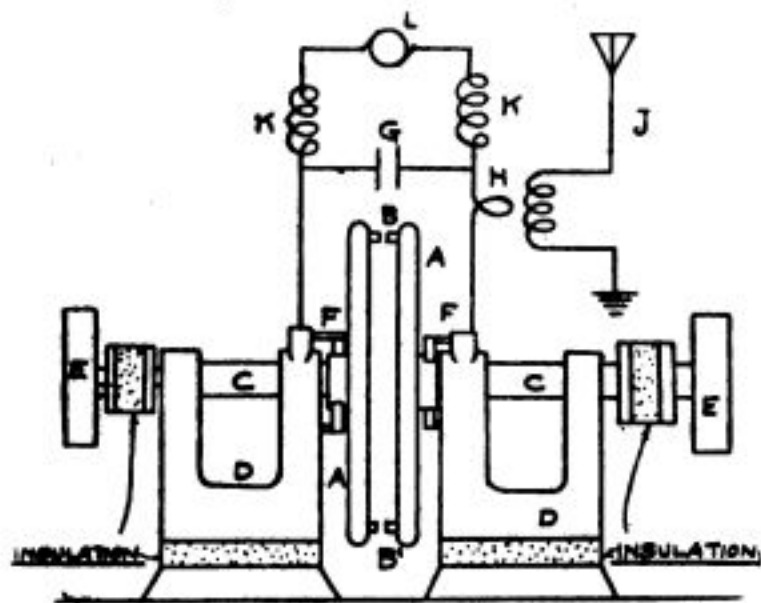

ME - Fig. 1 -

different metals. We give to the condenser G and choke-coils K values such that the oscillation period of the circuit is equal to the time elapsed between two consecutive discharges of the condenser, or else a multiple or sub-multiple of this value. By this device we can discharge the condenser twice as fast as with a single rotating disc. High power can be used in this case, and we can send sets

of regular waves upon which a suitable receiver can be tuned, and a note is produced in the telephone which can easily be distinguished from the noises caused by atmospheric disturbances.

### NEW MEANS TO GENERATE ELECTRICITY.

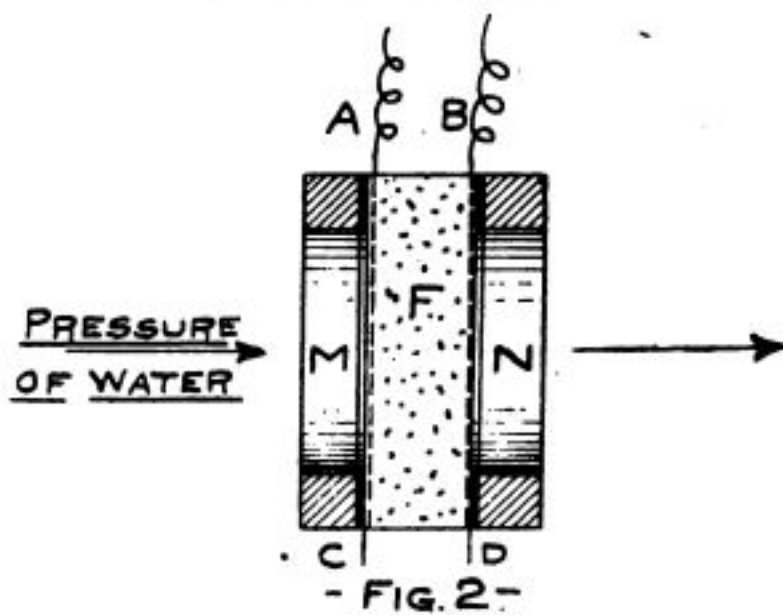

ME

It is well known that an electrical effect is obtained when a liquid is forced through a porous diaphragm at a considerable pressure, but as this effect is a very slight one it could not be used as a source of current. B. Schwerin has found a method of greatly increasing the current which can be thus obtained, so as to adopt it for practical use. The main parts of his device are a porous filter F (Fig. 2), having on each side the wire gauge sheets A, B, the whole being pressed between the metal rings M N, using insulating rings C D. Current is taken off from the two wire gauge pieces. A liquid is forced through the filter at high pressure. The success of the method lies in various details found by his researches, especially in the use of suitable liquids, and also ammonia, which is found to give a good result. A very high pressure is needed for the liquid, and the pores of the filter must be as fine as possible. The filter is formed of a substance in the shape of very fine powder, such as carbon or quartz, and the liquid is best sent through the device in a closed circuit of piping. With a constant pressure of 5 atmospheres and a carbon filter of 3 inches' thickness and a surface of 32 square inches the internal resistance is 1,000 ohms with distilled water, but add-

ing ammonia we reduce the resistance and also have twice the electromotive force and ten times the current, so that changing the liquid gives 20 times the energy. To show the effect of the pressure, in one case 10 atmospheres' pressure gave only 0.04 watt, while 80 atmospheres gave as high as 2.56 watts, (A), (32 volts and 0.8 ampere) showing that a considerable amount of power can be obtained by such a method. This does not depend upon the rate of flow of the liquid, but



-FIG. 3-

M. E.

upon the three factors—pressure, nature of liquid and diameter of the pores.

#### NEW TRANSFORMER.

In Fig. 3 will be seen the construction of the telephone transmitter which was employed by the Swedish inventors. Engner and Holström in their experiments between Stockholm and Paris. On this occasion they were able to work over a 2,500 mile line with very good results. Their object in the present transmitter is to transmit as much as possible of the pressure of the diaphragm to the carbon granules so as to secure the highest effect. This they carry out by the use of the diaphragm D, which

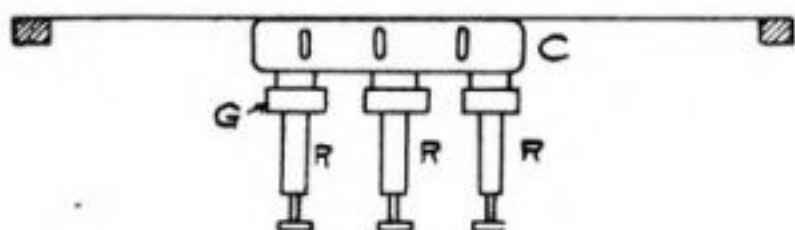

-FIG. 3, a-

M. E.

carries in the central part where the effect is the greatest, a light steel box of cylindrical shape, C, so that the flat bottom of the box presses upon the surface of the carbon grains, G, contained in the holder, R. In this way we have the pressure upon a considerable surface of the carbon grains. Usually the steel box is made to press upon a certain number of holders which are mounted underneath at TT, and these latter are placed in separate adjustable supports for regulating the pressure, as shown in 3A.



A LETTER TO SANTA CLAUS.  
WITH ALL EXCEPT VERY OLD-FASHIONED CHILDREN, THE WIRELESS  
HAS SUPPRESSED THE MAIL-BOX.

—Puck.

#### THE LAY OF THE WIRELESS MAN.

What are the wild waves saying?  
'Tis this I fain would know.  
My aerials hang a-swaying  
So gently to and fro.

I'm higher than the treetops,  
And longer than the yard.  
What are the wild waves saying?  
'Tis this I've on my card.

When sliding up my tuning coil  
I do it very slow.  
But what the waves are saying  
I've not yet learned to know.

Condensers, coils and rheostats  
All stand in bright array.  
But none of these inventions  
Will bid those wavelets stay.

With thousand-ohm receivers  
I coax them, rain or shine,  
To tell me all their secrets.  
However, they decline.

I'll beat those wilful wavelets  
By sending C. Q. D.  
To my old friend, the editor,  
Who'll boost me through "M. E."  
WILLIAM J. COQUELIN.

## The Construction of An Efficient Aerial

By GEO. F. WORTS.

For the benefit of the casual wireless amateur, who contemplates setting up a station, the writer will endeavor to explain methods for successful aerial construction and erection. Without any egotistical presumptions on his part, the writer will mention foremost that he can speak from actual experience in matters that pertain to aerials, having constructed and erected about twelve aerials for various amateurs.

To say the least, aerial erection under ordinary amateurs' conditions is very trying. Fortunately, however, property owners, or those whose permission it is desired to obtain for the trespassing of aerials on neighboring property, are usually generous minded enough to appreciate the benefits derived from a wireless laboratory, and permission is usually forthcoming. The trouble arises, however, when the physical obversities are contemplated. A good aerial should possess these two physical properties—height and length. If either were necessary instead of both it would be an easy matter to construct an aerial.

In erecting an aerial of average length and height—about 60x60 feet—the first thing to consider is the location. There is usually just one *good* location about a prospective station, and with a little forethought the amateur can invariably find this.

The aerial proper—excluding supports, lead wires, etc.—should be hung directly above the wireless room. The leading in wire, or wires, should lead directly into the room and not twine artistically about the house, as is often the case. The aerial should be of the flat top, horizontal type, in preference to any other except the umbrella, which in almost all cases is too big a job, mechanically, to undertake. The slanting aerial is not as efficient as the parallel aerial.

In selecting the flat top, horizontal aerial two points some distance apart and at an elevation that is equal and clears intervening and surrounding objects should be considered. Trees naturally suggest themselves to the reader, but are to be considered only as a last resource. They absorb too much en-

ergy for practical use. Two poles on houses that are of medium height and some distance apart are the usual conditions for aerials, and are quite suitable for most requirements. Some amateurs have exceptionally good fortune. Those, for instance, that live in the vicinity of tall smokestacks, between which they can rig their antennae.

In erecting the aerial, where there is a clear space between the two supports, the aerial wires should be strung between the two spreaders upon the ground, or roof, as it may be. Tared rope should be fastened to each spreader and the aerial hoisted by means of a pulley at the top of each pole. This instruction sounds simple, but took about five attempts at aerial erection before the points were arrived at.

When trees or other objects lay between the two supports, a strong cord should be thrown across the space for each wire. This is the simplest method and one that the writer has used more than any.

The question next arises concerning materials.

The wire in an aerial may be one of three kinds: Copper, phosphor bronze or aluminum. The copper or phosphor bronze should be soft-drawn stranded wire, as the stranded wire does not kink easily, withstands strain and has a much larger capacity for radiation than a single wire. However, if a single wire is used it should be no smaller than No. 14 B and S gauge. Iron wire should not be used, as its magnetic qualities antagonize and dampen the incoming oscillations, rendering it, therefore, practically useless for wireless purposes. Possibly the best all around aerial wire is aluminum, as it is light and very strong and an excellent conductor. It is best to use insulated wire of the same size as the aerial wires for the leads in.

For the aerial spreaders, bamboo rod is about the best procurable, being both light and strong. It can be purchased quite cheaply at almost any hardware store.

Pulleys should be of wood, or galvanized iron, preferably, and secured stoutly to the supports. The rope should

(Continued on Page 421.)

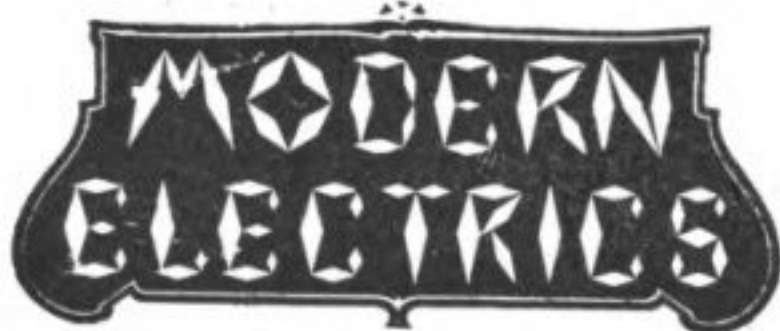

A Magazine devoted entirely to the  
Electrical Arts.

PUBLISHED MONTHLY BY  
Modern Electrics Publication  
NEW YORK CITY, N. Y.

H. GERNSBACK, EDITOR.

Subscription Price: For U. S. and Mexico  
\$1.00 per year, payable in advance.

New York City and Canada, \$1.25.

Foreign Countries, \$1.50 in Gold.

Stamps in payment for subscriptions *not*  
*accepted.*

Checks on out of town Banks cannot be  
accepted unless the usual exchange is  
added.

SINGLE COPY, 10 CENTS.

Forms close the 20th of the month pre-  
ceding date of publication. Advertising  
rates on application.

The Editor will be pleased to receive  
original contributions of timely interest  
pertaining to the electrical and the affli-  
ated arts. Articles with good drawings and  
clear photographs especially desired. If  
accepted, such articles will be paid for on  
publication, at regular rates. No manu-  
scripts will be returned unless return postage  
is enclosed.

Address all communications to:

MODERN ELECTRICS PUBLICATION  
84 West Broadway, New York, N. Y.

Chicago Office: 112 Dearborn Street  
Paris Office: 136 Rue d'Assas.  
Brussels Office: 23 Rue Henri Claus.

Copyright, 1909, by MODERN ELECTRICS  
PUBLICATION.

Entered as Second Class matter March 31, 1908, at  
the New York Post Office, under the Act of Con-  
gress of March 3, 1879.

Vol. II. DECEMBER 1909. No 9

### EDITORIALS.

The Editor desires to open an ex-  
perimental department for the use and  
benefit of experimenters and amateurs  
dabbling in electricity and wireless.

Almost every experimenter at one  
time or another has had occasion to  
construct some apparatus in a novel

manner, or he simplified seemingly  
complicated instruments. New con-  
nections, diagrams, etc., are often  
worked out; sometimes a simple  
change brings forth unexpected re-  
sults, etc.

All these things should be recorded  
and published for the benefit of other  
students, and the Editor believes that  
MODERN ELECTRICS is undoubtedly best  
suited for that purpose, as up to date  
over 23,000 copies are read by people  
interested in this work.

The Editor therefore invites all ex-  
perimenters to send in the result of  
their experiences, which will be pub-  
lished hereafter in the experimental  
department.

As long as the idea is original it will  
be welcomed, and gladly published for  
the benefit of others.

Do not be backward in sending in  
your account; we do not need fancy  
drawings. A rough sketch will do al-  
most every time, and can be worked  
out satisfactorily by our artists and  
draftsmen.

Not alone will others gain through  
your experience and experiments, but  
you yourself. If the idea is of suffi-  
cient value you can always point out  
that it was published first in Modern  
Electrics, which in a way may protect  
your rights for the future.

All contributions for the experi-  
mental department will be paid for at  
regular rates.

Remember, no idea is too small; if  
it has been published before we will of  
course let you know at once.

We prefer as many sketches or  
drawings as possible if the subject war-  
rants it. If you can take photographs  
of the objects or articles, so much the  
better.

Address all such contributions to:  
"Experimental Department, care of  
Modern Electrics."

### 25 DOLLARS IN GOLD.

The "results" contest (see editorial,  
November issue) closes December 31.  
There is not much time to lose. Did  
you send your postals to our statistical  
department? If not, you still have a  
good chance.

So far, Illinois is in the lead, next  
California, then New York. Remem-  
ber, twenty five dollars in gold for a  
few postal cards.

**HARTFORD WIRELESS ASSOCIATION.**

320 Wethersfield Ave., Hartford, Conn.

The Association was formed Oct. 21, and the following officers elected: W. J. Hickmott, Jr., President; D. N. Cole, Treasurer; H. E. Chapman, Secretary. At present the Association has only eight members, but more are expected as soon as the forming of the Association becomes known. The Association requests all amateurs interested in Wireless Telegraphy and living near Hartford to write to the secretary for membership blank.

Nearly all of the members are making the greater part of their apparatus, as in that way they become more familiar with the parts of the station. During the winter it is planned to have talks given by men prominent in electricity and men who have had professional experience with wireless telegraphy.

One curious experience I would like you to publish, as we never have seen or heard of it before. It was noticed by one of the members that once in a while there would be a regular series of dots in quick succession. One day this happened several times inside a few minutes and no answer could be thought of as the dots were faster and different than from a wireless station. At last an automobile stopped out in front of the house and the sound kept up a regular purr. The only explanation was the spark jumping across the gap in the cylinders of the automobile.

All members read MODERN ELECTRICS and are very pleased with it.

H. E. CHAPMAN,  
Secretary.

**S. S. KOREA MAKES GOOD.**

The Pacific mail liner Korea has had a double set of wireless installed as an experiment. We are glad to hear she is still in communication when 14 days out from S. F. for Hongkong, by means of her 5 K. W. set.

The following message was received from Operator S. A. Phelps:

"2,623 miles beyond Honolulu. In touch with coast every night. All well."

At the time this message was sent the Korea was 4,700 miles out and could be understood clearly.

**THE CONSTRUCTION OF AN EFFICIENT AERIAL.**

(Continued from Page 419)

be manila, about one-half inch, and tarred, to prevent its rotting. Always keep your aerial pulled up tight.

For light transmitting—that is, up to 1-4 K. W., the insulation need not be of high capacity. Porcelain cleats may be used for strain insulators. Two at the ends of each wire are sufficient. For higher power than 1-4 K. W. the aerial may be insulated as described in a previous article by the writer. All metal supports for the aerial should be insulated to prevent leakage.

The size of the aerial may be left to the reader's judgment, but for all round work, efficient transmitting and long distance receiving under any conditions, a four-wire aerial 100 feet long, with wires three feet apart and suspended 60 to 75 feet above the instruments (distance not measured from the ground), using the loop method of connection, constitutes as efficient an aerial as most amateurs would wish to possess.

**SAFE.**

The boy stood on the burning deck,  
He did not shake with fright.  
For his ship had a "wireless"  
And he got off all right.

—Judge.

A green wrapper on MODERN ELECTRICS means your subscription has expired. You want to know what's going on in Electrics, don't you? Send in your sub. before you forget it.

**W. A. O. A.**



The Wireless Association of America was founded solely to advance wireless. IT IS NOT A MONEY MAKING ORGANIZATION. Congress threatens to pass a law to license all wireless stations. The W. A. O. A. already has over 3,000 members—the largest wireless organization in the world. When the time for action arrives, the thousands of members will exert a powerful pressure to oppose the "wireless license" bill. This is one of the purposes of the W. A. O. A. There are more.

# The Measurement of Electric Waves

By M. A. DEVINY.

There are probably no more important measurements made about a large wireless station than those of the length of the radiated and received waves. So much of the efficiency of the transmission of energy and the adjustment of the instruments depends upon an accurate knowledge of the wave length that it is highly important that we be able to measure it with precision. On account of the many variable factors in the di-

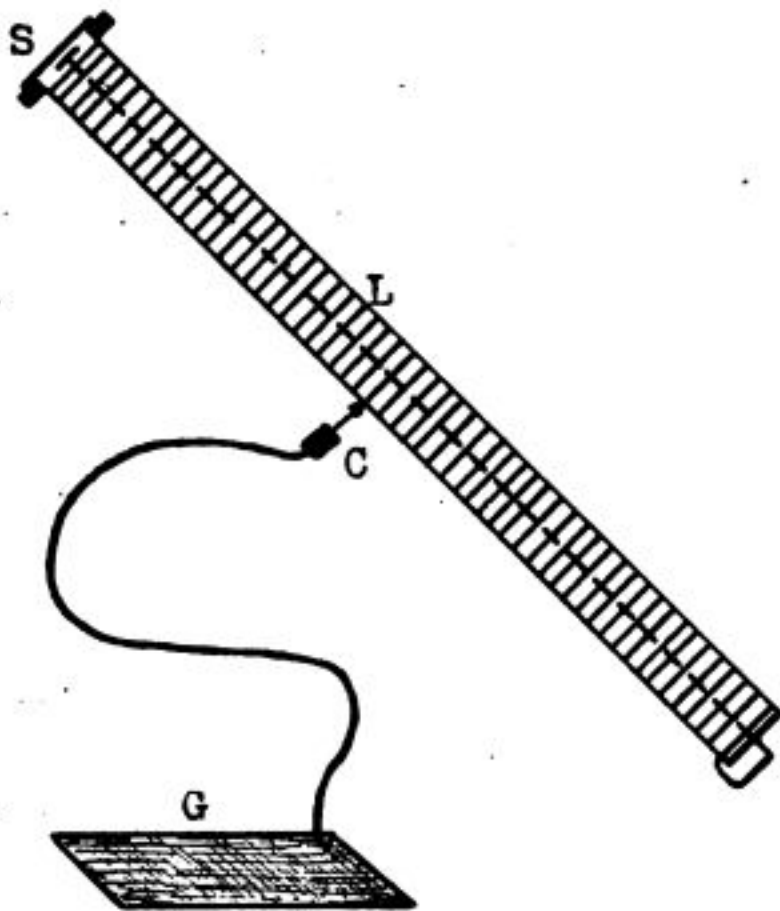

Fig. 1

mensions of the circuits and the class of instruments used in the different stations, it is hardly practicable to apply any definite rule which would be so general as to enable us to calculate the wave length with any degree of accuracy, and hence we must depend upon certain instruments which have been designed for the purpose. The principles underlying the operation of these instruments are rather complicated, but most of them depend upon the measurement of some factor of the aerial circuit bearing a direct relation to the length of wave.

The velocity of all forms of etheric wave motion is constant, as the elasticity and density of the ether in free space is constant. The length of the waves produced in this medium therefore depends upon the number of impulses im-

parted to it in a given time; the fundamental equation connecting wave-length, velocity of propagation and frequency having been found to be  $W=V/N$ . Since we know the velocity to be 186,000 miles per second, it can readily be seen that by measuring the frequency we can readily determine the length of wave that will be produced. Thus, if it were possible to produce electric waves with a frequency of one cycle per second, the length of the wave would be 186,000 miles and but one wave would leave the aerial per second. If the frequency were doubled, the wave length would be 93,000 miles and two waves would leave per second, while for a frequency of 186,000 per second, the aerial system would emit 186,000 waves each one mile long, and so on.

It follows from this that if we were able by some means to determine the frequency of oscillation in our transmitting aerial, we could accurately measure the length of the emitted waves. How, then, are we to do this? We cannot employ any of the means commonly used for similar measurements of low frequency currents and we must therefore resort to some entirely different method. There are two general methods available by which it may be done. The first is to cause the current to be measured to set up stationary waves upon a long helix of fine wires of known inductance, and to measure the distance between the nodes and loops of potential established upon it. From this we can easily calculate the frequency, or if the coil be provided with a suitably calibrated scale we may read the frequency directly.

The second method is to cause the circuit in which we desire to measure the frequency to induce a current in a second circuit having known values of capacity and inductance. By varying either or both of the latter factors, we can bring the circuit into resonance with the first. When this has been accomplished the oscillation constants of both circuits are the same and their frequencies are equal. From the known values we can calculate the frequency of the second circuit or read it on a scale as before.

Most of the wave measuring devices now in use depend upon the second method as it is the most reliable and accurate for general use.

Among the early wave meters on this plan are those of Dr. Slaby and known as "Slaby rods," a diagram of which is given in Fig. 1. This instrument consists of a long glass tube L which is

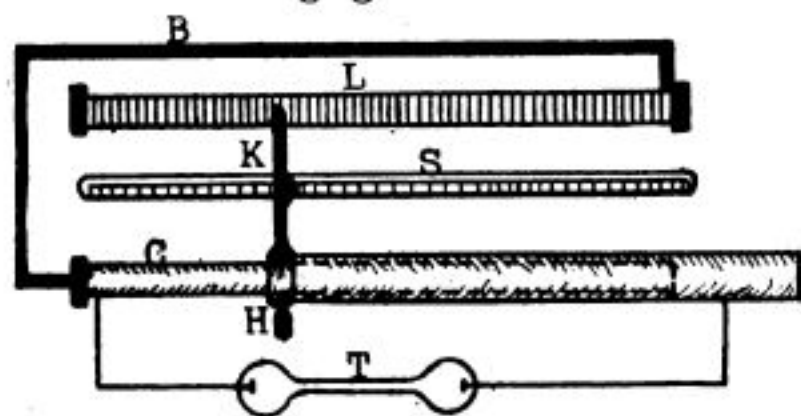

Fig. 2.

closely wound with a single layer of fine silk-covered wire forming an open circuit of relatively large inductance. At one end of the tube is placed a fluorescent screen S, somewhat similar to those used in X-ray fluoroscopes. One end of the coil is connected to the screen, while the other end is brought up through the inside of the tube and terminates in a disc a short distance from the surface of the screen. The metal plate G is laid upon the ground when the instrument is in use, and is connected through a flexible lead to a suitable contact-maker C by which contact may be made with any part of the helix, thus varying its effective length. The instrument is also provided with a scale (not shown in the figure) which is placed upon the helix and calibrated to read directly in wave length.

In using the instrument it is placed parallel to the aerial and the contact-maker slid along the coil until the screen glows brilliantly. When this condition is reached, the aerial and the instrument circuits are in resonance and the scale reading opposite the point of contact gives the length of wave directly in either feet or meters.

Slaby rods are not suitable for measuring wave lengths covering very wide ranges, and for this reason they are sold in sets, each one being adapted for measurements between certain limits. Owing to the numerous improvements made in this line, these instruments are seldom used now, they having given place to the more accurate and convenient closed circuit types.

One of the best wave measuring instruments yet produced is that designed by Dr. Fleming, and called by him the "cymometer," a diagram of which is shown in Fig. 2. This instrument is of the closed circuit type, having both a variable inductance and capacity, and with recent improvements it can be used to measure both transmitted and received waves.

The device consists of a long vulcanite rod L of comparatively small diameter which is wound with a single layer of fine wire forming the inductance. One end of the coil is free, while the other end is connected to the inner coating of the sliding tubular condenser C through a heavy copper bar B. The sliding contact on the inductance coil and the outer tube of the condenser are connected both mechanically and electrically through the rod K. The latter is provided with a handle so that as the inductance is al-

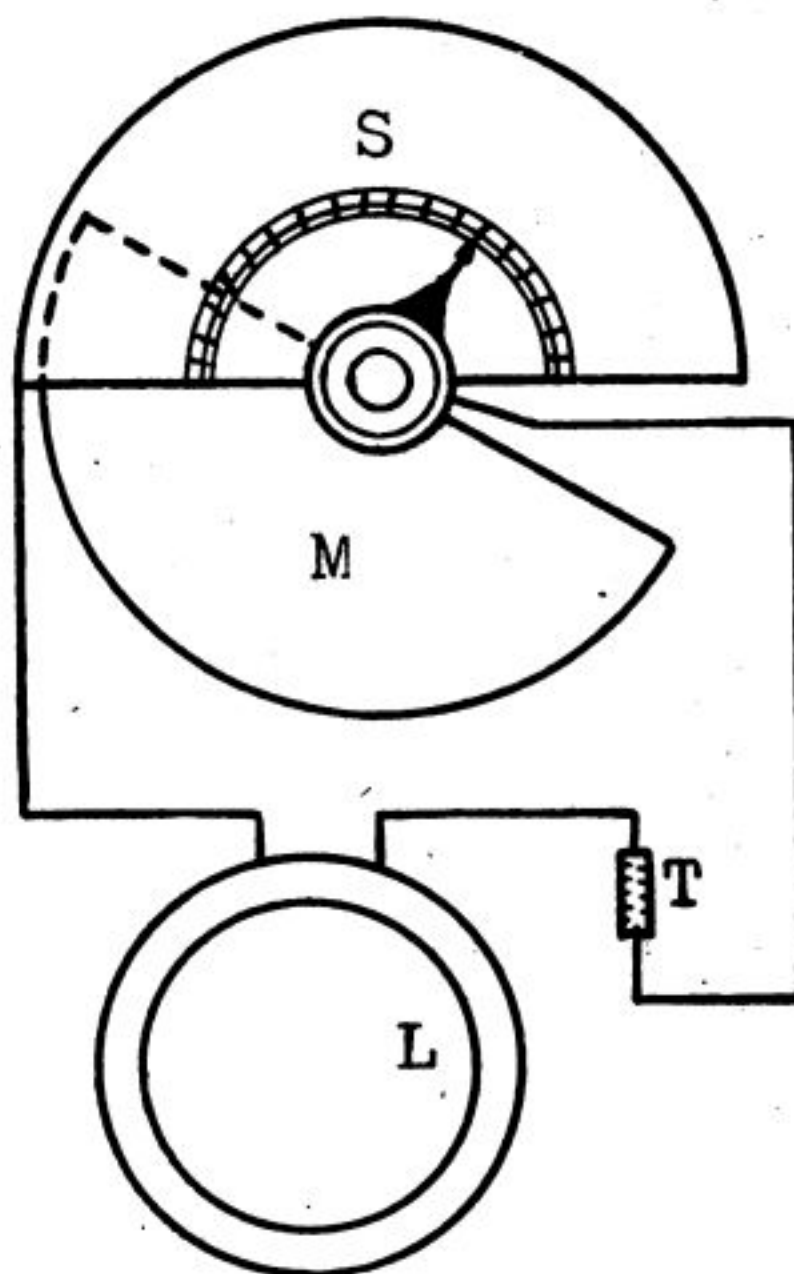

Fig. 3.

tered by sliding the contact back and forth, a similar change in the capacity of the condenser is effected. By the use of this construction it has been found that the oscillation constant or  $\sqrt{CL}$  of the circuit is almost directly proportional to the displacement of the handle; a feature which allows of the use of uniform-



ly calibrated scales. A neon vacuum tube T is connected to the outer and inner tubes of the condenser to indicate when the point of resonance has been reached, and a pointer is attached to the slider which moves over the scale S.

In using the instrument, it is placed so that the copper bar is parallel to some portion of the aerial circuit, and the handle is moved up and down until the current induced in the instrument is a maximum; this condition being reached when the neon tube glows most brilliantly. When this is done, the pointer attached to the movable member indicates the wave length on the scale below.

In practice these instruments are made in various standard sizes measuring wave lengths up to 2,500 meters. They are usually provided with four scales reading the wave length in both feet and meters, the oscillation constant of the aerial or other circuit and the number of oscillations per one-millionth of a second. It is also possible to use them for measuring very small values of capacity and inductance and for this purpose they have been found to be extremely accurate. A more sensitive detector than the neon tube has lately been employed, and with this improvement it is possible to measure the lengths of received waves, and to plot resonance curves.

One of the most widely used wave meters at the present time is that of Donitz, which in principle somewhat resembles the one just described. It consists of a hard rubber case in which is placed a variable condenser of the rotary type. This is connected in series with a fixed inductance coil L (Fig. 3), which is placed outside of the instrument. One part of the circuit connecting the two consists of an exceedingly fine platinum wire which is placed in a thermo-ammeter or air thermometer T, which is used to indicate resonance.

In using the instrument, the inductance coil is placed above or below the aerial tuning coil so that a current will be induced in it. The condenser knob is then turned until the thermometer reading is at its highest value while the pointer which is attached to the movable disks then indicates wave length directly upon the circular scales on top of the case.

In order to give the instrument a suitable range, three inductance coils of different values are furnished with each and a separate scale is provided for use with

each coil. Several instruments closely resembling the Donitz meter, or ondrometer as it is called, are now manufactured and they have proven to be highly accurate and very convenient to use.

### WIRELESS SWITCH.

One often wishes to change his wiring quickly in order to try some new diagram. This may be done by following above diagram. All wires connect to some one of the binding posts. The

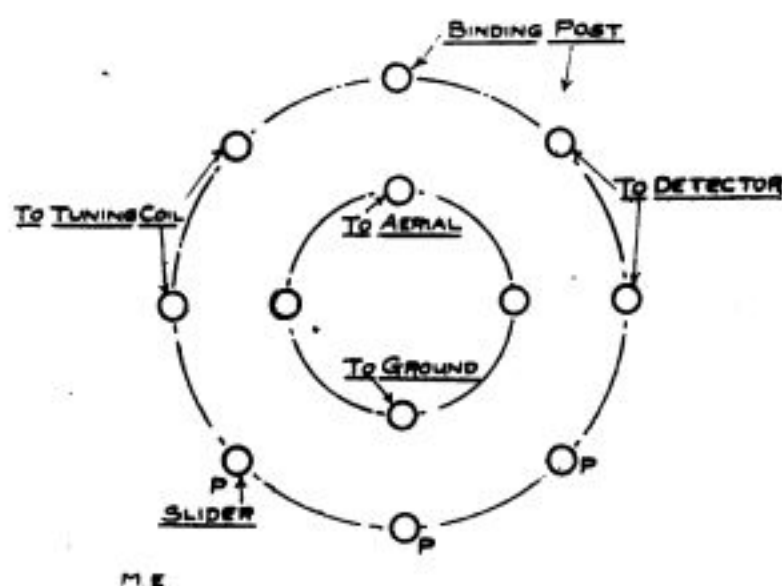

posts are in a circle, with a smaller inner circle for the aerial and ground and any other instrument. With the above diagram a connection can be made in several seconds. All that one has to do is to join one binding post to another and the connection is made.

### More "Modern Electrics"

Many of us wireless tickers  
 O'er our circuits pour in vain,  
 During all but muggy weather,  
 Ever linger full of pain,  
 Reading naught but batt'ry action,  
 No good morse to break the strain.

Even Job would lose his patience,  
 Listening on and not complain,  
 Easy lies no head with phones on,  
 Catching calls, gets on the brain,  
 The only way, my sparking brother,  
 Rests with you to entertain,  
 If the knowledge you would gain,  
 Call upon "Modern Electrics"  
 Surely you wont call in vain.

WILLIAM J. COQUELIN

# Wireless Association of America

## Wireless Registry

This department has been started with the idea to bring the wireless amateur in closer touch with commercial land and ship stations. Each month a list of new members will be printed here and once each year an official BLUE BOOK will be issued by MODERN ELECTRICS giving a list of all the members who registered during the year. Each member will receive the Official Blue Book free of charge. The Blue Book will also contain a complete list of commercial and government stations, their call letters, wave length, etc.

To register a station requires: Total length of aerial (from top to spark balls), spark length, call letter, (if none is in existence M. E. will appoint one) name and address of owner.

Fee for Registry (including one Blue Book) 25 cents.

NAME AND ADDRESS OF OWNER.	CALL LETTER	APPROXIMATE WAVE LENGTH IN METERS.	SPARK LENGTH OF INDUCTION COIL.
----------------------------	-------------	------------------------------------	---------------------------------

Robert J. Goldman, New York, N. Y.,	M.R.G.	80	1 ins.
Richard Johnstone, San Francisco, Cal.,	R.J.	196	1 "
H. T. Hardinge, New York, N. Y.,	G.X.	135	1 "
J. M. Sattler, Nutley, N. J.,	V.D.	100	½ K.W.
Stanley B. Chase, Groton, Mass.,	S.A.	150	1½ ins.
F. Herbert Carl, San Francisco, Cal.,	F.H.C.	130	3 "
Richard Gaschutz, Brooklyn, N. Y.,	M.R.D.	110	3 "
Monroe Jacobs, New York, N. Y.,	M.J.	65	½ K.W.
Fortuna Robert, Manchester, N. H.,	R.N.H.	200	1 ins.
W. H. Crane, New York, N. Y.,	W.	70	1½ "
Abe Garion, New York, N. Y.,	A.G.	160	2 "

NAME AND ADDRESS OF OWNER.	CALL LETTER	APPROXIMATE WAVE LENGTH IN METERS.	SPARK LENGTH OF INDUCTION COIL.
----------------------------	-------------	------------------------------------	---------------------------------

C. R. Runyan, Yonkers, N. Y.,	Y.S.	250	½ K.W.
Leo R. Clark, Rochester, N. H.,	L.R.C.	175	½ "
Victor Schleuder, Springfield, Minn.,	A.B.	60	½ ins.
E. Bernascein, New York, N. Y.,	B.W.	600	1 "
Weyman S. Crocker, Fitchburg, Mass.,	M.W.S.	70	½ K.W.
Harris J. Krim, New York, N. Y.	H.J.K.	200	
Mackenzie School, Dobbs Ferry, N. Y.,	M.S.	200	¼ K.W.
M. Cadenassa, San Francisco, Cal.,	O.Q.	200	¼ "
E. F. Waits, Corinth, Miss.,	M.C.F.	300	4 "
Bamberger Bros., New York, N. Y.,			
Ernest Amy, New York, N. Y.,	M.E.A.	92	3 ins.

NOTE: Parties having registered after May 1st are not entitled to the present Blue Book, but to the one to be published May, 1910.

### A NOVEL IDEA.

Some New York dealers are now selling Geissler tubes for Christmas trees. We had occasion to see a sample tree set up with about twelve tubes, and the effect in the dark green tree was tremendous. The soft light and the many different colors give an indescribably pretty effect which can not be imagined, but must be seen.

The tubes, which were of the liquid and plain type, were run from a one-inch spark coil and six dry cells, or a six-volt storage battery. The tubes were all connected in series, of course, the connections being made with thin copper wire, invisible to the eye.

### EXPERIMENTERS.

Have you read this month's editorial? If not, do so at once; it will interest you surely.

### EELS!

After trying the eel stunt last month I found out the following:

1. The eel electricity is very slippery.
2. The electric eel's favorite food is storage cells.
3. Cat electricity and eel electricity don't mix.
4. The electric eel is wireless.
5. If knocked down by one, call C. Q. D.
6. Two eels' tails placed opposite each other furnish an excellent spark gap. "Fips."

We wish to buy a number of back issues from April, 1908, to September, 1908, inclusive. We shall pay a good price for these issues, if in good condition. We would like to hear at once from readers who desire to dispose of above copies.

## A Silicon Detector

By JAMES D. THOMAS.

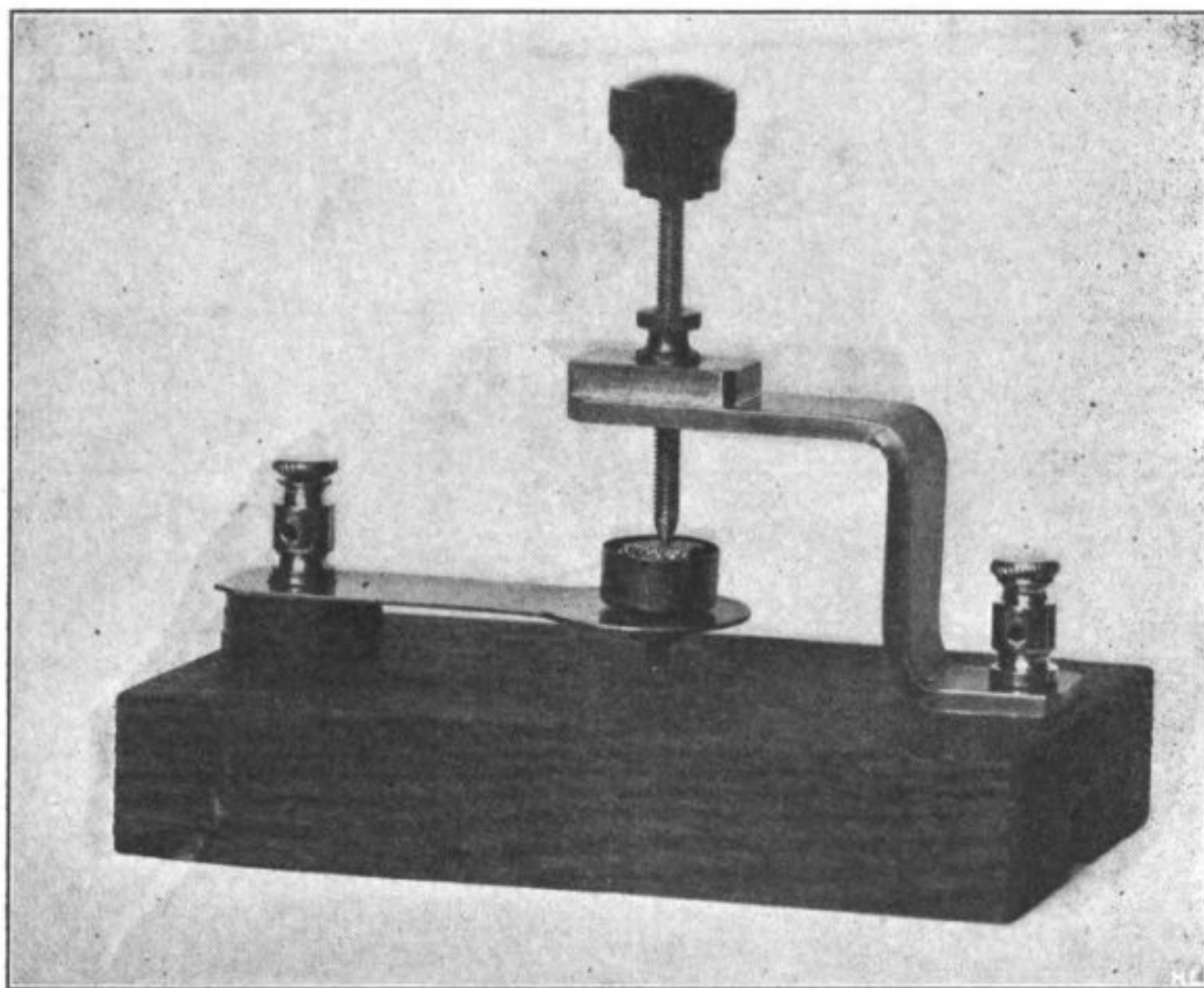

A silicon detector, when used with telephone receivers of from 1,000 to 2,000 ohms resistance, is very sensitive, and does not get out of adjustment easily.

The following detector was made by the writer at a total expense of \$1.00, and gives excellent results; however, telephones of high resistance must be used, for without such phones the advantages are not so appreciable.

For the standard, a piece of brass, Fig. 1,  $4\frac{1}{2}$  inches long,  $\frac{3}{4}$  in. wide by  $\frac{1}{8}$  in. thick, is bent to shape, as shown in Fig. 2, and a hole drilled at A to let a No. 8 screw pass. Next make a piece, as per Fig. 3, 1 in. long,  $\frac{3}{4}$  in. wide by  $\frac{1}{8}$  in. thick; this piece must be soldered or sweated on the end of the standard, B. Fig. 2, rounding the corners to make a nice appearance, as shown in Fig. 4.

Now bore a hole at C. Fig 4 through the center of the brass bushing and standard with a No. 29 drill and tape out for 8.32 screw, as per Fig. 5; this is a brass rod threaded with an 8.32 thread, and is 2 ins. long. On one end

it should be filed down to a flat point about 1.32 in. in diameter, and insulated handle with a threaded metal bushing screwed on the other end. Next, cut out of spring brass 1-32 in. thick the piece as shown in Fig. 6, and drill hole at A to let a No. 8 screw pass. Now comes the most important part of the detector—the Silicon itself, and its holder. Great care must be taken in making this part, and two or three should be made, as Silicon differs, one piece being more sensitive than another in the detection of waves. Get the round brass cup from the top of the round carbon rod in a Columbia or Ever-Ready dry battery, Fig. 7, and saw the screw off, then file the bottom smooth so it will be flat. The screw may be left on and a hole bored to let it pass in the center of the ring on brass spring, as shown in the photograph, but the range of adjustment will not be as great as if it were filed off.

Now take a lump of fused silicon and chip off a piece about 3-16 in. thick and about  $\frac{1}{2}$  in. across the face; grind the flattest side down on a fine emery

wheel until it assumes somewhat the shape as shown in Fig. 7 A. There may be a few pits in the face of the

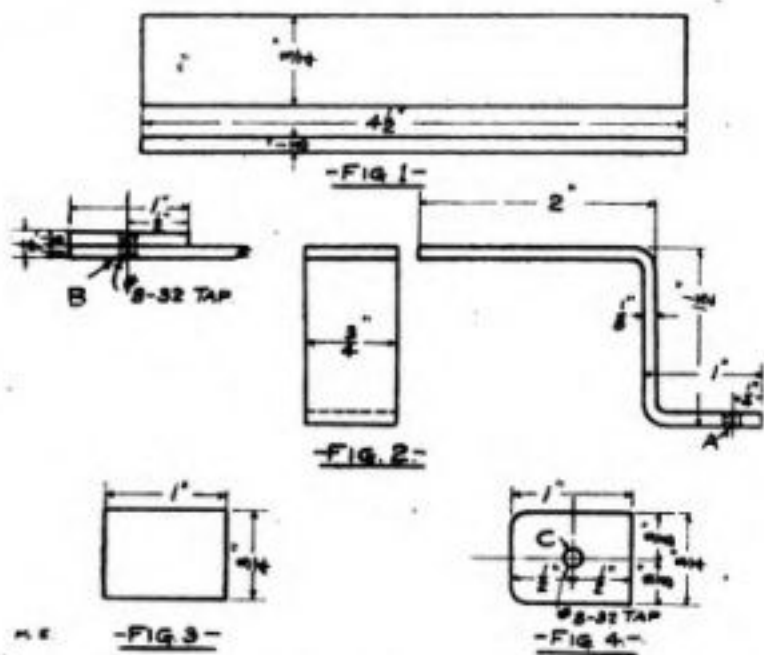

silicon after grinding, but if not too many it will work all right. Take the brass cup, and heating it over a blow torch or Bunsen burner, fill about half full with solder, using soldering paste as a flux. When quite hot press the silicon (face up) down in same, being careful to keep the face of the silicon as level as possible; allow to cool about a minute, then immerse in water so as to entirely cool it. This cup sets on the round part of the spring, Fig. 6, and is made separate, so that it can be easily replaced in case of accident or damage to one. The base is made as per Fig. 8, and holes drilled at A and B large enough to accommodate a No. 8 screw, countersinking them so as to accommodate washer and screw head. The standard is fastened down by the screw passing through the wood at one of the holes in the base, and screwing into a bind-

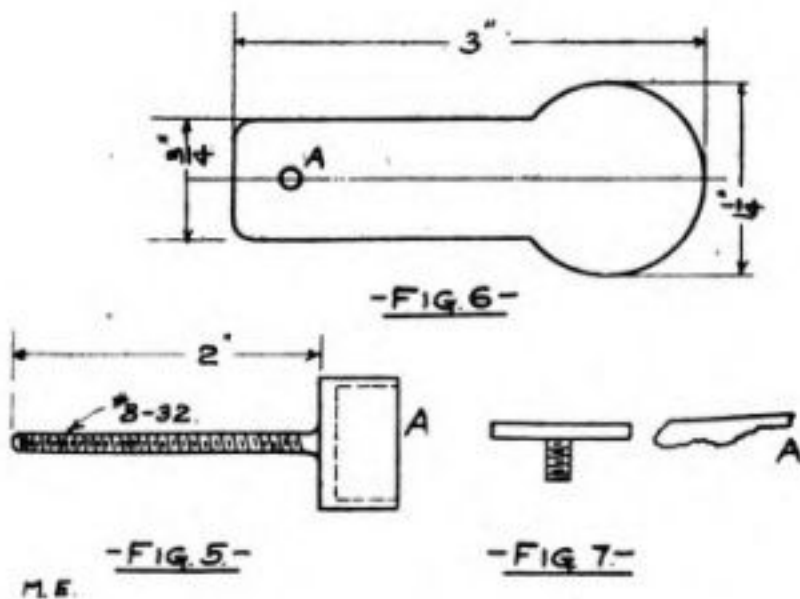

ing post, which serves as means of connection. The spring is held down in the same manner as the standard, the spring being held up from the base by

a brass or fibre washer about 5-16 in. thick by 3/4 in. wide.

The pointed screw, Fig. 4, is now screwed in the standard, with the nut from a dry battery binding post screwed on between the insulated handle and standard to act as a set nut when adjustment is accomplished.

The adjustment is accomplished by screwing the brass point down until it slightly presses on the silicon, then moving around under the point until the signals are heard loudest. The point should be screwed with more or less pressure on the silicon, depending on the sensitiveness of the piece of silicon used. When adjustment has once been found, it will not be necessary to bother with it again unless the detector is jarred or silicon moved, when it may be necessary to readjust.

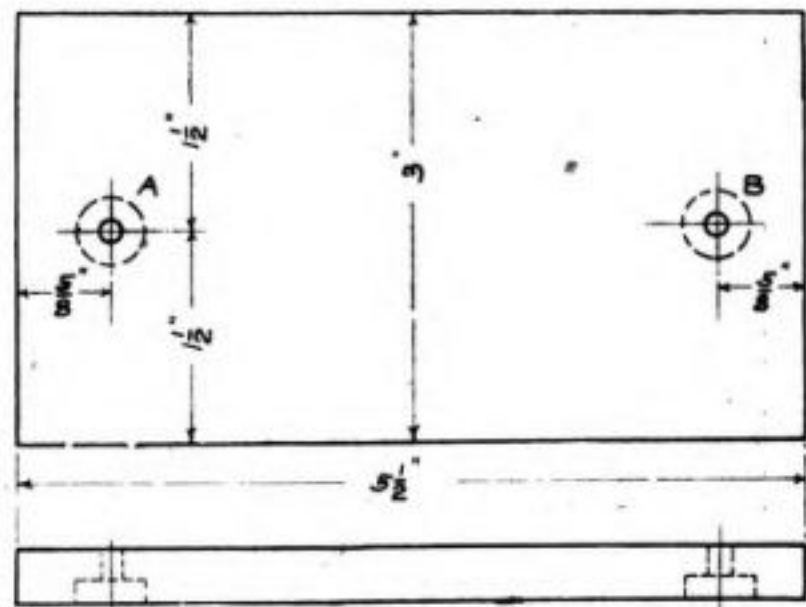

-FIG. 8-

It will not be necessary to give a diagram of connections, using the other different instruments needed, such as tuning coil, condenser and phones, as many good diagrams have been given in MODERN ELECTRICS.

W. A. O. A.



The Wireless Association of America, headed by America's foremost wireless men, has only one purpose: the advancement of "wireless."

If you are not a member as yet, do not fail to read the announcement in the January issue. *No fees to be paid.*

Send today for free membership card. Join the Association. It is the most powerful wireless organization in the U. S. It will guard your interest when occasion arises.

## Wireless Telegraph Contest

Our wireless Station and our Laboratory Contest will be continued every month until further notice. The best photograph for each contest is awarded a monthly prize of Three (\$3) Dollars. If you have a good, clear photograph send it at once; you are doing yourself an injustice if you don't. If you have a wireless station or a laboratory (no matter how small) have a photograph taken of it by all means. Photographs not used will be returned in 30 days.

PLEASE NOTE THAT THE DESCRIPTION OF STATION MUST NOT BE LONGER THAN 250 WORDS, AND THAT IT IS ESSENTIAL THAT ONLY ONE SIDE OF THE SHEET IS WRITTEN UPON. SHEET MUST BE TYPEWRITTEN OR WRITTEN BY PEN. DO NOT USE PENCIL. NO DESCRIPTION WILL BE ENTERED IN THE CONTEST UNLESS THESE RULES ARE CLOSELY ADHERED TO.

It is also advisable to send two prints of the photograph (one toned dark and one light) so we can have the choice of the one best suited for reproduction.

This competition is open freely to all who may desire to compete, without charge or consideration of any kind. Prospective contestants need not be subscribers for (the publication) in order to be entitled to compete for the prizes offered.

### FIRST PRIZE, THREE DOLLARS.

Recently I had a photograph taken of my wireless outfit for the purpose of entering it in the prize contest. All the instruments are home made, with the exception of the receivers, spark coil and key.

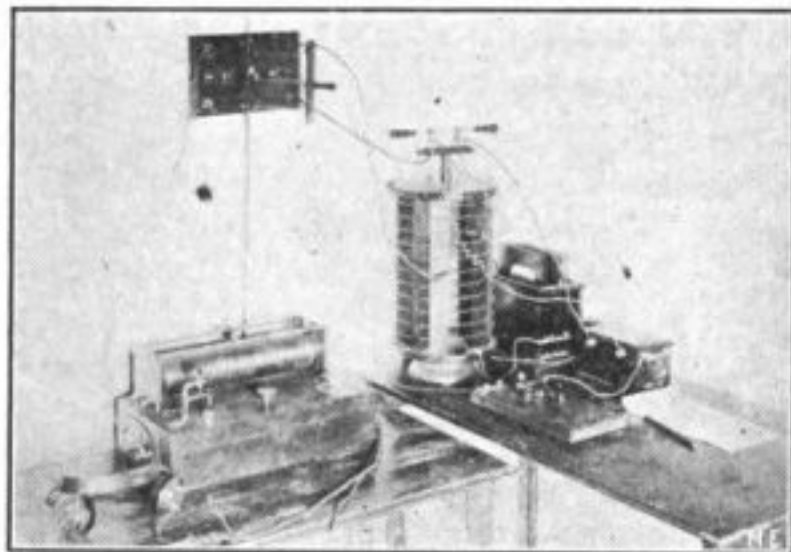

The receiving set, which is mounted on a case, is 8x16x4 inches, and includes tuning coil, detector, potentiometer, intermeshing condenser, set of "electro" 1,000 ohm receivers and a test buzzer. Push button being hidden in the picture. Potentiometer is adjusted with a rotary motion. The aerial and ground are connected to two binding posts at the end of the case and the receivers at the other end. The wooden parts are finished in ebony and the metal parts in polished brass and silver plating. I use the E. I. Co.'s R-1,000 set-up and get perfectly satisfactory results.

The sending instruments consist of a 1-inch coil, Helix, spark gap, and an adjustable condenser having four plates, 6x10 inches. I am using the Fessenden set-up. The switch is a T. P. D. T., cutting one side out when the other is working.

My air wire is stretched between two poles, 50 feet high, and 100 feet apart. It consists of four wires and is used either straightaway or looped. The

ground is led to the cellar and a square yard of copper by a number ten wire.

I receive from the ports and merchant vessels on Lake Michigan and have a partner a mile and a quarter away and we are in constant communication.

Wisconsin. M. J. BISHOP.

### HONORABLE MENTION.

Enclosed find photo of my wireless station, which is in my room. I have been experimenting with wireless for about six months.

On the right hand side of my table is an E. I. Co. one-inch coil. I have a condenser shunted across my spark gap. My hand can be seen on the key. The helix, which I made myself, is wound with ten turns of No. 6 copper wire. At the left of the helix is a D. P. D. T. aerial and ground switch.

I am going to use a signaling outfit for signaling me when out or in my room, but otherwise I use the DeForest system.

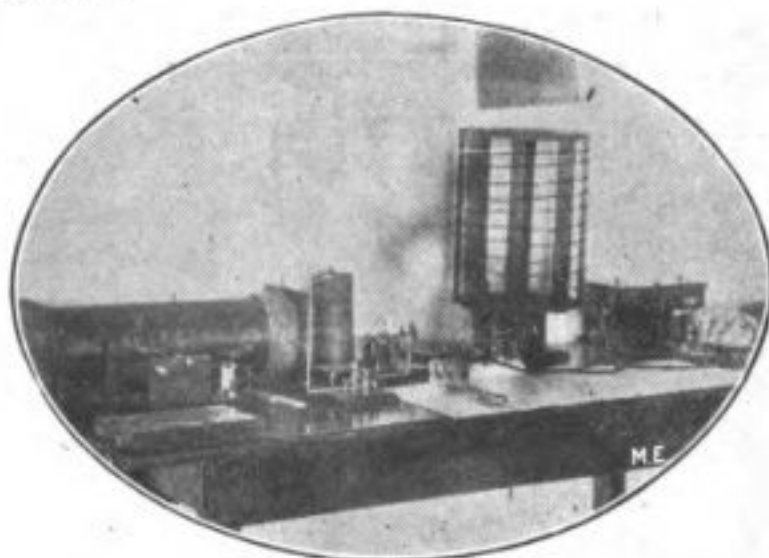

At the left of the table is my 300 meter length tuning coil, which I also made myself. It has a secondary winding, which can be seen on the right side. An E. I. Co. double slide tuning coil can be seen in front of my large one. I use the electrolytic detector, which gives very good results. My condensers are made of photograph plates and tinfoil.

I gain a great deal of information from MODERN ELECTRICS, which I buy monthly.  
 CARL PETERSON.  
 South Dakota.

**HONORABLE MENTION.**

Enclosed you will please find photo of my wireless station. The transmitter consists of a 1-2 K. W. transformer, zinc spark gaps, one of which is an E. I. Co.'s, Glass plate condenser made up of 40 plates, 8x8 in., helix and anchor gap. The picture was taken before I completed the transformer, and has a 1-inch coil in its place, with a pint Leyden jar. The glass plate condenser may be seen on the shelf of the small table. It has a battery and buzzer sitting on it, used as a test. For receiving I use silicon and perikon detectors, two tuning coils, condenser and my own connections. My aerial is made up of four copper wires,



No. 16 B and S gauge, 75 feet long; the highest end is 80 feet high and the lowest end is 70 feet. With this aerial I get splendid results. It is insulated with E. I. Co.'s insulators. My phones are of the double pole pattern, wound to 1,000 ohms each. MODERN ELECTRICS is a great help to me, and, as other boys say, I would not do without it.

DEREK BREITENBACH.  
 Washington, D. C.

**HONORABLE MENTION.**

Enclosed please find photos of my wireless station. I have devoted eight months experimenting with wireless. The transmitter consists of an E. I. Co. one-inch coil run on twenty dry cells, wireless key with zinc contacts, zinc spark gap and a condenser of low capacity shunted across the secondary—all home made. The spark obtained is 1-8 inch long and the same thickness. I

can at all times telegraph a distance of seven miles.

The receiver consists of a double slide tuning coil of 300 meters' capacity, po-



tentiometer, carborundum, electrolytic detectors—all my own make—and a Murdock mineral detector, 3,000 ohm phones, fixed condenser and two batteries. I employ a D. P. D. T. switch to change from transmitting to receiving. I also use a three point switch for detectors.

The aerial consists of two number 14 magnet copper wires strung from a red-wood tree 100 feet high, running 250 feet, to a tank thirty feet high, from which the wires run to my station.

The ground wire is attached to a water pipe and also to copper plates immersed in damp soil, covering 100 feet of surface. With this set I have heard Khuku, Oahu, the fifteen K. W. set, 2,200 miles from my station. The above description is my experimental station in my country home, ten miles from Santa Rosa.

I have found MODERN ELECTRICS to be the most perfect explanatory magazine on wireless.

San Francisco, Cal LEONE CADENASSE.

**HONORABLE MENTION.**

The following is a picture of my wireless station:

At the right of picture will be seen my sending station.

A sending helix having 13 turns of No. 10 copper wire, one zinc spark gap, two induction coils giving about a 1 1-2 spark, connected in series operated on 110 volts, and an electrolytic interruptor which cannot be seen; two condensers using gas chimneys, a telegraph key and a Geissler tube, used as a hot wire ammeter.

At the left of the picture will be seen my receiving station.

A tuning coil of 632 meters, adjustable condenser made up of plates of

brass, one 300 ohm potentiometer, one 1,000 ohm receiver, two detectors, an electrolytic and a silicon. By using the double pole double throw switch either detector may be used.

My aerial is made up of four strands of No. 12 copper wire, 20 feet long, on top of the house, and 30 feet from the ground. The ground connection is made from the gas pipe to instrument with No. 8 wire.

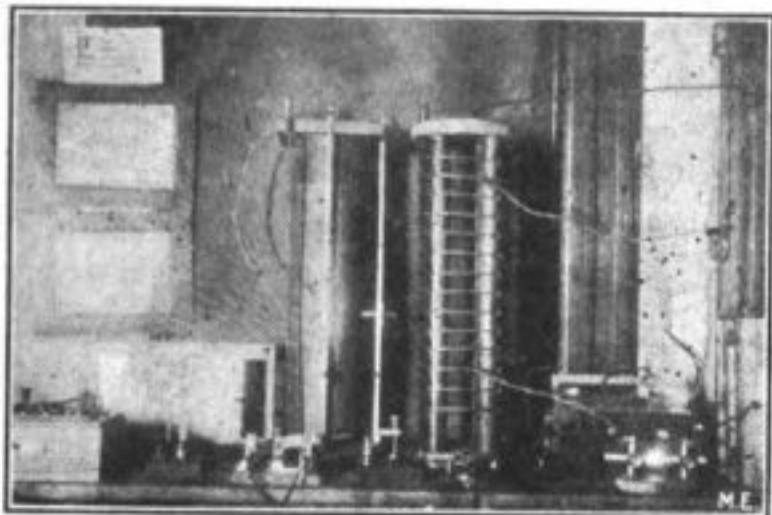

I made all the instruments myself, with the exception of induction coil (auto type), 1,000-ohm receiver and double-pole double throw switch. To your magazine is due my success in building my wireless station, and I would not be without it. THOS. BRENDL.

Detroit, Mich.

#### HONORABLE MENTION.

Photograph published herewith represents the wireless station of Mr. Joseph Lesmeister, Harvey, N. D. He would like to get in communication with some wireless experimenter nearby. Mr. Les-

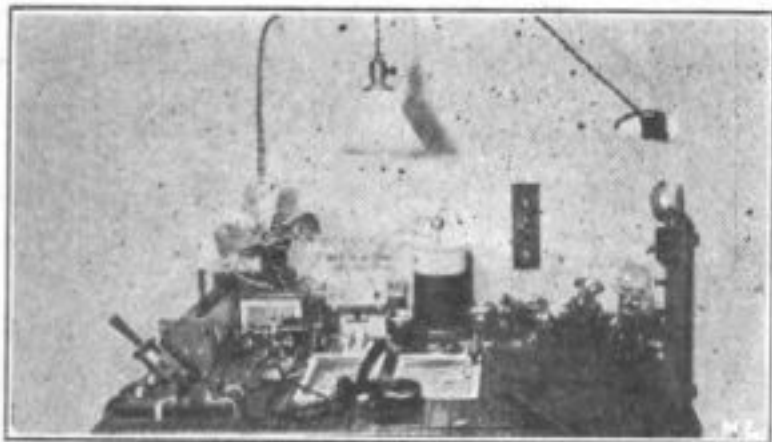

meister is also a member of the W. A. O. A.

#### HONORABLE MENTION.

Enclosed find a photograph of my wireless outfit, part of which I made myself, with many helpful hints from MODERN ELECTRICS, of which I am a constant reader.

The receiving instruments consist of tuning coil, condenser, silicon and tanta-

lum detectors, both home made; either can be thrown in by a 2-point switch, which is between them. I find the silicon is the most sensitive; a rheostat, which takes the place of a potentiometer; a pair of 75-ohm receivers, which are now replaced by a pair of the "E. I. Co.s" 2,000-ohm receivers, and a double pole, double throw switch to throw in receiving or sending. The S. P. S. T. switch on the edge of the bench is the ground switch.

The sending instruments consist of two inch spark coil, spark gap on top. Morse telegraph key, helix and plate glass condenser are on the side and not in the picture; switch in front of coil is for the batteries, of which there are eight.

Ground is made with an "E. I. Co.'s" ground clamp on the water pipe underneath the bench.

Aerial consists of two strands of No. 14 aluminum wire, 60 feet long, 75 feet



high at one end and 30 feet at the other end. Each wire is five feet apart.

The telegraph shown is one I have with a friend of mine.

Connecticut. NORMAN E. SOULES.

#### HONORABLE MENTION.

Enclosed you will find a photograph of my wireless station, which I have made myself. It consists of tuning coils, variable condenser, fixed condenser, carbundum, electrolytic and perikon detectors, a rheostat, switches and head phones.

On the left of the picture may be seen one of the tuning coils; right under this is a brass tube variable condenser, with which I have had excellent results. To the right may be seen another tuning coil, while under the bench right by my hand may be seen a large double slide tuner, that I made from an old MODERN

ELECTRICS, and which is very useful to my station. I have also had very fine results with my "electrolytic" detector. On the table are the detectors, switches



and rheostat. I have one pair of Sullivan phones and a pair of E. I. Co.s 1,000 ohm phones, which I get very good results from. On the shelf above may be seen the coil Leyden jars and helix.

I use the United Wireless Company's wiring system, and am able to receive messages as far away as Cape Hatteras, N. C., and Cape Cod, Mass.

My aerial consists of four pounds of aluminum wire on our barn, which is over 200 feet from the house. It is four strand looped, and I run two base wires from it to the house. The total height is about 70 feet from the ground and it is about 70 feet long.

I have been greatly aided by MODERN ELECTRICS, and recommend it to all who are interested in wireless.

New York. STANLEY R. MANNING.

#### HONORABLE MENTION.

Enclosed find photo of my wireless station. The same has been in operation for seven months. It consists of transmitting 1-2 K. W. transformer,

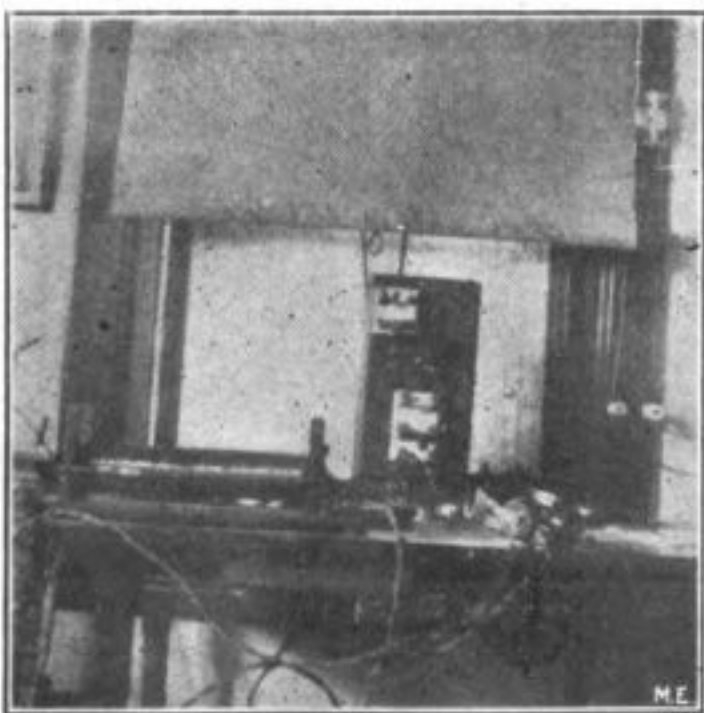

10-plate condenser, 14x14 inches, sending inductance, wireless key, aluminum

circular disc, spark gap and a water rheostat. Receiving, double slide tuner wound with No. 22 wire, fixed condenser, iron sulphide and silicon detectors, 300-ohm phones. Aerial consists of four copper wires No. 15, 8 feet, spreaders, 80 and 50 feet high, respectively. With this apparatus I have been able to transmit messages 100 miles and pick up Friday Harbor, San Juan island in Northern Washington, 1,500 miles distant. As I am living on a hill my aerial clears everything many miles out to sea. The D. P. D. T. switch shown on the switch board changes from sending to receiving and holds the high tension current very well. The aerial leads leave from the top of the switch board. The spark gap is made of aluminum with 5 brass rings 1/2 inch apart, which cools the points. It is behind the tuner. The ground consists of 3 zinc plates buried from 3 to 4 feet deep in the earth which is kept constantly moist. All the wires are soldered and heavily insulated, which is a great necessity. Los Angeles, Cal. STANLEY HYDE.

#### THE COLIN & JEANCE RADIOPHONE.

(Continued from Page 414)

(not shown). The inventors use a great number of microphones in series at S, and a commutating switch enables the use of a greater or less number. All the microphones are mounted on a large hollow base, which leads to a single mouthpiece of special construction. Any of the usual detectors can be employed with the apparatus. The arcs can be made to burn in air, hydrogen, coal gas or other gases; also in liquids such as water, petroleum, heavy oils, etc. The apparatus of this kind which was used in the Mediterranean tests was constructed by the Carpentier-Gaiffe-Rochefort firm of Paris.

#### HEROES OF WIRELESS TELEGRAPHY.

(Continued from Page 412)

Doubtless Eccles if he had survived would have shown the same characteristics. It was "all in the day's work." Yet a world which appreciates the qualities which such men show will not the less esteem the deeds done and the doers thereof.



# Electrical Patents for the Month

**939,436. TELEPHONE ATTACHMENT.** HARRY E. PALMER, Seattle, Wash. Filed Mar. 3, 1909. Serial No. 419,024.

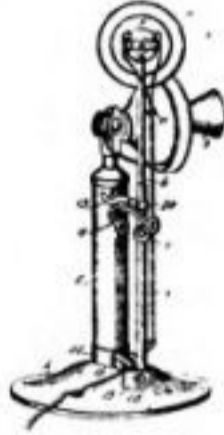

In a desk set, the combination with the transmitter supporting column, of a clip consisting of a metal strap, encircling said column and having the opposite ends thereof brought into parallel relation to each other to form clamping jaws disposed at an angle to the line of projection of the mouth piece of the transmitter, a clamping screw connecting said jaws, a tubular receiver supporting standard embodying telescopic sections and having its lower end held between the clamping jaws of said clip adapting said standard to swing toward and away from the receiver hook at an angle to the line of projection of the mouth piece of the transmitter, and a disconnecting arm adjustably mounted on said standard and adapted to interlock with the receiver hook of the transmitter and hold the receiver standard in an upright position.

**939,441. APPARATUS FOR PRODUCING ELECTRIC DISCHARGES.** HARRY PAULING, Gelsenkirchen, Germany, assignor to The Firm of Salpeters-Aure-Industrie-Gesellschaft, Ges. M. B. H., Gelsenkirchen, Germany. Filed Dec. 18, 1905. Serial No. 292,205.



Apparatus for producing electric discharges having in combination stationary electrodes with a distance between them large enough to prevent ignition, a conductor successively passing and thereby alternately increasing and decreasing the distance between the said electrodes and blast pipes adapted to extinguish the discharges before short-circuiting between the electrodes may occur, substantially as described and for the purpose set forth.

**940,485. ELECTRIC CHIME.** JAMES E. BOYDALL, Chicago, Ill. Filed Jan. 8, 1909. Serial No. 471,280.

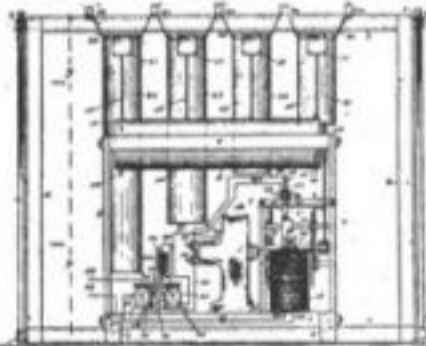

1. In an electric chime, a main frame and chime bells attached thereto, a motor circuit and a motor, means actuated by said motor for vibrating said bells, a clock arbor, a clock circuit, a current make-and-break device actuated by said arbor, a relay in said clock circuit, an oscillating armature actuated by said relay and adapted to close the motor circuit when said relay is energized, and a timing wheel driven by said motor and provided with peripheral notches to control the time of maintaining the motor circuit closed at each operation of the chime, substantially as described.

**940,724. ELECTROLYTE FOR USE IN ELECTRIC BATTERIES.** WALLACE J. L. SANDY, London, England. Filed Aug. 22, 1908. Serial No. 449,774.

An electrolyte produced by adding to 36 fluid ounces of a mixture containing 2 volumes sulfuric acid, 2 volumes of hydrochloric acid and 1 volume of water the following: 22 ounces of bichromate of sodium dissolved in 128 ounces of water and 6 fluid ounces of a saturated solution of caustic soda.

**939,212. SHOE-LAST.** ADAM J. BUCH, Portsmouth, Ohio. Filed Jan. 17, 1908. Serial No. 411,272.

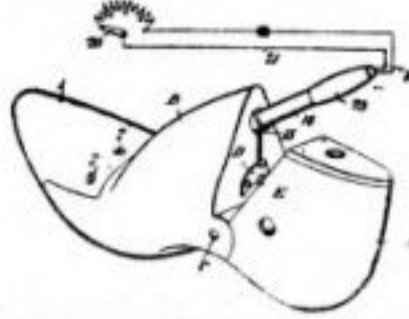

1. A last having a toe piece of heat conductive material, said toe piece being provided with a recess, in combination with an electrical heater housed in said recess, an insulating packing between the heater and the walls of the recess, and a metallic plate secured upon the under side of the last and serving to retain the heater in its recess or housing.

**940,428. APPARATUS FOR NEUTRALIZING ELECTRICITY IN MOVING MATERIAL.** WILLIAM H. CHAPMAN, Portland, Me. assignor to Chapman Electric Neutralizer Company, Portland, Me., a Corporation of Maine. Filed Nov. 3, 1905. Serial No. 285,677.

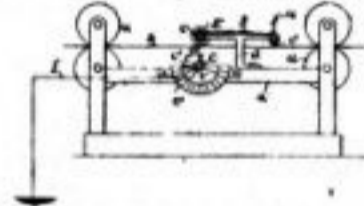

1. The herein described apparatus for neutralizing static electricity in moving material consisting of a comb conductor located adjacent to the moving material and connected with earth, an insulated conductor located adjacent to said comb conductor charged with electricity of the same polarity as that of the material to be treated.

**940,430. ELECTRIC PROCESS FOR MAKING PICTURES.** BRAXTON D. AVIS, JR., Wallace, W. Va. Filed June 23, 1908. Serial No. 439,992.

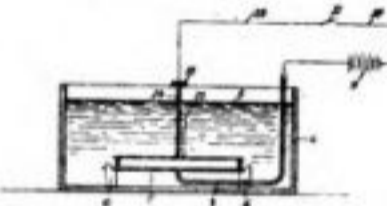

1. The method herein described of making pictures, which consists in producing a conducting surface, spreading thereover a gelatinous film sensitive to light, exposing said film to the action of the light so that different portions of said film receive more light than others, and depositing a metal electrolytically upon said conducting surface and through said film so that varying quantities of said metal are deposited upon different portions of said surface.

2. The method herein described of making pictures, which consists in preparing a conducting surface, coating the same with a film, the solubility of which is affected by light, exposing said film for the purpose of rendering different portions thereof insoluble in various degrees so as to vary electrical resistance of different portions of said film, and depositing a metal electrolytically upon said conducting surface through said film.

**939,605. ELECTRIC WATER-HEATER.** HERMAN G. LEVY and GEORGE N. BLANCHARD, San Francisco, Cal.; said Blanchard assignor to said Levy. Filed Mar. 20, 1909. Serial No. 466,900.

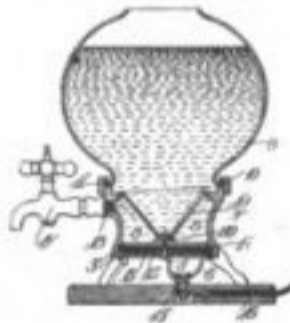

1. A heating unit comprising two sheets of insulated material the opposed surfaces of which are normally coated with a blinder which will become active on the application of heat thereto; and a winding of bare metal and insulating material between the sheets forming a flat insulated coil, said winding being united to the sheets to bind the several parts and thereby form a substantially rigid heating element.

**940,429. METHOD OF NEUTRALIZING STATIC ELECTRICITY.** WILLIAM H. CHAPMAN, Portland, Me., assignor to Chapman Electric Neutralizer Company, Portland, Me., a Corporation of Maine. Filed Dec. 18, 1908. Serial No. 292,258.

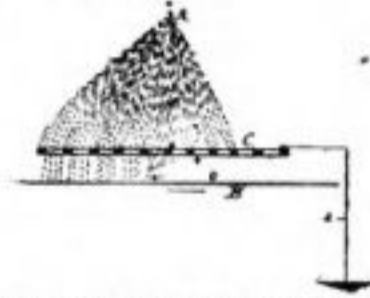

1. The herein described process of neutralizing static electricity in a charged surface which consists in charging a conductor embodying fine radiating surfaces with electricity of high voltage and of a polarity opposite to that of the surface to be neutralized and interposing between said conductor and surface to be neutralized a perforated screen of metal or other conducting material connected to earth.

**940,397. BINDING-POST.** ADAM LUNGEN, New York, N. Y., assignor to Edwards & Company, a Corporation of New York. Filed Jan. 16, 1909. Serial No. 472,642.



1. A binding post comprising a body with a pair of upwardly projecting arms, a screw journaled in both of said arms and extending therebetween, means for preventing longitudinal displacement of said screw in either direction, said arms, and a traveling nut on said screw guided by said body in a longitudinal but non-rotative movement.

**941,339. PROCESS OF PRODUCING SILICON CARBIDE.** FRANK J. TONK, Niagara Falls, N. Y. Filed June 14, 1907. Serial No. 379,034.

1. The process of producing silicon carbide, which consists in embedding in a charge of silicious and carbonaceous materials a resistance-conductor consisting of a linear series of separate shaped resistance-pieces of predetermined cross-section and resistance arranged in direct electrical contact, and passing an electric current through said conductor.



2. The process of producing silicon carbide, which consists in embedding in a charge of silicious and carbonaceous materials a resistance-conductor consisting of a series of separate shaped resistance-pieces of predetermined cross-section and resistance arranged longitudinally in direct electrical contact and supported by the charge, and passing an electric current through said conductor.

**938,588. SELF-LOCKING RELAY.** JACQUES F. KEMM, Chicago, Ill. Filed Jan. 16, 1909. Serial No. 472,748.

In a device of the character described, a magnet in electrical connection with a clock control switch provided with a pivoted armature having an insulated arm secured thereto adapted to open and close a time recorder circuit switch, a second magnet also in electrical connection with a clock control switch and provided with a pivoted armature and a connecting link pivoted to said armatures,

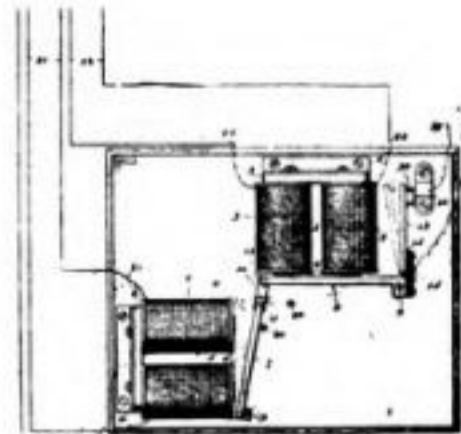

whereby each armature is self-locking and adapted to be unlocked by the other armature, substantially as and for the purposes set forth.

Original Electrical Inventions for Which Letters Patent Have Been Granted for Month Ending November 23.

Copy of any of the above Patents will be mailed on receipt of 10 cents.



Queries and questions pertaining to the electrical arts addressed to this department will be published free of charge. Only answers to inquiries of general interest will be published here for the benefit of all readers. Common questions will be promptly answered by mail.

On account of the large amount of inquiries received, it may not be possible to print all the answers in any one issue, as each has to take its turn. Correspondents should bear this in mind when writing, as all questions will be answered either by mail or in this department.

If a quick reply is wanted by mail, a charge of 15 cents is made for each question. Special information requiring a large amount of calculation and labor cannot be furnished without remuneration. THE ORACLE has no fixed rate for such work, but will inform the correspondent promptly as to the charges involved.

NAME AND ADDRESS MUST ALWAYS BE GIVEN IN ALL LETTERS. WHEN WRITING ONLY ONE SIDE OF QUESTION SHEET MUST BE USED; DIAGRAMS AND DRAWINGS MUST INVARIABLY BE ON A SEPARATE SHEET. NOT MORE THAN THREE QUESTIONS MUST BE ASKED, NOR SHALL THE ORACLE ANSWER MORE THAN THIS NUMBER. NO ATTENTION PAID TO LETTERS NOT OBSERVING ABOVE RULES.

If you want anything electrical and don't know where to get it, THE ORACLE will give you such information free.

### A MINUTE BATTERY.

(396.) C. D. KETCHAM, New Jersey, writes:

1.—Please explain why it is that when I take a silver cup, gold lined, and fill it with common water and place one plug of a 75 ohm receiver in the center and touched the other to the silver a click like that of a weak battery could be heard?

A. 1.—Because the two different metals with water as the electrolyte form a miniature battery and although the current is very weak it may be detected by a sensitive instrument, such as a telephone receiver.

2.—Which would make the best ground, the water pipe or a well?

A. 2.—The water pipe ground would probably give a greater capacity than the well ground because of the water pipe running for quite a distance under the earth, while if your ground is made in the well a wire will probably run down into the well and the only actual earth contact will be at the bottom of the well.

3.—In making a tuning coil is a core used?

A. 3.—No. Only a non-metallic form on which to wind the wire.

### RECEIVING DISTANCES.

(397.) CLAYTON WILLIAMS, Kentucky, asks:

1.—How far can I receive with the following: T antenna 50 feet long, 4 wires, 45 feet high, electrolytic detector, fixed condenser, E. I. Co. electro tuner, 75 ohm receiver?

A. 1.—100 to 300 miles.

2.—With E. I. Co.'s Electro loose coupler in place of tuning coil?

A. 2.—200 to 400 miles.

3.—With 1000 ohm receiver, in place of 75 ohm?

A. 3.—Probably 500 miles.

### TWO M. F. CONDENSER.

(398.) MAXWELL ALLON, Massachusetts, asks:

1.—Can a 2 + M. F. condenser, made by

Western Electric Co., be used for receiving?

A. 1.—Yes, if it is not of the rolled type.

2.—Where can I have an armature for a dynamo which I am making, made?

A. 2.—Almost any experimenters' house will be glad to construct an armature for you. We would suggest that you look over our advertising columns.

3.—How is a 2,500 ohm potentiometer made?

A. 3.—There are many different ways of constructing potentiometers, some of which have been described in our recent issues. We think that the non-inductive type is the very best.

### AUDION DETECTOR.

(399.) FRANK SCULLY, North Dakota, writes:

1.—From what company can I obtain an "Audion" detector?

A. 1.—Radio Telephone Co.

2.—Would a polarized relay be better than the regular telegraph relay for use with a filings coherer outfit?

A. 2.—Most assuredly.

### FIXED CONDENSER.

(400.) MARCUS LEITCH, JR., New Jersey, writes:

1.—What microfarad is the E. I. Co. fixed condenser?

A. 1.—About .005 microfarad.

2.—How many sq. in. does the above contain? (of tin foil).

A. 2.—About 135 square inches.

### LEAD PIPE STORAGE BATTERY.

(401.) J. EDWARD CUMMINGS, Pennsylvania, writes:

1.—Through what resistance should 3 gravity cells be left working?

A. 1.—About 15 ohms.

2.—What would be the ampere hour capacity of a storage cell made as follows: Negative is a lead pipe 5 x 1 3/4 inches. This is used as the cup to hold the electrolyte. The positive is also a lead pipe 5 x 3/4 inches. This is drilled full of small holes and holds the red lead?

A. 2.—Probably 15 to 20 ampere hours

3.—I have made an induction coil, using No. 35 wire on the secondary. As I had only 7 ounces of this wire it is not enough. Would it make any difference if I wound on some No. 32 wire, as I do not have any of the other?

A. 3.—We would not advise this, although you would probably be able to use the instrument as a shocking coil.

**CONDENSER.**

(402.) FRANK B. HANFORD, New Jersey, asks:

1.—How many square inches of tin foil would be needed in a condenser of .002 microfarads capacity, using paper, of which a sample is enclosed?

A. 1.—From 60 to 75 square inches.

**RECEIVING DISTANCE.**

(403.) B. LAWRENCE, Bronx, asks:

1.—Please let me know how far I can send with the following instruments: "Electro" transformer coil ½ K. W., "Electro" special sending helix, "Electro" zinc spark gap, "Electro" adjustable condenser, aerial on top of a house 60 feet high, aerial pole 20 feet high, 50 feet between poles, using a current of 110 volts?

A. 1.—About 25 miles. If you use an electrolytic interrupter you should be able to send messages 75 to 100 miles.

**RECEIVING CONNECTIONS.**

(404) L. DENNISON, Michigan, asks:

1.—How shall I connect auto-coherer, single slide tuning coil, variable condenser, 2 75-ohm receivers, 10-ohm reostat?

A. 1.—Diagram given below.

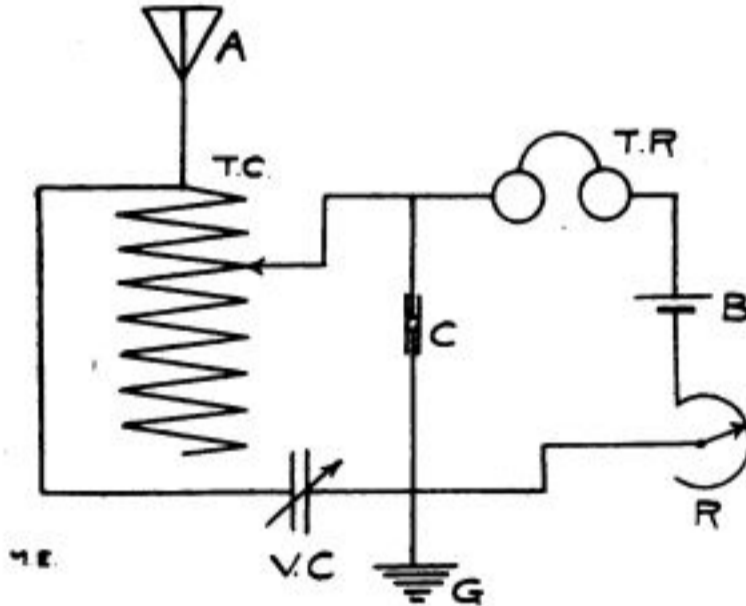

2.—How shall I connect 1 inch spark coil, zinc spark gap, Morse key, sending helix, sending glass plate condenser?

A. 2.—Diagram given below.

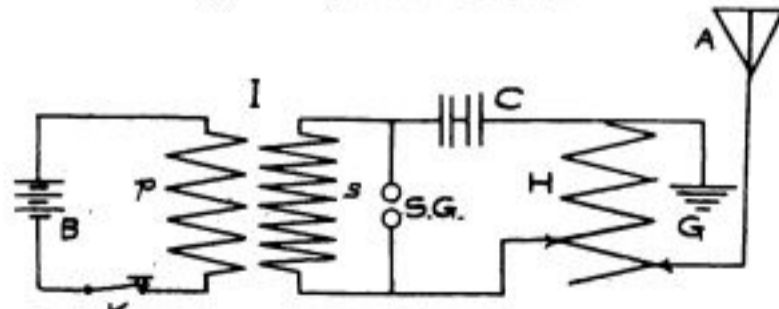

3.—How high shall I make my aerial? Of what shall I make my sending helix?

A. 3.—As high as possible. We prefer aluminum wire for use in the construction of both aerial and sending helix. No. 14 B. & S. for aerial, No. 8 for helix.

**RECEIVING DISTANCE.**

(405) HOWARD M. ANDERSON, California, asks:

**All You Need is the Idea**

We design and manufacture Mechanical and Electrical Instruments and Apparatus of precision for all purposes.

**MULLER & JABLONSKY**

**Electrical Instrument Makers**

62 CORTLANDT STREET NEW YORK

EXPERIMENTAL AND MODEL WORK  
SPECIAL MACHINERY, TOOL AND FIXTURES

When writing please mention "Modern Electrics."



**HOLTZER-CABOT**  
**Wireless Operator's**  
**HEAD RECEIVERS**

Double Head Band, Leather Covered and Padded, Pneumatic Air Cushions, complete with cords, as shown.

500 ohm \$10 1000 ohm \$11  
1500 " 12 2000 " 13

Write for discount and Booklet No. 20-K-2.  
Continental Code Card 7x9 in. Free with each Receiver.

**THE HOLTZER-CABOT ELECTRIC CO.**  
Chicago Ill. Brookline, Mass.

When writing please mention "Modern Electrics."

**WIRELESS APPARATUS**  
**and Electrical Supplies**  
**SPECIAL**

¼ K. W. Transformer \$22.00. ½ K. W. \$31.75  
¾ K. W. \$42.75. 1 K. W. \$55.50  
with 10,000 to 20,000 volt secondary, wound in sections on circular core with hard fibre tube over all the windings.  
Spark Gaps, Spark Coils all sizes, Sending Helix, Keys and Switches.

**THE IMPROVED SILICON DETECTOR**

Tuning Coils, Potentiometers, Condensers, sliding rotary, fixed, and series multiple, also combination to use in connection with rotary switch control.  
Telephone Receivers, hard rubber case, with nickel plated head band adjustable, also gold diaphragm and six foot cord \$3.00.

**THE WIRELESS EQUIPMENT CO.**  
**ARLINGTON, MD.**

When writing please mention "Modern Electrics."

**PATENTS** That Protect and Pay

**WATSON E. COLEMAN,**

Registered Patent Attorney,

Advice and Book Free; Highest References; Best Service

612 F Street, N. W. WASHINGTON, D. C.

When writing please mention "Modern Electrics."

**Magnet Wire**

At fabulous low prices. Ask for quotation on size, style and quantity desired.

**S. M. COHN & CO., 83 Fulton Street,**  
**NEW YORK CITY**

When writing please mention "Modern Electrics."



## Which Will You Choose?

Will it be "Just a Common Job" at small pay or one of the well paid positions which the American School of Correspondence can train you to fill?

Many poorly paid but ambitious men have over-come greater obstacles than those which confront you—have been trained by the American School to fill a good position at big pay.

It is easy to acquire training. Choose the position you desire to hold by marking and mailing the coupon below. Let us send you a complete solution of your problem.

The American School is the *greatest practical training school* in the world. It will come to you no matter where you live and train you in your spare time—in your own home.

Make your choice today by filling in and mailing the coupon. There is no obligation. The American School sends complete information quietly and promptly by mail—not by an agent to bother you in your home or at your work. We will tell you frankly and honestly just how we can help you. *Mail the free information coupon today.*

**American School of Correspondence**  
CHICAGO, U. S. A.

### FREE INFORMATION COUPON

American School of Correspondence:

Please send me your Bulletin and advise me how I can qualify for position marked "X."

- |                           |                          |
|---------------------------|--------------------------|
| ....Book-keeper           | ....Draftsman            |
| ....Stenographer          | ....Architect            |
| ....Accountant            | ....Civil Engineer       |
| ....Cost Accountant       | ....Electrical Engineer  |
| ....Systematizer          | ....Mechanical Engineer  |
| ....Cert'f'd Public Acc't | ....Sanitary Engineer    |
| ....Auditor               | ....Steam Engineer       |
| ....Business Manager      | ....Fire Insurance Eng'r |
| ....Commercial Law        | ....College Preparatory  |

NAME .....

ADDRESS .....

OCCUPATION .....

Mod. Elec. 12-09

Bus.

1.—Please show diagram for the most efficient arrangement of the following apparatus: Single slide tuning coil, variable condenser, fixed condenser, silicon detector and a 150-ohm receiver.

A. 1.—Diagram given below.

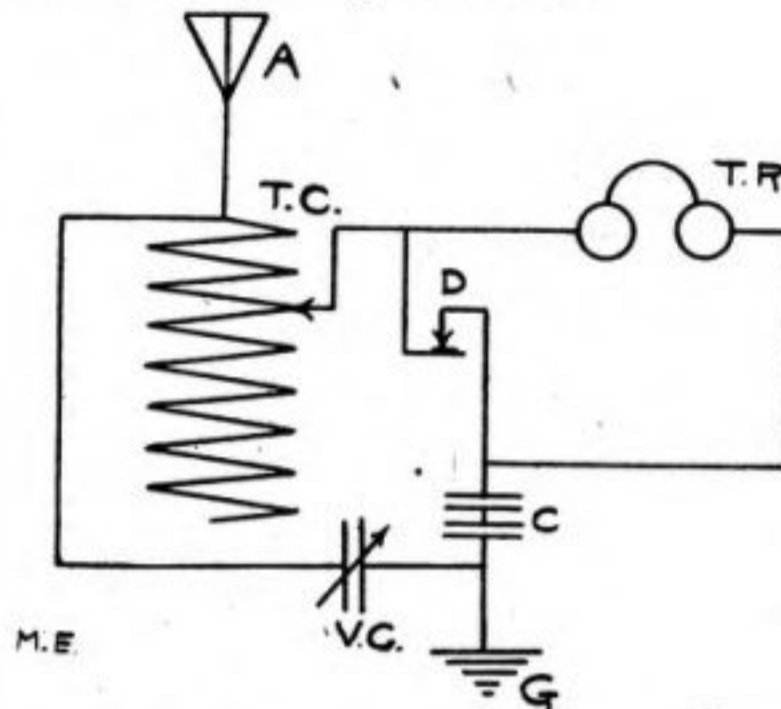

2.—How far can I receive with a 60 foot aerial made up of 4 strands of No. 14 aluminum wire 2 feet apart on a pole 53 feet high, with the above instruments?

A. 2.—300 to 500 miles.

### SENDING DISTANCES.

(406) HARMON DEAL, Missouri, writes:

1.—Will you please tell me how far I could send with aerial 50 feet high with 4 wires 30 feet long and E. I. Co. new 1/2 K. W. transformer coil?

A. 1.—75 to 100 miles.

2.—Is this type of transformer as powerful as the 1/4 K. W. commercial transformer?

A. 1.—Yes.

3.—How far could I send with 50 foot aerial, four 4 quart Leyden jars, the E. I. Co.'s special sending helix, the 1/2 K. W. transformer coil, with 110-125 volt alternating current?

A. 3.—25 to 50 miles, and if you use an electrolytic interrupter, about 75 to 100 miles.

### THREE INCH WIRELESS COIL.

(407) EDWARD RITCHIE, New York, asks:

1.—Kindly give dimensions and amount of wire on secondary of a three inch wireless coil.

A. 1.—About 3 1/4 pounds No. 36 on the secondary 5 3/4 inches x 3 inches diameter.

2.—Would this coil work well on storage batteries having 6 volts and 25 ampere hours?

A. 2.—Yes, fairly well; but you would have to charge the batteries frequently, the capacity being very low.

3.—If the secondary were wound in 8 or 10 sections, would it give good results? If not, how many sections are required?

A. 3.—No.

### CONNECTIONS.

(408.) EVERETT BAISLEY, Michigan, writes:

1.—I would like to have a good diagram and clear instructions for wiring and operating an Electro Importing Co.'s receiving outfit, consisting of 1 electrolytic bare point detector, 1 potentiometer, 1 single slide tuning coil, 1 variable condenser, 1 fixed con-

When writing please mention "Modern Electrics."

denser, 1 1000-ohm receiver. I have a T-shaped aerial 60 feet high and 55 feet long, and the nearest commercial station is 12 miles away.

A. 1.—Diagram given below:

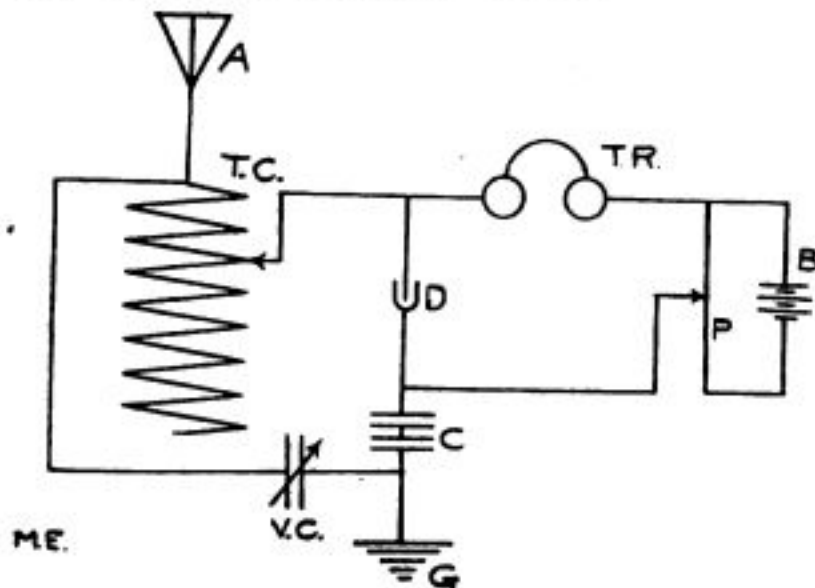

**RECEIVING RADIUS.**

(409.) HARRY ROHRER, Philadelphia, asks: 1.—What will my receiving radius be with the following: Aerial composed of four strands No. 14 aluminum wire, each strand being 18 inches apart and 55 feet long. It is suspended between 2 poles, one 57 feet and other 40 feet high. Instruments, silicon detector, double slide tuner, composed of 275 turns of No. 20 copper wire, 16 inches to each turn, variable condenser, fixed condenser, 2 1000-ohm telephone receivers?

A. 1.—300 to 500 miles.

2.—Please give a diagram for connection of the above instruments, as I have some trouble with buzzing in the receivers from an arc light about 100 feet away from aerial.

A. 2.—Diagram given below:

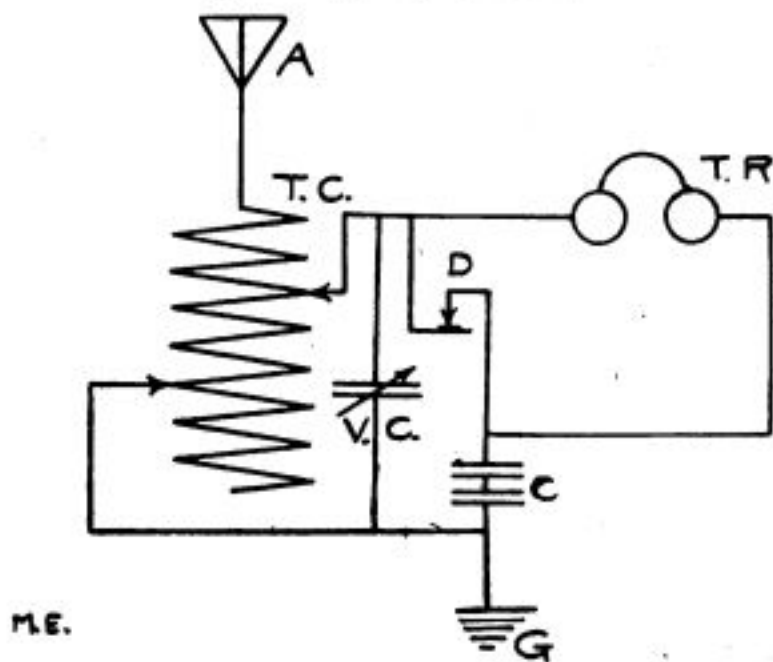

**WIRELESS QUERIES.**

(410.) LUDWIG BEHN, Baltimore, writes: 1.—Will you kindly advise me the sending radius of a wireless set, composed of following instruments: E. I. Co.'s 2½ inch induction coil, Leyden jars, zinc spark gap, sending helix and an aerial 75 feet high, composed of 4 wires and 90 feet long, looped antennae, running into the back yard?

A. 1.—10 to 15 miles.

2.—What will be the receiving radius of this outfit: Double slide tuning coil, variable condenser, fixed condenser, electrolytic detector, potentiometer and 2000-ohm receivers, using the same aerial?

A. 2.—500 to 800 miles.

When writing please mention "Modern Electrics."

**EVERY BOY HIS OWN TOY MAKER... 10c**

- Electric Whistle.....90c
- Miniature Receptacle..... 9c
- Miniature 2 C. P. 4½ Volt Lamp..... 14c
- Fun With Electricity..... 65c
- Battery Current Switches ..... 11c
- Permanent Horse Shoe Magnets, 5 Inch... 25c
- Electric Rheostat Regulator and Switch.. 55c
- Electric Meter.....55c

Above articles postpaid free of charge to your address. Send stamp for catalogues all things Electrical : : :

**Ketteman Electric Co.**  
118 23rd STREET, TOLEDO, O., U. S. A.

When writing please mention "Modern Electrics."

**\$100 Postpaid** **10 Greatest of all Scissors** **\$100 Postpaid**

Eighteen Tools Combined  
And Every Tool  
**PRACTICAL,**  
Keen Edge

- 1. Ruler
- 2. Scissors
- 7. Measure
- 9. Nail File
- 9. Screw Driver
- 2. Buttonhole Scissors
- 3. Gaspipe Tong
- 4. Cigar Cutter
- 5. Wire Cutter
- 12. Hammer
- 13. Penknife
- 14. Glass Cutter
- 15. Glass Breaker
- 16. Marking Wheel
- 11. Cartridge Extractor
- 10. Cigar Box Opener
- 17. Ink Eraser
- 18. Stereoscope

Just the article for Office men, Clerks, Bankers, Traveling Salesmen, or the Housewife. Made of 1st quality of steel—fine workmanship—nicely finished Nickel plated. Put up in elegant leather sheath. Postpaid upon receipt of \$1.00. Can be used in a thousand ways about the home and office.

**Much Handier Than a Knife** **An Excellent Gift**

18 Money refunded if not satisfactory.

**WM. C. HOCKING & CO., 499 Marine Bldg., Chicago**

When writing please mention "Modern Electrics."

**Have You An Idea?**

If so write for our Books: "Why Patents Pay," "What to Invent," "100 Mechanical Movements," and a Treatise on Perpetual Motions—50 Illustrations. All mailed free.

**F. DIETRICH & CO., Patent Lawyers and Experts.**  
60 Ouray block, Washington, D. C.

When writing please mention "Modern Electrics."

# PATENTS

TRADEMARKS AND COPYRIGHTS  
SECURED OR FEE RETURNED

Send model or sketch and description of your invention for free search of the U. S. Patent Office records.

Our **Four Books** mailed Free to any address. Send for these books; the finest publications ever issued for free distribution.

### HOW TO OBTAIN A PATENT

Our illustrated eighty page Guide Book is an invaluable book of reference for inventors and contains 100 mechanical movements illustrated and described.

### FORTUNES IN PATENTS

Tells how to invent for profit and gives history of successful inventions. Also list of Patent buyers.

### WHAT TO INVENT

Contains a valuable list of Inventions Wanted and suggestions concerning profitable fields of inventions. Also information regarding prizes offered for inventions, among which is a

### PRIZE OF ONE MILLION DOLLARS

offered for one invention and \$10 000 for others.

### PATENTS THAT PAY

Contains fac-similes of unsolicited letters from our clients who have built up profitable enterprises founded upon patents procured by us. Also indorsements from prominent inventors, manufacturers, Senators, Congressmen, Governors, etc.

**WE ADVERTISE OUR CLIENT'S INVENTIONS FREE** in a list of Sunday Newspapers with two million circulation and in the *World's Progress*. Sample Copy Free. Electrical Case a Specialty.

## VICTOR J. EVANS & CO.

(Formerly Evans, Wilkens & Co.)

Main Offices, 200 "F" Street, N. W.  
WASHINGTON, D. C.

### The "ELECTRO"-LYTIC BARE POINT DETECTOR (PATENT PENDING)

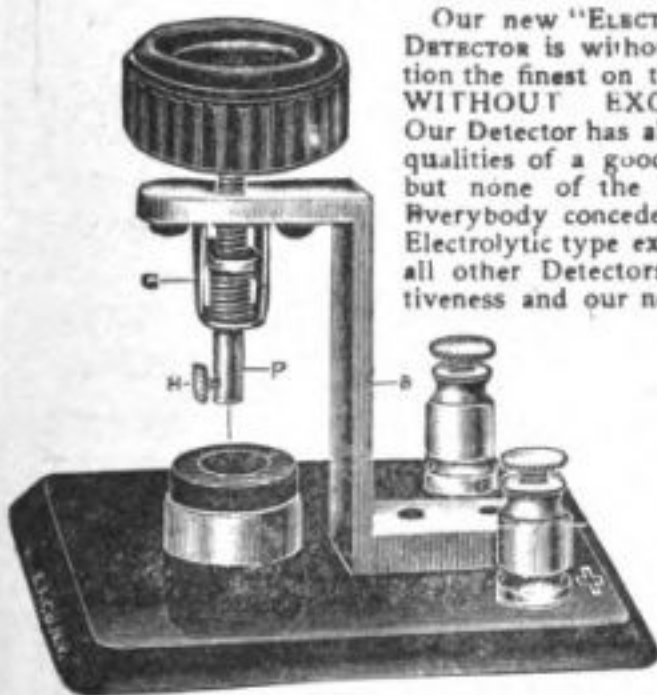

Our new "ELECTRO"-LYTIC DETECTOR is without a question the finest on the market WITHOUT EXCEPTION. Our Detector has all the good qualities of a good Detector but none of the bad ones. Everybody concedes that the Electrolytic type excels by far all other Detectors in sensitiveness and our new type—

already adopted by two of the leading wireless companies—is without doubt the acme of perfection. Please

bear in mind that our new Detector has been designed for *hard commercial work*, it is not an amateur contrivance. Here are a few points: Hard rubber base  $\frac{1}{2}$  in. thick, hard rubber thumb nut 1 in. diameter, graphite-carbon cup moulded in brass cup (under hydraulic pressure,) heavy cast brass standard, etc. The most important part is that the 1-10,000 inch Wollaston wire does not need to be soldered, as in all other Detectors, a screw holds it in a unique manner. The last 1-16 inch piece of wire is utilized, new wires inserted in 10 seconds, etc. By means of an ingenious plunger movement, the fine wire is raised and lowered with greatest precision—less than 1-10,000 inch at a time. The wire cannot turn in a circle, (as wires do, directly attached to thumb screws,) it can only move *up or down*, not sideways, etc. This has been found is of tremendous importance. ALL METAL PARTS ARE HEAVILY SILVER PLATED, as we found that silverplate is not attacked by fumes of the acid. We also furnish bottle to hold acid, and one pipette to fill acid in cup.

Introduction price, \$1.50 By mail extra 12 cents  
Write for new Pamphlet on this Detector.  
Electro Importing Co., 86-ZW. Broadway, New York

### SPARK COIL.

(411.) C. HUNTINGTON, New York, writes:

1.—Kindly let me know through MODERN ELECTRICS what size spark I would get from the following: Core 11 inches long and 1 inch in diameter, 2 layers of No. 18 primary wire, secondary of No. 30, 3 pounds, with insulating tube 7-16 of an inch thick.

A. 1.—We think you would get a great deal better spark if you wound the primary with No. 12 or No. 14 wire. Probably the best spark you will be able to get with the present coil is about 1 inch.

2.—State the transmitting distance of same with 3 pint Leyden jars, Morse telegraph keys, aerial 40 feet high and 25 feet long, your wires 12 inches apart.

A. 2.—8 to 10 miles.

3.—What is the receiving distance of the following: Same aerial, ground connected with gas pipe, tuning coil (single slide), one 75-ohm telephone receiver, detector and 3 dry cells?

A. 3.—75 to 100 miles.

### WAVE LENGTH.

(412.) OSWALD L. GRANICHER, California, writes:

1.—What would the wave length of my tuning coil be, which is wound with 405 feet of No. 24 black enameled wire on a frame 4 inches in diameter?

A. 1.—Approximately 500 meters.

2.—Would it increase the wave length of my station to have 810 feet on above coil?

A. 2.—Most assuredly, provided the fundamental wave length of your aerial is long enough to stand the heavy load of inductance, in the tuning coil.

3.—Would there be any current leakage in my helix, which is wound on wood covered with two coats of shellac?

A. 3.—Probably so, if your transmitting power is over  $\frac{1}{4}$  of a kilowatt.

### WIRELESS QUERIES.

(413.) Brooklyn, N. Y., asks:

1.—Must the ground wire from the instruments be insulated very good, or can it be laid by bell wire, just by staples?

A. 1.—Ground wire does not have to be insulated at all.

2.—Why does the vibrator stick on my 1½ inch spark coil?

A. 2.—Probably your batteries are run down. Try a new set of batteries.

3.—Please give a diagram how to connect the following: 1½ inch spark coil, E. I. Co.'s zinc spark gap, 1 strap key, 7 red seal dry batteries, 1 pint Leyden jar, and give sending radius.

A. 3.—Diagram given below. Probably about 5 miles.

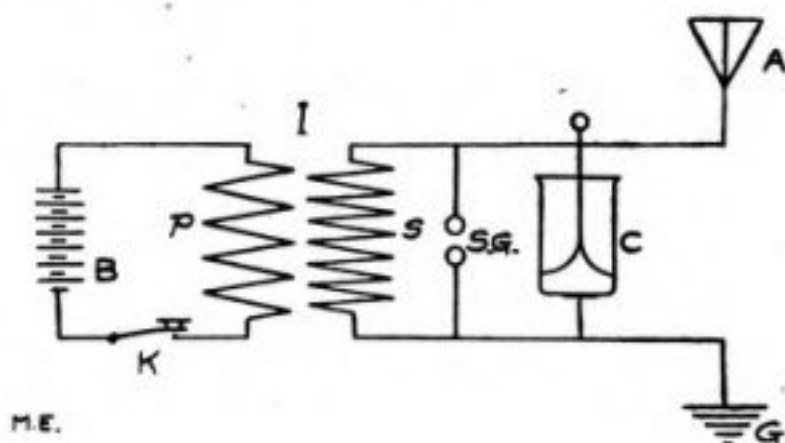

**CHOKE COIL.**

(414.) CLARENCE K. KROGMAN, Brooklyn, N. Y., asks:

1.—Please state the use of a choke coil, and how is it made?

A. 1.—The term choke coil is used to define a small coil wound similarly to an ordinary magnet, and the coil itself is used in certain circuits to prevent a kick-back caused by alternately making and breaking the circuit.

2.—How far will a sounder respond with coherer and decoherer and 1000-ohm polarized relay?

A. 2.—If sensitively adjusted, probably about 25 miles.

3.—How far will a four-inch coil operate with two quart Leyden jars, a 65 foot aerial?

A. 3.—About 30 to 40 miles.

**LOOSE COUPLER.**

(415.) RALPH A. SCOTT, Massachusetts, writes:

1.—Will you please tell me how to connect up the following instruments: Loose coupled tuner, variable condenser, fixed condenser, silicon detector, and two 500-ohm phones? I have tried several wirings with fairly good results, but would like to know the correct wiring of same.

A. 1.—Diagram given below.

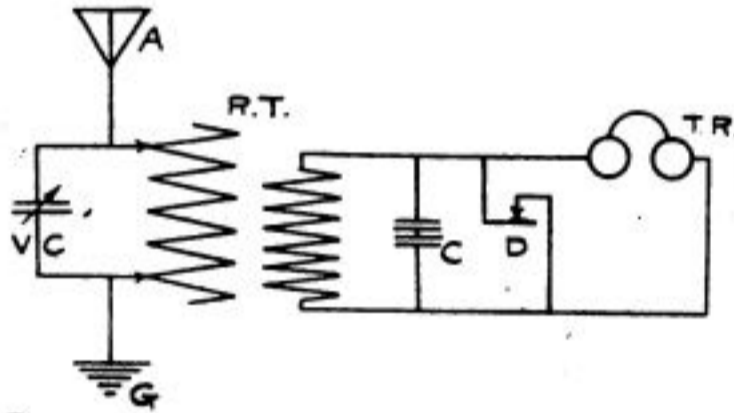

M.E.

2.—Does it cut down the radius of a station to run the ground wire on a horizontal for a short distance?

A. 2.—Not to our knowledge.

3.—Would it be better to have two sliders on the outside coil of a loose coupled tuner?

A. 3.—We consider the two slides give a much closer method of tuning than the single slide.

**WIRELESS QUERIES.**

(416.) ARTHUR C. HARDY, Newton Highlands, Mass., writes:

1.—Kindly tell me in your next issue of MODERN ELECTRICS the best way to connect up telephone receivers, loose coupled tuning coil, silicon detector and variable condenser.

A. 1.—We refer you to query No. 415 in this issue.

2.—How far could I send with a ¼ K. W. transformer?

A. 2.—Probably 50 to 75 miles.

3.—What is the best kind of detector?

A. 3.—We consider the electrolytic to be the most sensitive detector.

**TUNER**

(417.) CARL DRATHSCHMIDT, Yonkers, asks:

1.—Please tell me how much wire (No. 18 copper) I should put on a core (3 inch diameter) to catch messages up to 1,500 meters wave length.



**SOME HEADS  
And What They Earn**

*Statistics show that of 3542 men in various positions, 2803 earn only about \$15.00 a week; 586 earn between that and \$5000 a year; 117 between \$5000 and \$10,000; 36 from \$10,000 to \$15,000. The better qualified the man, the higher the salary.*

To command the *right* salary you *must* have the *right training*. If you lack the right training the International Correspondence Schools of Scranton will impart it to you *in your spare time*. If you have a liking for some special line of work the I. C. S. will make you an *expert* in that particular line. You will not have to leave home while qualifying. The only preliminary schooling required is the *ability to read and write*.

The way to find out all about it is most simple. Just mark and mail the attached coupon. Doing so costs you nothing and entails no obligation.

**The First Step  
to Success**

Marking the coupon will prove to be the first step toward joining the thousands of successful students who at the rate of 300 every month are VOLUNTARILY reporting advancement in salary and position *directly traceable to I. C. S. training*. During September the number was 308.

Mark the coupon NOW with the full knowledge that the Business of This Place is to Raise Salaries—to raise your salary. Finding out costs nothing. Mark the coupon.

**International Correspondence Schools,  
Box 992, SCRANTON, P.A.**

Please explain, without further obligation on my part, how I can qualify for the position before which I have marked X.

Bookkeeper Stenographer Advertisement Writer Show Card Writer Window Trimmer Commercial Law Illustrator Designer & Craftsman Civil Service Chemist Textile Mill Supt. Electrician Elec. Engineer	Mechanical Draftsman Telephone Engineer Elec. Lighting Supt. Meehan. Engineer Plumber & Steam Fitter Stationary Engineer Civil Engineer Building Contractor Architect's Draftsman Architect Structural Engineer Banking Mining Engineer
--	---

Name \_\_\_\_\_

Street and No. \_\_\_\_\_

City \_\_\_\_\_ State \_\_\_\_\_

When writing please mention "Modern Electrics."

**STOP**—Buying inferior instruments  
**LOOK**—At our goods first  
**LISTEN**—With our receivers.

Double slide tuning coils . . . . . \$ 4.00  
 2000 Ohm Receivers complete . . . . . 6.75  
 Loose coupled tuning coils . . . . . 15.00

—All Instruments Guaranteed—  
 SEND FOR CATALOGUE AND CIRCULAR

**FLETCHER-STANLEY COMPANY**

32-34 Frankfort St. :: New York

When writing please mention "Modern Electrics."

**Faucet WATER MOTORS**



Complete with emery wheel, buff wheel, pulley to run sewing and washing machine, polish. In some cities where we have no agents, and where the water pressure is good, a sample motor will be given free; apply at once if you want to make some extra money, or if you can devote your whole time, liberal salary and commission will be paid.

ALCOHOL STOVES, LAMPS AND FLAT IRONS.

ENGINEERS WANTED to send for catalog of indicators, Reducing Wheels, Planimeters. Address,

**LIPPINCOTT M. S. CO.,**  
 52 Columbia St.,

Newark, :: :: New Jersey

When writing please mention "Modern Electrics."

**A New Wireless Transformer**

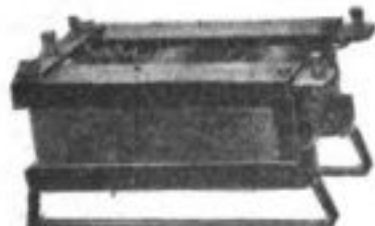

By actual test 5 times more powerful than any equally rated Transformer on the market :::

¼ K.W. with Adjustable Reactance . . . \$26.00  
 ½ K.W. with Adjustable Reactance . . . 45.00

All goods for the wireless experimenter carried in stock. Send 2c stamp for Catalog.

**THE TRANSFORMER SPECIALTY CO.**  
 136 Liberty Street, New York

When writing please mention "Modern Electrics."

Perfect Health Without Medicine  
 Scientific Discovery

**OXYDONOR**

DESTINED TO REVOLUTIONIZE THE ART OF HEALING



Its record of cures is so astonishing as to be almost unbelievable. It has cured the most obstinate ailments and weaknesses. The nature of the disease makes no difference. No matter how severe your affliction, no matter how long standing, no matter how many other treatments you may have tried, you have no right to believe your case hopeless before you have tried OXYDONOR, a self home treatment, without drugs. Most convincing proofs in our descriptive booklet, sent free to all.

**DR. H. SANCHE & CO.**

67 Wabash Ave., Suite 236 Chicago, Ill.

When writing please mention "Modern Electrics."

A. 1.—About 5 pounds.  
 2.—How far can I receive with the following instruments: Silicon detector, fixed condenser, 3,000-ohm receiver, double slide tuning coil, potentiometer, 400 ohm, and a variable condenser such as was described in the November issue of MODERN ELECTRICS? Aerial is 40 feet high, consisting of 3 No. 14 copper wires 15 inches apart, 23 feet long.

A. 2.—400 to 500 miles.

3.—How can I improve this set?

A. 3.—Principally by raising your aerial to 75 or 100 feet.

**RECEIVING AND SENDING RADIUS.**

(418.) W. BLACKMORE, New York City, writes:

1.—What is the farthest possible distance I can receive with the following: Aerial 120 feet high, 60 feet long, 4 wires 15 inches apart, an electrolytic detector, a potentiometer, a variable condenser and a fixed condenser, a 600-meter double-slide tuning coil, 3000-ohm receivers and four dry cells?

A. 1.—800 to 1,000 miles.

2.—How far can I send with the same aerial, ½ K. W. transformer (open core), a Gernsback interrupter, 8 two-quart Leyden jars, special sending helix and a zinc spark gap, a regular wireless key and a very strong current?

A. 2.—Probably 75 to 100 miles.

**WIRELESS QUERIES.**

(419.) RAYMOND COTTLE, Massachusetts, writes:

1.—How far can I hear with the following instruments: Aerials 32 feet high, 84 feet long and 3 strands (single slide), tuning coil, silicon detector, condenser and a pair of 1000-ohm receivers?

A. 1.—100 to 150 miles.

2.—How far can I send with the same aerials, and the following instruments: Induction coil, helix coil, condensers, and 6 batteries?

A. 2.—As you do not state the power of your coil it is impossible for us to estimate your transmitting radius.

**ELECTROLYTIC IN SERIES?**

(420.) W. F. CONBERGER, Philadelphia, Pa., asks:

1.—What should my receiving radius be, with the following apparatus: Double slide tuner, variable condensers, two electrolytic detectors connected in series, 3000-ohm ear phones, aerial formed of 10 wires on 20 foot spreaders, stretched between two smoke stacks 125 feet high and 100 feet apart?

A. 1.—1,000 to 1,500 miles.

2.—Is it best to have the detectors in series or multiple, or only have one detector?

A. 2.—We have tried various combinations of electrolytic detectors, but have finally come to the conclusion that one detector only is as sensitive for all around work as the combination and it is not so much trouble to keep it in adjustment.

3.—Should I be able to hear the 10 K. W. navy station at Pensacola, Fla.?

A. 3.—We should think so.

**AERIAL WIRE.**

(421.) J. W. GROVE, Baltimore, Md., writes:



1.—Would No. 18 bare copper wire make a good aerial?

A. 1.—Not as good as No. 14 or No. 12 wire, as the capacity of No. 18 is hardly large enough.

2.—Give directions for making an electrolytic interrupter for 110 volts alternating current.

A. 2.—We refer you to our advertising columns: We do not advise you to make an interrupter.

3.—In wiring sending and receiving sets, what kind of wire should be used?

A. 3.—Almost any kind of flexible conducting cord will do for wiring the receiving set, but Pirelli cable should be used for wiring the sending set.

#### DISTANCE ON TUNER.

(422.) J. RAYMOND SHARP, Philadelphia, Pa., writes:

1.—Please tell me how far I can receive with the following instruments: Aerial, looped antenna style, 50 feet high, 40 feet long, composed of five wires No. 14 aluminum 14 inches apart. Murdock 3000 meters double slide tuning coil, Electro Importing Company's fixed condenser, silicon detector and 75-ohm receiver.

A. 1.—Probably 150 to 200 miles.

2.—Is there any scale for tuning coils such as mine by which one can tell how far distant stations are that are received from time to time?

A. 2.—No, and we cannot conceive it possible that the distance over which a message is transmitted will ever be determined in such a manner.

#### RECEIVING RADIUS.

(424.) FLOYD TRONBLEY, Troy, Ohio, writes:

1.—Will you kindly answer the following in MODERN ELECTRICS: How far could I send with a 1½ inch spark coil, two quart Leyden jars, zinc spark gap, aerial made with two strands of No. 16 copper wire one foot apart, 50 feet high, and water pipe ground?

A. 1.—5 to 8 miles.

2.—How far could I receive with electrolytic detector, 500-ohm receiver and same aerial and ground as above?

A. 2.—250 to 300 miles.

#### CONDENSER FOR ONE-INCH COIL.

(425.) LEONARD R. CHURCHILL, Massachusetts, writes:

1.—Is it possible to send eight miles with 1 inch induction coil having sending helix, condenser, etc., and aerial, 8 wires No. 14 aluminum, 1 foot apart, 25 feet long, 35 feet high, place to be communicated with in country?

A. 1.—Yes; provided conditions are right and apparatus adjusted properly.

2.—How many sheets, and of what size of tin foil are necessary to make condenser for 1 inch induction coil to be placed on glass plates 5½ inches x 3¾ inches?

A. 2.—About 15 sheets of foil 4 inches x 2½ inches.

## B O O K S

We carry the best book assortment in this country. Our specialty is to publish electrical books—just what you are looking for. Here are a few:  
**Storage Batteries**, by A. E. Watson. Ph. D., E. E. Theory, Construction and Use. Price postpaid, cloth \$1.50.

**How to Make a 1-Kilowatt Dynamo**, by A. E. Watson. Profusely illustrated. Price postpaid \$1.

**The Gas Engine, How to Make and Use It**, by P. B. Warwick, including discussion on gasoline engines. Price, cloth, postpaid 75 cents.

**A B C of Wireless Telegraphy**, by E. Trevert. An excellent book for the amateur. Price postpaid \$1.00.

**New Experimental Electricity**, by E. Trevert. A book every experimenter should possess. Price postpaid \$1.00.

**X-rays for Everybody**, by E. Trevert. Unquestionably the best book printed for the amateur and experimenter. Price postpaid 50 cents.

These are only a few books from our large assortment. Send for free list containing over 70 best electrical books in existence.

M. Bubler Publishing Co., Lynn, Mass.

## S K O O B

When writing please mention "Modern Electrics."

## RUINED BY DRINK!

Saved in Time.

DO YOU DRINK?

I desire to communicate with anyone who realizes that they would be better off if they did not use liquor or with those who are interested in the welfare of a man who drinks. I have a message which has already saved many from the brink of ruin. Nothing dangerous, only an inexpensive Home Treatment, which has been used successfully by physicians and others. No publicity, no inconvenience; no loss of time. Full particulars in sealed envelope upon request. Address E. FORTIN, 40 Dearborn St., Chicago, Illinois. R 84. Correspondence confidential.

When writing please mention "Modern Electrics."

## Be A DOCTOR of Mechano-Therapy

\$3000 to \$5000 A YEAR

WE TEACH YOU BY MAIL



Within a short time you can begin practicing Mechano-Therapy, an elevating and highly paid profession for men and women. More comprehensive than Osteopathy. Endorsed by physicians. A fascinating study, easy to learn, either in class, by mail, or both, and equal to college course—an ordinary education and our course of instruction fits you for a professional life. Authorized Diplomas to graduates. Work absorbingly interesting. Vast opportunities for social and financial betterment. Special terms now. Write today for prospectus—free.

AMERICAN COLLEGE OF MECHANO-THERAPY  
Dept. , 120-122 Randolph St., Chicago

When writing please mention "Modern Electrics."

## GET OUR CATALOG

And see what a fine line of Christmas Novelties we have. Sent on receipt of stamp. Address

Trembly Electric Co.  
Box 505 CENTERVILLE, IOWA



When writing please mention "Modern Electrics."

## "How to Construct a Practical Wireless Telegraph"

With illustrations, diagrams and fine copy of the Codes, 25c. A 2c stamp brings our bulletin of wireless supplies.

CHICAGO WIRELESS SUPPLY CO.  
Room 52e, Auditorium Office Bldg, Chicago, Ill.

When writing please mention "Modern Electrics."

WIRELESS QUERIES.

(426.) CLARENCE HOLT, Massachusetts, asks:

1.—How far can I receive with a double slide tuning coil, fixed condenser, variable condenser, silicon detector, 3000-ohm receivers and an aerial 35 feet high, 28 feet long, 5 wires?

A. 1.—150 to 300 miles.

2.—What distance with the above instruments, an electrolytic detector, potentiometer, a battery and a receiving transformer, a vertical aerial being 75 feet high, 50 feet long and six wires?

A. 2.—500 to 1,000 miles.

3.—How far can I send with an E. I. Co.'s 1½ inch spark coil, E. I. Co.'s spark gap, a home-made condenser and helix, with the 75 foot aerial?

A. 3.—5 to 8 miles.

**\$3,000 TO \$10,000 A YEAR**  
IN THE REAL ESTATE BUSINESS



We teach you by mail every branch of the Real Estate, General Brokerage, and Insurance Business and appoint you **Special Representative** of the largest co-operative real estate and brokerage company. Excellent opportunities open to YOU. By our system you can begin making money in a few weeks without interfering with your present occupation and without any investment of capital. Our co-operative department will give you more choice, salable property to handle than any other institution. A Commercial Law Course FREE. Write for 62-page book free. **THE CROSS COMPANY, 2830 Resper Block, Chicago**

When writing please mention "Modern Electrics."

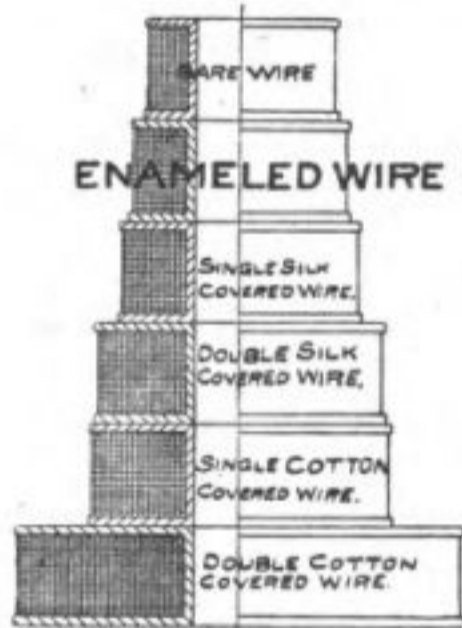

**LOOK**

at the enormous saving in space in favor of **American Enamelled Magnet Wire**

the adopted standard of wireless manufacturers and approved by the United States Government.

All sizes from No. 16 to 40 in stock, and prices right.

**American Electric Fuse Co.**  
New York, N. Y. Muskegon, Mich.  
Ask Your Dealer

When writing please mention "Modern Electrics."



**Come! Quick! Danger!**

Are you prepared for this call—no matter from which department it comes? Just think what it would mean to have constantly at your elbow for consultation an expert on the very problems that puzzle you. That's just what you would have in the

**CYCLOPEDIA OF**

**Applied Electricity**

Six Big Volumes—Bound in Half Morocco—2,896 Pages  
7x10 inches—printed on special paper in large, clear type—2,400 full page plates, diagrams, formulas, etc.

Written by thirty expert Electrical Engineers, the biggest men in the profession. It is a working guide for the student or practical electrician, or a ready reference work for the expert.

**Examine the Books at our Expense**

So confident are we that the books are just what you want, that we will send them to you by prepaid express—you keep the books 5 days examine them carefully, test them, apply them to your every day work. If satisfied that the books are the most complete and comprehensive work ever published on electricity, keep them, send \$2.00 within five days and \$2.00 a month until you have paid \$18.80, the special introductory price—the regular list price is \$36.00. If not suited to your needs, notify us. We will send for them at our expense. **Fill in and mail the coupon today—the books will be sent you at once.**

**IMPORTANT SUBJECTS TREATED**

Electric Wiring—Electric Telegraph—Wireless Telegraphy Teletypograph—Theory, Calculation. Design and Construction of Generators and Motors—Elevators—Direct Current Motors Direct-Driven Machine Shop Tools—Electric Lighting Electric Railways—Single Phase Electric Railway—Management of Dynamos and Motors—Power Stations—Central Station Engineering—Storage Batteries—Power Transmission—Alternating Current Machinery—Telephony—Automatic Telephone—Wireless Telephony—Telegraphone, etc.

For a short time we will include, as a monthly supplement, absolutely free of charge, for one year, the **TECHNICAL WORLD MAGAZINE**. This is a regular \$1.50 monthly, full of Twentieth Century Scientific facts, written in popular form. Also contains the latest discussions on timely topics in invention, discovery, industry, etc.

**FREE OFFER COUPON**

**American School of Correspondence,**  
Chicago, U. S. A.

Please send me Cyclopedic of Applied Electricity for five days free examination. Also T. W. for one year. I will send \$2 within five days and \$2 a month until I have paid \$18.80; or notify you and hold the books subject to your order. Title not to pass until fully paid.

NAME.....  
ADDRESS.....  
EMPLOYER.....

Mod. Elec., 12-09

**CLASSIFIED ADVERTISEMENTS.**

Advertisements in this column 2 cents a word, no display of any kind. Payable in advance, stamps not accepted. Count 7 words per line. Minimum, 2 lines. Heavy face type 4 cents a word. Minimum, 3 lines.

Advertisements under "Wireless" 5 cents a word. Minimum, 4 lines. Wireless books and blueprints not listed under "Wireless," 2 cents a word.

Advertisements for the Jan. issue must be in our hands by Dec. 25.

**ELECTRICAL APPARATUS.**

**STUDY ELECTRICITY AT HOME**—A complete electrical course at home, containing 80-page detail book, 220-page text-book, 200 experiments and over 100 pieces of apparatus. Price, complete, only \$5.60. Catalogue "M. E. S." explains this and other remarkable offers. Thomas M. St. John, 848 Ninth Ave., New York.

**PERFECTION STORAGE BATTERIES** have proved reliable for wireless telegraphy. Wireless apparatus made a specialty of. Perfection Igniter Mfg. Co., 1093 Bedford ave., Brooklyn, N. Y.

**ELECTRICAL BOOKS, BLUEPRINTS, ETC.**

**WIRELESS CODES.** Send 10c. for blue print showing Morse, Continental and Navy Codes. A. C. Austin, Jr., Hasbrouck Heights, N. J.

**FOR SALE.**—Practically new set Cyclopaedia of Applied Electricity in five volumes, well bound in half morocco leather. Treats of dynamos, motors, storage batteries, current measurements, wiring, telegraph, telephony, exchange, lighting, railways, power stations, alternating current, power transmission, etc. Cost \$19.00—will sell for \$8.00. Address, Henry Ward, 124 East 52nd street, Chicago, Ill.

**TECHNICAL INFORMATION** answered promptly, 25c. Wave-length figured mathematically, 35c. Aerial don't count. Drop a postal of inquiry. "C," 65 Cole street, Bristol, R. I.

**FLYING MACHINE, DEMON,** 25 c.; Aeroplane, self-propeller, 75c.; fine French Monoplane, exact model famous aviator, own power, \$1.25. Write us. Box 133, Station A, San Antonio, Tex.

**METALIZE FLOWERS,** insects, etc., for jewelry. Latest novelty; everybody buys; sample 10c. Two formulas and full instructions 50c. A. Benson, Stewartville, Minn.

**DRY BATTERIES CAN BE RENEWED** for three cents each by anyone. Price of formula \$1 (worth \$5). We have arranged with owners to send full instructions to any reader of this paper for 25 cents. Address at once, Fairmount Telephone Co., Leighton's Corners, N. H.

**AMATEURS,** make your own switchboards. Excellent imitation marble. Cheaply constructed. Full instructions 25c. A. Benson, Stewartville, Minn.

**WIRELESS**

**ARE YOU BUILDING A COIL?** We have just imported a stock of **THE BEST NORWEGIAN CORE WIRE, No. 22, FINELY ANNEALED.** The wire is cut in straight lengths from 6 in. to 24 in. **NOT IN COILS.** Price per pound 20 cents. **ORDER AT ONCE AS SUPPLY IS LIMITED.** **ELECTRO IMPORTING CO., 862 West Broadway, N. Y.**

**YOU BET**

we have all up to date wireless supplies. We carry more wireless goods for the amateur than any other house on the Coast. Why pay express and freight, when you can get the goods right here at right prices? Detectors, Tuners, Condensers, Spark Coils from 1-2 to 4 inch spark, oscillators, coherers, lamps, static machines, in fact, anything electrical you want. Call or write. It will pay you. **PAUL SEILER ELECTRIC WORKS, Market St. San Francisco, Cal.**

**1000 OHM RECEIVERS \$1.75.** Very sensitive and reliable. Complete long distance receiving sets with pair receivers resistance of receivers 2000 ohms, \$12.25. Double slide tuning coils, \$3.50. Fixed receiving condensers, 30c. Send stamp for circulars, Alden Wireless Co., Campello, Mass.

**SPECIAL!** Enameled Resistance Wire; 800 ohms, 25 cents. Enameled copper, 300 feet number 28 or 125 feet number 24, 25 cents. Number 40, 50 cents per 1,000 ohms. Cardboard tubes, 5 inch, 25 cents foot; 4 and 3 1-2, 15 cents foot. Middlesex Wireless Supply Company, 94 Antrim street, Cambridge, Mass.

"C. Q. 'D.'"—Wireless Troubles demonstrated magnetically. A puzzle—toy—a box of fascinating, mysterious fun—an "attractive" lesson in magnetism. An excellent Christmas box for old or young. Postpaid, 25c. silver. T. P. Adams Co., 626—M, So. 48th ave., Chicago, Ill.

**SPECIAL PRICES.**—1,000-ohm wireless receiver, double pole, solid hard rubber case, wound with copper wire, \$1.75. The only wireless key enabling receiving operator to interrupt transmitting operator at any part of message; will not burn out detector or phones, \$2.75. "National" receiving condenser, 30c. Waterhouse Bros., Bourne, Mass.

**WIRELESS APPARATUS** at reduced prices during Christmas holidays. If you live in Brooklyn, come and see us. We have everything new for the amateurs. Perfection Igniter Mfg. Co., 1093 Bedford ave., Brooklyn, N. Y.

**DOLLAR TUNING COIL.** 50c. detector. Free literature. Burt Mfg. Co., Wollaston, Mass.

**BOYS!**—"How to Make a Wireless Telegraph," 15c. coin. Written for a boy. Address, Arthur Klem, Dept. A, 24 Crown street, New Haven, Conn.

**MICA PLATES.**—For the condenser described in the November issue of this magazine, cut out of clear, imported mica, which we guarantee, and measuring 1 inch by 4 inches, will be sent prepaid, with four large pieces of graded mica and one piece of amber mica, for a two dollar bill. This is a bargain, as the same material would cost you \$5 at any supply store. This offer is for a short time only, so act quick. No stamps, please. Orlo A. Roote, Jr., Caxton Building, Cleveland, Ohio.

**WIRELESS BARGAINS.** Zincite and Copper Pyrites, 50c per set. Brass Cups silver plated for mounting crystals with solder, 10c each. **No. 36 S. S. C. IRON wire for Marconi Magnetic Detector, 50c per ounce. No. 50 (11-2 mil.) S. S. covered copper wire for high resistance phones. 60c for spool containing exactly 1000 ohms. Wollaston wire, .0005, 15c. .0001, 25c; silicon fused, large piece 15c. Molybdenite, more sensitive than silicon 10c large piece. Graphite carbon cup for electrolytic detector, 20c. Selenium metal in sticks for selenium cells, large piece, 25c. Stamp for 128 page catalog. Electro Importing Co. 86-Z West Broadway, N. Y. City.**

**FOR SALE.**

**FOR SALE.**—Eight-inch coil, excellent for wireless telegraphy. Open core. May be used with an independent vibrator or electrolytic interrupter. Also good for X-ray work. Built in six sections, mahogany case. Will sell for \$35.00. Offer considered. A. C. Brady, c/o Perfection Igniter Mfg. Co., 1093 Bedford ave., Brooklyn, N. Y.

**FOR SALE.**—Handsome Colledge Static Machine, for cash or microscope. Clarence A. Smith, Box 206, Vernon, Tex.

**FOR SALE.**—Second hand, auto spark coils, fan motors, storage batteries, 4 lbs. S. S. C. wire, in sections. Write A. C. Gowing, 15 Dean street, Worcester, Mass.

**FOR SALE.**—Quarter-inch coil in good condition, \$4. John Maier, Jr., 5396 Congress street, Chicago, Ill.

**FOR EXCHANGE,** Dynamo, 650 watts, direct current, with pulley, in best condition, worth \$50.00, for large induction coil, wireless outfit, other electrical apparatus, or \$25.00. Vick Azbe, St. Mary's Hospital, Jefferson City, Mo.

## FOUR KINDS OF SERVICE

The charge ranging from one cent to one-quarter of a cent a word to the general public makes communication by telegraph an economic convenience for every one. You can send

- 25-word TELEGRAMS, any distance for 25c.**
- 50-word TELEPOSTS, any distance for 25c.**
- 100-word TELETAPES, any distance for 25c.**
- 10-word TELECARDS, any distance for 10c.**

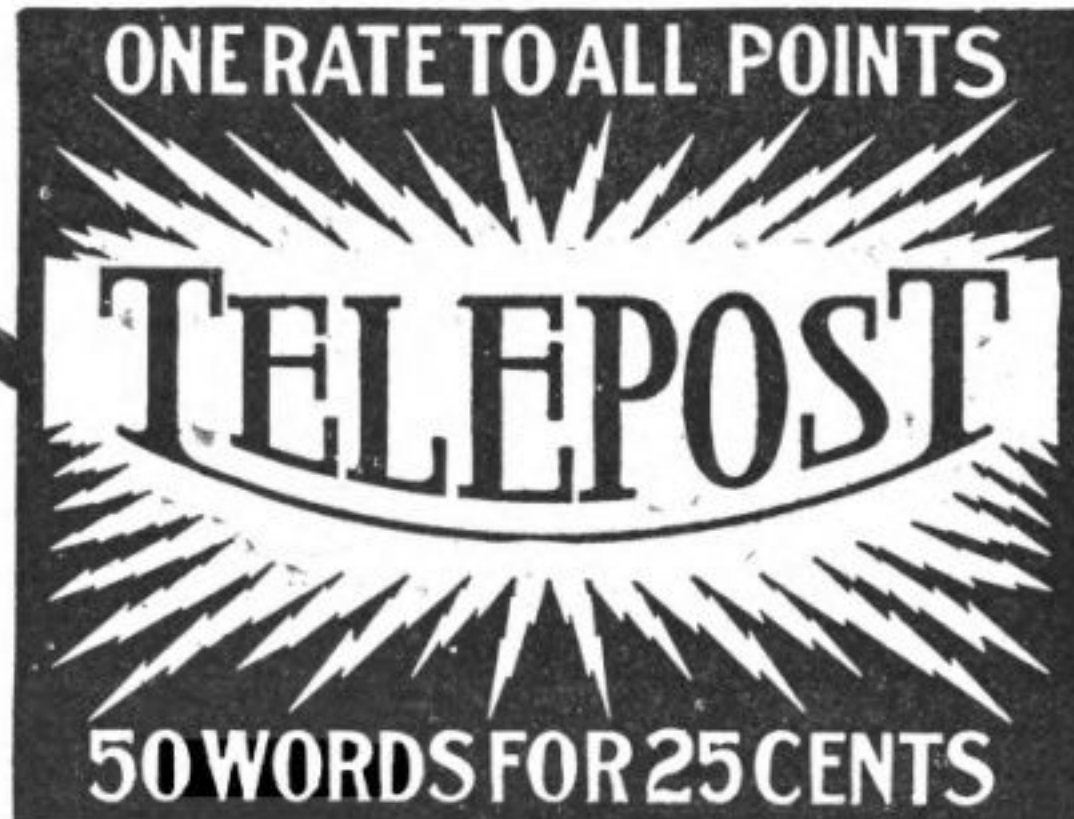

**A** THOUSAND WORDS PER MINUTE over a single wire, when the older Telegraph Companies average only fifteen words per minute, makes possible the above-named rates and other startling innovations in telegraph service that are sure to interest every progressive American.

¶ After some months successful operation commercially in the East the Telepost first Western section has been opened up. Offices are now open for business between St. Louis and Sedalia, Mo., St. Louis to Springfield, and Aurora, Ill. St. Louis to Terre Haute, and Indianapolis, Ind., and messages are transmitted at above rates.

¶ Line construction is being pushed in many widely separated sections, and additional cities are to be connected in rapid succession until every city in the United States is given the Telepost's quick and accurate service, at rates so low that all can afford to carry on their more important correspondence by wire.

¶ You ought to know all about it.

¶ An interesting illustrated booklet has been prepared, describing in detail the invention, its operation, its economy, its rapidity and its accuracy. Mailed without cost to any one asking for Booklet No. 359.

## Sterling Debenture Corporation

Brunswick Building, Madison Sq.

New York City

When writing please mention "Modern Electrics."

## Battery Bargain

No Extra  
Charge for  
Fahnestock  
Connections



**13½**  
Each  
In dozen  
lots



### GLOBE DRY CELL

Specially adapted to  
experimental work.  
Also used by contrac-  
tors because it is a good  
battery at low cost.

Splendid for bells, buzzers, etc.

**National Carbon Company**  
CLEVELAND, O.

When writing please mention "Modern Electrics."

## THIS IS THE WONDERFUL RED STYLO INK PENCIL

To in-  
troduce  
this mar-  
velous ink  
pencil to  
readers of  
MODERN  
ELECTRICS  
we will send  
One sample pre-  
paid for \$1.00.  
Regular price  
strictly \$2.00.  
Dealers and Agents  
write for interesting  
proposition.

We also make electric  
flash lights, batteries,  
the famous Universal  
dry cells, electric scarf  
pins, Alladin electric gas  
lighters, electric magic  
lanterns; also the marvel-  
ous DRY alcohol (in chunks)  
Universal flaming cigar light-  
er, sample sent by mail for  
50c., etc. CATALOGUE FREE.

**Universal Novelty Co.**

165 W. 29th St., New York, N. Y.

Impossible to leak, even if car-  
ried upside down. Writes like a  
pencil. Has a platinum-  
radio feed wire and we  
therefore guarantee each  
and every pencil. Order  
one now.

**Over 2 Million of  
these Pencils now  
in use.**

All editorials and  
text matter of MOD-  
ERN ELECTRICS  
are written with

**Red Stylo  
Ink  
Pencils**



When writing please mention "Modern Electrics."

## 1,000 Wireless Operators Wanted

**A**LL over the country today the big  
wireless telegraph and telephone  
corporations are endeavoring to get  
reliable, trustworthy operators.

The demand is greater than the  
supply—good men are scarce. It's the  
golden opportunity for the young man of  
brains and ability.

### A COMPLETE COURSE FOR WIRELESS STUDENTS

The American Wireless Institute, which  
is the most complete school of its kind in  
the United States, is now preparing hun-  
dreds of young men and women to fill  
positions of trust as wireless operators.

We teach by the only satisfactory  
method—practical working experience. Our  
study rooms are filled with complete wireless  
instruments—students get the actual experi-  
ence of sending and receiving messages.

We educate our students in Wireless  
construction in all its branches—teach them  
the proper care and use of all instruments  
in Wireless work.

### WIRELESS OPERATORS GET BIG SALARIES

The pay for Wireless operators and  
engineers ranges from \$60 to \$175 per month,  
according to ability.

But this is not all—think of the vast  
opportunities offered in the Wireless field,  
for the young man who is industrious and  
reliable.

Big corporations, with millions of  
capital, are entering this field and there is  
absolutely no limit to the advancement  
offered to the man with push and ability.

Every young man who is mechanically  
inclined should have our catalog—it gives  
complete details of our course—shows you  
plainly how we teach you to become a  
Wireless operator.

### POSITIONS WAITING FOR OUR STUDENTS

We are continually receiving at our  
office requests from every part of the  
country for trained men, and it is an easy  
matter for us to find good positions for our  
students as fast as they fit themselves for  
practical work.

Don't let this chance slip by. Sit down  
right now and write for our prospectus.  
We will send complete details by return mail.

## AMERICAN WIRELESS INSTITUTE

71 University Bldg., Detroit, Mich.

When writing please mention "Modern Electrics."

# The Greatest Opportunity For Christmas

We Save You As Much As 40 Per Cent. On Your Subscriptions

MODERN ELECTRICS.....	\$1.00	OUR PRICE <b>\$3.00</b>
COSMOPOLITAN, (or American, or Good Housekeeping)	1.50	
REVIEW OF REVIEWS.....	3.00	
Regular Price -		\$5.50

Modern Electrics.....	\$1.00	Our Price <b>\$4.05</b>
World's Work.....	3.00	
Everybody's.....	1.50	
Delineator.....	1.00	
Regular Price -		\$6.50

Modern Electrics.....	\$1.00	Our Price <b>\$5.40</b>
Pearson's.....	1.50	
Leslie's Weekly.....	5.00	
Regular Price -		\$7.50

Modern Electrics.....	\$1.00	Our Price <b>\$4.25</b>
Good Housekeeping.....	1.00	
The Outlook.....	3.00	
Regular Price -		\$5.00

Modern Electrics.....	\$1.00	Our Price <b>\$4.20</b>
Review of Reviews .....	3.00	
McClure's Magazine.....	1.50	
Woman's Home Companion.....	1.50	
Regular Price -		\$7.00

Modern Electrics.....	\$1.00	Our Price <b>\$2.15</b>
Pictorial Review.....	1.00	
Cosmopolitan, (or American or Good Housekeeping).....	1.50	
Regular Price -		

Modern Electrics.....	\$1.00	Our Price <b>\$2.40</b>
The World Today.....	1.50	
Pearson's.....	1.50	
Regular Price -		\$4.00

## MODERN ELECTRICS IN CONNECTION

	REGULAR PRICE	OUR PRICE		REGULAR PRICE	OUR PRICE
With Ainslee's.....	\$2.80	<b>\$1.80</b>	With Motor Boat.....	3.00	<b>\$2.30</b>
" American Boy.....	2.00	<b>1.45</b>	" The Musician.....	2.50	<b>1.80</b>
" The Book-keeper.....	2.00	<b>1.45</b>	" North American Review.....	5.00	<b>4.30</b>
" Cosmopolitan.....	2.50	<b>1.50</b>	" The Outlook.....	4.00	<b>3.50</b>
" Cycle & Aut'bile Trade Journal	3.00	<b>1.80</b>	" Pacific... ..	2.50	<b>1.80</b>
" Farm Journal.....	2.00	<b>1.45</b>	" Pearson's.....	2.50	<b>1.50</b>
" Fruit Grower.....	2.00	<b>1.35</b>	" Pictorial Review.....	2.00	<b>1.50</b>
" Good Housekeeping.....	2.00	<b>1.50</b>	" Popular Magazine.....	4.00	<b>3.00</b>
" Gunter's Magazine.....	2.50	<b>2.00</b>	" Recreation.....	4.00	<b>3.00</b>
" Harper's Magazine or Weekly.	5.00	<b>4.30</b>	" Review of Reviews.....	4.00	<b>2.30</b>
" " Bazar.....	2.00	<b>1.50</b>	" Scientific American.....	4.00	<b>3.30</b>
" Judge's Weekly.....	6.00	<b>5.00</b>	" Telephony .....	4.00	<b>2.30</b>
" The Ladies World.....	1.50	<b>1.10</b>	" Suburban Life.....	4.00	<b>3.05</b>
" Leslie's Weekly.....	6.00	<b>5.00</b>	" Success.....	2.00	<b>1.50</b>
" Lippincott's.....	3.50	<b>2.50</b>	" Sunset.....	2.50	<b>1.80</b>
" McClure's Magazine.....	2.50	<b>1.80</b>	" Travel.....	2.50	<b>1.80</b>
" Metropolitan.....	2.50	<b>1.75</b>	" Women's Home Companion...	2.25	<b>1.70</b>
" Modern Priscilla.....	1.75	<b>1.30</b>	" The World Today.....	2.00	<b>1.40</b>

Canadian and Foreign Postage to be added to above prices.  
We will gladly quote on any Magazine combination not listed above.  
Prompt and careful service assured.  
It is impossible to get the Magazines quoted in our list cheaper elsewhere.

MAIL ALL ORDERS TO

### Modern Electrics Publication

84 WEST BROADWAY • :- NEW YORK

When writing, please mention "Modern Electrics."

## Neat and Efficient Reversing Switches

No. ME40 K. & D. Starting, stopping, pole-changing or reversing switch. Suitable for use in any position where the current to be carried does not exceed 15 amperes.

The base is of hard fibre; the exposed metal parts are nicked. Made to standard gauges—parts interchangeable. Cut shows switch about  $\frac{3}{4}$  actual size.



**PRICE 75 CENTS**



No. ME41. This switch has the same working parts as No. ME40, but has no cover. It has a polished wood base. Cut about  $\frac{3}{4}$  size.

**PRICE 60 CENTS**

MANUFACTURED BY

**KENDRICK & DAVIS**

Lebanon - New Hampshire

GET THE K. & D. BOOK OF ELECTRICAL GOODS No. 9

When writing please mention "Modern Electrics."

## De Forest Apparatus

DESIGNED BY EXPERTS

WIRELESS TELEGRAPH AND TELEPHONE

RECEIVING OR TRANSMITTING

HIGH CLASS APPARATUS OF ALL SORTS AT REASONABLE PRICES

Variometers, Loose Couplings, Variable Condensers of all sizes, Helices and Spark Gaps, large and small, Heavy Transmitting Keyes, Audion and Radion Detectors, Wavemeters, Telephone Receivers of extreme sensitiveness, Complete Commercial Tuners, etc., etc.

**R. J. VARIOMETER**—A variable Tuning Coil without sliding contacts, or a loose Coupling using rotating coils.....\$16.00 Net

**R. J. WAVEMETER**—A calibrated Receiving Set that will measure the wave length you are using or of any station you can hear. Its variable condenser can be used separately.....\$20.00 "

**R. J. HELIX & SPARK GAP**—Equal to that used in most ship stations,\$15.00 "

**R. J. LOOSE COUPLING**—Rotating coil type to eliminate most extreme interference.....\$17.50 "

**HEAD TELEPHONE RECEIVERS**—De Forest type. Most sensitive known, light, fit the ears.....\$16.00 "

Technical advice and assistance gladly given to all purchasers. Call and see our apparatus at our new offices in the Metropolitan Tower. What we sell is GOOD.

If you wish a REAL Wireless Station go to those who KNOW HOW! Address

SALES DEPT.

**RADIO TELEPHONE CO.** 1 MADISON AVE. NEW YORK CITY

When writing please mention "Modern Electrics."

# Sensible Christmas Gifts for MEN

## "YANKEE" TOOLS

Pocket Screw Driver—No. 60

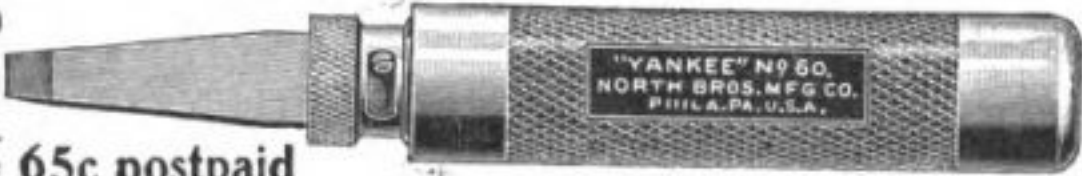

65c postpaid

Steel—Nickel-plated and polished—very attractive. Four blades, carried in handle—Fits the hand—Fits the pocket—Fits the screws—Fits the purse.

An Acceptable Little Gift—Fit for any Man

"YANKEE" TOOLS make sensible and very acceptable gifts for all men who ever have occasion to use tools of any kind. They last for years and the giver is remembered whenever they are used. Send for book of new ideas in time-and-labor-saving tools, full of interesting suggestions for Christmas.

A postal brings it if you mention "Modern Electrics."

Ask your dealer for "YANKEE" TOOLS

**NORTH BROS. MFG. CO., Dept. M., PHILADELPHIA, PA.**

## ROYAL STORAGE BATTERY

STYLE B-3 6 Volts, 60 Ampere Hours



Size 6½x7½x7 in. Weight 27 lbs Used on board of several U. S. Battleships. Same type used in the Oldsmobile, Pullman and a number of other high-class automobiles for ignition and lighting. Six plates in each cell, 8 positives and 8 negatives. 18 plates in one battery.

Through a fortunate deal with the makers, we have purchased several hundred of these batteries, all in perfect condition except that they are of the 1908 style. As the makers have brought out

a new 1909 type they did not wish to keep the 1908 type in stock and we bought the whole block. If you wish to know more about this wonderful ROYAL BATTERY, send 2c stamp and we will send you a 20 page book entitled: "Treatise on Storage Batteries." The type B-3, exactly as cut, only wider and bigger, lists at 27 Dollars (see book.)

Our PRICE NOW, to M. E. Readers **ONLY \$8.00.**

This is a chance of a lifetime. We can ship at once; Treated wood case. Fine rubber-belted handle, patent gas vent, etc. Speak quick, only about 25 left.

**ELECTRO IMPORTING CO., 86z W. Broadway, N.Y.**

When writing please mention "Modern Electrics."

## \$54.00 PER DAY

The record of the **CAMERA-SCOPE**



And we can prove it. Anyone can operate it, Makes 6 finished button photographs a minute. Price of Camera-Scope, with supplies for making 300 pictures (enough to pay for the complete outfit) **\$25.00.** Extra buttons \$1. per hundred; extra frames, \$1.50 per gross. Be independent and make money for yourself. Write today.

**W. S. MOUNTFORD,**  
100A MAIDEN LANE, NEW YORK, N. Y.

When writing please mention "Modern Electrics."

## The Schoen Printing Co.

Magazines  
**Printers** Catalogues  
Stationery, etc.

13 Vandewater Street, - NEW YORK

When writing please mention "Modern Electrics."

## Learn Telegraphy

At My Practical School



Only school graduating full-fledged operators. Established 1874. Housed in its own large, modern building. Equipped with R.R. train wire. **Endorsed by Railroad and Western Union officials.** Exclusive methods. Teachers are practical experts. Living expenses earned. Easy payments. Positions always open—I will help you. Correspondence course if desired, Morse or Wireless. Catalog **Free** GEO. H. DODGE, Pres., Dodge's Institute, 6th St., Valparaiso, Ind.

When writing please mention "Modern Electrics."

PRICE  
\$1.50  
AND UP

# STAR SAFETY RAZOR



Reputation from accomplished facts and not promises has carried the Star Safety Razor through thirty successful years. The expense of large advertising space prohibits going into detail in regard to the Star Safety Razor. You get value in this article and are not paying for the advertisement. Men who have used this Razor for many years, and who have also tried numerous thin blade Safety Razors, state that **THERE IS BUT ONE SAFETY RAZOR** that gives entire satisfaction—and THAT IS THE "STAR."

Catalogue sent upon request.

**KAMPFE BROTHERS, 28 Reade St., New York.**





## Murdock Wireless Apparatus

### OPERATOR'S HEAD RECEIVERS

We are the only manufacturers of Wireless Receivers that make a specialty of Receivers for all requirements and conditions. Our Receivers can be furnished in the following resistances:

**Double Receivers, in Series, with Head Band, Cord and Block**

STYLE AM.		STYLE PRO.	
200-Ohms....	<b>\$4.50</b>	200-Ohms ....	<b>\$7.00</b>
1,000 " ....	<b>5.50</b>	1,000 " ....	<b>9.00</b>
1,500 " ....	<b>6.50</b>	1,500 " ....	<b>10.00</b>
2,000 " ....	<b>7.50</b>	2,000 " ....	<b>11.00</b>
3,000 " ....	<b>8.50</b>	3,000-Ohm s..	<b>\$12.00</b>
		4,000 " ...	<b>13.00</b>
		5,000 " ...	<b>14.00</b>
		6,000 " ...	<b>15.00</b>

**THEY ARE THE BEST!**

Get our November list of "Quality" Wireless Apparatus. *Everything you need.*

**WM. J. MURDOCK & CO.,**  
**40 CARTER STREET - - - - - CHELSEA, MASS.**  
Chicago: 324 Dearborn St. San Francisco: 824 Folsom St.

When writing please mention "Modern Electrics."

## Have Your Printing Done in New York

BECAUSE it will COST LESS, express and all.

BECAUSE it will LOOK BETTER.

BECAUSE it will BE BETTER:

Have Your  
Printing Done by

# GEO. I. WILSON & SON

BECAUSE they are New York's best printers.

BECAUSE they command the services of New York's best practical advertising writers.

BECAUSE they employ skillful and imaginative art sts.

BECAUSE they are constantly in touch with all the latest ideas.

BECAUSE they have the most up-to-date assortment of type.

BECAUSE they have the latest and best power presses and labor and time saving machinery.

BECAUSE they have their own bindery.

BECAUSE they are experts at art work.

BECAUSE they know how to print from half-tones, an art whose existence is never suspected by the average "printer."

BECAUSE they buy supplies in such large quantities that they can deliver a job for less than others would pay for the paper.

BECAUSE they handle their business along business lines, discounting their bills and receiving cash for their work.

BECAUSE they can turn out the average job in less than forty-eight hours, and actually do print a major part of their work in twenty-four hours, a feat of which few other large printers in the country can truthfully boast.

*Just drop us a line, mentioning Modern Electrics.*

GEO. I. WILSON & SON, -:- 35 JOHN ST., NEW YORK

When writing please mention "Modern Electrics."

## TEN THOUSAND TELEGRAPHERS WANTED

by railroads, commercial companies and Wireless Companies. Only schools in America teaching

### WIRELESS TELEGRAPHY

We operate fifteen Wireless Stations. Main Line R. R. Wires in each of our Institutes  
Supervised by R. R. Officials. Write for prospectus.

#### NATIONAL TELEGRAPH INSTITUTE

CINCINNATI, OHIO PHILADELPHIA, PA. MEMPHIS, TENN. DAVENPORT, IOWA PORTLAND, ORE. COLUMBIA, S. C.

When writing please mention "Modern Electrics."

# METAL STAMPING

E. KONIGSLOW STAMPING & TOOL WORKS. CLEVELAND, O.

DIE MAKERS. HARDWARE SPECIALTIES.

# IVER JOHNSON

## SAFETY AUTOMATIC REVOLVER



We point to the difference between the positively and absolutely safe Iver Johnson Safety Automatic Revolver and the imitation near-safeties. They have some device added to them to make them near-safe. The safety feature of the Iver Johnson Safety is the firing mechanism itself—not some spring or button device to pull or press. That is why you can, in perfect safety—not near-safety—kick it, cuff it, knock it, or

### HAMMER THE HAMMER

"SHOTS," our booklet, tells all about it in a plain, simple way, so you can't go astray on the SAFE revolver question. Send for it—FREE.

#### Iver Johnson Safety Hammer Revolver

Richly nickeled, 22 calibre rim-fire or 32 calibre center-fire, 3-inch barrel, or 38 calibre center-fire, 3¼-inch barrel, - - - **\$6** (Extra length barrel or blued finish at slight extra cost)

#### Iver Johnson Safety Hammerless Revolver

Richly nickeled, 32 calibre center-fire, 3-inch barrel, or 38 calibre center-fire, 3¼-inch barrel, - - - - - **\$7** (Extra length barrel or blued finish at slight extra cost)

Sold by Hardware and Sporting Goods dealers everywhere, or sent prepaid on receipt of price if dealer will not supply. Look for the owl's head on grip and our name on barrel.

**IVER JOHNSON'S ARMS & CYCLE WORKS, 323 River Street, Fitchburg, Mass.**

New York: 99 Chambers Street. San Francisco: Phil. B. Bekeart Co., 717 Market St.  
Hamburg, Germany: Pickhuben 4. London, England: 13 Cullum Street, E. C.

Iver Johnson Single Barrel Shotguns and Truss Bridge Bicycles



When writing please mention "Modern Electrics."

## The First Annual Official Wireless Blue Book

The only book of this kind in existence. It contains the location, call letters, wave length, power, etc., of

### 972 Wireless Stations in the United States and Canada

U. S. Atlantic and Inland Stations	90
" Pacific Shore Stations	60
" Navy Stations	51
" Army Stations	50
" Revenue Cutters Stations	22
" Navy Vessels Stations	185
Hawaii Stations	7
Merchant Vessels in the Atlantic, Pacific & Great Lakes	350
Canadian Stations	39
Cuban Stations	3
U. S. Amateur Stations	115
<b>Total</b>	<b>972</b>

If you have a wireless station this book will be invaluable to you. When receiving messages you will know at once where from they originate. NO MORE GUESSWORK as heretofore. The Wireless Blue Book creates a new interest in wireless as it enables every experimenter to accurately estimate the range of his outfit.

It took four months to compile the data of the Blue book and it is warranted to be correct in every respect. **YOU CANNOT AFFORD TO BE WITHOUT IT.**

 **PRICE, 10c BY MAIL.** Cash or stamps (only U. S., no foreign ones) taken

**Modern Electrics Publication,**

**84 W. Broadway, New York**

When writing please mention "Modern Electrics."

➔ **PROTECT YOUR IDEA!**

# Patents THAT Pay

**"MY TRADE-MARK"**

*"Your business will have my personal attention.—"E. E. V."*

## SPECIAL OFFER

Send me sketches or drawing or model and description of your idea or invention for FREE examination of U. S. PATENT OFFICE Records and report as to patentability of the same;—to find out as to whether you are entitled to a patent will not cost anything;—then, if your invention is new, upon receiving instructions. I will prepare, ALL necessary (application) papers. **DO THIS AND SAVE TIME AND MONEY.**

**WRITE NOW**

**FREE TWO BOOKS:**  
61-Page  
"Inventor's Guide"  
AND  
80-Page  
"Proof of Fortunes in Patents—  
What and How to Invent."

**FREE**  
The above - entitled books will tell you How to Secure Money to "Patent" Your Invention, How to Sell Your Patent, and ALL about the **GREAT SUCCESS OF MY CLIENTS**

Trade-Marks, Copyrights, Prints, Labels, Registered.

**ADVICE FREE.**

Correspondence Solicited.

## REFERENCES :

- American National Bank, Washington, D. C.
- Little Giant Hay Press Co., Dallas, Texas.
- Gray Lithograph Co., New York City, N. Y.
- Farmers Mfg. Co., Norfolk, Va.
- New Era M'fg Co., Fairfield, Ia.
- The Parry Stationery Co., Oklahoma City, Okla.
- Bell Show Print Co., Sigourney, Ia.
- The Camp Conduit Co., Cleveland, O.
- The Iowa Mfg. Co., Oskaloosa, Ia.
- Sam'l Allen & Son Mfg. Co., Dansville, N. Y.
- The Garl Electric Co., Akron, O.
- Superior Mfg. Co., Sidney, O.
- Tidnam Tel. Pole Co., Oklahoma City, Okla.
- Bernhard Furst, Vienna, I. Austria-Hungary.
- Compound Motor Co., Brooklyn, N. Y.

I advertise my clients' patents free in a magazine having a two million circulation.

**MY FEE RETURNED IF "PATENT" IS NOT ALLOWED**

(SEE ABOVE LIST OF REFERENCES—THEY TALK!)

**HIGH CLASS WORK**

**EXCELLENT TESTIMONIALS**

SUCCESSFUL CLIENTS IN EVERY SECTION OF THE U. S.

Expert-Prompt Services

Highest References

809 F ST., N. W.

**E. E. VROOMAN, PATENT LAWYER, Wash., D. C.**

My offices are located across the street from the U. S. Patent Office

When writing please mention "Modern Electrics."

### ... THE ... "Electro" Static (Wimshurst) Machine

Guaranteed to generate in any kind of weather, no matter, foggy or rainy. The first machine ever constructed which can truthfully claim this. We absolutely guarantee a fat, powerful 3-in. spark from our new machine. It is used successfully to operate Geissler and X-Ray tubes, charging the biggest Ley-

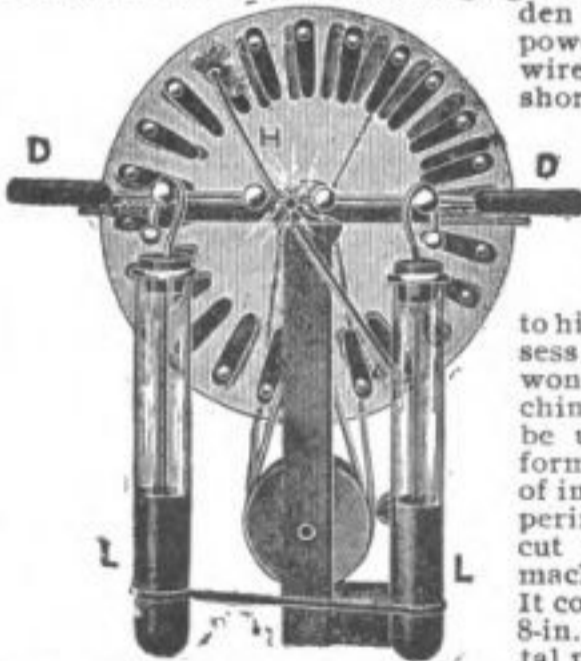

den jars, firing powder, working wireless sets for short distances raising a person's hair, etc. Anybody interested in electricity owes it

to himself to possess one of these wonderful machines which can be used to perform thousands of interesting experiments. Our cut shows the machine plainly. It comprises two 8-in. glass crystal plates revolving

in opposite directions, two adjustable oscillator and discharging rods and balls D, collectors H and one iron clamp to fasten body to table. Size over all 11x14 in. Weight boxed 8 lbs. Nothing to wear out, no batteries, no trouble, simply turn the crank, the machine does the rest. **Price, complete boxed, \$3.75.** If you haven't got our 120 page electrical cyclopedia No. 7, send 2c stamp postage; contains 100 experiments.

**ELECTRO IMPORTING CO.**

86-Z West Broadway, New York

"Everything for the Experimenter"

When writing please mention "Modern Electrics."

### Modern Electrics Binder

Here it is. You've waited long enough for it. You do not have to hunt all through the house to find a particular copy of MODERN ELECTRICS—our new M. E. Binder keeps them together. It is the most



up-to-date binder ever gotten up and will last a lifetime. It works automatic and you can add each month a new copy. Will hold 12 copies and at the end of the year you will have a beautiful BOUND book containing more PRACTICAL information than any electrical cyclopedia three times as large. The binder is made of a beautiful dark red velum. All lettering is impressed in genuine gold and is guaranteed not to wear off. New copies can be inserted

in 10 seconds. You will never be without one once you've tried it. Only by ordering 10,000 binders are we enabled to sell it at the ridiculous low price of **50 CENTS PREPAID.**

We know that every "M.E." reader will send for it. All other magazines ask \$1.00 for identically the same binder.

No stamps, nor out of town checks accepted (except if 10c exchange is added).

**MODERN ELECTRICS PUBLICATION**

84 West Broadway

New York City

When writing please mention "Modern Electrics."



**GROBET SWISS FILES**

And Other High Grade Tools

Are shown in our catalog. Send your name and address on postal and mention this paper and we will send free our catalog.

**MONTGOMERY & CO.,**  
103 Fulton Street, New York City

When writing please mention "Modern Electrics."

**A CHEAP AERIAL INSULATOR.**

When putting up an aerial for experimental work, the amateur is often bothered to secure satisfactory insulators.



-FIG. 1-

M. E.

unless he pays a price which is beyond his means. The ordinary porcelain wiring cleat, preferably of the glazed type, makes an extremely good substitute. The aerial wire is fastened at one end through one of the holes in the cleat, while a wire or cord through the hole in the other end leads to the spreader, Fig. 1. The ropes or wires supporting the spreaders should be insulated in the same manner, but with several cleats in series, Fig. 2, to provide for ample insulation and insure the smallest possible amount of leakage. The guy wires to the pole, if the aerial is thus supported, may be treated in the same manner. If greater tensile strength is desired two or more cleats may be used in parallel



-FIG. 2-

M. E.

side by side with the holes coinciding. But this is not often necessary, for an aerial constructed by the writer, each wire of which is 250 feet long, of No. 12 copper, insulated by single cleats at the end, bears the strain without signs of overload. An aerial insulated in this way hangs gracefully and makes a neat business-like appearance so desirable to the amateur.

Contributed by, A. C. GOWING

**Deafness NOW CURABLE**



Aurophone in use. Practically invisible.

If your hearing is affected in any way or to any degree you are sure to find relief by using the lately perfected electrical hearing devices, the

**AUROPHONE AND THE AURASAGE**

The Aurophone is a powerful miniature electrical telephone which magnifies sound waves so that an affected ear may hear normally. The Aurasage by its action on the middle ear massages the ossicles so that the natural hearing may be restored. These two wonderful devices make possible the **Successful Treatment of Deafness.**

*A Letter from One of Our Patrons.*

Mears Ear Phone Co.—Gentlemen: After 30 years of deafness I have discarded my speaking tube, and no one would know that I have been deaf. Your instrument has restored

my hearing. Words are inadequate to express my gratitude.—H. R. French, 6844 Peoria Street, Chicago, Ill.

**OUR FREE OFFER:**

With every Aurophone sent out we will for the next ninety days, send the Aurasage **without extra charge**, which is to be used together with the Aurophone as long as you need it. The use of the Aurasage **costs you nothing**, and its use in conjunction with the Aurophone, is invaluable. Send the coupon below for the free booklet and for further details of this offer as well as a list of satisfied users in all parts of the world, who will answer inquiries.

**Mears Ear Phone Co. (Inc.) 45 West 34th St., New York**

Branch offices: 65 East Randolph St. Chicago; 120 Boylston St., Boston; 820 Witherspoon Bldg., Phila. Pa.; 1168 Avenida de Mayo, Buenos Aires, A. R.; 25 Boulevard des Capucines, Paris, France; 190 Yonge St., Toronto, Can.

**SEND THIS COUPON TO-DAY**

without obligations to me, send particulars of your special offer.

Name.....  
Address.....  
City.....State.....

When writing please mention "Modern Electrics."

**TELEGRAPHY TAUGHT**

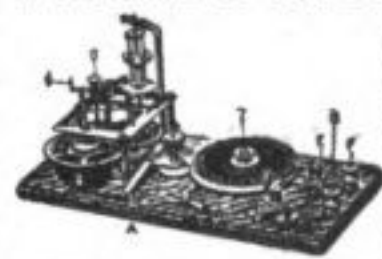

in the shortest possible time. The Omnigraph Automatic Transmitter combined with standard key and sounder. Sends you telegraph messages at any speed just as an expert operator would. 5 styles \$2 up; circular free.

**Omnigraph Mfg. Co.**  
89 1/2 Cortlandt St., New York

When writing please mention "Modern Electrics."

**Premium Catalog**

containing over 600 electrical articles anyone of which you may acquire for **NOTHING**, simply by getting us new subscribers will be sent you on receipt of 2c stamp.

**MODERN ELECTRICS PUBLICATION**  
84 West Broadway, New York

**LEARN TO BE A WATCHMAKER**  
Bradley Polytechnic Institute  
Horological Department A  
Peoria, Illinois  
FORMERLY PARSONS HOROLOGICAL INST.  
Largest and Best Watch School in America  
We teach Watch Work, Jewelry, Engraving, Clock, Optics, moderate rates. Send for Catalog of Information

When writing please mention

UNIVERSITY OF MICHIGAN  
 3 9015 06729 4952

# Christmas

## THE "ELECTRO" LOOSE COUPLER (Receiving Tuning Transformer) (Patent Applied For)

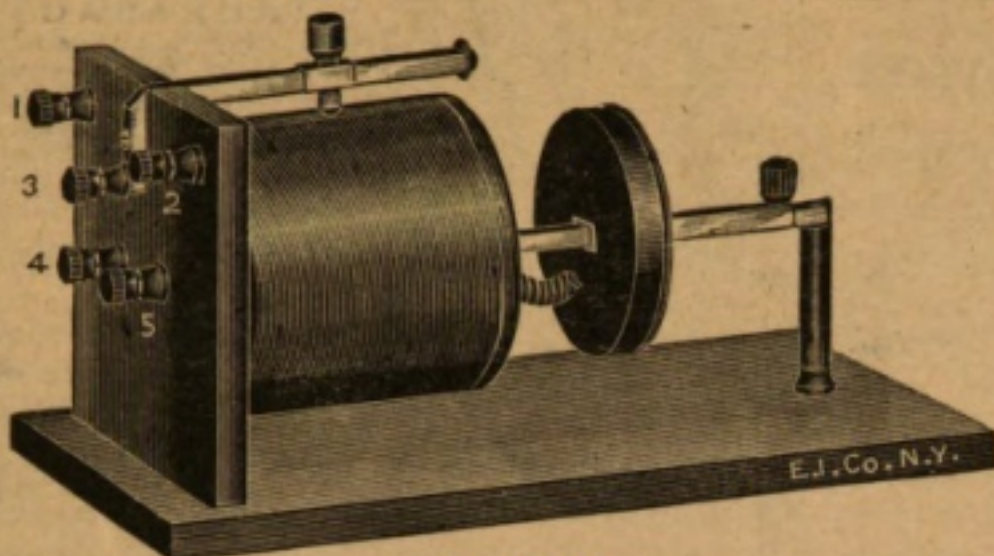

No. 12000

The new instrument is nothing but a transformer which serves to increase the intensity of wireless signals. At the same time it is the most accurate tuner as yet devised. For this reason the large commercial stations and government stations are using it exclusively now, as it enables them to work "through" other stations.

The loose coupler is not a new invention. It has been known for years, in fact has been used by European governments for two years.

However, the experimenter has been deprived of its use as the cheapest on the market sell at an exceedingly high price making it prohibitive for the average experimenter to procure this useful instrument.

We have been experimenting for long months to produce a loose coupler within the reach of everybody and as usual succeeded. Not alone did we succeed but we improved the old type to such an extent that it has a far greater selectivity than any similar instrument on the market **NO MATTER WHAT ITS PRICE.**

By means of our new secondary it is possible to "feel off" comparatively few turns of the primary and as each layer (of the secondary) assists the other one, it will be easily understood why we obtain such marvelous results with our instrument, never duplicated before.

Certain far off stations come in quite loudly even if the secondary is pulled clear out as far as it will go, that is the air distance between primary and secondary is fully 6 inches.

If the instrument was well "in tune", we frequently heard a 2 K. W. station 30 miles distant so loud that the signals even when the phones were one foot from the ear, were plainly audible.

We found the connections as per diagram to give best results. The variable condenser is especially recommended and will be of considerable value. Any detector can be used of course. Personally we prefer the "Electro-Lytic Detector" as the signals come in very much louder.

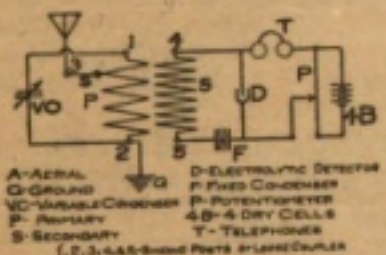

The construction of the "Electro" Loose Coupler is of the highest perfection.

All wood parts are of quartered oak, metal parts nickel plated. The wire on both primary and secondary is warranted to be the best black enameled wire. 5 hard rubber binding posts are provided as shown. If the variable condenser is not used, post No. 1 remains unconnected.

The secondary is machine wound as it would be quite impossible to wind the very fine wire otherwise. It is of course highly important that no wire of one layer should cover any other, in other words the winding must be done with highest precision only made possible with a special winding machine.

The secondary, projecting from the right has a square tube which slides on the square guiding rod with greatest ease. At the far end a hard rubber knob is provided which serves as a handle to move the secondary back and forth.

We use no sliding contacts to make connections with the secondary, a flexible cord passing through the center of the primary connects with posts 4 and 5. No loose contacts possible.

On the primary a single sliding contact is provided with our well known slider used on our other instruments. A stop is provided so that the slider cannot be moved beyond a certain point. The secondary can be moved back and forth with the greatest possible ease and will not stick, or require two hands to move as is the case with even expensive makes. Our loose coupler is built to pick up wave lengths up to 800 meters and as the majority of commercial and government stations have only a wave length up to 600 meters, our instrument will be found to respond in practically all cases.

Adjustment: When connections are made and detector is adjusted, move secondary up to the centre of primary, then adjust slider till signals come in loud; then move secondary back and forth till position is found where signals are loudest. Now the variable condenser is adjusted. Dimensions: length of base 12 inches, width 6 inches, height over all 6 1/2 inches, weight 2 1/4 lbs. No. 12000, the "Electro" Loose Coupler, (Patent applied for) as described,

is the latest word in wireless. While an ordinary tuning coil is admirably suited for ordinary work it is not a success where exceedingly fine tuning is required. In fact even the best tuner cannot tune within 10% accuracy. Furthermore, now when so very many stations are working simultaneously, we must have an instrument which is capable of tuning to an exceedingly fine degree—within 1% accuracy—and furthermore be able to **ABSOLUTELY** tune out ANY unwanted station.

The loose coupler does this in an astonishingly perfect way and in addition will bring in distant stations 3-5 times as clear and loud.

**INTRODUCTION PRICE \$3.75**

NO PARTS SOLD.

Google

No. 12001 "Electro" Loose Coupler with two slides \$4.00

UNIVERSITY OF MICHIGAN