

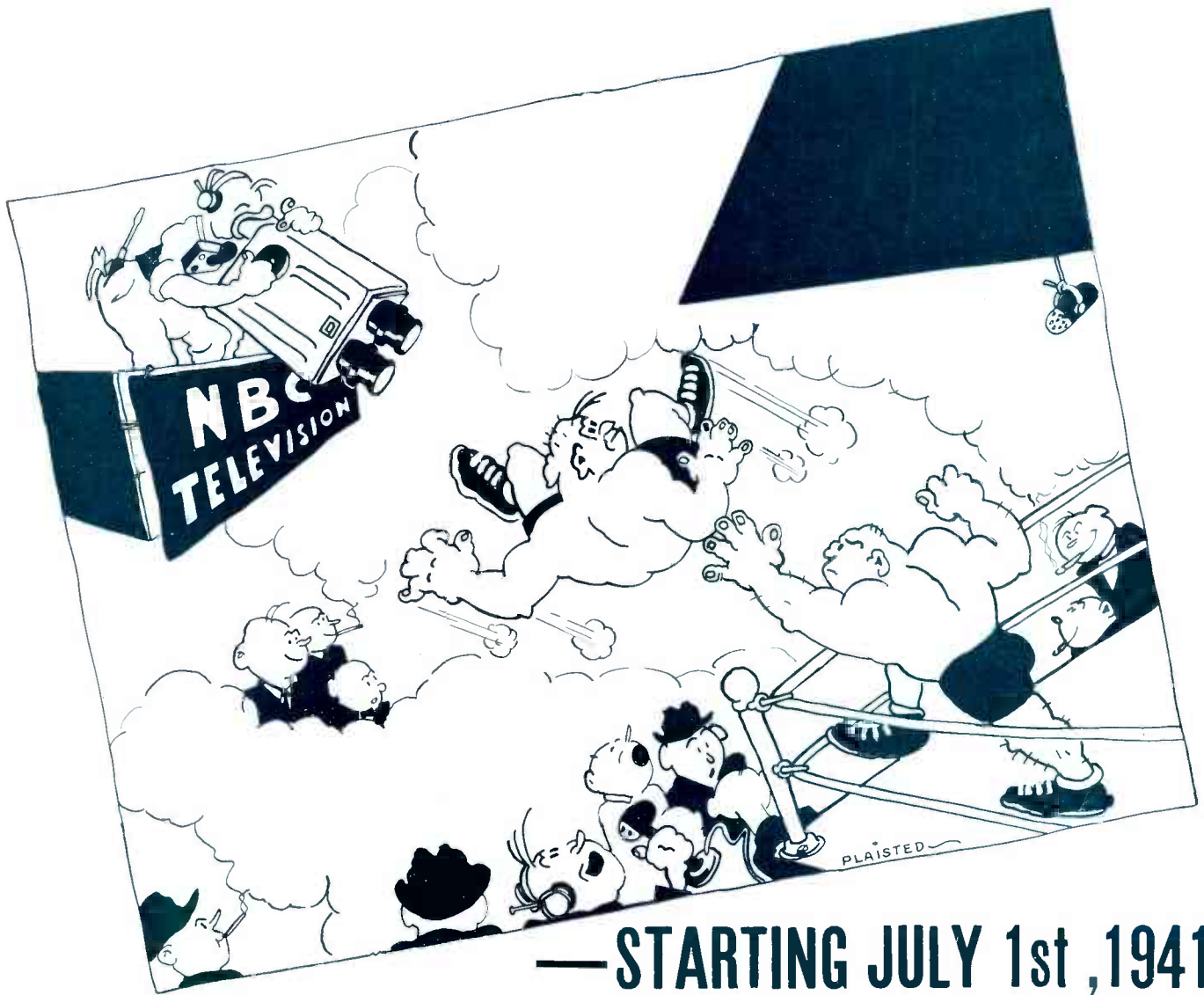

JOURNAL

DIRECTED TO BROADCAST ENGINEERS AND EXECUTIVES

FCC ALLOWS TELEVISION TO SUPPORT ITSELF



—STARTING JULY 1st, 1941

May

Of, By, and For the Broadcast Engineer

1941



2730
to
1.8 METERS
FM/AM
(110 KC to 165 MC)

*Complete
Radio Receiving Station!*

Covers substantially everything in the radio spectrum. You can use one, two or all three units simultaneously through the separate antenna switch. Monitoring speaker connects to any one; in addition separate speakers can be connected as you wish. Headphone monitoring jack ties into output of any one of the three receivers.

The only receiving unit made which tunes continuously from 1.82 to 2730 (165 mc to

110 kc). A few of its services are: time signals, coastal and ship telegraph and telephone, aircraft beacons, standard broadcast, relay broadcast, aviation, amateur, international short wave bands, police, government, press and educational channels. FM broadcast and relay bands with high fidelity audio for best FM reception. Is 20½" wide, 30" high, 18" deep. Sells complete for \$450.00.

the hallicrafters co.

CHICAGO, U. S. A

USED BY 33 GOVERNMENTS

SOLD IN 89 COUNTRIES

TABLE OF CONTENTS

Volume 8, No. 5

409

May, 1941

Cover Cartoon by Ross Plaisted, NBC Television Engineer

	Page
An Orchid to the Broadcast Engineers.....	2
Microphone Problem Solved.....	4
The Forgotten Men.....	5
KGO Wins G. E. Plaque.....	6
You, Too, Can Own a Boat.....	7
A Portable Applause Meter.....	8
In Memorium -- Justus Allen	9
Jack Benny's Radio Anniversary Party.....	10
Safety Bulletin — THINK!.....	12
The "10C70" at Short Beach.....	13
Biographies: W. A. R. Brown George M. Nixon.....	14
New York Engineering News.....	15
Who's Who in Chicago — Harold & Marvin Royston.....	16
Stripers on the Eastern Seaboard.....	18
Denver News.....	20
On the Airialto With Tom Gootee.....	22
San Francisco News.....	24

A.T.E. Publications, Inc.

TRUSTEES

E. Stolzenberger	G. E. Stewart	G. M. Sellar
F. R. Rojas		R. W. Clark

ATE JOURNAL STAFF

Managing Editor.....	E. STOLZENBERGER
Coordinator.....	F. R. ROJAS
Director of Sales and Promotion.....	E. C. HORSTMAN
Press Photographer.....	JOE CONN
Circulation Manager.....	TED KRUSE
Staff Assistants.....	H. GRELCK, BOB WARD
Treasurer.....	C. W. PHELAN
Assistant Treasurer.....	D. J. MOLONEY

ASSOCIATE EDITORS

Chicago.....	T. E. GOOTEE
Cleveland.....	J. D. DISBROW
Denver.....	J. ROHRER
Engineering Chapter.....	R. A. ISBERG
Hollywood.....	RAY FERGUSON
KFI-KECA.....	H. M. McDONALD
Mutual Broadcasting.....	R. A. SCHLEGEL
New York.....	TED KRUSE
San Francisco.....	LEE KOLM
Washington.....	DORSON A. ULLMAN

The ATE Journal is a privately printed monthly publication, issued by the Ass'n of Technical Employees Publications, Inc., a corporation of the State of New Jersey with office at 30 Rockefeller Plaza, N. Y. City. Editor's office: E. Stolzenberger, 116-03 91st Avenue, Richmond Hill, L. I., N. Y.

The A.T.E. Journal is the Official Publication of the N.A.B.E.T. Advertising rates and information supplied on request. Subscription, \$1.50 per year. Single copies, except Christmas Yearbook, 25c; Christmas Yearbook, 50c, subject to availability. All remittances in advance. Foreign: Add postage.

Nothing appearing in the ATE Journal shall be construed to be an expression of the A.T.E. Journal, or the National Association of Broadcast Engineers and Technicians, but must be construed as an individual expression of the author or authors.

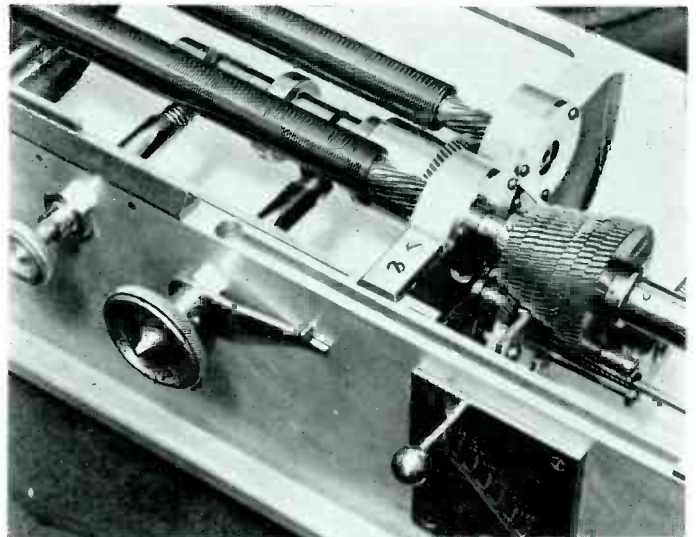

Inside the Recording Bed of a Scully Master Recorder

**Your Recording Clients
CAN Be Satisfied**

Professional Recording Engineers Overwhelmingly **Prefer** SCULLY MASTER RECORDERS because of their undisputably superior performance—a Natural Result of Scully's Pioneering Work in the Recording Field extending over a **Score** of Years.

Scully's Proven and Earned Reputation is **Your ASSURANCE** that the recordings made on a Scully Master Recorder are the finest that human ingenuity and scientific development have yet devised . . . AND . . . that these superb recordings can be duplicated 24 HOURS A DAY!

Specify

for Ease of Operation
Dependability
Precision
AND Permanence

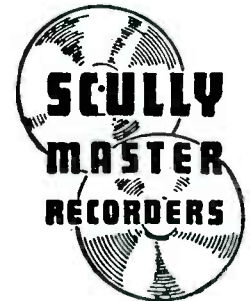

If you are seriously interested in Recording, we are in a position to show that, on a long time basis, the Scully Master Recorder is the most economical "Buy" in the industry—and absolutely cheaper than price-designed equipment. Write, phone, or visit—But

INVESTIGATE BEFORE YOU INVEST

**SCULLY
Machine Company**

62 Walter Street

Bridgeport, Conn.

Telephone Bridgeport 5300

An Orchid to the Broadcast Engineers

By Emil Corwin

Music Editor, National Broadcasting Company

SEVERAL years ago Leopold Stokowski gave radio men a start by wandering from his podium, where they thought he belonged, to poke around in the control room, sacred to the engineers. Stokowski, one of the first of symphonic conductors to explore the possibilities of perfecting the technique of music broadcasting, had no illusions about the microphone from the very start. It did queer things to sound. The way music came out from the loud-speaker wasn't always the way it went into the microphone, and Stoki would find out why.

It was an awesome thought to this man that the destiny of a program over which he and his musicians labored mightily for hours rested in the ten fingers of a dial twister sitting inscrutably in a control room set apart from the orchestra. The carefully rehearsed nuances of tonal balance might be ruined by an impulsive or unwarranted flip of an engineer's wrist. After all, the engineer was a radio man, not a musician.

So the inquiring conductor went to the crux of the matter. He set up a glass cage in front of the orchestra and took over the controls himself. Everything went fine—but in the control room only. The knob twisting was well and good for the music coming into the control room, but not so good for the listener. The music was sometimes too low to register over the air, and at other times the orchestra was so loud it was knocked off the air thirteen times in an hour.

This happened more than a decade ago, when musically trained men were not engineers, and engineers functioned as importantly as musicians, for it was in their power to "mix" music from various microphones, to magnify the soft tones and tone down the loud tones. The engineer, in short, was a sort of mechanical crutch to artistic expression. Some of the "long hair conductors" can be pardoned for the impression that the control room boys were muscling into their territory.

But nowadays there is only harmony, literally and figuratively, between the control room and the podium. As Dr. Frank Black, NBC's general music director, points out, the control room today is merely a convenient listening or checking post. Once the concert begins, the

control knobs are rarely adjusted, unless it is for applause and bravos.

The engineer's job is simpler because the technique of broadcast music is simpler. Not six, but a single microphone is used, for example, to pick up the performances of the NBC Symphony Orchestra of more than 100 men. If there is a soloist with the orchestra, no matter whether he is vocalist or instrumentalist, he uses the same microphone, suspended from the ceiling in front of the stage.

The one-mike idea is likened to hearing with one ear. When several mikes are used, it means that the man in the control room must resort to balancing, destroying the conductor's balance and reconstructing one of his own.

The single microphone, Dr. Black says, is like a camera. It takes an over-all picture without distortion. "There is a school," he adds, "which holds all-important the attainment of one single end. That is the projection on the air of a musical picture of the performance as true as would be heard in the studio or concert hall."

If the engineer's job in the control room is simplified, he has himself to thank for making it so. For it is through his ingenuity that important advances have been made in the creation of higher quality microphones, in circuits that prevent overloading, in gadgets that have enabled music to be broadcast with greater fidelity and in broader tonal ranges.

It must not be assumed, however, that the control room engineer is twiddling his thumbs instead of the knobs in the control room now. He hasn't got it that easy. He is still very much in the picture, and I would be overlooking an important aspect of his function if I neglected to mention a criticism of a recent NBC Symphony concert by Olin Downes, music critic of the New York Times. In commenting on the playing of two Berlioz works, Downes wrote on April 6, 1941:

"The Queen Mab Scherzo, coming over the air, is a little louder than when actually heard in the concert hall, perhaps because the transmission gentlemen are afraid that its delicacy will be inaudible without a little magnification; while the Rackozy March is at the other sonorous pole: it is doubtless too brilliant in places for the manipulators to let the whole climax through."

To appreciate the significance of the criticism it is necessary to know that the dynamics of the two selections singled for mention are at opposite poles. The "Queen Mab" work contains long stretches of soft, shimmery music so fragile and delicately pianissimo as scarcely to be heard in a concert hall. The Rackozy March, on the other hand, is heavily scored, being one of loudest compositions in symphonic literature.

Here was a situation not likely to occur in one concert in fifty: two works of such dynamic extremes presented in juxtaposition. If there were no experienced control room engineer to ride the gain, the soft music would have been too low to register on the air and the loud music coming through unchecked would have thrown Mr. Toscanini off the air, which was Mr. Stokowski's experience a decade before. As it was, the "Queen Mab Overture" came over only a "little louder", which is better, of course, than not coming over at all.

There is never a dull moment in the control room. Every new program, every new artist, presents a problem of some sort. Take such a simple sounding affair as four men playing four pianos simultaneously. Sounds easy, but I am told that eleven engineers put their heads together on the "First Piano Quartet" to work out some problems of production. Problems? Well, what are you going to do when none of the four pianists plays with the same strength? How about the fact that no two pianos have the same dynamics, meaning that piano A sounds louder than piano B, though they are played with the same touch?

After trying a pickup with half a dozen mikes, and much shifting of concert grands, it was found that a single 77B uni-directional mike, raised to maximum height, gave the truest musical picture. The pianists with the strongest touch were placed farthest from the microphone and the pianos were arranged in square formation. An interesting sidelight in this broadcast was the ruling out of the use of the pedal in the interest of a crisper and cleaner tone.

Richard Leonard, production director of the NBC Symphony and other programs, believes that there are limitless possibilities in sounds and combinations of instruments in radio. When a con-

ductor sends part of his orchestra off-stage for a distant effect; when an entire brass section leaves its accustomed position to play into the open piano with the strings held down by the sostenuto pedal; when a trumpeter directs his tones into a bucket of water; when one clarinetist plays without a mouthpiece and another plays with only a mouthpiece—when radio musicians do things of this sort, they are experimenting in tonal effects, pioneering in a new technique, building the groundwork for radio music of the future. These pioneers, says Leonard, are chiefly the dance bands. They have taken the tones which could never be produced in a concert hall and made them an integral part of radio music orchestration.

These are experiments which would have appealed to Wagner, Rimsky-Korsakoff, Berlioz and other composers who were interested in the mechanics of orchestration.

Leonard feels that more conductors should follow the lead of Toscanini, Stokowski and Bruno Walter in their willingness to experiment with broadcast music to get the best results in dynamic changes and balance. Toscanini in his NBC broadcasts is always amenable to shifting his men for better radio effect. During a rehearsal of the Overture Bacchanale from Tannhauser, for example, the Maestro severed his orchestra, sending part of it off-stage for the desired far-off effect. Toscanini during rehearsals often wanders about the studio while another directs and into the control room to determine tonal values.

Bruno Walter discovered that he could not "just make music and let it go" in the radio studio as in the concert hall. He felt he had to give the basses more weight because they are not heard on some small receiving sets as easily as the higher octaves.

Leonard has seen and heard nearly all the great contemporary conductors and orchestras in the concert hall, but he considers it a greater experience to hear their rehearsals and performances from the control room of the broadcasting studios. It is exciting to be witness to the tests and experimentations of the great interpreters of music, each of whom has his own peculiar ideas about how best to prepare a concert for the radio audience.

But for the all-important task of transmitting the world's finest music so that listeners everywhere might hear it without distortion and with increasing fidelity, the music makers must look to radio's engineers who, in their plodding, unspectacular way, have each year improved the technique of transmission.



Photos by NBC Press Dept.

Top: Dr. Frank Black, NBC Music Director, in action

Center: Richard Leonard, NBC Production, follows the score of a symphony rehearsal

Bottom: Engineer Ewert and Producer Tom Riley concentrate to give the listeners

BETTER radio entertainment

Microphone Problem Solved

By F. M. Figgins

National Broadcasting Company, Hollywood

THE RCA 44-B and 44-BX microphones, as you no doubt know, are provided with a movable link. This link furnishes a method of changing from "voice" to "music" response. Also, the substitution of a fifty ohm resistor for this link effects a desirable compromise. However, making these changes entails the use of a screw driver and requires some little time.

Here in Hollywood we have attempted to reduce these changes to a minimum, to avoid the resultant troubles with stripped threads, lost screws, loose connections, and the

were considered and rejected before we arrived, we think, at a satisfactory solution. The drawing and photographs show our modification.

It will be noted that the wiring in the base of the microphone has been changed. A fifty ohm, one-half watt, IRC resistor has been mounted on the lugs formerly used to terminate the link. Mounted on the outside of the bottom plate is, essentially, a single pole, triple throw switch. This switch is built on a one-eighth inch bakelite plate, using standard 6/32 brass machine screws, hex nuts, and knurled

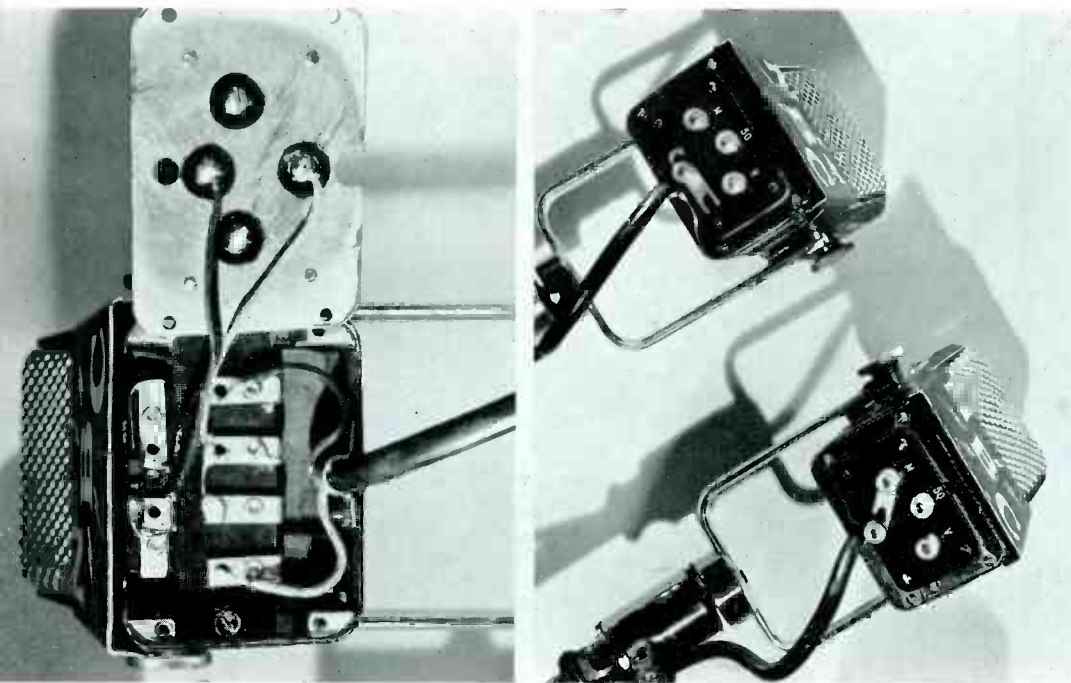

Photographs by Art Brearley

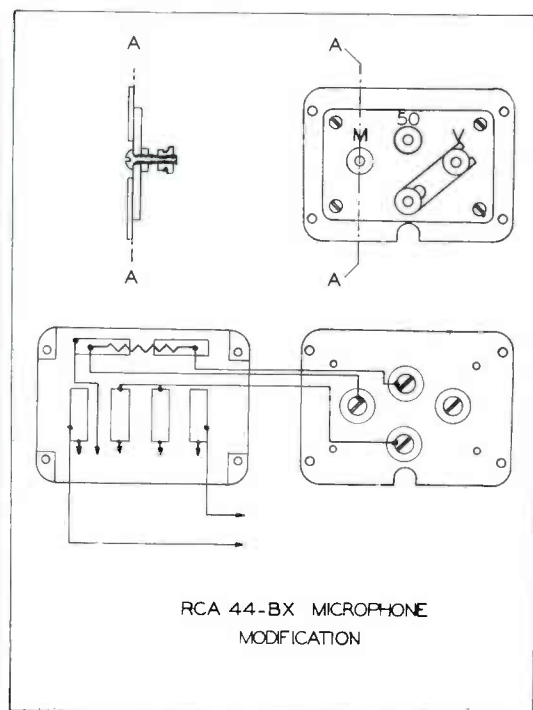

general inconvenience and loss of time to the Studio Engineers. We attempted to equip each studio with a combination of microphones which would fill the requirements of any program. No combination, within reasonable numerical limits, seemed to be satisfactory. Constant changes were necessary, and changes usually meant a hurried call to the Maintenance Group.

Our problem, then, was to find some method to expedite those changes. A switch was the obvious answer, but space limitations and the lack of availability of a good, positive acting switch precluded this solution. Many ideas

were considered and rejected before we arrived, we think, at a satisfactory solution. The link is a piece of 5/16 inch by 20 gauge brass with slotted ends; one end has a closed slot, to prevent loss. All metal parts are cadmium plated. After assembly, the ends of the screws are "upset" to prevent loss of any un-tightened nuts. All connections, including the cable, are soldered to reduce possibility of loose connections.

Four microphones were modified and put in service, on a test basis, to check the reaction of the Studio Engineers. Immediate, favorable comment from all Engineers, and an appreciable reduction in "borrowing" of microphones, convinced us of the success of our modification. All microphones of this type were then modified.

The Forgotten Men

TOO few of us have ever stopped to think about the telegraphers, the Morse operators—so much a part of American history. They were closely allied with us once—back in the early days of radio—even, in a sense, then a part of our existence. But radio, the telephone and mechanical telegraph have all but erased the land-line telegraph operators of old.

Radio was a child of telephony and telegraphy, but now a child no longer dependent on its foster parents. As radio grew, so did the telephone and the telegraph. But as the number of active radio operators steadily increased, the number of telegraphers gradually diminished. New and modern machinery replaced the old-line Morse men; now their services are no longer in demand. And possibly within another decade the telegraph operator will have slipped into the dim history of another day now past.

There once was something of a common bond between the radio operators and telegraphers. But somewhere along the "line" we parted company, each to his separate way. The old Morse men were considered persons of skill and distinction once. And they stuck to their jobs as best they could despite the onrush of a new machine age. Then came the full-page printer, and the many new teletype machines. Finally, the crushing blow: the automatic operators—mere robots that did their work at lightning speed. Newer and younger and cheaper help came in to take away their jobs, and the Morse telegrapher was gradually edged out of the communications picture.

There seem to be fewer of these men with each passing day—and the mortality rate is high. Perhaps another ten years will even find them forgotten by their own industry, and by the world. This then is a tribute to the Telegraph Operators — our kindred brothers, so imperceptibly disappearing from the American Scene they helped to create: the history of these United States. —T. E. G.

A.T.C. Journal **5** May — 1941

POPULAR DAVEN SERIES 750 DECADE RESISTANCE BOX



Designed for use as Laboratory Standards, as components in Bridge Circuits, and in other types of precision measuring equipment . . . the Decade Resistance Boxes are complete assemblies consisting of two or more Type 225 DAVEN Decade Units mounted on an engraved metal panel and enclosed in a shielded walnut cabinet.

Three terminals are provided, two for the resistance circuit, and a third as a ground connection. There is no electrical circuit between the resistance elements and the metal panel. Available in 12 models with resistances from 11 to 1,111,100 ohms, in from 0.10 to 10. ohm steps.

DECADE RESISTOR UNITS

TYPE 225 — FOR PRECISION LABORATORY STANDARDS

These Decade Resistor Units are precision type resistors and can be used individually in equipment . . . when complete Decade Boxes (Series 750) are not required. Each unit is completely enclosed in an aluminum shield and supplied with pointer-type knob and aluminized dial plate. Seven standard models covering the range from 0.10 to 10,000 ohms per step or a total of 1.0 to 1,000,000 ohms in accuracies of from 1.0 to 0.10%.



THE DAVEN COMPANY

158 SUMMIT STREET • NEWARK, NEW JERSEY

Export Department: 100 Varick Street, New York City — Cables: "ARLAB"

KGO
Engineers
Awarded the
1940
General Electric
Plaque
31 Seconds Lost Time
in 6,400 Hours!



PRESENTATION OF G.E. PLAQUE
 (Left to Right) Mr. Alvord, G.E. Pacific Division Vice-President; Mr. O. B. Hanson, NBC Vice-President and Chief Engineer; Mr. Curtis Peck, and Mr. A. E. (Shorty) Evans

ADDITIONAL distinction for the unsung Engineers behind the scenes in American Radio Broadcasting was brought about when the Engineering Staff of the KGO transmitter at Oakland, California, received the General Electric Company's annual merit

award for technical efficiency manifested by the least broadcast transmitter time lost on-the-air through technical failures during the year 1940.

For this achievement, "Shorty" Evans, KGO Engineer-in-Charge, was presented with the handsome plaque in behalf of

his Engineering Staff by Mr. R. M. Alvord, G.E. vice-president in charge of the Pacific District. The presentation speeches were broadcast together with a skit which dramatized what might have happened during the thirty-one seconds lost by KGO in over 6,400 hours of broadcasting.

At the presentation luncheon were many nationally-known executives, including Messrs. O. B. Hanson, NBC V.P. and Chief Engineer, Al Nelson, Curtis Peck, and Joe Baker of NBC, and Messrs. E. T. Harris and H. M. Scholes of G.E. Needless to say, all Engineers not on watch at the KGO and KPO transmitters were also in attendance at this memorable occasion.

Associated with "Shorty" Evans in establishing this record were Geo. Irwin, A. E. Fisher, H. C. Dunton, Jimmy Ball, Myron Case, Dick Parks, and A. E. Eldredge, shown in the photo at the bottom left of this page. The San Francisco Chapter is rightfully proud of their fine record.



KGO TRANSMITTER MEN—(Seated) "Shorty" Evans. (Standing, left to right) George Irwin, Manoel Perry, watchman; Myron Case, James Ball, Henry Dunton, Addison Eldredge, Aubrey Fisher, and Dick Parks

You, Too, Can Own a Boat

By Harry Jacobs

Engineering Dept., National Broadcasting Co., San Francisco

THE accompanying picture is a graphic report of the efforts of a Broadcast Engineer at the time-honored art of shipbuilding. The work was begun in May last year, and completed early this winter midst heavy rainstorms that threatened to float the hull prematurely down the streets of Berkeley and into San Francisco Bay.

The complete boat was built in the not-so-big garage at the cost of leaving the family jalopy out in the drizzle and sun for eight months. Some details of construction may be of interest to those who are boat-conscious. The hull is 18 feet long by 5 feet 4 inches beam (wide, you lubbers), and draws 3 feet 1 inch (don't try to navigate a three-foot ditch!). The hull is built entirely of resin-bonded water-proof plywood, and fastened with silicon-bronze screws. The keel is a casting of 625 pounds of lead, held in place by 4 lag bolts $\frac{5}{8}$ inch in diameter. All fittings are bronze,



and all rigging is stainless steel. Total weight of the completed boat is close of 1,000 pounds, and inasmuch as the hull is very light, due to the use of plywood construction, the results should give a very stable boat (I can swim, anyway).

The design is one done 'specially for the San Francisco Bay by a local designer, Ernest Nunes, of Sausalito, across the bay from S. F., and incorporates features which are needed in the choppy waters of the Pacific area. "NEMO" is number forty of a fleet of over seventy boats that have been built to the plans in the last two years.

Note to would-be boat builders: It's a cinch, if you have lots of time and no one to bother you with their ideas about how they'd do it. Just speak to your supervisor and arrange for a night watch, get up at 7 every morning and work on the boat till 2 in the afternoon, don't cut the lawn, forget to wash the car, let everything else go to the dogs, and low and behold, in about a year or so you'll probably have a boat!

Now, learn to sail it, and appreciate complete relaxation, the one thing every broadcast engineer could use more of.

SKINNER, COOK & BABCOCK
INCORPORATED

BUILDERS

NEW YORK

Builders for the Radio and Television Industry

Typical Projects Handled by
Skinner, Cook & Babcock, Inc.
(Since 1924)

- Broadcasting station WCAF (1st unit) and erection of antenna towers, Bellmore, Long Island
- Broadcasting station WCAF (2nd unit), Bellmore
- Broadcasting station WCAF (3rd unit) and erection of antenna towers, Port Washington, Long Island
- Broadcasting station WJZ (1st unit), Bound Brook, New Jersey
- Broadcasting station WJZ (2nd unit), Bound Brook
- WJZ studio renovation, 33 West 42nd Street, New York
- Removal of old WJZ towers from roof of 33 West 42nd Street
- RCA Technical and Test Building, Van Cortlandt Park South, New York
- RCA receiving station, Belfast, Maine
- RCA tuning coil and mast foundations and anchors, Tuckerton, New Jersey
- RCA short wave station and cooling pond, Rocky Point, Long Island
- Foundations and erection of towers and masts, Rocky Point
- RCA community house addition, Rocky Point
- Additions and alterations, administration and development buildings, Rocky Point
- RCA receiving station and additions, Riverhead, Long Island
- RCA alterations, Bush Terminal, Brooklyn, N. Y.
- Mast erection, roof of 30 Broad Street, New York
- Mast erection, roof of 65 Beaver Street, New York
- Alterations, RCA Communications Building, 66 Broad Street, New York
- Erection of NBC television antenna on dome of Empire State Building, New York
- Design and erection of television relay tower, Hauppauge, Long Island
- WABC guyed tower erection and foundations, Mountain View, New Jersey
- American Radio News tower erection and foundations, Carlstadt, New Jersey
- WEVD mast erection and station alterations, Brooklyn, New York
- Research laboratory for Major Edwin H. Armstrong, Alpine, New Jersey
- F-m Tower (design and erection) Station W2XMN, Alpine

Let us discuss your
construction problems with you

Phone MUrray Hill 2-3156

A Portable Applause Meter

By E. Stolzenberger

Maintenance Engineer, National Broadcasting Company

THIS portable applause meter was designed to accommodate studio and traveling radio programs that require a device to register the relative amplitudes of audience reaction, such as applause and laughter.

In the past, programs that required an applause meter were accommodated by feeding an audience microphone to two or three cascaded microphone pre-amplifiers, the output of which fed a voltmeter, such as the present standard "VU" meter. This meter was housed in a bakelite box and was placed either in the control booth, studio, or on the stage—as the Client wished. However, this was cumbersome because it necessitated many patch-cords, tied up pre-amplifier facilities, and required three pairs of conductors from the control booth to the meter box, which at times had a tendency to feed-back.

To eliminate these operating difficulties, it was deemed desirable to have all associated equipment mounted together as a self-contained unit, so that the only external connection

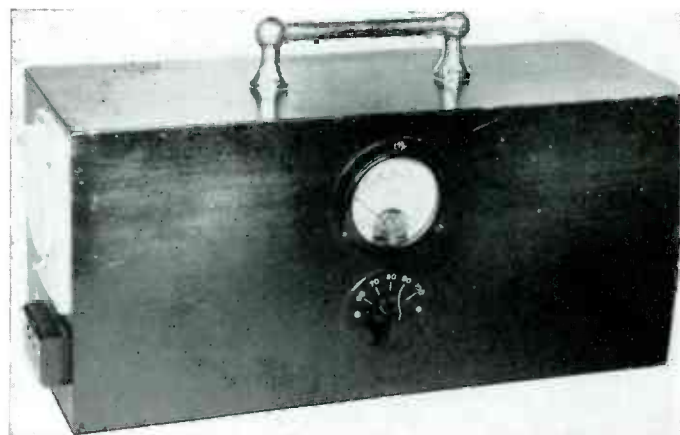

(Staff Photos)

Fig. 1. Front view, showing carrying handle, "VU" meter, and calibrated gain step-switch

was the microphone or other sound source, such as the "program bus." The completely self-contained applause meter is shown in the photographs; it has been in service several months and we are happy to report that the Clients are pleased with its operation and adaptability to their demands, which, after all, is the acid test in competitive broadcasting. The entire unit measures 14" long, 6½" high, and 5½" deep—all inside dimensions. Because the circuit is conventional and without "tricks" the diagram was not included. An optional microphone-matching, or line-bridging input transformer feeds an RCA 1T4 pentode mounted in an anti-microphonic suspension, which in turn is loaded by a six-position step attenuator of 10 db per step; the output feeds another 1T4 pentode, which in turn drives a beam-

power 1Q5GT which is shunt fed and directly loaded by a Weston model 301 "VU" meter. These tubes were chosen because their filaments operate directly from a single 1½ volt battery without series dropping resistors, and deliver maximum gain with only 90 volts of B battery. Matching input

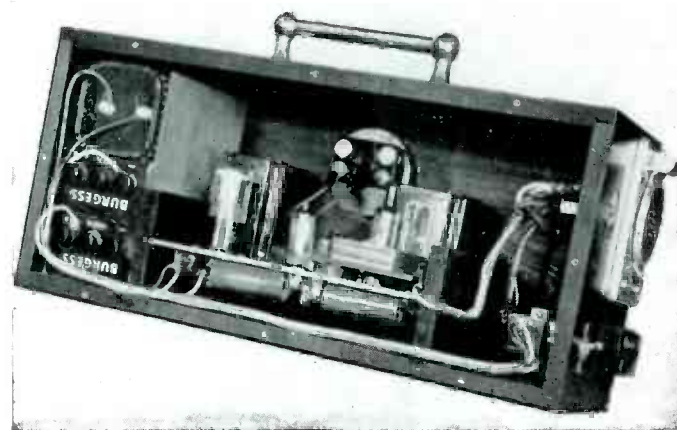

Fig. 2. Back removed, showing batteries, sliding chassis, meter pin-jacks, and anti-microphonic input tube mounting

is used when the meter is used with its own microphone, and a toggle switch transfers to bridging input when a separate microphone is not available or desirable. As the photos show, various receptacles permit use with studio or field microphones, and a pair of jacks permit patching the input to other equipment, as circumstances may require.

Obviously, the requirement is for accurate *relative* readings, and the author wishes to stress this point—because the instrument herein described is *not* intended to function as a

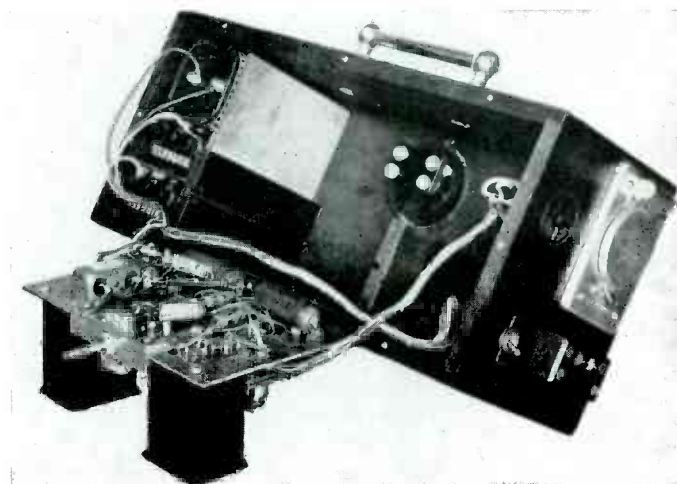

Fig. 3. The chassis removed for inspection; microphone receptacles, jacks, and power switch are clearly shown

sound level secondary standard, and therefore does not include calibrating or "weighting" circuits.

The experimental model shown does not include the input-switching toggle, or hinged back, which are to be "standard equipment" on replacement models.

Since this unit was conceived by New York Maintenance personnel, it naturally has several novel features attractive to maintenance engineers; pin-jacks mounted on the Weston meter case permit removal of the chassis without removing the meter or applying a wrench to its terminals; the flat chassis rides in tracks, and is removable without disconnecting input or power connections, which permits complete visual, mechanical, and electrical inspection of the unit while it is in an operating condition.

JUSTUS ALLEN

It is with deep regret that with this issue we must announce the passing of Justus Allen of the Empire State staff.

Allen first joined the N.B.C. in March, 1931, as transmitter engineer at WENR, Chicago, and subsequently achieved the rank of Assistant Station Engineer.

In April, 1939, he was transferred to the New York Television staff and spent several months in the various television groups in Radio City before being assigned to the Empire State Transmitters.

Being an excellent mathematician with a flair for filter design he was particularly valuable at Empire State and was principally responsible for the FM-Video cross coupling filter which received considerable publicity.

It was after the completion of the last job that Justus began to complain of periods of sickness which were attributed to a sinus condition.

He took an early vacation in the hope that a change of climate would help him. This was followed by a month of sick leave.

On May 2, we were horrified to learn that Justus was in a serious condition at St. Luke's Hospital in Denver and was to be operated on for a brain tumor. He never recovered from the operation and passed away on May 4. He was highly respected by all who had contact with him and his loss is keenly felt by all his associates.

We at Empire will remember Justus as a capable and efficient engineer, a considerate and trustworthy companion with a rare sense of humor, and in general a thoroughly nice person. —V. B.

— 30 —



*the high hat
doesn't fit...*

Time after time, we've been tempted to do a little "crowing" about ALLIED acceptance . . .

But as much as we'd like to "pat ourselves on the back," we realize that consistent, satisfactory performances are everyday "musts" for ALLIED equipment.

Guess we'll postpone wearing the "high hat" until we can boast of something unusual.

•
**ALLIED RECORDING
PRODUCTS CO.**

21-09 43rd Avenue • Long Island City • New York



Jack Benny's Radio Anniversary Celebrated

FRIDAY, May 9, was the biggest red letter day in the life of Jack Benny—and the letters weren't on the box, either. The NBC Jell-O comedian was honored by radio, stage and motion pictures as the favorite funny man of a generation—Benny is celebrating his tenth year on the air, but he has been in the show business a quarter of a century.

At 10:30 p.m., EDST, stars of stage, screen and radio took to the air over the coast-to-coast Red Network of NBC to pay him tribute—from New York, Gary, Indiana, and Hollywood.

Following the broadcast, one thousand celebrities of the show and business worlds got together at the Los Angeles Hotel Biltmore Bowl to salute the former fiddler from Waukegan, whose father wanted him to be a small town haberdasher and forbade his stage career.

Niles Trammell, President of the National Broadcasting Company, over whose Red Network Benny has won more popularity polls than any other personality in radio, was the official host.

Rudy Vallee, another radio veteran, who for over a dozen years has ruled the air as an NBC institution and who has discovered more stars than any other radio headliner, acted as toastmaster.

Louis B. Mayer, vice-president of Metro Goldwyn Mayer in Charge of Production, was there to represent and speak for, the motion picture industry in which Benny has also attained stardom.

The broadcast saluting Benny brought to the microphone in its sweep across the continent, both intimate friends of the jester and contemporaries of his struggling days on the stage.

New York NBC brought his first an-

nouncer, Alois Havrilla, Announcer Ed Thorgersen, Amos 'n' Andy, Eddie Cantor and Ole Olson of Helzapoppin Olson & Johnson fame. From Gary Indiana, NBC picked up his recent quiz rivals, the famous Quiz Kids, and from Hollywood, Benny received the congratulations of his close friends, Claudette Colbert and Herbert Marshall, and from Mr. Trammell on behalf of NBC.

The dessert of the show was provided by Mary Livingstone, Rochester and Jack Benny himself, over mikes installed in the Benny home in Beverly Hills, which gave the listeners a "stitch by stitch" description of Rochester dressing the "boss" for the gala anniversary dinner.

The Benny Anniversary Dinner was the most colorful affair Hollywood has seen since the annual Motion Picture Academy of Arts and Sciences Night. Seated with Benny on the dais and in the audience were more stars than you can see in the sky at night.

Among the star speakers were Bing Crosby, Fibber McGee and Molly, Bob Hope, W. C. Fields, Burns and Allen, Mary Livingstone, Edgar Bergen and Charlie McCarthy and Benny himself.

Presentation of anniversary gifts on behalf of radio and screen were made to Benny by Mr. Trammell and Mr. Mayer. Business world speakers included Colby Chester, Chairman of the Board of General Foods Corporation, Benny's sponsor for seven years. Don E. Gilman, Vice-President of NBC in charge of the Western Division, introduced Vallee. Former Ambassador William C. Bullitt gave the dinner an official touch.

Other NBC executives crossing the continent to honor Benny included John F. Royal, Vice-President in

Charge of the International Division; Sidney Strotz, Vice-President in Charge of Programs, and Bertha Brainard, Manager of Program and Talent Sales.

Benny first went on the air in 1932 as guest of columnist Ed Sullivan over a New York station after a vaudeville career that dates back to days immediately preceding the last World War. He served in the United States Navy then, and sets the real start of his career on the day he was given a couple of comedy lines to speak in a Great Lakes Training show in which he appeared as a violinist.

It was as a violinist that he flopped at New York's famous Palace Theatre before the war and it was as a comedy monologist that he finally succeeded after the war, rising to amazing heights via the new medium of the air.

The producers of Benny's programs estimate that the NBC jester generates 117,000,000,000 laughs a season. Each show averages one hundred laughs. On the basis of thirty-nine programs a season and an average of 30,000,000 listeners per program, the season's laugh output soars into the astronomical figure.

The adjacent collage of photos is the work of the Journal's Staff Photographer, Joe Conn. The hub of the collage is, of course, Jack Benny and Mary Livingstone, and from left to right, top to bottom, the celebrities are, Sidney Strotz, Louis B. Mayer, Niles Trammell, The Quiz Kids; Herbert Marshall, Bob Hope, Bing Crosby, Bertha Brainard, and Rochester; John F. Royal, Edgar Bergen and Charlie McCarthy, Alois Havrilla, Olson & Johnson; Burns and Allen, Rudy Vallee, W. C. Fields, and Don Gilman; Fibber McGee and Molly, Eddie Cantor, William C. Bullitt.

CAPPS*

SAPPHIRE is, and has always been, the only material for making cutting styli for high class recordings.

CAPPS* Patented Sapphire Styli are the original and accepted standard for high class professional acetate recordings.

Imitated but not equalled

•
FRANK L. CAPPS

244 W. 49th STREET NEW YORK CITY

Telephone Circle 6-5285

*Reg. U. S. Pat. Off.

CARE

Care in the lesser details as well as the important ones is the result of careful and thorough training. It is especially important at Terminal, where good service is our best salesman.

TERMINAL RADIO CORP.

68 WEST 45th STREET
80 CORTLANDT STREET
NEW YORK CITY

Phone for Both Stores: VAnderbilt 6-5050

THINK

IT has often been stated that there is "no substitute for brains." This phrase also applies very appropriately when the subject of safety is involved, whether it be one of fire or danger to humans. There is no time when an individual is called upon to make more rapid and accurate decisions than during such an emergency. It may mean the loss by fire of an enormous investment, or it may be that the life of your best friend is at stake. Heroes are born during just such occasions.

In order that you may properly, accurately, and rapidly make such decisions during an emergency, you have been furnished with as much pertinent data as possible and will continue to receive such data from time to time. You also have been schooled in the proper resuscitation methods and the use of the gas masks. The phrase used in the last A.T.E. Journal Safety Bulletin said, "THINK IT OVER." This could properly be reduced now to one word, namely, THINK.

On May 10, a fire occurred in New York, and from all general appearances to the guide who discovered the fire, "it was heading for a big fire," but the prompt and efficient efforts of Maintenance Supervisor Charles W. Phelan of the New York Engineering Staff soon had the blaze under control. It was not alone the matter of properly applying the fire extinguishers that brought the blaze under control, but it was also the fact that all efforts were properly coordinated, which included:

- 1, ventilation;
- 2, gas masks;
- 3, services of Rockefeller Center safety squad;
- 4, services of New York City Fire Department;
- 5, use of electricians for emergency lighting;
- 6, use of engineers for disconnecting electrical circuits.

And finally, also of extreme importance, the fact that a thorough check-up was made to insure that no further damage would recur, such as subdued combustion in unexpected nearby places and burning of insulation from circuits that might have caused further fire and damage.

Every fire, after it has occurred, tells a story of "what might have been done—IF." It is these incidents that should be thoroughly discussed locally in order to insure better action in possible future cases.

Aluminum Disc Substitutes

Stories are still going the rounds that all disc manufacturers are working overtime to produce a satisfactory substitute base material, now that the industry has an aluminum famine on its hands.

These substitutes range from glass to cardboard and plastics, and we expect to have an opportunity to try them all very soon.



The "10C70" at Short Beach, Jones Beach State Park

THE number under the shapely number is not a telephone number, but serves as identification of the very sleek and ship-worthy cabin cruiser owned and skippered by New York Maintenance Engineer Carlos Clark.

The "10C70" is 33 feet long, has an 8-foot beam, and draws 2 feet of water. It is powered by two Chrysler four-cylinder engines, complete with fresh water cooling, including the exhaust pipes, and has a maximum speed of approximately 16 m.p.h., and a cruising speed of 12 m.p.h.

The main cabin sleeps two, in 6½-foot long lower bunks, and the forward stateroom sleeps two, also in comfortable 6½-foot lower bunks. Further pleasures of "home" include a 32-volt power plant, running water, lavatory, carbon-dioxide fire extinguishers, mechanical refrigeration, a modern galley and, of course, one of the latest RCA broadcast receivers. While on the subject of fire extinguishers, Carlos Clark is also Fire Chief of the New York Maintenance Group—just one of their many and varied responsibilities at Radio City, the world's largest broadcast plant.

Ye Editor, Ed Stolzenberger, is making every effort to induce Carlos to name

her the "A.T.E. Journal Summer Editorial Office" and hopes that psychology and the power of suggestion will do the

rest! A ship-to-shore radio telephone would then complete the "10C70's" boast of having all the comforts of home.

Presto Offers a New 50 Watt Recording Amplifier . . .

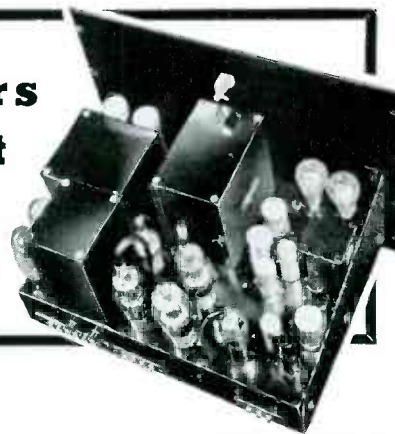

. . . and the first *accurately calibrated* recording channel for making direct playback transcriptions. The new Presto 88-A amplifier, combined with the Presto 1-C cutting head, makes recordings identical in response to the finest commercial pressings. These recordings give you full range reproduction when played back on the N. B. C. Orthacoustic or standard lateral settings of your reproducing equipment. A switch on the amplifier selects either of the two recording characteristics.

You'll hear a new quality in your recordings when you use this Presto equipment . . . a fuller, more

natural bass . . . crisper, cleaner highs. Pre-emphasized high frequency response reduces surface noise well below audibility. Output of the 88-A is 50 watts with 1½% distortion. Gain is 85 db. Noise level is 45 db below zero (.006 W). Use the 88-A in place of your present amplifier. You'll notice a tremendous improvement in your recordings. Your present Presto 1-B or 1-C cutter can be calibrated with an 88-A amplifier at a nominal charge. Catalog sheet on request.

Canadian Distributor: Walter P. Downs, 2313 St. Catherine St. W., Montreal, P. Q.

PRESTO RECORDING CORPORATION
242 West 55th Street, New York, N. Y.
World's Largest Manufacturers of Instantaneous Sound Recording Equipment and Discs

W. A. R. Brown

Leaves Post as NBC's Assistant Development Engineer, to Join the RCA Frequency Bureau

William A. R. Brown attended the Massachusetts Institute of Technology and in 1916 entered the marine service of the Marconi Company. From 1921 to 1924 he was employed as transmitter engineer at RCA transoceanic stations, and from



W. A. R. Brown

1924 to 1927 at the WJZ broadcast station. He became Assistant Station Engineer of the WEAJ broadcast station in 1927 and in 1928 was transferred to the technical staff of the National Broadcasting Company. As Assistant Development Engineer, Mr. Brown has conducted extensive correlation studies of short-

wave transmission and solar activity. On April 1, 1941, Mr. Brown transferred to the RCA Frequency Bureau. He is an associate member of IRE and of AIEE.

George M. Nixon

Engineering Department Veteran of Thirteen Years Appointed Second in Command of NBC's Development Laboratory

George M. Nixon's academic work was done at Pratt Institute, from where he graduated in 1927, and at New York University. His first experience was gained in the operating department of the Electric Storage Battery Company which



George M. Nixon

he left in 1928 to engage in general broadcast development work for the National Broadcasting Company. On April 1, 1941, he was appointed Assistant Development Engineer and supervisor of the activities of the Development Group. Mr. Nixon has been co-author of several technical articles which have appeared in the Journal of the

Acoustical Society of America and the RCA Review on such subjects as "Broadcast Studio Design", "Variation in Absorption Coefficients as Measured by the Reverberation Chamber Method", etc. He is a Fellow in the Acoustical Society of America and a Member of the American Institute of Electrical Engineers and the Institute of Radio Engineers.

Edward C. Horstman

Unanimously Elected to Journal Staff by Board of Trustees



Edward C. Horstman

On Wednesday evening, April 23, 1941, A.T.E. Journal Trustees R. W. Clark, F. R. Rojas, G. M. Sellar, G. E. Stewart, and E. Stolzenberger met in regular session and unanimously elected Edward C. Horstman to the A.T.E. Journal staff as Director of Sales & Promotion, effective immediately.

For the benefit of those who have recently, or will soon hear from our National

President in his new capacity, Ed Horstman is a native of Grand Island, Nebraska, and has actually "grown up" with American Broadcasting. Twenty-five years ago, he started out as a Morse operator. He followed this career for ten years, and then joined the NBC Engineering Staff at its Chicago office, where he has earned the trust and esteem of his fellow-workers. All who know him admire his boundless energy, dynamic personality, and above all, his sense of fair play and understanding.

We are very happy to welcome Ed Horstman to the Journal Staff, knowing that he can and will produce—in conjunction with the entire staff—a better A.T.E. Journal, Of, By, and For the Broadcast Engineer.

At this same meeting of the Trustees, R. W. Clark, Television Development Engineer, was elected Secretary and Charles W. Phelan, Maintenance Supervisor of NBC's multi-million-dollar Radio City plant, was elected Treasurer.

New York Engineering News

By R. A. Isberg

QUICK, Henry, the Flit! Radio has always been infested with bugs. If a piece of equipment does not function properly, it is said to have "some bugs in it." Likewise those of us who try to keep it working are known as "radio bugs." Radio has done very well in spite of all the "bugs" but at present the "Fly's" are causing it considerable consternation. Radio's best hope seems to be a probable "legal fly swatter" and the support of the newspapers who see in the present plague a threat to the freedom of the press.

New York A. A. Bowling Season Ends



Ed Lowell, Captain of General Service Team No. 1, the League winner for the second consecutive year, being congratulated by George Milne, Chairman of the New York A. A. Bowling League. The winners beat the Engineering Team No. 2, Captained by George McElrath, by a single game!



Dinner of the New York A. A. Bowling League at the close of the season. Among others, are Al Protzman, Ray Guy, and George McElrath

Navy Duty

Ensign Rodney D. Chipp, USNR, has been called to active duty afloat. He will be given intensive communication instruction at Annapolis and Noroton, Conn. He has previously served two weeks active duty at the Navy's Manhattan communication office. Rod is an M.I.T. man and has been with NBC since 1934. He transferred to television

in 1938, and has filled assignments with telemobile units, demonstration studio and maintenance.

Lieutenant John B. Knight, USNR, is now on active duty with the Bureau of Ships at Washington. He has been at the television transmitter at Empire State since 1933.

Lieutenant Richard W. Pickard, USNR, has been informed that he will be on flight duty at Pensacola. Pic was formerly in the communication reserve but managed a transfer to flying. He has been at Empire State since 1938 and first came to NBC in 1928.

Latest reports of Lieutenants Thatcher and Gurin, who were called to active duty earlier in the year, indicate that the Navy is making good use of their experience. Thatcher is supervising construction in Hawaii and Gurin is in charge of some of the air conditioning installation on board Uncle Sam's ships.

Al Crenshaw, Mr. Hanson's office assistant, has been called to active duty as a yeoman in the Manhattan Naval Headquarters offices. Al's cheerful personality has won him many friends and should stand him in good stead in his new station. His successor, Bill Felmlly, is two years below draft age, hi!

P D A S M

Prevailing Discounts on All Standard Makes! No waiting for merchandise! We supply you immediately from our complete stock — at prevailing trade prices. Some more reasons why radio engineers like to buy at Terminal!

TERMINAL RADIO CORP.

68 WEST 45th STREET
80 CORTLANDT STREET
NEW YORK CITY

Phone for Both Stores: VANDerbilt 6-5050

Who's Who in Chicago

(The Fifth of a Series)

By Tom Gootee



Harold and Marvin Royston

THIS narrative is of necessity two biographies — the story of two brothers: Harold and Marvin Royston. Because the life of one would not have been complete without the other, and because the elements of fate and coincidence contrived to bring them together whenever they strayed apart. In fact, this recurring coincidental feature is probably more amazing than anything else that happened during their respective lives.

Harold was born in January, 1908, and brother Marvin first saw the light of day some two years later. During the first two decades of the century the Royston Family moved from town to town in northern Missouri and Illinois, seldom spending more than a year in one place. Yet despite this, both brothers managed to acquire a good education.

It was the younger brother, Marvin, who first began tinkering with radio. He obtained a Ham license in 1925, and then spent most of his spare time working with the rig W9-CRL and building small crystal receiving sets to sell to his friends and neighbors.

Harold had no interest in his brother's "gadgets", and spent his vacations and extra time working variously as an auto mechanic, an ice man, and a railroad mechanic for the C. B. & Q. After completing high school in 1926, he spent a year at Mount Morris College — rounding out his education.

Early in 1927 Marvin obtained his first Federal Operator's License, and when summertime approached his thoughts turned to an operating job on one of the lake cruise boats. He contrived to be excused from the last month of school work, and went to Chicago. There he signed aboard the S.S. *Puritan* — his first operating position.

The *Puritan* was a passenger ship that plied between Chicago, Mackinac Island and Buffalo — making a round trip in

about a week. The equipment consisted of a 1/2 kilowatt tube-revamped spark set under the call: W-D-U. There were two operators aboard the boat — for continuous watch — but there was very little work of any kind to be done. As a matter of fact, Marvin went out of his way to find work. He made numerous improvements in the regular communications equipment, and built a complete new Direction-finder for the Skipper!

It was quite an exciting summer for seventeen-year-old Marvin Royston, and when September came he was reluctant to return to school and such mundane things. Upon his return home, however, he must have used a good sales talk on his brother, for within a few months Harold became interested in radio, and moved to Valparaiso, Indiana, to attend the Dodge Radio School during the winter and spring of 1927-28.

Harold obtained his Federal License in the spring of 1928, and immediately began laying plans for a summer job on the Great Lakes. Marvin also had the same idea, and the two met in Chicago and signed aboard the S.S. *Puritan* — the second season for Marvin.

It was an eventful four months for both boys, and they frankly admit it was more of a vacation than actual work. Marvin conveniently "broke in" his brother to the ways and means of ship operating — and in no time at all, it seemed, September arrived and the *Puritan* went out of service.

But the fever of wanderlust had bitten them during the summer, and their thoughts turned toward the Atlantic seaboard — where operating berths were not seasonal. With the momentous decision made, they bought a second-hand Model-T Ford for fifty dollars and journeyed slowly but uneventfully from Chicago to New York City.

At 326 Broadway they ensconced themselves in the far-famed "Static Room" of the R.C.A. offices — and

waited. They both had a desire to "see the world" or, at least make a few trips across the Big Drink. But with no such jobs forthcoming — after a week or so — they began wondering about any kind of an operating berth.

Finally they were offered separate jobs with the venerable Bull Line. It meant a split-up of the "Royston Combination", but both boys accepted. Harold sailed aboard the S.S. *Eastern Temple* — a sulphur boat bound for Galveston. And Marvin sailed aboard the S.S. *Ruth* — another sulphur boat bound for Puerto Rico. Both ships were equipped with one kilowatt spark sets, and the two brothers kept in touch with each other until they ran into a bad hurricane off the Virginia coast.

Harold's boat, the *Eastern Temple*, fared badly in the storm and lay anchored off Charleston for two days with all pumps broken — and the water rising slowly but surely. In time, however, the pumps were repaired and the ship patched up. From Charleston it proceeded around Florida to Galveston.

In the storm and excitement Marvin had lost all contact with his brother, and later efforts to communicate with Harold were unsuccessful — due mainly to the poor receiving sets on both ships. The *Ruth* was proceeding southward off the coast of Georgia when the Bull Line ordered the ship to change its course for Galveston, and a week later Marvin and Harold were surprisingly reunited at that port.

Both ships loaded sulphur at Galeston for Norfolk, and the two brothers met again at Hampton Roads, Virginia, a few weeks later when their ships arrived in port almost simultaneously! There they quit their jobs together, and journeyed overland to New York.

Back in the "Static Room" they waited for more lucrative and interesting work — but without much success. Marvin was in favor of waiting weeks, if neces-

sary, for a good long-distance freighter, but Harold finally decided to take a job on a trawler out of New London.

Harold's decision meant another "break" between them, and Marvin went down to the boat to see his brother off. Tuning around on his receiver a few days later, Harold was just a little surprised to hear Marvin on another trawler of the same fleet—less than half a mile away! Marvin had signed aboard a sister ship at the last moment.

But they both regretted their decisions after the first month of rocking back-and-forth off the Connecticut coast, and they finally quit—together.

Back in New York they were more determined than ever to get long ocean jobs, and their patience was finally rewarded. Marvin signed aboard the S.S. *American Merchant*—then making regular round trips between New York and London. Harold accepted a position on the Export Line's S.S. *Executive*—scheduled for a Mediterranean run.

Most of the way across the Atlantic the two operators kept in touch with each other, but finally the distance became too great. And while Marvin made two round trips to London, Harold visited Gibraltar, Marseilles, Genoa, Naples and Messina—and then back to New York.

They arrived in the United States within two days of each other—in the spring of 1929. Then, while Marvin made another trip to London on the *American Merchant*, Harold made a coast-wise trip aboard the *Executive* to Wilmington, Charleston, Boston, and back to New York. The two brothers arrived back in the big city on the same day, again reunited by coincidence!

The *Executive* was set for another lengthy Mediterranean cruise, but Harold had had his fill of the open sea. He quit the ship, and loafed around New York while Marvin completed another trip to London and back on the *American Merchant*. Then Marvin left his berth, and the two turned westward with thoughts of the approaching summer cruise season on the Lakes.

They journeyed to Chicago, but were not so fortunate in landing a dual berth as they had done the year before. Harold signed on the old S.S. *Puritan* with a new call: W-A-D-X. But Marvin took an operating job on the S.S. *North American*—another cruise passenger boat—with the call: W-T-B-A.

Occasionally they met in port when the two ships crossed routes—but they kept in touch with each other over the air, until the season ended in September.

Then Marvin decided that a little

higher education wouldn't do him a great deal of harm, and he enrolled at the University of Illinois—where he studied for a year and a half.

Harold had other plans. He first worked at W-G-O, the RCA Communications Coastal station at Chicago, for several months. Then he accepted a job at the W-L-S transmitter at Crete, Illinois.

At that time W-L-S had its own transmitter, although it shared air time with W-E-N-R. He fulfilled the role of transmitter engineer from then until the spring of 1931, when the equipment was consolidated with the W-E-N-R transmitter.

Left without a job, Harold first worked at W-G-O for a few months as a relief operator, and then signed aboard the lake boat S.S. *Manitou*. Then, in July of 1931, he heard that NBC was looking for operators. He applied for a job, and was accepted in July—where he has since remained.

Marvin, in the meantime, had completed his school work at Urbana, Illinois. During the summer of 1930 he worked on the S.S. *North American*—not only operating, but also publishing the ship's newspaper! He returned to school that fall, and then felt the University of Illinois the following spring. He came to Chicago and worked on the Dredger *Sandmaster* for several months, and then aboard the *North American* during the summer cruises. When the tourist season ended in September, Marvin went up to the new NBC offices and applied for a job. He was accepted, and started his NBC career just two months after his brother Harold.

From that time in 1931 until now the two brothers have had thousands of hours of broadcast programs running under their respective controls. Harold will complete his tenth year in the Field Department at Chicago, next July, and has put on the air every conceivable kind of special event and field broadcast—ranging variously from the 1933 World's Fair Clambake, through the Ohio River Flood of 1936, and including all the assorted commercial field programs that keep him moving all over the Middle West. Marvin, a studio engineer until the last few days, finds most of his time taken up with recording work.

And so each of the two Roystons have since gone their respective ways—with different homes, different interests, and different work. But whenever they occasionally meet, there must be an exchange of latent understanding between them—harking back to the rollicking days when coincidence kept bringing them together

To Serve Well the Professional Radioman

CREI Puts *Facts* INTO WORDS



8 Complete Laboratories and Modern Equipment of the CREI RESIDENCE SCHOOL Are Used to Prove and Improve Each Lesson Included in the CREI Home Study Course

A total of 2700 sq. ft. is devoted to these laboratories:

MAIN EXPERIMENTAL LABORATORY
STANDARD FREQUENCY LABORATORY
TRANSMITTER LABORATORY
SHOP PRACTICE & WIRING LABORATORY
BROADCAST LABORATORY & STUDIO GROUP
TELEVISION LABORATORY
GENERATOR AND POWER LABORATORY
ADVANCED EXPERIMENTAL & AUDIO LAB.

What do these extensive Residence School facilities mean to the Home Study student?

They mean that lessons are not only based on theory, but also practicability and usability, as determined by tests made upon the Residence School Class of Students.

They mean that faculty members are constantly applying new theories and putting TECHNICAL FACTS INTO UNDERSTANDABLE WORDS!

They mean that this Residence School background protects and increases each investment in CREI training, by providing up-to-date lesson texts developed in our laboratories—keeping pace at all times with the forward surge of the industry.

They mean that based on this scientific foundation, CREI offers the only high-type course of its kind in advanced Practical Radio Engineering.

These facts are important to you . . . and to EVERY MAN who is seeking a way to improve his position in the radio field. We will be pleased to send our booklet and pertinent facts on request.

"Since 1927"

CAPITOL RADIO ENGINEERING INSTITUTE

E. H. RIETZKE, Pres.

Dept. AT-5, 3224 - 16th St. N. W., Wash., D. C.

STRIPERS

on the

Eastern Seaboard

By
Serge de Somov



Serge de Somov, John Rodenbach, and Mrs. de Somov

IT HAPPENED all of a sudden, just as we anticipated it . . . The big spring run of Striped Bass was finally under way.

My better half, Rode and I were gathered around a beach fire discussing fishing conditions of the day, and a little peeved about the disagreeable cold, when at 12:30 according to the well-publicized Bulova Watch Time on my left wrist, my rod, which rested in a sand spike some twenty feet away, started to nod violently toward Europe. The signal was all but too clear—my few jumps from fire to rod were record-breaking if not comical. The ever-increasing pulsations of the tip ran second only to my heart's beats. I forgot about cold, and all my thoughts concentrated on that first line of enormous breakers—the danger spot where you may easily lose an improperly hooked fish. But it ended well. I beached a 7½-pound striper. The first striper of the year caught from the surf by a member of the N.B.C. or W.O.R. Fishing Fraternity (F. F.) By the way, there are some subdivisions of this great fraternity: (a) the F.W.F.F., fresh water fishing fraternity; (b) the S.W.F.F., salt water fishing fraternity; (c) the S. and W. F. F., guess yourself. I say it with pride—I belong to the last one . . . It seems to me that any arguments between members of different divisions of the above-mentioned F.F. as to whether fresh or salt water fishing is real fishing—are, really, just for the sake of argument. Of course—Flounder Fishing . . .

Well—five minutes later my better half got hooked into, and successfully beached, another striper—a 6½-pounder; then another one; then I got a 6-pounder; then, finally, came Rode's turn. Spitting on the worm helps. I got a third one

from the same spot, and Rodenbach his second. Then the run ended. I moved a quarter of a mile away. The real fun started then. A 250-foot cast into the third line of breakers over the sandbars brought me almost immediately a beautiful strike followed by a Tarpon-like display of jumping of the silver Striper in the air. This time—a 10-pounder—3 minutes for that. Then another, another, and finally another one until Rode arrived with some bait, for I had none left. Then we both proceeded to actually murder them. Murder with a vengeance . . . I got four more, one of them a jumper of 10 pounds. Rode beached three more. Then we stopped; we had no more bait, and the prospect of carrying all this fish over a distance of one-half mile to the car was not so agreeable.

It was 6:45 p.m. when we gathered around the car to take the photo which accompanies this article. The score was: Serge de Somov (The Master), 11 fish; John Rodenbach, 5; Louise de Somov, 2 stripers. The stripers ranged in weight from 6 to 10 pounds each and were caught in West Hampton, Long Island.

It is interesting to note that this was the first big "kill" of the season along the whole Eastern Atlantic coast.

On the way home we stopped to drop a fish at Charlie Berdan's, a friend of mine, an old timer, veteran of Montauk Striper Fishing. The latter recalls the days when (some 30 years ago) he had to take horses in East Hampton to reach the Montauk Fishing Grounds. In those days commercial striper fishing was very little known and, consequently, stripers had a chance to grow up; any striper weighing less than 15 pounds was called a "surf rat."

After having distributed some fish to friends in the Riverhead Area and after a hearty supper in our Middle Island cabin we proceeded home to N. Y. On the way we stopped at Kew Gardens at Yoichi Hiraoka's to give him a fish. He is the Hiraoka, ne plus ultra xylophonist, you so well know. I happened to start him in this magnificent sport of surf casting in 1936. This, mind you, was 1:30 a.m. Well, Hiraoka had just motored home from a concert he had given in Massachusetts; he was all in, but upon seeing the fish all he said was: "Where" and "When." As his wife told us on the phone the next day—Yoichi could not go to sleep at all, he was too excited. Instead he got all his fishing paraphernalia into the car, and at 6:30 a.m. he was already fishing at the Westhampton Beach. He did get four stripers. Sic.

Those of you, dear fishermen, who have this Divine Spark will not condemn Hiraoka's actions.

It is very gratifying to state that our army of surf casters is increasing in numbers quite rapidly. From the basement of the R.C.A. building to the top of the Empire State—you'll find them . . . In the latter building you will meet the one and only Vincent Barker—M.S. and F.W.F.F. who last year at Tiana Beach gave me a good lesson in striper fishing by beaching four in a row while none of those present on the beach, including your humble servitor, had any . . .

There must be something rather sinister and mysterious in the fact that Christopher (Maintenance Chief) does not say anything about his exploits in surf fishing as yet. I saw with my own eyes his beautiful Canton bamboo rod and brand new Capitol reel. Yes, yes—he must know some secret hole or sand bar where he expects to astonish us with a 74-pounder some day. (The world's record is 73 lbs.) Mac Queen is following in his boss's footsteps (without surf boots, though). Red Shultis is unfortunately too busy, but he just the same recently acquired a new spool of No. 9 line. And as for Champion Jimmy Carter of W.O.R.—he still thinks that last September's kill in the Cape Cod canal is sufficient in its intrinsic value to enable him to lay off for a while.

Oh, yes. Another change from just F.W.F. to S. and F.W.F.—Bob Ward, S.E. In our salt-water ranks we include Bill Pooler, Don Abbott, Bob Johnston, papa Bill Kelly, Alex Horwath, and Ewert, who just left us to join the Navy.

We still have hope that the dyed-in-the-wool fresh-water fishermen Doc Dickson and Harry Hiller will soon change their minds and utter a kind word for Salt Water Fishing. May be our colleagues in San Francisco could help me in this matter by writing a line in the Journal.

I am not asking the Hollywood crowd of Mountain and Kerosene water fishermen to contribute to this coaxing of Dickson and Hiller, for I know them as absolutely incorrigible Fresh Water men. (Bob Brook note.) To you Westerners I say: Have you done any tip-up fishing this past winter? We *have*. But let us not start a feud.

Meanwhile the spring striper run in the Atlantic States is under way.

HAVE FUN THIS SUMMER

with the
**ABBOTT DK-3
2½ METER
TRANSCEIVER**



Have fun, wherever you go, with this self-contained battery operated ultra high frequency radiotelephone transmitter-receiver. Working 2½ meters is all the rage this season. This reliable, inexpensive portable unit offers clear, powerful signal reception and transmission on 112 to 116 Mc. band and features inductive antenna coupling variable from front of panel. Works equally well in car, boat, plane or field. Employs 1-6J5GT and 1-6G6G; three 45 V. B batteries and four 1½ V. batteries. Extremely small and compact, measuring only 11"x11"x4½". Sbp. wgt. 11 lbs.

Call, write or phone for full particulars

NEW MEISSNER F/M RECEPTOR

This complete, self-powered 8 tube converter adds stateless F/M reception to any standard radio receiver. Easily connected to phono or television terminal. Features 3-gang ceramic condenser, magic eye for perfect tuning, sliding rule dial, attractive polished walnut cabinet. Excellent tone quality and power output. Size: 13"x7"x6¾". For AC-DC operation.



BOTH ITEMS IN STOCK and ON DEMONSTRATION
— SEE and HEAR THEM TODAY —

SUN RADIO CO.

212 FULTON ST.
NEW YORK CITY
Phone: BArelay 7-7647

HERMANN FLOREZ

Consulting Radio Engineer

Directional Antenna Design

Construction

Equipment Analysis

Field Intensity Surveys

3201 Glenwood Road

Brooklyn, N. Y.

Denver News

By Joe Rohrer

THE affect of national defense has been felt at KOA with the loss of Al McClellan to the Navy. Mac was first class radioman in the reserve and is now stationed at a land base in Hawaii. Mrs. McClellan and son are to join him soon. He operates K6KQK on 20 and 40 meter CW. W9FA is maintaining schedules.

Glenn Glasscock has been promoted to status of Senior Lieutenant in the Naval Reserve. He expects to go into the service at any time. Glenn is fortunate that his vacation schedule was completed before getting his call to service.

J. E. Carpenter has joined the studio staff. Gene comes from KFEL, Mutual affiliate at Denver. Operates W9ZBN, is quite active on 20 and 75 meter phone with 300 watts power. I can recommend him as a good pole sitter as he hung some guys (!—Ed. S.) for me during a spring rain storm.

D. D. Kahle is working summer vacation relief at the studios. Took over a full time platter spinning job after

two days, due no doubt to his experience at KLZ, Columbia affiliate, Denver. "Pinky" is a very handsome lad with red hair. He is a family man as is Carpenter, with one girl each.

Some time ago we reported the acquisition of a fine kerry blue bitch by Ozzie Austin. He is going to raise pups and make money. The spring atmosphere, or something, has Miss Kerry feeling quite romantic and she has many wooers. Not wishing her to meet the wrong people, Ozzie has thrown up such fortifications as electric fences, anti-airdales, and such. All the skin is off Ozzie's chin. He fell down chasing a particularly persistent mutt. (P. S.: Latest communique from the front indicates that Ozzie has capitulated to the mutt. Anybody want a mutt-kerry blue? See Austin).

STAN NEAL HAS FORSAKEN ALL ELSE AND IS BUILDING A BOAT. It is a fifteen foot job for an out-board. Doing a beautiful bit of craftsmanship. He talks such terms as "Garboard strakes, chine battens." If he just had even a small pond to sail it in we could understand it. What will he do with it out here in this dry country?

This will announce the arrival of baby girls to Vern Andrews and Stan Neal. Somewhat late with the news as they were both born in February within a week of each other. Do you suppose Stan and Vern talked the thing over carefully? I didn't hear of any bet. They both live near the same firehouse, though.

Active ham stations in Denver are W9FKQ, W9ZBN, W9FA, W9ZEA, W9CZR, W9EYN. All but 9FA are on 20 phone which is the best bet for summer communication. Amateur activity was stimulated some by the erection of a 105 foot tower at W9EYN. An extension was added to the old one. It now supports an extended double zepp on 75 meters, a vertical for 75 meters, and an all band Hertz. A 20 meter V beam 555 feet on a side will be up soon pointed at N. Y. Power gain is theoretically 30. For those of you that have been asking, Russ Thompson will soon be back on the air with W9KQW and some new fixings.

We all regret that more could not be done for Justus Allen of N.Y. television who passed away here following an operation on a brain tumor May 3. With Allen at the time were his brother and Harold Austin of KOA staff, a friend of Allen's Chicago days.

**Prompt, Intelligent Service on Any
Radio Part, Receiver, or Problem**

TECHNICAL EQUIPMENT COMPANY

Telephone:
WOrth 2-1895

135 Liberty Street
New York, N. Y.

FURNITURE

By special arrangement with many of the leading Furniture Manufacturers and Distributors, furniture of **ALL** kinds may be bought thru us at near factory cost by obtaining our signed order. Terms arranged.

GOODRICH TIRES

Batteries and tubes can be purchased on our signed order at **CONFIDENTIAL DEALER PRICES**. No charge for mounting.

KEECH SERVICE

170 BROADWAY

Phone LExington 2-1100 (Twenty-four Hours a Day)

Chicago Radio Distributor Weds

Following the recent announcement of his marriage, Sam Poncher, president of Newark Electric Company, prominent Chicago radio distributor, was treated to



Reading left to right in the photograph are: W. S. Hartford, Sales Manager Thordarson Elec. Mfg. Co.; Sam Poncher, President Newark Electric Company; W. J. Halligan, President The Hallicrafters Company; Arthur Schmidt, President American Phenolic Company; Sid Shure, President Shure Brothers Company

a surprise party at the Lake Shore Athletic Club.

Over fifty of Chicago's radio notables turned out to wish Sam good luck on

his matrimonial venture. One of the highlights of the evening was the presentation of a completely outfitted portable bar to Mr. Poncher. The presentation was made by W. J. Halligan, president of The Hallicrafters Company of Chicago.

True Fidelity for the Home

Sun Radio Co., 212 Fulton Street, New York City, in cooperation with several leading manufacturers, has developed two basic home fidelity musical reproduction systems that offer "studio-like" qualities and which should prove of interest to all true music lovers.

A De Luxe Series system features a high fidelity studio amplifier exclusively designed for Sun Radio by Webster-Racine, used in conjunction with a new and improved 1941 version of the Miller R. F. tuner and the latest Cinaudagraph 12-inch woofer-tweeter speaker combination.

An Economy Series system employs a new Mercury Hi-fidelity amplifier as the basic foundation with the Miller tuner and the famed Jensen MT-8 Bass Reflex Reproducer as its complement. Supplementary or auxiliary equipment such as an automatic record changer, a record

player, a recorder or an F. M. tuner may be added to either system as desired to provide unsurpassed beauty in musical entertainment. A custom-built console cabinet, with record compartments, designed to accommodate the aforementioned equipment, is available in a choice of plain, unfinished pine, brown leatherette covering, walnut, or mahogany.

Interested persons may obtain a complete description of this equipment by writing Sun Radio Co. for a free copy of Supplement No. 102A.

W. J. Halligan Appointed to Chicago Commission on National Defense

The appointment of William J. Halligan, president of The Hallicrafters Company to The Chicago Commission on National Defense has been announced by Chicago's Mayor, Edward J. Kelly. Mr. Halligan served in the communications division of the Navy during the last World War and during the conflict was assigned to a mine layer operating in the North Sea. At the close of the war he attended West Point and is an active member of the West Point Club of Chicago.

DO IT NOW

Don't Overlook This Excellent Buy!



\$1.50 Will Bring YOU the Next Twelve Issues of the A.T.E. Journal — Bigger and Better Than Ever!

— OR —

Save yourself some money — and us some bookkeeping, and send ONLY \$3.00 for a 3-Year Subscription to the A.T.E. Journal — Of, By, and For the Broadcast Engineer.

.....
Name

.....
Address

.....
Name

.....
Address

Make checks payable to "A.T.E. Journal"

Courmettes & Gaul OPTICIANS

55 West 49th Street
R. C. A. Building, New York
Main Floor

EYE EXAMINATIONS

Prescriptions Filled . . . Prompt Repair Work

PATERSON:
79 Bridge Street

NEW BRUNSWICK:
54 Albany Street

AARON LIPPMAN & CO.

246 Central Avenue

Newark, N. J.

Leading Radio Equipment Distributor of New Jersey
Prompt Service at No Extra Cost

RIDING GAIN

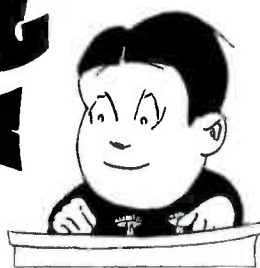

ON THE AIRALTO WITH TONCOOTÉE

THE art of producing realistic sound-effects for radio broadcasts has become an exacting science. A good sound technician can often do much toward making the play or sketch more "realistic," and he is as important to dramatic and action shows as the actors themselves.

In general there are two types of sound-effects: "manual" sounds actually made by the operator, and "mechanical" sounds which are recordings. The use of records is both convenient and labor-saving, and about 60 per cent of all sound-effects used on the networks is made up of these recorded or "mechanical" sounds. There are actually over 5,000 different kinds of recorded sound and, of course, an unlimited number of "manual" sounds which can be made. The most used recordings are of automobiles, general outdoor noises (for forest backgrounds), and trains and airplanes. "Manual" effects most often used are the opening and closing of doors, telephone and doorbell ringing, and human footsteps.

The hardest sounds to reproduce are, strangely enough, some of the most common noises we hear outside of radio. It is difficult to duplicate the noise made by a match dropping in an ash-tray, a dog walking across a wooden floor, a caged animal of any kind, or the human heartbeat. Rain and other water effects are often hard to reproduce, as are glass crashes, and the simple sounds of cooking: breaking and frying of eggs, frying bacon, percolating coffee, and others. The illusion of walking on snow is produced by crunching corn-starch flakes together. Bubbling lava from an erupting volcano is simulated by boiling oatmeal over a hot fire. The sound of an old Ford car may be made by attaching a mike to an old sewing machine, or an old washtub (filled with tin cans, etc.) may be jiggled and rotated by a motor with a bent drive rod.

Once in a while a heavy dramatic show may require as many as three or four sound technicians in order to pick up all the desired "sounds" in the microphone. A recent *Authors Playhouse* show, "High Air," required three men to recreate the effect of subway tunneling (digging, blasting, riveting, oozy mud, shaft elevator, air lock, etc.) under ground. The *Gangbusters* programs are generally lively with sound aplenty in pistol-shooting and automobile (recorded) effects.

* * *

Pat Barrett [Uncle Ezra] sends word to the boys "down the line" that, contrary to Federal reallocation of most radio stations, his five-watter station EZRA is still operating with its customary infrequency.

Don McNeill—m.c. of the morning Breakfast Club—has named his new suburban home: *Lumbago Manor*. When pressed for an explanation he said it was because it had a creek in the back.

* * *

Radio schools in the United States are now training more men for radio than ever before. The need for operators and technicians has become more acute with each passing day, in both professional fields and for service in the army and navy. The Capital Radio School in Washington recently purchased all of the old equipment and studios of WMAL—when that station removed to new quarters—that the school might have additional training space for its students. And the RCA Institutes in Chicago report several hundred available radio jobs in that vicinity that *cannot* be filled—due to the lack of trained, experienced labor. Don't look now, but we think Prosperity just staggered around the corner.

* * *

One of the very first radio news commentators: Frederic William Wile, well known as an outstanding newspaperman and journalist, died last month at the age of 67. Mr. Wile was indeed a seasoned veteran of radio; back in 1923 he first entered radio with short talks over WRC, in Washington, later joining NBC, and still later joining CBS.

* * *

The "Applause Meter" used by NBC on "Truth and Consequences" and other audience participation shows, "measures" the amount of applause by the sound level of the hand-clapping. It is actually a highly-damped voltmeter used as a volume indicator. The meter itself has a full range of about 17 db, and by the use of an attenuation network the operating range can include levels from 65 to 122 db—acoustic levels. The gadget is accurate, but the readings can only be made on a comparative basis—one burst of applause as compared with another.

* * *

The nightly Alka-Seltzer "News of the World" show—usually involving several overseas pickups during each broadcast—is one of the most unpredictable and variable of NBC services to both sponsor and listener. Atmospherics often prevent good reception from abroad—despite RCA's super-super-directional antennae and diversity reception. There promises to be plenty of action in the Far East soon, and NBC reporters are already on the scene in that powder-keg region. Under Abe Schechter's supervision, broadcasts can

soon be expected from Changhai, Tokio, Singapore and Manila—with several other NBC roving correspondents in all the hot-spots of eastern Asia just waiting.

* * *

Eddie and Fanny Cavanaugh are rounding out some 18 years of radio service in Chicago this month, having appeared on practically every local station in the city at one time or another—and still going strong with their chatter-and-gossip program!

* * *

America's Town Meeting of the Air will be heard for at least another five years over the networks. The *Town Meeting* is a unique show in that it is strictly uncensored, unrehearsed in any way, unsponsored and definitely non-partisan. The first program was heard over NBC on May 30, 1935, and within a few months rose quickly to be the most popular sustaining radio forum on the air. It is doubtful whether any other program could have done so much to promote serious thinking upon issues of national and international importance.

* * *

Ted Steele, ex-NBC page boy, seems to be going places in a big way in music. After waxing several records for Decca with his novachord, he has now formed his own orchestra—still featuring his novachord instrument—and will soon be a full-fledged band leader in his own right.

* * *

And speaking of music, weirder and more frightful musical effects can be expected any Sunday night during the *Inner Sanctum Mystery* tales. Charles Paul, who makes an organ wail like a banshee, has formed a six-piece (alleged) orchestra which will supply the musical, creepy background. Arrangements involving odd effects with a bassoon, oboe, clarinet, French horn, trumpet and organ promises to scare you—even if the play doesn't.

* * *

According to compilations released by the Labor Department late in April, individual workers in radio broadcasting receive a higher *average* pay than workers in *any other industry*. This includes, of course, other branches of radio—in addition to engineering and operating. An average of well over \$42.00 per week is paid to radio employes, contrasted to \$41.78 to workers in the machine tool industry, \$40.05 for automobile employees, and \$38.42 for workers in the printing and publishing trades.

* * *

Have you heard the story about the radio engineer who dreamt he was in the midst of a difficult ten-fader commercial broadcast, *and when he woke up he was?*

* * *

Ten Years Ago in Broadcasting. You might have tuned in and heard the new Rudy Vallee Variety Program, or Hank Simmons' "Show Boat." Floyd Gibbons was going great guns with rapid-fire accounts of foreign adventure and travel. Amos 'n' Andy were winning most radio popularity

polls by a landslide, and some of their current expressions—like "Ise regusted" and "Check and Double-Check"—were becoming a fixed part of the nation's vocabulary. If you preferred more serious entertainment you might have listened to the Theremin Electro-Ensemble—a trio of weird-looking, strange-sounding electrical musical instruments. The thrice-weekly Lucky Strike Dance programs—under the direction of B. A. Rolfe—set aside several minutes each broadcast for a Broadway columnist, Walter Winchell, and his news commentaries. Two of Winchell's contemporaries: Louis Sobol and Ed Sullivan, were being featured respectively on WOR and the CBS. And by May of 1931 the Depression had definitely arrived!

* * *

Twenty Years Ago in Radio. The only consistent reception possible—for those amateurs and experimenters owning short-wave—were the "hams" operating variously below about 200 meters. DX over 500 miles was phenomenal for all amateur reception, and usually meant long hours patiently coercing a tiny lump of galena crystal with a piece of brass wire. Those listeners financially able, could purchase complete radio sets *with tubes*—mostly at prohibitive prices—and a few of the sets then available were the Grebe Regenerative Receiver, Frank Andrea's FADA, the Cino Radio (Cincinnati), the Baldwin "Diaphragm" sets, and the infamous Esco regenerative receivers. But probably 90 per cent of all radio sets in existence were home-made.

HEADQUARTERS for Broadcast Engineers

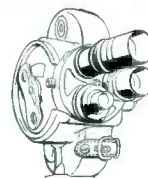

— before making any purchases call or
write your favorite foto supply house . . .

IMPERIAL CAMERA SHOP

6208 Cermak Road, Berwyn, Illinois

Phone: Berwyn 344

Harold Soffer

Compliments

of

HERB RICE

Insurance of All Kinds

Phone

NBC Extension 140

San Francisco News

By Lee Kolm

NOTES ON THE CUFF . . . During April Mr. O. B. Hanson paid SF a surprise visit. His two weeks stay was high-lighted by attending the GE plaque award luncheon for the KGO gang . . . Proving that the 5:45 morning watch is not without its hazards, a negro bandit held up Harry Jacobs, SE, on April 23 and removed eighteen dollars from Harry's wallet. Starting up after a boulevard stop near the SF-Oakland Bridge, Harry was surprised to find a negro beside him and a wicked-looking revolver backing a demand for money. Harry thought it well worth the eighteen dollars to see the bandit put away the revolver . . . The photo-electric alarm at KGO was overhauled by Aubrey Fisher during April after it was found a party had slipped by the never-sleeping guard and found two of the boys with their feet on the desk . . . Ed Callahan, FE, has taken two weeks active duty with the Navy and hopes to have completed his vacation before the call comes for service "for duration." The fifty-six-hour week is rather hard to take after enjoying the forty-hour week per A.T.E. contract . . . Charlie Kilgore, CS, recently supervised the installation of a PA system in the SF Press Club. The boys understand he'll take his wages out in credit at the renowned bar! . . . The Bal Tabarin Cafe (send in their advertising copy—Ed. S.) will be the locale for our annual Ladies Night. Red Sanders, FE, and Frank Barron, SE, will be in charge of the arrangements . . . Week-end crashes on the highway adjacent to KGO transmitter ease the monotony for Myron Case, ME, and from reports his first aid instruction has come in mighty handy . . . Guy Cassidy, SE, has started construction of his new home in Redwood City and is kept busy with the multiple chores of contractor, carpenter and painter . . . During April the control room enjoyed the visits of Craig Pickett and Steve Hobart, both Hollywood supervisors and ex-San Franciscans . . . With his old home town the center of a building boom, Dick Parks, KGO, is anxious to get back for a visit this year. He plans to drive to Corpus Christi, Texas, for the three-week vacation . . . Cliff Rothery, SE, has developed his gardening hobby to the point where he now plans to become a member of the SF Wholesale Florists group. The fancy flowers he has been growing bring top prices from the local shops . . . With his well down nearly fifty feet Bev Palmer, CS, should soon be hitting a good supply of water. Following the advice of Cassidy, Bev also dropped a wrench into the well, but on second thought retrieved it, thinking that he'd carried things too far . . . George Irwin, KGO, plans a grand circle trip on his forthcoming vacation. Tour should take him to El Paso and thence to Carlsbad and Rocky Mountain National Parks before returning home via Denver . . . Jimmy Ball, KGO, has gained considerable fame with his home-made hi-fidelity receivers. Everyone who sees the construction claims that the workmanship is par excellence . . .

Three men have been added to the San Francisco staff recently. Richard O'Brien is the former relief engineer during vacations at KPO. He is now a graduate student in electrical engineering at Stanford. From KJBS in SF, comes Kenneth Owen. His past experience includes service with several stations in the Pacific Northwest, including KMO and KGW-KEX . . . The third man is Harold Platt, who became acquainted with the Field group during the Golden Gate International Exposition. His duties were with the Fair's pick-up group. Platt will join us from KOH in Reno . . . The opening of the SF yachting season found Joe Baker's yacht in the parade of nearly 400 locally-owned craft . . . New lawns were seeded by Joe Baker, Bob Barnes, and Mort Brewer of KPO. Now the fight is on to keep the neighborhood dogs from ruining the hard work done on the front yards . . . Rumor has it that Bob Barnes will take delivery on a new car in Detroit during his vacation. Possibly he felt there was too much effort needed to replace the defective muffler on his present car . . . Mort Brewer's vacation will take him to Death Valley, Grand Canyon, and Tucson, Arizona . . . Wouldn't be a bit surprised if Alan O'Neil, Recording, purchased a new car and drove to the Northwest this year . . . Harry Jacobs' vacation will be divided between Seattle and Catalina. Driving first to Seattle for a visit with relatives and then to LA with his yacht (let's have the story and photos—Ed. S.) for a sail to Catalina, Harry will have a busy three weeks . . . Questioned as to why he no longer played golf, Oscar Ber, MS, revealed that three years ago he was struck by a ball and since then golfing held no attraction for him. He still carries a reminder of the accident . . . Jim Summers, CS, was called for active duty in the Navy, but was deferred after a medical examiner reported some back teeth missing. Jim attempted to get flat feet by jumping from his front porch with two fifty-pound weights, but it didn't work! . . . Curtis Peck, engineer-in-charge, was promoted to Lt.-Commander May 1 and is now afraid a Navy call to service will force him to give up the garden he has started in the back of his apartment . . . Mark Dunnigan, SE, has a problem. His berry bushes are becoming infested with numerous bugs, but he is wondering whether the spray will get him when he eats the berries, or will the spray just take care of the pests . . . With George Greaves, FS, again taking up the golf game, we wonder if he will learn to stay on the fairways. Maybe he thinks it's cooler playing golf under the trees in the rough . . . To convince Cliff Rothery that he should buy a movie camera, Alan O'Neil and Lee Kolm packed up their equipment and visited the Rothery peninsula estate. With Cliff furnishing the film the fellows had a time for themselves photographing the many varieties of flowers Cliff raises. Alan and Lee are now awaiting a sponsor so that they will not have to put out any cash for the indoor drama they plan to film.



**READY-TO-BROADCAST
LOCAL PROGRAMS?**

*NBC is
your Answer!*

There are two outstanding NBC services available to radio stations for building audience-commanding local commercial and sustaining programs.

1. NBC Thesaurus. This "Treasure House of Recorded Programs" supplies a wide variety of fine musical material, recorded by popular, well-known artists and ensembles. Weekly continuity for 21 outstanding program series (65 programs a week).

2. NBC Syndicated Program Service. Expertly produced musical and dramatic shows including such successes as "The Lone Ranger," "Betty and Bob," "Secret Agent K-7 Returns," "Time Out with Allen Prescott," "Carson Robison and His Buckaroos," and many more.

**CUSTOM-BUILT PROGRAMS
FOR "SPOTS"?**

*NBC is
your Answer!*

NBC's "custom" recorded program service is complete! It covers writing, casting and production

of shows, in addition to recording, processing, manufacturing and distribution of duplicate pressings. NBC offers its splendid recording facilities—NBC Orthacoustic—plus processing and manufacturing of pressings to agencies that prefer to handle their own program production. And for "Spot" and local advertisers, with their choice of any of 200 stations, NBC Thesaurus and Syndicated programs will do an outstanding sales job at remarkably low cost.

**PROGRAM PLANNING
HELP?**

*NBC is
your Answer!*

NBC's assistance to advertising agencies in the planning of recorded programs includes studios, fine technical service, casting help and other

services. The unmatched facilities of the "Program Center of Radio" are all yours when your show is recorded by NBC. Remember—NBC Orthacoustic gives you recorded programs that literally sound like live studio broadcasts!

AIR CHECKS?

*NBC is
your Answer!*

A great many radio artists have discovered that this excellent NBC service best fulfills their requirements for "off the line" or "off the air" recordings.

Scores of advertisers and agencies, large and small, use all or part of NBC's complete radio-recording service. Let us demonstrate how this outstanding service fits your requirements.



NBC Radio-Recording Division

NATIONAL BROADCASTING COMPANY

A Radio Corporation of America Service

RCA Building, Radio City, New York • Merchandise Mart, Chicago
Sunset and Vine, Hollywood

FOR *Higher Fidelity* AUDIO

THESE TWO



AMPLIFIERS!

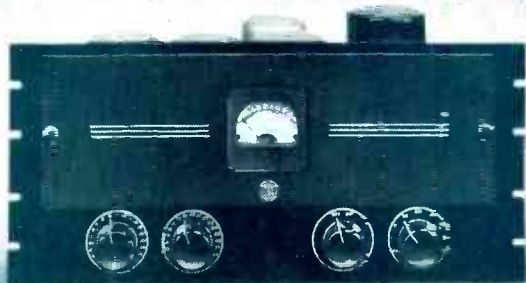

RCA Model 86-A LIMITING AMPLIFIER

- ★ Compression-ratios to 18 db.
- ★ No audible "thumps" on peaks
- ★ Optimum return-time value
- ★ Flat within 2 db., 30-15,000 cycles
- ★ Calibrated level controls
- ★ Meter indicates reduction in db.
- ★ Meter measures plate currents
- ★ Built-in power supply
- ★ Ideal for recording

\$275* with one set of tubes

(Less 36-B Mounting, shown above)

You can raise the average program level of your transmitter several db. . . with corresponding increase in coverage . . . easily and at low cost with this RCA Type 86-A Limiting Amplifier. Protection against overmodulation and transmitter outage is safe and certain—for the 86-A provides fast pickup time. Return time is slow enough to prevent low-frequency distortion, fast enough to avoid obvious level-reduction following a volume peak. Controls are calibrated in VU, to indicate exact input and output levels on the verge of compression. And even with maximum compressor-action suddenly applied, there are no audible "thumps" to mar your program. Write for the complete story of this low-cost, flexible Limiter Amplifier.



RCA Model 82-C MONITORING AMPLIFIER

- ★ High fidelity at low cost
- ★ Flat within 2 db., 30-15,000 cycles
- ★ High gain—105 db.
- ★ Output level: 12 watts (3% distortion)
- ★ Less than 1½% distortion, 50-7500 cycles, 8 watts
- ★ Compensating Network Available
- ★ Built-in power supply
- ★ Remote volume control furnished

\$85* less tubes

(\$15.00 extra for rack mounting)

HERE is an improved version of the highly popular Type 82-B Monitoring Amplifier. Like its predecessor, it affords high-fidelity audio at extremely low cost . . . is flexible and easily adapted to your studio arrangements. Because of its high gain it can be used directly in studio talk-back circuits without preamplifier or for driving speaker directly from turntable. High output level insures low distortion even when feeding into several speakers. Inverse-feedback keeps the overall response low in distortion and unusually uniform in frequency-response.

*F. O. B. Camden, N. J. Prices subject to change without notice.



Use RCA Radio Tubes in your station for finer performance

Broadcast Equipment



RCA Manufacturing Co., Inc., Camden, N. J. • A Service of Radio Corporation of America • In Canada, RCA Victor Co., Ltd., Montreal

New York: 1270 Sixth Avenue

San Francisco: 170 Ninth Street

Chicago: 589 E. Illinois Street

Atlanta: 530 Citizens & Southern Bank Building

Hollywood: 1016 N. Sycamore Avenue

Dallas: Santa Fe Building