

JUNE 1981

\$3.00

# BME

BROADCAST MANAGEMENT/ENGINEERING

NAB

3

SHOW

IN

PRINT

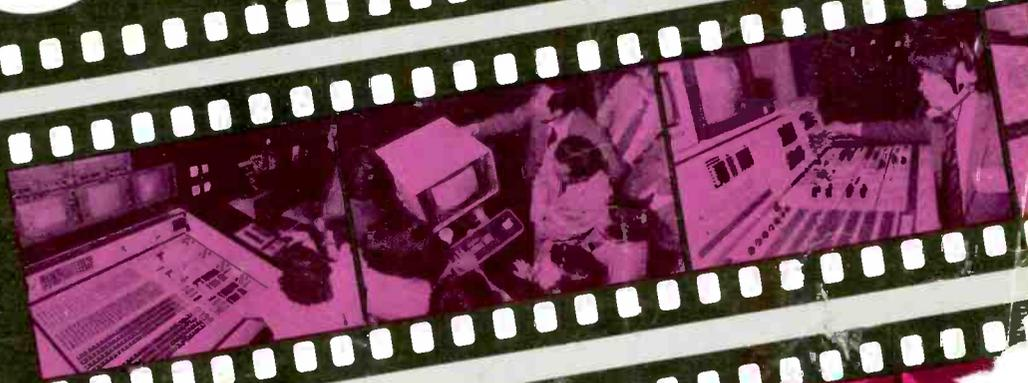

# PROVEN TECHNOLOGY MAKES A WORLD OF DIFFERENCE

NEC is state-of-the-art in transmitters, cameras, digital effects equipment, frame synchronizers, switchers, time

base correctors, 1" VTR's, and earth stations. You can depend on NEC, from ENG/EFP through transmission.

## NEC

NEC America, Inc.  
Broadcast Equipment Division  
130 Martin Lane  
Jive Village, Illinois 60007

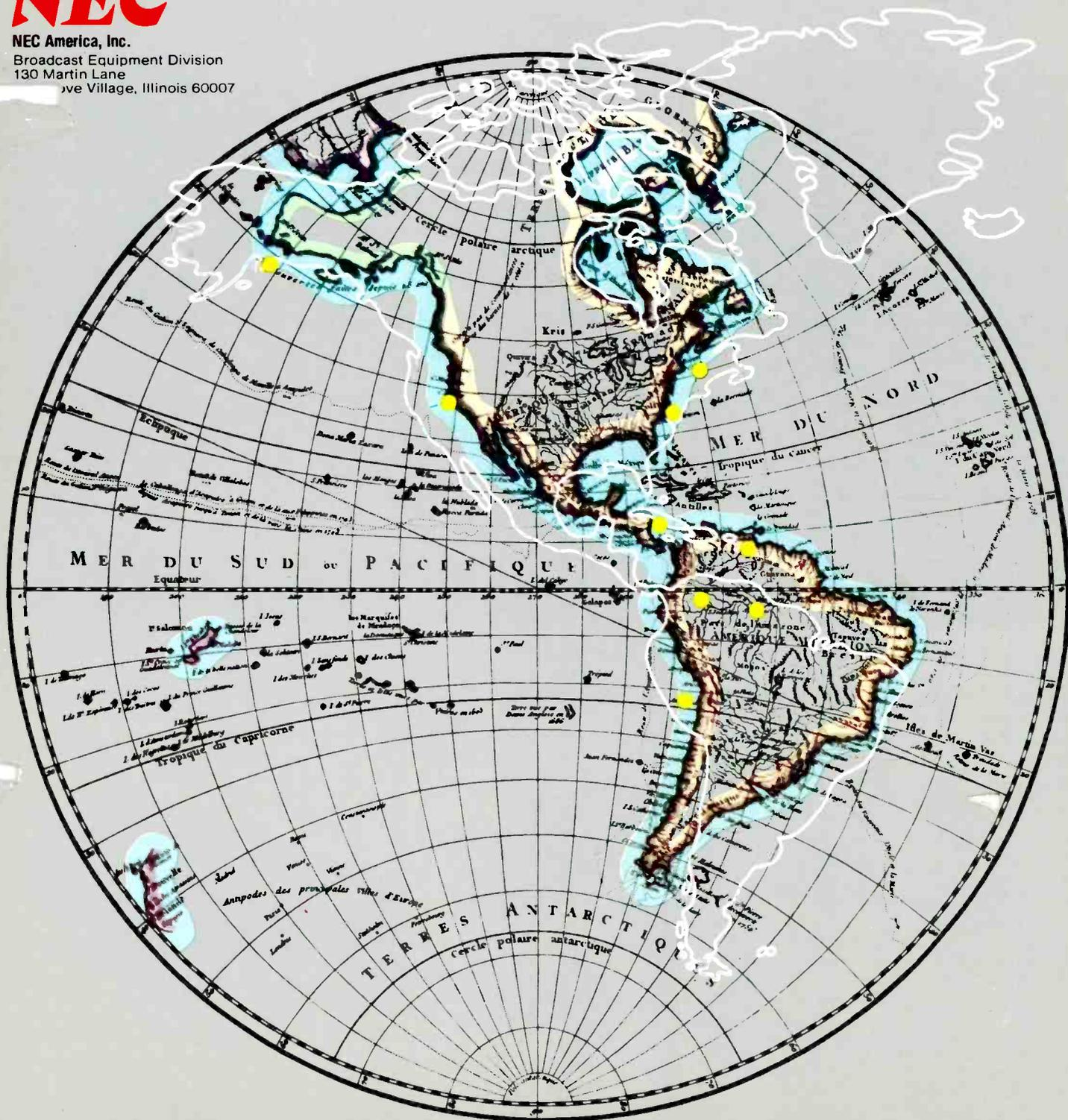



# CREATIVE TECHNOLOGY ON CMX

**Roger Berk, Jr.**  
President, Creative Technology, Inc.  
Vice President, Group One Broadcasting, Inc.  
Akron, Ohio

## "We Designed Our System Around The 340X"

"When we at WAKR in Akron made plans to establish a separate production facility, our goal was to build an organization that was committed to excellence. Our proximity to Cleveland, Detroit, Pittsburgh, and the other large cities of the Midwest made our market area large and competitive. We decided to meet this challenge by offering a facility that not only provided a competent and creative staff but the very finest in technical equipment. We designed our system around the 340X.

"It is clearly the finest computer-assisted editor in the world today. And its versatile architecture assures its place as the leader in future

generations of equipment. With CMX's versatility we have interfaced everything from our computer-assisted production switcher, to our one-inch recorders, computer-assisted audio mixdown system, our multi-channel Squeezoom," and our computer-based animation and character generation system.

"This high level of interface, with the CMX "talking" to the other computers in our control room allows us, with a minimum of multi-generational iterations, to perform dazzlingly complex effects involving up to nine levels of video and up to 18 tracks of audio on each frame-accurate edit.

"Here at Creative Technology, we're

saving time and money with our CMX; but of greater importance it allows us to produce more original and interesting material at a lower cost per spot than could be achieved using conventional techniques. Further, CMX always has one eye on the future, as the system is evolving and improving constantly. We've regularly added the latest software options as they have become available.

"The 340X is a many-faceted and unparalleled tool. It allows creativity to displace technical drudgery in high quality production. We can't wait to get our next one."

TM—Vital Industries



**CMX  
ORROX**  
The World Standard for Editing

**Orrox Corporation**, 3303 Scott Blvd., Santa Clara, CA 95050 (408) 988-2000 Telex 910-338-0554  
Los Angeles (213) 980-7927 / Chicago (312) 325-8488 / New York (212) 371-1122

Circle 101 on Reader Service Card

 **HITACHI**  
Hitachi Denshi, Ltd.

**HR-200**



OFF ON



The control panel features four meters at the top, labeled VIDEO/RF, AUDIO 1, AUDIO 2, and AUDIO 3. Below the meters is a 'RECORD LEVEL' section with four rotary knobs. To the right is a 'RECORD SAFETY' section with a 'NORMAL' position and a 'RECORD' position (indicated by a red light). Further right are 'STANDBY' and 'JOG SHUTTLE' controls. At the bottom are several buttons: 'SERVO ALARM SYSTEM ALARM', 'REMOTE LOCAL', 'TAPE EE', 'VIDEO RECORD SELECT', 'AUDIO 1 RECORD SELECT', 'AUDIO 2 RECORD SELECT', 'AUDIO 3 RECORD SELECT', 'RECORD' (red button), 'PLAY', and 'STOP'.

# Hitachi-5 Competition-0

## That's the score in one-inch VTR technology.

We've gone the first generation of TYPE C machines *five* better ...to help you get all the potential of one-inch out of your video installation. Here's what the competition *doesn't* give you.

### 1. Retracting Tape Guide

Retracts for unequalled ease of threading; repositions with one micron accuracy for up to two million threadings. Provides the reliability of a quad thread system in a one-inch format.

### 2. "PRO" Tape Path

The protective reverse oxide ("PRO") configuration of the tape path means *only* the video and audio heads touch the oxide surface. All other transport mechanisms guide the tape by its reverse side. Result: noticeably reduced dropouts; longer tape life.

### 3. Instant Head Replacement

Pre-aligned head design permits easy replacement of video heads in three minutes. No adaptors or jigs; no adjustments required.

### 4. Audio and Video Confidence

The others only let you *see* what you're taping. We let you *see* and *hear* everything being recorded...simultaneously.

### 5. Non-contact Tape Shuttle System

In shuttle and standby modes, tape rides on a cushion of air. Increases head and tape life immeasurably. Cuts frictional resistance, yielding shuttle times of only 80 seconds end to end.

We could go on. With impressive features like microprocessor control; broadcastable slow motion; one-touch shuttle and jog; front access circuit boards; audio spot erase, and on and on. But why run up the score, when it's already no contest? See the Hitachi HR-200, it's equally impressive portable HR-100 model, and companion TC-200 Time Base Corrector.

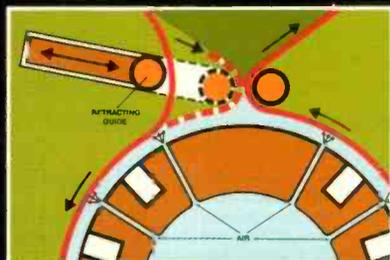

• Tape guide retracts for threading ease • Air drum eliminates head contact in shuttle/standby modes

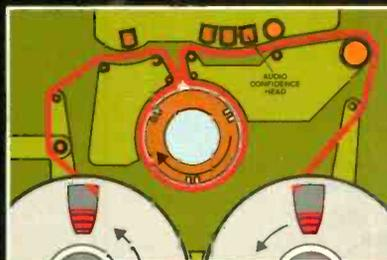

• Full audio and video confidence  
• "PRO" tape path reduces dropouts



Tomorrow's Technology Today

175 Crossways Park West, Woodbury, N.Y. 11797 (516) 921-7200

• New York • Chicago • Los Angeles • Atlanta • Cincinnati • Dallas • Denver • Seattle • Washington, D.C.

Circle 102 on Reader Service Card

# BM/E

BROADCAST MANAGEMENT/ENGINEERING

JUNE 1981/VOLUME 17/NUMBER 6

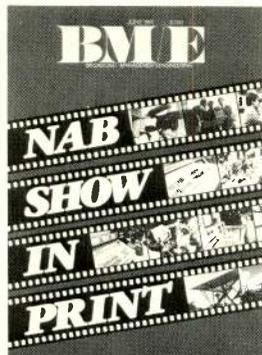

The 1981 NAB Convention sustained an upbeat response in the broadcast industry. Whether the talk was of computerized post-production, high quality audio, or simply more reliable equipment, broadcasters left with a feeling that the tools they need are available.

Publisher  
**Charles C. Lenz, Jr.**

Editorial Director  
**James A. Lippke**

Editor  
**David Hawthorne**  
Managing Editor  
**Janet E. Smith**  
Senior Editor  
**Robin Lanier**

Senior Editor  
**Stephen C. Miller**  
News Editor  
**Eva J. Blinder**  
Editorial Assistant  
**Douglas Damoth**

Assistant Publisher  
**Djuna Van Vort**  
Creative Director  
**Gus Sauter**  
Marketing Services Manager  
**Christine Bunish**  
Production Manager  
**David Rose**  
Advertising Production  
**Deborah Foley**

Comptroller  
**Steven Abromowitz**

FCC Counsel  
**Lovett Ford and  
Hennessey, P.C.**

## 10 Broadcast Industry News

*Fundraising rules relaxed for public stations; AT&T satellite plan suspended*

## 26 The 1981 NAB Show In Print

*Broadcasting sees the right tools to meet new challenges*

## 33 Cameras & VTRs Leap Ahead

*ENG/Recording Cameras  
High Resolution One Tube Cameras  
Under \$20,000 ENGs Improve  
Top Line Portables Advance  
Convertible Cameras Everywhere  
Studio Cameras Stress Auto Setup  
Many Camera Options  
Half-inch Improved Stripe Filter Tri-gun*

*Lenses Continue to Proliferate  
New Means of Supporting Cams;  
Teleprompting  
Power Packs  
More Formats on VTRs  
3/4-inch & 1/2-inch Advances  
Those 1/4-inch Machines  
One-inch VTR Innovations  
Mag Tape & Accessories*

## 57 Artistic Advances in Graphics Systems; Still Stores

*Digital Graphics  
Character Generators*

*Still Stores  
Animation  
Teletext*

## 99 Television Facilities Benefit From New Designs

*Editors  
Time Code  
Synchronizers  
Routing Switchers  
Distribution Amps and System Modules  
Digital Effects  
Production Switchers  
Master Control  
Business Automation for TV  
Frame Syncs & Digital Processors*

*TBCs & Other Digital Processors  
Analog Video Processors  
Digital Video Gets Boost Through Filters  
Telecines  
Film to Tape Transfer  
Picture Monitors  
Lighting  
Mag Tape Accessories  
Fiber Optic Sources  
Cable Connectors  
Shipping Cases*

## 75 Radio Equipment Heads For The Lead

*Consoles  
Audio Tape Recorders  
Cart Machines  
Radio Program Automation  
Electronic Reverb  
Audio Delay  
Audio Processing*

*Microphones  
Turntables  
Telco  
Top-fi Switching/DA  
Switching & Distributors  
Intercoms  
Monitor Speakers*

## 149 RF Transmission Explores New Territory

*LPTV  
More High Power Transmitters  
Transmitter Tubes  
Microwave for ENG  
Weather Radar  
Satellites*

*Transmitters for Radio  
STL  
Remote Control  
Towers  
Antennas  
Lightning Protection*

## 165 FCC Rules & Regulations

*New Sponsorship ID rules for noncommercial stations*

## 169 1980 Great Idea Contest Winners

### BROADBAND INFORMATION SERVICES, INC.

295 Madison Ave., New York, N.Y. 10017, 212-685-5320, Telex: 644-001  
Publishers: **BM/E—Broadcast Management Engineering**  
**BM/E's World Broadcast News**



BM/E BROADCAST MANAGEMENT ENGINEERING (ISSN 0005-3201) is published monthly by Broadband Information Services Inc. All notices pertaining to undeliverable mail or subscriptions should be addressed to 295 Madison Ave., New York, NY 10017. BM/E is circulated without charge to those responsible for station operation and for specifying and authorizing the purchase of equipment used in broadcast facilities in the U.S. and Canada. These facilities include AM, FM and TV broadcast stations, CATV systems, ETV stations, networks and studios, audio and video recording studios consultants, etc. Subscription prices to others \$24.00 one year, \$36.00 two years. Foreign \$30.00 one year, \$48.00 two years. Air Mail rates on request. Copyright 1981 by Broadband Information Services, Inc., New York City. Second class postage paid N.Y., N.Y. and additional mailing offices.



Grass Valley Group has guaranteed quality.  
**Now we guarantee  
 quick delivery!**

All GVG distribution amplifiers can now be shipped within four weeks of receipt of order!

That's right, stock-to-four-week delivery is a reality for the entire 3400 Series DA line, including the new 3430V Video Delay DA!

Orders for one to thirty DAs are *all* subject to the stock-to-four-week delivery *guarantee*. That's up to 30 DAs *in a single order*, shipped within a month ARO!

Greatly improved delivery times have *also* been established for GVG processing amplifiers, isophasing amplifiers, sync generators, linearity correctors. . . virtually *everything* within our Processing and Distribution Equipment line.

The commitment to improved delivery without sacrifice of famous GVG quality comes from within our dedicated Modular Products Group. Housed in a modern expanded facility, they are totally committed to excellence in the engineering and manufacturing of the finest video processing and distribution equipment.

## THE GRASS VALLEY GROUP, INC.®

P.O. BOX 1114 GRASS VALLEY CALIFORNIA 95945 USA • TEL: (916) 273-8421 TWX: 910-530-8280

A TEKTRONIX COMPANY

Offices: WEST: 21243 Ventura Blvd Ste 206, Woodland Hills, CA 91364 (213) 999-2303 • SOUTHEAST: 1644 Tullie Cir NE, Atlanta, GA 30329 (404) 321-4318 • NORTH CENTRAL: 810 W Bristol St, Elkhart, IN 46514 (219) 264-0931 • NEW ENGLAND & MID ATLANTIC: Station Plaza East, Great Neck, NY 11021 (516) 487-1311 • SOUTH WEST: Seminary South Office Building Ste 316, Fort Worth, TX 76115, (817) 921-9411 • MIDWEST: 3585 N Lexington Ave Ste 238, Arden Hills, MN 55112 (612) 483-2594

Circle 103 on Reader Service Card



"Our Sony video recorders have not only traveled the equivalent of fifteen times the circumference of the earth, but they've logged more than 2,500 hours of taping time," says Martin McAndrew, Vice President of Operations for Continental Colour Recording.

"Not one of these machines has ever broken down," McAndrew adds. "What makes that even more impressive is that they're constantly being used by different people with different ideas about how carefully to handle equipment.

"Seventy per cent of the time, our equipment is

used by ABC and NBC, but we also rent it to local television stations and production companies."

Continental Colour, the country's largest video equipment rental company, has specially built trucks and trailer trucks that are virtually television stations on wheels. Two of these trucks are equipped with one-inch equipment, including a total of two BVH-1100 and four BVH-1000 one-inch high-band video recorders. Continental has also purchased additional Sony recorders for its brand-new post-production facility.

"Sony picture quality is excellent," says McAndrew,



# “375,000 MILES WITHOUT A BREAKDOWN.”

*Martin McAndrew, Continental Colour Recording*

“much better than its main competitor. And the slow-motion capability of the BVH-1100's means that each can do the work of two separate machines, in less space, at less expense. No one else's equipment can match these 1100's.

“No wonder our Sonys are almost always on the road. They've covered the World Series, the Winter Olympics, the daytime Emmy Awards, the Tony Awards, operas and symphonies for PBS, and the Pope's visit to the U.S. And we've had zero problems; working with Sony has been delightful.”

If you want one-inch equipment you can really get some mileage out of, find out about Sony's full line. It includes cameras, recorders, editors, and the BVT-2000 digital time base corrector.

Write Sony Broadcast, 9 West 57th Street, New York, N.Y. 10019. Or call us in New York at (212) 371-5800; in Chicago at (312) 792-3600; or in Los Angeles at (213) 537-4300.

**SONY**  
**BROADCAST**

Sony is a registered trademark of Sony Corp.

Circle 104 on Reader Service Card

# BROADCAST INDUSTRY NEWS

## Fundraising Rules Relaxed For Public Broadcasters

Public broadcasters gained the right to air the logos of corporate contributors as part of a recent FCC action loosening the fundraising policies for noncommercial stations.

The action eliminated the "name only" rule, allowing public stations to use logos, locations, descriptions of product lines, and similar information to identify companies that make monetary contributions. The Commission emphasized, however, that any product promotion in this context was still prohibited.

Unpaid promotions of goods and services will be permitted under the new rules, though, if the station determines that the promotions are in the public interest.

Time and frequency of acknowledgements were left to the stations' discretion, as were limited on fundraising activities for station purposes.

The rule relaxation, according to the FCC, is designed to make fundraising easier for noncommercial stations, as the lessened restrictions on acknowledgements should be more attractive to corporate donors. The resulting increase in number of donors. The resulting increase in number of donors, the FCC said, would serve as a guard against any single donor being able to affect programming decisions.

## AT&T Satellite Plan Suspended By FCC Action

The startup date for AT&T's three-year satellite TV programming distribution trial has been pushed back five months

to allow the FCC staff additional time to investigate the service. The move was a disappointment for AT&T, which had planned to start distributing NBC programming May 18.

The April 9 vote, however, did not prevent the other two television networks from signing up for the AT&T service at the NAB Convention in Las Vegas. Program distribution for CBS and ABC is scheduled to start November .

The CBS service will interconnect the net's Television City, Hollywood production center and its New York City Broadcast Center.

In announcing the contracts with CBS and ABC, AT&T's Bill Brock pointed out the "unique features" of the satellite distribution service, including "total, end-to-end networking" and total control by the customer over its own network from a console.

Another big name in satellite television distribution. Wold Communications, recently announced an agreement with Microdyne Corp. of Ocala, Fla., under which Microdyne will supply as many as 100 TVRO earth stations to be installed at TV stations around the country. The earth stations will help implement Wold's nationwide satellite distribution of *Entertainment Tonight* and *The Merv Griffin Show*; the first 50-plus units are expected to be installed by late summer.

## FCC Plans Interim DBS Over Broadcasters' Protests

Opposition from broadcasters and terrestrial microwave users failed to stop the FCC from proposing interim policies and issuing a notice of proposed rulemaking for direct broadcast satellite services late in April. At the same time, the Commission also accepted for filing the DBS proposal of Satellite Television Corp., a subsidiary of Comsat.

The move delighted Comsat, of course, and STC was quick to announce that it had requested two space shuttle launch dates in 1985 for its two DBS satellites, one operational and one an in-orbit spare. This would set the start-up date of what will probably be the first actual DBS service well after the 1983 Regional Administrative Radio Conference, at which Western Hemisphere rules for DBS are expected to be set. A second DBS proposal is expected

## KCBS Electronic Newsroom Goes Public

When all-news KCBS, the network's San Francisco O&O, installed an all-electronic newsroom late last year, it did so very quietly. The station's caution seems to have paid, off, however, and culminated in its April 16 unveiling of the very successful system. Station users report significant savings in time and paper usage as well as that rarest of birds — a quiet newsroom.

Built by Integrated Technology, Inc. of Kansas City, Mo., the "News Machine" was designed with the full cooperation of station news personnel to meet the specific requirements of radio broadcasting. News wire inputs — 15 of them — tie into the central computer, which automatically files and crossfiles the stories. Editors and reporters have instant access to any material in the station's files through their terminals, which allow them to write, edit, and rewrite quickly and easily.

Bulletins flash on the terminals as soon as they are received, keeping all personnel up to date. Eight electronic "scratch pads" at each terminal allow reporters to work on several projects at once, while a split-screen facility lets editors see two stories side-by-side, moving entire blocks of copy from one to the other if desired.

The system also streamlines staff communications and coordination. Each terminal has instant access to all others, allowing users to send each



KCBS mid-day editor Jim Cullen reviews news input in the Electronic Newsroom computer

other messages and instructions electronically. Newsroom activity and assignment lists are readily accessible; reporters in the field can even file their stories with portable terminals.

KCBS's experiments with electronic news handling go back to 1977, when it joined with UPI in a "limited" test that lasted until December 1980. Greg Endsley and Dave Cunningham of Integrated Technology were called in by CBS in August, 1980, and installation and debugging of the complete system began in October.

# Quality, Reliability, Service...

## Excellent Reasons for Choosing ADM<sup>®</sup>

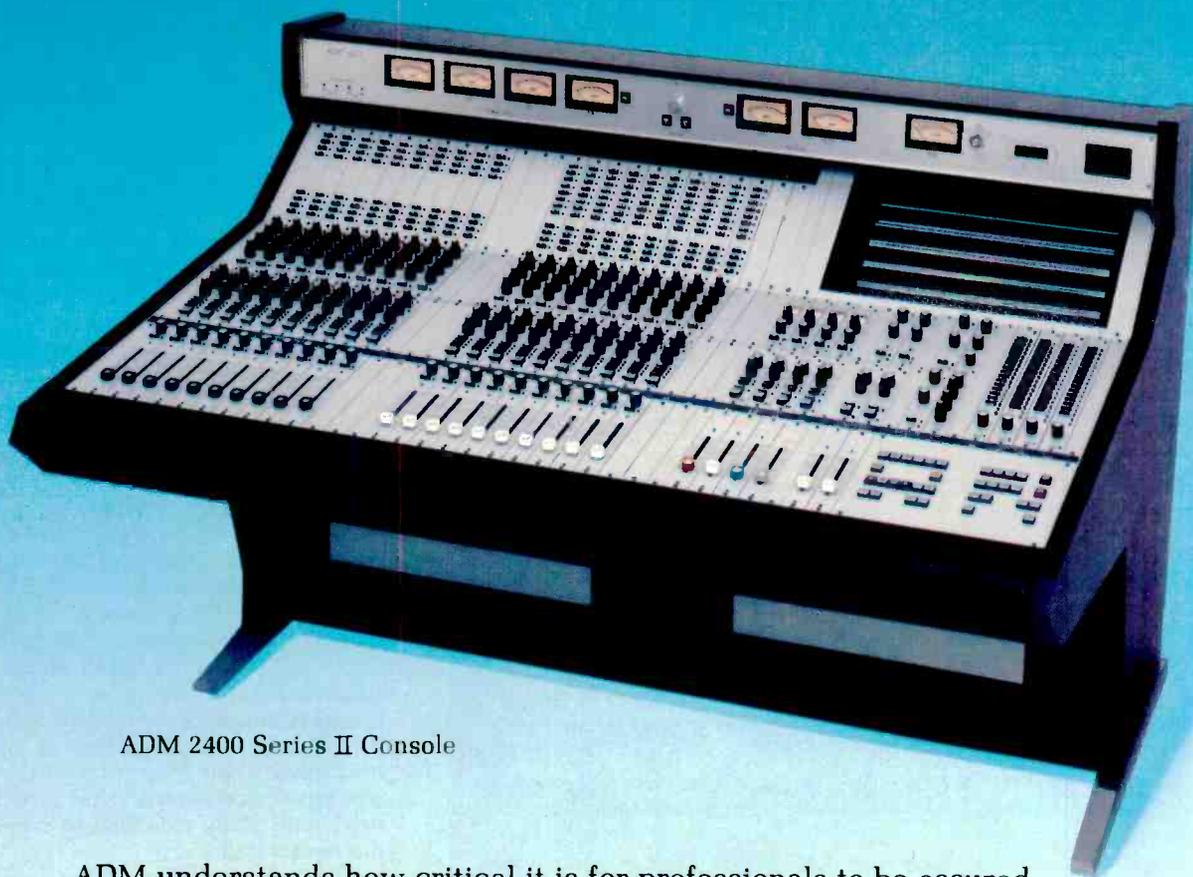

ADM 2400 Series II Console

ADM understands how critical it is for professionals to be assured of unfaltering performance under the most demanding conditions. That's why everything we do at ADM—from initial concept to final production—is geared to providing consoles of unexcelled quality and reliability. The finest of components are used in ADM consoles to assure long life and trouble-free operation. Our exclusive five-year warranty, the most generous in the industry, attests to this fact. Service—if you ever need it—is prompt and professional.

Find out more about ADM's high-performance standard and custom consoles. Contact ADM Technology, Inc., 16005 Sturgeon, Roseville, Michigan 48066. Phone (313) 778-8400. TLX 23-1114. West Central Sales Representative, Gordon Peters. (817) 467-2990. West Coast Sales Office, (415) 664-2400.

# ADM<sup>®</sup>

*The Audio Company*

## News

to come this fall from the aptly named DBS Corp., whose 32-channel common carrier service, free to consumers, would cover half the country. STC's proposal involves three channels of pay TV and initially would cover only the Eastern states.

Much of the concern over what some see as a hasty move by the FCC has centered around the RARC date. NAB's Vincent Wasilewski, for exam-

ple, suggested that Latin American countries might see the proposal "as a 1980's version of a 'land grab' . . . strictly a nationalistic move." Wasilewski called the FCC's decision to process applications prior to setting actual policy "short-sighted. This is a cart before the horse situation." He said that NAB opposed allocating "prime spectrum space" to the service, but did see experimental opportunities in DBS, especially involving high-definition television.

Also opposing the DBS proposal was

a group whose members stand to lose a lot if the 12 and 17 GHz bands go to the satellite service, as Comsat has requested. The Operational Fixed Microwave Council, representing terrestrial microwave users, filed comments with the FCC claiming that the band wasn't big enough for both uses.

Comments from the individual commissioners were almost all favorable, as might be expected after a unanimous decision. Some doubts came from Anne Jones, who mused that the FCC's "preliminary determination that DBS is in the public interest may be premature."

The impact of DBS on local television broadcasters is another question raising a variety of replies. Robert E. Lee, FCC chairman at the time of the proposal, questioned whether local broadcasting "can economically exist on local and regional advertising since national advertising will surely go on the bird." In a study conducted by Harvard University, however, 60 percent of the telecommunications experts who participated indicated that they felt DBS would have no "significant" effect on broadcast TV. A large majority (83.1 percent) said that DBS would not serve local needs and 79.2 percent said local needs would continue to be served by commercial TV stations.

An interesting, if insignificant, side-light was provided by an AT&T exhibit at the NAB convention, two weeks before the FCC's DBS move. A demonstration of the company's Dial-It telephone polling service asked broadcasters, among other things, whether they thought Comsat should set the go-ahead on DBS. Sixty-two percent of radio broadcasters and 58 percent of television broadcasters voted "yes" — of the tiny, statistically meaningless number that voted at all.

## CNN's Satcom 1 Access Upheld By FCC Decision

Ted Turner's right to a transponder on Satcom 1, RCA's primary cable satellite, has been assured by the FCC in a recent decision affirming the legality of his Cable News Network's contract with RCA Americom.

In its decision, the Commission found that CNN's right of first refusal under its contract with RCA was legal and enforceable under the Communications Act. Space on the main cable bird is a clear victory for Turner, still working to get CNN into the black.

CNN, which had originally planned to be on the ill-fated Satcom 3, was left with a distribution dilemma when that satellite was lost after its December, 1979 launching. The FCC granted the net temporary access to a Satcom 1 transponder in time for its June 1 start-up date, but permanent access was not

## Case History #437

Electronic News Gathering is one of the toughest environments a microphone will ever encounter. Every mike we've seen has compromised the demand for low handling noise, fine audio quality and virtual indestructibility.

Credit the NBC Electronic Journalism Department/Operations and Engineering in New York for putting the Electro-Voice DO56 shock-mounted omni in the field. Although originally designed as an on-camera entertainment and MC's microphone, NBC found the DO56 to be the microphone that provides an audio signal commensurate with video in real-life crisis situations. In these situations audio often takes a back seat to video,

### Electro-Voice DO56 Shock-Mounted Omnidirectional Microphone

pushes, the shoves, the rubs and finger taps in stride. And when handling *really* gets rough, the DO56's unique internal shock mount virtually eliminates the bell-like clang transmitted by other shock-mounted mikes.

Congratulations to the NBC Electronic Journalism Department in New York. You found the solution — the DO56.

For an in-depth description of this and other case histories, get on the Electro-Voice "Mike Facts" mailing list. Write on your letterhead to Mike Facts, c/o Electro-Voice, 600 Cecil Street, Buchanan, MI 49107.

resulting in a final product that doesn't accurately reflect the broadcaster's professional standards. NBC discovered that the DO56 takes the

**EV** Electro-Voice®  
a gulton company



Circle 105 on Reader Service Card

# LIMIT TO THE LIMIT.



## HERE ARE THE INDUSTRY'S MOST DYNAMIC PERFORMERS.

OF COURSE, THEY ALSO COMPRESS, EXPAND, GATE AND DUCK. THAT'S WHY RECORDING AND BROADCAST ENGINEERS ALIKE APPRECIATE THE EXTREME DEPENDABILITY AND MAXIMUM FLEXIBILITY OF AUDIO & DESIGN'S COMPLETE LINE OF COMPRESSOR/LIMITERS. NO OTHER MANUFACTURER IN THE WORLD CAN MATCH THIS SELECTION OF LOW DISTORTION LEVEL CONTROLLERS.

1. THE GEMINI EASY RIDER OFFERS TWO FULL FUNCTION CHANNELS AT A MODEST PRICE.
2. THE EX-PRESS LIMITER IS IDEAL FOR CONTROLLING STEREO MIXES, PLUS IT CAN BE CONFIGURED FOR FM BROADCAST OPERATIONS.
3. KNOWN THE WORLD OVER, THE VOCAL STRESSER COMBINES A COMPLEX LIMITER WITH FOUR BANDS OF SWEEP EQ.
4. THE ORIGINAL COMPLEX LIMITER FEATURES SEPARATE COMPRESSION, LIMITING AND EXPANSION FACILITIES.
5. FOR SPECIAL APPLICATIONS, THE VOICE-OVER LIMITER AUTOMATICALLY MAINTAINS A PRE-ESTABLISHED MUSIC TO VOICE RATIO.
6. AND, THE UNIQUE SELECTIVE LIMITER CONTROLS LEVEL IN ONE FREQUENCY REGION WITHOUT MODULATING THE REST OF THE PROGRAM.

WITH FEATURES LIKE ADJUSTABLE ATTACK, RELEASE AND RATIO AS WELL AS STEREO COUPLING, "SIDE CHAIN" ACCESS AND "SOFT KNEE" SLOPES AT THE THRESHOLD OF COMPRESSION, THESE EXCEPTIONAL LIMITERS ARE THE MOST PROFESSIONAL CHOICE FOR EFFICIENT, LOW DISTORTION LEVEL CONTROL. CALL TOLL FREE, 800-426-6170 FOR DETAILS ON THESE AND OTHER FINE AUDIO PROCESSORS FROM AUDIO & DESIGN.

AUDIO & DESIGN RECORDING, INC. • P. O. BOX 786 • BREMERTON, WASHINGTON 98310  
TELEPHONE (206) 275-5009 • TELEX 15-2426

AUDIO & DESIGN RECORDING, LTD. • NORTH STREET • READING RG1 4DA • BERKSHIRE, ENGLAND  
TELEPHONE (0734) 53411 • UK TELEX 848722

Copyright 1981 by Audio & Design Recording, Inc.



## Audio + Design

THE HIT SOUND IN AUDIO SCIENCE

Circle 106 on Reader Service Card

## News

assured until the current decision. The temporary authority was extended late in January for another six months.

### LPTV Applications Halted

Citing insufficient staff and computer capacity to handle the flood of low power television applications that have inundated it, the FCC voted early in April to stop accepting new applica-

tions.

Nearly 5000 applications had been accepted at the time of the cutoff, creating an enormous backlog of work for Commission staffers, who must analyze them for mutual exclusivity. Applications already received will continue to be processed, however.

Applicants meeting one of three criteria can still file: locations currently receiving less than two full-service TV stations, requests to change from channels 70 through 83, and requests for frequency changes to resolve inter-

ference with full-service stations.

In a related action taken the same day, the Commission denied a renewed request from CPB, PBS, and the National Association of Public Television Stations to stay the LPTV interim processing policy. The petitioners had asserted that two *ex parte* meetings between Commission staff and applicants had adversely affected two petitions of theirs, one requesting a stay of interim processing and one requesting that channels be reserved for public broadcasting. The FCC ruled that since the LPTV rulemaking is designated as non-restricted, the *ex parte* meetings did not violate the rules.

# Video for business. That's our business.

More and more businesses are turning to video as a vital part of their communications arm. And as a medium through which to make their operations more efficient. Because video has so many important applications.

We, at Camera Mart, have believed in video from the beginning. And just as video has grown, we've grown. Because we always had up-to-date equipment, and the people who could help you get the greatest benefits from video. And save you money while you're doing it.

We have a professional staff to serve you, and the most complete line of video cameras, lenses and accessories, terminal equipment, processing equipment, switchers, video projectors, videocassette recorders, editing systems. We carry virtually every important equipment name you could name. And all at competitive prices, whether you buy, lease or rent.



## The Camera Mart, Inc.

456 West 55th Street, New York, 10019 • (212) 757-6977/Telex: 1-2078  
Sales • Service • Rental

Circle 107 on Reader Service Card

### Wold, Visnews Offer New Broadcast Satellite Service

U.S. and international broadcasters can now "rent a news bureau" in New York or Washington to cover stories breaking in those cities. The complete newsroom services, including transmission facilities, are being offered by Wold-Visnews Broadcast Services, a joint venture of Wold Communications and Viscom International (USA), Ltd., a subsidiary of Britain's Visnews Television news agency.

Initiated early in May, the service allows news personnel of client broadcasters to produce and edit stories at the Wold-Visnews facilities and transmit them via satellite. Headquarters for the operation are in New York City's Empire State Building, where users can find ENG and editing facilities. The Washington outlet features three fully equipped newsrooms and an editing room. Both offer fixed microwave links to Wold's satellite uplinks. Visnews will handle the European side of the operation.

Another phase of the venture will involve end-to-end videoconferencing services for international businesses. The regular operations of Wold and Visnews will be unaffected by the new business.

### Earth Station Facility Kicks Off D.C. Service

MetroSat, a sophisticated receive and transmit earth station complex serving the Washington, D.C. area, opened its Bren Mar, Va. facilities in a spectacular fashion last April — assisting broadcasters with emergency satellite links for transmitting news feeds about the assassination attempt on President Reagan.

According to Bob Schmidt, president of MetroSat's parent company, Communications Technology Management, Inc. (CTM), MetroSat was "able to transmit these broadcasters' signals out of Washington when other



Picture shows Model 5315/32 TV Audio Console customized for WRC-TV, Washington, D.C.

Simplicity, reliability and high performance are the parameters needed by TV broadcasters in the 1980's.

And Neve delivers just *that* in its wide range of purpose designed TV audio consoles; consoles surprisingly

price competitive and often available on short delivery. Our 542 series spans 6 to 16 in, ideally suited for video production facilities and TV audio sweetening. The 5315 and 5316 consoles are available in sizes from 12 to 36 in with 4 or 8 submasters for TV sound production and on-air applications. Please write or call for our comprehensive TV audio console information package, so you can put Neve in your budget now.

You'll be joining the Neve world of excellence!

# Audio for TV Stations!

---

 **Neve**

**Rupert Neve Incorporated** Berkshire Industrial Park, Bethel, Connecticut 06801 Tel: (203)744-6230 Telex: 969638

**Rupert Neve Incorporated** 7533 Sunset Blvd., Hollywood, California 90046 Tel: (213)874-8124 Telex: 194942

**Rupert Neve Incorporated** P.O. Box 120907, Nashville, Tennessee 37212 Tel: (615)385-2090

**Rupert Neve of Canada, Ltd.** 2721 Rena Road, Malton, Ontario L4T 3K1, Canada Tel: (416)677-6611 Telex: 983502

**Neve Electronics International, Ltd.** Cambridge House, Melbourn, Royston, Hertfordshire, SG8 6AU England Tel: (0763)60776

**Rupert Neve GmbH** 6100 Darmstadt Bismarckstrasse 114, West Germany Tel: (06151)81764

## News

communications networks were unable to respond." The uplinking service is available on an occasional or long-term basis for broadcasters — radio as well as television — CATV programmers, and business users.

The Virginia facility, which includes three 10-meter dishes, is capable of simultaneous transmission to any three domestic satellites — four transponders on each.

Another CTM project just getting off the ground is MetroNet, a common carrier microwave system. MetroNet and MetroSat have both announced that they will provide microwave and earth station facilities for the Bell & Howell Satellite Network of Washington, D.C., for its teleconferencing services.

### Tele Cine, Inc. Becomes Schneider Corp. Subsidiary

Schneider Corp. of America, U.S. arm of Jos. Schneider GmbH & Co. of West Germany, has purchased Tele Cine,

Inc., exclusive U.S. and Canadian distributor for Schneider's line of broadcast television lenses. A new corporation, Tele Cine Corp., will continue to operate the broadcast lens distribution business from Tele Cine's current headquarters in Massapequa, New York.

Donald Collins, Tele Cine, Inc. president, will continue as executive vice president of Tele Cine Corp., while Schneider president Gil Hoffman will serve as president of both companies. Schneider is currently working on plans to move both operations to expanded facilities in the vicinity, although the companies will retain their separate identities and functions. Schneider Corp. handles North American sales and distribution for the German company's non-broadcast products.

## The New FM Performance Leader Broadcast Electronics' FX-30 Exciter.



With almost 50 already in use  
Broadcast Electronics' new FM Exciter  
— the FX-30 — provides superior on air performance.

#### For the Purist, Purest Sound.

The FX-30 has the lowest distortion, with THD and IMD less than 0.08%. And, it's the first exciter to specify Transient Intermodulation Distortion (TIM) at less than 0.1%.

#### Loud, yet Quiet.

The FX-30 is loud and sparkling clean with your programming, yet it's the quietest exciter of all, with a typical S/N ratio of 78 dB.

#### Broadband and Synthesized.

Advanced dual speed phase locked loop puts more than 2000 channels at your fingertips.

#### Set It and Forget It.

Automatic control circuits eliminate adjustments after initial setup. Exciter output is automatically stabilized and fully protected. Set it and forget it.

#### The Perfect Retrofit.

RF power output is adjustable up to 30 watts. The FX-30 will improve the performance of any transmitter and will fit directly in place of your present exciter.

#### Styling Elegance.

Elegant in styling as well as in performance, the new look in FM is the elegant look of the FX-30.

For more information on the FX-30 Exciter and BE's exciting new FM transmitters, call or write Joe Engle at: 217-224-9600

a FILMWAY company



**BROADCAST  
ELECTRONICS INC.**

4100 N. 24th STREET, P.O. BOX 3606, QUINCY, IL 62301, TELEX: 25-0142

Circle 109 on Reader Service Card

### Earth Station Antenna Maker Signs On At NAB

SatCom Technologies, Inc., a fledgling Atlanta-based manufacturer of satellite earth station antennas, made its first appearance at last April's NAB Convention at Las Vegas.

The new company is a subsidiary of Radiation Systems, Inc. (RSi), which primarily serves the military market with a broad line of antenna products. SatCom Technologies will aim its service at the domestic satellite market, offering a complete line of satellite antennas from three to 13 meters in diameter. Expected customers include broadcasters and CATV operators, common carriers, and business and industrial users.

One new product from SatCom is the comsat-designed Torus antenna, notable for its ability to receive signals from several satellites simultaneously. The Torus will be built by RSi under exclusive license from Comsat.

### "TV University" Gets Carnegie Foundation Grant

The National University Consortium, which aids an increasing number of at-home students to get college degrees over the air, has received a \$446,000 grant from the Carnegie Foundation, the third (and largest) such grant to NUC from Carnegie.

NUC, now ending its second semester, currently involves 11 universities, 32 PBS TV stations, and three cable systems across the country. Plans call for a goal of 100 participating universities, with a corresponding increase in public television and CATV systems.

Students pay tuition for the courses and member schools pay a fee to help support the program, which is also supported by grant money such as the Carnegie funds. Study guides and texts



**Our Co-Ax Digital Remote Control system is now available for:**

**Sony BVP-300/BVP-330, Thomson  
MC-601/MC-701, Ikegami HL-77/HL-79A,  
RCA TK-76B/TK-76C, and NEC MNC-71CP  
ENG/EFP cameras.**

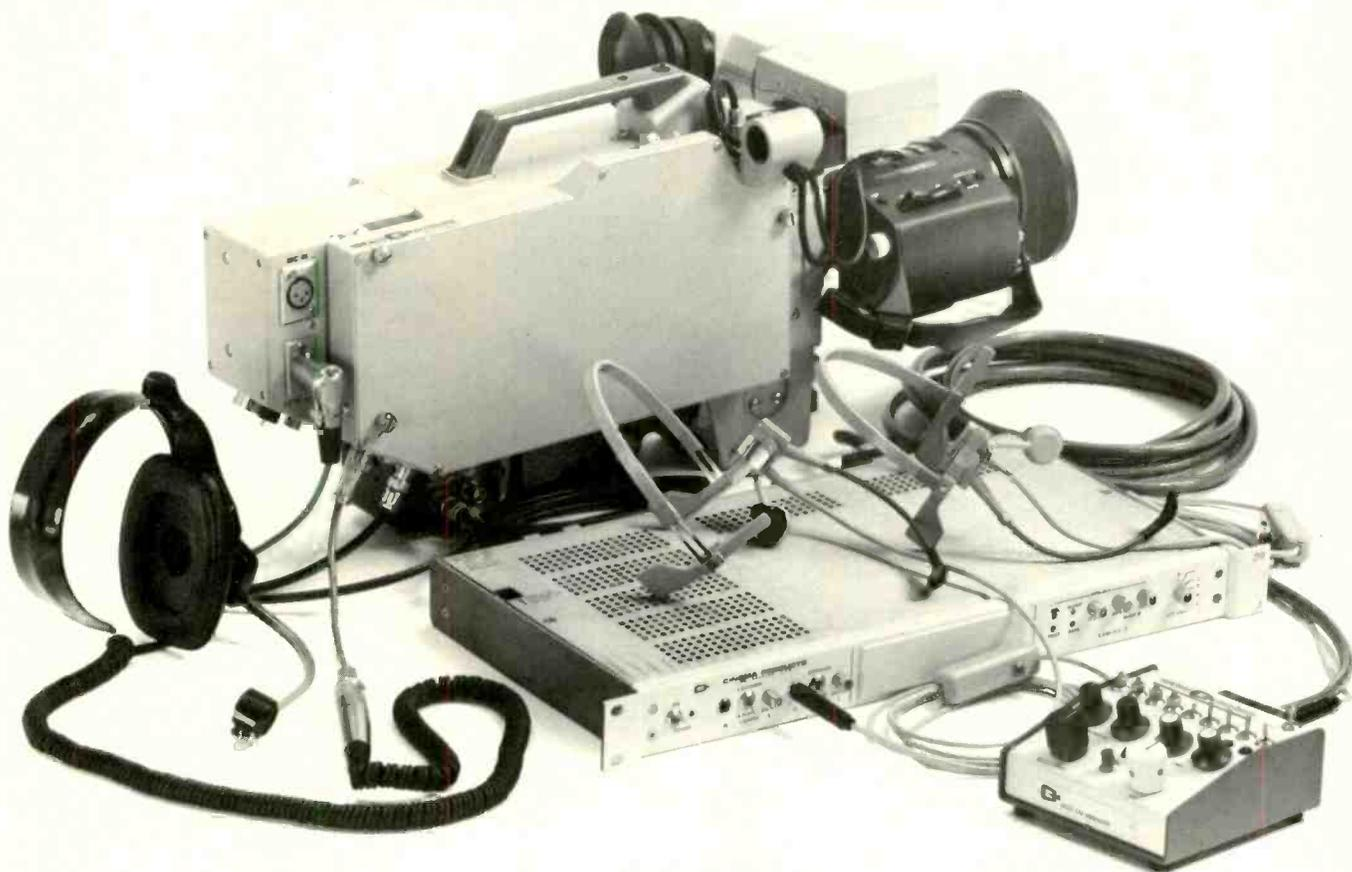

- Cinema Products' exciting new co-ax digital remote control system provides dependable, studio-like remote control to ENG/EFP cameras in the field *at a fraction of the cost of other systems!*
- System consists of mini-CCU, analog-to-digital encoder, and digital-to-analog decoder.
- Permits control of all functions normally required in OB van, including genlock.
- Digital encoder (19" rack-mounted) designed to accommodate two mini-CCU's to control two cameras (each equipped with its own decoder).
- Lightweight, camera-mounted decoder features intercom capability. (Decoder is either side-mounted on camera door, or neatly "sandwiched" between camera body and door.)
- Digitally encoded control data relayed to camera-mounted decoder through a simple, lightweight and reliable coaxial cable.
- Eliminates the need for expensive, bulkier, multi-core or triax camera cable, and reduces to a minimum

the risks normally associated with the use of such camera cables.

- Low-cost coaxial cable allows complete remote control and camera set-up functions from greater distances with greater safety and utmost reliability.
- The most affordable and reliable remote control system available on the market today, the CP co-ax digital remote control system is ideal for all extended shooting situations such as sports events, live concerts, political rallies, etc.

For full details, call toll-free: 800-421-7468.

**cinema E products**  
CORPORATION

*Technology In The Service Of Creativity*

2037 Granville Avenue, Los Angeles, California 90025  
Telephone: (213) 478-0711 • (213) 477-1971 • Telex: 69-1339

## News

provide the major part of the course work, which is supplemented by the television broadcasts. Students enroll through the nearest affiliated university, which assigns them individual "telephone tutors" and may provide a "learning center" for at-home scholars. All courses are fully accredited and lead to bachelors' degrees. The "guided study" teaching method is similar to that used by the British Open

University, founded in 1969, which enrolls 80,000 students in its telecommunications teaching system.

### Fiber Optics Company To Concentrate On ENG/EFP

A new fiber optic communications systems manufacturing company has been formed by two former employees of Valtec Corp. Artel Communications Corp., described by one of the principals as "a small, high technology sys-

tems company" with "some excellent opportunities," is aiming its initial product offerings at the ENG/EFP market.

The new gear, seen at NAB, is a portable ENG/EFP system that can transmit video signals from a camera a distance of one to two miles over small, lightweight optical cable with high video quality. It is expected to be available within a few weeks. Artel productions will include terminal equipment and systems to multiplex, process, and transmit video, voice, and data signals over fiber optic cables.

Richard A. Cerny, formerly marketing director for Valtec Communication Fiberoptics, heads Artel as president. Tadeusz Witkowicz, Artel executive VP and treasurer, previously managed Valtec's Systems Group.

### Women Logged Broadcast Job Gains In 1980

Figures recently released by the FCC show that women continued to make significant gains in broadcast employment, including those jobs in the higher-paying categories.

Of total employees, 33.3 percent were women in 1980, compared with 31.8 percent in 1979. Women showed good-sized gains in the four highest-paying job areas, also, making up 25.3 percent of officials and managers (up from 22.6 percent in 1979), 25.7 percent of professionals (up from 24 percent), and 34.5 percent of sales workers (up from 30.7 percent). In the fourth category, technicians, women also gained — to 9.7 percent from 8.3 percent — but remained at a relatively low level of employment.

Figures for minority employment also showed increases, although these were less rosy than the statistics on women. Total employment of minorities (including Blacks, Asians and Pacific Islanders, American Indians and Alaskan Natives, and Hispanics) rose slightly to 14.6 from 14.3 percent the previous year. Gains were seen by most minority groups in most of the higher-paying categories, but these also were rarely more than a few tenths of a percent, with an occasional category showing a slight loss.

### News Briefs

The FCC must take into account public TV stations' service to their hearing impaired viewers during license renewal proceedings, the U.S. Court of Appeals for the District of Columbia has ruled. The station involved in the case is KCET, Los Angeles, currently participating in a major teletext experiment involving captioning (see *BM/E*,



## Professional Performance With A Bottomline Benefit.

### The MX-5050B

The Otari MX-5050B. The 1/4" production machine that's earned the reputation of The New Workhorse. Because of quality that delivers unmatched reliability. Reliability that an engineer depends on. And accountability that makes your banker smile. Smiles, because it eases your production burdens while making a "return on investment." The 5050B offers the performance and features of machines which cost more than twice as much, and the "B" will keep on returning your investment long after it's written off.

Now, that's why we claim that dollars for dB's, it's the best you can own.

The New Workhorse

**OTARI**

Otari Corporation, 1559 Industrial Road  
San Carlos, California 94070 (415) 592-8311 Telex: (510) 576-4930

Circle 110 on Reader Service Card

# SOPHISTICATED. YET SIMPLE.

Nurad offers the broadcaster a comprehensive approach to airborne ENG/EJ operations that strikes a balance between two equally desirable attributes: sophistication and simplicity.

Even a casual glance at the COPTER POD™ and MINI POD™ reveals our radical departure from ordinary airborne ENG/EJ systems. In COPTER POD™ and MINI POD™, four circularly polarized directional transmit antennas,

each providing 90° coverage (forward, aft, left, and right), and a circularly polarized receive antenna (for ground-to-air-to-ground relay operations) are utilized instead of the usual multipath-prone omnidirectional antenna. This approach not only results in a significant increase in gain, but, because the transmitted energy is confined to a single segment, virtual elimination of multipath effects.

With COPTER POD™ and MINI POD™'s AUTO TRANSMIT™ Automatic Antenna Selector System, the proper transmit antenna (forward, aft, left, or right) is automatically selected and switched into the system, thereby allowing complete freedom of helicopter movement.

In addition to the directional antenna system, COPTER POD™ incorporates a frequency-agile transmitter with power amplifier, and a frequency agile receiver, all embodied within a sleek, aerodynamically streamlined envelope. MINI POD™, a scaled-down version of COPTER POD™, incorporates the directional antenna system and built-in power amplifier, and is complemented by our MINIPAC™ transmitter/receiver pair.

Our SUPERTRACK™ Central Receive Antenna System combines the virtues of the field-proven SUPERQUAD™ II with the capability for operator-controlled tracking of airborne microwave transmissions. With SUPERTRACK™, the operator is provided with a simple TURN LEFT/ON TARGET/TURN RIGHT readout telling him whether and in which direction to pan the antenna for tracking.

Nurad has the total answer for airborne ENG/EJ operations. By combining the directional transmit antenna system of the COPTER POD™ and MINI POD™ with the operator-controlled tracking capability of the SUPERTRACK™, Nurad offers the broadcaster reliability not found in other systems for airborne ENG/EJ operations.

## NURAD



## News Briefs

January, 1981) . . . . FCC has proposed deleting VITS requirements for remotely controlled TV transmitters, in response to a petition from ABC . . . . The EBS weekly test requirements have been amended to allow stations to substitute EBS activation for the test . . . . The Commission has terminated its proceeding proposing that new or changed VHF stations be required to allow UHF's to place their antennas

on the VHF's tower . . . . The FCC inquiry on transmission of test signals in the vertical interval during inter-national broadcasts has also been terminated.

Japanese network TV Asahi operated out of Boston's WNAC-TV for its overseas coverage of the Boston Marathon in April . . . . KGO Radio, ABC affiliate in San Francisco, won four first-place awards in the UPI California-Nevada Broadcasting Competition, for spot news coverage, editorial series, public service reporting, and

major-market feature . . . . Allen Rosen of KOMO-TV's *PM Northwest* has been named Television Photographer of the Year (1980) by Region 11, National Press Photographers Association — the second year in a row Rosen has been so honored . . . . KMSB-TV, Minneapolis, received the 1980 INTV award for "best print and visual promotion."

## Business Briefs

E&O Systems Ltd., U.S. distributor of Barco color monitors, has announced a name change and move. Now known as **Elector**, the company is located at 5128 Calle del Sol, Santa Clara, Calif. 95050 . . . . **Bardwell & McAlister** has moved to larger quarters at 7051 Santa Monica Blvd., Hollywood, Calif. 90038, (213) 466-9361 . . . . **Victor Duncan, Inc.** has opened the doors of its new facility at 661 N. LaSalle, Chicago . . . . **KEF Electronics** has opened a West Coast office at 425 Sherman Ave., Palo Alto, Calif. 94306.

A new research and marketing consulting firm, **Bushyhead, Wortsman & Klein Inc.**, will offer its services to television stations from its offices at 2131 Union St., Suite 4, San Francisco 94123, (415) 921-1881 . . . . **Frederick N. Doner Productions, Inc.**, specializing in theater, motion picture, and television production, has opened offices in Detroit, with plans to add a New York branch this fall . . . . A new company, **Western Broadcast Systems**, will sell and market broadcast-quality audio and video products from its headquarters at 10707 Amulet Pl., Cupertino, Calif. 95014, (408) 749-0900.

**Klark-Teknik Electronics** has been appointed exclusive U.S. distributor for **Rebis Audio** of England, manufacturer of a range of signal processing modules . . . . **Scharff Communications** is the exclusive Northwest distributor of Britain's **Audio Developments** line of professional portable mixers . . . . A new San Rafael, Calif. audio supply house, **Recording and Broadcast Supply**, has been appointed California distributor for **Neotek** and **Apsi** consoles . . . . **Nortronics** has retained **R.A. Albrecht Co.** of Rochester, Mich. as manufacturer's rep for that state.

U.S. JVC Corp. has installed two automated parts storage and retrieval systems at its Elmwood Park, N.J. warehouse in an effort to improve customer service . . . . **Chyron TeleSystems** is offering three new training courses for Chyron IV operators; more information from Chyron, 265 Bethpage-Spagnoli Rd., Melville, N.Y. 11746, (516) 249-3296 . . . . **TSG** of 1009 S. Fourth St., Louisville, Ky., is

# Football Special

## The Classic

Shure M-67 Mixer  
Telex Sportscaster Headset - CS91  
Electrovoice 635A Mike

All Three Only \$379<sup>00</sup>

## The Deluxe

Astrolite 2636B  
Microtrak Sport IV with Dial\*  
Electrovoice 635A

All Three Only \$819<sup>00</sup>

\*The Microtrak Sport 4-Dial features 4 microphone and one high-level input, spotter mic. input, three headphone outputs, hybrid/talkback capability, and telephone dial for connection to any phone line.

OFFER EXPIRES 8/15/81

Prices are payment with order, UPS prepaid. Write for our complete price list to fill all your equipment needs.

# David Green

P.O. Box 590/Leesburg, Virginia 22075, Phone 703-777-8660

## broadcast consultants corporation

Circle 112 on Reader Service Card

# QUALITY STANDS OUT

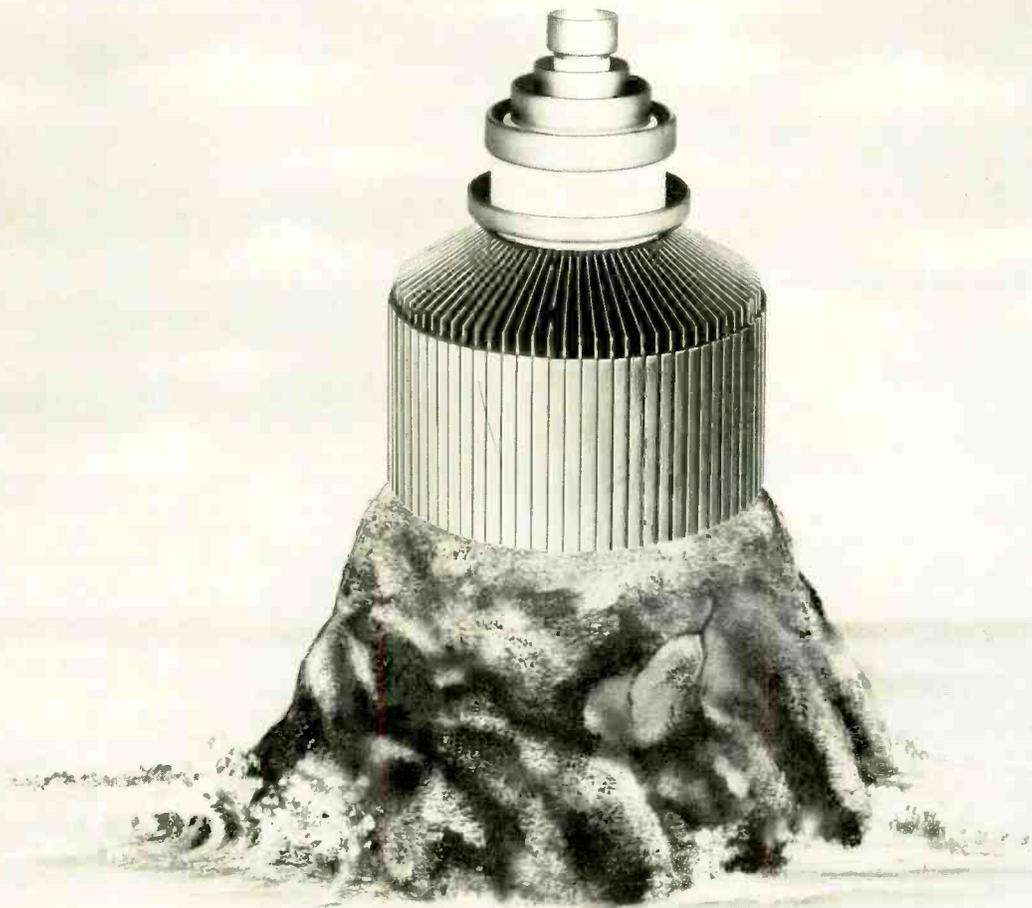

In UHF-TV tetrodes, there's just one name: **THOMSON-CSF.**

- for high gain, exceptional linearity and matched coaxial-cavity circuits,
- for optimum performance in combined video-and-sound-carrier amplification,

- and for proven reliability and long operating life, it's THOMSON-CSF.

Typical of this exceptional product line, the **TH 347**, an ideal choice for 1 kW UHF-TV transmitters/translators.

In its TH 18363 circuit, it operates all the way up to 860 MHz in  $\lambda/4$ , with sufficient gain to allow a single-tube design.

**One more excellent reason we say "THOMSON-CSF. a name to rely on!"**



**THOMSON-CSF**  
COMPONENTS

**THOMSON-CSF COMPONENTS CORPORATION** ELECTRON TUBES DIVISION  
750 BLOOMFIELD AVENUE - CLIFTON NJ 07015 - TEL.: (1.201) 77 910 04 - TWX: 710 989.7149

**BRAZIL**  
SAO PAULO  
THOMSON-CSF  
COMPONENTES DO  
BRASIL Ltda.  
TEL.: (11) 542.4722

**GERMANY**  
MUNCHEN  
THOMSON-CSF  
BAUELEMENTE  
TEL.: (89) 75.10.84

**ITALY**  
ROMA  
THOMSON-CSF  
COMPONENTI  
TEL.: (6) 638.14.58

**SWEDEN**  
STOCKHOLM  
THOMSON-CSF  
KOMPONENTER  
& ELEKTRONOR AB  
TEL.: (8) 225815

**FRANCE**  
BOULOGNE-BILLANCOURT  
THOMSON-CSF  
DIVISION TUBES  
ELECTRONIQUES  
TEL.: (1) 604.8175

**UNITED KINGDOM**  
BASINGSTOKE  
THOMSON-CSF  
COMPONENTS AND  
MATERIALS Ltd.  
TEL.: (256) 29.155

**SPAIN**  
MADRID  
THOMSON-CSF  
COMPONENTES  
Y TUBOS S.A.  
TEL.: (1) 419.88.42

**JAPAN**  
TOKYO  
THOMSON-CSF  
JAPAN K.K.  
TEL.: (3) 264.63.46

Circle 113 on Reader Service Card

## Business Briefs

offering hands-on seminars on broadcast equipment repair for engineers. The company's phone number is (503) 589-3880.

The Nigerian Television Authority has ordered over \$10 million of television cameras, video recording systems, and outside broadcast vehicles from **Ampex Corp.** Other major contracts recently reported by the company include \$4 million of videotape for

Magnetic Video Corp., a major video program duplicator, and \$250,000 of equipment including VTRs, a production switcher, and an editor for Hayes Productions of San Antonio, Texas. The company delivered its three-thousandth VPR-2 helical VTR in March, to McDonnell-Douglas Corp. . . . **Editel** has expanded its Chicago post-production facilities with one-inch VTRs and off-line editing equipment from **Sony Corp.** Recording house M&K Sound of Los Angeles has just added a Sony digital editor to its

equipment lineup . . . San Francisco production house Chronicle Productions has installed a **TeleMation** Compositor I graphics system.

**WXIA-TV**, Atlanta, has purchased a **Harris TVD-100H** 100 kW circularly polarized VHF antenna, along with a 9100 Facilities Control System and a two-bay Batwing antenna. The company has also sold a **TV-50H** 50 kW transmitter, **TAH-15H** helical antenna, and 9100 system to **KCTV**, San Angelo, Texas . . . **WOLE-TV**, Aquadilla, P.R., has increased its coverage area with an **RCA Broadcast TTG-30H** 30 kW transmitter and a **TW-12A12** travelling wave antenna worth about \$1 million. **WVEC-TV**, Norfolk, Va., has purchased two similar transmitters, and **Rainbow Communications of California** has installed \$900,000 of RCA broadcast equipment in its new post-production facility . . . **Rupert Neve, Inc.** will supply sophisticated TV sound production consoles for CBS Television's New York City Broadcast Center. The first Neve **NECAM II** computer-assisted TV audio post-production system in the U.S. has been installed in **Motown Studios** in Hollywood.

**Compact Video Sales** has completed a custom-made Compact 27 mobile video unit for Video West of Salt Lake CITY. Video Production Services of Kansas City will lease a Compact 27 for coverage of sporting and other events for the TV nets . . . **Bonneville Productions** has upgraded its Studio C facility with **UREI 813** monitor speakers . . . **American Video Products** of Anaheim, Calif. has installed a dual editing suite for **American Film Factory**, complete with **UMI Commander IIs**, **Vital 114Xs** and a shared **Vital SqueezZoom**.

**Jack E. Banister** has been named division video president, marketing for **RCA Broadcast Systems** . . . **James A. Smith** has been appointed vice president, director of marketing for **R.F. Technology** . . . **William E. Gibson** has been promoted to vice president-general manager of **Harris Corp.**'s Transmission Systems Division, part of the **Farinon Group** . . . **Stewart Greenberg** has been elected vice president of marketing and sales at **James B. Lansing Sound.**, . . . **RTS Systems** has appointed **Jack Sympton** international sales manager.

**Donald O. Kiser** has been appointed president of **GTE Lenkurt** . . . **James K. Baker** has been elected president and CEO of **Arvin Industries** . . . **EECO, Inc.** has named **Dr. Stuart Krasney** director, marketing development . . . **Oak Communications** has announced the appointment of **H.K. "Hank" Sauer** as vice president and of **Ronald S. Comm** as vice president of finance.



## Record, play and dub complete sporting events and full-length movies . . . non-stop.

Record and playback up to 2 hours, 40 minutes on any standard Sony BVH 1000, 1100, and 1100A or Ampex VPR-1C, VPR-2 and VPR-2C Type C VTR with the Merlin ME 238 conversion kit.

Extended play time allows most full-length movies and sporting events to be recorded on a single 12½" reel. Ideal for master playback when dubbing to small format machines as well as for cable and broadcast automated programming.

# MERLIN

1880 Embarcadero, Palo Alto, CA 94303

Call Toll Free — 800-227-1980 (California — Call Collect 415-856-0900)

Merlin Engineering has a full range of products and assemblies for bringing your broadcast VTR up to date, as well as complete engineering facilities for custom applications. Write for your copy of the Merlin catalog.

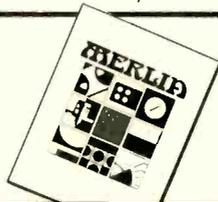

Circle 114 on Reader Service Card

# GIANTS COME IN ALL SIZES.

Model Shown: 3106 in the new American Data Gold. Just one in a complete line of quality multi-level video production systems. Simple to operate, yet advanced in design and reasonable in price.

 **American Data**

4C1 Wynn Dr • Research Park  
Huntsville, Alabama 35805  
Telephone (205) 837-5180  
TWX 810 726-2125

A Division of Central Dynamics Corp.

Circle 115 on Reader Service Card

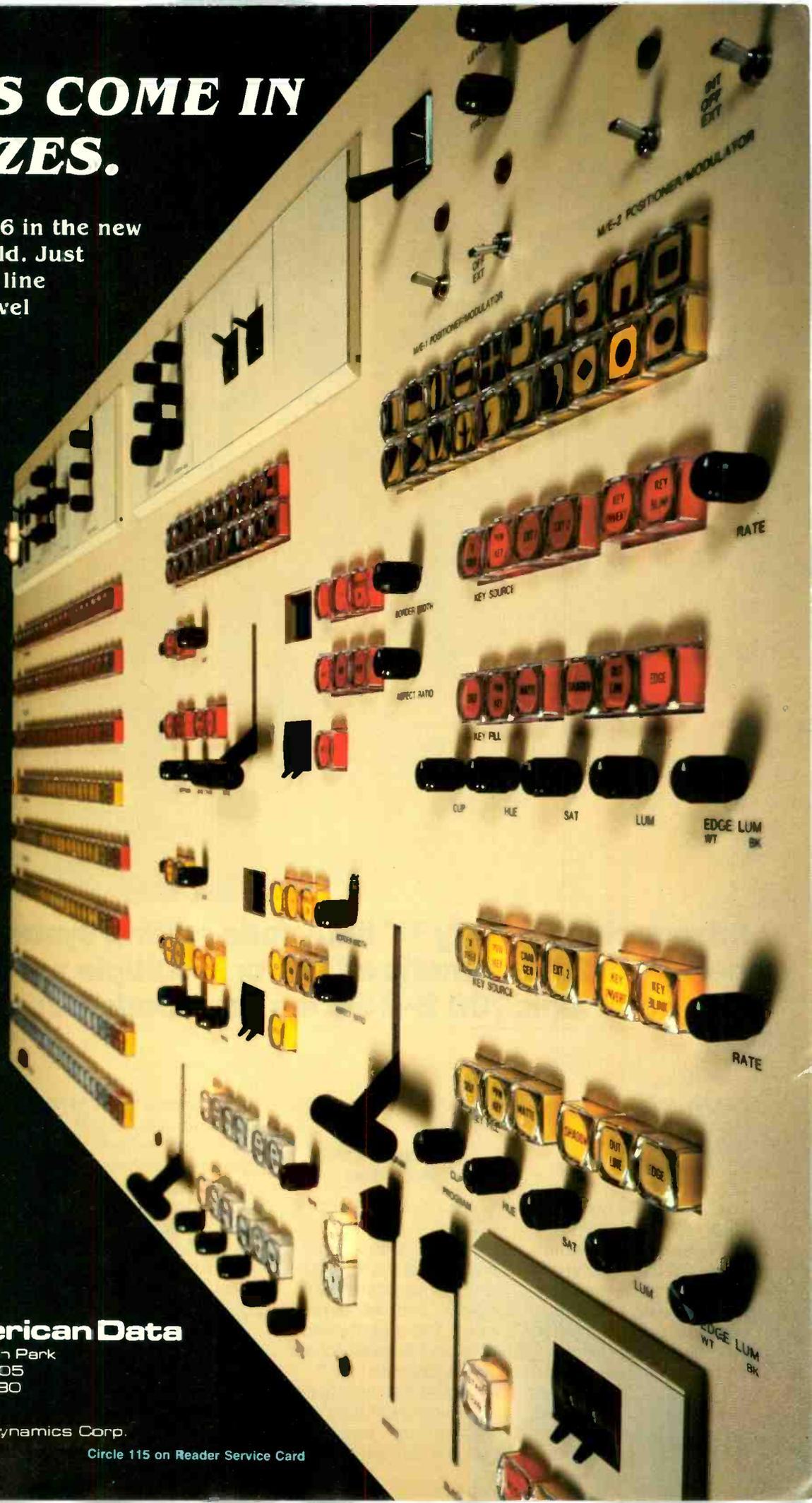



## Introducing the only $\frac{3}{4}$ " time code editing system that performs 20 automatic edits from multiple sources. The Panasonic 700 B-2 Series Time Code Editing System.

**700  
B-2  
SERIES**

Now Panasonic adds a new dimension to the speed and accuracy of time code editing with our new 700 B-2 Series Time Code Editing System. The AU-700 editing recorder, the AU-A70 programmable editing controller, and the AU-J10 multiple source adapter. Together they let you do what other time code editing systems don't: Perform up to 20 automatic, multiple-source insert and assembly edits. And the 700 B-2 Series is packed

with outstanding performance features.

### The precision of direct drive.



Check out the excellent stability and precision of the AU-700's direct-drive video head cylinder and capstan servo motor. The superb performance and durability of our crystal-oriented HPF™ heads. All combine to produce an outstanding picture with horizontal resolution of 260 lines color, 330 lines

monochrome and S/N ratio of 46 dB color, 50 dB monochrome. You'll also get an edit with less video noise because video head switching has been moved to the vertical interval so it never shows up in the picture. At the same time, we incorporated DUB IN and DUB OUT connectors with separate Y/C signals and a flying erase head. And to keep that good-looking picture looking good, all circuitry is mounted in a durable annealed aluminum die-cast chassis.

### The speed of microprocessors.



Another touch of ingenuity is the AU-700's microprocessor controls. Designed to work perfectly with the AU-A70 editing controller, they give you the speed, accuracy and versatility of full-logic, mode-to-mode switching. The AU-700 will accept SMPTE time code on a separate track or on audio track one as well as standard CTL pulses. And its electronic





Shown from left: AU-700 editing recorder, AU-A70 programmable editing controller.

digital tape counter displays LED readouts of CTL pulses in minutes and seconds—even in fast forward and rewind.

#### Multiple source versatility.

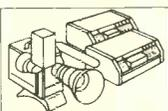

With our AU-A70 editing controller

not only can you generate and read time code pulses, microprocessors let it perform up to 20 time code edits automatically. Add an AU-J10 multiple source adapter and it will accept inputs

from two source decks and one live line plus perform A/B rolls. Microprocessors also let you automatically go to specific tape locations. You can also search both ways at speeds of 1/20X, 1/5X, 1X, 2X, 5X plus pause with picture. Other features include program check, program exchange, insert programming and overflow indication. For editing convenience, separate address time and lap time indicators are included. The AU-A70's error codes pinpoint any procedural

errors to avoid incorrectly programmed edits. The AU-A70 can also be used with any Panasonic solenoid-operated 3/4" and 1/2" VHS™ decks. For worldwide versatility, there is a built-in voltage selector that is compatible with 100V / 120V / 220V / 240V AC, at either 60 Hz or 50 Hz.

#### Total service capability.

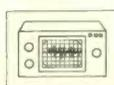

When it comes to servicing and maintaining the 700 B-2 Series, Panasonic backs you with a full net-

work of B-2 dealers, equipped with total service capability. Each has the parts and technical expertise that professionals require. For further information, call your nearest Panasonic office: Northeast—(201) 348-7620 Southeast—(404) 923-9700 Midwest—(312) 364-7936 Southwest—(214) 258-6400 West Coast—(213) 655-1111 The new 700 B-2 Series Time Code Editing System. Only from Panasonic.

**Panasonic.**  
VIDEO SYSTEMS DIVISION

# THE 1981

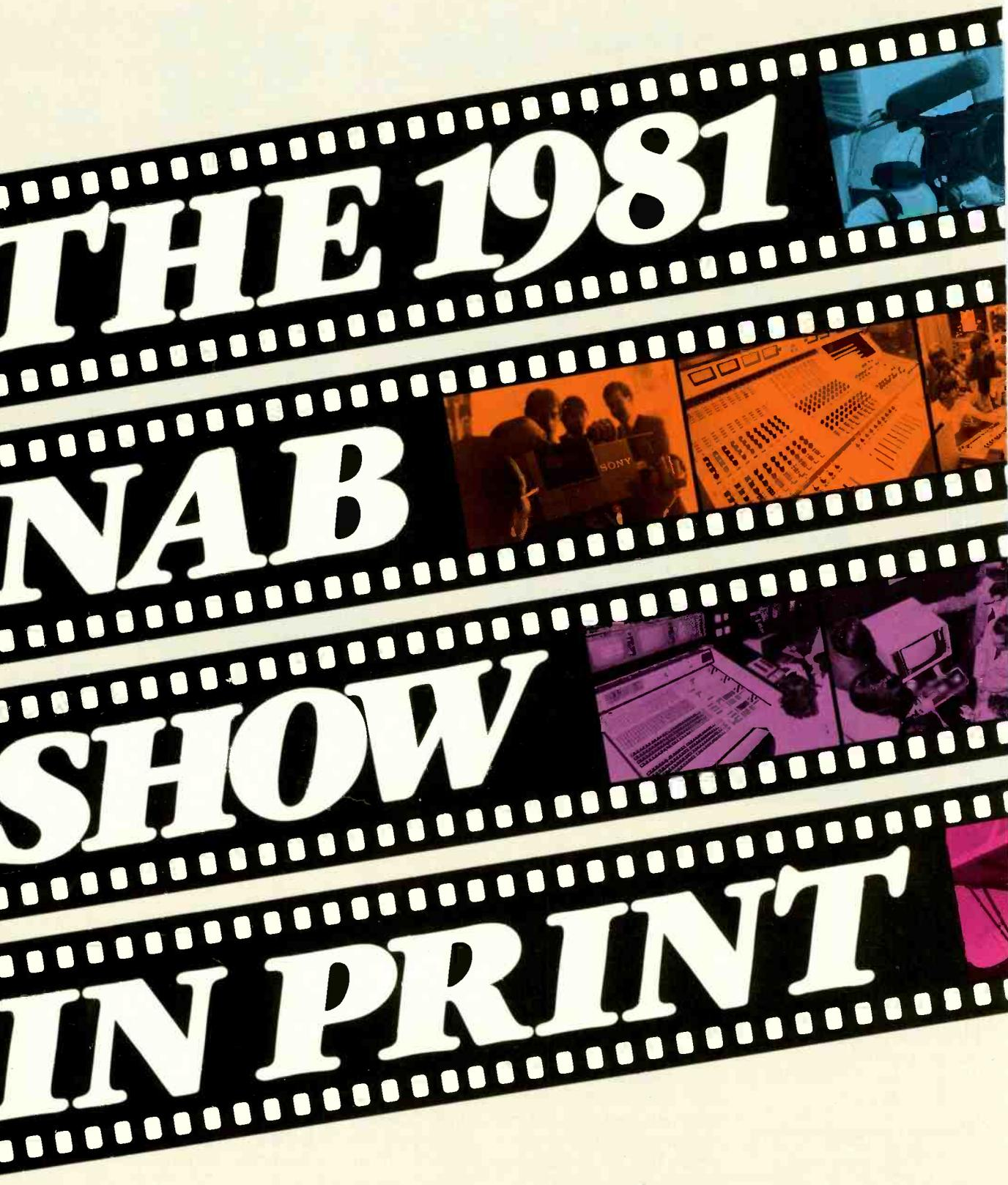

# NAB

# SHOW

# IN PRINT

*Thousands of broadcasters witnessed "dreams come true" in the one-piece camera/VTR; visions of better things yet to come with superior audio for radio and television and technical support for new ventures; low-power television, STV, and satellite networking.*

IN ONE OF THE BEST NABs in recent memory, genuine technical advances were made leaving broadcasters and exhibitors in a state of mild euphoria. In both radio and television, the broadcast industry seemed more self-assured and confident that the "emerging technologies" seemed at least as much an opportunity as a threat. According to exhibitors, the best evidence of this was the heavy purchasing of equipment that went on throughout the four day exhibit.

There was some grumbling about the size of the show, which featured 479 exhibit booths, and some foreboding over next year's Dallas site. A movement was afoot to have the show return to Las Vegas in 1982 but this seemed impossible given commitments already made by NAB for Dallas, and Las Vegas's own heavy '82 schedule of events. That Las Vegas wants the NAB back is no question at all. One Vegas taxi driver said, of the thousands of broadcasters in town: "This is the first time we've made any money since the (hotel) fires started scaring business away."

Radio broadcasters grumbled some too, stating that the show seemed heavily geared to television. Certainly, the show gave that impression given the flash and appeal of television exhibits. NAB did, however, make a valiant effort to balance its papers program and sessions between radio and television but that the momentum was decidedly on the television side was undeniable. Once again, many radio broadcasters were heard to suggest a separate "all-radio" NAB, perhaps in conjunction with NAB's Radio Programming Conference.

According to NAB, the 1981 convention in Las Vegas drew 5870 broadcasters as pre-registrants, exhibitors provided guest passes to 9890 individuals, many of whom were broadcasters, and the exhibitors themselves accounted for another 11,275 people. Hospitality suites drew some 4000 people for a total NAB body count of 31,035.

### **Television is more vibrant than ever**

There can be little doubt that the television industry grows more exciting each day. There is a general air of optimism around television's technology that promises to bring today's broadcasters into easy reach of the opportunities that lay ahead in satellite communication (see *BM/E* last month for NAB Satellite Report), low-power television, and subscription television. But this eye on the future has by no means diminished the industry's concentration on the issues at hand.

Equipment for newsgathering has taken a tremendous step forward with the introduction by RCA, Panasonic, Sony, and even For-A Co. (a relatively new but nonetheless innovative Japanese concern) of one-piece camera/VTR units. While the units from the big three use 1/2-in.

videocassette cartridges, few concerns were aired about "another format." All three of the major companies took care to offer easy integration of the new systems with existing technology. While RCA and Panasonic supply full post-production and studio support in half-inch, and see it eventually supplanting 3/4-in., Sony has opted to begin by making the new format compatible with 3/4-in. post-production systems.

For high-end program production, production and post-production equipment continue to surge ahead in their use of the computer. Automatic set-up cameras, computer assisted switching, and computer aided post-production controllers are talking to each other and working together to give the producer unprecedented creative freedom. The awesome power of computer control and digital processing were graphically demonstrated by the flood of major digital art systems and surge in character generator capacity. Uniformly, broadcast engineers and managers began to talk enthusiastically of the day when a digital standard for communication and control would arrive to bring all of this equipment into efficient use.

In the five sections of this report that follow, broadcasters will see clearly that the technology is available to create highly efficient radio and television facilities. The burden is now on broadcasters to throw out the old assumptions and to begin to look at new applications for this technology. The broadcast industry is about to enter an age more competitive than any it has seen before but it has the tools to create the services and images that will capture the public's attention this year and in the years ahead.

### **Radio to get the listener's ear with higher quality**

For most makers of radio broadcasting gear it was an excellent show. The broadcasters came in a serious mood. Exhibitors were pleased with the prevalence of real buying interest among the visitors to the booths.

The health on the exhibit floor reflects the health of the radio industry, with sales and profits at the highest levels in history. Radio is doing very well, and makers of radio gear are riding high along with the broadcasters.

But radio broadcasters can see coming up the road an array of competitors for the ears of the public. Competition from home high-fidelity systems has been massive for a long time and is still growing. Coming up toward large-scale use is the videocassette machine, and the videodisc has just made a strong entry. A few years off is the digital audio disk. All these alternate entertainment media bring top-grade audio and will be putting more and more pressure on the technical quality of the radio signal.

Adding to the push on quality from these "outside" sources is the high quality of satellite distribution. Broadcasters are showing their awareness of the need to have a high-grade signal in a number of ways. For instance, they

## NAB SHOW IN PRINT

are buying high-priced, high-performance cart machines, such as the ITC Series 99 and the Pacific Recorders Tomcat, in large numbers. In fact, exhibitors at the show reported a general trend among broadcasters to pay much less attention to price than in the past; it was all-out performance they were after. A new unit that seemed to guarantee superlative handling of the audio signal was the



### NAB . . . More To Come

NAB, 1981: an industry headed into uncharted waters. Manufacturers have offered broadcasters sleek new vessels in which to face the years ahead. The skeptics amongst us wonder if these "things of beauty" will endure against the rigors of a practical competitive broadcast environment. Next month, in *BM/E's* July issue, we'll answer that question. Whatever the industry selects as the technology appropriate to the task ahead, it will have to maintain, support, and grow with it. In the July issue of *BM/E*, Test and Measurement for today's broadcast facility will be the topic. We'll look at what is available to support all the 1981 technology and how best to pursue — not the optimum plant — but the real plant. Part of that report will include all of the latest details on T&M equipment introduced in Las Vegas.

Two other topics at NAB '81, deserved more thorough treatment than could be provided here: Broadcast Vehicles and Pay-Television. *BM/E* will give you the full story on these two vital concerns next month when we'll be able to tell you why they are important as well as what is available.

one that stirred the broadcasters.

A closely related phenomenon is what seems to be the beginning of the end of the "loudness war," the push for super modulation density that has afflicted American radio for a number of years. A number of industry observers told *BM/E* that many broadcasters, especially in highly competitive markets, are backing away from the drive to squeeze the last half-dB of modulation through their transmitters. They have found that the distortion from extra-heavy processing causes listener ear fatigue and drives the audience away.

These broadcasters are now looking for a "clean" signal that will stand comparison with the average stereo disc and home high fidelity system. The makers of audio processors are helping by emphasizing the low distortion their systems produce when they are used carefully (more on processors below.)

The satellites, as reported in detail in last month's issue, were the big hardware story for radio. Makers of radio earth stations got plenty of "serious" booth traffic: radio broadcasters in substantial numbers are looking for the Satellite Connection. The satellites are, of course, not just a new kind of radio hardware — they are a massive programming revolution. They are going to affect radio operation fundamentally: for instance, full-scale satellite programming will alter sharply the way many radio broadcasters use program automation.

Another lift to quality is embodied in some of the new AM transmitters, which incorporate much more careful handling of the audio signal than was prevalent among AM transmitters in the past. Three of these new-age AM transmitters were described in detail in the May issue: the Continental Model 317C-2, 50 kW AM; the Harris MW-50B, another 50 kW AM; and the RCA BTA-5SS, 5 kW AM. All were on the exhibit floor. Also on the floor were a substantial number of high-performance FM transmitters from a number of makers, as detailed below.

In the best consoles, turntables, reel-to-reel tape recorders, microphones, and audio amplifiers, the fidelity has been extremely high for a long time. The exhibits of these studio items continued and extended the opportunities to build studios for radio with top-most fidelity. There was, for instance, a mini-explosion in wireless microphones that can hold their own with the best wired types (see below). Turntable preamplifiers with extraordinary precision in performance continued to appear.

The trends in test equipment, too, continued along the line established in recent years toward much higher precision and much easier operation. The upgrade in radio technical quality must have high-precision test equipment to sustain it.

Other categories of equipment in which the upgrade appeared and was supported were intercoms, telco interface equipment, and studio-transmitter links.

The summary of radio at the 59th Annual Convention of The National Association of Broadcasters therefore stands as follows: the broadcasters came with another record year under their belts, by and large satisfied with the present. But they know that their future hangs on a signal of high technical quality, one competitive with today's superb stereo discs and home high fidelity systems and with tomorrow's videocassette machines, videodiscs, and digital recording. The broadcasters were shopping for equipment that would help them produce such a signal. Fortunately for them and the future of radio, the equipment was there.



Julius Barnathan, President  
Broadcast Operations and Engineering  
American Broadcasting Company



## PARTNERS IN PRODUCTION

The CHYRON® IV is a vital member of the ABC production team. For most of the leading TV stations and production houses, CHYRON has become their indispensable "canvas, brush and palette."

And, like Picasso, with these tools they create some of the most memorable graphics in the world...

Follow the Leaders with

# CHYRON

TELESYSTEMS

A DIVISION OF CHYRON CORPORATION  
265 Betpage-Spagnoli Rd., Melville, N.Y. 11747  
516-249-3236 • Telex: 144522 Chyron Melv

Ampex International is exclusive distributor for  
Chyron Graphics Systems outside the U.S.A.

Circle 117 on Reader Service Card

# RCA CP ANTENNAS RUN CIRCLES AROUND

## Outsell nearest competitor by 2 to 1.

RCA CP antennas outsell the nearest competitor by more than 2 to 1 for good reason. And there are many more good reasons why RCA has sold 6 out of 10 of the CP antennas on order at the close of 1980. But the bottomline is customer trust and user confidence in RCA CP antennas...and the people who produce them. RCA developed and installed the first commercial CP antenna at WLS Chicago in 1973. Then, as now, RCA engineering, product performance, installation and service support run CP circles around the others.

## Engineered like no others.

When you see the care and craftsmanship that go into each antenna at the RCA Antenna Engineering Center in Gibbsboro, N.J., you'll know why our CP's are as good as they are. They're engineered with experience unmatched anywhere,

and built to last. For example, feed-line hardware is made from bronze, brass or stainless steel. Feedlines are firmly grounded to the antenna pole at multiple grounding points to eliminate arcing and protect against lightning.



## Performance tested for sure results.

We test our antennas on every channel for both horizontal and vertical polarization on giant turntables, with the results fed into computers. With this information we've built an enormous data bank from which we can reproduce characteristics for any type of antenna.

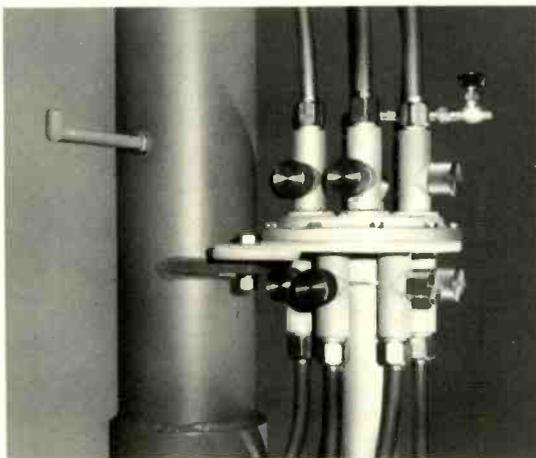

### RCA Circularly-polarized antennas at these stations:

KCPQ (13), Tacoma, WA.  
KCRA (3), Sacramento, CA.  
KSTW (11), Tacoma, WA.  
WABC (7), N.Y., N.Y.  
WBNS (10), Columbus, OH.  
WBTW (13), Florence, SC.

WCTI (12), New Bern, NC.  
WFMY (2), Greensboro, NC.  
WITN (7), Washington, NC.  
WLS (7), Chicago, IL.  
WNCT (9), Washington, NC.

WPBT (2), Miami, FL.  
WRAL (5), Raleigh, NC.  
WVTM (13), Birmingham, AL.  
WTTV (4), Indianapolis, IN.  
WTVD (11), Durham, NC.

XETV (6), Tijuana, MX.  
Difusora (4), Sao Paulo, Brazil  
Korean Broadcasting System (9), Seoul  
TV Litoral (3), Buenos Aires, Argentina  
TV Nacional (7), Santiago, CH.

# THE OTHERS

## Installation, service simplified.

We design our CP antennas for low windloading. That means you can install most of our antennas on your existing tower, probably without tower modifications. To further simplify installations on most types, there's only one feed line on each radiator, instead of the usual two. Fiberglass and steel pole steps are provided for climbing the antenna. We look after the installation to get you on-air properly, and provide incomparable RCA TechAlert service to keep you on.

We think RCA CP antennas are the best choice you can make. Their record in the field proves their superiority beyond question. For the details, call your local RCA Broadcast Representative. Or write RCA Broadcast Systems, Building 2-2, Camden, N.J. 08102.

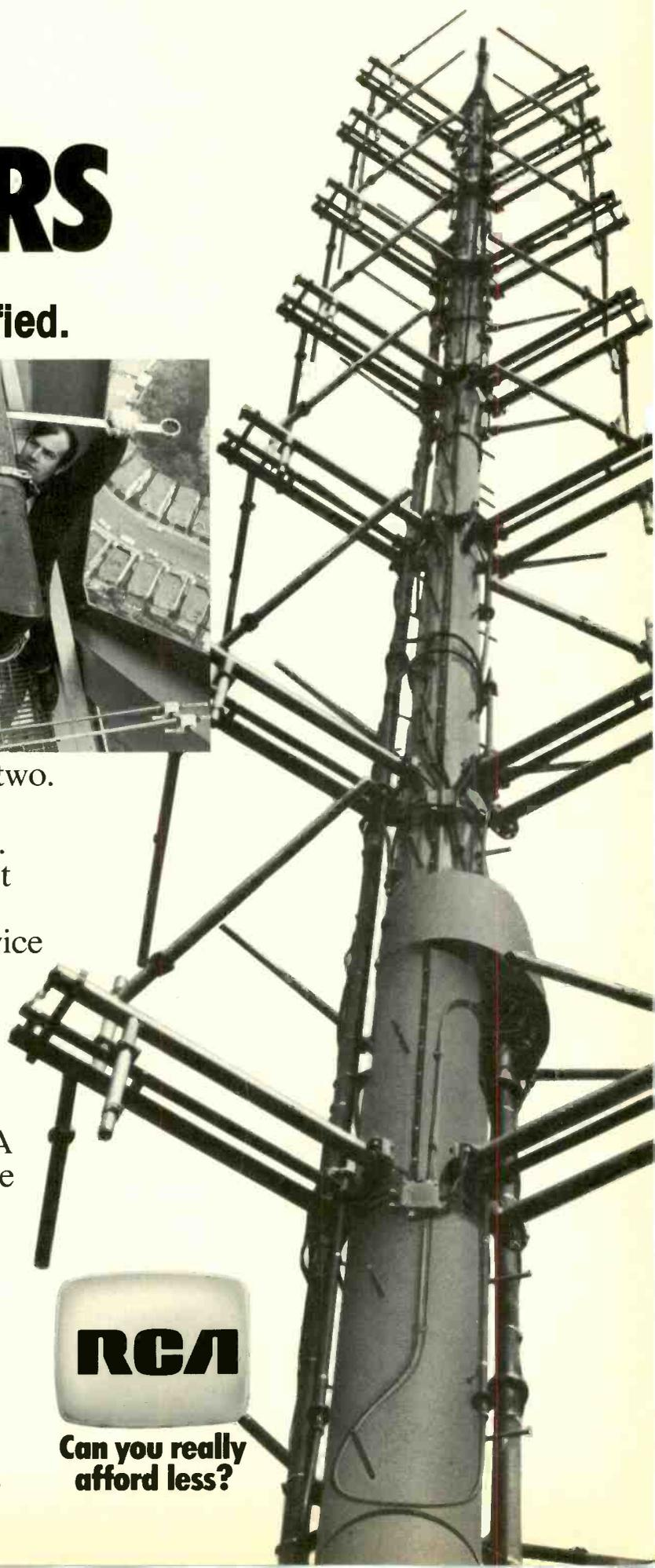
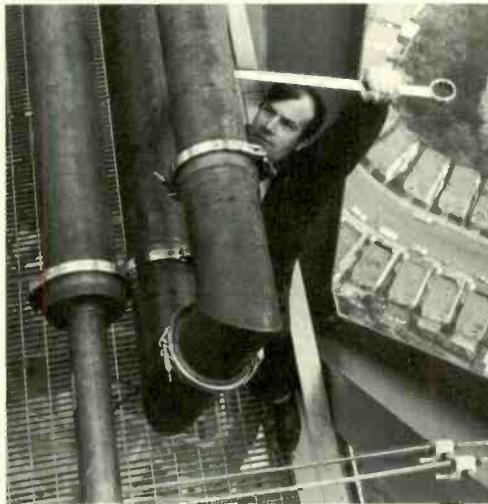

### The RCA CP antenna line

Type TDM—Dual Mode, Top Mount, Lowband VHF—Ch. 2-6  
Type TCL—Tetra Coil, Top Mount, Highband VHF—Ch. 7-13  
Type TFU-CP—UHF Pylon, Top Mount—CH. 14-70  
Type TBK—Quatrefoil, Side Mount, Lowband VHF—Ch. 2-6  
Type TBJ—Panel, Top or Side Mount, Highband VHF—Ch. 7-13



**Can you really  
afford less?**

# "the Controller"

\$1,995.00



... is a microprocessor based editing system able to operate with all major 3/4-inch and 1/2-inch VCRs without any modifications. Simple, rugged, and reliable, it provides you with outstanding performance and features, in a variety of configurations at an attractive price. A 2-year unconditional guarantee assures your uninterrupted use of the product. Furthermore, you may satisfy your future production growth with our 100% trade-in provision towards the purchase of any of our "Executive" line of advanced editing systems. Write us on your Company letter-head for a free evaluation at your own facility, or call your favorite distributor... chances are he's one of ours.

**Cezar International, LTD.**

1026 W. Maude Ave., Sunnyvale, CA 94086  
Telephone (408) 733-1436

**"The Originators"**



# NAB SHOW IN PRINT CAMERAS AND VTRS LEAP AHEAD



**The one-piece camera/VTR is at last a reality. Recording technology progresses towards higher quality with special purpose designs.**

## Four ENG recording cameras introduced

The arrival of a combination color TV camera and recording unit has been predicted for some time now as the next logical ENG development. It was generally assumed that the first such integrated camera/recorders would not arrive until a solid-state pickup array was ready. Therefore it came as some surprise at the 1981 NAB Convention to see not just one but four new combination camera/recorders — three as integrated units, the fourth as a hybrid.

Exhibiting the completely integrated systems were RCA, Panasonic, and Sony. The recorder portions of these three systems use half-inch tape, but achieve performance better than that obtainable with 3/4-inch videocassette recorders.

The hybrid combination camera/recorder, on display at various times in both the A.F. Associates and For-A exhibits, was actually a system developed by the Nippon Television Network of Japan.

The RCA and Panasonic units were similar in that both used the same recorder, described as a "joint development of Matsushita Electrical Industrial Co. Ltd. of Osaka, Japan [Panasonic's parent] and the RCA Corp." The com-

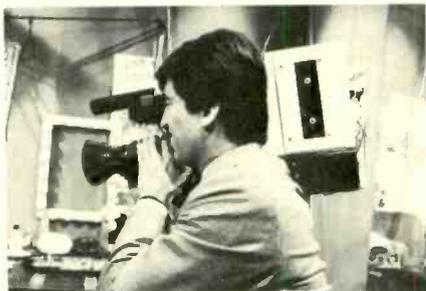

Panasonic showed a completely integrated camera/VTR system featuring the recorder developed by Matsushita and RCA

compact recorder uses standard VHS cassettes. The Sony unit differs in that it is designed to use L 500 Beta videocassettes as the recording medium.

The two new formats are in no way similar to those used in the VHS or Betamax consumer products and they are not compatible with each other.

Baseband recording techniques are used, most likely with separate luminance and chrominance channels being recorded. RCA, which had more printed literature than the others, said the new format, which it called Chroma Trak, improved chrominance resolution, distortion, and noise by a factor better than 3:1 compared to 3/4-inch cassette systems. Two audio tracks plus a dedicated time code track are included. All systems get 20 minutes of recording time from standard one-hour cassettes.

The camera portions of the three integrated systems were quite different. RCA's system (called Hawkeye) uses new half-inch pickup tubes, either Plumbicons® or Saticons®, that offer performance equal to 2/3-inch tubes. The Sony camera uses a new single-tube highband SMF Trinicon. Panasonic elected to stay with three 2/3-inch pickup tubes designed into a new camera head.

The RCA and Panasonic systems include, in addition to the combination camera/recorder, full-featured studio editing recorder systems. All functions on the new studio units are controlled by soft-touch controls. Other features of the editing recorder/player include individual edit point selection, preview, review, and return to go functions, and LED time/lap time indicators.

With just a single tube, the Sony BVW-1 was the lightest in weight. Including lens and battery, the BVW-1 weighs 15 pounds and measures 110 by 360 by 200 mm. Recording time is 20 minutes but continuous recording time was stated to be over one hour per battery. RCA's Hawkeye unit (HCR-1) weighs 21.5 pounds. The Panasonic unit with 2/3-inch tubes weighs a trifle more — 22 pounds.

The new combination systems permit TV camera manufacturers to boast complete mobility. (Cases are sealed against dirt, moisture, and RFI.) RCA stressed that its unit "handles like a

film camera." According to the company, with no camera to recorder connecting cables to interfere, the operator has complete maneuverability — one of the frequent causes of technical problems in field.

The use of half-inch tubes in no way hurts performance, RCA asserts. While the smaller tubes theoretically offer a lower S/N, a new optical system that is very fast (f/1.4) compensates for this.



Sony's one-piece camera/VTR was the lightest of the three integrated units



RCA's Hawkeye weighs less than early TK-76's without lens and battery

More glass can be used, giving an f/1.4 rating without increasing the weight of the lens. Camera head circuitry improvements, in combination with a new rigid prism optic system, permit camera picture quality to meet or exceed that of 2/3-inch tubes.

The Hawkeye's viewfinder includes LED displays that indicate battery status and verify that there is a signal on the tape. The display also indicates shooting time remaining and end of the tape.

Among the camera features are automatic white balance, black balance, flare control, automatic iris with variable spot size, and automatic comet tail suppression. The camera includes a 30-day memory for balance setting and features a six-position filter wheel. The battery is a snap-in type. A live encoded

## NAB SHOW IN PRINT



Sharp's lightweight camera was displayed in hand-held and studio configurations



Visitors at A.F. Associates and For-A saw NTV's hybrid camera/VTR

output is also available to feed other VTRs or a monitor.

The camera can be separated from the recorder so that the latter can be slung over a shoulder or carried by another person. When linked to its genlock adaptor, the camera can be tied with microwave feeds, the HR-2 studio recorder, or other videotape units.

Sony stressed that its BVW-1 concept has system compatibility with U-Matic and one-inch videotape recorders. Recordings from the BVW-1 can be transferred for editing to these other formats, Sony said. In its demonstration suite, cassettes were dropped into a player controlled by an edit controller. (This same controller also operated a new BVU-800 U-Matic videocassette recorder; see section on 3/4-inch advances.) Recordings from the quarter-inch tape hybrid system, the CV-One, were played back and edited (without dubbing into another format) through the use of the CVF-6000 videocassette recorder/player unit from For-A. This unit includes remote control, various shuttle speeds (twice normal, one-fifth, and one-twentieth), a pause control, and reverse modes of operation. It is compatible with a TBC and has a capstan servo mechanism that locks to external sync vertical drive.

This system uses the Funai format, a helical scan format with two rotating

heads. Tape speed is 32.1 mm/s. Both luminance and chrominance signals are recorded; the former is frequency modulated, while the latter goes through a "chroma-conversion." The system uses CVC cassettes, which are about the size of audio cassettes. CV-One is considered to be in the development stage and the camera manufacturer has not been identified. The unit will be marketed in a year.

Both RCA and Panasonic promised production units of their respective systems by the first quarter of 1982. It was quite evident from the exhibits that the systems are complete and that the two companies were ready to take orders. Sony, on the other hand, anticipated marketing its system in Spring 1982.

**For more information:** RCA Hawk-eye, 299; Sony BVW-1, 300; Panasonic, 301; A.F. Associates/For-A CV-One, 302.

### New high resolution one-tube cameras

The new Sony BVW-1 VTR-in-camera system, as just described, incorporates a single highband SMF Trinitron. This same tube has become the basis of another new camera, available as a separate unit, the BVP-110.

Weighing in at about six pounds without lens, the camera is lightweight and about half the size of conventional three-tube cameras. It draws only 9 W of power. The Sony-patented tube is called the HBST (High Band Saticon Trinitron) for short. Incorporation of a Saticon photoconductor layer results in high sensitivity and resolution with "excellent" spectral response. The camera is expected to be priced in the \$10,000-\$15,000 range.

The tube's built-in bias light reduces lag and an automatic beam control system suppresses comet tailing effects and beam defocusing when bright spectrals are encountered in a scene.

Sony said the tube's unique deposited electrostatic deflection electrodes, combined with a new electron gun assembly, provide absolute and precise control over beam spot size and position. Improved RGB filter dimensions result in a horizontal resolution of 400 TV lines, according to Sony.

The camera includes an NTSC encoder with a two-line enhancer. A color framing pulse enables VTR synchronization during edits.

Automatic light balance can be stored digitally for later use. This enables the camera operator to reset white balance to new light conditions, retrieve a previous setting, or use a preset balance condition. A variety of zoom lenses are available. The new camera is expected to be ready for delivery by the end of next year.

Hitachi also showed a new high-performance single-tube camera, the FP-10, with an expected price tag of \$7500. While Sony boasts a resolution of 400 TV lines, Hitachi claims 430 for the FP-10, which incorporates a new one-inch tri-electrode HS302 Saticon. Claimed S/N is 48 dB. Sensitivity is listed as 2000 lux at f/4 (grey scale 89.9 percent reflected); -6 dB and -12 dB high gain switches are included.

Both the Sony BVP-110 and the Hitachi FP-10 carry one-tube cameras to a new performance high. The Hitachi tube, like the Sony, has a built-in bias light for reducing lag. The FP-10 camera has an automatic beam optimization circuit to extend dynamic range and reduce comet tailing. The FP-10 also includes a number of automatic features, for example, built-in four-position color temperature corrector filter, built-in color bars, and genlock. A 1H delay line improves vertical contours; a two-line enhancer is available as an option. The FP-10 can be controlled remotely through the use of a serial data transmission system.

An optional five-inch viewfinder converts the FP-10 into a studio camera. The FP-10 weighs about 11.5 pounds and draws about 15 W.

There were several other new one-tube cameras in the lower price range, all aimed at the market garnered by the Panasonic WV3900. JVC introduced the S-100 U, which has a Saticon with a color-striped filter and provides 282 lines of resolution and 45 dB S/N. It boasts a sound zoom microphone — an industry first. Switches permit omnidirectional, superdirectional, and auto-zoom operation. This camera features many automatics at a price under \$3500. Hitachi also showed a low-end line of one-inch tube cameras but did not promote them for broadcasters.

**For more information:** Sony BVP-110, 303; Hitachi FP-10, 304; JVC S-100 U, 305.

### Under-\$20,000 ENG's improve

Advantages such as low weight, low power, and perfect registration offered by the improved one-tube cameras made them serious challengers for the lower-priced end of the ENG range. Choosing a camera remains difficult, however, due to the growing sophistication of three-tube models.

JVC has improved upon the KY-2000, which this spring reached 2000 in sales. The new KY-2700, introduced at NAB, provides horizontal and vertical contour correction thanks to new circuitry. Its improved deflection yoke has increased registration accuracy in the second and third zones to 0.2 percent and 0.4 percent, respectively. The KY-2700U boasts a S/N ratio of more than 54 dB with 230 foot candles at f/4.0 (contour correction off).

# ON THE OTHER HAND, OUR ROUTING SWITCHERS HANDLE GROWTH VERY NICELY.

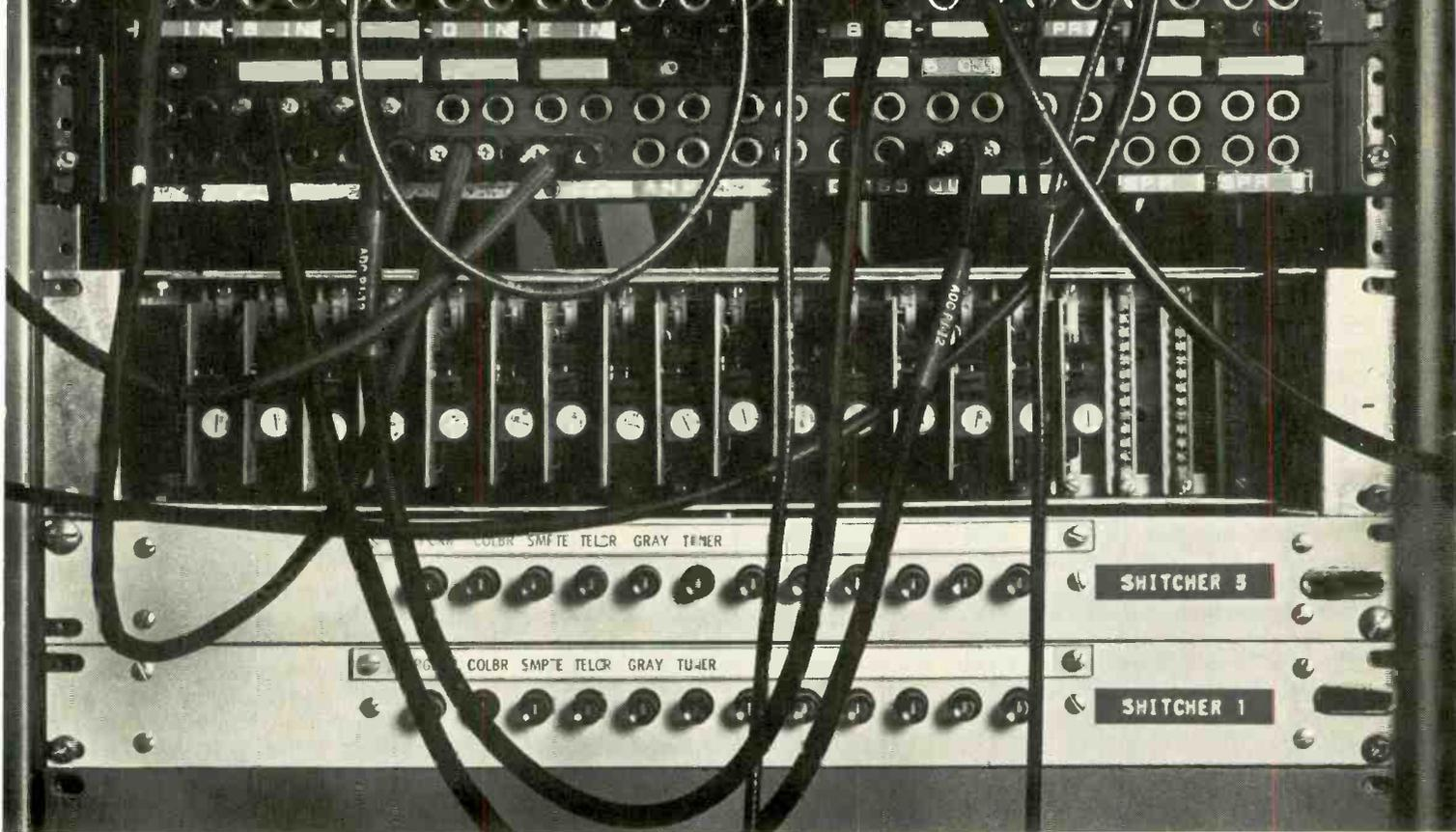

With a microprocessor-based 3M routing switcher, you can eliminate the problems of hard wiring once and for all. And specify just about any type of control you want.

It all depends on how you'd like to set it up. Our design engineers can then tailor the matrix for you. From your smallest requirement on up to any desired size. And they'll help you select the control that's best suited to your needs, too.

The choice is yours. Touchpad, thumbwheel, illuminated or L.E.D. pushbutton, machine, X-Y, or alphanumeric universal control. Even a terminal control that allows you "supervisory" control throughout the system, or computer control through our RS-232 port.

What's more, 3M routing switchers are easily expandable. Start with a matrix that matches your present requirements. Then as your studio grows, your routing switcher does, too. With the simple addition of extra frames and switch cards.

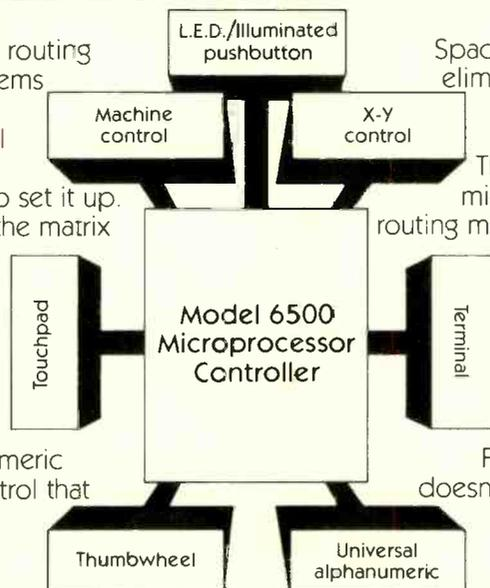

Space-guzzling, multi-conductor cables are eliminated. And so are unnecessary output panels. Because with our system, outputs can be reallocated as required.

The heart of the system, the Model 6500 microprocessor, as well as controlling the routing matrix, can be integrated with a machine control system to offer absolute production control of film chains, VTR's and other production machines.

Or it can be used as a stand-alone machine control system which offers the same coaxial wiring and expandability of the routing switcher panel.

Finally, a routing switcher whose growth doesn't depend on the size of your building.

For more information about 3M routing switchers, or a custom design consultation for your studio, call collect, (612) 736-1032. Or write on your letterhead to: Video Products/3M, Bldg 223-5E/ 3M Center, St. Paul, MN 55144.

**THE ROUTING SWITCHERS THAT GROW  
AS YOUR NEEDS GROW.**

## NAB SHOW IN PRINT



Sony's tiny BVP-110 has the same single Tricon pickup tube as the BVW-1 one-piece



The Hitachi FP-10 one-tube camera boasts 430 lines H resolution

The additional circuitry has increased weight to 11.6 pounds — half a pound heavier than the older KY-2000U. The unit is about half an inch wider to accommodate the new circuitry.

The KY-2700U sports a 14:1 zoom with an  $f/1.6$  relative aperture. This lens is faster than that supplied with the KY-2000U and has improved outer area focus and lower distortion. The new unit has most of the usual built-ins including automatic white balance with memory and automatic beam control. The \$11,990 suggested price of the KY-2700U makes its cost about the same as the new performance one-tube cameras.

Hitachi introduced two new cameras described as "professional high-quality cameras ideal for ENG and EFP." Known as FP-21 and FP-22, the cameras are quite different from the FP-20S industrial camera. As a result of a new prism beamsplitter and low noise preamps, they feature horizontal resolution of 550 lines at center, an S/N ratio of 55 dB, and built-in H and V contour correctors. The FP-22 incorporates digital auto setup, complete computer control of auto centering pedestal, and pulse cancellation. Previous setup information is held digitally in the memory even when power is turned off.

The camera's ABO circuit extends the dynamic range and reduces comet tailing. There is a diagnostic indicator in the CPU unit. The FP-22 weighs 12 pounds (excluding lens and viewfinders); the FP-21, minus the digital microprocessor, weighs 11.2 pounds. The \$18,000 price of the FP-22 is quite remarkable for so many features.

The new JVC KY-2700U and the Hitachi FP-21/22 series are, in a sense, a response to last year's improvements in low-priced cameras marketed by Sharp — the XC-700. Over the year the \$12,600 XC-700 became a best-seller — over 500, according to the company. This year Sharp introduced a two-line

vertical enhancer (\$1400) as an option.

A new approach to spare parts was the biggest attention-getter at the Sharp exhibit. The company offered a complete spare parts kit consisting of all the printed circuit boards, mother board, and power modules used in the XC-700 (B/E counted 19 pieces). The kit is priced at \$1995.

**For more information:** JVC KY-2700, 306; Hitachi FP-21, 307; FP-22, 308; Sharp vertical enhancer option, 309; spare parts kit, 310.

### Top line portables advance

High quality and automatic features for less than \$20,000 have created a market for lower-priced cameras, but there was also something at NAB '81 for those who want the very best.

Last year Ampex promised the most with its BCC-20 Digidcam. As a result of its exclusive Spatial Error Correction System, Ampex's computerized setup camera offered a new high in picture quality (registration accuracy of 0.05 percent in all three zones, geometry distortion less than 0.1 percent in all zones). This year Ampex showed how its Master Setup Panel (MSP) could control eight BCC 20s — or eight BCC-21s (a BCC-20 converted into a studio field production camera).

During the past year two new top-of-the-line ENG/EFP cameras emerged at the 122nd SMPTE Exhibition and Convention in November, 1980. Both were reshown to NAB audiences. RCA introduced the successor to the famous TK-76 — the TK-86. It included a new sealed  $f/1.4$  beamsplitter and was lighter and easier on power.

Toshiba was the other mid-year newsmaker with its introduction of the PK-60. Weighing only 9.24 pounds, drawing only 20.6 W, and delivering S/N better than -54 dB with standard lead oxide tubes, this camera head is truly state of the art. It can be operated

remotely by digital means and can be set up automatically by a digital master controller. An analog version offers up to 5000 feet of separation between the camera and the base station through triax. (A wireless triax system using a microwave link is also possible.)

The digital remote system designed for the PK-60 was unveiled at NAB. This latest system incorporates Digital Data Loc™ — a microprocessor-controlled adaptor that plugs into a connector at the rear of the camera head. An auto setup box and/or a digital base station are also available.

Command signals can be sent from the auto setup box directly into Digital Data Loc or remotely via the digital base station, which in turn connects to the auto setup box.

Stored data is converted to analog and supplied to the camera, always maintaining initial setup levels. Since the memory is non-volatile, the setup levels are retained.

Compensation data from the auto setup box can be stored at the Digital Data Loc, allowing the box to be disconnected from the camera to set up additional cameras sequentially.

During this past year Philips began talking about its LDK-14S, the most recent version of the popular LDK-14 model. It was performing at NAB '81. The 14S uses new diode gun Plumbicons. New low-noise FETs, mounted on the tube target contact, yield high S/N ratios and provide protection from spurious signals. A new high-transmission  $f/1.4$  prism system is incorporated. These features plus those earlier associated with the LDK-14 make it a no-compromise EFP portable.

A totally new camera, the HL-83, was announced by Ikegami, who said this camera introduced a new era. It's smaller in size, lighter in weight, and uses less power than the HL-79D, yet it has all of the performance operational features required by broadcasters.

Weighing less than 10 pounds in-



# VERSATILE.

## O'Connor Model-50. A fluid head with 378 combinations.

### NEW, ADJUSTABLE BALANCE, QUICK RELEASE PLATFORM.

The Model 50-D Fluid Head can be ordered with one of six different platforms. Each has its special features and purposes, but our newest is the ultimate.

First, it has a unique camera mounting plate which can be attached to your camera in one of eight different positions. This is used to balance your camera on the head, greatly improving the head's performance.

Besides an adjustable camera mounting plate, the entire platform (with camera atop) can be shifted



back and forth on the head so that you can find the precise center of gravity for whatever particular gear you're using at any given moment, such as heavy lenses, large magazines, etc.

It takes only a second to release your entire camera with O'Connor's new quick release option. To prevent accidental releases, it has a built-in safety feature.

### WITH BASES, WE'RE LOADED.

The Model 50 can be ordered with one of six bases. Besides two Pro Jr. types, Mitchell, Arri 16 and

Arri 35, we also offer the O'Connor Claw Ball Base with the "ultra positive grip." The distinctive aluminum ridges



dramatically increase the holding power with far less effort needed to secure it in position. This Claw Ball design can also be adjusted  $\pm 15^\circ$  to the horizontal plane within the top casting of the tripod to correct or alter your panning plane.

### O'CONNOR COUNTERBALANCE DEFIES GRAVITY.

Three counterbalance spring options are available for the Model 50. It is important that you use the proper method to determine which spring is correct for your needs. If you're not sure, consult an O'Connor dealer or talk to us direct.

When you have the correct counterbalance spring, you should be able to stop the camera at any point in the normal tilting range and release the handle without the camera moving.

And it should take no more effort to tilt it upward than it does to tilt it downward. We specifically design counterbalance into all our heads to correct this natural act of gravity so that your "tilts" are as steady as your "pans."

### MORE CONTROLS FOR MORE CONTROL.

Like all O'Connor heads, the Model 50 is designed to provide maximum versatility. Separate controls for the pan drag, pan lock, tilt drag and tilt lock—all improve the flexibility and repeatability of camera movement.

### O'CONNOR HAS MORE OPTIONS.

More options mean a more versatile system for you. In addition to some of the items already mentioned for the Model 50, we also have adjustable double video handles, hi-hats, cases, adapters, teak tripods and the ever amazing Hydro-ped.

### ORDER IT YOUR WAY.

The basic O'Connor Model 50 fluid camera head can be ordered 378 different ways. If you're not sure how you want yours, maybe you should send for our brochure and price list to help you pick the equipment that's perfect for your needs.

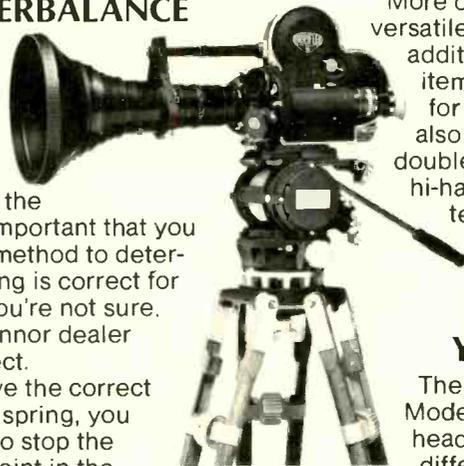

# O'Connor

FLUID CAMERA HEADS

O'Connor Engineering Labs., Inc., 100 Kalmus Drive, Costa Mesa, CA 92626 • (714) 979-3993 • TELEX 685 641  
O'Connor Engineering Ltd., 14 Av. Industrielle, 1227 Carouge, Geneva, Switzerland • Phone (022) 42 79 38 • TELEX 28 449

## NAB SHOW IN PRINT



Harris's TC-85 features computer setup of fine registration, black and white balance, gamma, and flare



JVC's camera display highlighted the improved KY-2700U, successor to the KY-2000

cluding viewfinder, the new camera is amenable to having a miniature VCR attached to it (presumably the quarter-inch For-A or Technicolor system).

The HL-83 draws only 15 W which permits up to three hours of operation with an attachable Ni-cad battery. The system boasts a  $f/1.4$  prism system with bias light and a 57 dB S/N ratio.

Both Thomson-CSF and Sony have refined their portable camera product lines into essentially two cameras each (Sony manufactures the units under license from Thomson-CSF).

In the new line-up, Thomson-CSF has apparently retained the term Microcam only for the 501 series. The 501 is a lower-priced version of the MC-701. The MC-701 is described as a three-in-one camera (a studio camera, an on-location camera with multi-core or triax to a CCU, and an ENG/EFP one-piece camera). The MC-710 ENG/EFP version weighs 11.4 pounds and includes automatic color balance and auto registration centering. A diode gun tube can be used. The MC-501 offers two-line enhancement and automatic white/black balance.

Sony refers to its versions as the improved BVP-300A and the BVP-250. Through low-noise FET preamps, the BVP-300A has an S/N ratio of 56 dB, compared to 53 dB for the older BVP-300. (The Thomson-CSF 701 claims 57 dB, but with a diode gun tube. Sony's

diode gun version is the BVP-330.)

The BVP-250, derived from the 300A, offers stable auto color balance and an S/N of 54 dB, but no automatic beam optimization.

Hitachi continued to show its top-of-the-line cameras, the SK-91 (\$33,000) and its slightly heavier and lower-quality cousin the SK-81 (\$23,000.) It also showed the general-purpose FP-40S. Likewise, Toshiba continued to show its older units such as the PK-39 ENG/EFP camera. Fernseh, Inc. showed the KCA 100 ENG/EFP camera, introduced several years ago, and Cinema Products stood pat with the MNC-81.

**For more information:** RCA TK-86, 311; Toshiba PK-60, 312; Philips LDK-14S, 313; Ikegami HL-83, 314; Thomson-CSF 501, 315; 701, 316; Sony BVP-300A, 317; BVP-250, 318.

### Convertible cameras everywhere

Top-of-the-line ENG/EFP cameras are so good they perform as well as most studio types — and with the availability of a full range of lenses, there is no reason why such cameras should not be used in the studio. This year, as mentioned, the Ampex Digi-cam BCC-21 was introduced as a convertible.

In the Ikegami booth the HL-790 studio camera had an HL-79 inside it. RCA had the TK-860.

Of course, there were some cameras designed to be convertible right from the outset, such as the CEI-310. Although this was something of a special case, CEI showed how a 310 was converted by Panavision to shoot tape using the same lenses, matte boxes, filters, and gear heads used in shooting film. The unit is called the Panacam Electronic Cinematography Camera.

Last year Thomson-CSF introduced a top-of-the-line camera designed for multi-role use, the TTV 1525.

**For more information:** Ampex BCC-21, 319.

### Studio cameras stress auto setup

The trend to more and more automatic setup of studio cameras continued at NAB '81, following the lead set by the RCA TK-47 two years ago. Ampex touted the BCC-21 as a studio digital convertible capable of being set up by a master setup panel. Harris introduced the TC-85. Hitachi promoted the fact that its SK-100 automatic studio camera was selected by the CBS Network. Ikegami announced a new totally automated field/studio camera, the HK-322. Marconi has taken a further step in automating the Mark IXB by including a dedicated microprocessor for the control of automatic registration sequ-

ences. And Toshiba said its PK-40 digitally controlled studio camera is "perhaps the finest video camera ever built."

Harris's new TC-85 represents a slightly different approach. An independent computer is used for each TC-85. There is no waiting to set up cameras in sequence and no disaster if the master computer fails. With each camera having its own computer, every camera in the studio can be readied in 45 seconds or less. If a new tube is installed, the TC-85 can set itself up properly.

The TC-85 system allows a video operator to override the computer setting if desired. Although the computer setup is standard, the camera may be ordered without this feature.

Marconi's Mark IXB, like the Harris TC-85, incorporates separate computers in each camera.

Ikegami has adopted a centralized digital control system for its new HK-322 line. As many as 100 cameras can be set up from a single control point. Although the camera was designed to be automated rapidly and accurately, operational performance in terms of colorimetry, stability, and reliability has not been compromised.

Through the use of special digital registration, the HK-322 is making the same claims as the Ampex BCC-20/21: less than 0.05 percent color registration error and under 0.1 percent geometric distortion over the entire raster. As with the Ampex unit, complete digital shading and correction is provided.

The HK-322 camera uses one-inch XQ-2070 diode gun Plumbicons or XQ-1500 anti-comet tail tubes. The camera also includes some special effects as a result of deflection modulation. A lower-cost version of this camera sans automation is available as the HK-302. It uses 2/3-inch diode gun Plumbicons.

### Many camera options

Something new in camera options was shown at this year's NAB by a small company called RAVE (Reliable Audio Video Enterprises). The company sells a PC board for insertion in the camera to produce an in-camera reticule. The RPG-1000 generates a video pattern showing the composite safe title and action area as specified by SMPTE.

RCA announced the TK-47T as a triax version of the company's automated camera. Cable links of more than 10,000 feet are possible. The TK-781 was also introduced as a triaxial version of the TK-761 studio/field camera. The Ikegami HK-322 and 302 cameras offer triaxial capabilities, as does the new EFP camera the HL-83. The Toshiba TK-60 offers triax options, and so does the new Marconi Mark IXB. The



Bell Helicopter **TEXTRON**  
Evansville, Texas Inc.

**A Bell  
JetRanger III  
puts you  
on top  
of the  
competition,  
giving you  
an edge in  
audience  
share.**

Get a big story on the early news instead of the late night edition and you have a tremendous competitive advantage. If the viewer watches the early telecast, you stand a good chance to hold him all evening. And that means rating points!

The best way to beat the competition is with a Bell JetRanger III. It gets you into otherwise inaccessible areas. It lets you transmit live up to 120 miles away, or tape and transmit enroute. The story can be on the air before you land.

Bell's JetRanger III is a superior ENG platform, offering low noise and vibration, so you get sharper pictures and cleaner audio. The large cabin allows shooting from either side through large sliding windows. And there's no need to clutter the space, because there's plenty of storage room in the baggage compartment, as well as in other accessible storage areas.

Bell's JetRanger III. Backed by the world's most extensive parts and service system.

**Would you like to see what one can do for you?**

For more information on Bell helicopters designed for the communications industry, contact Bell Helicopter Textron, Department 698, Box 482, Fort Worth, Texas 76101, or call 817/280-2222.

# UNDERPAID OVERACHIEVER

The MICROTIME T-120 Time Base Corrector.

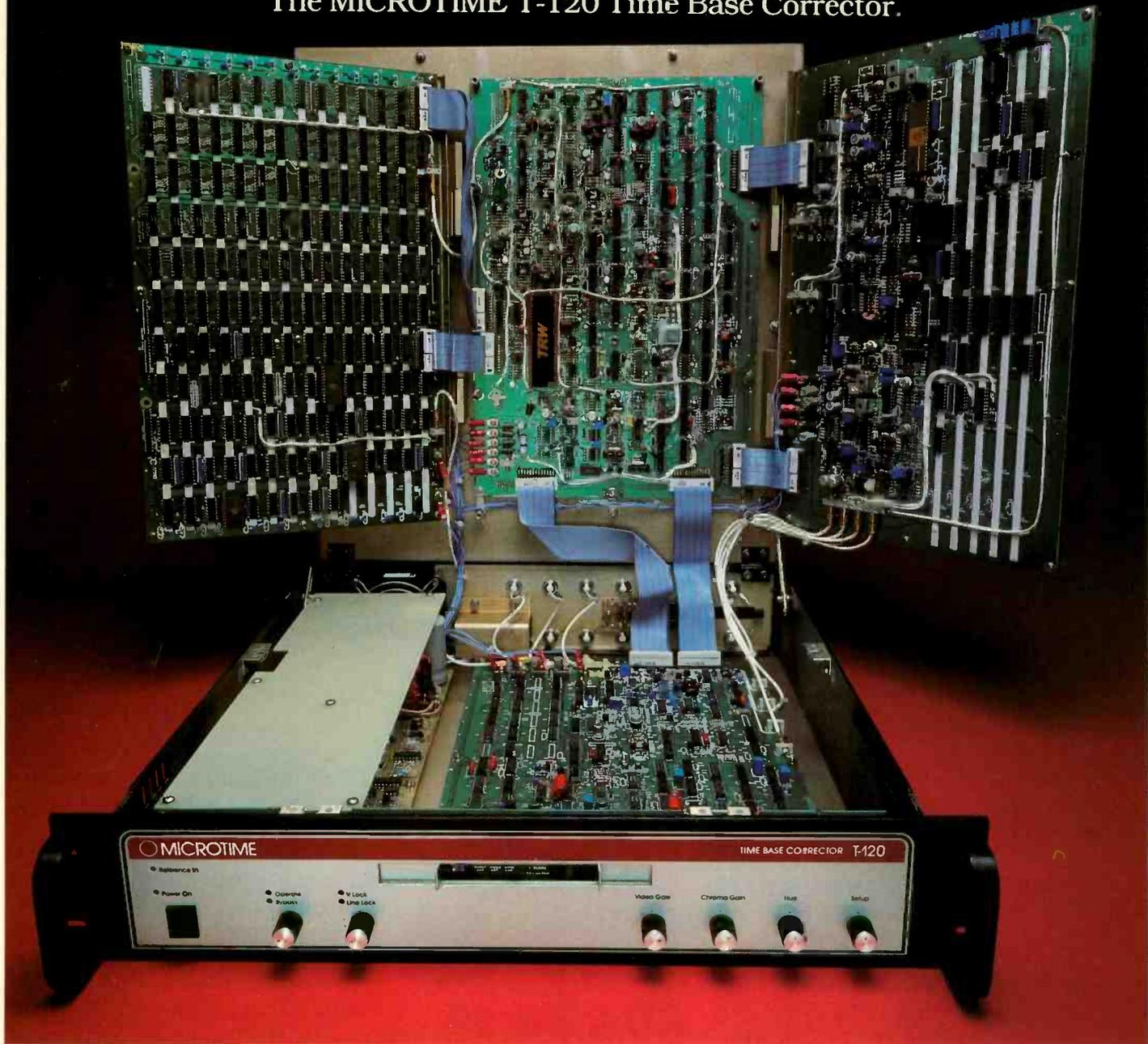

It does everything but cost a lot:

- 8 bit, 4x subcarrier digital design for high reliability and transparent performance
  - Wide range, 16-H line memory allows correction of large gyro errors
  - 3.58 MHz feedback for full bandwidth processing
  - Averaging Velocity Correction for best color performance
  - Chroma/Luminance delay compensation adjustment for smear-free pictures
  - Built-in RS-170A Sync Generator will operate genlock or standalone if reference is lost.
- For full information contact: MICROTIME,  
1280 Blue Hills Avenue Bloomfield, CT 06002.  
(203)242-4242 TWX 710-425-1165

 MICROTIME

Circle 122 on Reader Service Card



Thomson-CSF 701 has a triax adaptor for up to 4000 feet remote operation. Harris's new TC-85 is available with a triax option.

Fiber optic connections were promoted by Ampex in the BCC-20/21 and by Fernseh and various independent companies, but there was no ground swell in this direction. This subject is treated more extensively later on.

In order to eliminate bulky multicore cables between the camera and remote control unit, Cinema Products has created a healthy business for itself by promoting coaxial remote systems for various cameras. At NAB '81, CP said it now offers coax remote control for the Sony BVP-300/330 and Thomson-CSF's MC 601/701 cameras. (The system has already been available for the RCA TK-76 B/C, the Ikegami HL-77 and 79, and NEC's MNC-71 series of cameras).

Rank Precision Industries has also entered the business. It offers triax and RF link adaptors for Ikegami HL-77 and HL-79 cameras.

**For more information:** Harris TC-85, 320; Ikegami HK-322, 321; HK-302, 322; RAVE RPG-1000 PC board, 323; RCA TK-47T, 324; Marconi Mark IXB, 325; Rank triax adaptors, 327.

### Half-inch, improved stripe filter tri-gun tubes stand out

The major advances of the last few years gave way this year to half-inch tubes, both Plumbicons and Saticons, and improvements in stripe filter tri-gun tubes.

Although RCA was alone in showing a camera using the new half-inch tubes, at least four other manufacturers have received or are about to receive sample tubes. Half-inch tubes have been heralded as the *last* major advance before solid state pickup devices take over.

Amperex said the new tubes, which are only three inches long, are both

lighter in weight and lower in power drain than 2/3-inch types. They incorporate most of the advances worked into other Plumbicons, however, featuring diode electron guns for dynamic beam control. Their output capacitance is low (3.5 pF), thanks to a special signal plate and contact. The new tubes include isolated front-end mesh contacts for reduced line pickup, evaporated wall electrodes, reduced magnetic deflection power, and low power electrostatic focus.

Despite its miniature size, the new Plumbicon delivers high quality pictures. The sensitivity is somewhat less than that of larger tubes, but this is made up in a faster rated optical system. The new tubes are made in Eindhoven, Netherlands, and will be priced around \$3000, according to Amperex.

Half-inch Saticon tubes were announced by RCA Electro-Optics Devices. (The RCA Hawkeye uses either Plumbicons or Saticons.) These new tubes were designed by RCA and are expected to be manufactured in RCA's Lancaster, Penn. plant.

The half-inch Saticons feature low capacitance by virtue of their small scan formats and have low-lag guns for good low light level performance. The photoconductor has low reflectivity throughout the visible spectrum, resulting in minimum flair.

RCA says resolution is excellent. At 400 TV lines, amplitude response is typically 40 percent. Lag performance is typically less than 2 percent. Identified as BC 4398B, G, or R, the tubes are priced at \$1850 each.

The high resolution and good spectral response of Saticon photoconductors showed up in stripe filter tubes for single-tube cameras. Sony identified its new stripe filter tube as the Sony-patented highband Saticon Tricon. It incorporates a built-in bias light and automatic beam suppression circuitry. The tube incorporates deposited electrostatic deflection electrodes along with a new gun assembly to control beam spot size position. Advances in striped filters make 400 TV lines of resolution possible.

Hitachi identified the new pickup tube in its single tube camera, the FP-10, as a "one-inch M type tri-electrode Saticon HS 302." It, too, has a built-in bias light and accommodates an automatic beam optimization circuit. Although Hitachi did not have a bulletin on this tube at NAB, its most recent catalog describes a new approach to "filter integrated color Saticon targets and 'electrostatic focusing of electron beams'" (phrasing similar to that used by Sony).

In other Saticon tube areas Hitachi promoted the fact that a second-generation low-lag Saticon layer was at hand. It described these tubes as Saticon IIs.

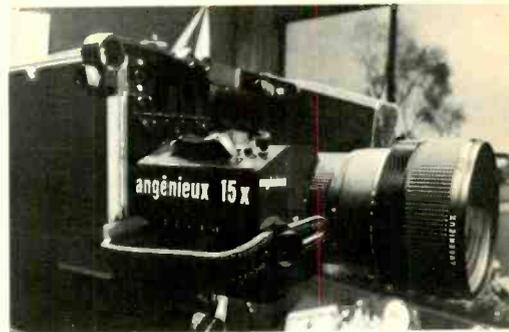

Angenieux's 15x9 ENG zoom offers high performance in a small package

Tentative bulletins prepared just prior to the NAB show described an H8397B, an H8398B, an H9366B, and an H9369B tube. Saticon IIs use computer-aided evaporation technology, new doping approaches, control of impurities and refined materials purification methods.

A new diode gun Leddicon for "advanced generation" 30-mm cameras was shown by English Electric Valve. The tube has an ultra high-resolution target with low output capacitance. It uses a one-inch scan format for precise geometry and registration. A new 25-mm diode gun HOP (ACT) Leddicon was also shown, along with an array of other camera tubes.

With so much emphasis on 1/2-inch tubes and striped filter tri-gun tubes, CCD was easily forgotten at NAB '81. But Fairchild Camera did exhibit a camera with a single chip 488x380 element sensor in operation along with a striped filter. Three chips in a camera would produce very acceptable pictures at reasonable light levels, Fairchild said. (A 488x380 array when operated in a 7.16 MHz clock frequency provides a signal compatible with NTSC b & w standards).

**For more information:** Amperex half-inch Plumbicons, 328; RCA Electro-Optics half-inch diode gun Saticons, 329; Hitachi Saticon II, 330; EEV 30mm diode gun Leddicon, 331; 25mm diode gun HOP Leddicon, 332; Fairchild CCD area image sensors, 333.

### Lenses continue to proliferate

Brand-new lenses were, of course, needed for the half-inch tube cameras and both Fujinon and Angenieux responded. But beyond that many other lenses were announced, including a new autofocus lens by Canon.

Fujinon showed two types for half-inch tubes: a 14X and a 12X. Both lenses offer f/1.4 speeds that remain flat for a very wide focal length of 7 mm out to a zoom of more than 10X. The longer of the two, the Fujinon S14X7, has a built-in 2X extender and an extended range of 196 mm (equivalent to a 550 mm lens for 1 1/4-inch format tubes). With hood and servo unit, the weight is



Fujinon said its new 30X lens for 2/3-inch cameras could eliminate the need for large cameras at sports events

## NAB SHOW IN PRINT



Canon's autofocus lens lets broadcasters prefocus on sound stages, for example

1.7 kg. The S12X7 weighs only 1.3 kg.

Angenieux showed a similar aperture lens for half-inch tubes, an f/1.4 15X system. It too had a built-in 2X range extender. Its weight is 1.2 kg as given in the "preliminary" data sheet. Its minimum focal distance was 0.8 meters (same as the Fujinon). Horizontal field angle was given as 48 degrees to 3½ degrees.

Angenieux devoted more attention to its 15x9 zoom for 2/3-inch tube cameras, which has a high aperture of f/1.5 with a photometric factor of 1.1. This lens is flat to 100 mm and drops to 1.9 at 135 mm. A built-in turret-operated 2X extender can be used in low light levels. Despite the large lens elements, it weighs only 2.1 kg. The lens is weather-resistant, with shower-proof optical and servo units. An 0.8X retrozoom provides a wide angle of 60 degrees.

The new Canon autofocus lens uses a through-the-lens focusing design based on an infrared system. A strong infrared emitting light comes from a diode within the lens. Infrared light reflected from the subject automatically adjusts the focusing to the proper position. Canon says the major advantage of an infrared active system, as opposed to

other methods, is that it can focus even in darkness — for example, for pre-focusing on a sound stage during a live presentation.

Automatic focus can be accomplished between one and 30 meters. A touch of the control button activates the system. Wide-angle or telephoto positions do not affect the unit. The focus zone for the infrared beam is only 1 cm, making it very precise. The autofocus was shown in a P18X16 B lens, which has an aperture of f/2.1 to 2.7 and a practical focal length range of 16 to 288 mm. The lens also has built-in 1.5X and 2X extenders.

Canon showed a new ENG/EFP lens, the J13X9BIE-II. It is lighter in weight than its predecessor with no loss in optical quality — the II weighs 1.45 kg.

The major theme at Canon was to get more use out of ENG/EFP cameras through different lenses. The Canon J13X9B or J13XBIE with built-in extenders are ideal for news; the J20X8.5B IE lens is ideal for field or studio commercials; the J25X11.5B IE converts the camera to a fixed-position sports camera. The J20 and J25 lenses were introduced last year.

New from Schneider (Tele Cine booth) was a 15X wide-angle lens with 2x flip-in range extenders and a dioscope. Type TV 51 fits 1¼-inch cameras (zoom range 16 to 240 mm with extender), while the TV 61 is for one-inch cameras (zoom range 12.5 to 190 mm without extender). The horizontal angle of view is 53 degrees to 3.9 degrees (without extender).

Fujinon showed a series of new lenses in addition to its offerings for half-inch tube cameras. One of its prize lenses was a new high-quality 30X EFP lens the company called "the ultimate zoom lens for 2/3-inch format cameras." (The 30X goes beyond Fujinon's earlier 22X and Angenieux's and Canon's 25X zoom's for 2/3-inch cameras. Although Schneider has sold 30X lenses, adaptors are necessary and weight is high.) The new Fujinon A30X11 lens with built-in 2X extenders has an f/1.6 aperture flat from 11 mm to 220 mm. At 330 mm the speed is

f/2.4. The lens with hood weighs approximately 9 kg.

Another new Fujinon lens is a 14X zoom for one-inch format cameras. Designed for a wide range of studio lighting levels, the lens has a maximum aperture of f/1.6. The company showed several other lenses, including light-weight and economy versions of others in its line. It also showed a fixed-focus lens suited for the Ikegami EC 35 electronic cinematography camera, introduced in 1980.

An EFP matte box for "the film look in video" was a new accessory at the Cinema Products booth. It fits most 15X to 17X lenses for ENG/EFP use. The unit accommodates two flip-on rotatable filter sizes and 4½-inch diameter special filters, such as star and fog filters available from Tiffen.

Tiffen itself had a variety of lenses and accessories, but its principal new product was a sturdy stackable filter case that holds seven filters.

**For more information:** Fujinon half-inch format lenses, 334; 30X EFP lens, 335; 14X zoom for one-inch cameras, 336; Angenieux half-inch format lenses, 337; f/1.4 15X system, 338; 15x9 zoom, 339; Canon autofocus lens, 340; J13X9BIE-II, 341; Schneider (Tele Cine) 15 X wide-angle, 342; Tiffen filter case, 344.

### New means of supporting cameras; new teleprompters

The more cameras that evolve, the more the need for new mounting heads, pedestals, tripods, dollies, and other camera support equipment. NAB '81 had quite a lot to offer in this area.

Many of the new items on hand were designed to make producers more creative. One such item shown at Las Vegas was the Video Mini-Jib from Matthews Studio Equipment. The Mini-Jib arm provides smooth fluid camera action in vertical, horizontal, and diagonal directions. Its arm rotates 360 degrees for an infinite variety of camera positions.

Matthews boasted 75 new innovations for 1981, including such items as furniture clamps, meat axes, drop ceiling scissors clamps, and gimbal roller heads.

Listec showed five new systems at NAB '81. The Vinten Plover transportable pedestal model 3179 was the first. This compact pedestal, suitable for remote work, handles 50- to 230-pound loads without changing gas pressures. (A new multi-ram system allows the user to change camera or lens in the field without changing apparatus.)

A new production pedestal for lightweights — 200 pounds or less — is the Vinten Raven studio pedestal. The Raven offers a 24.5- to 59-inch elevation range at no sacrifice in smoothness or flexibility.

The T-13 tripod from ITE supports up to 70 pounds

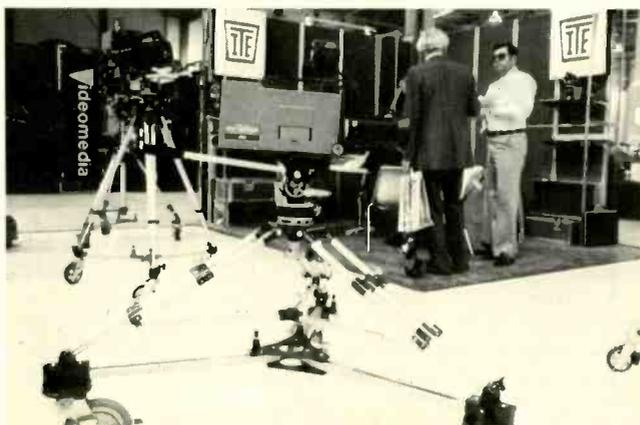

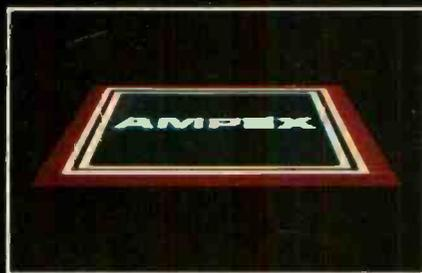

## Ampex Digital Optics. A New Perspective For Special Effects.

This is the new generation of digital optics systems. That for the first time gives you true three-dimensional perspective.

This is ADO. Ampex Digital Optics.

### **You're the Magician. And the Magic's Easy.**

ADO should come with a magic wand. But we've given you something better. A unique, joystick which you use to control all ADO's dazzling effects.

### **The Most Astounding Tricks Ever Performed on TV.**

No matter which effects you choose, ADO's powerful computer performs them with unprecedented smoothness.

Even the most astounding.

For example, ADO can rotate a picture about all three axes at the same time.

What's even more incredible is that ADO can do it with *perspective*. True image perspective.

And that's only the beginning.

ADO's "locate" mode can shift the perceived point of view, so an object on the screen looks as if it's above, below, left or right of the viewer.

A sizing/position function allows image position anywhere on the screen, and can vary image size from zero to beyond eight times normal.

Axis positioning lets you move axis of rotation off the picture center. Even completely off the picture plane.

Aspect/skew functions change horizontal and vertical aspect ratios, so a square image, for example, becomes a parallelogram.

You can even freeze or "grab" frames from a continuous source and manipulate them the same as continuous video.

And ADO executes all functions—perspective, geometry, position and size—in real time. On up to four video channels.

### **More Power to You.**

You do it all. ADO is user programmable, so you interactively control all picture manipulations. Simply punching a few buttons programs them in.

ADO also has totally transparent picture processing. That means your picture output is identical to your input.

Call your Ampex sales representative for more information.

### **ADO. The Special Effects System With a New Perspective.**

Ampex Corporation,  
Audio-Video Systems Division,  
401 Broadway, Redwood City, CA 94063  
415/367-2011

Sales, Spares and Service Worldwide

## NAB SHOW IN PRINT

The Vinten ENG pan and tilt head, Model 3199, is designed for light ENG and location shots with small cameras and big lenses. The new head handles 25-pound weights and offers 90 degrees of tilt and 360 degrees of pan.

The fourth Listec system, the Cygnet pan and tilt head, operates with lubricated friction dampeners and was introduced last year. This year's model 3089 weighed only 10 pounds. Camera lenses weighing up to 25 pounds can be panned and tilted smoothly since the camera rotates about its own center of gravity, with no cams or spring.

The fifth Listec item was a Digivision monitor prompting system, D12/D17 SH and ESH. The new model is available for smaller ENG cameras and

includes video keyer enhancement.

Innovative Television Equipment offered several new products in addition to its full line. The ITE H10 Hydro Head represents a new concept in viscosity drag control for pan and tilt. It incorporates adjustable center of gravity controls that permit perfect counterbalance load control, thus providing constant camera balance.

A second new product was the ITE T-13 tripod, designed for EFP cameras equipped with video viewfinders. The design eliminates any radial torquing to the top assembly and legs. Loads weighing up to 70 pounds can be supported.

Several new Sachtler products were shown by Arriflex, including the Studio 7 plus 7 fluid head tripod, designed to handle larger and heavier cameras in a compact design.



Sony's BVU-800 VCR has new tape-handling features for editing efficiency

### Progress Toward the All-Digital Studio Reported at NAB 1981 — No Standard Yet

As it did a year ago, the SMPTE made a presentation to television engineers attending NAB on its progress towards reaching a world standard that will help usher in the all-digital studio. A highlight was a panel discussion covering the SMPTE digital video component tests conducted in San Francisco the first week of February. (See *BM/E*, April, 1981, for a report of the San Francisco event.)

Those tests lead to two preferences being stated, one by SMPTE and one by EBU. SMPTE, consisting mostly of engineers coming from 525-line countries using NTSC, favored a component-coded digital television system in which the luminance signal is sampled at a frequency of 14.3 MHz and the two color difference signals sampled at the frequency half that rate (the so-called 14:7:7 scheme). EBU members, witnessing the tests in San Francisco and having made many tests of their own, favored a 13 MHz sampling rate, or at best, a 13.5 rate. Both groups, however, agreed that a single world sampling rate acceptable to all parties would be most desirable. SMPTE's Digital Task Force on Component Digital Coding and selected members of the SMPTE Digital Working Group attended joint meetings with EBU Working Party V subsequent to the San Francisco meeting to discuss the preferred rate.

During those meetings the SMPTE Task Force concluded it could not get the EBU to agree to the 14.3 MHz sampling rate. It could however get the EBU to move up to 13.5 if that were to become a world standard. The Task Force came back with the recommendation that 13.5 MHz be accepted as a standard to be passed on to the ITU

CCIR committee for ratification and approval.

On the last day of the NAB Convention the SMPTE Working Group on Digital Video Standards met to review its position in light of the EBU stance (made public in a press release of that date — April 15.) EBU said it had the support of other broadcasting unions such as the OTI (Organizacion de la Television Iberoamerica), as well as encouraging reactions from the Union of National Radio and Television Organizations of Africa (URNTA) and the North American National Broadcasters Association (made up of ABC, CBS, NBC, and PBS of the U.S. and CBC of Canada).

But the Task Force could not get consensus that 13.5 MHz should be the new standard. Indeed, an ad hoc committee on digital television from Japan, represented on the SMPTE committee, arrived at the conclusion that perhaps two standards should be set: 14.3 and 13, which are convertible to each other within an active TV line by a 10:9 relationship.

The committee meeting at NAB did decide that it would look further into the possibility of adopting 13.5 after its impact on the cost and performance of 525-line equipment was understood more fully. The SMPTE Task Force on Component Digital Coding will continue to meet with other concerned groups; a trip to Japan is planned in May. The EBU Administrative Council had a meeting scheduled for May 22 to 25, 1981 (after press time), at which time it planned to make a formal recommendation to CIR.

While this process has been going on, potential manufacturers of digital video recorders have been quiet. There were no demonstrations at NAB showing new highs in packing densities or support for this or that error correction code. Only Hitachi showed a working digital videotape recorder (using a modified Type C transport); no unusual claims were made for it.

Television Products, Inc. brought two new products — the P-80 air-counterbalanced camera pedestal, designed for studio production, and the P-25 low-priced unit. TVP says the P-80 was designed through inputs from a national user questionnaire in consultation with network studio camera operators. Vertical height range is 21 inches to 58 inches. A single steering and lift ring allows simultaneous steering and elevation movement. Ballast can be added to compensate for light-weight EFP cameras. The P-25 is based on the P-20 model but incorporates features found on larger units. Adjustment of counterbalance force is achieved by adding or subtracting air pressure through a Schrader valve.

Two new universal fluid heads were shown by Davis and Sanford Co. The dual-handle fluid action head, Model 12, accommodates all cameras up to 12 kg in weight. Features are positive tilt lock and tilt tension control and auto slip — a self-adjusting automatic breakaway quick pan. A snap lock quick-release camera mounting plate is included. The Model 808 fluid head is designed for cameras weighing up to eight pounds. It includes Hydralock, a new concentric hydraulic lock/tension device.

Both O'Connor and Quick-Set showed complete lines of video and motion picture support equipment. The Quick-Set exhibit featured Samson, Hercules, and Gibraltar heads, tripods, dollies, and pedestals and Husky dollies. O'Connor displayed its own heads and tripods, including the ingenious HydroPed, Model 102B, which locks on any terrain and is very rigid in torsion and bending.

New Gitzo fluid heads and tripods were shown by Karl Heitz. The Video Combi tripods handle cameras weighing up to 35 pounds. Featured was an extra-light (1¾ pound), short (14 inches) tripod capable of handling light video cameras.



# ACE. The Editor's Choice. With more choices for editors.

This is the most adaptable, most flexible, most fully human-engineered editing system ever.

This is ACE. Ampex Computerized Editing.

## **TouchScreen™. The Ultimate in Editing.**

No keyboard. No buttons. No lightpen. That's ACE's unique TouchScreen.

As your finger gently touches a particular command on the screen, ACE instantly senses the location of your finger, compares it with the command on the screen, then executes the function or sequence.

All you do is touch and edit. It's that simple.

## **Standard Options With Uncommon Flexibility.**

If you're accustomed to working with the

simplicity of a dedicated keyboard ACE offers one with exciting new flexibility. We've added eight soft keys that increase available functions. Without increasing complexity. They're even programmable to perform repetitive operations, so you don't have to.

Rather work with the familiar ASCII typewriter keyboard? ACE has that, too. Plus programmable soft key operation.

ACE also complements each editing mode with an improved version of the popular joystick control to make finding edit points easy.

## **Modular Design for Today. And Tomorrow.**

Once the basic ACE system is installed, its modular design allows you to make enhancements economically. The advanced thinking that went into ACE assures that, as your needs grow, ACE

can grow with you.

To find out how ACE can start taking care of your editing needs today, get in touch with your Ampex representative for more information.

**ACE. It Lets the Editor Make the Choice.**

**AMPEX**

Ampex Corporation,  
Audio-Video Systems Division  
401 Broadway Redwood City CA 94063  
415/367-2011  
Sales, Spares and Service Worldwide.

# NOW YOU GET MORE THAN MARCONI WHEN YOU BUY MARCONI!

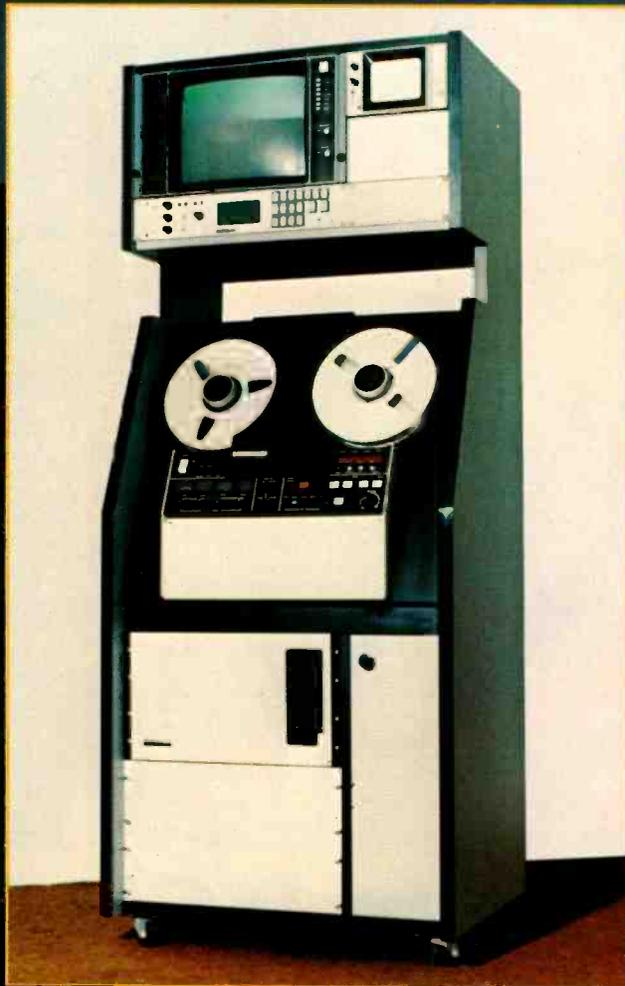

Take the Marconi MR2 (pictured above). It's a superbly-crafted machine from one of the world's most prestigious manufacturers. A 1" C Format VTR that has proven its quality and durability time and again.

Now add AFA. For more than a decade we've successfully designed and fabricated total videotape systems and rebuilt and refurbished hundreds of VTR machines of every make and model.

Now, as the exclusive sales representative for all Marconi Broadcast Products in North America, we'll service your MR2 and other Marconi products with all the expertise and knowledge we've gained over the years. And we'll supply you with all the spare parts and components you'll ever need directly from our headquarters in Northvale, New Jersey. Guaranteed!

**AFA**  
**A.F. ASSOCIATES**

100 Stonehurst Court, Northvale, NJ 07647, (201) 767-1000

© 1981, A.F. Associates, Inc.

Circle 125 on Reader Service Card

## NAB SHOW IN PRINT

Lee-Ray Industries showed lightweight wheeled cart carriers, including folding equipment requiring minimum storage space.

Camera remote control systems were shown by Evershed Power-Optics and Canon. The Evershed equipment has been exhibited before, but the Canon remote control pan and tilt system, U-182, is quite new. This computerized system can be pre-programmed for up to 10 shots. It is quite compact and lightweight and consists of four modular units: the pan/tilt unit (180 degrees of pan, 40 degrees of tilt), the master control unit, and two different operating units. The pan/tilt unit comes with a Canon J13X9B f/1.6 zoom lens. Panning, tilting, focusing, and zooming can be accomplished by the remote control unit. One operational unit handles programming and playback; the other is playback only.

Telescript's line of monitor prompting equipment included an infinitely variable digital prompter, the MPS. It incorporates Electrohome's 1981 1000-line resolution monitor for good readability.

Q-Tv-Telesync showed a new lightweight (9 pound) on-camera video prompter, the VIV. A six-inch monitor is magnified by an optical beamsplitter to equal the image of a monitor. Also

**For more information:** Matthews Video Mini-Jib, 345; new equipment line, 346; Listec Plover, 347; Raven, 348; 3199 pan & tilt head, 349; Cygnet 3089, 350; Digivision prompting system, 351; ITE H10 hydro head, 352; T-13 tripod, 353; Arriflex (Sachtler) head, 354; Television Products P-80 pedestal, 355; P-25 pedestal, 356; Davis & Sanford Model 12 head, 357; Model 808 head, 358; Heitz (Gitzo) Video Combi tripods, 359; Canon U-182, 360; Telescript MPS prompter, 361; Q-Tv mini-prompter, 362.

shown was a new Mini-Q-Prompter for ENG cameras.

### Power packs

Things have settled down somewhat in the battery market. Most manufacturers have returned in full force to Ni-cads. The improvements were to meet the needs of lower power consumption in the newer cameras and the battery weight loss that means. There was also the problem of charging a variety of VTR and camera batteries without having to buy a charger for each.

Frezzolini Electronics introduced what seemed to be the most versatile of the systems, the MBC-2. This multiple battery charger can handle five Frezzi camera packs in the fast charge mode and eight VTR batteries on a trickle charge simultaneously. Frezzolini also showed its complete line of batteries and chargers.

While the cost of silver has made it costly to continue manufacturing silver/zinc batteries, the ones that have been sold are precious to their owners. To help prolong battery life, Anton/Bauer introduced a diagnostic discharger/equalizer for silver/zinc portable power packs. There is also a unit for both silver and Ni-cad batteries. Anton/Bauer also introduced a new four-position slow charger.

Christie Electric continued to make improvements in its ReFLEX-20 fast chargers and batteries.

CINE 60 introduced a multiple battery charger that can handle seven mismatched batteries and dememorize another battery on an eighth channel. The CATC 35 is modular in design, with each charger a separate unit that can be programmed to whatever type of battery is plugged in. It sells for \$2195.

Two other chargers were introduced by CINE 60. The Four-Channel Sequential Fast Charger handles four Ni-cads in four hours. The ENG-1 is a versatile fast charger that can charge any Ni-cad battery, from 1.2 AH to 7 AH. Charge time depends on the kind

of battery.

CINE 60 also introduced a new lightweight power belt, the Sofbelt™. It provides the same power capability as other CINE 60 power belts but is foam-cushioned and attaches with Velcro® fasteners.

Comprehensive Video was displaying the PAG Power line of belts, batteries, and chargers.

PEP, Inc. introduced a new line of 4 A Ni-cad batteries weighing about two pounds and good for one hour of continuous use. They have on-board adapters and cost \$595.

PEP also introduced replacement batteries for most VTRs. A new fast charger can bring batteries back up to power in 40 minutes.

Perrott Engineering Labs introduced the 8100 Series fast charger. The new unit will accommodate any Ni-cad battery and charge it in an hour.

**For more information:** Frezzolini MBC-2, 363; Anton/Bauer silver/zinc discharger, 364; Cine 60 CATC 35, 365; Sequential Fast Charger, 366; ENG-1, 367; Sofbelt™, 368; PEP Ni-cad batteries, 369; replacement batteries for VTRs, 370; Perrott Engineering 8100 fast charger, 371.

### More formats on VTR's 25th anniversary

Twenty-five years ago Ampex exhibited the first quadruplex videotape recorder to the broadcast industry at the 1956 NAB convention (then the National Association of Radio and Television Broadcasters). 3M participated in that historic event by providing the first two-inch videotape. There were many refinements to follow, some by Ampex, others by RCA, but essentially there was only one format — quad.

In 1970, Sony showed the ¾-inch U-Matic videocassette format, which did not impact the broadcast industry until the ENG revolution began several years later. On videotape's twentieth birthday at NAB, '76, Ampex unveiled the VPR-1 one-inch VTR with AST,



The studio portion of RCA's Hawkeye system includes the HR-2 VTR and HE-1 edit controller, which provide full production and post-production capabilities



Two BVU-800 U-Matic editing VCRs can be interconnected for complete editing capability. Microprocessor control is built in

## NAB SHOW IN PRINT



RCA had a new Supertrack option for its AE-800 editing system

Sony introduced the BVH 1000, and Fernseh brought the BCN. Things have never been the same since.

The twenty-fifth anniversary saw yet two other formats emerge at NAB—high band half-inch videocassette types from RCA, Panasonic and Sony incorporated in new camera/VTR combinations for ENG, and quarter-inch video cassettes for ENG from For-A and Technicolor.

We said all that is available for print about the new half-inch recorders-players when we talked about the combined cameras/VTRs earlier. This section will look at the new round of ¾-inch videocassettes for broadcast and new half-inch entries for ENG-institution work. The Technicolor quarter-inch recorder will be covered briefly. Finally, advances in one-inch machines will be discussed. We will also take a look at wideband VTRs—those able to record up to 12 MHz.

### ¾-inch and half-inch advances

The biggest news in the ¾-inch field was Sony's unveiling of yet another videocassette recorder, the BVU-800. The technical capabilities of the BVU-800 take ¾-inch recorders to a new plateau in terms of quality, portability, and cost efficiency, says Sony. What distinguishes the BVU-800 from other U-Matic equipment is a built-in microprocessor control system which makes it capable of editing with a second BVU-800 without an equipment controller interface. A Sony spokesman said, "Two interconnected BVU-800s provide complete editing capability, eliminating the need for a third box."

The BVU-800 is a front-loading device for added convenience (units can be stacked) and incorporates new tape handling features. Six dc motors are incorporated in the die cast transport, which keeps the tape threaded around the drum in all modes except eject. This avoids the load/unload cycle found in standard U-Matic VTRs.

Since the tape remains threaded around the scanner, the BVU is capable of capstan control in search and jog

modes. Front panel control offers fixed speeds of one-thirtieth, one-tenth, one-fifth, one-half, one, two, five, and 10 times normal speed. Color pictures are provided up to 10 times and monochrome up to 40 times normal speed in either forward or reverse.

The same video and audio editing concepts found in one-inch VTRs have been refined for the BVU-800. Video and/or audio one and two, insert and assembly editing are possible, as is the ability to rehearse, implement, and review in manual or auto edit modes. This gives the BVU-800 editing flexibility more commonly associated with microcomputer-assisted editing systems.

Audio inserts have timed entry and exit sequences, enabling perfectly matched "split edit" on audio one and two. High speed search and forward/reverse jog ability make audio and video editing fast and accurate.

An audio mixer between audio channels one and two allows for switching of two inputs or mixing. The Sony BVU-800 is compatible with the Sony BVE-500A editing system. Delivery is anticipated for summer of 1981.

Panasonic, which last year introduced a new ¾-inch editing videocassette recorder, the AU-700, showed up this year with an editing controller with SMPTE time code accuracy, the NV-A970. Its microprocessor logic allows insert and assembly editing on Panasonic AU-700, NV-9200, NV-9500, and NV-9600 series machines, as well as on the VHS industrial models. The controller reads both control track pulses and SMPTE time code. Five edit point search speeds are included. Plus and minus trim points and single field shift buttons for use with the AU-700 are included, as is a length-of-tape memory.

Another development in the ¾-inch U-Matic category was the availability of a unit designed for airborne use. TEAC showed the V 1000AB-F Type IV, a rugged but compact unit intended for installation in aircraft, including helicopters. A remote control panel

with TTL logic enables the recorder to perform a variety of tasks from the vantage point of the cockpit.

As a means of increasing the value of ¾-inch VCRs, Recortec showed a long playing attachment. The attachment incorporates a reel-to-reel transport. When 14-inch reels are added to a standard recorder, up to 12 hours of play can be achieved. In combination with Recortec's high band system, the HBU-2860 (which operates at high speed), the result is four hours of extended play.

In the half-inch videocassette area, JVC introduced a new heavy-duty BR-6400U recorder and a BP-5300U player using the VHS format. Among the features of the recorder are direct drive of the head drum; a four-head system (two pairs of video heads—one for normal recording/playback, the other for slow motion or still frame playback); high speed search up to 10 times while watching pictures; remote control of playback from still to five times normal; two-channel audio and automatic front loading of the cassette. Both units directly interface with JVC's editing controllers, the RM-88U and the RM-82U.

A half-inch videocassette recorder configured into a time lapse recorder was shown by Panasonic. The NV-8050 offers time lapse modes—two hours (real time), 12 hours, 72 hours, 160 hours and 240 hours. A VHS videocassette is the recording medium, although the format is not compatible with other VHS machines.

Another highlight of the Panasonic



Dolby's 221 brings two channels of noise reduction to the BVH-1100



*latest*  
**Do you know the score?**

UHF TV	NEW STATIONS						1980		
<b>BOGNER ANTENNAS</b>	WBTI	KADN	WSFJ	WMDT	WXAO	WHMC	WRTS	KCWY	WHMM
	KMXN	KNDU	WDDD	WFTI	WLYJ	KTBO	WGGN	WVGA	
<b>ALL OTHER ANTENNAS</b>	WUHF	WTVE	KAUT	WFUM	KOKI	WPDE			
	WCGV	WQOW	KNBN	WTJC	WXTV	WLRE			

If you're involved in broadcasting systems you know us. But are you aware that in UHF we're now also the *biggest* as well as the *best*! The fact that a vast majority of all new 1980 UHF TV stations use a Bogner antenna is only part of the story. Since 1964 we have put into broadcast use more than 600 slot arrays, with over thirty 55kw to 200kw slot antennas during the past three years alone. Antennas that are all still meeting their promise — trouble-free, dependable operation with solid coverage.

Put together all the qualities you want in your antenna: exceptional performance, proven durability, economy and on-time delivery, and you'll know the score about Bogner. We have competitors but no equal.

Prove it to yourself. Talk to the stations listed above (or call Len King for the names of all TV stations using Bogner manufactured antennas). Find out first hand why Bogner is the champion of UHF antennas. Bogner Broadcast Equipment Corp., 401 Railroad Avenue, Westbury, New York 11590, (516) 997-7800.

**BOGNER®**

CHAMPIONSHIP BROADCAST ANTENNAS

WBTI-Cincinnati, OH; KMXN-Albuquerque, NM; KADN-Lafayette, LA; KNDU-Yakima, WA; WSFJ-Newark, OH; WDDD-Marion, IL; WMDT-Salisbury, MD; WFTI-Poughkeepsie, NY; WXAO-Jacksonville, FL; WLYJ-Clarksburg, WV; WHMC-Conway, SC; KTBO-Oklahoma City, OK; WRTS-Spartanburg, SC; WGGN-Sandusky, OH; KCWY-Casper, WY; WVGA-Valdosta, GA; WHMM-Washington, DC; WUHF-Rochester, NY; WCGV-Milwaukee, WI; WTVE-Reading, PA; WQOW-Eau Claire, WI; KAUT-Oklahoma City, OK; KNBN-Dallas, TX; WFJM-Filint, MI; WTJC-Springfield, OH; KOKI-Tulsa, OK; WXTV-Greenville, MS; WPDE-Florence, SC; WLRE-Green Bay, WI

## NAB SHOW IN PRINT

exhibit was a new high-speed VHS tape duplicator system, the Video Tape Printer (VTP). It can produce copies of two-hour and four-hour VHS cassettes in about four minutes. The VTP consists of a master recorder and printer. The master printer makes mirror images of the original, recording it on a high coercivity half-inch tape contained in a cartridge. In the printer, the master and slave tapes are tightly wound together by a contact bifilar winding method. A magnetic transfer field is applied to complete the duplication. A slave tape feeder holds up to 15 tapes for automatic operation. The master tape can be used for about 1000 copies.

**For more information:** Sony BVU-800, 372; Panasonic NV-A970 editing controller, 373; TEAC V 1000AB-F Type IV, 374; Recortec LP attachment, 375; JVC BR-6400U, 376; BP-5300U, 377; Panasonic NV-8050, 378; VTP, 379.

### Those quarter-inch machines

This year's show was the first NAB to show quarter-inch videocassette recorder/players. Two were on hand: the CV-One (as part of the VCR attached to the camera by Nippon Television Network and shown at the A.F. Associates and For-A exhibit) and the Technicolor seven pound VCR. Both use the same format, that of Funai of Japan. Although 1/4-inch formats have not heretofore been seriously considered for broadcast use, both were being promoted as suited for ENG work. Nippon Television Network reported that it had taken its unit up Mt. Everest to produce a documentary. Editing is possible with the CVF-6000 recorder player from For-A. Quality is similar to that of Super 8 film or better.

Visitors to NAB could see the touch-down of the spaceship Columbia at the Technicolor stand. The recording was a bit noisy, but it was not a direct feed. Rather, it was made off-the-air *through a tuner*. Actually, the recording was



The Panasonic NV-8050 time lapse recorder provides automatic time recording through an internal time/data generator

made on a brand-new Technicolor product, Video Showcase, which includes a quarter-inch recorder, a built-in all channel tuner, a 7.7-inch color picture tube, and a rechargeable battery. This whole package measures just 18 by 13 by 8 1/4 inches and weighs just over 20 pounds. (The standalone VCR 212 recorder/player portion weighs 7 pounds). The 30-minute videocassette measures 4 1/8 by 2 5/8 by one-half inches. The company claims 240 lines of resolution for the product, with a luminance S/N of 43 dB. The recorder employs helical scanning with a tape speed of 1.26 inches per second and two heads using FM modulation.

The For-A CVF-6000 recorder/player has built-in features that make it suitable for editing purposes. There are four shuttle playback speeds: two, one, one-fifth, and one-twentieth times. The operator can switch forward to reverse without going through stop. The 26.4-pound CVF-6000 contains several level meters.

**For more information:** CV-One VCR, 380; Technicolor VCR, 381; Video Showcase, 382; For-A CVF-6000, 383.

### One-inch VTR innovations minor

There were no startling new announcements in the one-inch professional videotape recorder field at NAB '81. Indeed, Ampex had nothing new to report other than that sales were fantastic — over 5000 of its VPR series have been sold since the unit's introduction in 1976.

RCA, which introduced the TR-800 Type C system last year, stressed the complete recording and editing capabilities of the AE-800 editing system. The AE-800 system takes advantage of several of the TR-800's facilities, such as operation of playback machines in synchronization at variable speeds forward and reverse.

RCA displayed the TR-800's super-track accessory operating in conjunction with the TBC-800 time base corrector, playing broadcast pictures in reverse frame and forward at jog and other speeds. Also in view was the Multi-Rate Video Controller MRVC accessory for instant replay, which includes a nine-point permanent memory and a scratch memory for automatic search-to-cue and control of multi-rate video operation.

Sony's only new announcement was a three-hour long play one-inch Type C machine, the BVH-1180. This full-console version of the BVH-1100A has 14-inch reels that record 186 minutes, with a fast shuttle speed of 4.5 minutes for a three-hour tape. The machine has been designed for mastering and tape duplication and for playing automatic



3M's slow mo controller for VTRs stores up to 10 cue points

late-night or early-morning broadcasts. To provide audio confidence, a simultaneous record and play function has been added to three audio channels of the BVH-1180.

Hitachi also showed a three-hour one-inch Type C VTR, the HR-300, which incorporates a new transport with high-power dc motors. The HR-300 was described not as a specialty machine, but rather as a full production and editing system. It includes all of the exclusive features of Hitachi's HR-200 VTR.

The control focus of Hitachi's VTR display was the one-inch H.P.C. (Hitachi Production Center) system. The HPC package includes the HR-200 VTR, a TBC, and a new control console. Added benefits includes automatic correction of chroma level, independent differential gain and phase control, instant cue point shifting (with no need to re-search to the edit point), tape end sensing, illuminated tape path, expanded TBC control, and audio playback level controls brought to the console's front panel.

3M made a fairly significant addition to its TT-7000 line with the TT-7000-3. A new feature permits the user to go automatically to a preset slow mo or shuttle speed from any other mode (without going to stop). 3M says the feature allows forward and reverse speeds to be preprogrammed for natural slow motion playback.

3M also showed a number of new accessories including a slow mo controller, remote control, and studio console with a monitor bridge. The slow mo controller has memory storage of up to 10 cue points with selectable preroll from 0 to 10 seconds. It includes a 90-minute course clock, pre- and post-cue clocks, and a fine or exact second cue clock.

**NEED  
REAL  
FLEXIBILITY. . .**



. . . from your edit controller? **EDITMASTER** can be a 3 VTR system for your 10 a.m. client, a 6 VTR system for your next customer, a 14 VTR system next and a 2 VTR system for your last client. Easily! Plug in a coax cable with BNC connectors to your interfaced VTRs. Add or subtract at will! **EDITMASTER's** distributive processing and serialized communications gives you real flexibility. Of course, we use standard SMPTE time code and user bits, or control track. With DATAVID color data graphics, TAGALONG auto monitor switcher with dissolve and LISTMAKER edit decision list, **EDITMASTER** lets *you* design the system you need now. . . with the flexibility to become the size you want tomorrow. **EDITMASTER's** modular flexibility lets you grow with confidence.

**EDITMASTER**

*Growth through flexibility!*



**UNEMCO INTERNATIONAL, INC.**

MANUFACTURERS OF EMS PRODUCTS  
2102 RINGWOOD AVENUE  
SAN JOSE, CA 95131  
(408) 946-5076

## NAB SHOW IN PRINT



Studio console and monitor bridge are available as options with 3M's TT-7000 VTR

The new remote control permits operation of the recorder from up to 100 feet away. The monitor switch panel (rack mount) allows selection of the VTR input/output and remote control of TBC functions.

Part of the 3M exhibit was devoted to showing 3M's digital audio recorder synchronized with the TT-7000 VTR for improved TV sound.

New at the Marconi exhibit was a tie-in with A.F. Associates (AFA) — a side-by-side exhibitor. AFA, as exclusive sales representative for Macroni's broadcast products, exhibited the MR-2 one-inch recorder and the B 4624 monitoring unit (introduced last year) and described the company's expertise in designing and building systems. (Outside the exhibit hall, AFA's handiwork could be seen in the Total Communication System's 45-foot studio-on-wheels, the Video Voyager I.)

Options to the BCN 51 videotape recorder were demonstrated at the Fernseh, Inc. booth. First was a new slide store option that handles 171,000 frames (slides including random access and editing). With the TDF-2 frame store memory, full bandwidth video in both still frame and slow motion is possible. Another option was an extended play recorder, first shown at the 122nd SMPTE Convention. The BCN 51 EP can play a two-hour and 20-minute program without performance degradation. An analog TBC helps avoid quantization noise; Dolby noise reduction gives for optimum audio reproduction.

The BCN-51 EP uses 12-inch reels.

The benefits of Dolby NR for one-inch VTRs was one of the themes at the Dolby exhibit, which offered custom modification kits for Sony and Ampex machines. New this year was item 221, which provides two channels of Dolby A for the BVH-1100 and plugs directly into the VTR in place of the Sony Audio One and Two record/playback module. No modifications are required. A similar unit (220) is being prepared for the RCA TR-800.

Yet another source of long-play VTRs was Merlin Engineering Works, which offered extended play conversion kits (ME-238) for all Ampex and Sony one-inch machines. Merlin's most interesting product, however, was its ultra wideband video recorder, the ME-128.

This unit, a modification of the standard Fernseh BCN-51 records 14 MHz signals. Although it uses a standard scanner and standard heads and regular tape, the transport and servos have been changed to run both the scanner and tape at twice speed. New electronics join with this to produce 14 MHz at 45 dB S/N. The conversion is done at the module level so that machines can quickly be converted back to normal.

**For more information:** RCA super-track accessory, **384**; MRVC, **385**; Sony BVH-1180, **386**; Hitachi HR-300, **387**; H.P.C., **388**; 3M TT-7000-3, **389**; slow mo controller, **390**; remote control, **391**; studio console, **392**; Fernseh BCN options, **393**; Dolby 221 kit, **394**; Merlin ME-238, **395**; ME-128, **396**.

### Magnetic tape and accessories

The tape talk in Las Vegas centered around the future of metal tape for video. That may have been the talk, but only Fuji introduced any metal videotape, and that in VHS and Beta formats.

Fuji took two approaches: metal videotape (MV) and Vacuum Videotape (VV). Both are experimental at this point, with the formats being tested by major machine manufacturers to see how much redesigning is necessary.

Fuji says that the packing densities available on the metal tapes achieve recording wavelengths below the one micron level.

Jim Ringwood of Maxell feels that the trend in metal tapes is for use in digital VTRs and that metal tape "won't be around commercially for a year or two."

Maxell, for its part, introduced a new 20-minute version of its ¾-inch U-Matic videotape. In the half-inch format Maxell showed a new 4½-hour Beta videocassette, the L-750.

In audio tape, Maxell introduced two new open-reel tapes for slow-speed recording — the UD 18-180 and the UD

25-120. The two new tapes are designed to produce quality recording at speeds as slow as 1 7/8 IPS.

3M's Color-Plus U-Matic line now boasts an improvement of 2.5 dB chroma S/N over the industry standard. In the one-inch Type C format, most tape manufacturers made available extended play lengths for the new machines that can handle up to three hours of recording.

Tape accessories manufacturers were also hawking their wares at the show. Audico showed the production model of its 751 VTL videotape loader, introduced in prototype at last year's NAB. The company has upgraded the system so that it can handle almost any tape format from quarter-inch audio tape to ¾-inch videotape. The 751 VTL, priced at under \$5,000, will load tapes onto reels, carts, and cassettes.

Capital Magnetics has been making progress in the marketplace over the past year or so and is trying to expand that base. No new carts were introduced, but the company said it is developing metal tape carts.

Television Equipment Associates exhibited the production model of the Elcon EA 750 cleaner/profiler for U-Matic cassettes. The EA 750 allows the user to determine standards for acceptability for tape stock. Simple to operate, the system allows three functions: rewind only; rewind and clean only; rewind, clean, and profile.

The Garner Industries booth highlighted the Garner 1100 degausser for one-inch videotape. Introduced last year in prototype, the 1100 is capable of erasing 13 one-inch tapes per minute.

Nortronics introduced two new height gauges, the PF-710 and the PF-720. The PF-710 is a zenith/height gauge that provides zenith adjustment and height adjustment on both tape guide and track. The PF-720 checks tape guide adjustment on any open-reel recorder, checks all tape contact points, and has a locking thumbscrew that prevents movement during use.

Optek had the production model of the Model 8000 bulk tape degausser. Brought as a prototype last year, the Model 8000 handles all tape and completes its erase cycle in 32 seconds.

Taber introduced the Taberaser 409, which the company said is 40 percent more efficient than the older Model 309. Model 409 handles all tape formats and cycles in 20 seconds.

**For more information:** Fuji MV, **397**; VV, **398**; Maxell 20-minute U-Matic tape, **399**; L-750 half-inch videocassette, **400**; UD 18-180, **401**; UD 25-120, **402**; Audico 751 VTL loader, **403**; TEA EA 750, **404**; Garner 1100 degausser, **405**; Nortronics PF-710 height gauge, **406**; PF-720, **407**; Optek 8000, **408**; Taber Taberaser, **409**.

# A YEAR AGO NOBODY BUT SHARP'S ENGINEERS SWORE BY THE XC-700.



# TODAY THE PROS

**"WE DON'T SEE A \$27,000  
DIFFERENCE BETWEEN SHARP'S  
XC-700 AND A \$44,000 CAMERA."**

*—Larry Hatteberg, Chief Photographer  
KAKE-TV (ABC's Wichita Affiliate).*

"My cameramen were pretty skeptical when Sharp® introduced the XC-700 last year.

Like a lot of pros, they just didn't believe that a \$12,000\* camera could be any good. But we were looking for an economical way to go from film to tape, so we decided to give Sharp a shot.

We started using the XC-700 at the Democratic Convention last summer. And by the time we were covering the World Series, we were believers.

In fact, we've got seven XC-700's in our news department right now, and we're just one camera away from being an all Sharp operation.

So we've made the transition to tape long before I ever thought we could.

And we've done it with a minimum of compromise.

Of course, there will always be differences between an XC-700 and a \$44,000 camera. But reliability isn't one of them.

For day-in, day-out reporting, the XC-700 has held up as well as any camera we've ever used, even the most expensive ones.

It's also easy to handle. With the controls up front where a cameraman would expect to find them. And more features pound for pound than all the cameras I've seen in its class.

They say it was designed by cameramen, not engineers. But all I know is that the XC-700 has given our station a lot more for its money.

For \$44,000, we didn't just get a lot of camera. We got a lot of cameras."

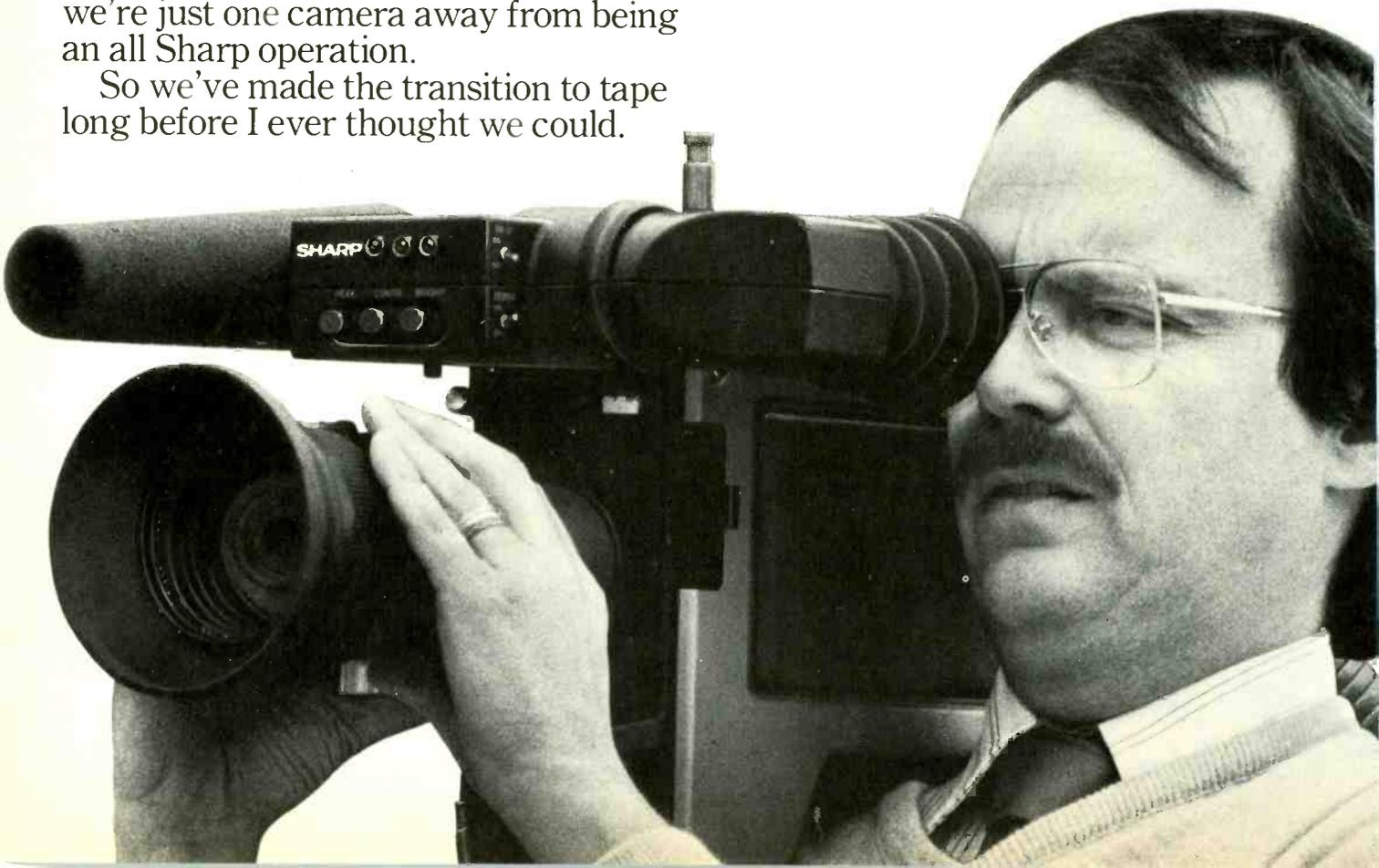

# SWEAR BY IT TOO.



**“FOR SHOOTING IN LOW LIGHT,  
SHARP’S XC-700 BEATS  
ANYTHING IN ITS CLASS.”**

*—Sue Hartung, Chief Photographer  
WLUK-TV (ABC’s Green Bay Affiliate).*

“Some of my best stories have been shot under the worst possible conditions. But with Sharp’s XC-700, the last thing I worry about is the light. I’ve covered warehouse fires and a bombing at night, with nothing but police lights or an occasional street light to shoot by. I’ve gotten shots of children touring a hospital, where the lights were kept low enough to read X-rays by. I’ve even photographed an operation for the removal of a brain tumor. And in every case, the Sharp® XC-700 really showed me something. It also surprised a few of my colleagues at the station, because we’ve all had bad experiences

with cheaper cameras in the past. So it’s refreshing to find a camera in the \$12,000 range\* that’s loaded with features and that has one other important thing going for it. Dependability. In our business, that’s the name of the game. Because our territory is 20 counties and our average story is an hour away, so I only get one shot at stories I’ve worked on for hours. And if I don’t get it with the camera, I don’t get it on the air.”

For more information and more field reports from other working professionals, contact your local dealer or write: Sharp Electronics Corporation  
Professional  
Products  
Dept. BME-6  
10 Keystone Place  
Paramus, New  
Jersey 07652

**SHARP**

\*Manufacturer’s Suggested Retail Price \$12,600. Less Lens.

Circle 128 on Reader Service Card



# THIS MAY BE THE ONLY WAY TO GET A BETTER WEATHER PICTURE THAN OURS.

Our new Weathermation Satellite Digital Color System II\* delivers a weather satellite picture unlike anything you've ever seen on broadcast TV.

In fact, it's such an incredible picture, the only way you're going to be able to get a better one is to go up into space and take one yourself.

Weathermation Digital System II translates GOES images of clouds into color digital display of selected geographical areas of North America.

Weathermation System II receives a fully digital signal more precise than any weather picture ever possible before.

It lets you acquire and display this more precise image of the weather in any area of North America within 15 minutes of when it happened.

Obviously this allows your local television station to produce weather reports at a technological level you've never been able to achieve before.

But System II also includes display options that can make the weather broadcast of any local station the equal of any network.

You'll have a choice of numerous colors and levels of shade, and different areas of North America

that can be as large as the whole continent, or as small as your own county. There's also the capability for animation and a floating enlarger that will enable your weathercaster to pinpoint precise conditions.

But perhaps the best feature of the Weathermation System II is that all these capabilities can be accomplished in a local phone call that won't last more than 2½ to 3 minutes.

Yet, a system that can change the shape of your weather reporting forever is not all that expensive.

So call us at 312/263-6921 or write Weathermation, 190 North State Street, Chicago, Illinois 60601, for details. We'll show you a weather satellite picture unlike anything you've ever been able to see before.

The new Weathermation Digital Color System II.

It lets the folks at home see what only an astronaut could see before.

*Weathermation*

## INTRODUCING OUR DIGITAL COLOR SYSTEM II

\*Weathermation is the exclusive agent for ESD, Inc.

Circle 129 on Reader Service Card



NAB SHOW IN PRINT

# ARTISTIC ADVANCES IN GRAPHICS SYSTEMS; STILL STORES

## Computers for control and signal processing have opened new vistas for video graphics

### Digital graphics

Virtually no field has grown as spectacularly during the past few years as digital video art systems. Ampex's AVA system continued to draw crowds as its artist rendered vivid pictures directly into the television medium. This year, however, AVA was joined by several others, ranging in sophistication from powerful computer-based systems arriving at NAB from the computer-based design industry to simple personal computer-based systems using the Apple II.

The flexibility and power of dealing with video in its digital form under computer direction has also created a massive upsurge in the graphics capabilities of character generators. Systems such as Thomson-CSF's Vidifont V and the Dubner Computer System have forever blurred the distinction between digital art systems and character/graphics systems.

This surge of activity in digital video art systems can be directly attributed to the progress made in removing the distinctions between video information for NTSC (PAL and SECAM too) and the processing of digital information as practiced in the computer industry at large. When the broadcast industry finally develops standards compatible with those of the large general-purpose digital world, a flood of powerful new systems will become available. The larger computer industry will then enjoy the economies of scale it requires in order to profit from paying attention to any particular computer application. Research and development investments will be spread over a much larger market base and development of devices can move from expensive, low-volume custom designs to inexpensive, large-volume generalized designs.

While last year's NAB Show-in-Print listed only one digital art system — AVA — this year there were nearly a dozen if character generator/graphics systems and computer animation sys-

tems with overlapping functions are counted into this group.

AVA (Ampex Video Art) is essentially unchanged in its hardware configuration. Software changes have been added, however, with AVA's increasing on-air experience. The software improvements include an improved lettering mode to permit left, right and center margins to be set automatically and to allow line or word justification (proportional spacing between words or lines so that each word or line begins and/or ends exactly at the margin). Individual characters on a line can now be inserted or replaced randomly.

A new "blue pencil" mode permits the artist to draw guidelines on the artwork without modifying the art itself. These guidelines can be used to establish definitions for the creation of new art derived from the preceding image or to alter the existing image. A new "art director's mode" permits the creation of specific artists' files. An entire piece of art, or elements of it, can be recalled or transferred from file to file. Such software enhancements, tied with improvements in other modes (such as "cut and paste," overlay grid, and design palette), continue the process of providing the artist with the computer-assisted equivalent of techniques used in conventional artistic media. Depending on options, the AVA system is still priced in the \$150,000 to \$200,000 range.

MCI/Quantel, similarly concerned with emulating traditional artists' techniques and tools, withdrew in 1976 from offering a computer art system called "Intellect" to the broadcast marketplace. This year, however, Quantel returned to the field with a system it has dubbed "Telegraphics" 7000. As with earlier Quantel product introductions, the 7000 was shown only to a limited audience in the company's suite. Pending analysis of the reaction to the product, it will make its debut to the general public probably within the next year.

With the four years' development between "Intellect" and "Telegraphics," Quantel claims to have produced a system that offers a new approach capable of "fine art"; that is, art devoid of the "electronic look." According to the manufacturer, there is "no discernible difference between the

electronic result of the machine and a camera looking at conventional artwork."

The 7000 is "full color" rather than "partial" color. Instead of offering 256 colors, or some other fixed number of color selections, the 7000 offers the user the ability to mix any of the colors presented on the palette to create new colors, shades, and hues, just as a conventional artist mixes colors. Even the way the operator accomplishes this is "operationally similar" to the way it is accomplished conventionally. The color menu presented to the artist includes a "mixing" area. The artist dabs the brush (stylus) into one paint color and smears this in the mixing area; selects a second color and then smears and mixes this with the first color in the same area. When the desired hue or shade is achieved, this color can then be assigned to the brush for use on the "canvas." In appearance, the system is similar to the others. A color monitor output displays the results of the artist's activity, while the artist actually moves the stylus over a touch tablet. There is also a monochrome screen and keyboard for housekeeping displays and functions.

To achieve textural qualities similar to those associated with oil colors or watercolors, the artist can build up saturation levels on the canvas by varying the pressure he applies to the stylus. This, says the artist who demonstrated the Quantel system, has very much the same "feel" as the conventional technique.

The picture output of the 7000 is of extremely high quality with virtually no aliasing. The system consists of a mini-computer, supporting electronics (10½ inches of rack space), Winchester disk and floppy disk memories (occupying 5¼ inches of rack space), in addition to the operational equipment. Twenty full pictures can be stored within the system or the pictures can be either output to the floppy disk or aired directly. A full digital interface is provided for the direct connection of the Telegraphics unit with Quantel's DLS-6000 still store and library system.

A firm price has not yet been established for the 7000, but company spokespersons indicate that it will eventually enter the market priced between \$90,000-100,000. Included with the

## NAB SHOW IN PRINT



Thomson's Tom Hindle runs through the new Vidifont Graphics V

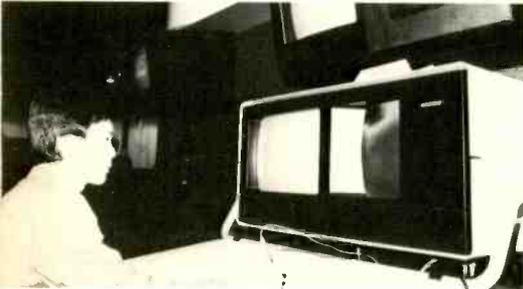

Ampex's AVA system was joined this year by nearly a half dozen other digital video art systems

functions discussed above are brush selection, various art modes, and an inventory of functions similar to those offered by other systems.

Aurora Imaging Systems, a company new to NAB, showed its Digital Videographics System, which is already on-air at KRON-TV, San Francisco. Another system is on order for installation by the Societe Francaise de Production, France's national production center. Depending on the configuration of the system purchased, a Digital Videographics System could cost between \$125,000 and \$225,000.

In addition to the electronic mimicry of conventional artists' techniques, this system features three animation modes. The simplest form of animation, cycling, is common not only to this system but to a number of character generator/graphics systems. Basically, different colors, or shades of color, are cycled through. When the color of the foreground object is the same as the background it seems invisible, while objects of a different color are visible. By cycling through the colors, the appearance of motion is achieved as the objects, drawn at different locations, come in and out of the background color. Cycling and the other two types of animation, step-wise and reveal, are achieved by smooth, internally generated dissolves between individual steps in the process.

Another aspect of the Aurora Imaging approach is its use of a symbolic menu display. In addition to a written

function label on the menu screen, each function is identified by a symbol—the "fill" mode, for instance, pictures a partially full beaker with an arrow rising from the fluid towards the brim. "Fill" is a mode common to many of these systems that permits the artist to direct that a particular area of the picture be filled with one color rather than having to actually paint in the desired color to the drawn borders.)

From the systems design standpoint, Digital Videographics consists of two operating stations with different functions tied to the CPU and storage systems. The design station, probably located in a graphic arts department, is the station used by the artist to create the graphic or animation sequence. The display station would probably be located in a control room from where the operator would call forth stored artwork for inclusion in a program. The CPU, imaging electronics, and storage system can support up to three design stations (though only one design station may be active at a time) or one design station and up to six display stations (though only one display station may be active at any one time).

The system's disk storage is 10 Mbytes, capable of storing 100 or more typical pictures. Complex pictures or animation sequences might reduce the number of actual pictures stored. An optional library disk storage system increases the capacity of the system by 80 Mbytes, allowing storage of up to 2000 or more typical pictures. A one Mbyte optional floppy disk storage is offered to permit pictures to be carried from the system, or stored away from it for other purposes. The design station system has two standard RGB video outputs (with sync) plus one NTSC RS-170A output. The display station has a single RS-170A NTSC composite video output.

Appearing at NAB for the first time was the \$102,400 system from Computer Graphics Lab. This system is the offspring of the digital graphics work done at New York Institute of Technology. Anyone who has followed the development of digital graphic art systems will recall the pioneering efforts initiated by NYIT.

The system shown at NAB is a stand-alone unit using 11 Mbyte Winchester-type disks with a 5 Mbyte removable back-up disk. The computer is an LSI-11.

Resolution is 512 by 508 with a 60 ns per pixel resolution. The system provides eight-bit color with selection between 256 colors or an optional filtering system for color mixing.

Another videographics unit was exhibited at NAB by Ramtek. While Ramtek is new to NAB, it has supplied the computer industry with video graphics systems for some time. Shown

at its booth was its 6214 Colorgraphic computer, based on the Z80 micro-computer with 96 Kbyte RAM, a floppy disk drive and controller, 164 Kbytes of RAM-based screen refresh memory, high resolution color monitor, and keyboard. The system, as is, is user-programmable in Pascal or assembly language. A digitizing tablet is available for "hand drawn" input.

The system, like many that are used in the computer industry, works in RGB, but output for broadcasting is via an NTSC (PAL or SECAM) encoder. This highly modular system provides a long list not only of computer peripheral equipment but also of operating program options. In RGB, the resolution is 1280 elements by 1024 lines, but the NTSC encoded output is 640 elements by 480 lines. Extremely high quality images are achieved through Raster Scan Technology, which the manufacturer claims is superior to techniques used in some of the other systems.

Because the system is a generalized computer capable of running not only color graphics but also other Pascal (version IV.O) programs, the company's spokesperson suggested that numerous stations' display programs would be appropriate to the system. Specifically, sports graphics and scores, election reporting, and weather reporting functions were suggested. Station management functions, such as statistical analysis, graphing, and chart needs could also be met.

Joining with other exhibitors from the U.K., Logica, Ltd. discussed its ICON digital graphics computer system. This system was exhibited at this past September's IBC in Brighton, U.K., and reported in *BM/E's* November, 1980 issue. At that time Logica demonstrated a smaller scale digital video art system it had developed in conjunction with the BBC. With its NAB presentation, Logica took its first tentative steps into the American market.

While the ICON system is a very large, very sophisticated computer system for graphics and data processing, the smaller system, now dubbed Flair, is intended for station-level operation. Flair is operationally similar to the other art systems and should be ready shortly for its American debut.

The Apple II was evident in a number of exhibits, operating for business programs, off-line graphics, and on-air graphics. For on-air use, however, the Apple II needs modification. Two companies, Adwar Video Corp. of New York and Video Associates Labs, Inc. of Austin, Texas, showed the necessary interface modifications.

Adwar's version is called the ARS-170A. This PC board based modification provides crystal black burst gen-

# TOSHIBA'S PK-60 MAKES NEWS... THE SMALLEST, LIGHTEST NEWS/PRODUCTION BROADCAST CAMERA ON THE AIR. WITH A DIGITAL MEMORY THAT WON'T FORGET.

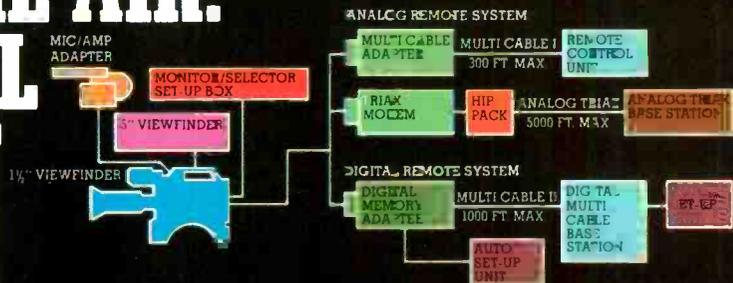

Here's the newest ENG/EPF camera from Toshiba. Just right and so light for broadcast news. It's this combination of features that make the PK-60 a small standout.

- 9.4 lbs.
- Small Size
- Reduced Power — 20.6 watts
- Outstanding Stability
- Digital Data Loc
- Microprocessor-based Auto Setup Unit
- Digital/Analog Base Stations
- Triax/Wireless Transmission

Digital Data Loc is Toshiba's digital memory that can be preset by the engineer and travel to the act on scene.

Toshiba's versatile PK-60 with advanced new circuitry, unbeatable overall performance and... Toshiba's celebrated quality.

**Toshiba America, Inc.**  
Broadcast Electronic Systems Division  
292 Gibraltar Drive, Sunnyvale, CA 94086  
(408) 734-9172  
Eastern Sales and Service  
2971 Flowers Road South, Atlanta, GA 30341  
(404) 458-95E2

**TOSHIBA**  
In Touch with Tomorrow

## NAB SHOW IN PRINT

lock, H, V, and burst phase adjustment, blanking width adjustment, and other necessary signal conditioning to meet RS-170A requirements. The output of the Apple II graphics system can then be keyed, mixed, or aired.

Video Associates' version of the modification is based on two additional PC boards that plug into the Apple II, but use none of its memory. The VAL VB-1 features downstream keying, chroma on/off switch, programmable horizontal offset, adjustable hue control, adjustable chroma amplitude, preview automatic color framing, and an external power supply. The output is NTSC. Installation of this modification takes about 15 minutes and involves no tracing or soldering. One of the two boards fits into one of the Apple's seven slots while the other mounts above the power supply and is connected by DIP.

About 18 stations, according to a spokesperson, are already using this \$2200 modification. With it, stations use the Apple II as a color titler, for generation of weather maps, limited animation effects, and animated logos. By purchasing the optional digitizing pad or tablet from Apple directly or a similar unit, the Versawriter, from Versa Computing, Inc., users can create their own graphs and charts.

**For more information:** Ampex/AVA "Blue Pencil," 410; MCI/Quantel Telegraphics 7000, 411; Aurora Imaging Digital Videographics, 412; Computer Graphics Lab, 413; Ramtek Colorgraphic, 414; Logica ICON, 415; Flair, 416; Adwar Video ARS-170A, 417; Video Associates VB-1, 418.

### Character generator/graphics systems: artful improvements

Broadcasters have grown accustomed to seeing a new round of software-based enhancements in color character generator/graphics systems at each successive NAB. Hardware changes have also been introduced from time to time, particularly in the area of new input systems, digitizers, and font compose options. This year, the digital video art systems had not only camera inputs for grabbing whole black and white pictures for further manipulation but also increased text capabilities. Character generator/graphics systems responded by greatly improving their own animation and colorizing capabilities. The result? A much more difficult job of distinguishing between the two approaches.

The best way to distinguish between the systems seems to be their principal functions. Character generator/graphics systems still primarily serve to

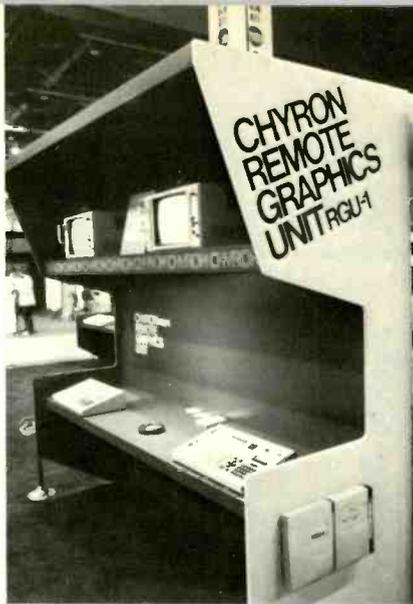

The Chyron IV's CCM allows two-channel effects

quickly compose text-based messages for display on television. The graphic arts capabilities in such systems are largely in support of the textual functions. Digital video art systems, on the other hand, primarily allow the artist to create hand-crafted art directly in the video medium with textual capabilities in support of the artwork. As a result of this, art systems focus on the digitizing tablet as their primary input device while character generator/graphics systems still rely on the keyboard.

Vidifont Graphics V, from Thomson-CSF Broadcasting, Inc., is undoubtedly the largest step forward made by any established character generator/graphics system manufacturer this year. By adapting a full framestore and employing bit mapping techniques, Graphics V has gained random access to any and all pixels independently. Once complete access to all pixels has been achieved, software can be written that defines a wide range of dynamic events which occur temporally as well as spatially.

One of the major benefits to be derived from such an approach is the freeing up of at least one production switcher mix/effect bank. For instance, if a diagonal banner is to ripple onto the screen over a keyed graphic, the effect would generally require at least one switcher-initiated wipe in addition to the key. Moreover, the diagonal banner, with lettering properly kerned, would conventionally be accomplished not by the character generator but through the use of an art card, which the switcher would see through another camera input.

The Graphics V can accomplish this effect completely internally, with the aid of the switcher required only to put the function on-air. If, for some reason, it is also desirable to make some on-air change in the graphic under the banner without affecting the banner, this too can be accomplished without

involving the switcher.

What is involved here are several fundamental changes in system architecture achieved as a result of the framestore and bit mapping aspects. The two most difficult things to achieve in the foregoing example are writing on a diagonal and altering one element in a graphic without affecting other elements in the same graphic. Normally, the alteration of a graphic could be achieved on a dual-channel system, but the Graphics V requires only a single channel to accomplish this because it defines the graphic as existing on a series of transparent planes, similar to layers of acetate as used in conventional graphic arts techniques.

The Graphics V is available in single and dual-channel systems so that displays can be faded in/out as a downstream key on a single channel or cross-faded with the independent output of the other channel. Background and foreground displays can be manipulated independently of the other planes. Up to 16 character planes can be stacked, permitting such effects as fan-out, and information on each plane can be "swapped" with the information on another plane. The system has two low-resolution channels in addition to its two high-resolution channels. The low-resolution channel permits access to formatted displays to change or update information in the high-resolution channel. While the low-resolution channel will not show the actual graphic, it will describe that graphic in English so that if sports scores or vote tallies were existing on a separate plane in a multi-planar display, only the information requiring updating would need to be changed and other elements of the graphic would remain unaltered.

Up to eight keyboards can function simultaneously, two operating with access to the high-resolution channels and six operating with the off-line low-resolution channels for updating and editing of messages. The basic Graphics V system sells for \$59,500.

Another multi-plane display character generator/graphic system was shown by Dubner Computer Systems, Inc., a newcomer to NAB. Readers of *BM/E's* ABC Olympic coverage (April, 1980) will already be somewhat familiar with what the Dubner CBG unit can do. Viewers of ABC's *Wide World of Sports* and *20/20* have frequently seen the CBG at work.

This \$76,000 system (more with options such as dual floppy disk drive and digitizer system options) has two display planes. Each plane can use any 64 of 512 possible colors. Colors are specified by eight levels each of red, blue, and green; each color can be keyed or unkeyed, transparent or opaque. The two planes (background is defined as an entire plane of 525 lines

# EYE-OPENERS

Just when everyone had their eyes wide open to the outstanding line of Ikegami broadcast and production color cameras, Ikegami introduced its color and B&W monitor line, engineered with the same innovative technology as its cameras. A great tradition of eye-opening continues with precision, quality and beautiful images.

The Ikegami color monitor line consists of the High Resolution Series RH Color Monitors and the High Performance Series 8 Color Monitors. The High Resolution Series RH Color Monitors are available in the 14" TM 14-2FHA and the 20" TM 20-8RH. Both provide precision color reproduction at 600 plus lines for professional studios, control rooms, remote vans, etc., and feature a high resolution CRT with High Density Dot Matrix, a switchable comb filter in the decoder, and the AFPC (Automatic Frequency Phase Control) system to maintain exceptional color reproduction. Both models are rack-mountable, with the TM

14-2RHA featuring plug-in circuit boards for easy maintenance.

The High Performance Series 8 Color Monitors are available in the 14" TM14-8RC, 20" TM20-8R and 25" TM25-8. The Series 8 monitors offer high quality color reproduction, a Shadow Mask Dot Matrix CRT, Pulse Cross Circuit, Active Convergence Circuit, low power consumption, and more.

The B&W Monitors are engineered to the same exacting Ikegami standards and are available in Triple 5", Dual 9", 5", 9", 12", 17" and 20" sizes.

Ikegami's Eye-Openers are available at most dealers. For details and additional information, contact: Ikegami Electronics (USA) Inc., 37 Brook Ave., Maywood, NJ 07607, (201) 368-9171; West Coast: 19164 Van Ness Ave., Torrance, CA 90501, (213) 328-2814; Southwest: 330 North Belt East, Suite 228, Houston, TX 77060, (713) 445-0100; Southeast: 522 So. Lee St., Americus, GA 31709, (912) 924-0061.



*Video Products built to Ideal Standards*

 **Ikegami**

Circle 131 on Reader Service Card

# GLOBAL IX™

Now, from the new revolutionary GLOBAL IX series, Farinon Video introduces the only truly universal portable video microwave transmitter. For the first time there's a single portable transmitter capable of covering any 2-GHz frequency plan in the world.

With the unique GLOBAL IX wideband transmitter, you can select more channels than ever before—up to 55 channels in each of 16 different frequency plans. Standard plans or you name it. And RF channels can be selected locally or remotely. Now that's versatility.

You'll wonder how such a compact transmitter can provide 3 Watts of wideband power. But if that's not enough, there's an auxiliary 12-Watt power amplifier available too. And the transmitter interface can be either baseband video or true 70-MHz heterodyne.

Here's another first. Two audio channels with programmable subcarrier frequencies can be transmitted simultaneously. And you have the choice of line level or microphone level for either channel.

To simplify maintenance, the GLOBAL IX portable transmitter has built-in diagnostics. Problems can be quickly diagnosed by monitoring the indicators on a remote channel selector or a separate display unit.

You can power the transmitter from AC or a car battery—or even a standard power belt. What's more, you won't find a more rugged or environmentally reliable transmitter no matter where your crew takes it.

This unique portable video microwave transmitter is representative of the state-of-the-art products in the all-new GLOBAL IX series. Another example of Farinon Video's quest to provide superior video transmission equipment for use throughout the world.

For more information, contact HARRIS CORPORATION, Farinon Video, 1680 Bayport Avenue, San Carlos, CA 94070; (415) 595-3500;

Telex 34-8491. In Canada, 657 Orly Avenue, Dorval, PQ H9P1G1; (514) 636-0974; Telex 05-82-1893.

## The Only Portable Video Microwave Transmitter You'll Need in All the World.



**HARRIS**  
FARINON VIDEO

## NAB SHOW IN PRINT

by 1024 pixels, while the foreground plane consists of standard fonts or custom fonts such as logos or graphic symbols) can be merged or "woven" to make ever more complex pictures.

A 54-key ACSII keyboard is the primary operator interface to a system controlled by two Intel 8080 microprocessors (a CPU and memory manager). A hard disk drive with two 5 Mbyte disks (one removable) provides the main memory for up to 255 fonts, 9999 text messages, 100 to 500 backgrounds, or any combination of these aspects on each disk. A dual floppy disk option is available for library storage, as is a digitizer for input of NTSC or black and white art through a camera. The digitized image is stored as a 64 grey level background.

Operating modes include a normal compose mode for working on either or both planes; a Palette mode for selecting up to 128 colors from the 512 possible (64 colors on each plane); Font Load Mode; and Font Fix Mode for the creation and modification of font characters and backgrounds. Fonts may be of any size up to 485 lines high by 1024 pixels wide. Each font can contain up to 96 characters.

Like the Vidifont system, the Dubner CBG can type on the diagonal with character kerning. A full range of dimensional, drop-shadow, and colorizing capabilities are provided. Animation, particularly strong in the Dubner CBG, can be any length in duration up to the capacity of the memory, and can occur at any rate up to real time (or 30 fps).

As part of its design commitment to not obsolete its system, Chyron has taken a different route to achieve some of the same capabilities. This year, the Chyron IV has added Channel Control Modulation (CCM) which permits the outputs of both channels to be mixed. The operation, supervised by a Z-80 microprocessor, provides a number of benefits. Like the multi-level systems previously discussed, the two channels can be seen as two planes or levels — that is, laid one over the other. One difference, however, is that information is tied to the channel it is on so that it does not, in fact, pass information from one level to the other.

Nevertheless, this approach does allow a large number of functions to be achieved simply and economically. A Scoreboard function, for instance, allows alphanumeric data on one channel to be updated independently of graphic material on the other channel. Up to six "box scores" can be chained together for updating. When the score is superimposed over the graphic elements there is no required change in the other

level. This option is a less than \$1000 change to the basic Chyron IV software.

In addition to "Scoreboard," the CCM approach has allowed for a lot of switcher-type effects to be added to the Chyron, including wipes. An auto-sequencing mode is now available because of the handshaking that takes place between the channels, allowing very substantial animation results. Also, operator strokes can be learned by the microprocessor for modification and recall. All of this, it should be noted, has been achieved with modest costs in mind.

**For more information:** Thomson-CSF Vidifont Graphics V, 419; Dubner CBG, 420; Chyron CCM, 421.

### New systems debut, others change

High-quality character generation and graphics capability already has been achieved. Now the game is cost and function. Last year the stir was caused by the interface of character generators to other computer systems for the purpose of updating displays such as weather, scores, and vote tallies. This trend continues, though now taken in stride by many manufacturers of such systems. The force of multilingual audiences in this country and the pressure of a "new" international market has led to a sound round of subtiting capabilities.

Wholly new systems were also in evidence. System Concepts introduced its Q-8 system, which features the capacity of up to 18 fonts in resident memory, a disk library, and stored logos. The Q-8, priced at \$27,995, has an impressive array of standard features for the price. This dual floppy disk system permits control from multiple keyboards with tally and lockout controls for the delegation of authority.

The fonts can consist of three different type faces with different sizes. Custom design fonts and logos are possible with the Q-8, which also features proportional spacing of its 64-element character designs. Random access or sequential access to both of the 100-page disks is provided with unlimited "next disk" sequencing. Automatic centering, right justification, and a variety of roll, crawl, and positioning capabilities are provided. Eight colors are selectable by row for backgrounds; colors for letters as well are available in a variety of block and underline functions.

While scaling up one end of its line, System Concepts also displayed the Microgen, a low-cost titler. Microgen offers 12 pages of internal memory, capable of 6000 characters, with all the basic titler level functions such as crawl, roll, and flash. The Microgen



System Concepts brought its Quantanews system for television newsrooms

also offers a complete second channel for composition while on air.

Videomedia's first offering to the character generator field is the KR-6000, a high resolution (35 ns) character generator designed specifically for inclusion in the post-production stage. Depending on options, the system is priced between \$10,000–15,000 and though it is especially suited to operation in post-production with Videomedia's Z-6000 editor, it also operates as a standalone.

What makes the unit a post-production system is a variety of "switcher"-type functions and its interface with the edit controller. In the simplest post-pro setup, the KR-6000 will lock to any incoming color sub-carrier signal and provide fade in/out and fade up/down from black for both the keyed text and/or the incoming color video. Obviously, a host of simple post-production needs involving titles can be met with the KR-6000. Such functions would normally require a four-bus switcher with downstream keying. Control of the KR-6000 can be local or delegated to the Z-6000.

Even though its design feature is its inclusion in the post-production system, the KR-6000 offers a good range of normal features including full drop-shadow and edging, colorizing by character, changeable font cartridges (up to four resident fonts on-line; each font can be any size), 16 programmable colors, vertical and horizontal centering, proportional spacing, and a variety of other functions. Careful consideration has been given to the I/O structure of the system so that it will be compatible or expandable as new options and configurations become available.

A new low-cost titler (\$4595) was shown by Video Data Systems. The TPT-2500 is a microprocessor-based titler offering 32 pages of internal memory (each page is 14 lines of 32 characters). Characters are of two widths (16 or 32 characters per line) and three heights (16, 32, or 64 per field). A "word integrity" editing function will automatically reformat lines and words to eliminate any broken words at the

## NAB SHOW IN PRINT

end of lines. For subtitling, crawls can consist of two lines of either 216-character length or 984-character length.

Characters, borders, and drop shadows can consist of any combination or permutation of black and white. Page display can be automatic with an operator-designated dwell time of one-quarter to nine seconds, in quarter-second increments, one to 63 seconds. An optional DC-2500 Digital

Cassette Memory can hold 58 blocks of data, each 480 characters long, for automatic dumping into the resident memory for extended titling or message cycling.

For-A Company's Video Typewriter, VTW-600, is an extension of the concepts introduced in the VTW-300. The 600 essentially adds a number of new options and functions including a character design unit and a color control unit. The wipe unit and card memory unit available with the 300 have been retained.

The character design unit permits the

operator to "draw" with a lightpen new characters (or symbols) which are assigned to one of the keys on the keyboard at the operator's discretion. In subsequent operation, when that key is depressed the created character or symbol will appear rather than the letter inscribed on the key. Thus, using either the shift key or infrequently-used symbol or numeric keys, a large number of custom symbols can be brought on-line. The color control unit can assign any of eight colors on a character-by-character basis. The full system, with all options, runs around \$15,000.

Several of the more familiar systems showed new functions and options. As mentioned earlier, a couple of new approaches have been taken for subtitling foreign language programs and for other subtitling needs.

Fernseh Inc.'s Compositor I, for instance, showed its new subtitling option for the Compositor I. Up to 2000 subtitles can be stored for up to 2400 events on a replaceable disk cartridge memory system. Since each subtitle is randomly accessed, repeated subtitles can be assigned to appropriate events without having to duplicate the composition of the subtitle. For instance, a dialogue response like "Yes" need only be entered once and used whenever appropriate.

Each subtitle address is tied to a specific SMPTE/EBU time code location by a mark-in, mark-out process. After the subtitles have been composed and associated with their proper events, their playback is slaved to the VTR playback and the subtitles burned into a new videotape containing both subtitle and picture information. Accuracy of each subtitle to SMPTE time code location is plus or minus one frame. The necessary SMPTE/EBU reader equipment is included in the option, which is available on all 64K computer-equipped Compositors. Earlier 32K Compositors are retrofittable.

System Concepts has added a subtitler option to its Q-7A/R character generator system called QST. Working with the dual floppy disk, Q-7A, QST offers up to 500 three-line subtitles and 50 inserts per disk. When the first disk is completed, the second disk comes on line automatically. The first disk can then be replaced by a third disk, essentially making the subtitling/event complex infinite.

While the three 32-character rows are normally displayed in the lower third of the picture, they can be positioned for the deaf or in any part of the raster to eliminate conflicts with the background.

A full range of timing mode adjustments are available using either external or internal time code cues. For display, the subtitles can be run in parallel with the program material or burned in.

## Comsearch Will Clear the Way

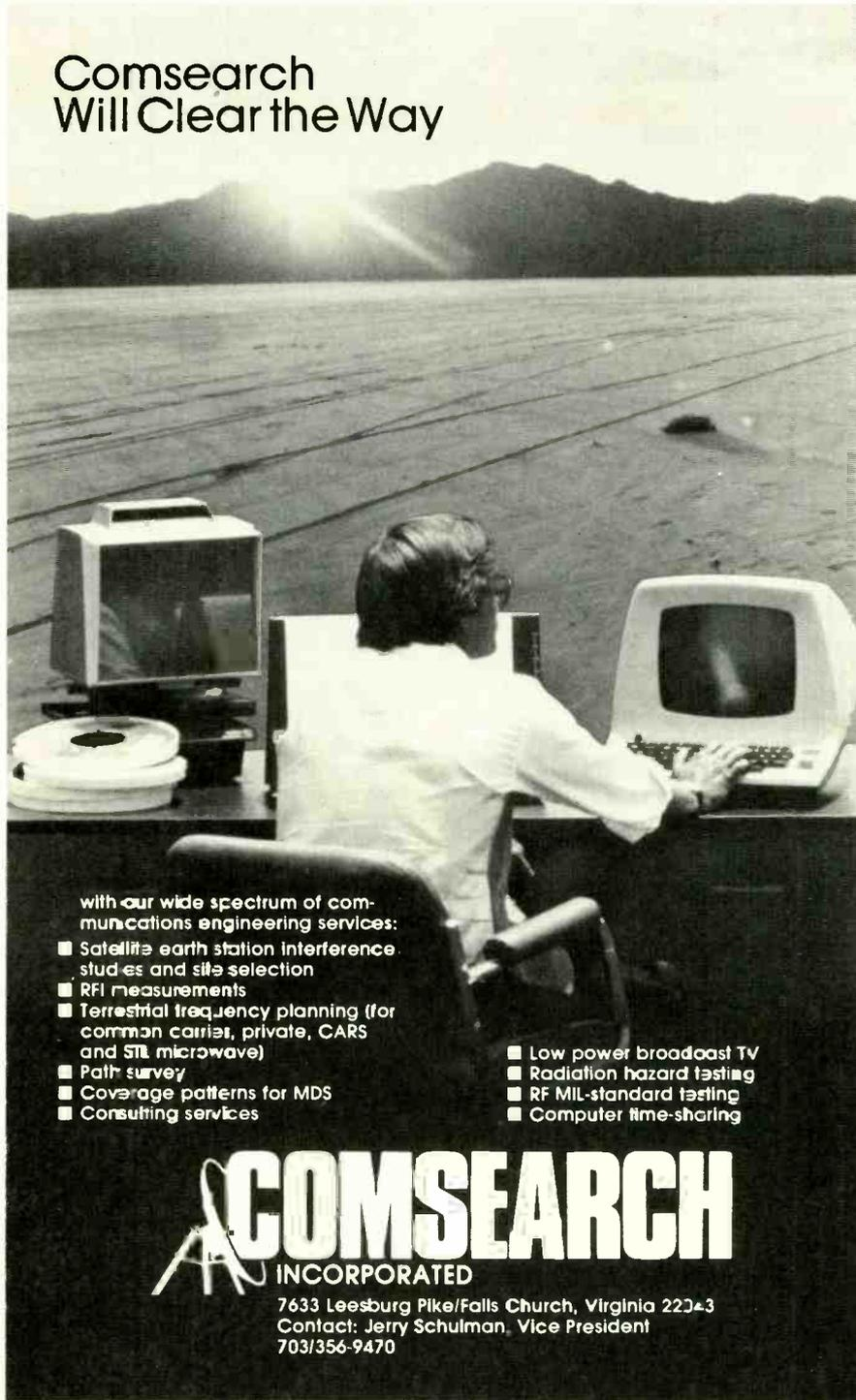

- with our wide spectrum of communications engineering services:
- Satellite earth station interference studies and site selection
- RFI measurements
- Terrestrial frequency planning (for common carrier, private, CARS and STL microwave)
- Path survey
- Coverage patterns for MDS
- Consulting services
- Low power broadcast TV
- Radiation hazard testing
- RF MIL-standard testing
- Computer time-sharing

# COMSEARCH

INCORPORATED

7633 Leesburg Pike/Falls Church, Virginia 22343  
Contact: Jerry Schulman, Vice President  
703/356-9470

Circle 133 on Reader Service Card





# Vital today: hands-on demonstrations!

The best way to get the big picture: put yourself in our place — in our spectacular new Florida Showroom! It's a realtime Production Studio with working Control Room. Where you can get your hands on the most sophisticated video equipment available today for bigtime live production. Where you can see and try out for yourself all the latest Vital systems — all fully operational right in the Showroom.

To put *your* hand on the switch, call for an appointment today. Or visit our West Coast Showroom in Hollywood, California: (213) 463-7393.



**VITAL INDUSTRIES, INC.**

World Headquarters:  
3700 NE 53rd Avenue, Gainesville, FL 32501  
Tel: 904/378-1581  
TWX: 810-825-2370. TLX: 80-8572-Vital-A-Gain

**Vital offers you your own private NAB Showtime, 12 months a year.**

## **NAB SHOW IN PRINT**

3M's D-8800 Graphics Generator introduced a new camera compose unit at this year's NAB. The camera digitizer takes the standard output image of any monochrome camera, digitizes it, and stores it in the on-line memory of the D-8800 unit. Once stored, the image is cleaned up of digitizing errors and can be modified manipulated (both H and V flips), reduced in height, italicized, and affected by a variety of other color-based functions.

Another new aspect to the D-8800 and 3M's 2000 series units is an interface with Telesource Communications Service's information system computer. The interface will permit the station character generator to tie into a national computer information network for updating of election returns, sports scores, weather information, and — ultimately — a wide variety of other database services that may become available. The interface, Television Titrer Controller (TTC), will permit the automatic updating of a variety of formatted displays.

BEI, now manufacturing the Marquee 2000 under license here in the U.S., has added two new options to this high-end character generator/graphics system. Font compose is a \$5000 option that permits the user to create new fonts using the 2000's keyboard. Characters can be any size between 18 and 66 TV lines, while logos or other artwork input via a monochrome camera can be up to 100 TV lines in height. The Marquee's character resolution is 31.25 ns. A number of editing functions permit the refinement of the composed fonts, which are ultimately assigned to any selected key on the keyboard.

Both Knox and Laird Telemedia showed their full lines of character generator systems fundamentally unchanged from last year. Knox did say that it planned "some new things for next year"; until then, the K128, K50 and K60 character generators will carry the banner.

Laird showed a new video pointer, Model 1060A, as an addition to its line. The video pointer is a standalone accessory that permits an operator to insert a black, white, or transparent arrow into a picture. The arrow can be positioned via a joystick and "pointed" in any of eight "compass directions." It can be varied in size or flashed.

Shintron introduced a new version of its Model 505 Videotypewriter, the 505L. The new model provides 16 pages of non-volatile memory that can be retained for up to 30 days after power is shut off. The non-volatile memory permits the 505L to offer such features as roll control, crawl, window display, flash, and isotropic font enhancement. Lower case fonts are also possible now.

**For more information:** System Concepts 0-8, **422**; Microgen, **423**; QST, **424**; Videomedia KR-6000, **425**; Video Data Systems TPT-2500, **426**; For-A VTW-600, **427**; Fernseh subtitling option, **428**; 3M camera compose unit, **429**; TTC, **430**; BEI font compose option, **431**; Laird 1060A, **432**; Shintron 505L, **433**.

## **HIT THE ROAD.**

**On August 10, 1981, Clarion will roll out Chicago's first Compact Video Systems Inc. Phase Three television production unit...**

That's when Clarion Production Services will make Chicago the home of the world's finest mobile television production unit. It will be equipped with the very latest in state of the art video equipment. Everything you need to go on location for network and syndicated, live or taped multi-camera program production. From pre-pro to post-pro. All in a forty foot tractor trailer unit with a thirty-six foot companion trailer for production meetings, a portable green room, or just for lounging around.

For more information, call General Manager Bob Bemis. He'll tell you about his unit, how you can rent it, and what it will cost.

## **CLARION PRODUCTION SERVICES**

Eight South Michigan Ave.  
Penthouse Suite  
Chicago, IL 60603  
312/781-0080

### **Still stores/slow motion**

There was not a lot of action in the still store and slow motion recorder area this year, though there were a couple of new systems and new models.

Several of the models that were introduced last year are now in production, and new options have been added to some of these. New slow motion controllers have been issued by several one-inch VTR manufacturers, including RCA, Sony, and 3M.

A new still store system was shown by ADDA Corp. — ESP R. This system is portable and uses 14-inch fixed disk drives with still storage capacity of 80 stills per disk. The unit, which sells

# THE PROFESSIONAL'S CHOICE

## MORE STANDARD FEATURES TO BEGIN WITH

## MORE OPTIONS TO GROW WITH

# VIDEO TEST SET

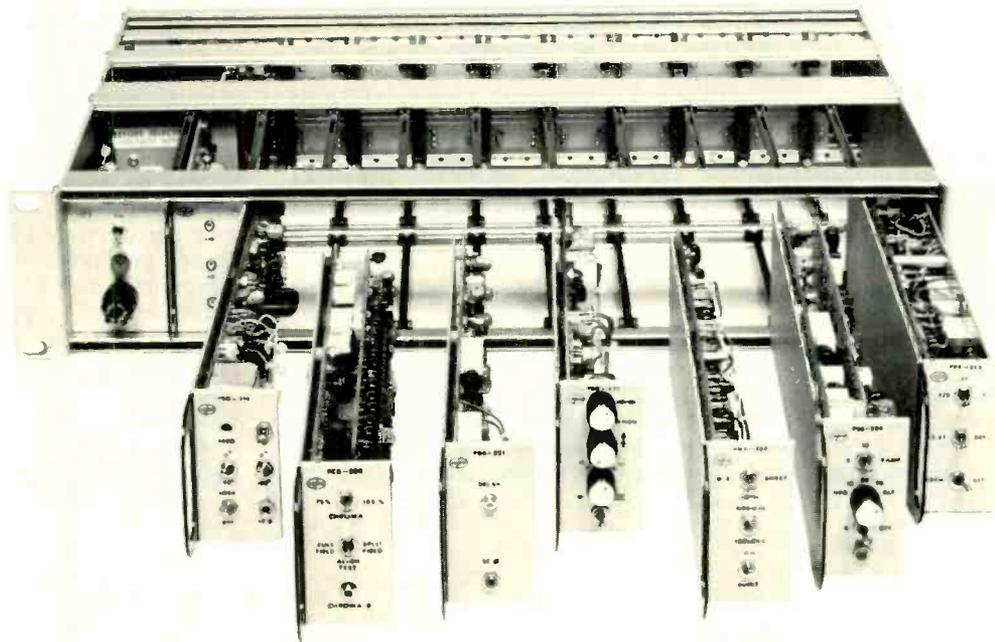

This totally integrated modular video test set is designed for the discriminating professional. The Lenco 300 System lets **you** specify video test signals to meet **your** system requirements, not the manufacturer's.

Use the Lenco PSG-310 Digital Color Sync Generator, or the PSG-312 RS-170A generator, with any one or a combination of all the test modules. Mix 'em or match 'em any way you want. There are 29 test signals available to answer **all** of your system test specifications.

With the Lenco 300 System, you get a lot more for a lot less. For instance, all of our advanced test signal modules have composite

video delay, making Lenco the **only** manufacturer that can **individually time** the test signals to your system.

And we're the only American manufacturer that supplies a color bar generator with the new SMPTE alignment test signal (reverse bars).

We're so sure of your acceptance of Lenco equipment that we offer a **two-year** warranty on all parts and labor—and that includes freight to and from our factory!

Call or write for a demonstration today. You'll find Lenco to be your first—and only—video test set alternative.



## LENCO, INC., ELECTRONICS DIVISION

300 N. Maryland St., Jackson, MO 63755, (314) 243-3147

### The Professional's Choice

Circle 136 on Reader Service Card

## NAB SHOW IN PRINT



*Compositor I from Fernseh Inc. was one of several systems to offer subtitled capabilities*

for between \$60,000 and \$70,000, has control functions identical to those of the larger ESP C Series. Up to four disk drives can be employed.

A new option for the larger ESP C Series systems is the Multiple Access Controller (MAC), which allows modular expansion of still storage to a maximum of 12 disk drives, accessed by as many as 15 ESP mainframes. Three mainframes may operate simultaneously through MAC, each accessing a different drive group. Time and information sharing is possible with MAC and the expanded system may be programmed to set up a priority control function for one drive group over another. A fully expanded system pro-

vides access to 9000 stills, each accessible in less than half a second.

With systems as large as this, a Library Control System proves useful. ADDA has modified its system to provide for management of up to 200,000 stills, each slide identified by a sorting reference label consisting of title, category, geography, and date code established by the user. The off-line Library Control System can be used to sort, edit, and sequence slides through three user-designed sorting references. At the SMPTE Conference this past fall, ADDA previewed another new option which it showed at NAB, "Multipix." This display option allows the ESP user to preview up to 25 slides displayed in a five-slide by five-slide matrix. Multipix is also available in a smaller version that provides a three-slide by three-slide matrix. The option is priced at \$3500.

MCI/Quantel, which introduced its DLS 6000 Digital Library System last year, showed the system with three new operating levels this year. The systems at all three levels are compact, using just 10½ inches of rack space. They feature Winchester-type hard disk recording and standard SMD disk drive interfaces for the eight disk drives that each level can handle, with each disk drive capable of storing 800 stills. Multiple control panels are available for

each system level, and the modular design allows each system to be expanded to its next superior level.

The three levels are 6010, a basic still store; 6020, which allows on-air transitions between slides; and 6030, which adds a variety of picture manipulation capabilities for editing, composition, and display. Also common to each of the three levels is an off-line videotape archival system that stores still frames in digital form.

The 6010 uses a single framestore while the 6020 and 6030 each employ two framestores. The 6020 has two output channels that permit the execution of on-air effects, plus a preview channel. Cuts, dissolves, and wipes can be performed, and an external key allows recording of captions. The 6030 permits picture repositioning, compression, cropping, variable aspect ratio, and multiple picture montage. A Browse picture mode displays 16 picture grids for review, editing, and sequence selection. An interface with a Chyron graphics system was shown to demonstrate the 6030's ability to work with titlers and graphics systems.

U.S. JVC Corp. showed its VM-1200LU series magnetic videodisc recorder for slow motion and still storage. Shown as a prototype last year, the unit appeared at this year's show as a deliverable production model. The VM-

## All the features to produce good ENG results

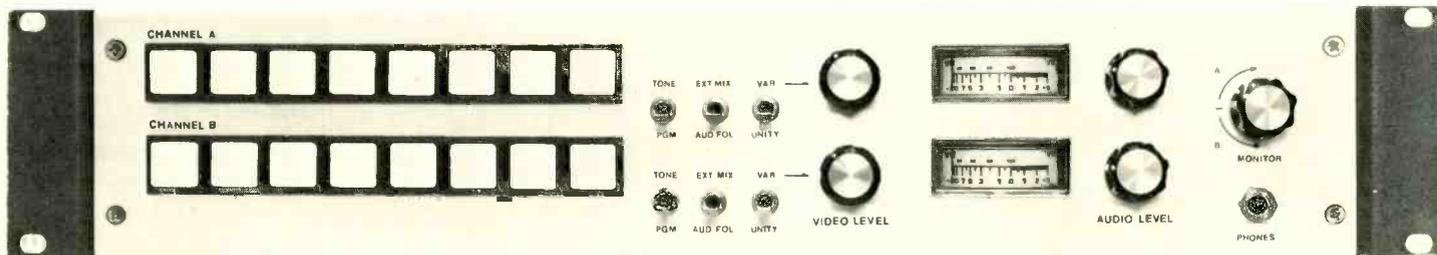

### Video/Audio Switcher VAS-MKII

**Ready to install in your new or existing mobile unit.**

**Designed for your field crews to cover any news story with ease!**

Separate channel for program and preview with audio follow — Auto gain select for Mic or line — Vertical interval or random switching — Audio monitor amplifier — Video and audio DA's, four (4) each per channel — NTSC and PAL version

For further information on this and other associated products including Color Bar Gen/Source Identifier, SMPTE Edit Code Generator/Reader, etc., call us or write to:

## KAITRONICS CORPORATION

Broadcast Products Division

1540 Gilbreth Road, Burlingame, CA 94010

(415) 697-9102

Circle 137 on Reader Service Card

1200LU stores up to 600 frames or 20 seconds of real-time video for variable speed playback from freeze to 30 fps. The single hard disk unit records on both sides, and continuous loop recording and playback is possible. Playback is fully bi-directional at all speeds.

Variable playback speed is controlled through a lever, and a time base display permits checking of the recording or playback process indicating time base in seconds. An A/B zone function permits the recording cycle to be established in two 10-second continuous segments. Playback can also be preset for half-speed or one-fifth speed.

Harris Video Systems presented its Iris system in an eight-drive, 5849 on-line still storage version. Up to three control panels can now access the Iris system for preview and program outputs, as well as for editing. Two new options for the system include quarter-picture compression with joystick positioning for composition and display and a library system featuring a 20-character description for search routines. If the slide is positioned for a key, that position is stored and the slide displayed in that position automatically.

There were no significant changes in the Ampex ESS system this year, which was demonstrated in conjunction with the Ampex AVA art system. The addi-

tion of the ESS to the AVA provided powerful animation and sequencing capability.

Arvin Echo showed production models of its Image Maker videodisc recorder for slow motion and still storage. The Image Maker, an extension of Arvin's EFS Series of analog disc recorders, stores up to 512 frames of high-band color stills. Full random access to the 512 frames is provided with preview independent of the on-line channel. The variable speed playback with frame-by-frame editing provides for good animation functions. Up to 64 still locations can be preset.

Priced at \$39,900 and weighing less than 50 pounds, the disk unit and controller are suitable to mobile as well as in-studio applications. Motion loops can also be programmed from 16 to 512 frames. As in the other EFS series machines, the storage medium is low-cost discassette.

Colorado Video, which for several years now has shown its line of Slow-Scan video transmission systems, reports that a nonbroadcast women's magazine show will make use of its narrowband system for transmitting video images. Essentially, subscribers to the program will receive information on food, health, fashion, and travel, with accompanying still picture information via the narrowband technique.

The system, which includes a video compressor on the input side and an expander on the receiver side, transmits 10 MHz video via telco. Such systems can transmit via any narrowband technique including SCA, microwave, satellite, or other data-grade lines.

Ampex, Sony, RCA, Hitachi, and Fernseh continued to show slow-motion controllers for their one-inch VTR systems. The newest of the slow-motion controller systems was from 3M for its NEC TT-7000-3 VTR. It and others are discussed in the videotape recorder section of this report.

**For more information:** ADDA ESP R, 434; MAC option, 435; Library Control System, 436; Multipix, 437; MCI/Quantel DLS 6000 updates, 438; U.S. JVC VM-1200LU, 439; HVS Iris options, 440; Arvin Echo Image Maker, 441.

### Animation

No one showed the traditional methods of single cell film animation at this year's NAB, but several showed other methods. Animation Video, a new division of Convergence Corp. brought its Anivid system to NAB for the first time. The system uses a traditional animation stand, but a video camera photographs the artwork, which is then fed to a one-inch or 3/4-inch VTR. The Anivid controller al-

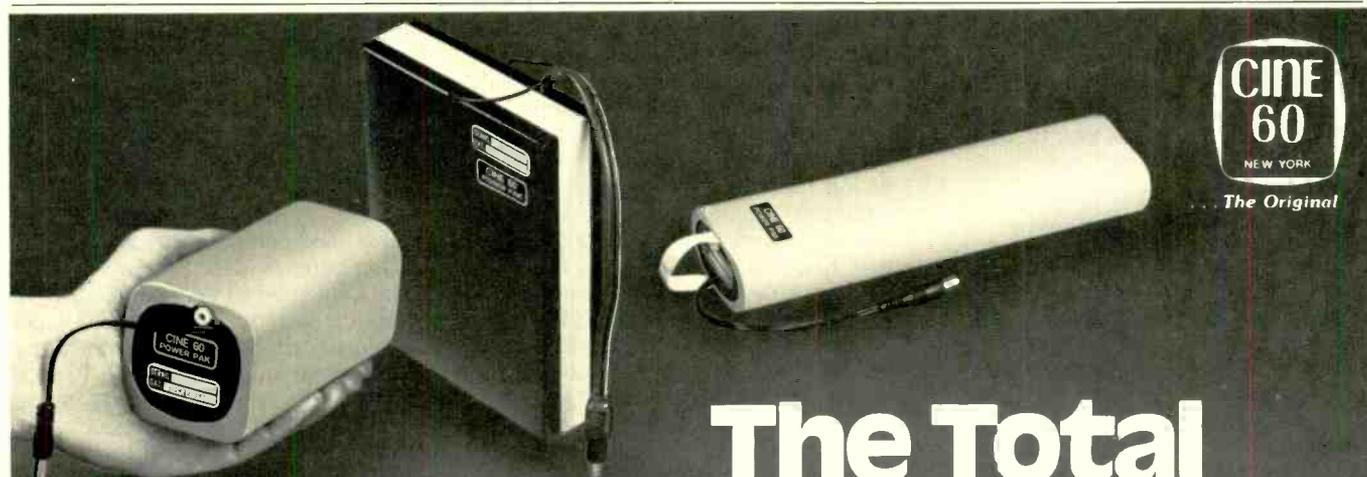

# The Total VTR Battery System

- Power-packed, higher performance Nicad Cells deliver more VTR running time, longer life, never need maintenance, fast charge in one hour.
- Exclusive electronic circuitry and quality construction provides the identical total reliability of Cine 60 Powerbelts... standard of the industry.
- "Total Charge Capability, anywhere..."
- On location, fast charge from any 12 Volt car system — unattended, in one hour, with our 3 lb. Car Fast Charger — no heavy inverter needed.
- From A.C., one hour fast charge with our 3 lb. Universal Model 9400 or BP 2500.
- Fast Charge four batteries — automatically and unattended — with our new, multiple, High Frequency, Regulated Fast Charger, one per hour, four in 4 hours.
- Standard charge 2 batteries overnight, with our two channel, regular Charger
- Directly replaces original VTR batteries — Sony BP-20, BP-20A, BP-50, BP-60, BP-80, BP-90 and JVC/Panasonic PBP-1.
- See your local authorized Cine 60 Dealer. Ask about the Total VTR Battery System you need.

There's Always Something New From Cine 60

## CINE 60

630 Ninth Ave. New York, N.Y. 10036 (212) 586-8782  
 6430 Sunset Blvd. Hollywood, Ca. 90028 (213) 481-3046  
 TWX: 710-581; TELEX: 645-647

Circle 138 on Reader Service Card

## NAB SHOW IN PRINT

lows for precise one-frame exposure. Animation Video says the system has a number of advantages over the old film method. There is no waiting for the lab to process the film, error corrections is instant, and video quality is higher than film transferred to tape.

Lyon Lamb is a company new to NAB but well-known in the world of animators. In 1977 Lyon Lamb introduced the first Video Animation System for animators to test their work without waiting for the film to come back from the lab to see if it was what they planned.

The early versions of the VAS were black and white. Now with the introduction of VAS IV, the company has come up with a broadcast-quality color system. It operates much the same as the Anivid system but claims a more accurate measurement of frame control. The time code is read on the vertical interval.

Frank Woolley & Co. offers a low-cost method that gives the appearance of animation through the Motionmaster<sup>TM</sup> video animation system. The animation stand is a light box that gives the appearance of motion when a properly produced gel is attached to the front. A studio camera shoots the Motionmaster<sup>TM</sup> and either tapes the output or airs it live. The system is priced at under \$3000.

**For more information:** Anivid system, **442**; Lyon Lamb VAS IV, **443**; Woolley Motionmaster<sup>TM</sup>, **444**.

### Teletex and closed captioning

This was the year that teletext — or more generically, videotex — and closed captioning systems came out of the closet at an NAB show. Although many of the systems have been emerging for several years, this is the first time they have arrived at NAB in strength — and showing self-confidence, despite the FCC's nearly comatose position regarding approval.

Antiope, French pioneer and a heavy



Harris's Iris system for still storage uses the HVS 630 frame synchronizer (above) to achieve some of its effects



ADDA Corp.'s Library system for its ESP series still stores offers a variety of customer designated search routines

contender for eventual FCC approval, was on hand through its U.S. marketing arm Antiope Videotex Services of Washington, D.C. Heartened by CBS's enthusiasm over the system in testimony to the FCC, Antiope displayed its videotex system. Company officials clearly feel the French system leads a growing pack of competitors. Corporate buoyancy among CBS and Antiope officials was weighted down, however, when a heavily touted press demonstration was to have taken place in a Caesar's Palace suite. Transmission difficulties on a satellite feed from Washington, D.C. to Las Vegas blitized the interactive demonstration.

But CBS remained enthusiastic about Extravision, a teletext news, information, and captioning service it is testing over its O&O station in Los Angeles, KNXT. (See report in *BM/E's* January, 1981 issue.) The test is expected to last through this year and will involve about 100 receivers in the Los Angeles area. Equipment and system software has been provided by Telediffusion de France, the agency behind Antiope.

Pooling their activities, a host of United Kingdom systems designers and suppliers rallied around the British Videotex & Teletext stand. BVT, supported by the U.K.'s Department of Industry, is a marketing venture formed by British Telecom and Logica. Included were Prestel, the videotex system developed by the General Post Office; Ceefax, the BBC's videotex offering; Oracle, from the Independent Television Network; and Jasmin Electronics Ltd.'s teletext, designed for commercial and industrial customers but completely compatible with Prestel.

Also represented in the BVT stand was VG Electronics, which manufactures teletext editing terminals, digitizers, keypads, and hardcopy printers as well as page generators, data bridges, decoders, regenerators, and vertical interval inserters.

BVT's co-founder, Logica, was showing its Context fielding/library system, based on BBC's Ceefax (which Logica helped develop in the first place), while Philips subsidiary Mul-

lard (and its California-based affiliate, Signetics) was discussing its range of dedicated LSI circuits designed specifically for videotex and teletext systems.

Emerging from the British effort is a second-generation system that BVT officials feel is a beat ahead of Antiope. Two matched decoders — one standard, the other capable of reacting to signals below the vertical interval's twenty-fourth line — can pull out slightly different messages on the same terminal.

Meanwhile, Prestel International said that by this autumn, its first U.S. videotex computer will be on line and in full service in the Boston area.

This was the first year that Telidon, the Canadian videotex system, took its own booth at NAB. The Canadian system, which went on line commercially last month (May) in Manitoba, expects to install 25 terminals in agricultural representatives' offices within a few weeks. Although terminal rental will be \$50 a month per unit, data retrieval is free on the service, which is being called "Grassroots." By the autumn, Telidon expects 50 terminals to be in place, and by the first quarter of next year, about 1000 terminals are expected to be installed.

Another Canadian company, Skotel, has developed an intelligent interface for its timecode readers and generators. The interface, which is aimed at closed captioning, encodes information into the 32 binary user data bits of the time and control code. The advantage is that real language text can be encoded into the time code; the two-data encoding formats can interface — through a standard RS-232C — with computers, character generators, terminals, keyboards, and editing systems.

Computer Video Systems of Salt Lake City showed its Compuvid CDD series of data display systems, which are aimed primarily at cable operators. The Compuvid, available with 16 or 27 page memory, performs a range of teletext services, from news to stock market reports to weather information.

EEG Enterprises, from Farmingdale, N.Y., was on hand again this year with its closed captioning system for the hearing-impaired. A user-bit inserter loads eight-bit characters redundantly into the time code, which is then encoded on television line 21. Sears and Roebuck builds a color television with a Sanyo decoder for \$550; a set-top decoder is available from Sanyo for \$250.

**For more information:** British Videotex and Teletext Prestel, **445**; Ceefax, **446**; Jasmin Electronics teletext, **447**; VG Electronics, **448**; Mullard LSIs, **449**; Logica Context system, **450**; Telidon, **451**; Skotel interface, **452**; Computer Video Systems Compuvid CDD, **453**.

# THE BROADCAST QUALITY COMPACT STUDIO

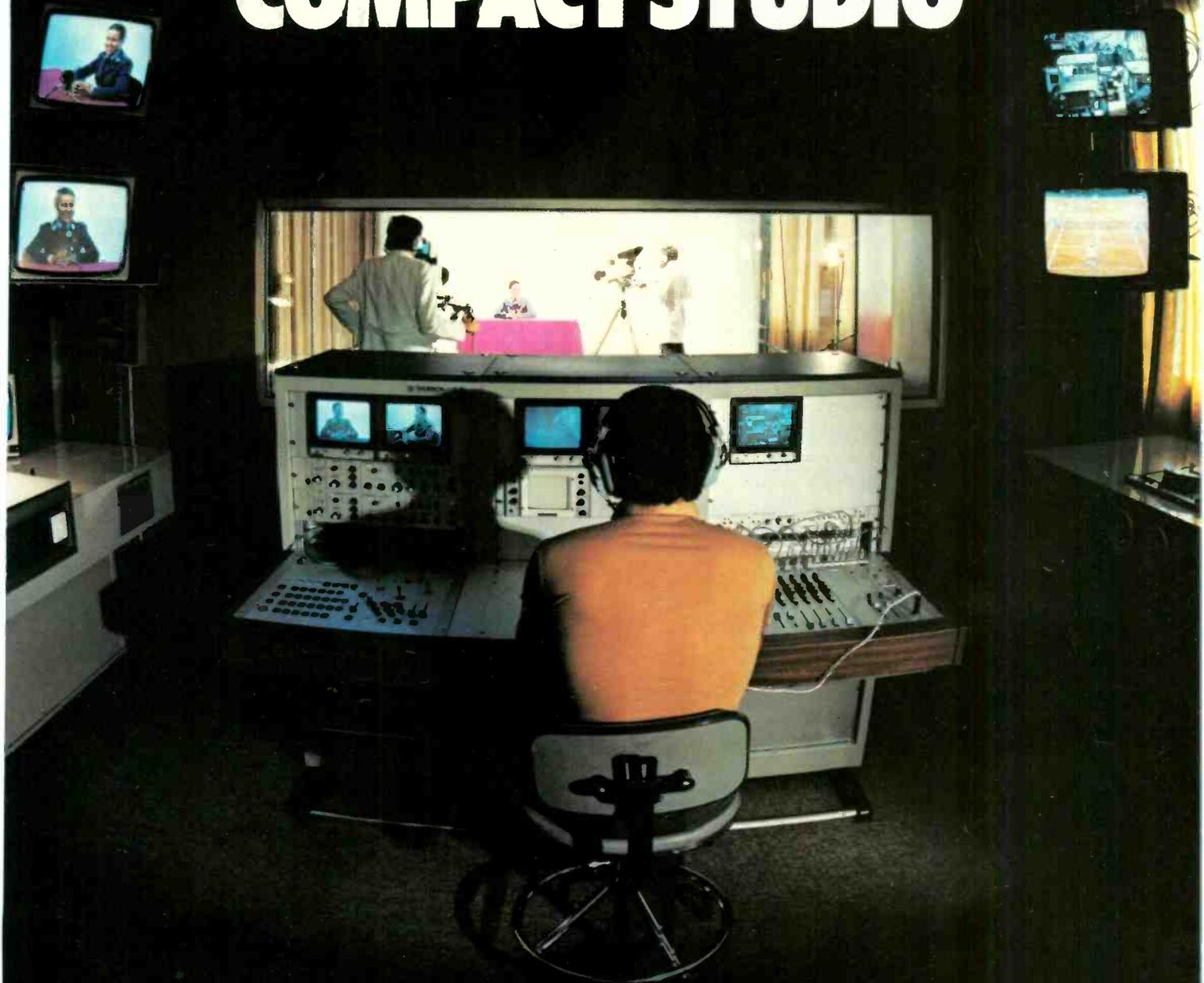

Exciting new technical developments at THOMSON-CSF enable them to bring you exceptional professional equipment. This compact modular studio provides all the facilities required for TV program production.

Broadcast quality cameras and a top of the line switcher mixer offer a

wide range of special effects in SECAM, and even on-air transmission.

A large range of possibilities available to the director, coupled with the ease of operation for the technical staff - the compact studio gives you all this and highest quality professional productions for all facets of public and private industry.



## THOMSON-CSF

DIVISION RADIODIFFUSION-TELEVISION  
94 rue du Fossé Blanc  
92231 Gennevilliers - France. Tél. : (1) 790.65.49  
THOMSON-CSF EQUIPMENT AND SYSTEMS LTD  
Hunting House, Central Way  
North Feltham Trading Estate - Feltham, Middx  
Great Britain. Tel. : (01) 751.62.41  
THOMSON-CSF BROADCAST, Inc.  
37 Brownhouse Road - Stamford  
Connecticut 06902 - USA. Tel. : (203) 327-7700

**THOMSON-CSF's compact studio : the key to professional productions.**

# The only choice...



506 TBC: Low cost TBC with superior CCD performance.



515 TBC: Digital PAL-M TBC for heterodyne VTRs.



\*516WB TBC: Wideband, digital TBC for broadcast quality with heterodyne VTRs.



630 Frame Synchronizer: Component-coded framestore with TBC. Compressor/Positioner and Digital Noise Reducer optional.



EPIC: Computer-aided "super editor" for all of your video editing requirements.

If you thought that Harris Video Systems only made TBCs...surprise!

Although we've been most famous for TBCs (we originated the commercial digital TBC and won an EMMY for it), we've now gone far beyond that. Today, we're bringing advanced digital technology to the entire spectrum of video production and broadcasting.

Worldwide customers include all major networks, a large number of commercial and educational stations, numerous CATV operations, and a rapidly growing list of industrial and scientific installations.

Further, since we're part of the Broadcast Products Division of Harris Corporation, you can be sure of superb sales and service support almost anywhere.

\* Lower cost version, the 516, also available.



# in digital video!



507 TBC: Low cost PAL TBC with superior CCD performance.

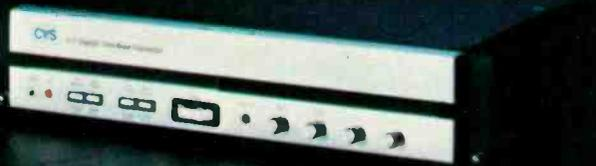

517 TBC: Component-coded, PAL/SECAM TBC for heterodyne VTRs.



590 TBC: Broadcast quality, digital TBC/Signal Processor for heterodyne and direct VTRs.



631 Frame Synchronizer: Component-coded PAL framestore with TBC. Compressor/Positioner and Digital Noise Reducer optional.



IRIS: Digital still store system for storage and manipulation of video images from virtually any source.

**HARRIS**



COMMUNICATION AND  
INFORMATION PROCESSING

HARRIS CORPORATION Harris Video Systems  
1255 East Arques Avenue, Sunnyvale, CA 94086 (408) 737-2100  
Telex 35-2028

Circle 140 on Reader Service Card



## INNER VIEW 3: A closer look at Conrac Monitors

### Comb Filter Separator: Resolution Solution at 3.58 MHz.

Conrac's Comb Filter Separator delivers the high resolution needed for today's high performance camera and taping equipment. It removes color information from the composite video signal without the luminance loss in the 3.58 MHz region produced by notch filters.

Conrac's Comb Filter takes advantage of spectrum interweaving to separate luminance from chroma, without reducing luminance bandwidth.

But the best part of Conrac's Comb Filter is that it gives you this improved picture clarity without the drawback of conventional comb filters. Because, unlike conventional comb filters which exhibit heavy dot patterns in the luminance path, Conrac utilizes non-linear techniques to virtually eliminate these patterns around vertical and horizontal transitions.

### Conrac Quality: Computer-controlled for the 80's.

The implementation of a failure analysis documentation system has become an essential new tool in

the quality factor. This system provides the capability of daily test analysis from four different product test and inspection areas. The net results are improvements in product quality and long term reliability.

### Conrac Technology: Over 30 years of leadership.

Conrac's track record of technical innovations stretches back nearly three decades; and what we've learned since then goes into every monitor we make today. That is important to you because the more technology we pack into each monitor, the more performance you will receive from it.

Comb filter separator and computer-controlled quality are just two ways Conrac technology can save you time and money.

For the complete inner view of Conrac technology, call or write us today. Conrac Division, Conrac Corporation, 600 North Rimsdale Avenue, Covina, California 91722, Telephone (213) 966-3511, Telex: 67-0437.

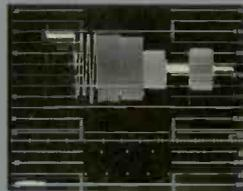

1. Multiburst test signal with conventional bandpass and notch luminance/chrominance separator.

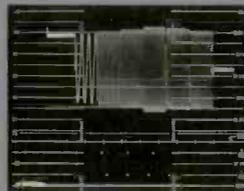

2. Multiburst test signal with Conrac's Comb Filter luminance/chrominance separator.

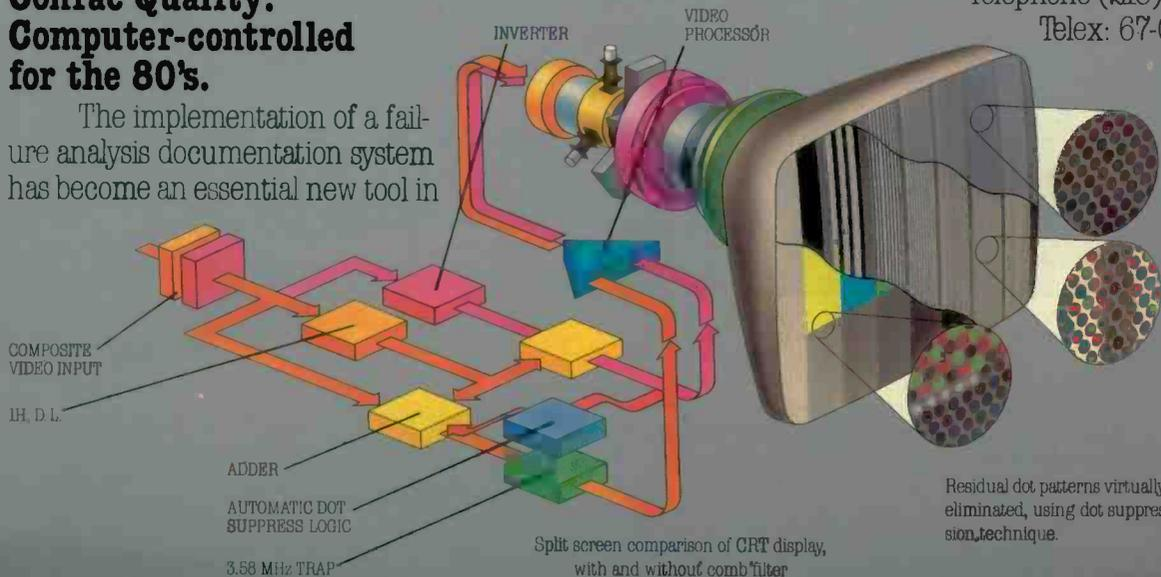

1. Luminance resolution using the conventional notch/filter separator.

2. Luminance resolution using the comb filter separator.

Residual dot patterns virtually eliminated, using dot suppression technique.

**Quality you can take for granted.**

# NAB SHOW IN PRINT RADIO EQUIPMENT HEADS FOR THE LEAD



**With competition for the radio listener's and television viewer's ear, manufacturers of radio and audio equipment respond to the pressures felt by broadcasters.**

## Audio consoles and mixers

The advance in audio at this year's NAB was conceptual. There seemed to be almost universal agreement among the console makers that quality sound was to be very important to television. In preparation for that conceptual change, a number of manufacturers introduced new products aimed mainly at TV broadcasters.

A spokesman for Harrison, which up to now has specialized in large consoles for film and recording, made it plain where the marketing strategy lies. "We're showing our large post-production consoles now," he explained, "but next year you are going to see an entirely new line of products geared to quality sound for broadcasters."

Predating that philosophy were the products from ADM, including seven new consoles redesigned with the needs of television broadcasters in mind. The 800 Series (now the 800 Series II) was radically redesigned so that it could be reduced in size, resulting in a line of consoles for OB vans and mid-range television studio post-production.

There were a number of consoles that had digital components. Harris's Micro Mac<sup>™</sup> modular audio console attracted a lot of attention because of its digital manipulation of the board's controls. Harris says that because the system is software-based, a number of functions can be incorporated that under normal conditions would call for a much larger console and additional control modules.

The system specs allow for a maximum of 16 channels in and three out, plus mono/sum, three assignable submasters, and machine control of up to 32 sources. There is a built-in keyboard that allows the user to program



Panasonic's Professional Audio Division brought three new Ramsa consoles. The WR-8816, above, has 16 inputs and four outputs



Broadcast Audio exhibited the System 20 stereo consoles, available with up to 60 inputs

many of the system's functions, for example: source machine assignment, momentary or latching source start/stop commands, speaker muting in up to six different areas, setting the up/down timer and the 12/24 hour clock, cart machine replay lockout, and stop-delay on reel-to-reel machines.

Broadcast Audio showed its System 20 stereo broadcast console. Depending on the kind of mixers chosen, this system can handle up to 60 inputs, three mixing and seven frequency graphic equalizers, stereo/mono switch, and three stereo outs with a mono/sum.

Cetec Broadcast Group introduced its new audio console, the 8000, which comes standard in an eight-channel, 24-input model but is expandable to 16 channels and 48 inputs. Few options are offered with the Cetec 8000 because Cetec says that its standard configuration is available as options on other consoles. The standard features are Penny and Giles attenuators, liquid crystal display clock/timer, built-in intercom, 4 W cue amplifier, and read/play cart machine indicator.

Farrtronics Ltd. of Markham, Ont., was another console maker looking toward the audio needs of television. The M70 Series has all the normal options of a modular system but also has an interface for post-production editors such as those from CMX, Datatron, and Convergence.

Fitzco Sound showed three new Audioarts Engineering consoles. The 44 Series mixing console is a modestly priced unit that comes in 16-, 24- or 32-input models. The 8000 Series is the



*The new Cetec 8000 stereo console, in version with 16 channels above, comes complete with eight channels or more. Additional channel modules, or an integral equalizer, can be added*

midrange console and features 6, 24, or 32 inputs and eight out configurations. The Wheatstone Project, the top of the line console, is modular in design and can be put together in whatever configuration is necessary.

Howe Audio displayed the prototype of its new 8000 Series stereo mixing console. It has 22 inputs and four outs (two stereo, one stereo program and one mono). The TTL logic in the electronics package adjusts the signal so that the faders and program/audition keys do not directly affect the signal. Howe says that the logic in the system virtually eliminates on-air mistakes. The 8000 series will be available in the fall and should sell for under \$9000.

Quad Eight brought a new modular console called the 248 Component Series. The basic system comes in an eight-input by four-output console that can be expanded to 24 inputs and eight output buses. The cost, depending on options, ranges from \$8000 to \$24,000.

Sphere Electronics made its first appearance at NAB as an exhibitor, but the appearance was timed to attract a lot of attention. Sphere debuted its 1604 satellite mixer in the Best Audio truck. The first test of the Satellite 1604 came in the telecasting of the Academy Awards and the Diana Ross special (Best Audio provided the audio services for both broadcasts). The Satellite 1604 is a 16-in, four-out console priced in the \$6000 range.

McCurdy continued the move toward smaller broadcast consoles with its introduction of the SS9800 Series of consoles in 16- or 24-channel versions. Machine control interfaces are available for either board control or control from a remote location. The unit comes in stereo or mono versions and costs \$16,000 to \$30,000 depending on the options.

MCI introduced its JH-618 Series consoles in eight-, 16-, and 18-input versions. Options allow for a non-



*McCurdy showed a complete operating studio built around a McCurdy console, with turntables, cart machines, monitor system*

# OUR SWITCHER SPECS SPEAK FOR THEMSELVES

Following is a summary of test data compiled from the final test measurements made on a 50-input by 50-output audio/video switching matrix sold to Capital Cities' Houston outlet KTRK-TV. We invite comparison of these test results with our published specs and with the published specs of routing switchers manufactured by others.

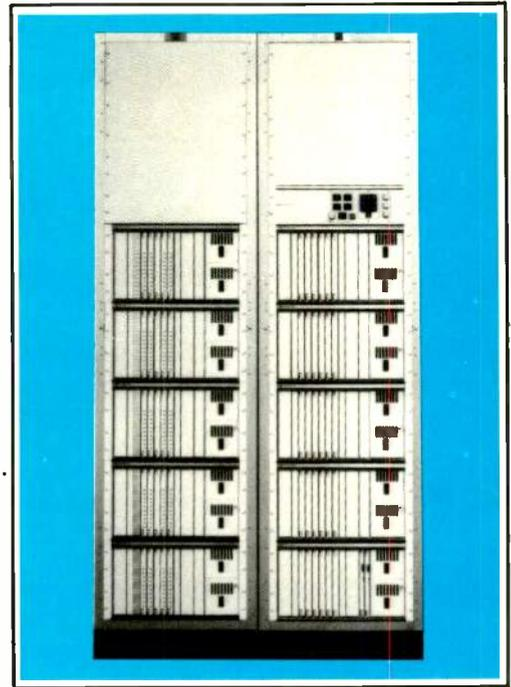

50 x 50 KTRK MATRIX

## KTRK TEST DATA BREAKDOWN

	Worst	Mean	95th Percentile	Published Spec
<b>VIDEO</b>				
Crosstalk @ 3.58 MHz .....	-63	71.1	65	-60 dB
Diff Gain .....	.05	.042	.05	0.1%
Diff Phase .....	0.1	.056	.08	0.12°
Diff Delay .....	1.0	.89	.95	± 1°
Freq Response .....	.05	.02	.05	±.12 dB
Hum & Noise .....	-79	-84.6	-80	-75 dB
Gain Uniformity, All Paths .....	.017	.006	.017	±.07 dB
Input Return Loss .....	46	51.2	46	40 dB
Output Return Loss .....	45	48.8	46	40 dB
<b>AUDIO</b>				
Crosstalk @ 20 KHz .....	-80	-84.7	-81	-75 dB
Hum & Noise .....	-88	-91.8	-90	-85 dBm
THD 30 Hz - 20 KHz				
@ 0 dBm .....	.017	.011	.015	0.1%
@ +24 dBm .....	.24	.13	.17	0.5%
Gain Uniformity, All Paths .....	0.1	.044	.09	0.2 dB
Common Mode Rejection .....	80	88.3	83	70 dB

Our routing switcher specs are the best in the industry—we test each matrix for conformity and we beat our own specs by comfortable margins.

**TRY THAT ON YOUR GRASCOMFERNSAM DYNATEK SWITCHER!**

**US UTAH SCIENTIFIC, INC.**  
THE ROUTING SWITCHER PEOPLE.

2276 SOUTH 2700 WEST, SALT LAKE CITY, UTAH 84119  
PHONE (801) 973-6840  
TWX: 910-925-4037

TOLL-FREE  
IN U.S.A.  
(800) 453-8782

Circle 142 on Reader Service Card

# The New **it** Benchmark Improved In Four Important Ways!

## No. 1 Cart Machine

Today, one out of every two broadcast cartridge machines purchased worldwide is an ITC Premium Line machine.

Now, four new features make this first-choice line an even greater value.

## Improved Frequency Response

The head is new. The open-faced design is cylindrically shaped rather than hyperbolic. MuMetal laminations are surrounded by epoxy filler impregnated with aluminum oxide particles for shielding and durability. Core windows are wider than conventional designs. The end result is greatly improved frequency response without low end humps and bumps.



New Cart Hold Down

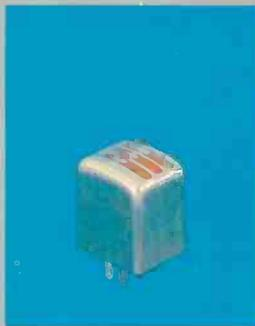

New Head Design



New Pressure Roller



New Removable Head Module

## Removable Head Module

True center pivot design. Azimuth, zenith and height adjust independently. Locking one does not affect the others. Steel ball pivots and longer azimuth arms permit finer tuning.

## Improved Tape-Head Alignment

New cartridge positioning system assures precise, rigid alignment of tape to head even when insertion is hurried or careless.

## Long-Life Pressure Roller

The 525K pressure roller offers twice the pulling power and extended life. Tolerates common cleaning chemicals. Holds its durometer even in high humidity.

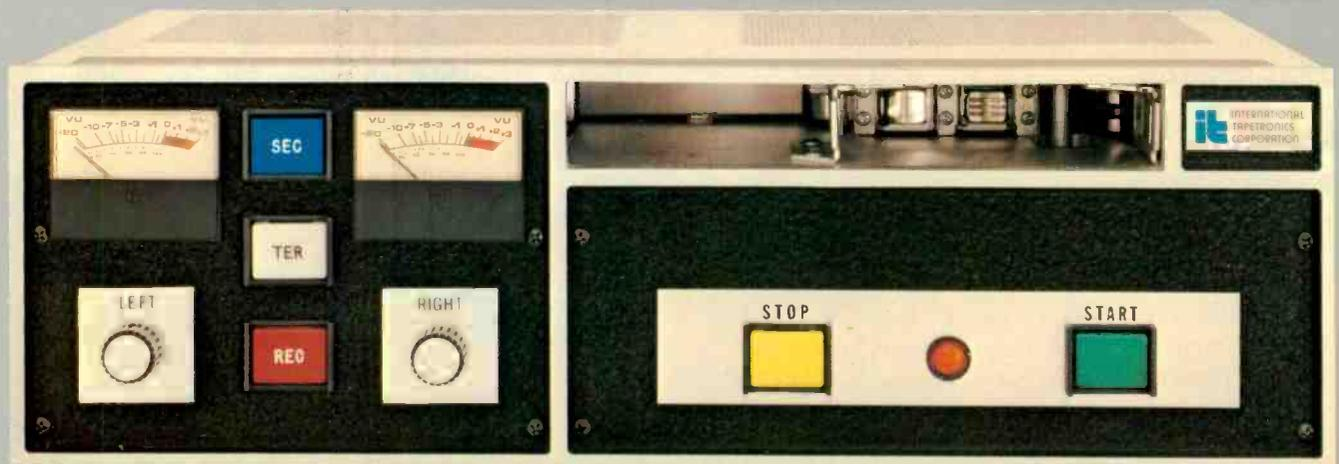

To place a no-risk order  
**CALL TOLL-FREE**  
**800-447-0414**  
 From Alaska, Hawaii, Illinois  
 call collect; (309) 828-1381



International Tapetronics Corporation,  
 2425 South Main Street,  
 Bloomington, Illinois 61701

Marketed exclusively in Canada by McCurdy Radio Industries, Ltd., Toronto

## NAB SHOW IN PRINT

automated recording/remixing console with mix only metering up to a completely automated console. Prices range from \$15,000 to \$35,000.

Rupert Neve showed some improvements in its current lines of consoles. The new software in the NECAM II computer-assisted mixing and editing system for TV audio was impressive. Neve is another manufacturer that feels that the future is in quality television sound and seems to be paying particular attention to that market.

Pacific Recording & Engineering offered no new consoles this year but stressed the range and quality of its BMX consoles and also the kinds of interfaces available for machine control.

Panasonic's Professional Audio Division introduced three new Ramsa® consoles. The WR-8210 recording console has 10 inputs and four outs and is for four- and eight-track recording. The WR-8716 is a sound reinforcement mixing console with 16 inputs and four group and stereo master outputs. The Ramsa® WR-8816 recording and mixing console handles 16 inputs and four stereo master outputs and is, according to Panasonic, ideal for four- and 16-track recording. Production is scheduled for early June.

Ward-Beck Systems showed a custom radio studio setup that had been designed for several stations around the country. It features WBS Standard R 1200 radio console with M 490 modules. Nearly 30 of the systems have been sold.

Arrakis Systems, making its second appearance at NAB, came in with four new consoles. The 2000 Series is a modular board with eight or 16 channels, 32 inputs with three stereo outputs and one mono. It sells for \$5200. The 500R Series is an update of the 500 Series and comes in eight- or 12-channel models, either with mono or stereo with 32 inputs. It runs \$3750. The \$2500 500SC is similar to the 500R except that the eight-channel model has 16 inputs and the 12-channel model has 24. The final new console introduced by Arrakis was the 250SC, a five-channel version with 10 inputs in either mono or stereo that goes for \$1500.

Auditronics featured its 200 Series on/air mixer, designed with both engineers and air personalities in mind. Because all the electronics swing up for ease of maintenance, the console can be dropped into a cutout on the desktop. It is modular in design and allows for a number of options and expansion. One interesting module is the Personality Equalizer, which allows all DJs to have customized EQs adjusted specifically for their individual voices. When a DJ



ADM showed the new ST 160-2, designed for television audio as well as general broadcast use. Series is available with 16 channels, as shown above, or with other configurations



The Micro Mac console shown by Harris attracted attention with its digital manipulation of the board controls. Many functions can be added, changed, simply by changing the software

comes on shift, a card is popped in the board and — instant EQ. The 200 Series comes in six-, 12-, and 18-input models. With all the bells and whistles the system costs about \$10,500.

Micro-Trak had two new consoles to show. Model 6509 is a five-channel stereo broadcast mixer that can handle nine inputs with the option of input pre-amplifier of user's choice. Type of fader (rotary or linear) is also up to the user. The 6509 sells for \$1595. The second mixer is a four-channel version of the Sport III, appropriately called the Sport IV.

Logitek offered a couple of new features on its Custom Audio Series con-

soles: a built-in six-output stereo distribution amplifier and a preselector module that allows the feeding of eight additional stereo inputs into either of two input modules.

LPB Inc. featured its complete line of Citation Series consoles, shown in prototype at last year's show but now in production. The series comes in groups of six-, eight-, and 10-mixer dual stereo consoles.

Studer/Revox showed prototypes of two versions of the new 900 series mixing console, aimed at the television market. The 901 is a smaller console that would be useful in mobile vans and smaller studio situations, with 12 inputs



The 3M Company had the multi-track digital audio system in a demonstration that gathered in many listeners during the show

and four master outputs. The 902 is larger, but still compact enough for larger remote units and production studios that need a versatile system without going to the very large consoles. The standard model will have 26 inputs and 4 master outputs, expandable to 50 inputs and 24 outputs.

Teac introduced a couple of new products this year. The TASCAM M-35 mixing console, with eight inputs, four bus outputs, and a separate eight-track monitor mixer, sells for \$2300. The other new addition to the TASCAM line is the switchless System 20 modular mixing system. It operates like an electronic patch bay, with access to all signals at all points along the signal path. The system was at first designed for the operator who worked alone, but the company felt that its flexibility made it useful for many multi-channel uses. The system comes in four modules: the MM-20 with six inputs and six outputs and provisions for four-track monitoring; the PE-20 with four channels of parametric type EQ; the EX-20, which provides four additional transformer isolated inputs; and a meter unit, MU-20. The entire package is priced at about \$1245.

JBL has moved into the mixer market with a new automatic mic mixer. The Model 7510 can handle up to 24 input channels. The system is modular and comes in groups of four mixer packages. It offers the flexibility of automatic gain, normal mixer control and priority. The priority mode allows for one mic to be the primary source of the audio and override the other inputs

when necessary.

Shure Brothers issued a tease at the NAB about a new compact audio mixer. It listed a number of functions including an automatic muting circuit, fast attack limiter, simplex power, built-in battery pack, LED peak indicator, headphone level control and headphone amp/line switch. It also is said to be able to fit into the space currently occupied by the Shure M67. The first of the production models will be available in August. The new mixer is the M267 and is priced under \$400.

Sony also came out with a new portable mixer. The MX-P42 handles four inputs to two stereo outputs. Automatic Level Control combines with onboard compression/expansion for increased dynamic range. The MX-P42 operates on three C cell batteries and weighs 7.7 pounds.

Sphere also introduced a small console for radio that replaced the faders with an electronic light strip. A company spokesman says the system allows for silent operation by the disk jockey. The board is more expensive than most DJ consoles, but Sphere thinks that the quality and uniqueness demand the higher price.

Comprehensive Video Supply Corp. featured the CVMM-15 portable microphone mixer, a lightweight (under two pounds) unit that handles three mic inputs with individual level control. One of the inputs has 9 V phantom power supply for use with shotgun microphones. The mixer comes with a metal belt loop. Foundation Instruments of Canada is manufacturing the

CVMM-15 for Comprehensive Video.

ProTech Audio displayed the Satt Electronics portable mixers, SAM 82 and SAM 42, which it is importing from Sweden. Both are geared for remote operations. SAM 82, which is the larger of the two consoles, costs about \$6000.

**For more information:** ADM 800 Series II, **803**; Harris Micro Mac™, **804**; Broadcast Audio System 20, **805**; Cetec 8000, **806**; Farrtronics M70, **807**; Fitzco Sound (Audioarts Engineering) 44 Series, **808**; 8000 Series, **809**; Wheatstone Project, **810**; Howe Audio 8000 Series, **811**; Quad Eight 248, **812**; Sphere Electronics Satellite 1604, **813**; McCurdy SS9800, **814**; MCI JH-618, **815**; Panasonic Ramsa® WR-8210, **816**; Ramsa® WR-8816, **817**; Ward Beck, **818**; Arrakis Systems 2000 Series, **819**; 500R Series, **820**; 500SC, **821**; 250SC, **822**; Auditronics 200 Series, **823**; Micro-Trak, Model 6509, **824**; Sport IV, **825**; LPB Citation Series, **826**; Studer/Revovox 901, **827**; 902, **828**; Teac TASCAM M-35, **829**; TASCAM System 20, **830**; JBL 7510, **831**; Shure M267, **832**; Sony MX-P42, **833**; Comprehensive Video CVMM-15, **834**; ProTech Audio (Satt) SAM 82, **835**; SAM 42, **836**.

#### Audio tape recorders and loggers

One of the few digital products introduced this year came from Panasonic's Professional Audio division. The Technics SV-P100 is a digital audio cassette recorder containing a PCM processor and a tape recorder as a single unit. The prototype of the SV-P100 was shown at the show and production is expected this fall. The cost of the machine will be under \$5000.

Accurate Sound introduced the Model AS-100 high-speed duplicator. The transport on the AS-100 is completely dc servo-controlled, handles 10 slaves, and guarantees speed accuracy by crystal control.

MCI introduced two new recorders, one quarter-inch model and one eight-track. The JH-110BX comes in mono and stereo versions with two-speed



Sony brought the MX-P42, a portable mixer with four inputs, two stereo outputs. It has automatic level control, runs on three C cells





Production Studio, WRBR-FM, South Bend, Indiana.

## Electro-Voice's Greg Silsby talks about the Sentry 100 studio monitor

When I first described to Electro-Voice engineers what I knew the Sentry 100 had to be, I felt like a "kid in a candy store." I told them that size was critical. Because broadcast environment working space is often limited, the Sentry 100 had to fit in a standard 19" rack, and it had to fit from the front, not the back. But the mounting hardware had to be optional so that broadcasters who didn't want it wouldn't have to pay for it.

The Sentry 100 also had to be both efficient and accurate. It had to be able to be driven to sound pressure levels a rock 'n roll D.J. could be happy with by the low output available from a console's internal monitor amplifier.

The Sentry 100 also had to have a tweeter that wouldn't go up in smoke the first time someone accidentally shifted

into fast forward with the tape heads engaged and the monitor amp on. This meant high-frequency power handling capability on the order of five times that of conventional high-frequency drivers.

Plus it had to have a 3-dB down point of 45 Hz, and response that extended to 18,000 Hz with no more than a 3-dB variation.

Since it's just not practical for the engineer to always be directly on-axis of the tweeter, the Sentry 100 must have a uniform polar response. The engineer has to be able to hear exactly the same sound 30° off-axis as he does directly in front of the system.

I wanted the Sentry 100 equipped with a high-frequency control that offered boost as well as cut, and it had to be mounted on the front of the loudspeaker where it not only could be seen but was accessible with the grille on or off.

I also didn't feel broadcasters should have to pay for form at the expense of function. The Sentry 100 had to be attractive, but another furniture-styled cabinet with a fancy polyester or die-cut foam grille wasn't the answer to the broadcast industry's real needs.

And for a close I told E-V's engineers that a studio had to be able to purchase the Sentry 100 for essentially the same money as the current best-selling monitor system.

I'm happy to report that we've achieved all our objectives.

Market Development Manager,  
Professional Markets

**EV** Electro-Voice<sup>®</sup>  
a gulton company

600 Cecil Street, Buchanan, Michigan 49107

In Canada:  
Electro-Voice, Div. of Gulton Industries (Canada) Ltd.,  
345 Herbert St., Gananoque, Ontario K7G 2V1.



# WE'VE EXPANDED



Due to your continued support and belief in CSI quality transmitters and service, we have moved to newer and larger facilities. We are looking forward to supplying you with the same high quality workmanship and service you have come to expect from CSI.

**CSI** ELECTRONICS INC.

18248 E. Rogers Cr. • Boca Raton, FL 33431 • Phone 305-994-6511

This equipment is distributed in Latin America by Electrex Company, 18680 N.E. 2nd Ave., Miami, FL 33179. Contact Ben Ostrovsky, 305-651-5752

## NAB SHOW IN PRINT

servo-controlled tape transport and separate equalizer and bias settings for each speed. It is available in either NAB or IEC equalization standards.

The JH-110C-8 features full remote control of repro-input-sync functions for each channel as well as remote transport functions. It comes with separate EQ and bias settings for each of its three speeds and offers NAB/IEC equalization switching with no realignment required.

Telex Magnecord introduced its new 3000 Series tape recorder/reproducer, which handles 10½-inch reels and has automatic cycling, automatic cue release (AQR), and CMOS logic tape motion controls.

TEAC showed two new Tascam Series recorder/reproducers. The 22-4 is a four-track model with function and output select, pitch control, and optional dbx interface and remote pause controls.

The 22-2 is a half-track machine with three-motor, three-head transports with independent monitor and record ready controls. It sells for \$750; the 22-4 goes for \$1425.

Otari introduced the MTR 10 Series two- and four-channel production/mastering recorders using quarter-inch tape, with the four-channel model convertible to half-inch. Both have dc PLL servo-tape transports with microprocessor-based control systems.

The 5050BQ Series II is a quarter-inch four-channel recorder. Otari has installed a proprietary microprocessor to govern the transport control. Though more compact, the 5050BQ has all the features of its predecessor, the MX5050-QXD.

NEAL Ferrograph brought out two new cassette recorders, the 312 and the NEAL 302. The 312 is a stereo model which comes in three- or four-channel configuration, has Dolby HX, and can handle metal tape. It is geared to reproducing music with the full sound.



The Otari 24-channel audio recorder got a detailed demonstration with the aid of monitoring equipment



At ITC booth the Series 99 cart player/recorder went through its paces for spectrum, distortion tests

The NEAL 302 stereo cassette recorder has a built-in calibration function that allows the machine to be set up for any make of tape. A calibration oscillator is built-in to provide a 500 Hz signal for calibration and Dolby B noise reduction.

International Tapetronics introduced its new reel-to-reel recorder, the 770 Series, which is servo-controlled, capable of remote operation, rack mountable, and available in mono and stereo versions.

Dictaphone displayed its new Veritrac™ logger, an enormously flexible microprocessor-based system. The Veritrac™ is available in configurations from four to 40 channels and provides over 50 hours of recording. It features a time/date option that has an auto search capability and a Safe Scan that (in the dual transport model) will detect recording failure on any channel and

automatically transfer the recording to the backup transport.

Ampro-Scully's new logger, the 1500-L series, can record for up to 25.6 hours using a 3600-foot reel. It has four-channel transport with servo motor capstan. There were some upgrades in most of Ampro-Scully's recorder line.

NEAL Ferrograph also introduced a slow-speed logger, the SP74R, a four-channel machine with built-in time code reader that can record for about 25 hours.

**For more information:** Technics SV-P100, 840; Accurate Sound AS-100, 841; MCI JH-110BX, 842; JH-110C, 843; Telex Magnecord 3000 Series, 844; TEAC 22-4, 845; 22-2, 846; Otari MTR-10, 847; 5050BQ Series II, 848; NEAL Ferrograph 312, 849; NEAL 302, 850; International Tapetronics 770 Series, 851; Dictaphone Veritrac™, 852; Ampro-Scully 1500-L, 853; NEAL Ferrograph SP74R, 854.

### Cart machines: on a plateau

All the established makers of cart record and play machines were on hand with their units. UMC introduced a record/play model in its 100 series for A-size carts. It has overload indicators, automatic end-of-message response to the standard cue tones, automatic cue, and both low and high-end equalization. UMC also brought its first triple-deck unit. Model 300 also has cue response, an extra-heavy half-inch capstan, and wow and flutter rated at 0.06 percent. The system allows easy recording on deck 3 from either deck 1 or deck 2.

No radically new cart machines appeared at the show, but the two systems that have lately created a new high performance level, in a higher price bracket, the ITC Series 99 and the Pacific Recorders Tomcat, were both getting plenty of attention.

In addition to the display of the Series 99, ITC announced four improvements to its "Premium" line, one of the most widely used in broadcasting. The head has been reshaped to lift and smooth the low frequency response. A new cart hold-down system is aimed for more precise positioning of the cart against the head. A new head adjustment system has true center-pivot design. And the pressure roller has doubled pulling power.

D-B Electronics, new last year when it introduced a two-deck cart machine, expanded the line this year with a three-deck machine that has attractive features. A servo-controlled Hall effect motor aids speed stability.

**For more information:** UMC Series 100 record/play model, 460; Model 300, 461; ITC Series 99, 462.

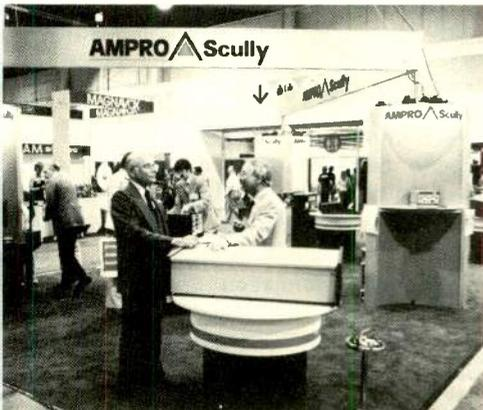

Consoles, cart players, reel-to-reel tape machines exhibited by Ampro-Scully

# D.C. Servo Drive Runs Smooth Steady Cool

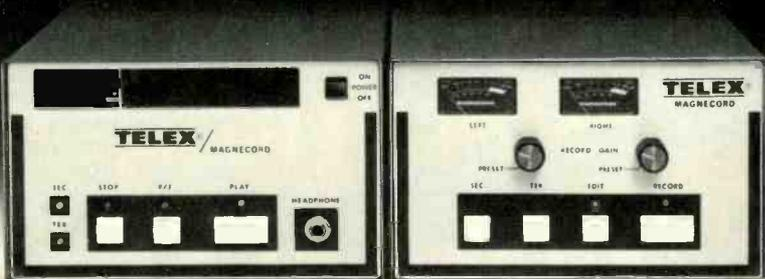

## Of course, it's Telex/Magnecord

Telex Magnecord broadcast cart machines run cool and steady. So cool no ventilation is required, so steady not even voltage or frequency fluctuations will alter their speed. Thanks to our dc servo flutter-filter drive. Completely immune to RFI and EMI, it meets or exceeds all NAB standards and is suited for local or remote/automated operation.

### Standard features at no extra cost.

- An edit pushbutton to add stop cues in playback and omit stop cues in record
- LED indicators show end of tape, status and secondary/tertiary cue tones
- Front panel headphone jack
- VU meters for each channel

### Convenient, Flexible

MC-Series is field convertible from mono to stereo, or play to record. Optional remote controls simply plug in.

Four broadcast cart machines to choose from in the Telex/Magnecord

MC-Series - all made in U.S.A. and affordable. Write for detailed information.

### Quality products for the audio professional



9600 ALDRICH AVE. SO., MINNEAPOLIS, MN 55420 U.S.A.

Telephone: 612-884-4051, telex: 29-7053

EUROPE: 22, rue de la Légion-d'Honneur, 93200 St. Denis, France, Téléphone: 820-98-46, telex: 63-0013

CANADA: Telak Electronics, Ltd., 100 Midwest Road, Scarborough, Ontario M1P3B1, Telephone: 416-752-8575

Circle 146 on Reader Service Card

## NAB SHOW IN PRINT

### Radio program automation: hand-in-hand with business systems

The makers of large radio program automation systems that have dominated the market in recent years were on hand, and no important new rivals showed up. The new trend for these successful automation suppliers was association with business automation firms or systems, with complete interfaces worked out between the two sides for total automation.

Broadcast Electronics has made the interface between its Control 16 and Computer Concepts' business systems. A working pair was on the floor, supplying a live demonstration of instant communication between the two systems. Cetec's Model 7000 program system was similarly connected with the MAPS business system, bought by Cetec early in 1981, for another live demo. Again, speed in all the joint functions was one of the great gains, along with accuracy.

Harris Corp., having bought Automation Electronics, will market the Autotron systems separately as well as in paired association with the Harris System 90 program system. Harris had a live pair on the floor, with the Autotron Star linked to the Harris system. The Autotron system can have eight work stations and will work with other program systems in addition to the Harris. The system will reschedule automatically according to a "best rearrangement" when a spot cancellation or late insertion occurs. The rescheduling follows a program in the computer, with spot priorities established by the traffic manager.

IGM's Basic A was displayed connected with a Custom Business Systems traffic-accounting system. Again, the combination produced very efficient and rapid handling of time orders and other material coming from the traffic department, with spots actually aired reported back to the traffic department for billing and verification.

Sono-Mag brought a new, improved Mini-Pro live assist system with memory for 100 events. On the large Sono-Mag ESP systems, the memory has been extended to 10,000 events. Other improvements include a color monitor and easy interface to any business system, with the digital software now stored on cassettes.

For more information: Sono-Mag  
Mini-Pro, 463.

### Simpler systems broaden the range

As has been true for some time, program automation systems cover ranges of complexity and price that reach to the

very simple and inexpensive, allowing broadcasters to get into automation on any level desired. Audi-Cord introduced a live-assist programmer with a memory for 16 steps and capacity to control eight sources. It works with tape cartridge machines or other sources that respond to cue tones; if desired, it can be supplied with relay outputs to control other machines.

Another 16-event sequencer, the Broadcast Controls Model 1601S, has microprocessor operation for a broad range of functions. These include special event on any channel; full network join facility with internal clock, including deadroll, fade, reset, ID, net intro, Take Net, commercial, back to net; remote control allowing cluster insert, duck and talk over, talk down and hold. Up to eight expansion decks can be added to raise the memory total to 128 events.

Microprobe Electronics, long a source of inexpensive automation systems, brought an expanded version of the Model 100 live-assist sequencer with memory for 48 events. The system will handle eight sources, plus network, with adjustable deadroll, automatic advance if a source fails, overlap audio, time circuitry with 15-, 20-, 30-, and 60-minute formats to show when to skip over music to the next commercial.

Microprobe's larger Control 3 system will control multicart machines, with random select to any cart, and now has memory for up to 900 events.

ProTech Audio introduced an automation system called Basic-3, consisting of three compact modules on PC boards. The objective is to automate the control of cart and reel-to-reel machines by means of 25 Hz cue tones. The 725ATS card detects the 25 Hz tone, closes a relay to start the next machine, and closes a second relay with adjustable time delay to stop the earlier machine. The 725FA card has a 25 Hz notch filter to take the cue tone out of the program material. The 725OSC card holds an oscillator to provide the 25 Hz cue tone for insertion of the tone on the recordings.

Eumig, Inc. brought its audio cassette automation system, the FL-1000, first seen at the 1980 NAB and now equipped for instant interface with most small computers, including Commodore, Apple II, and various Radio Shack models. With the computer the FL-1000 supplies a new variety of low-cost automation, with an excellent set of control functions useful in radio.

**For more information:** Audi-Cord live-assist programmer, 464; Broadcast Controls 1601S, 465; Microprobe Model 100, 466; ProTech Audio Basic-3, 467; Eumig FL-1000 updates, 468.

# NEWEST AUDIO PROCESSORS AVAILABLE FOR DEMONSTRATION AND EVALUATION

*Most brands in stock*

*We ship anywhere overnight*



EXR Exciter S4-1



EXR Exciter EX-3



Audio & Design Limiter M-600



Eventide BD-955 Digital Delay Line



Lexicon 1200 Speech Compressor



Telex MC series Cart Machines



Telex Headsets



Otari MX-7800 Eight track



Otari 5050-B Half or full track



Otari ARS-1000 Automated tape deck

## Signal Processors

Audio & Design  
Recording  
Ashly  
dbx  
Dolby  
DeltaLab  
EXR  
Eventide  
Inovonics  
Lexicon  
Marshall  
Orban

## Microphones

AKG  
Crown/PZM  
Electro-Voice  
Neumann  
PML  
Sennheiser  
Shure

## Tape Machines

Eumig  
Otari  
Revox  
Technics  
Telex

## Monitors

Auratone  
JBL  
Tannoy

Plus: **Acoustic design** and consultation services for your control room or production facility.

# EVERYTHING AUDIO

16055 Ventura Blvd., Suite 1001  
Los Angeles, California 91436  
Phone (213) 995-4175 • Tlx 651485

Circle 147 on Reader Service Card

# NO OVERLOAD. NO MATTER WHERE YOU USE IT.

In-studio or on-location from a whisper to the roar of a full-blown rock concert, nothing can overload our MD 421. Nothing.

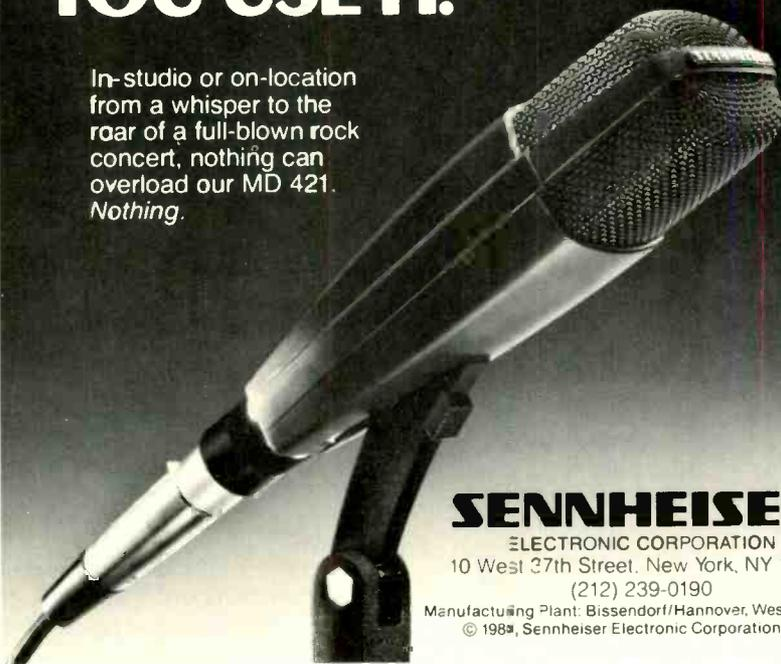

## SENNHEISER

ELECTRONIC CORPORATION  
10 West 37th Street, New York, NY 10018  
(212) 239-0190

Manufacturing Plant: Bissendorf/Hannover, West Germany  
© 1981, Sennheiser Electronic Corporation (N.Y.)

Circle 148 on Reader Service Card

## NAB SHOW IN PRINT



IGM showed the Basic A program automation system, with Go-Cart and Instacart, interfaced with Custom Business Systems' accounting and traffic automation to make the "complete" auto station



Control of Harris System 90 automation system has been interfaced with Autotron business automation system; the latter is now a Harris-owned product, will be marketed by Harris

### Computerizing radio business

Companies offering to computerize radio traffic, accounting, and so on have swarmed to the NAB for a number of years; many have been successful in sales to radio broadcasters. The number of companies on the floor was roughly the same this year as in 1980.

Chase Media was back to describe its CADO system for broadcasters. Now in use by more than 40 stations, CADO includes a music inventory system that stores titles and characteristics and automatically delivers playlists.

Computer Management Systems, also a long-time NAB exhibitor, emphasized its Broadcast Management Information System and related consulting services. CMS announced development of a complete traffic, billing, accounting system for the new RKO Radio Network.

Custom Business Systems, now marketed by IGM and available with interface to the IGM Basic A program system, as noted above, described a new hard-disk system with multi-terminal options and expanded software, which includes control for day-part considerations.

Groton Computer, successful with its moderately-priced on-line business service, has adopted the Apple computer for the in-house sector of its distributed-processing system. The subscriber has the small computer and the control, input and readout sections at the station for data needed day to day, hour to hour. Input for the large accounting, billing, and analysis operations goes by telephone to Groton's large central computer, where the complete memory for the station is stored.

The Management is a new venture, organized by Pete Charlton of Sono-Mag (but separate from that firm) with a fresh approach to low-cost business automation. The company supplies two programs, "Electric Log" and the

"Electric Bill." The plan is based on purchase by the station of the \$4500 Radio Shack TRS-80 Model I computer, which is easily installed by the buyer and serviced locally. The programs sell for about \$2500, which includes complete instructions, plus a package of practice diskettes. The programs have been devised, Pete Charlton says to cover 95 percent of the requirements of the typical medium-to-small radio station, with a standard capacity of 500 schedules (billings). Capacity can be expanded about five times with the Radio Shack TRS-80 Model II.

Nidus, making a first appearance at the 1980 show, came this time with a revision of software in its complete business system that increases scheduling ability and lifts rotation and separation functions. Nidus says it now has ready interfaces to program automation systems of Broadcast Electronics, Sono-Mag, and Cetec.

A computerized music storehouse that holds up to about 60 hours of recorded music at any time was described by the RITME-CX Library System. The music is arranged in coded subdivisions, each holding about 15 music selections. When the code for that subdivision is punched in on the keyboard, the selections are played on the monitor reproduction system, allowing the operator to choose one for broadcast, background music, or other purpose.

**For more information:** Custom Business Systems hard-disk system, 469; The Management Electric Log, 470; Electric Bill, 471; Nidus software updates, 472; RITME-CX Music storehouse, 473.

### The listener behind the numbers

Two firms on the floor offered elaborate analysis of Arbitron book figures to uncover the detailed characteristics of a

radio station's audience. Media Service Concepts of Chicago will supply a cume analysis system to explore patterns of listening behavior; trends to show the station's and competitors comparative changes and directions; listening maintenance patterns, and efficiency studies to track hour-by-hour listening for the station and the market.

Simmons Market Research Bureau of New York will determine demographics of the audience in voluminous detail, not only age but also education, economics, living patterns, occupation, etc. Also in their service is determination of buying attitudes toward hundreds of specific products in more than thirty product categories.

**For more information:** Media Service Concepts, 474; Simmons, 475.

### Electronic reverb continues up

Also on a strong uptrend is radio interest in electronic reverb, and there was a good supply of equipment for this function on the floor. Ursa Major, with its "Space Station" special-effects system introduced last year now strong in the industry, brought a new digital reverb system, Model 8X32, with attractive adjustment capabilities. It has 32 registers, in each of which a specific reverb program can be stored for use on a pushbutton basis. The user can adjust the reverb by ear, choosing one of four basic programs, setting the level and decay time of early reflections, then the initial decay time and other significant parameters. An "input mute" cuts off the signal so the reverb can be heard decaying naturally. "Reverb clear" momentarily cuts the decay to zero to open the way for a completely new reverb program.

MicMix brought two reverb systems not seen at the NAB before, the XL-210 and the XL-500. The XL-210 uses a spring system with elaborate controls

# "WHY USE WELLFLEX"

## Optimum Design

Cablewave Systems offers Wellflex Transmission Lines designed to meet your most stringent electrical and mechanical requirements.

Highly reliable, the unique Wellflex construction provides a combination of strength and flexibility with optimum performance.

Outstanding electrical parameters include extremely low RF loss, smooth impedance coefficient, and conservatively rated power handling capability.

Wellflex is available with either air or foam dielectric with copper corrugated outer conductor, solid and corrugated inner conductor (depending on size), and with a tough, durable, corrosion resistance polyethylene jacket suitable for burial and prolonged life.

Air Dielectric Wellflex in smaller diameters, ( $\frac{1}{2}$ " and  $\frac{3}{8}$ " ) offer a field proven, fixed helix design called Soirafil II - a single, continuous extrusion which locks the center conductor coaxially within the outer conductor, resulting in a near perfect impedance coefficient throughout the entire length of line.

RF transmission lines with welded and corrugated conductors are also manufactured by our associated companies in West Germany and Brazil.

Kabel-und Metallwerke  
Gutehoffnungshuette AG  
Radio Frequency Systems Division  
Kabelkamp 20  
3000 Hannover  
West Germany

KMP  
Cabos Especiais e  
Sistemas Ltda.  
Caixa Postal 7 163  
Sao Paulo SP, Brasil

## Optimum Performance

Larger Diameter Air Dielectric Wellflex Cables, ( $1\frac{1}{8}$ ", 3",  $3\frac{1}{2}$ " and  $4\frac{1}{2}$ " ) feature a unique vertebra helix design to achieve optimum crush and tension strength. Its "pillar effect" using less volume of dielectric, provides lower loss and higher power handling capability due to the more rapid dissipation of heat from the center conductor.

Wellflex has it all: low loss, low VSWR, higher power handling, smoother impedance coefficient, and rugged, long dependable life.

Cablewave System's Wellflex is type accepted for sampling systems in accordance to FCC Part 73.68.

Cablewave Systems, Inc., 60 Dodge Ave., North Haven, Conn. 06473, Phone (203) 239-3311

In Canada: LeBlanc & Royle Communications Towers Ltd., 514 Chartwell Rd., Oakville, Ontario, Canada L6J 5C5, Phone (416) 344-1242.

### Antenna/Transmission Line Systems Catalog

Complete in every detail, total information needed to plan, specify and purchase a complete system or component, plus complete engineering data and more!



**Cablewave Systems**



## 50 kW VHF power, greater efficiency. 4CX40,000G tetrode and cavities from Eimac.

Eimac's new CV-2200 series of practical, low-cost cavities are available now. Combined with Eimac's 4CX40,000G VHF tetrode, this efficient, compact package is recommended for FM broadcast service, VHF-television, particle acceleration and VHF radar.

Generating a measured power output of 60 kW, the 4CX40,000G tetrode offers power gains of 20 dB up to 218 MHz. High stability is achieved with the pyrolytic graphite grid structure. And a highly efficient, economical and quiet anode cooling system is inherent in its design.

Eimac supplies cavity and tube to match your requirements.

We back it up with know-how and application engineering information.

the nearest Varian Electron Device Group sales office. Call or write today.



50 kW FM broadcast cavity CV-2200 with 4CX40,000G tetrode.

Electron Device Group  
Eimac Division  
301 Industrial Way  
San Carlos, California 94070  
415 • 592-1221,  
ext. 218

More information is available from Varian Eimac Division. Or





## NAB SHOW IN PRINT

and associated circuitry that give it frequency response flat from 20 Hz to 20 kHz, distortion 0.05 percent to 0.4 percent at normal operating levels, noise at -78 dBm. Equalization at low, mid, and high frequencies gives separate  $\pm 12$  dB adjustment; decay time (T60) is three seconds; price under \$1000. The XL-500 has several selectable reverb programs, including a plate mode, a room mode, and a hall mode. It has excellent specifications and more flexibility in adjustment, with the decay time continuously adjustable from one to six seconds.

Quad Eight brought System 5, which has adjustable decay time from 0.5 to six seconds, high-frequency reverb time adjustable over a pre-delay from 0 to 100 ms in 5 ms steps, four-section equalizer, dynamic range of 105 dB, distortion less than 0.02 percent, signal-to-noise ratio 85 dB. The unit has three separate basic reverb programs that can be altered by more than 13,000 different control settings.

**For more information:** Ursa Major 8X32, 476; MicMix XL-210, 477; XL-500, 478; Quad Eight System 5, 479.

### Lengthening and shortening time

The lengthening or shortening of the running time of recorded material without perceptibly altering pitch is on the upswing. Lexicon, strong in digital reverb, brought a new version of its Model 1200 audio time compressor, introduced in earlier form at last year's NAB. The new unit has speed change range of 0.5 to 2.0, frequency response 40 Hz to 15 kHz,  $\pm 1$  dB, and extremely low noise and distortion.

Also from a veteran of digital special effects and reverb systems was the Eventide TimeSqueeze system, which is based on a small computer tied to the company's H949 Harmonizer and PIC945 Precision Tape Controller. The computer can be the Hewlett-Packard HP-85 or one like it. It is programmed so that the user simply punches in the time the tape is to run. The system then controls the tape machine to run at the right speed and sets the Harmonizer to make the pitch correction. Time ratio is adjustable from 400 percent down to 50 percent of original recording time. The system has distortion less than 0.15 percent at 1 kHz, dynamic range of 96 dB, frequency response  $\pm 1$  dB, 20 Hz to 15 kHz.

A third time compressor appeared in the booth of Integrated Sound Systems from Long Island City, N.Y., a firm formerly emphasizing sound system installation. The Model TDM-8000 audio time compressor has a speed factor adjustable from 1 to 1.5 and excellent

audio specifications at all speeds.

**For more information:** Lexicon Model 1200, 480; Eventide TimeSqueeze, 481; Integrated Sound Systems TDM-8000, 482.

### Equalizers: more top performers

In addition to the modular equalizer in the dbx system, noted above, new equalizers came from three companies. Orban Associates introduced the new Model 672A, which combines operation features of a parametric and a graphic. It has eight bands, each tunable over a 3:1 frequency range, with Q variable from 0.3 to 20 (center tuning). Equalization is adjustable  $\pm 16$  dB on each range. Frequency variation, noise, and distortion are all at today's minimum levels.

Aphex Systems, branching out from the "enhancement" system that has won it a place in the last few years, brought a number of sound-system and studio components, among them the EQF-2 parametric equalizer in a modular package. It has five bands of adjustment, each covering a broad range, with constant 1.5 octave bandwidth, reciprocal equalization curves, expandable resolution, and state-of-the-art characteristics.

Sphere Electronics added another high-technology equalizer with its Model EQ-1014. This is a parametric with four bands — low, mid-1, mid-2, and high — each adjustable over a wide frequency range and amplitude range. Q is variable in the mid bands, shelving is available in the high and low bands. The passband characteristics, once more, are completely state-of-the-art. The unit is another in a modular case, readily dropped into Sphere (or other) consoles. Radio broadcasters will usually want equalization in some form, especially if they do any program production.

**For more information:** Orban 672A, 483; Aphex EQF-2, 484; Sphere EQ-1014, 485.

### Audio processing and noise reduction

Radio broadcasters' interest in audio processing has been on a steady upward curve for several years; in *BM/E*'s most recent survey of broadcast industry needs (reported in February, 1981), processors were fourth on the "wanted" list, higher than ever before.

At the show all the makers of audio processors who have been prominent in the field in recent years had their units on display. Gregg Laboratories introduced a new AM processor, the model 2560, with some elaborate design features. The signal is divided into five frequency bands for the major control

action. High-frequency equalization is aimed to offset the typical AM receiver roll-off. Clipping circuits are designed to minimize ringing.

dbx, Inc., showed for the first time at NAB its Series 900 modular signal processing system. The system uses a rack into which up to eight modular units, of uniform size, can be plugged. Functions available in the plug-ins are: de-essing; a compressor with compression ratio adjustable up to infinity:1; a noise gate; a parametric equalizer; a flanger. dbx says that additional plug-in processing units for the system are coming.

dbx also introduced its Type II noise reduction in two new forms, aimed especially at broadcasting. The 941/942 are encode-decode units, respectively, which fit into the Series 900 rack. The Model 140 is a simultaneous encode/decode unit for the Type II noise reduction in a standard rack mount. All provide the 30 dB of noise reduction and 10 dB of headroom that characterize the dbx system.

Audio and Design Recording brought its Transdynamic Triband processing system, not seen at the NAB before. This unit supplies all the circuitry for comprehensive three-band processing if used with any automatic gain-control amplifier. The Transdynamic has a considerable number of advanced ideas, such as a control circuit on the peak limiter that can be contoured to 25, 50, or 75  $\mu$ s preemphasis. This, says the maker, allows super-clean high frequency processing without high frequency overload. Other operation features are separate control of attack, release, and compression on each band, adjustable peak modulation asymmetry for AM, LED bar graph metering, and built-in pink noise generator for easy setup.

ProTech Audio of St. James, N.Y., had a new compressor/limiter, Model 663CL, which is complete with a power supply in a rack-mount cabinet 1 $\frac{3}{4}$  inches high. The unit supplies a compression ratio of 2.5:1; frequency response  $\pm 0.5$  dB, 30 Hz to 20 kHz; adjustable attack and release times; and 0.5 percent THD at 27 dBm out. Price is under \$500.

Circuit Research Labs of Tempe, Ariz., a newcomer, showed an array of processing units for both AM and FM. With each unit in a 1 $\frac{3}{4}$ -inch high standard rack mount, the systems are based on units that divide the total processing job into sections. The APP-400A "audio preparation processor" uses operational transconductance amplifiers for a broad overall preliminary gain control action. It is ordinarily teamed with the PMC-400 "peak modulation controller," which has five functions; soft and hard clipping for final modulation control; adjustable preemphasis for AM; overshoot-free filters; phase cor-



Digital delay line of Eventide Clockworks has adjustment for many functions, including special effects, a variety of reverb characters

rection to reduce the deficiencies of older, heavy-iron plate modulation; and asymmetrical waveform generation for AM. Similarly, other units in the line include a "spectral energy processor" that controls level in separate bands; an optional "composite controller" for control of the FM composite signal; "stereo preparation processor" for two-band control of a stereo signal; and "stereo modulation processor" for final control of stereo signal.

A dual peak limiter from UREI, Model 1178, puts in one package two separate channels, each similar to the earlier one-channel Model 1176LN. The two can be used entirely separately or tracked together for stereo with a front panel control. Also on the panel is adjustment for both attack and release times and selection of four compression ratios. The unit has high impedance balanced bridging inputs and extremely low noise and distortion. It comes in a rack mount 3½ inches high.

**For more information:** Gregg Labs 2560, 486; dbx series 900, 487; 941/942, 488; 140, 489; Audio and Design Recording Transdynamic Triband, 490; ProTech Audio 663CL, 491; Circuit Research Labs APP-400A, 492; PMC-400, 493; UREI 1178, 494.

## Mics on the iron burner

There has been a gradual, steady increase in microphone development activity through recent years. NAB '81 showed an acceleration.

Beyer Dynamic, a main source of microphones for years, showed its very extensive line with a model new to the NAB, the clip-on MCE-5 electret condenser. This mic may be the smallest condenser clip-on, at a diameter of 7 mm and length of 23 mm. It can operate as a wireless mic with Beyer's wireless pocket transmitter. A version with 5.6 V battery in the connector section is also available for direct connection to amplifiers or tape recorders. Claimed characteristics are square on the upgrade: very flat 20 Hz to 20 kHz, S/N ratio 62 dB, omnidirectional.

Crown International brought its amplifier line and its pressure-zone microphones. This new twist in microphone technology, now about three

years old, invokes the principle that the direct and reflected waves are in phase for a very short distance above any reflecting boundary. By putting the microphone flat against a boundary, in this "pressure zone," the system gains insensitivity to differences between direct and reflected sound. This gives the microphone unprecedented "reach" since all incident waves add cumulatively, and also freedom from comb-filter effects since all sounds are in phase.

Physically, the mics are also handy because of their flat profile, which makes it easy to absorb them unobtrusively into a scene. Crown showed several models, each with an electret capsule mounted very close to a backing plate. Specs for the PZM-31S, for example, include stated frequency response of 20 Hz to 20 kHz, ±3 dB, THD 3 percent at 150 dB SPL, and signal-to-noise less than 25 dB SPL (equivalent acoustic input).

Electro-Voice, probably the seller or more microphones than any other maker for the last two decades, had three new ones this year. The CO94 is a miniature lavalier-clip electret condenser microphone, omnidirectional, designed for connection to clothing. The microphone is about 22 mm long by 10 mm in diameter, and connects by six-foot cable to a power supply/buffer unit, which is normally clipped to the user's belt. It can also run on phantom power supply. Its small size adapts it to barrier recording (ceiling, wall, or floor). Electro-Voice says the mic will handle 20 dB more sound than earlier similar models, or 141 dB. The DO56 is an omnidynamic unit with high shock isolation, intended for hand-held use by vocalists on stage and television, as well as for such applications as sports interviews. The PL77AA is a cardioid electret condenser, with very flat frequency response to 20 kHz, 100 dB dynamic range, and 30 dB equivalent noise level, A weighted.

The Panasonic Video Systems Division introduced a new wireless microphone system aimed at ENG and other remote pickup operations. The components include an omnidirectional electret condenser microphone; the WX-

9000 transmitter, designed for attachment to the user's clothing; and two receivers, WX-9200 and WX-9250. The first receiver is dc-powered from an ENG power source and can be readily mounted directly on a TV camera. The second has internal battery power. The transmitter puts out 30 mW of power in the 450 MHz band. Frequency response of the system is given as 50 Hz to 10 kHz, ±3 dB.

The Panasonic Professional Audio Division also brought a new microphone, the Ramsa VVM-8100. This is a unidirectional back electret condenser with push-pull configuration, allowing handling of sound pressure up to 154 dB SPL. Frequency response is excellent to 18 kHz, S/N ratio is better than 52 dB, and dynamic range is better than 132 dB.

Sennheiser had a new wireless microphone system, recently accepted by the FCC for use on unoccupied TV channels, either the 181 MHz band or the 205 MHz band. The system uses narrow bandwidth and crystal-controlled oscillators to allow multi-frequency installations. A Sennheiser "HiDyn" noise suppression circuit minimizes noise interference for an S/N ratio of 74 dB. The transmitter is FM modulated with 50 mW output and runs on a 9 V battery. The receiver can use the 110 V ac line, a built-in battery, or an external 12 V dc power source.

Sennheiser also added to its line of headphones with the Model HD222. This is a "closed-ear" type, in contrast with the "open air" headphones that Sennheiser has marketed very successfully for a number of years. The new HD222 headphones cover the ears tightly with substantial isolation from ambient sound. Weight is 8.8 ounces.

Shure Brothers, another long-standing bulwark of microphone development, introduced the SM85, designed especially for hand-held use by vocalists and broadcasters on remotes. It has an elastomer shock mount and a three-stage wind and pop filter. Special effort went into controlling distortion, resulting in THD well below one percent up to an input level of 143 dB SPL.

Sony brought its new ECM-989MS, which has an interesting design: three separate cardioids are used in an adjustable M/S (coincident mic) stereo plan. The capsules are back electret condenser mics, which have gold-evaporated film diaphragms six microns thick for frequency response flat to 20 kHz and S/N ratio better than 66 dB. The power supply can be in the same housing as the capsule unit, or can be separated from it up to 330 feet. Orientation of the pickup patterns is electrically adjustable to meet any pickup requirements.

Sony's demonstration of its wireless microphone system was one of the

**What  
the Shadow  
doesn't know  
...it learns.**

**The BTX Shadow System:**

- synchronizes and controls ATRs and VTRs to sprocket-lock, subframe accuracy
- learns each recorder's dynamic characteristics to optimize machine control
- maintains minimal offset during GO TO and CHASE functions
- runs independently, allowing hands-off synchronization in all control modes
- uses standard RS 232C interface to permit present and future computer automation, including electronic editing
- available with optional control console, which displays time and status data and allows keypad entries of destinations, GO TO and FOLLOW commands, and data storage/retrieval
- priced to permit each transport to have its own Shadow

To learn what the Shadow knows, call  
1 (800) 225-2253



The BTX Corporation, 12 Huron Drive, Natick, MA 01760



Circle 217 on Reader Service Card

## NAB SHOW IN PRINT

pleasantest — and most convincing — of the show. On one side of the aisle, two top-notch violinists played classical duets. Each wore a Sony WRT-57 wireless mic. About 30 feet away the mic signals were received, sent through Sony's digital reverberation system, and fed to headphones. The live sound and the transmitted sound could be compared comfortably, and the latter came off extremely well.

Telex was another firm with a wireless microphone system. The receiver, Model FMR-1, operates as a single-channel FM wireless mic receiver with one antenna or as a diversity system with two antennas. WT-100, the belt-pack transmitter, has a cable connection to Telex's WLM-100 electret lavalier microphone. The transmitter is also equipped to accept any low impedance microphone. The system incorporates compression-expansion circuitry to improve the signal-to-noise ratio. RF is in the 150-174 MHz range.

**For more information:** Beyer MCE-5, 495; Crown pressure zone mic, 496; Electro-Voice CO94, 497; DO56, 498; PL77AA, 499; Panasonic Video Systems wireless system, 500; Panasonic Professional Audio VVM-8100, 501; Sennheiser wireless system, 502; HD222 headphones, 503; Shure SM85, 504; Sony ECM-989MS, 505.

### Turntables and pickup arms

Turntables and tonearms are only as good as the records they play. While table and arm manufacturers were not showing new and radical innovations this year, an Englishman arrived at his first NAB with a record cleaning machine that just may be the industry's "better mouse trap."

Available in a single or double-deck version (Mark II and Mark III, respectively), these professional record cleaning machines are manufactured and marketed by Keith Monks, whose base is outside London but who has a subsidiary company — Keith Monks (USA) Inc. — in Stamford, Conn.

A half-and-half mix of distilled water and industrial ethyl alcohol is applied through a brush to records that spin on a turntable. A suction arm sweeps from the center of the record to the edge, sucking up the liquid cleaner and suspended particles. When the process is completed — about 90 seconds for each side — the record is dry, clean, and free of all chemicals. The machines have been marketed around the world, but this is Monk's first attempt to deal directly with U.S. broadcasters.

Micro-Trak introduced a turntable preamplifier it calls Model 6411. The

\$169 unit features a transformerless electronically balanced output and is switch selectable for high-frequency adjustment.

Stanton Magnetics was at its first NAB, but the company is certainly not a stranger to broadcasters. The Stanton phono pickups lift the music off disk recordings in hundreds of radio stations. Stanton showed a new pickup, the 980LZS, which the company calls "The Moving Coil Replacement." It is a moving magnet design with mechanical impedance at a very low level for dynamic tip mass rated at 0.2 mg, rise time of 10  $\mu$ s. Stanton gives frequency response of 10 Hz to above 50 kHz; resistive load can be 100 ohms or higher.

Stanton also showed its line of headphones, the Model 310 preamp-mixer, and its record-cleaning equipment.

Others displaying turntables and tonearms that have been seen at previous NAB exhibitions were Russco, and Technics/Panasonic.

Fidelipac showed Audio-Technica's ATP series of dual magnet cartridges, available with either spherical or elliptical diamond styli.

**For more information:** Keith Monks record cleaner, 506; Micro-Trak 6411, 507; Stanton 980LZS pickup, 508.

### Working on the telco interface

At the show Comrex demonstrated its complete system, the Studio/Telephone Conference Integrator, which allows a talk-show host to put up to two callers on the air, with the audience hearing both callers and the host, and each caller hearing the host and the other caller. The control system allows the host to seize or drop either of the incoming calls at the push of a button.

Comrex also announced an addition to its Low Frequency Extender, which has done so much to improve the quality of telco carried remotes. A high-frequency enhancement unit can be added at the sending end; in a live demonstration at the Comrex booth, this predictably lifted the naturalism.

Russco Electronics introduced two units intended to help the broadcaster with the telco interface. The T411 "Tel-E-Mote" is a portable remote mixer with three channels and switchable line equalization for improving telco quality. The T112 telephone-to-studio equalizer/coupler has two separately adjustable 600 ohm balanced outputs for feeding the console and recording gear simultaneously. It has a 2W headphone amplifier for monitoring without loading the line, a three-band adjustable equalizer for improving telco line quality, and a 60 Hz notch filter for reducing hum.

**For more information:** Comrex Low Frequency Extender improvements, 509; Russco T411, 510; T112, 511.

### More top-fi studio gear

Studio gear for broadcasters has, by and large, caught up with, or gone ahead of, the high-fidelity instruments that used to outdo it. But some movement continues from high-fidelity technology into broadcasting. Crown International represented this movement in specific terms at the show. It was Crown's first time at the NAB, and the company announced a reorganization and enlargement of its product line to meet the needs of the two separate markets, the consumer and the professional. For radio broadcasters, this was a formalizing of a relation that has existed with Crown amplifiers for a long time.

Crown has redesigned the front panels of the DC-300A and DC150A, two of its best-liked amplifiers of the last 10 years, to accord with the new emphasis on "professionalism." The changes amount to a more rugged power switch, a relocation of level controls, and a new appearance. Crown also introduced two brand new power amplifiers in the professional series, the PS-400 and PS-200. Both have top-most specifications like those of the DC series, the immunity to output shorts, etc. The PS-400 is rated at 265 W per channel into 4 ohms, the PS-200 at 140 W per channel into 4 ohms.

Crown also showed its line of pressure-zone microphones, a real first for the NAB. They are discussed in another section of this report.

Another company showing new, advanced power amplifiers was United Recording Electronic Industries. Representative of their series is the Model 6500, rated at 275 W per channel into 8 ohms, 450 W per channel into 4 ohms. The amplifier has a modular design, with each channel and its separate power supply on a module. Specifications are at the all-out levels we get today in the best amplifiers: intermodulation at 0.05 percent up to full rated output, noise —100 dB below rated output, rise time less than 7  $\mu$ s, slow rate 50 V/microsecond.

We also have today an array of turntable preamplifiers of spectacular performance. Broadcast Electronics brought a new one to the show with specs that are startling even by today's super standards for this gear. The company rates the new EP-1 at 0.01 percent harmonic distortion and intermodulation distortion, less than 0.1 percent transient intermodulation distortion, frequency response within 0.5 dB of the RIAA curve, weighted noise 90 dB below reference with 10 mV input. The



# the trendsetters

Unquestionably the industry's standard of excellence in broadcast equipment

Most manufacturers meet industry standards; we exceed them. Our TOMCAT cartridge recorders/reproducers and BMX series of broadcast consoles deliver trendsetting on-line performance in broadcasting systems worldwide, from Boston to L.A., Australia to Great Britain.

**TOMCAT:** simply the world's finest. Innovative design assures superb sound quality, reliability, and low noise operation. Our Maxtrax™ wide-track fixed azimuth heads yield more signal, lowest phase error.

**BMX, Series II:** the ultimate in high performance mixing consoles. These compact units feature proven RF immunity and CMOS remote control flexibility, plus a choice of 10, 14, 22, and 26 input mainframe configurations. A new mix module is now available to offer two mix-minus busses for telephone talk shows. All this in a no-nonsense panel layout!

See why TOMCAT and BMX series have made us the industry trademark. Call or write today for free information on our complete line of equipment.



pacific recorders & engineering corporation

11100 roselle street  
san diego, california 92121  
telephone 714 453-3255

## NAB SHOW IN PRINT

maker also says the unit is highly resistant to RF interference, with each audio and power conductor having an independent RF filter network.

**For more information:** Crown PS-400, **512**; PS-200, **513**; UREI 6500, **514**; Broadcast Electronics EP-1, **515**.

### Switching and distributing at top fidelity

The top-fi studio must have top-fi switching and distributing networks for its audio. Pacific Recorders has custom-built a number of systems for getting audio around a complex of studios with purity undiluted. The company now is offering several standard systems of the kind. The RS-16 audio routing switcher takes in up to 16 stereo program channels and combines them in any way in the output. A microprocessor supplies any wanted switching logic while reducing the need for hardwiring connections for all possible switching modes. The system has vanishing-level distortion and noise. The SDA-20/XB-200 is a combined audio switcher and stereo distribution system. It has 20 stereo inputs, up to nine very low impedance stereo outputs. The SDA-8 has a bridging stereo input feeding eight stereo outputs. These systems all have characteristics aimed to preserve to the full the quality of the audio.

**For more information:** Pacific Recorders RS-16, **516**; SDA-20/XB-200, **517**; SDA-8, **518**.

### Intercoms

Intercom systems manufacturers arrived in Las Vegas with a clutch of new equipment, much of it designed for wireless operation or for interfacing wireless and hardware systems.

A prototype for a four-channel microcoupler — essentially a four-pack of mini-receivers — was shown by Nady Systems. The single antenna coupler, which will cost about \$600 when it is available later this summer, will feed four wireless mic channels.

In addition to showing his line of wireless receivers and Nady Cordless wireless mics, company president John Nady said he would be launching a new wireless intercom system this summer. The new duplex system will have a range of up to one mile. Cost, he estimates, will be about \$500 a channel.

A new 20 dB-gain preamp mic transmitter that weighs a scant five ounces was introduced by Swintek. Called Mark 50A/dbs/PZM, the \$895 transmitter allows sound transmission even at a whisper. The unit will accept

dynamic, electret, or high-level PZM mic inputs. Typical dynamic range is 100 dB for this transmitter that operates in the high band from 150 to 350 MHz. The company also was showing its not-so-new 200/CPS duplex intercom, aiming it to the new generation of ENG camera/recorders, which can carry the \$1995 transceiver system on board.

A base station that will interface wireless intercom headphones with any hardwired system was introduced by R-Columbia Products. The audio signal from a hardwired headphone is fed into the base station, then transmitted to any number of wireless headsets on one channel.

A similar system was being discussed at Cetec Vega's stand, where the company was displaying its range of wireless intercom equipment. Cetec Vega expects to market its QX1 and QX2 systems by July (pending FCC acceptance). The QX2 is a wireless intercom that will handle six duplex conversations simultaneously to or from any hardwired intercom.

Television Equipment Associates of South Salem, N.Y., was touting BCA's 929 intercom system. The 929 will feature remote panel capability and will carry a remote mute that can be programmed in the field.

An IFB switchboard main station, the SB-412-IFB, designed specifically for television studios marks Clear-Com's decision to introduce a line exclusively for TV. The board features a 12 by four assignment matrix, a monitor that can be assigned to any of four channels, and a power supply. The matrix will assign 12 stations or groups of stations to any one of four channels or an "off" position, at which time all stations on that line can communicate with each other but are disconnected from the switchboard. Six of the station lines have an ISO function, allowing separate isolated communication between the main station and a selected station line.

ROH, Farrtronics, and Sigma Electronics were showing modular intercom and distribution systems that have been seen at NAB earlier. HM Electronics intends to have a wireless intercom system available next month (July), but did not have a prototype system at the show.

**For more information:** Nady Systems microcoupler, **519**; wireless intercom, **520**; Swintek Mark 50A/dbs/PZM, **521**; R-Columbia base station, **522**; Contec Vega QX1, **523**; QX2, **524**; Television Equipment Associates BCA 929, **525**; Clear-Com SB-412-IFB, **526**; HM Electronics, **527**.

### Monitor speakers

Among studio monitor speaker mak-

ers, some faces new to NAB appeared in Las Vegas this year, while some of the old guard promised some new developments.

Tannoy, a U.K. company with a strong track record in Europe, is being handled in this country by BGW Systems of Hawthorne, Calif., a newcomer to NAB. BGW was showing the Tannoy SRM 10B, new to the U.S. market. The speaker has a maximum output power of 80 W and produces 109 dB at one meter over a frequency range of 70 Hz to 20 kHz.

A larger speaker, the SRM 12B, has the same output and sensitivity — 1 W produces an average level of 90 dB from 50 Hz to 20 Hz — as the SRM 10B, but can handle a continuous 100 W input from 70 Hz to 1 kHz, whereas the SRM 10B takes a maximum input of 80 W over the same range.

BGW also pulled the wraps from its Model 150 power amplifier, a rack-mounted 150 W output unit that boasts a frequency response of +0, -0.25 dB at 20 Hz to 20 kHz. Hum and noise level are claimed to be better than 109 dB below 50 W. First delivery of the \$549 Model 150 was to Norwegian Broadcast last December.

Three new Time Aligned 75 W studio monitors were unveiled by United Recording Electronics Industries (UREI). The Sun Valley, Calif., company showed its 811A, a single-woofer coaxial model with a sensitivity of 87 dB SPL; its 813A, a dual-woofer coaxial speaker with 89 dB SPL sensitivity; and its 815A, triple-woofer coaxial model with a sensitivity of 91 dB SPL. Frequency response of all three speakers is  $\pm 3$  dB between 40 Hz and 20 kHz.

While JBL displayed its series of professional speakers that have been seen at previous NABs, company officials allowed as how updates were in the wind. Indeed, JBL was hoping to show the updates at the Audio Engineering Society exhibit — a month after the Las Vegas NAB show had shut down. In the upcoming JBL offering: the 4343 studio speaker will have an 18-inch woofer — currently it carries a 15-inch woofer — and new 10-inch midrange speakers as well as a new network.

Having introduced the Sentry 100 last year, Electro-Voice this year came up with a rack/wall mounting bracket kit — designated SRB-7 — for the 30 W speaker system. The Sentry 100 no longer has to sit on the floor.

**For more information:** Tannoy (BGW) SRM 10B, **528**; SRM 12B, **529**; 150 power amp, **530**; Time Aligned (UREI) 811A, **531**; 813A, **532**; 815A, **533**; JBL 4345, **534**; 4400, **535**; E-V SRB-7, **536**; QSI VALID, **537**; master clock system, **538**.



Free! PhaseMaster Record  
Send For Your Copy  
of Our Hit;  
"The Worst of K-FAZ Radio!"

# "There are cart machines... and then there's PhaseMaster."

"That's me, Johnny P. Shift, morning D. J. at K-FAZ radio. With sound like ours, we're lucky to have any listeners at all. I mean we got it all. Unacceptable phase shift. Annoying holes in the sound. And enough wow and flutter to drive anybody with half an ear to distraction. Sometimes I wonder whether we're trying to entertain people...or get even with them!"

"So I keep telling Uncle Bobby, my station manager, about Ramko Research's new PhaseMaster Series. Everything from a single playback through a stand alone record/play unit to a complete package for recording, playing and duplicating cartridges and cassettes!"

"PhaseMaster eliminates phase shift, once and for all. Wow and flutter are reduced to absolute minimums. And, there's signal-to-noise, distortion and

frequency response figures that are unheard of in the business 'til now. Tape hiss is gone — I mean to tell ya', this sucker's quiet. And, it's completely compatible with existing cartridges."

"If I've explained PhaseMaster to him once, I've done it a hundred times. All about how we can get rid of time-consuming calibration procedures. How there are no complicated, expensive electro-mechanical devices for moving the heads around. How PhaseMaster electronically

compensates for any phase shift and corrects the error in real time. And quality, Man, these things are built like a brick... tank. Which is why they've got the longest warranty in the industry!"

"I tell him the whole story — including how Ramko will give us a free two week trial (that is, if he hasn't already ruined our credit). So, you know what he keeps asking me? 'What's the phone number?'"

"So what do I look like, the phone book?"

The Ramko Research PhaseMaster Series eliminates phase shift and gives you all the operational and convenience features you ever wanted in a cart system, mono or stereo. Get a free two week trial or more information by calling your nearest Ramko Sales Representative or (916) 635-3600. Collect.



**NOW SHIPPING**

**Growth plan for television products  
and services in the '80's.**

**CENTRAL DYNAMICS**

**+**

**PHILIPS**

**+**



**American Data**

**Three recognized world leaders  
in broadcast equipment have merged  
their talents and technologies to meet  
the world's television challenge  
of the 1980's.**

**And that's good news for the whole industry.**



Customers in North America will now be served by a much larger integrated organization for fast, efficient service for all products.

With the formation of new U.S. and Canadian organizations, Central Dynamics will market Philips Broadcast and American Data products in the United States and Canada. (Philips will market CDL products throughout the rest of the world, as they have since 1972.) International sales of ADC products will continue through the present overseas network.

In addition, the acquisition of American Data by Central Dynamics doubles the company's manufacturing capacity with plants in the U.S. and Canada. N.V. Philips will concentrate on design and manufacture of advanced cameras, transmitters and equipment for the digital television decade.

This aggressive move establishes a wide range of products available from one source, and represents a long term commitment of these companies to new technology, product and customer service.

The first phase of the plan is already taking place:

- CDL has increased manufacturing capacity 30% in their Montreal plant.
- N.V. Philips Broadcast Products are moving into larger facilities in Eindhoven, Holland.
- An expanded CDL and ADC research and development effort has already been launched.
- And, the new expanded organization will move soon to new headquarters in northern New Jersey staffed for sales, service, parts, product management and support activities.

The compatible products and services of CDL, Philips and American Data are now offered by one U.S. company dedicated to the television industry:

Philips ENG, EFP and Studio cameras

Teleproduction vans and systems

Video recorders

Production switchers

Digital noise reducers

Master Control switchers and Automation Systems

Machine control and pulse distribution systems

Routing switchers

Terminal equipment

Philips/Pye UHF and VHF transmitters

Plus these corporate services:

- Customized systems for vans and studios.
- Package financing for equipment and systems.

Customers now have access to a single large company for fast, efficient service for all products. That makes good business sense. And this stronger, larger company is committed to meet the industry's growth requirements throughout the '80's.



**CENTRAL DYNAMICS**

Central Dynamics Corporation  
91 McKee Dr., Mahwah, NJ 07430, 201-529-3800

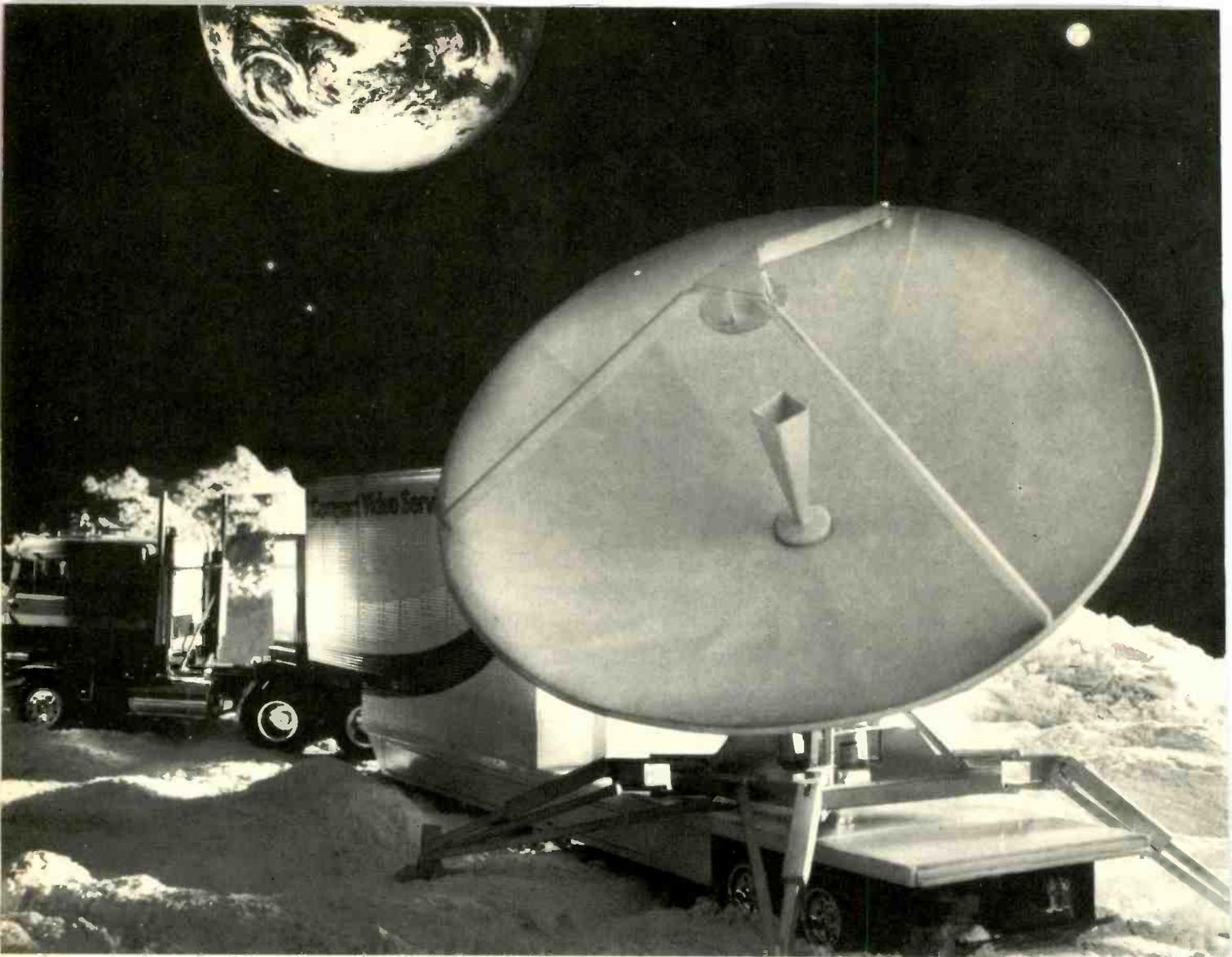

# We'll go 22,300 miles into space to save you money.

Tired of paying high costs for location transmission?

Then meet Compact's brand new Transportable Earth Station. Whether you rent by the day, week or month, it can help you eliminate expensive land line transmission costs.

A self-contained satellite broadcast facility complete with a unique folding antenna dish, the Transportable Earth Station gives you the ability to broadcast your event live and direct from location by communications satellite.

While it may sound exotic and complicated, our system is a necessary alternative to microwave or land line delivery of your program. From the time you arrive at the location, a single engineer can have you

on the air in as little as one hour. And because it's designed and built by Compact Video, the unit performs to our scrupulously high standards of technical excellence.

Of course, as a complete production facility, Compact can arrange for everything you need including production equipment, crews, and even transponder time.

Next time your schedule calls for a pickup from a remote location, give Compact's Hynndie Wali a call.

Chances are she can put together a package that can save you time, money, and headaches.

We'll do anything to save you money. Even go to outer space.



## Compact Video Services INC

Compact Video. Performance, not excuses.

2813 W. Alameda Ave., Burbank, CA 91505 [213] 843-3232

**NAB SHOW IN PRINT**

# TELEVISION FACILITIES BENEFIT FROM NEW DESIGNS



**Computerization has come to the TV plant with a vengeance. In everything from editing systems to lighting systems, the computer is used for efficiency and control.**

## Editing equipment

Editing equipment at this year's NAB was decidedly "market sensitive." Not only were low-cost systems plentiful, but the cost per feature factor was way down. Another aspect of "market sensitivity" was the arrival of appropriate editors for each user's needs. Whether the task is feature film, prime time programming, news or industrial, a good editor at the right price was available.

Ampex's ACE editing system, a modular design that expands to the size the user needs. ACE interfaces with up to 20 machines, including switcher control for multiple-mix effects. It comes with a choice of three types of control interfaces, a dedicated keyboard, an ASCII keyboard and, what caused the most interest, the TouchScreen™ — a light-sensitive infrared grid within the CRT that responds to a finger touch. By touching the screen at a particular spot a number of edit functions can be called up. The user programs an edit decision list by going through the various menu options. Several people mentioned that the system was not one for untrained editors. A spokesman for Ampex acknowledged ACE's complexity, but added, "If you don't like something all you have to do is stick your finger in it."

Control Video Corp. also had a light-sensitive editor, the Lightfinger, that differs from the Ampex system in a couple of key ways. First, it is marketed toward smaller post-production facilities and stations (though CVC says the system can be expanded to a size compatible with even the largest facilities). Secondly, it is geared for the inexperienced editor and constantly

prompts the next edit function necessary. The final way that CVC differs from the Ampex ACE is that it starts at a much lower price as a two-machine editor costing about \$17,000.

CMX/Oroxx added some improvements in the software of the 340X which are said to increase the speed and simplicity of the editing. A new part of the program is Motion Memory M2, which allows the system to control the edit from a one-inch VTR in whatever speed or direction selected (one-fifth speed in reverse to two times speed forward). The Motion Memory M2 operates on most one-inch VTRs — Sony, Ampex, 3M/NEC, and Hitachi,

Convergence once again came out with a new version of the ECS-100 series. The new ECS-104 (and optional ECS-104S) sports a number of new software additions that expand the capability of the system. The basic unit offers a range of auto assembly list management features. It has a joystick for scrolling through the list, a source and record VTR time code search, an automatic list cleaning function after each individual edit, the "409" program for full list cleaning, and automatic self-diagnostic program testing. The ECS-104 starts at \$34,000.

The big news from Datatron was a reduction in the price of its editors. The company announced a 10 percent cut across the board.

In addition to the price rollback, Datatron showed for the first time at NAB the Smart Scan™ option for the

Vanguard editor. Smart Scan™ takes advantage of the broadcast-quality variable speed capability of many of the one-inch VTRs on the market. It "learns" the speed and direction in which the tape transport is supposed to run and then operates in that mode when the edit is made.

The final edit decision list, as with a number of larger editors, is compatible with "another manufacturer's system" or can be programmed to whatever EDL standard SMPTE finally adopts.

Fernseh introduced new software for the Mach One™ editor. As did several other editors, it offered a program that allowed for the variable speed capability of one-inch machines. The major innovation in the Mach One™ software was its "cluster event" feature, which allows for the previewing or recording of a complex series of transitions with a single operation. It was developed to go with production switchers with effects memory, such as the E-MEM option from GVG.

UNEMCO was not on the exhibit floor, but showed the Edit Master to dealers in its suite. The Edit Master is a computerized edit controller that can handle 28 sources. What excited some people was that the mainframe costs \$5000 and each interface costs \$1500. Given a standard configuration of about seven sources, the Edit Master and interface would cost \$15,500.

The Edit Master is a distributive system with an interesting approach to the interfaces. There are two types of inter-



To select an edit decision, the user need only touch it on the screen with Ampex ACE



Convergence continued to develop its ECS line of editors — the latest is the ECS-104

# THE FACTS ARE IN...

The **isi** 200 Series with PolyKey<sup>®</sup> is today's truly advanced switching system.

**FACT:**

Our 200 Series is available in three different configurations (shown) providing the right size switcher for any facility.

**FACT:**

Every 200 Series switcher is built around the amazing PolyKey effects (PKE) unit. Unmatched flexibility allows complex transitions like two edged title keys over a bordered wipe behind a chromakey to be performed with speed, accuracy, and simplicity.

Standard features in every PKE include four input busses, auto transitions, internal quad split, title key over/under, video and chroma keying, black/white/color key edging, rotary and spin wipes - and more!

**FACT:**

The Downstream Transition Unit on the 200 Series Switchers includes items you'd expect to pay extra for - but don't with ISI: 'flip-flop' mixer with auto mix and cut bar, colorized DSK with edging, master fade-

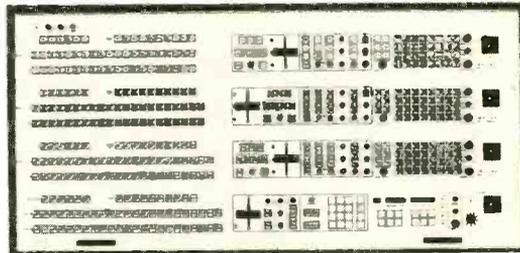

ISI 200-3 Production Switcher

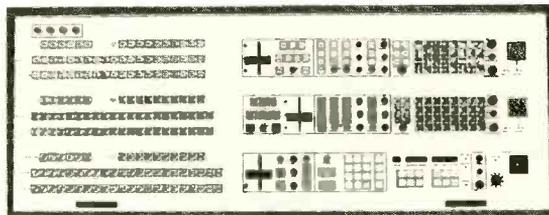

ISI 200-2 Production Switcher

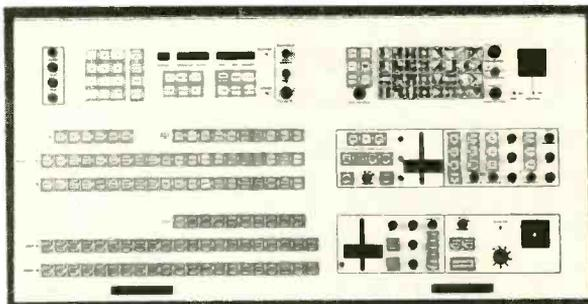

ISI 200-1 Production Switcher

to-black with pulse processing, and our exclusive 8 position pointer. A 200 Series Switcher is a total package.

**FACT:**

Our optional A.P.E. (Automated Production Effects) offers storage and retrieval of manually executed control panel functions. And with vertical interval recall of 3840 events per disc in our dual 'floppy' system, retrieval is smooth, fast, and flawless.

**FACT:**

Whether your facility is a broadcast operation, production house, or industrial user, and no matter what your application - production, remote, or post production - we've got the 200 Series Switcher that's just right. All with ISI's two year warranty and total commitment to service.

Call us toll free for more information and the name of your nearest authorized ISI professional video products distributor.

Available in NTSC & PAL.

**i**nnovative **S**witching **i**deas.



**INDUSTRIAL SCIENCES INC**

P.O. Box 1495 / Gainesville, Florida 32602

Toll Free: (800) 874-7590

Florida Only: (904) 373-6783

## NAB SHOW IN PRINT

faces: interactive (two-way) and active (one-way). The interactive is designed for VTRs and similar sources that need to be constantly monitored, while the active is for programmable sources such as complicated mix/effects through an E-MEM. The system can handle 14 interactive sources and 14 active sources.

Videomedia introduced a new post-production A/B roll editor, the Z6000A. Its use of Z-80 microprocessors at each interface makes the system one of the lowest-priced A/B roll editors with full switcher control, according to the company. In addition to three-machine control, the Z6000A features split edits, auto extend, auto tag, select in and out points on the fly, full VTR status verification, random search and go to functions, and four Z-80 microprocessor controllers. Prices start at \$22,500. Videomedia stressed the ability to upgrade any of its previous Z6 editors to the Z6000A format.

Jatex also introduced a low-cost A/B roll edit controller, the VSEC-62TMX, compatible with most one-inch and ¾-inch machines without modification to the VTR. The VSEC-62TMX features its own time code generator, Scene-Dex, which Jatex touts as a cost-efficient way of achieving frame-accurate automated editing. A built-in LED status display indicates operating modes without a CRT or monitor. The system starts at under \$15,000.

Sony introduced a new three-machine editor, the BVE-3000. This editor has a number of built-in features that make it a very flexible controller. A built-in sync indicator alerts the operator when the time code from the playback and record machine are offset. A SMPTE time code generator is included, and an optional module reads VITC. The editor has the ability to

determine in and out points on the fly. It also has built-in switcher effects for preset cut, dissolve, or wipe. A port controls an external switch/effects generator.

**For more information:** Ampex ACE, 539; CVC Lightfinger, 540; CMX software improvements, 541; Convergence ECS-104, 542; Datatron Smart Scan™, 543; Fernseh Mach One software, 544; UNEMCO Edit Master, 545; Videomedia Z6000A, 546; Jatex VSEC-62TMX, 547; Sony BVE-3000, 548.

### Smaller editors aim for flexibility

The two-machine ENG-type editors kept pace with their big siblings in flexibility and ease of operation, while keeping the cost competitive.

Cezar International came to Las Vegas with the intention of conquering the small controller market with extremely low-cost units. The Controller is a microprocessor-based unit that offers most of the capabilities of more expensive models at a quoted price of \$1995. It operates with ¾-inch and ½-inch machines.

Cezar had two other editors at a higher price, but still under what comparable editors were going for. The Executive runs \$4495 and is able to produce an edit decision list that is compatible with other large post-production auto assembly systems. The top of the Cezar line is the editing Center, which starts at \$5295.

Cinema Products brought an inexpensive edit controller called the Newsmaker. In addition to its low cost, about \$3700, it is designed for the inexperienced operator. The controls are few and Cinema Products says it takes only about five minutes to learn how to use the editor. But the editor is flexible enough that no editing functions are lost to an experienced operator.

Panasonic continued to make inroads

into the U-Matic market with a new controller to go with its heavy-duty professional ¾-inch machines. The NV-A970 is a microprocessor-based unit that offers the features of most editors in its class — it reads SMPTE time code and control track pulses and has edit point trim and variable search speeds. The controller can also interface with Panasonic's VHS VCRs. The cost of the controller is \$5250.

When is an editor not an editor? When it's a Sony BVU-800 VTR. This U-Matic Machine has a microprocessor based editor built-in, eliminating the need for a separate controller.

The BVU-800, when linked with another BVU-800, automatically becomes a full editor. With the addition of a time code generator/reader a fully integrated editing system is formed.

Cezar International and Datatron are both marketing an off-line editor that is a two-source controller but can produce an edit decision list as if it were a three-machine controller. The decision list is compatible with most of the major computerized editing systems. Cezar, who designed the editor, markets it as "The Decision Maker." Datatron markets the controller under the name of "Editt/Plus™."

The crossover between film and videotape seemed to take on added weight at this year's convention. A number of companies were mentioning the advantages of film-to-tape transfer, but Harris and CMX/Orox showed products expressly for film editing using electronic systems.

CMX/Orox calls its system the FLM-1 film editor controller. Through a series of interfaces, the system actually controls the film transport and either generates an edit decision list with edge numbers and instructions for the negative cutter or feeds directly to a VTR for cut-only edits.

Harris took a more traditional approach using the EPIC editor. The film is transferred to tape and then edited. The

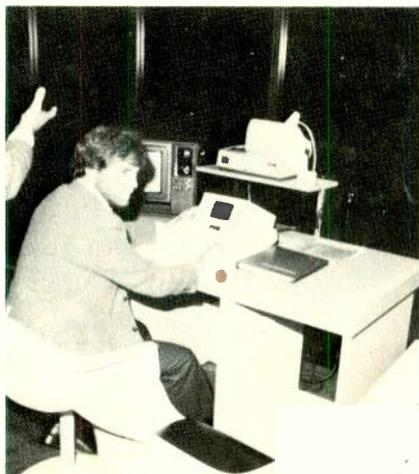

CMX's Edge system received good attention from mid-range aspirants



Videomedia's Z-6000A continues the capability's expansion in the Z80 microprocessor-controlled editors

## NAB SHOW IN PRINT

Harris system, formally called the EPIC Video Editor with Video-Assisted Film Editing, goes further than the CMX system in that it goes through a switcher to preview all the effects that would end up in the final film. An edit decision list is produced with edge numbers and instructions for the negative cutter.

**For more information:** Cezar Controller, 549; Executive, 550; Editing Center, 551; Panasonic NV-A970, 553; Sony BVU-554800, 555; Cezar Decision Maker/Datatron Editt/Plus, 556; CMX/Oroxo FLM-1, 557; Harris video editor, 558.

### Time code equipment

Adams-Smith Inc., whose products were shown in the Glentronics booth, took a total approach to time coding. The Series 2600 is a modular group of various kinds of generators and readers that can be used in conjunction with a total editing system. Included are longitudinal generator and reader, vertical generator and reader, a character inserter, a code restorer, and a sync generator.

Amtel offered two versions of the Edit Code Master, the Model 3700 and Model 3800. Both have a generator, reader, a user bit encoder, and a video character generator — all mounted in a 19-inch rack space. Both have two jam sync modes, momentary and continuous.

Datametrics had three new products in its line of readers/generators. Model 716 is a low-cost but versatile time code generator for 25-frame EBU or 24-frame film standards. The \$1980 unit syncs to RS-170A color frame standard and has an option for internal detection of color frame ID from incoming RS-170A video.

An upgraded model of Datametrics' SP-722, Model 722A, has all the features of its predecessor (generation, reading and video character insertion) plus more. It now generates and decodes SMPTE code, time, or user data and the character generator displays time or user date in four sizes with switchable background. The unit can read data from 1/20 to 100 times playback speed.

The Model 760, Datametrics' other new time code reader, has the ability to calculate segment durations, perform character insertion, and show time and user data simultaneously. It can read and display code from 1/30 to 100 times playback speed.

ESE introduced the ES 254 SMPTE time code reader. This eight-digit re-



Datatron's Vanguard system with Smart Scan™ tracks variable playback speeds

ader, which runs \$650, can display code at 1/20 to 20 times playback speed.

For-A introduced a portable time code generator, the TCG-3200, specially designed for ENG/EFP use. The TCG-3200 has a readout that displays hours, minutes, and seconds but has 32 spare bit capability so that frames will also be recorded.

Skotel showed the production model of its PTC-100 portable time code generator and reader, which was shown in prototype last year. There were some new features in the TCG-80N edit time code production generator, including measurement of sync to subcarrier phase to determine the RS-170 color field.

Sony is also getting into the VITC business with a new portable, the BVG-100. It features jam sync, color frame lock and a built-in longitudinal play speed reader. The BVG-100 is fully plug-compatible with Sony U-Matic and one-inch VTRs.

Telcom introduced a new reader and a new generator. The TCG-550 is the new generator which generates both SMPTE or EBU and sells for under \$1000. Its companion reader, the TCR-660, displays time or user bits, is remoteable, and indicates color framed time code. It is also priced at under \$1000. Telcom also introduced the 6010 high-speed time code reader, which features time or user data selection, 16 by 16 character generator, parallel time and user data display, and indication of color-framed time code.

**For more information:** Adams-Smith Series 2600, 559; Amtel 3700, 560; 3800, 561; Datametrics 716, 562; 722A, 563, 760, 564; ESE ES 254, 565; For-A TCG-3200, 566; Skotel PTC-100, 567; TCG-80N, 568; VITC unit, 569; Sony BVG-100, 570; Telcom TCG-550, 571; TCG-660, 572; 6010, 573.

### Synchronizers

Adams-Smith introduced its Tape Synchronizer Model TS-605, which is an audio editor for television sound. The Model TS-605, which incorporates SMPTE/EBU time code, allows for the control of a master and two slave transports and boasts synchronizing resolution of one-hundredth of a television frame.

BTX brought its new Shadow System, an intelligent controller and synchronizer for audio and video tape machines. The Shadow is compatible with most audio and video editing systems and interfaces with ATRs, VTRs, mixdown consoles, and commercial minicomputers.

Control Video's latest offering was the CVC synchronizer, a two-machine microprocessor-based system that can expand to 32 machines with the addition of intelligent controllers. The CVC synchronizer can sync up machines on a frame-by-frame basis or can create and maintain an offset in all modes.

The Elector TCS Mk I time code synchronizer, new from E&O Systems, is a SMPTE/EBU time code system that can work in drop frame and non-drop frame mode intermixed. It features adjustable frame rate, dropout protection, and code error indication.

MCI introduced the JH-45 Autolock

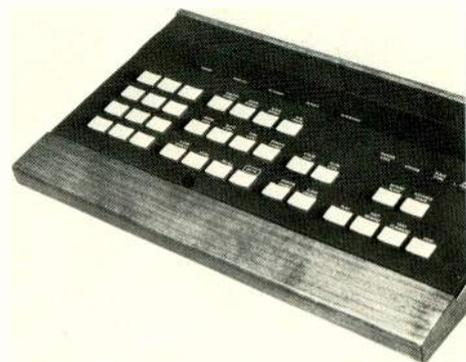

BTX's Shadow System synchronizer control system

# Compare

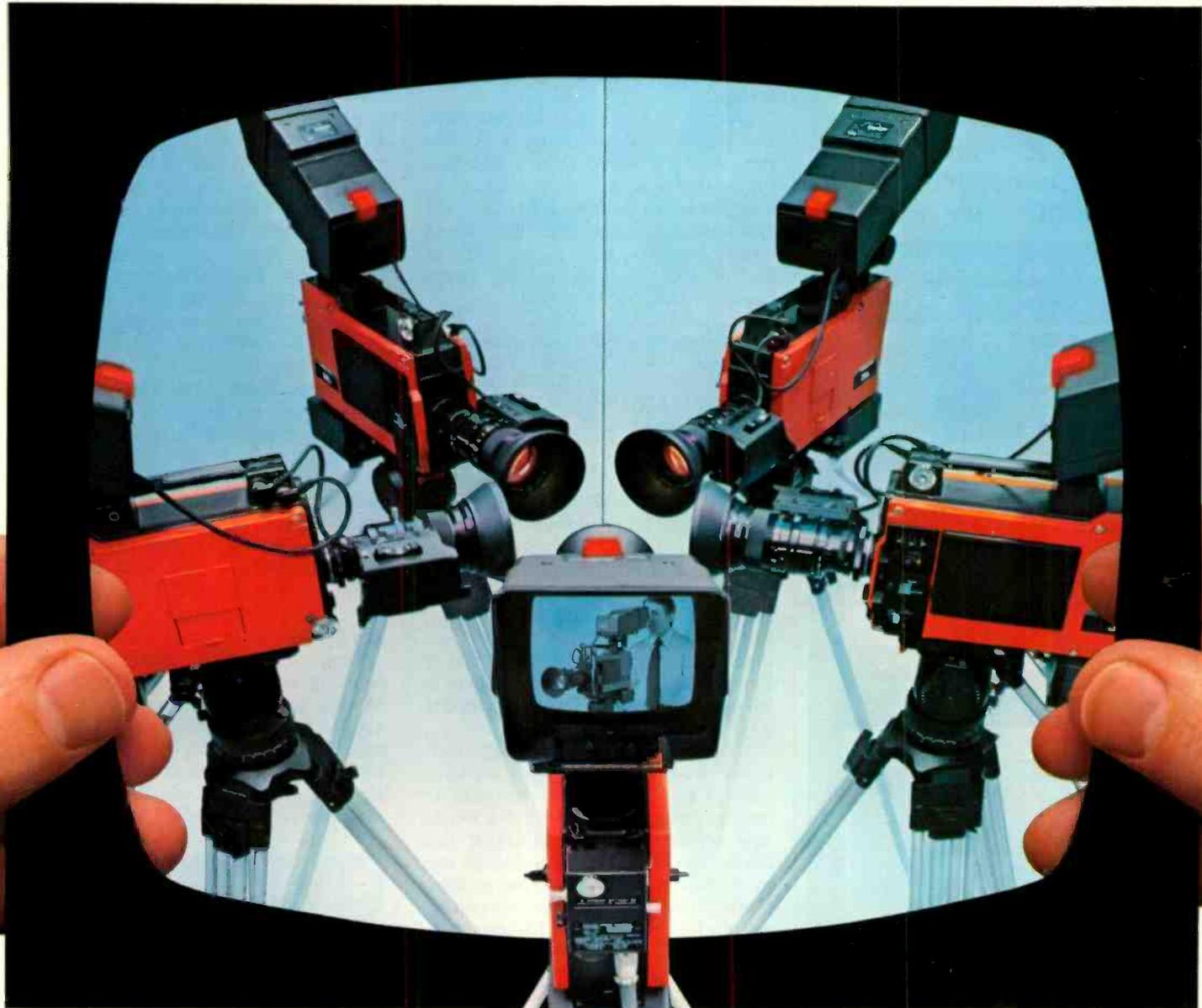

JVC's Professional Video Dealers want you to compare the newest member of the KY family of 3-tube color cameras to any other camera you may be thinking of... and to others you may have eliminated because of their high prices.

#### COMPARE PERFORMANCE:

The KY-2700 holds registration specs to a tight 0.1, 0.4, and 0.8%, for crisp clean pictures. That's stability!

The KY-2700 has dual-edged vertical and horizontal contour correction for the detail and sharpness you require, 500 lines resolution, and for virtually noise-free video, 54db signal to noise. That's performance!

#### COMPARE FEATURES:

A fast, 14:1 Servo zoom lens, Automatic Beam Control (ABC), Automatic White Balance with memory, Automatic Black Stabilizer circuit (ABS), a low 18 watt power consumption for extended battery operation, "Instant On"

performance. And much more. That's a lot.

#### COMPARE VALUE:

No other professional 3-tube color camera can match these specifications at a price even near the KY-2700.

That's a pleasure.

Compare it at your JVC Professional Video Dealer NOW!

For more information,

**call toll-free 800-821-7700, Ext. 7005.**

(in Missouri, 800-892-7655, Ext. 7005.)

Or write US JVC Corp., Dept. BME 6/81  
41 Slater Drive, Elmwood Park, NJ 07407.

Available in Canada from JVC  
Canada, Inc., Ontario.

## The new KY-2700

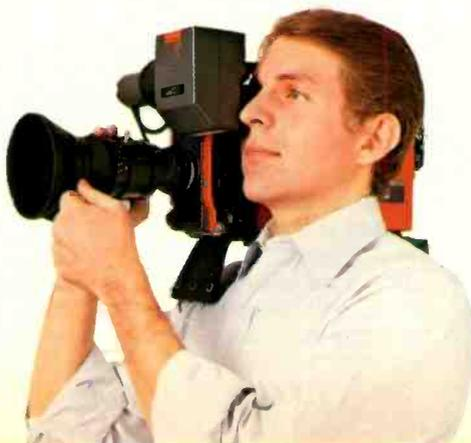

**Your choice.  
Now. JVC®**  
US JVC CORP.

Circle 156 on Reader Service Card

# SAVE YOUR TUSH with our T.U.S.H.\*!

Now Tentel has 3 products to make your video tape recorders work right

## 1 TENTELOMETER® tape tension gage



If you don't have a TENTELOMETER® for measuring tape tension, you're in worse shape than you know! Thousands are in use throughout the world! Send for our 16-page instruction manual.

## 2\* TENTEL U-matic Spindle Height (T.U.S.H.) gage



Save your valuable tapes from edge damage and binding and breakage problems simply and easily. "Greatest thing since soap," says one customer. U-matic now, BETA and VHS soon.

## 3 TENTEL TIMER hour meter



For measuring the number of hours of "run" time to allow preventative maintenance to be performed to prevent down time.

Send or call for information and prices on the complete Tentel line. We want to help. We've already helped thousands.

Our toll-free number is

**1-800-538-6894**

(U.S. not including California)  
8 a.m. - 5 p.m. Mon. - Fri.

**TENTEL 1506 Dell Avenue  
Campbell CA 95008  
(408) 377-6588**

Circle 157 on Reader Service Card

# NAB SHOW IN PRINT

SMPTE/EBU generator/reader/synchronizer and autolocator. The JH-45 syncs to most machines, has an offset of up to 24 hours, and allows user bit insertion.

Quintek Inc. featured its new unit, the Q-Lock 3.10 synchronizer. An important step for the Q-Lock 3.10 is that for the first time, according to Quintek, a digital audio recorder (3M) has been synchronized with video. The sound quality available with digital audio is another step toward providing better audio for television programs.

**For more information:** Adams-Smith TH-605, 574; BTX, Shadow System, 575; Control Video CVC, 576; Electro TCS Mk I, 577; MCI JH-45, 578; Quintek Q-Lock 3.10, 579.

## Routing switchers learn the language

The recent trends towards multiple audio crosspoints per video crosspoint, more microprocessor control, and improved status monitoring were joined this year by a trend toward alphanumeric control panels. It seems as though just about every manufacturer of routing switchers now offers some type of English-language readout or display to tell operators that VTR 1 is dedicated to STU B rather than 135 to 06.

Utah Scientific, one of the pioneers in the development of more sophisticated status and control adjuncts to routing switchers, introduced a whole new series of such products at this NAB. The CSP-1610 is a control and status panel for a 10- or 20-bus system. It offers 1600 name and number combinations for sources and a 16-key touchpad for programming the system. Large LD displays are easily read. A full matrix display, the CSP-16160, features a second four-character display to indicate presently assigned output buses. Up to 160 outputs can be controlled, and the system can also be programmed as a multi-bus panel for controlling any number of randomly assigned buses. (A similar approach has been made available to production switchers through the use of Utah Scientific Source Display Strips — four-character mnemonic display strips that can be added to production switchers to show assigned sources.

Another new option for Utah Scientific AVS-1 switching matrices is a hard-copy event logging circuit card, the HC-1. This card drives a standard line printer and will log all events. If an invalid setup is ordered by the operator, the card will maintain last valid setup, but will print a record of the incorrect order. Two other new options include the SC-150 Supervisory Control Panel for status and control of a full 160 by

160 A/V system and the PDS-1 Scanner/Alarm Circuit, which scans 36 voltages and currents to determine that each card in the system is operating properly. Another new card, the AF/OR, can be programmed automatically to switch associated signals in a follow-mode with the video.

A new company to NAB was AVL Digital Ltd. Working from a basic line of products acquired in a takeover of Richmond Hill Labs, the company, a member of the McCurdy Group, debuted its AVS-100 series A/V routing switchers. This is a broadcast-quality system using a modular design based on a 10 by one building-block card approach. The design is output-oriented and can be configured in multiples of 10, building towards a 26-output bus maximum. There is one audio and one video output per bus. A BCD parallel interface makes the basic system easy to automate.

AVL explained its Universal Alarm Annunciator system, designed for smaller studios. Up to 44 input lines are monitored for failure detection. Audible alarms are provided at multiple locations and distributed for video display. A hard-copy printed record is also made.

Image Video, Ltd. introduced a new series of alphanumeric control panels. Models include a desktop CP-1, and about a dozen other rack-mountable CP models. The wide number of configurations provides for a high degree of customizing. Some panels need not be alphanumeric or A/V, and can be

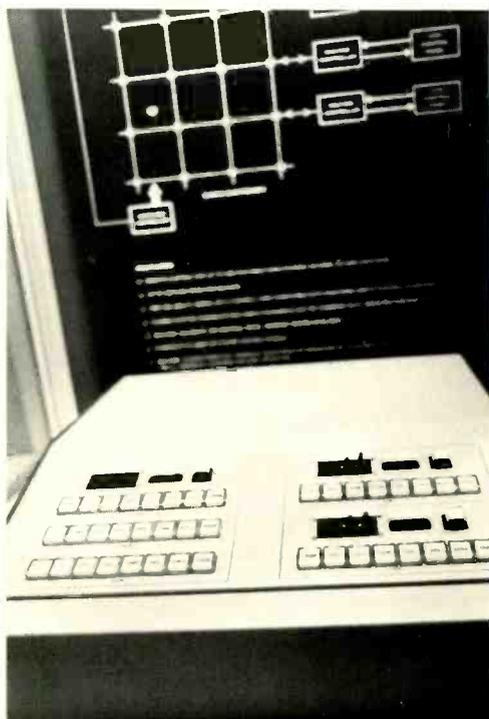

Dynair's line of routing switchers now includes the System 23 data routing switcher which, with the System 21 video router, leads to a complete machine control system



# TV test equipment from the inventors of the Plumbicon<sup>®</sup> tube.

At long last a new, reliable source of TV test equipment. One that offers fast, predictable delivery. One with a name all the world trusts—Philips. Four quick examples:

## PM5565 Waveform Monitor

Enjoy the luxury of examining one line and one field at a time. On top of this, there's a convenient front probe input so you can use the monitor as a troubleshooting oscilloscope.

## PM5567 Vectorscope

If you want more accurate decoding and the ability to have an external reference from composite video signals, choose our vectorscope.

Both waveform monitor and vectorscope mount side by side, fit all existing hardware and use less power than the competition.

## PM5539 Color Analyzer

Take it on a quick trip through your studio or control room and adjust all monitors to the same color temperature in a matter of minutes.

With four different memories, there's no problem in quickly calibrating four different phosphors.

Variable full-scale, from less than set up to more than reference white, allows measurement of color tracking as a function of APL.

## PM5534 Color Pattern Generator

Our universal pattern contains all the signals needed to verify overall system operation—directly from the picture. No wonder virtually every set manufacturer uses our pattern for their TV set alignment.

Of course our TV test equipment line doesn't end here. Today Philips offers a wide range of equipment including sync and pattern generators, VITS generators and analyzers, and TV modulators and demodulators.

For nationwide sales and service information call 800-631-7172, except in Hawaii, Alaska and New Jersey. In New Jersey call collect (201) 529-3800, or contact Philips Test and Measuring Instruments, Inc., 85 McKee Drive, Mahwah, New Jersey 07430.

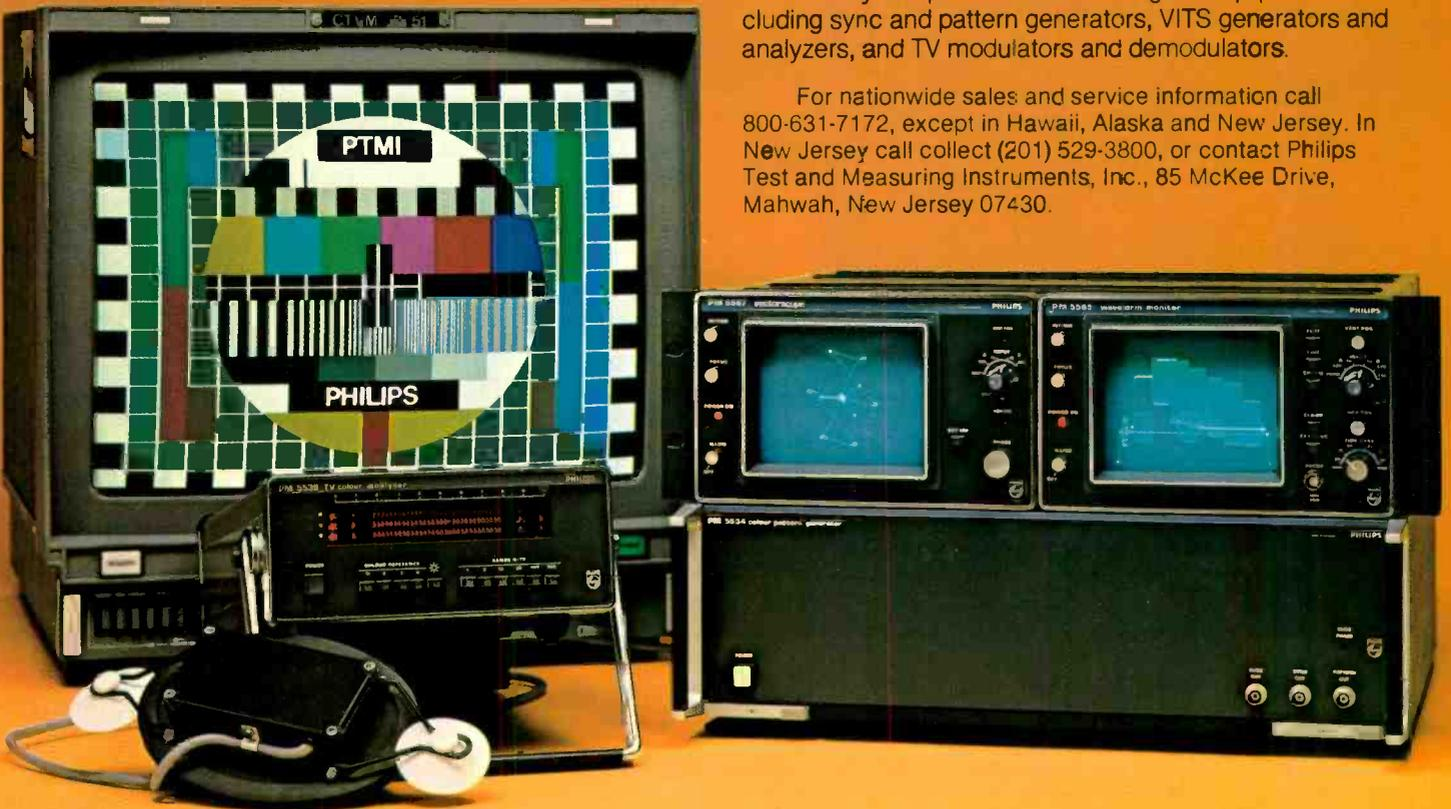

# Philips, of course.



Test & Measuring  
Instruments

# PHILIPS

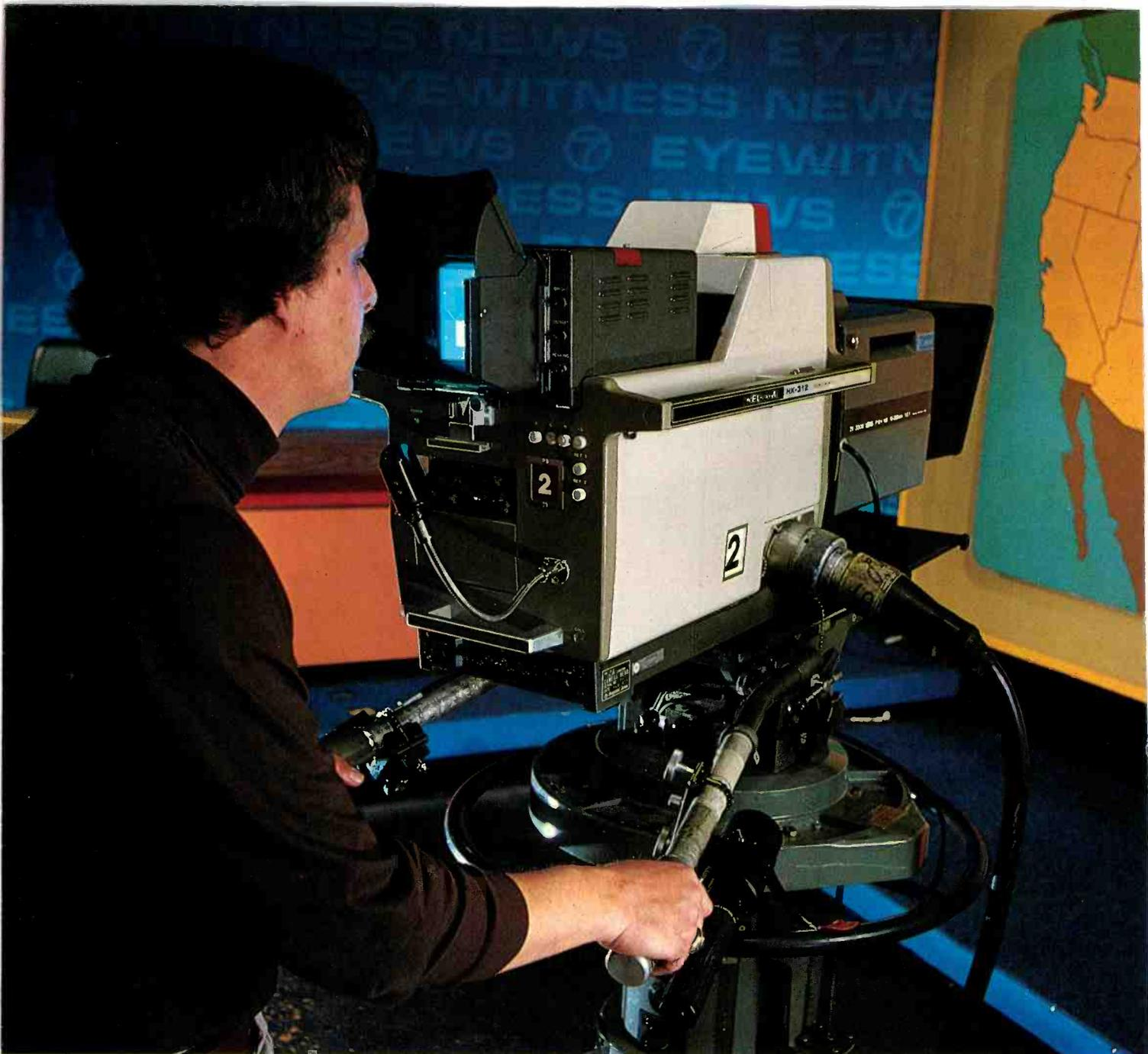

## Computer set-up and triax too

Today, broadcasters are classing computer setup and triax as necessities. Ikegami offers you a choice of two such cameras. Both are proven in the studio and field.

- The HK-312, with 1¼-inch pickup tubes, is a proven computer setup camera. More than 100 are in service throughout the ABC Network, at WGBH, and at other major stations.
- The HK-357A with 1" diode gun pickup tubes offers the same high standard of performance along with the convenience of field capability.

Both are extremely stable cameras that can be operated manually. And both accept computer control for automatic setup for on-air readiness in 45 seconds.

Both cameras can be used with multi-core cable. With triax the cameras can be a mile from their base station.

Of course, in colorimetry, automatics, circuitry excellence, and range of options, both are incomparable. But seeing is believing. Experience a demonstration soon at Ikegami Electronics (USA) Inc., 37 Brook Avenue, Maywood, N.J. 07607; (201) 368-9171. West Coast: 19164 Van Ness Ave., Torrance, CA 90501 (213) 328-2814; Southwest: 330 North Belt East, Suite 228, Houston, TX 77060 (713) 445-0100; Southeast: 522 South Lee St., Americus, GA 31709 (912) 924-0061.



# Ikegami

## NAB SHOW IN PRINT

single- or multi-designation types. Control is over coax cable (optionally over audio cable) using standard eight-bit word serial communications. Image Video also discussed a large 200 RAM event system that can address its routing switcher for automation. With an optional disk system, up to 4000 events can be stored.

Grass Valley showed a new line of alphanumeric control panels for its 440 Series routing switcher system. The new panels are easily adapted to earlier 440 systems since they will translate the numeric tally pulses into the new alphanumeric display. Extensive error reporting capabilities are built in, with error messages displayed on the "in-use" portion of the panel. Various models of the panels are available, including single-bus and X-Y control panel types.

Dynair, looking beyond the control panel, introduced a new Data Routing Switcher, System 23. While the new system is compatible with Dynair's System 21 A/V router, its primary function is to handle machine control signals in RS-422 or 423, though the system is compatible with RS-232.

It is designed on a building-block approach, expanding in 10 by 10 modules to a 1000 by 1000 system. The control lines are coax or duplex for four-wire serial data.

The system controller is a microprocessor communicating over serial data lines via a unique serial data bus. The system is programmable for simultaneous path switching from a master control panel, lever switch control panel, or CRT. It can also be controlled by an outboard computer. A wide variety of control options provides for redundancy. At data rates up to 256 kilobaud, machine control communication becomes highly efficient. CMOS switching, integrated circuit amplifiers, and isolation elements provide reliability.

3M introduced two models of its BCD or microprocessor-controlled routing switcher systems, Model 20X and Model 40X. The new models are part of the 6500 Series, which can be developed to include the 6500 machine control system.

The 20X is a 20 input by 20 output unit in a single frame, while the 40X is 40 by 20 in a single frame. Performance specifications are identical for the two models. Each system is expandable, with the 20X expanding in groups of four inputs and one output at a time, and the 40X expanding in groups of 10 inputs and adding outputs one at a time.

The dual microprocessor control system allows for programmed salvo switching, AFV, audio breakaway, audio only, and video only switching.



Di Tech was one of several routing suppliers to offer alphanumeric displays

The Universal Control Panel gives readout in alphanumeric notation and is touchpad-programmable in the same fashion. The dual microprocessor provides redundancy and automatic changeover in case of failure.

In addition, second audio channel for each crosspoint can be installed in the field. A third audio matrix can be added by using 3M's AX series of audio routing systems.

Other new control panels were shown by Datatek and Di-Tech, Inc. Datatek's Series 2000 Panels are microprocessor-controlled and are able to operate as single-bus or multiple-bus controllers. The control panel microprocessor communicates over an RG-59/U coaxial cable with an associated output bus microprocessor in the matrix frame. Since the panel has an RS-232 interface, outboard computer control is practicable. The panel can be programmed for AFV, breakaway, and multi-level basis.

The 990 Series control panels from Di-Tech provide for desktop and rack mounted units, also offering serial party line or eight-bit parallel BCD communication. The panels provide alphanumeric displays of source and destination. Source display can be selected by thumbwheel, or by touchpad in other models. Some of the 990 Series panels offer group select as well as preset selection through either thumbwheel or touchpad switches. Configurations are in one-bus, two-bus, and 10-bus form, with the 10-bus touchpad Model 996 priced at \$2155. A single-bus desktop thumbwheel panel is priced at \$470.

**For more information:** Utah Scientific CSP-1610, **580**; CSP-16160, **581**; HC-1 option, **582**; SC-150, **583**; PDS-1, **584**; AF/OR, **585**; AVL Digital AVS-100, **586**, SD-XX, **587**; Universal Alarm Annunciator, **588**; Image Video Ltd. control panels, **589**; GVG control panels, **590**; Dynair System 23, **591**; 3M 20X, **592**; 40X, **593**; Datatek Series 2000 control panels, **594**; Di-Tech 990 Series, **595**.

### Digital video effects: can't stand still

Not all the unusual twists and turns in digital video effects were visible on a television screen this year. Ampex entered the fray with a major new system they labeled ADO. (Those readers who attended the Ampex exhibit may recall the system's name as Merlyn, but it was subsequently dubbed ADO, Ampex Digital Optical.) ADO instantly placed Ampex in direct competition with MCI/Quantel, Grass Valley Group, NEC, and Vital. One of ADO's chief shots across the bow of the competition was the ability to rotate images simultaneously on all three axes, giving the appearance of true three-dimensional rotation.

MCI/Quantel returned fire almost instantly. Overnight, they reprogrammed a portion of the DPE-5000 software to produce an effect very similar to the 3-D rotation. While the result of the reprogramming was not perfect, it clearly succeeded in demonstrating the power of the software. Given the little more than the 10 or 12 hours they had between Sunday night and Monday morning, Quantel's bead may very well get more accurate.

When it came to shots from the blind side, DCC — the business automation people (BIAS) — took the prize. With few people looking over their shoulder, DCC joined up with a small company headed by John Davis, formerly with Vital, and issued Digifex, a small digital video effects generator aimed at the small-market station.

While true technological breakthroughs are rare, it appears that Ampex has achieved just that with its ADO system. Broadcasters who viewed the ADO output were clearly impressed, not only by the virtuoso performance of ADO but also by the news that the system would sell for less than \$100,000.

The use of the phrase "optical effects" is intended to convey the notion that ADO brings to video the quality and flexibility film obtains through the use of opticals. With digitally encoded

# WORDS & PICTURES

Introducing Vidifont® Graphics V. The character/graphics system with unique technological innovations.

Everything you need to combine operator ease with artistic beauty. Total creative freedom. A rainbow of colors. An infinite variety of animated effects. Plus multi-user access.

Graphics V.™ Sophisticated. Easy to use. Practical. Flexible. Everything you'd expect from the great Vidifont tradition.

## THE FACTS SPEAK FOR THEMSELVES

- Eight full-set fonts. Up to 48 in resident memory.
- 256 automatic kerning combinations of intercharacter spacing.
- 4,096 colors in resident collection.
- 16 color "quads" instantly on-line.
- Backgrounds. Created independently of foreground character plane and enlarged or reduced.
- Capability to mix italics and conventional characters on the same row.
- Edge types include border, shadow and outline.
- Edging may be extended in any direction. Up to 256 scan lines.

- Compact component design for mobile applications, built-ins, or custom console.
- User stations and disk storage may be located hundreds of feet from main electronics.

- Up to 8 keyboards can operate simultaneously.
- Simultaneous on-line accessibility provided by two independent, full-function, high resolution channels.
- Over 35 pages instantly accessed on-line.
- Unlimited additions from disk.

- Character appearance enhanced by edge polishing to eliminate objectionable effects of aliasing.

- Exclusive area composition permits composing and editing in one section of the display without disturbing adjacent items.
- Free-form manipulation through double-buffered frame store. Character placement not limited by row-structured page.

- Margins can be released in any or all directions. Displays can "bleed" or run off the edge of the screen.

- "Cut and paste" capabilities.
- Multi-planar character and row stacking.
- Unique restore function permits examination of sequenced displays. Graphics V steps back and restores previous display for comparison.

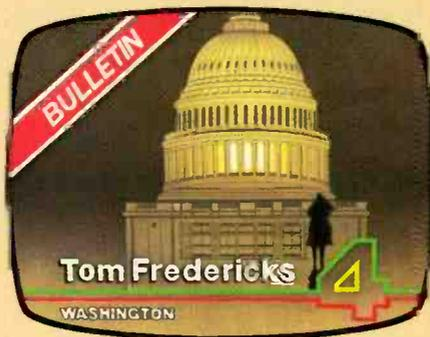

## THE WIDEST ARRAY OF DYNAMICS

- Rolls/crawls. 196 speed/direction combinations.
- Up to four displays may be moved in any direction simultaneously.
- Ripple-on/ripple-off. Character-by-character appearance or removal at any of 127 rates.
- Timing relationships may be examined event-by-event, re-arranged, re-timed or otherwise adjusted.

## EASY TO USE

- Operator-oriented design. Prompted and menued entries. Logically laid out keyboard.
- Independent color edit outputs for each channel.
- Standard setup always available. When a different, often-used format is required, operator loads in a "user environment." Fonts, colors, channels, levels, tabs, margins, etc. are automatically configured and placed on-line.
- Self-test and diagnostics.

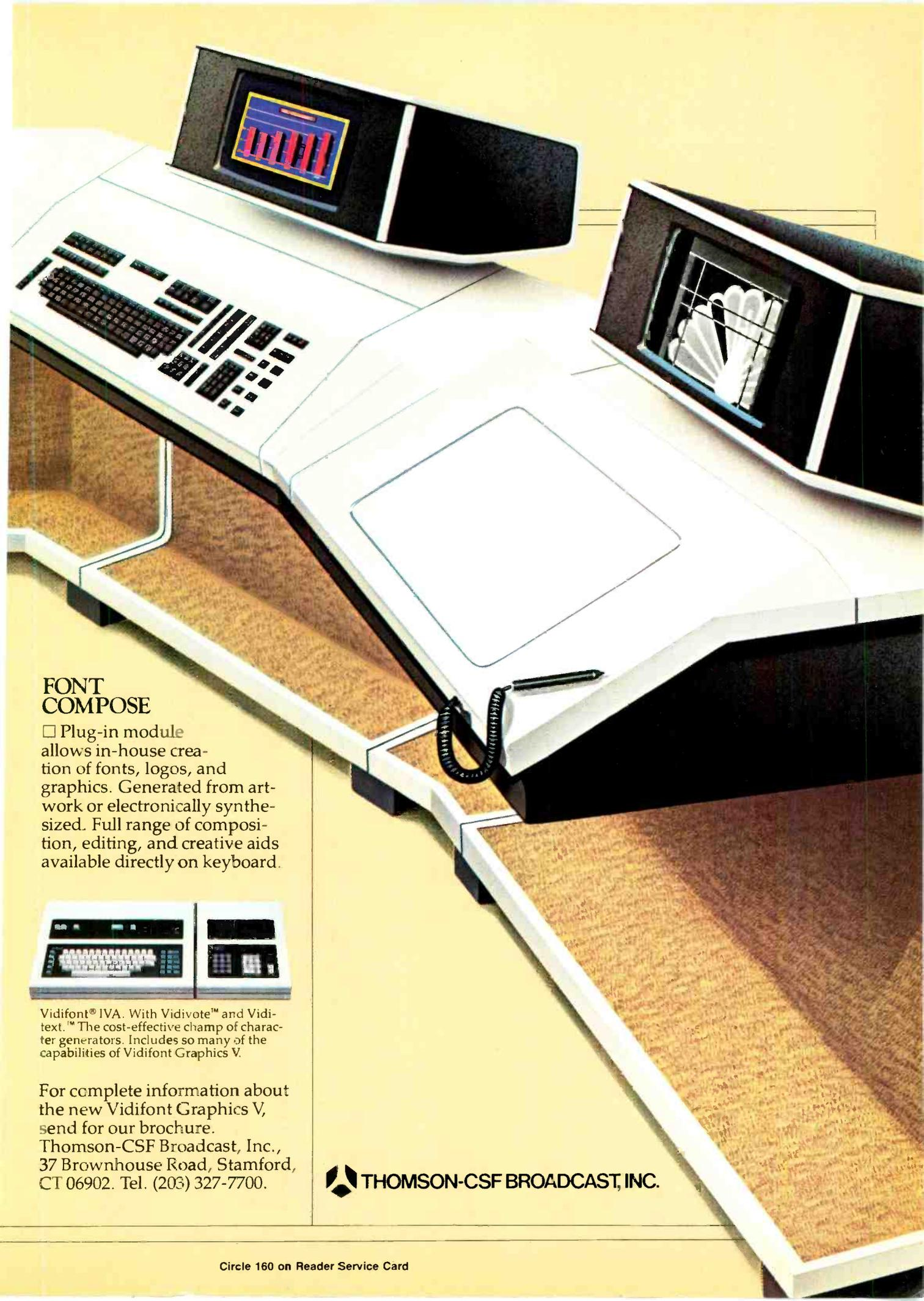

## FONT COMPOSE

□ Plug-in module allows in-house creation of fonts, logos, and graphics. Generated from artwork or electronically synthesized. Full range of composition, editing, and creative aids available directly on keyboard.



Vidifont® IVA. With Vidivote™ and Viditext.™ The cost-effective champ of character generators. Includes so many of the capabilities of Vidifont Graphics V.

For complete information about the new Vidifont Graphics V, send for our brochure.  
Thomson-CSF Broadcast, Inc.,  
37 Brownhouse Road, Stamford,  
CT 06902. Tel. (203) 327-7700.

 **THOMSON-CSF BROADCAST, INC.**

# All Similarity Between A Live Performance and

## BARCO MONITORS

# Is Purely Intentional!

With Barco, reliability is more than a word, it's a commitment . . . backed by the most comprehensive customer support program in the industry. If you ever need service, our factory trained engineers are on hand 24 hours a day. If you need a part, we'll ship it out the same day you call, because they're all in stock. Of course, with Barco, you get the best professional color monitor

money can buy... at a competitive price... and they are **IN STOCK — SHIPPED THE SAME DAY YOU ORDER.** Today, more than ever before, you need the total Customer Support Program that only Rohde & Schwarz offers.

Contact us at 14 Gloria Lane, Fairfield, NJ 07006 or call (201) 575-0750. Telex 133310.

## ROHDE & SCHWARZ SALES CO. (U.S.A.) INC.

Sole representative for Barco Professional Video Systems Dept. in the United States.



## NAB SHOW IN PRINT

component video, the ADO system is able to alter the geometry, size, and perspective of video images. The image can be defined as a three-axis, solid geometric shape, rotated a full 360 degrees along all three axes simultaneously while it is expanded or compressed continuously. Compression to zero or expansion up to eight times normal without visible picture degradation is possible. At the same time, the geometric center of the object can be moved to any part of the raster or off the screen altogether.

In the case of an image that is defined as transparent (like a film slide) flips, tumbles, etc., are completed for the entire picture and all of its elements, creating the effect of turning the slide in realtime, real world conditions.

Stop, start points, rates of movement, expansion, and compression are programmable. Up to 24 picture manipulations can be linked in sequence. A joystick control gives the operator basic control over movement, while the executive routine can be altered to smooth out or proportion the steps. Storage of effects sequences is on floppy disk.

Multiple control panels can be employed, though only one may be on-line at a time. Live or videotaped frames can be grabbed for manipulation. Output is either RGB or encoded NTSC.

The DPE 5000 series of special effects systems from MCI/Quantel exhibited a number of significant changes including new effects, new models, new configurations, and new control

options. Perhaps the best news from Quantel is the DPE 5000/SP (Special Performance) unit. Priced at less than \$65,000, this single-channel system has many of the features from its bigger sibling — such as infinite compression and two axis squeeze.

The SP electronics are housed in 8¾ inches of rack space. The control panel is similar to the DPE 5000 panels and has seven preselect keys. There is a mini version of the "Shot Box," an option introduced by Quantel at IBC, that has 20 keys for execution of up to 40 preset effects.

"Shot Box," making its U.S. debut at NAB, is a special control panel with 35 keys plus a "shift" key that delivers up to 70 factory-programmed effects. The user can select from a standard inventory of 700 effects, assigning any desired 70 to the keys. To obtain full access to the "Shot Box" option, the user must have the DPE 5000/Plus with the Autosequence™ option.

The user of this \$10,000 option does not have to assign all 70 effects. Some key positions can be reserved for user-created effects that the user wishes to call up repeatedly.

Another addition to the DPE 5000 system is a switch for the delegation of control to any of several remotely located control panels. Up to four studios or edit suites can have full control panels with access to the DPE 5000 electronics.

Digifex is the name given to the video effects package offered by DCC, Broadcast Division. The unit is aimed at the small-market station and is priced at \$38,000. The assumption made by Digifex is that the small-station operation generally applies digital effects to titles, graphics, and logos and does not

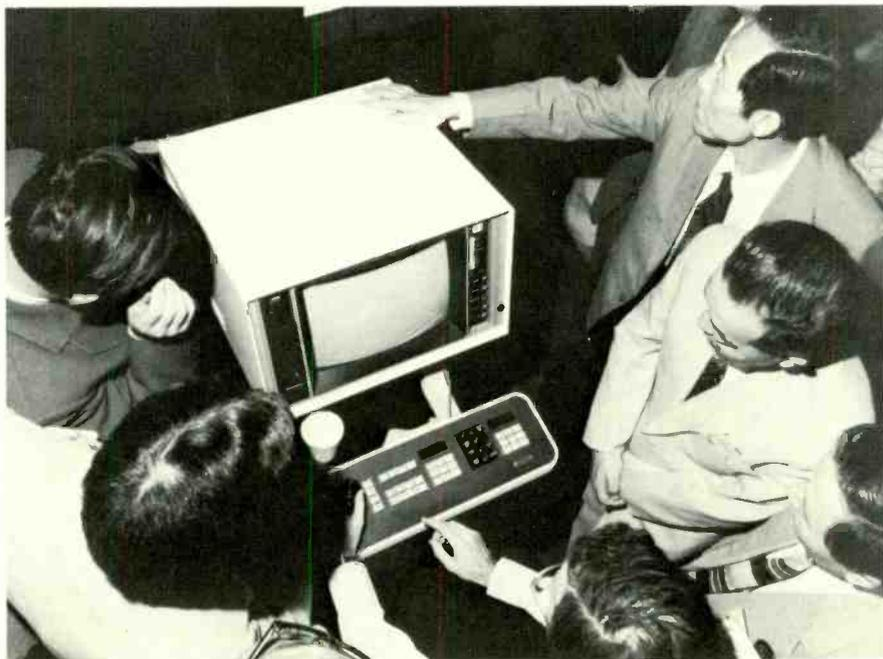

ADO (Ampex Digital Optical) system impressed broadcasters with its 3-D rotation

# SOLID, SMOOTH, RELIABLE!

## THE P-80

The All New P-80 Pneumatic Camera Pedestal—



21"-58" HEIGHT RANGE  
Compares with any unit available.

### UNPARALLELED STABILITY

Each column guided by large, precision ball bearings on four hardened-steel tracks.

### SMOOTH, EFFORTLESS CAMERA MOVES

8" Gimbal-mounted wheels and a single steering and lifting ring.

**LONG-TERM RELIABILITY** Designed without compromise for durability, easy maintenance, and minimum down-time.



30-5/8" - 50-5/8" HEIGHT RANGE

## THE P-25

Based on our workhorse P-20, improved with features from our larger models.

### ALL WELDED STEEL CONSTRUCTION

Provides rugged stability, carries loads up to 270 lbs.

### EASY ROLLING 8" WHEELS

Come standard with Gimbal-mounting.

Manufacturers of Pneumatic Camera Pedestals since 1952



TELEVISION PRODUCTS CO.

9016 Aviation Blvd., Inglewood, CA 90301  
(213) 776-3276

Circle 162 on Reader Service Card

## NAB SHOW IN PRINT

need to manipulate the entire raster in order to get creative use out of digital effects.

Input to the Digifex unit is generally from an artcard through a camera. The image stored can then be manipulated over real-time video using effects such as spin, flip, rotate, zoom, compress, fill with matte, wipe, and combinations of the above.

Speed of the transitions or repetitions can be set for automatic playback or manually adjusted across an infinite speed range set in frames and seconds. The system requires two synchronous inputs.

The control panel for the Digifex unit consists of keypad entry group for identifying effects by number and setting durations. Key clip, hue, luminance and chrominance adjustments, and a lever bar for manual execution of wipes are also available. An LED display provides information on effect speed, pattern number, image source, and mode.

Grass Valley Group's Mark II DVE system, NEC's DME system, and Vital's SqueeZoom were essentially unchanged. There were, of course, new effects shown by each of the systems — most derived by changes in program-

ming. Both Grass Valley and Vital developed further control of their systems through more thorough integration with their switching systems.

Grass Valley showed a four-channel DVE integrated with the GVG-300 production switcher. The 300 was designed from the beginning to work with digital effects, so numerous operational benefits, particularly in the area of effects automation through the use of E-MEM, were apparent. According to a GVG spokesperson, several 300s with DVE are now in the field.

Vital's main thrust was the integration of SqueeZoom with its new Saturn Series switcher (discussed elsewhere in this issue). According to a company spokesperson, PSAS will soon incorporate a bubble memory system to store up to 30 minutes of effects events. Another aspect new to the Saturn/SqueeZoom is a complete on-board diagnostic system using an Ann Arbor data terminal to monitor and report on all switcher functions.

NEC's DME was shown in operation with NEC's TAKS-1000 series switcher. While still offering the full panoply of effects and developing more constantly, the system was fundamentally unchanged. With its exclusive Actiontrak<sup>TM</sup> system, however, numerous related effects were achieved that were visible in no other system.

**For more information:** Ampex ADO, 596; DCC Digifex, 597; MCI/Quantel DPE 5000/SP, 598; "Shot Box," 599; control delegation switch, 600.

### Production switcher innovations; digital leads the way

While microprocessor control of analog switchers is, and has been, the major trend from switcher manufacturers in the past few years, Panasonic carried the process yet another step this year by showing the first all-digital video switcher at NAB.

Several years ago, Panasonic showed a digital video effects system, the 7000. While it was an object of curiosity and marvel for delegates to



Ampex's new switchers have completely eliminated front panel pots

# OPTIMOD-AM

## ROCK TO CLASSICAL...COAST TO COAST



Hundreds of stations worldwide—in every format—now process with OPTIMOD-AM. An integrated system design makes OPTIMOD-AM ideal for all formats: it guarantees uniform audio quality and uncanny definition on typical AM radios—regardless of uneven operator gain riding or inconsistent source material. And our system standout—the "Smart Clipper"—listens to clipping distortion like a human ear to definitively solve the long-standing conflict between music loudness and voice distortion.

Regardless of format, you can adjust the field-proven, stereo-ready OPTIMOD-AM system to give you the sound you've always wanted. Call us Toll Free (800) 227-4498, in California (415) 957-1067 for the name of the Orban broadcast dealer nearest you.

**orban**

Orban Associates Inc., 645 Bryant Street, San Francisco, CA 94107

Circle 163 on Reader Service Card



# The Quantel DPE 5000/SP.

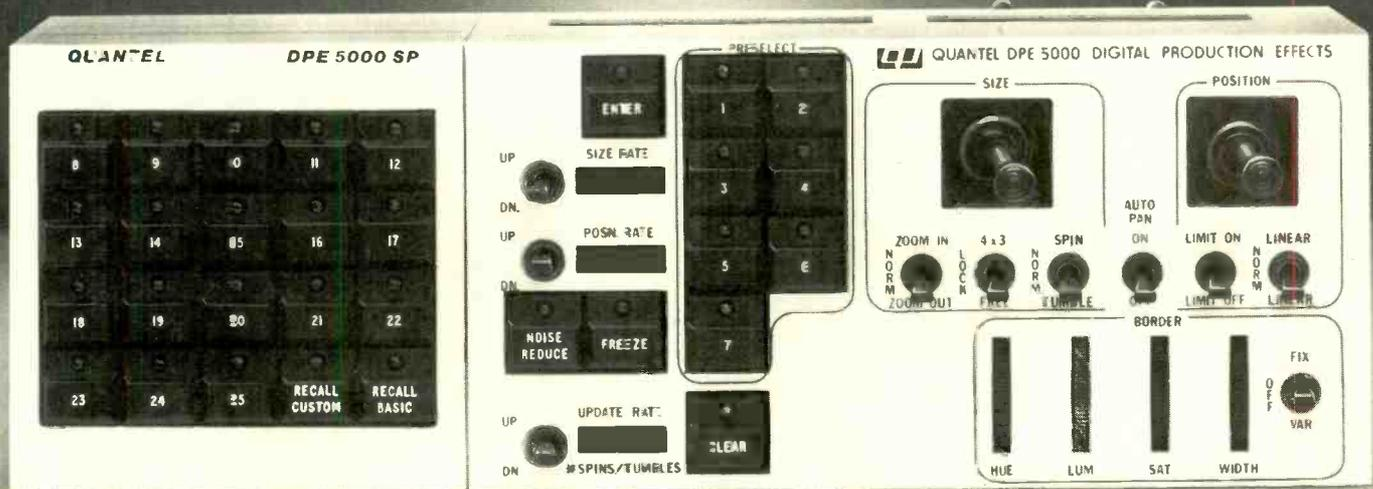

## Now every broadcaster can afford digital effects.

If you've been holding back from digital production effects because the cost seemed too high, hold back no more.

The new Quantel DPE 5000/SP makes digital effects affordable by every broadcaster.

This exciting single-channel system gives you infinite compression. Zoom expansion to 2X normal picture size. Variable picture positioning. Freeze and update. Fixed and variable border generation. Horizontal squeeze. And vertical squeeze.

Not bad for a unit that's only 8¾ inches high. Perfectly sized for your studio—or mobile unit. And with low power dissipation.

But you get a lot more. Like pre-select of picture position, size, and transition rate. A choice of linear moves or camera-like Quantel-style moves. And "Digiflip" tumble-flip.

And more yet! Over 40 moves instantly selectable at the touch of a button—18 pre-programmed effects and 25 of your own creation.

And a serial interface makes it simple to have multi-station control.

The DPE 5000/SP even includes built-in noise reduction so you can eliminate the cost of a separate noise reducer from your equipment budget.

On top of all this, you get Quantel's superior picture interpolation for the smoothest moves available.

"SP" stands for "special performance." Almost an understatement. Call your local MCI/Quantel office for details. Or get in touch with us directly at 415/856-6226. Micro Consultants, Inc., P.O. Box 50810, Palo Alto, California 94303.



**MCI/QUANTEL**  
The digital video people

MCI/Quantel and "Digiflip" are trademarks of Micro Consultants, Inc.

Circle 164 on Reader Service Card

# RELIABLE TELEMETRY

## TRL-1 TELEMETRY RETURN LINK

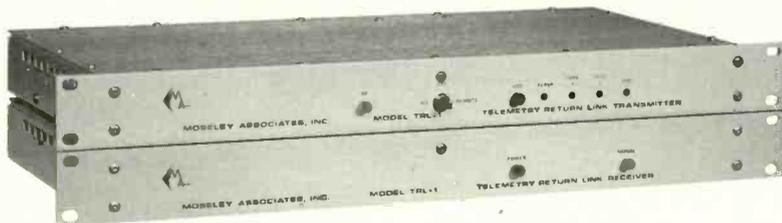

- DATA/TELEMETRY/  
VOICE TRANSMISSION
- EXCELLENT ADJACENT  
CHANNEL REJECTION
- AC/DC OPERATION

The TRL-1 telemetry return link provides a reliable means of returning telemetry information from a remote transmitter site to the control point via the Group P channels in the 450 MHz band. This avoids problems associated with telephone or subcarrier interconnections. Both transmitter and receiver use narrowband techniques to allow adjacent channel operation. The TRL-1 is the first system ever designed specifically for this application. Microphone input on the transmitter is standard; MCW identifier module with battery backup is optional.

FOR FURTHER INFORMATION PLEASE CONTACT OUR MARKETING DEPARTMENT.



**MOSELEY ASSOCIATES, INC.**

A FLOW GENERAL COMPANY  
SANTA BARBARA RESEARCH PARK, 111 CASTILIAN DRIVE • GOLETA, CA 93117  
(805) 968-9621 • CABLE: MOSELEY • TELEX: 658-448

Circle 165 on Reader Service Card

# Broadcast Production Consoles

*GREAT AUDIO STARTS HERE*

### FEATURES:

- Stereo Outputs  8 or 12 Channels
- Up to 24 Inputs  All Inputs &  
Outputs Balanced  QM-  
8P, 4 Stereo Channels standard, 0,  
2 or 6 optional  QM-12P, 4  
Stereo Channels standard, 0, 2,  
6, 8 or 10 optional.
- Input Channels:** 3 Knob EQ  
with In/Out Switch  Echo,  
headphone and Cue Send  
 Channel On and Remote  
Start  High Quality  
Conductive Plastic Faders.
- Output Channels:** 4 Balanced  Low  
Noise, Low Distortion  May be  
Stereo or Mono.
- Monitoring:** 4 Independent Monitors  
 Flexible Control Room Selection   
Talkback to Studio Muting



**QUANTUM**  
AUDIO LABS, INC.

1909 Riverside Dr., Glendale CA 91201  
Telephone (213) 841-0970

*Quantum Audio Labs is an independent manufacturer  
and is not affiliated with any retail store.*

**QUANTUM offers the following  
options for the QM-8P and QM-12 P:**  
Phantom Power Supply  104 Point  
Patchbay  8 or 12 Channel Input  
Expander.

Circle 166 on Reader Service Card

## NAB SHOW IN PRINT

that convention, the system was never thoroughly marketed in the U.S. The idea for digital video effects, however, was picked up by several other manufacturers and systems subsequently introduced by NEC, GVG, MCI/Quantel, and Vital made digital video effects accepted practice. When digital video effects manufacturers were recognized for their contribution to television arts and sciences, the Academy did not forget Panasonic's pioneering efforts and awarded it an Emmy as well.

The AV-800 Digital Production Switcher that Panasonic showed this year, will be marketed here in the U.S. this winter. The system features a 4 fsc, 10-bit sampling structure and offers the common benefits of digital processing. Regardless of the complexity of the event, absolutely no degradation to the picture is produced. Virtually no adjustments are required from setup to setup since values do not drift.

Input to the switcher is standard NTSC composite video, which is then separated into component digital video for processing. A digital video interface can be provided to a digital video processor for effects such as expansion and compression.

Standard effects with the AV-800 include 64 wipe patterns, generated by microcomputer program. The various wipe pattern formats exist on a series of plug-in "tumblers" similar in concept to music box rolls. Each tumbler is programmed for several versions of its wipe pattern, which can be selected by turning the tumbler once it is in its socket. The tumblers, which are about one inch long and half an inch in diameter, have a series of perforations that define the wipe program to the switcher. The tumbler and socket approach also permits users to order wipe patterns in any sequences that represent their versions of "most frequently used" or according to any other sense of individual priorities.

The digital nature of the AV-800 also



*Saturn Series switchers from Vital incorporate automation and digital effects*

## NAB SHOW IN PRINT

permits a wide range of new effects in addition to conventional effects. Digital filtering permits a "focus through" effect in which the foreground or background can be brought in/or out of focus in a manner visually identical to the technique used by camera operators. Because of its composite processing and built-in luminance non-additive mix approach, a large number of color-dependent effects can be achieved in addition to conventional chroma key. While the system employs only two ME banks for unlimited re-entry, a number of effects can be achieved on each crosspoint bus, including dual-split, quad-split, and penta-split wipes.

The digitizing of the video signal itself for switching represents another step toward the all-digital plant, but conventional switchers continue to rely on digital technology for control. E-MEM, PSAS, CAPS, ACTS, A.P.E., and other computer-assisted switcher systems were joined by still more offerings this year.

Ampex this year introduced an entirely new series of switchers that employ a high degree of automation. Called AVC Series, the switchers range from a single-M/E, 16-input version to a three-M/E, 32-input switcher. The largest of the series, the AVC-33, was an immediate success as CBS took delivery on one and ordered a total of nine more for installation at its network headquarters in New York and at several of its O&O stations.

The 32-input AVC-33 on display was physically smaller than the 24-input 4000H, Ampex's former top-of-the-line switcher. The AVC series has eliminated all control pots from the panel and instituted instead two centrally located adjust panels containing up/down and on/off pushbuttons. Co-located on the adjust panel is a pattern positioner. All switcher adjustments can be made from this panel with the exception of the quad split and color background functions. A memory system, STAR, stores the setup for each of the system's M/Es and can transfer all parameter information for a particular setup on one M/E to another.

Since the video parameter information is tied to the source, and not the keyer, the key source can be brought up on any of the switcher's keyers with perfect reproduction of switcher setup. The four setups are for two chroma and two luminance key effects.

The output of any M/E can be previewed, as can the individual buses feeding the M/E, the program bus, preset bus, and quad split system. As an option, a Preview Key System permits the preview of keys over a scene, even if the scene is on the program bus.

## FM wireless intercom headphones!

Superb, interference free, intercom up to 150 yards! FCC certified and license free. Five channels available. Comfortable & lightweight, only 11 ounces without standard 9v batteries. Soft, foam-filled, vinyl ear cushions provide excellent acoustic seal, reducing ambient noise. Interface capability with "hard-wired" systems. The TR-50 is also now available in hard hat.



- TV & Film cameramen producers, directors.
- Football coaches, assistants, spotters.
- Manufacturing personnel.
- Security personnel.
- Theatre crews.
- Language translators.
- Tour directors.

Request Bulletin-3U for TR-50 and other FM wireless models.

INTERCOM MODEL TR-50 **\$297.**

# INTERCOM

Manufactured by:

**R-COLUMBIA PRODUCTS CO., INC.**  
2008 St. Johns Ave. Highland Park, IL 60035  
(312) 432-7915 TWX: 910-692-2160

Circle 167 on Reader Service Card

## Comrex 20th Anniversary

## Building Broadcast Equipment

# COMREX

P.O. Box 269, 60 Union Avenue, Sudbury, Massachusetts 01776  
TEL. 617/443-8811 TWX: 710-347-1049

Circle 168 on Reader Service Card

## NAB SHOW IN PRINT

The AVC-33 has 70 wipe patterns, with up to 100 wipe patterns available with effects extender options. A pattern modulator unit is also available, as is an optional panel memory system that will store and recall up to eight setups plus "last setup" in order to quickly return to some preferred operating condition.

There are five models in the AVC switcher series. The AVC-33 is base-priced at \$124,000; the AVC-31 is \$112,000; the AVC-23 is \$101,500; the AVC-21 is \$96,000, and the AVC-11 is \$67,000.

Vital Industries kicked off its 1981 NAB presentation with the introduction of its "Saturn Series" system, which it claims is the "largest production switcher even built." Again, a high degree of automation has been employed in order to master this 24-input, four-M/E system.

Each M/E contains three keys (both RGB and composite types), two matte colorizers, and two color background generators. Equipped with an "endless effects" transition system, each M/E can mix, non-add mix wipe, or cut between two keys, within the key, or behind the key while maintaining or changing the color background.

The Saturn Series includes PSAS as standard for sequencing and learning events. A microprocessor control system automatically stores all switcher adjustments and values as they are made and holds the settings until they are overridden by a subsequent change. Non-standard setups are indicated automatically to reassure the operator, and an M/E clear system allows the operator to return to a neutral switcher setup whenever desired. A very useful monitoring aspect permits the channel-

ling of the preview channel back to the camera position.

While Grass Valley showed no new switching systems, it did show a new 16-input version of its top-of-the-line GVG-300. Model 300-3B, like the larger 3A, is designed to integrate E-MEM and Digital Video Effects.

GVG's 1600X, shown last year in a post-production configuration, was shown in a similar manner this year. This time, however, E-MEM was shown working with the Chyron IV character generator/graphics system. With the 1600X interfaced to the CMX editor (serial or parallel interfaces may be used) and the E-MEM addressing the Chyron, Grass Valley was able to demonstrate some significant editing features permitting the inclusion of graphics through the 1600's effects system.

Central Dynamics Corp.'s "agreement in principle" to acquire Philips Broadcast Equipment Corp. and American Data Corp. made news all by itself. Basically, CDC will broaden its line of switchers to include the American Data line while handling sales and service for the products of Philips Broadcast Equipment, which will continue to be manufactured abroad. According to Arden C. Boland, chairman and president of Central Dynamics Ltd., Montreal, the acquisition should allow for a more focused R&D program.

One of the new model switchers that CDL will bring to the deal is the CD-480 Model 10. This is a 10-bus switcher with two SFX amplifiers, each of which can control up to four video sources. The SFX module provides extended effects capability and permits preview of any transitions without affecting the on-air signal. The modules include encoded chroma keyer with

RGB keyers as options.

Two utility buses on the Model 10 supply additional key and program sources or can function as dedicated feeds to digital video effects devices. CDL showed the system interfaced with the DPE 5000. CAP, CDL's computer-assisted production system, can be applied to one or both of the Model 10's SFX systems. The base price of the Model 10, in a 16-input configuration, is \$70,000. This year, CAP was shown interfaced with CDL's smallest 480 switcher, the Model 4, which has just one SFX module.

Another new product from CDL was its Model 2170 One Bus Quad, quadruplex effects for inclusion with any small switcher. The 2170, priced at \$4500, provides five selectable split patterns derived from either three or four sources.

American Data showed no new switchers but demonstrated a new downstream keyer, Model 860. The 860 is a \$2200 option to its 400 series edge and color background generators. ADC's top of the line switcher 3106 has a new interface to permit chroma key tracking.

ACTS, ADC's computer-assisted production system for its 3100 series production switchers, now has an optional cassette-based memory system. The extended memory capacity is particularly useful for event sequence storage, and is in addition to the 80-event, on board 16K RAM.

While ISI still led with its 200 Series production switcher, introduced last year, it explained that a new switcher, the Model 904, would be ready by July. Essentially, the new 904 will be a 10-input, two-M/E, switcher based-priced at about \$15,000. According to a company spokesman, the switcher is "90 percent complete."

LIMITED  
TIME OFFER

## Trade Up To Eventide's BD955 Save Up To \$640.

If your station still uses tape delay, here's a money-saving opportunity to trade up to the Eventide BD955 Broadcast Delay. For a limited time, trade-in any tape machine and Eventide will give you an allowance of up to \$640 towards the purchase of the BD955—the broadcast delay that breaks Murphy's Law with no-moving-parts digital reliability.

Here's how it works: Send us any tape machine (reel-to-reel, cartridge, even cassette) in any condition, working or not. The tape machine need not be set up for delay operation.

We'll give you a trade-in allowance of up to \$640 depending on which BD955 model you select:

Trade-in Allowance	BD955 Model Max. Delay / Bandwidth
\$640	6.4 second / 15kHz.
\$320	3.2 second / 15kHz.
\$160	1.6 second / 15kHz.
Prefer the extra economy of our 7.5kHz. models? We'll still give you a trade-in allowance:	
\$320	6.4 second / 7.5kHz.
\$160	3.2 second / 7.5kHz.
\$ 80	1.6 second / 7.5kHz.

This offer ends September 30, 1981, so see your Eventide dealer soon, or call Eventide at (212) 581-9290 for further information. Say goodbye to that old tape troublemaker and save on an Eventide BD955. You've been living with Murphy's Law long enough.

# Eventide's BD955 Broadcast Delay Breaks the Law...

## Murphy's Law.



### No Tape Loops That Snap • No Moving Parts That Fail • No Dead Air.

If something can go wrong, it will. That's the reason tape delays became common in the first place—to give the broadcaster time to delete the unexpected expletive or libelous statement.

But all too often it's the tape loop delay itself that "goes wrong." Tape loops snap while they're on the air. Or the fill cartridge that many stations use to "cover" the deleted airtime, malfunctions. And errors are frequently made by harried station personnel executing the complex process to get in or out of delay. The net result of all these is dead air ... it's unfortunate, but Murphy's Law says it's inevitable.

The Eventide BD955 Broadcast Audio Delay breaks Murphy's Law. Its digital memory replaces unreliable tape loops, so tape loop snaps are banished forever. The BD955's auto catch-up feature eliminates the need to fill the delay period. Instead, as the DUMP button is pressed, the delay instantly goes to zero and the objectionable material is deleted. Then the BD955 automatically rebuilds the delay as the program continues. This action is virtually unnoticeable to the listener. You have to hear it to believe it.

With the auto catch-up feature, getting in and out of (and back into) delay is no problem. In fact, the BD955 is so reliable, many stations simply leave it in-line around the clock.

And there's even more value built into the BD955. When not being used as an obscenity delay, the unit does double duty as a valuable production tool. Any delay from 6.5 milliseconds to the unit's maximum can be set from the front panel, so you can get a wide variety of reverb, "doubling" and other vocal and musical production effects.

The Eventide BD955 is available with maximum delays of 1.6, 3.2 or 6.4 seconds and with full 15 kHz or telephone-compatible 7.5 kHz response. So you need pay only for the capabilities you need.

Before your tape loop delay fails again, get an Eventide BD955. You've been living with Murphy's Law long enough.

**Eventide**  
the next step

Eventide Clockworks Inc. 265 West 54th Street New York, N.Y. 10019 (212) 581-9290  
Circle 169 on Reader Service Card

PLAIN



There's nothing fancy about the Knox K50.

It's reliable; it's economical; it's basic; the simplest machine we make.

Come to think of it, it does have an independent preview channel... and shadow-edged characters... and a flash function... all as standard features.

Maybe it's fancier than we thought.



A DIVISION OF COMPUTER OPERATIONS, INC.  
5001-J Forbes Boulevard, Lanham, MD 20801  
301/459-2106 Telex 89-8527

FANCY fancy FANCY  
fancy FANCY fancy  
FANCY fancy FANCY  
fancy FANCY fancy  
FANCY fancy FANCY  
88888 88888



Do it with style. Better still, do it with *three* styles.

Knox calls it Multifont, and it's built into each Mod-16 character generator.

It's upper and lower case. It's accented letters. And it's resolution down to a single scan line.

It's just one of the features standard with every Mod-16.

It's also by Knox. Plain enough?



A DIVISION OF COMPUTER OPERATIONS, INC.  
5001-J Forbes Boulevard, Lanham, MD 20801  
301/459-2106 Telex 89-8327

Circle 170 on Reader Service Card

## NAB SHOW IN PRINT

When finished, the 904 will include all of the features of the 902, ISI's popular mid-range switcher for studio, mobile, and field operations, and add many of the automation and effects features established in the 200 Series switchers. The 904 uses microprocessor control to reach into new levels of application, such as interface with digital video effects system, serial (or parallel) interface to computer editors, and automation.

New to the 200 Series switchers was Edifex, an extension of ISI's PolyKey concept. The new option permits the five level keys (two background and three key levels) to be combined in a single composite frame, which may be faded to black as a single function. EdiFex will also interface a 200 series switcher to digital video effects, high resolution character generator systems, and A.P.E.

The trend towards automated post-production switching was underscored by Crosspoint Latch Corp.'s introduction of two new options for its switchers. Model 6403 is a single event, programmable editor/switcher interface unit. Designed to extend the effects of edit controllers capable of A-B rolls, the 6403 has programmable start/finish points and transition durations from one to 999 frames. It will either store and execute switcher-based effect commands entered by the edit controller, or will take over from the controller to run more complicated events.

A more sophisticated 256-event programmable editor/switcher interface is the Model 7200. This microprocessor-controlled interface will walk through editing sequences with the operator, permit the setting of event durations, learn them, and execute perfectly on recall. The unit is priced at \$12,500 and interfaces with Crosspoint Latch switchers.

Echo Lab showed off the power that microprocessors can bring to low cost switchers with its SE/3, a Z-80-controlled system. The remarkable little switcher has a high degree of intelligence. For instance, the basic transition architecture automatically releases preview controls once a transition is taken to program. (Conventional flip/flop architecture is switch-selectable.) Even more importantly, however, are the various automated aspects of the system. A "learn" mode permits the system to learn up to 5000 control operations for recall. Events are stored as shots or sequences. Up to 200 single shots or any of 500 wipe patterns can be stored. Up to five sequences can be stored for recall by using the five front-panel function buttons. Each step in a sequence is learned, entered, and

recalled by pushing the appropriate button. The system should be deliverable in September and is priced at \$14,000.

Shintron introduced a computer-driven interface for use with its Model 375 switcher in post-production. The Model 575 ISEC (Intelligent Switcher/Editor Control) permits complete access to the 375 for Convergence or United Media editors. Interfaces with CMX, Datatron, RCA-EECO, and other edit controllers will be available as the programming is completed.

Shintron also introduced a compact version of its 375, the Model 372 for mobile van use. The new model retains the Shintron "Superbus" concept for its A, B, and C buses. It also includes a preset/preview bus in addition to a program bus. It will accept synchronous or a synchronous signals and contains a color background generator, downstream matte keyer, and downstream fade-to-black. The system is configured in a single housing, though it can be configured with electronics separate from the control panel.

Viscount showed no new models this year in its line of production switchers, but did raise the price of its 1107 compact switcher. The new price is \$1117 for this amazingly small (8½ by six by four inches three-input, two-bus unit. The system includes 22 standard effect patterns for wipes, mattes, and keys.

New additions to Ross 500 MLE (Multi-Level Effects) production switchers are a matrix wipe and a pattern selector. The new matrix wipe pattern generator includes 16 new effects, including a five-pointed star and an arrow-pointer. These effects can be made to spin if the 500 Series switcher includes the rotary wipe option. The new 62-pattern pushbutton selector is an option to all 500 Series switchers with the exception of the 514. It will be standard equipment on all future 504, 505, and 508 models.

The "suitcase" model switchers, such as Asaca's ASW-100 and Beaveronic's Model 705, were essentially unchanged from last year. One new limited-purpose device that made it to the show was a special effects keyer from Adwar Video Corp. This unit, the SEK-2, is specifically intended to add color titles and graphics.

**For more information:** Panasonic AV-800, 601; Ampex AVC Series, 602; Vital Saturn Series, 603; Grass Valley GVG-300B, 604; CDL CD-480 Model 10, 605; Model 2170, 606; American Data Model 860, 607; memory system for ACTS, 608; ISI Model 904, 609; Edifex, 610; Crosspoint Latch 6403, 611; 7200, 612; Echo Lab SE/3, 613; Shintron 575 ISEC, 614; 372, 615; Ross updates, 616; Adwar SEK-2, 617.



## THERE'S A NEW PRODUCTION TOOL IN TOWN



**lexicon**

**Model 1200 Audio Time Compressor automatically reduces or expands the play time of recorded material ... gives you "time-tailored" programming at the push of a button ... preserves original pitch and voice quality.**

- With the remarkable new Lexicon Model 1200, you can now eliminate time-consuming retakes to fit commercials or other material into available time slots. For the first time, you can speed up tapes or slow them down — and get broadcast-quality sound free of distortion.
- You simply connect the 1200 with virtually any variable-speed tape recorder, set the timer for the on-air or play time you require, and you're in business. Material that runs too long can be compressed up to 25%. You can time edit to add tag lines or heighten the energy of the message. In TV applications, the Model 1200 can be teamed with a variable-speed film projector and/or a videotape recorder.
- The Model 1200 — a product of Lexicon's eight years of leadership in digital audio processing — marks a breakthrough in bringing time-processed audio to the level of quality necessary for radio and TV use. Based on sophisticated computer technology and proprietary intelligent digital processing techniques, the 1200 has been thoroughly field-tested in the production of nationally broadcast commercials by 19 of the top 20 advertising agencies. Write for detailed information and application notes.

60 Turner Street, Waltham MA 02154 USA (617) 891-6790 TELEX 923468  
Export: Gotham Export Corporation, New York, NY 10014

Circle 171 on Reader Service Card

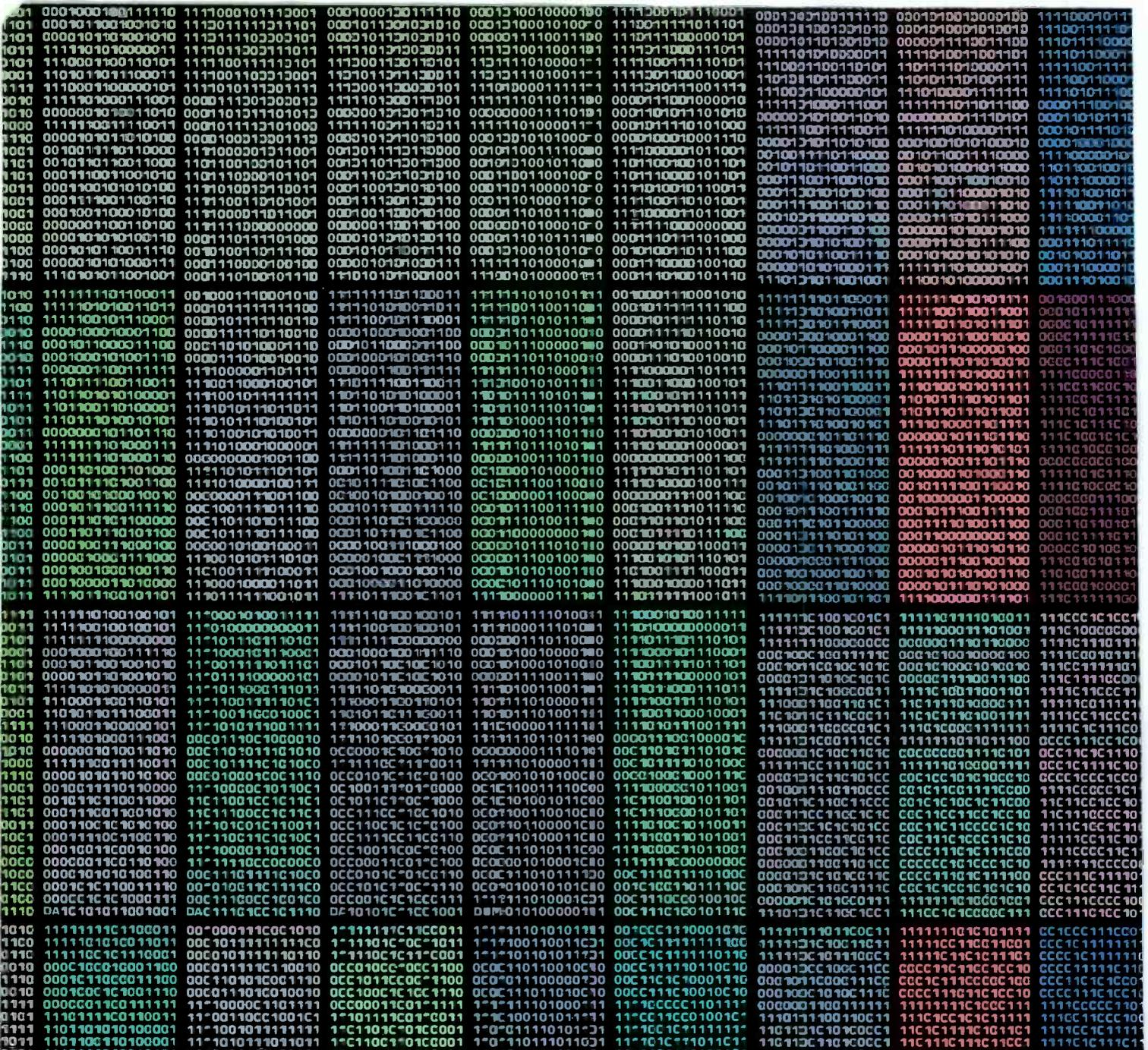

These are the first four notes  
of Beethoven's Fifth Symphony.



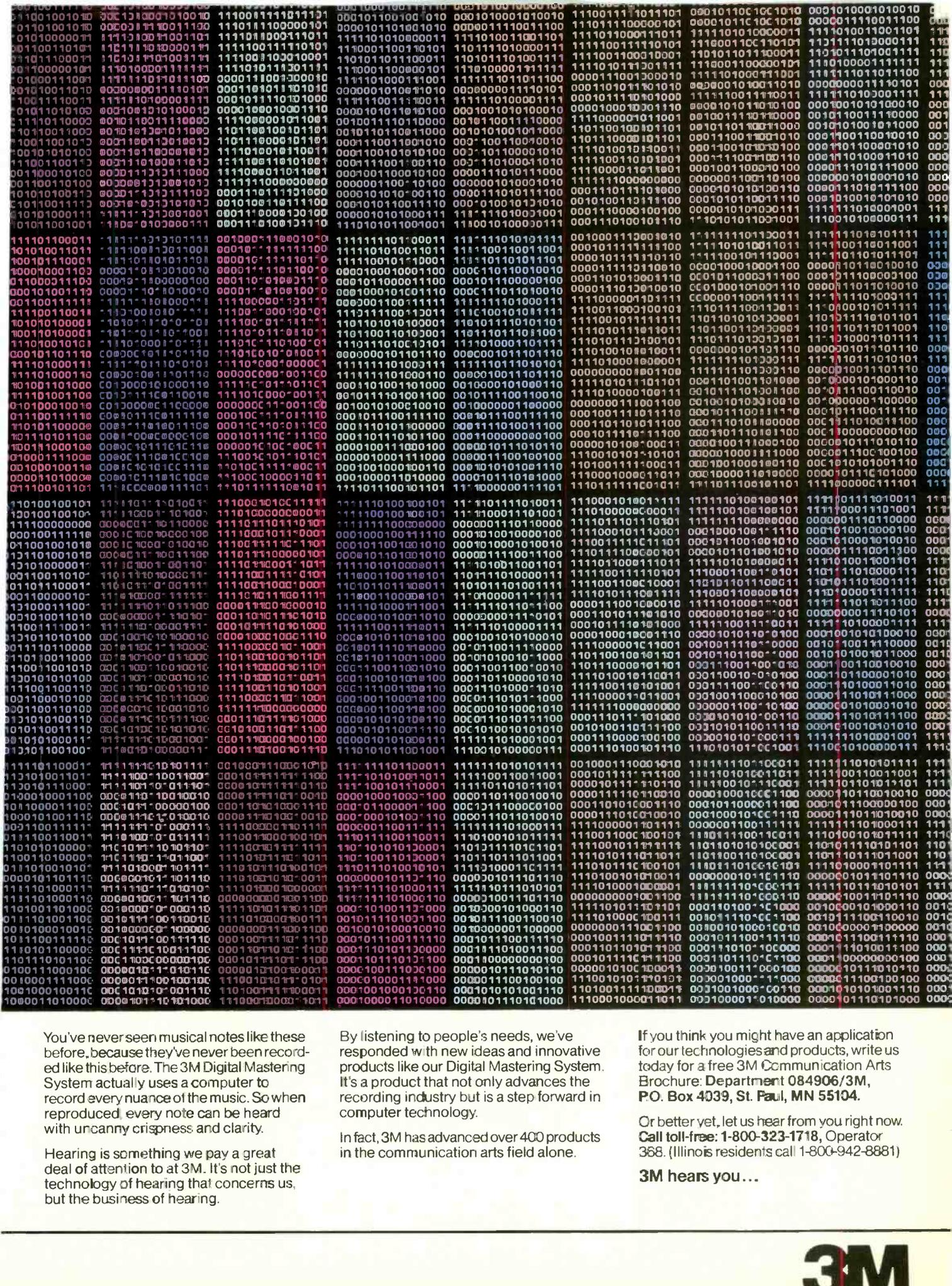

You've never seen musical notes like these before, because they've never been recorded like this before. The 3M Digital Mastering System actually uses a computer to record every nuance of the music. So when reproduced, every note can be heard with uncanny crispness and clarity.

Hearing is something we pay a great deal of attention to at 3M. It's not just the technology of hearing that concerns us, but the business of hearing.

By listening to people's needs, we've responded with new ideas and innovative products like our Digital Mastering System. It's a product that not only advances the recording industry but is a step forward in computer technology.

In fact, 3M has advanced over 400 products in the communication arts field alone.

If you think you might have an application for our technologies and products, write us today for a free 3M Communication Arts Brochure: Department 084906/3M, P.O. Box 4039, St. Paul, MN 55104.

Or better yet, let us hear from you right now. Call toll-free: 1-800-323-1718, Operator 368. (Illinois residents call 1-800-942-8881)

3M hears you...



## NAB SHOW IN PRINT

### Master control: gaining control

While there were not many new master control switchers or systems at NAB, there were a great many improvements geared to automation of on-air operations. One new on-air automation system was a first time-entry by Datatron.

Called S.A.S. (Station Automation System), Datatron's computer controller is designed for traffic, scheduling, and automated on-air operation. The system can be interfaced to any master control switcher and is intended for stations in small and medium-sized markets. It will store up to 4000 events on-line, run the switcher or machine control system, and produce FCC logs and billing information. Events can be edited right up to preroll with complete reconciliation of the remainder of the event schedule. The system is a desktop CRT-based unit with disk storage. Full-screen display lists all relevant data for each event in alphanumeric form. Source identification is English-language. The system, depending on options, will be priced between \$40,000 and \$60,000.

ISI's TAS-100 (Total Automation System) is now ready for operation with

the ISI master control switchers (Models 931, 821, and 1199). Machine control interfaces exist for all current television equipment, including IDA and ADA-equipped ACR-25s. The TAS-100 is a modular, building-block design that starts with a 2000-event controller. Ten auxiliary channels in the system permit control of other events, such as switching transponders or microwave channels for automatic recording of scheduled feeds. The system runs between \$44,500 and \$85,000.

Central Dynamics introduced its APC-920 Automation System, — the "second stage" in its APC-900 Automation System. The 300-event 920 system was shown operating with CDL's MC-990 master control switcher. It is operationally identical to the 910, which had 40-event storage.

Image Video showed its Model 8100 Automated Master Control system. This unit, incorporating a Z-80 microprocessor, is a plug-in, single-day controller. The 30-input master control switcher can be operated conventionally until station volume justifies automation.

The master control and automation systems from Vital, Grass Valley, and American Data remained stable. These systems have been on-air for some time and, like Grass Valley's M200 system, are designed to grow with the sophisti-

cation of the station.

Machine control systems continue to grow in number and complexity. Systems such as Fernseh's TCS-1, 3M's 6500, Dynamic Technology's VIMACS, and Control Video Corp.'s Intelligent Controller were all seen last year. But, as with other software-based systems, exhibited further development this year.

VIMACS, marketed by Candex Pacific, added SAMS (Source and Message System), VIPS, and VISE to its vertical interval machine control system. SAMS is an encoder/decoder unit that allows VIMACS-connected sources (remote broadcast sites or VTR machine rooms) to enter a brief production message, identifier, or program title into the central system. VIPS decodes and displays source IDs on regular monitors and VISE encodes identifiers from equipment such as cameras and telecines. All of this information (time code too) is routed through the system in the vertical interval in addition to the normal machine control signals of the VIMACS system.

3M's 6500 connects through a single coax cable. The microprocessor-controlled system works with any of the 3M routing switchers — including two new models covered in this report — or it can operate as a standalone. CVC's "Intelligent Controller" has used its

# The True Test for ENG Color

Asaca/ShibaSoku's 226 battery driven Color Bar Generator is the last word in equipment testing and station signal identification in the field

- Generates split field color bar signal and your station's name on location.
- Great for line operation
- 12 volt DC or battery operated
- 1 kHz sound oscillator
- Line signal and 226 generated signal switch



# 226

**ASACA/ShibaSoku  
Corporation**

1277 Rand Road  
Des Plaines, Illinois 60016  
(312) 298-4380

Circle 172 on Reader Service Card

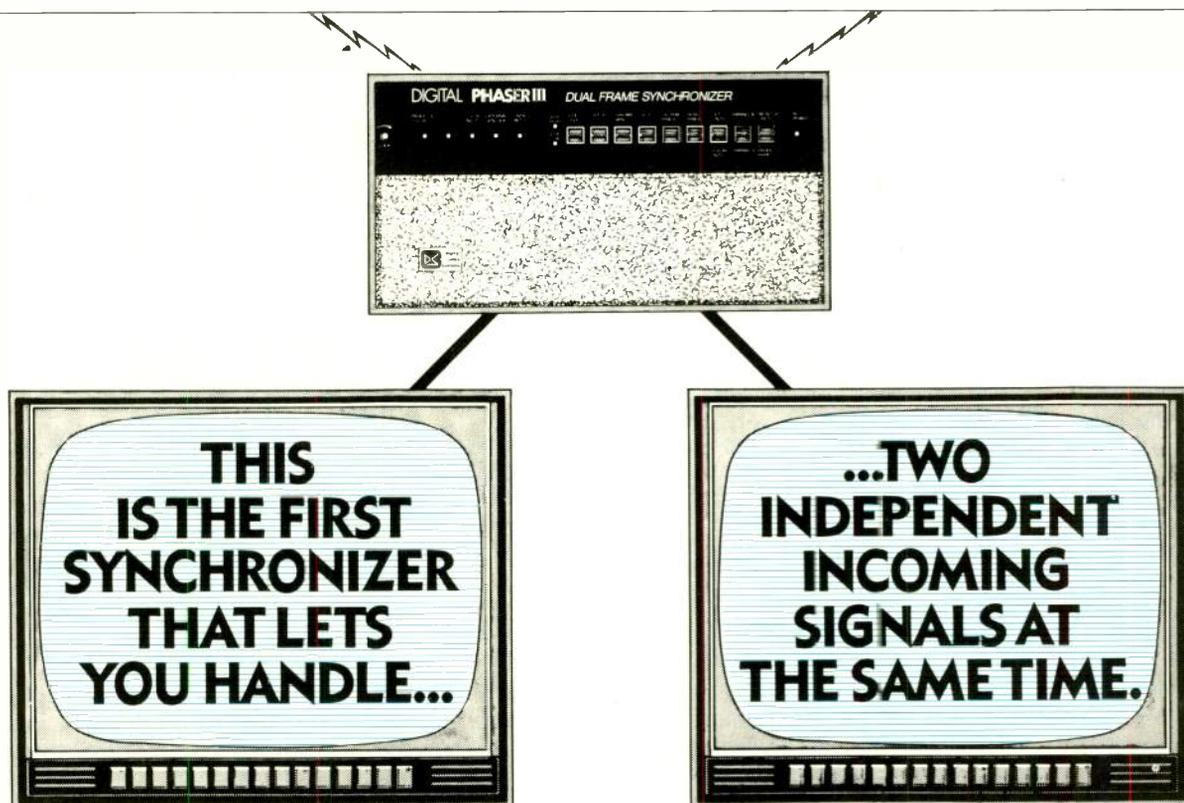

Two remote feeds coming into the station simultaneously? That's exactly the kind of situation Digital built the Phaser III for.

It's only logical that the company that defined the state of the art in synchronizers should push the borders of that state a little further into the 1980s. Phaser III does just that.

It's the first system that can synchronize two totally independent signals. A dual channel intelligent framestore synchronizer giving optimum picture quality with direct colour.

Phaser III. It's not a glimpse at the future – it's here now.

**IN STOCK.  
AT LESS THAN \$12,000 PER CHANNEL.**

 **DIGITAL**

Digital Video Systems Inc.

Head Office: 716 Gordon Baker Rd., Willowdale, Toronto, Canada M2H 3B4 • Telephone (416) 499-4826

## NAB SHOW IN PRINT

machine control function and SMPTE time Code read/write capabilities to extend the system to editing and synchronizing applications. These new applications are reported elsewhere in this issue.

Another version of the CVC system, "The Sequencer," is intended for cable or closed circuit television system use. Events of a large number of VTRs can be controlled on a clock basis or programmed on a "chained" event basis — that is, one starts as the other finishes.

Image Video showed its 4100 Machine Assignment System, which handles up to 160 machines. The system's controller is made up of two sections, the Assignment Controller and the Machine Controller. Each section contains its own microprocessor, these communicate with one another over coaxial cable. The assignment section determines which machines will be assigned to which control panels and the machine control section handles communications between the system and the individual machine interfaces. Up to 24 control panels can be involved in the system, controlling up to 25 machines per panel with 35 levels of switching and tally.

Dynair, with its System 23 Data

Switching system and System 21 Routing Switcher system, now offers remote control of up to 1000 machines from as many as 1000 locations through its System 23 Remote Machine Control System. Communication is via RS-422 serial data; up to 128 functions per machine can be controlled. Various "delegate" or "demand" modules can be configured to provide the hierarchy of control. Central control over the entire system can be achieved through the System 23 Data Switcher when large numbers of remote control locations are used in the system.

**For more information:** Datatron S.A.S., 618; ISI TAS-100, 619; CDL APC-920, 620; Image Video 8100, 621; Candex Pacific SAMS, 622; VIPS, 623; VISE, 624; Dynair System 23, 625.

### Business automation systems expand

Over the years, business automation systems have grown, both in their capabilities and in the sheer number of companies offering business services. This year the established systems continued to offer new programs for radio and television management and to develop new ways of delivering these services (on-line, off-line, time share, service batching, and more). But the

power of data processing has gone on to conquer new territory as well.

DCC, perhaps the largest single supplier of business automation services to radio and television stations, launched a new Network Control concept for its BIAS system at NAB. Network Control brings near total automation to a television operations by integrating all the business functions of DCC's on-line BIAS system with a new Master Control Automation system. Automatic letter-writing and other "office functions" have been added to round out the system.

The BIAS system offers traffic and accounting functions, a Feature Film program package for inventory, amortization, and program management. Buy Line, an avails submission system, connects the station with its national rep. The system also links up with the Master Control Automation system, which controls the on-air switcher, identifies material, initiates machine functions as scheduled, prepares several alternative logs including FCC logs, and generates media pull lists. An auxiliary events feature will even allow the system's user to do a full news break automatically — turn on the lights, operate the camera, and air the break — then resume normal on-air operations with all files and schedules updated to reflect the news break.

# THE ELEGANT SOLUTION

## The New 8x32 Digital Reverberator from URSA MAJOR

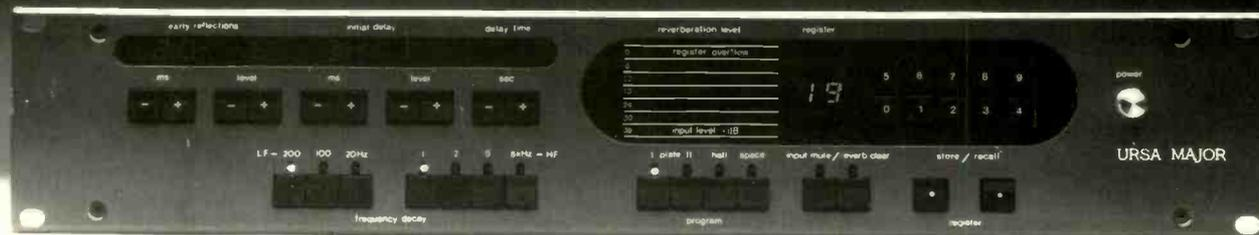

- Clean, high-quality reverberation
- Four programs: Plate I, Plate II, Hall, and Space, with decay times from 0.2 to 20 seconds
- "Friendly," microprocessor-based control and display of all seven programmable reverberation parameters
- LED display of the dynamic properties of input and processed signal levels
- Non-volatile storage registers for 32 separate reverb set-ups
- Input Mute and Reverb Clear functions for extra control of long decay times
- Compact (3½"x19")
- Optional remote control
- Moderately priced (\$5995 U.S.)

URSA MAJOR, Inc., Box 18, Belmont, Mass. 02178 USA • Telephone 617-489-0303 Telex 921405 URSAMAJOR BELM

Circle 174 on Reader Service Card

# pictures & power

## Leddicons ...

the image standard for quality camera tubes.

The Leddicon® family of 1/2/3", 1" and 30mm lead oxide tubes are the best available today... and include integral and variable light bias types, extended reds, high resolution greens and H.O.P.'s for anti-comet tailing suppression.

## Vidicons ...

the established imaging tube standard for all broadcast color telecines and caption scanners. A wide range of photosurfaces means that there is an EEV vidicon to meet any requirement.

## Klystrons ...

that pay for themselves in 1 to 2 years. Our 55 KW high efficiency klystrons have operated reliably at over 45% efficiency for the past two years... worldwide. EEV klystrons are available from 10 KW to 55 KW.

Power-tetrodes... a complete power range is available for TV AM and FM transmitters.



® Registered Trademark of EEV Lead Oxide Camera Tubes



**EEV, INC.**

7 Westchester Plaza, Elmsford, NY 10523, 914-592-6050, Telex 646180

In Canada: EEV CANADA, LTD., 67 Westmore Drive, Rexdale, Ontario, M9V 3Y6, 416-745-E494, Telex 06-989363

In Europe: English Electric Valve Co. Ltd., Chelmsford, England CM1 2QU Tel: 0245 61777, Telex 851-991C3

Members of the GEC Group of Companies

Circle 175 on Reader Service Card

## NAB SHOW IN PRINT

Station Business Systems, which now boasts 35 to 40 television clients for its BAT 1700 system, continues to press on with Newscom. Interest in newsroom computers continues to run high, and SBS's Joseph Coons said that the system "is now fully mature and ready to be installed on a 60- to 90-day basis." Coons wanted to clear up the impression he attributed to the trade press that Newscom was expensive. A five-terminal system, said Coons, could be purchased for \$75,000-80,000.

SBS has not foresaken development of its business system in the least, and has added general ledger software and various new management and budget analysis programs. For radio, an MPI system gives a station's PD better con-



Systems Concepts' Quantanews has been installed in this van to take it on tour for news directors

trol over music formats by providing a variety of statistical data on music plays.

Jefferson Data reports that its ENP news system will be ready for market as of June 1. The shakedown of the system which has been going on at WBTV, Charlotte has provided a good test run for the system.

The Quantanews system from System Concepts has found its first full client in KDBC-TV, El Paso, Texas. Unlike the larger newsroom computer systems, Quantanews is focused primarily on newsroom management of assignments, crews, and other scheduling matters. While it is also set up to handle newswire, morgue, and weather functions, it does not include all the text editing features of the larger systems.

Columbine, which offers a wide range of business services and operations programs to radio and television stations, made one of its rare appearances at NAB. Its impressive array of programs is designed for use on IBM System 34 hardware, which the operator purchases. Software is leased from Columbine. The system now boasts 144 television clients, 308 radio station clients, and five network or network-type clients.

Kaman Sciences' BCS system is basically unchanged, but the company reports continued success with its special

FILMS and DEMOS programs on its 1100 system. KARTS, BCS's management package for radio audio carts, is also achieving success.

**For more information:** DCC Network Control, 627; SBS Newscom, 626; business system updates, 628; Jefferson Data ENP, 629.

### Frame synchronizers and digital processors

With NEC's FS-16 and MCI/Quantel's DFS-1750, both introduced last year, the idea of the routine frame sync took hold. Both units, moderately priced and just one rack unit high, made it possible for broadcasters to conceive of multiple framesyncs dedicated to multiple video sources. These units followed the price breakthrough made by ADDA Corp.'s VW-1 unit and its successor, VW-2.

DVS joined the low-cost dedicated frame sync march with its Phaser series. This year Phaser I and II were joined by Phaser III, a low-cost dual-channel synchronizer capable of handling two independent feeds. The new unit contains two frames of memory but shares power supply and some other circuitry. Its 6.2 million bit memory is microprocessor-controlled and inputs are examined continuously for automatic adjustment. An 11 TV line hys-

**3 Models—6, 8 and 10 mixer dual stereo • Transformer Balanced Inputs and Outputs • 3 Inputs Per Mixer—internal pads allow mic/line selection on the same mixer • Two 4-Input Auxiliary Input Selectors—may be assigned to any mixer • Pre-fader Pushbutton Cue—in addition to normal CCW fader cue position • LED Status Indicators—color coded to aid in instant identification of function selectors • Momentary or Continuous Remote Control Contacts—internally selectable, also controls optional digital timer reset/start • Full Metering Capability—two meters standard, up to four meters and/or digital clocks and timers optionally available, all meters provided with LED peak indicators • Gain Selectable Microphone Preamps—provided with center tap access for phantom condenser microphone power, processor input/output port with buffer amplifier for outboard compressors, limiters, etc. • Programmable Muting Logic—internal pin-programmed matrix allows any selection of monitor and cue muting for the first five mixer positions • Pushbutton Aural Phase Test • Announcer's Microphone Intercom-Air Selector • Full Dual Channel Operation—**  
**independent program and audition assignment pushbuttons • Five Monitor Driver Outputs—four muted, one non-muted • All Mixers Switch-Selectable to Mono or Stereo • Ground-Plane Techniques Used Throughout for Increased RF Immunity • Selectable Internal or External Master Level Controls • Accessories and Options—mono mixdown, high impedance (cassette) line input plug-ins, reference oscillator/line input plug-in, additional microphone input plug-ins, digital clock, digital timer, linear faders**



**LPB**®

**citation series**

LPB Inc. • 28 Bacton Hill Road • Frazer, PA 19355 • (215) 644-1123

Manufacturers and Distributors of Broadcast Equipment since 1960

© 1980 LPB Inc.

# Put FUJINON'S 17x9 zoom on an ENG/EFP camera and you may never take it off.



## The universal lens for 2/3" format.

Instead of toting a truckload of lenses, take one—Fujinon's 17 × 9 zoom.

At the wide side, the 9mm focal length (equal to 18mm in 1 1/4" format) gives you wall-to-wall or full field coverage. Flip the built-in 2X extender lever and you can zoom out 306mm (600mm in 1 1/4" format). With optional wide and tele front converters, the limits are extended even further—7.2mm wide, 490mm tele.

Range like that removes practically all production limitations. So does the F/1.7 speed, ease of operation and light weight.

And with the most complete list of conversion accessories available for studio use, Fujinon has made the 17 × 9 the one lens you literally can take anywhere.

### Check the specs:

Focal length:	9mm ~ 153mm 18mm ~ 306mm (2X)
Maximum aperture:	F1.7 (9mm ~ 114mm) F2.3 (114mm ~ 153mm)
MOD:	.9m
Zoom:	Servo/Manual
Iris:	Auto/Manual
Focus:	Manual
Weight:	2.1kg

For more information or a demonstration call or write:

**FUJINON**

Fujinon Optical Inc.   
672 White Plains Road  
Scarsdale, NY 10583  
(914) 472-9800 / Telex: 131642  
Circle 176 on Reader Service Card

## NAB SHOW IN PRINT

teresis insures against motion discontinuities and a freeze on the "last good frame" guards against video feed loss.

Microtime, Inc.'s approach to multiple-input frame synchronizers was proffered last year as the 2525 SP. Now in production, this synchronizer features a new TD control panel in addition to its Smart Proc (SP) control panel. Basically, the SP can monitor and control hue, setup, video, and chroma gain for eight video sources. The operator can then switch between these sources without recalibrating. A remote control panel communicating over RS-422 has full control of the SP. This year another remote control panel has been added for use by the TD in the control room. This panel allows the TD to "take control" from the operator and secure a feed for air.

Digital noise reduction, which has been integrated with most of the full-blown frame synchronizers or available as a standalone from companies like Thomson-CSF, Philips, and MCI/Quantel, finds itself applied to yet more aspects of the television system.

Philips showed its LDM-3001 combined with the six-vector Variable Matrix Color Corrector adapted from the LDK-25B camera series. This structure



Phaser III is third in the framesync line from DVS

automatically applies noise reduction to film-to-tape transfer. The LDM-3001's automatic correction sensing feature, which made it useful as a dedicated device in transmission systems, is now just as useful for tape mastering, duplicating, and film transfer.

Sony showed the production model of its BVX-30 Digital Video Multi Processor, shown in prototype last year. The unit provides infinite window time base correction, freeze frame, digital enhancement, noise reduction, and full color correction if equipped with the optional BK-31 Color Processor.

The BVX-30 will handle direct or

color under sources. Sony claims that its noise reduction system improves a typically noisy picture by as much as 60 percent and eliminates after-image and masking effects on low-level video.

Several observers mentioned that the BVX-30, like other noise reducers, might well find a role in earth station receive systems and in microwave transmission.

Oki showed the LT1200 portable standards converter, which is priced at about \$100,000. Encode and decode modules are on boards so that the system can function as either simply by plugging in the correct board. Encode

**B7501FT**      **B7501**      **B7501TS**

**75 Ohm 0.1% Precision Terminations**

Five styles of BNC/UHF terminations are available to eliminate level problems or mismatches. Level shifts of  $< \pm 1\text{mV}$  are now possible when interchanging terminations. Construction is from high quality BNC/UHF plugs with tight tolerance 0.1% metal film resistors. Each termination is tested after assembly to insure quality performance.

B7501	BNC Low Profile	\$ 3.55
B7501TS	BNC with test socket	5.10
B7501TP	BNC with test point	4.85
B7501FT	Feedthru BNC/BNC	13.50
U7501	UHF Low Profile	3.55

Quantity discounts available



STOCK DELIVERY 916/273-9524

Hughes Electronic Devices Corporation  
P. O. Box 1985, Grass Valley, CA 95945

Circle 177 on Reader Service Card

# Winsted

**THE MATCHMAKERS**  
for the customized approach  
to videoproduction centers.

## Portable PRODUCTION CONSOLE

For in-house or on location—a complete production facility in one compact portable unit. Ample 4 7/8" of rack space puts all your equipment within easy reach. Large selection of modular components offer many variations.

For full-line catalog of editing, production and dubbing consoles, tape and film trucks, film and videotape storage systems, call or write:

**MODEL 831**

**THE WINSTED CORPORATION**  
8127 Pleasant Ave. So. • Minneapolis, MN 55420 • 612/888-1957

Phone Toll-Free  
**1-800-328-2962**

# Winsted

Circle 178 on Reader Service Card





## NAB SHOW IN PRINT

or decode boards exist for NTSC, PAL, and SECAM. For operation as a standards converter, no adjustments are necessary — one button puts the power on and the system in service.

The LT1200 can also be used as a standard frame synchronizer or TBC. Features such as freeze frame are useful in both applications. Operating as a converter, the machine can be used to integrate different standard tapes.

**For more information:** DVS Phaser III, 631; Microtime 2525 SP, 630; Sony BVX-30, 632; Philips LDM-3001, 633; Variable Matrix, 634; OKI LT1200, 635.

### TBCs and other digital processors

The main trend in time base correctors this year was the addition of signal processing and reconfiguration to support special video environments, such as transfer and editing. Frame synchronizers either got smaller or developed multi-input schemes. Noise reduction systems changed little and standards converters remained the same.

Microtime introduced a brand-new

time base corrector, the T-120. Like some other manufacturers, Microtime noted with pleasure that its new TBC features 3.58 MHz feedback, a requirement for working with the new half-inch VTR/camera systems.

The T-120 is an eight-bit, 4 fsc TBC with a 15-line correction window. It is especially designed for non-segmented scan-type VTRs and interfaces with Microtime's 2100 Image Enhancement system. Auto Trac 3™ circuitry automatically assures the correct vertical blanking conditions. The unit can genlock or operate from its own internal RS-170A sync generator.

This \$9490 unit is very compact,

using only 3½ inches of 19-inch rack space. Though compact, access for service is simple due to a "flower petal"-type arrangement of the boards. Extension cards are no longer necessary since access to all boards can be obtained through the top of the box.

Another unique design approach was shown by Digital Video Systems for its new DPS-100 series systems. In appearance, the DPS-100 modules look like a series of chrome-plated drawers, each about an inch high. Modules shown in Las Vegas included the DPS-103 TBC, DPS-162 master sync generator, DPS-175 test signal generator, and the DPS-100 diagnostic



Sony's BVX-30 is one of the new combination digital video processors

# NEW CETEC 8000

This is the all-new high-performance luxury console from Cetec. 8 channels standard, expandable to 16. You can expand it, or choose to plug in an equalizer — otherwise it comes complete and ready to work. All modular and solid state, with Penny and Giles pots and

the best IC's available. There's almost no hard wiring, and no cumbersome harness to trace. Clean, clear sound — only .008% THD. Five lighted meters, two peak LED over-

load indicators, five warning enunciators, LCD clock/timer, front-mounted intercom, head-phone

and cue amplifiers — all standard and included. First quality in design, materials, and manufacture. The only thing we've stinted on is the selling price — this great new Cetec 8000 is price-competitive with many audio consoles that offer much less. Write or phone today for fully detailed data brochure.



Circle 180 on Reader Service Card

 **Cetec**

Cetec Broadcast Group of Cetec Corporation 1110 Mark Avenue, Carpinteria, CA 93013 (805) 684-7686 Telex: 658-461

# LISTEN TO THE DIFFERENCE.

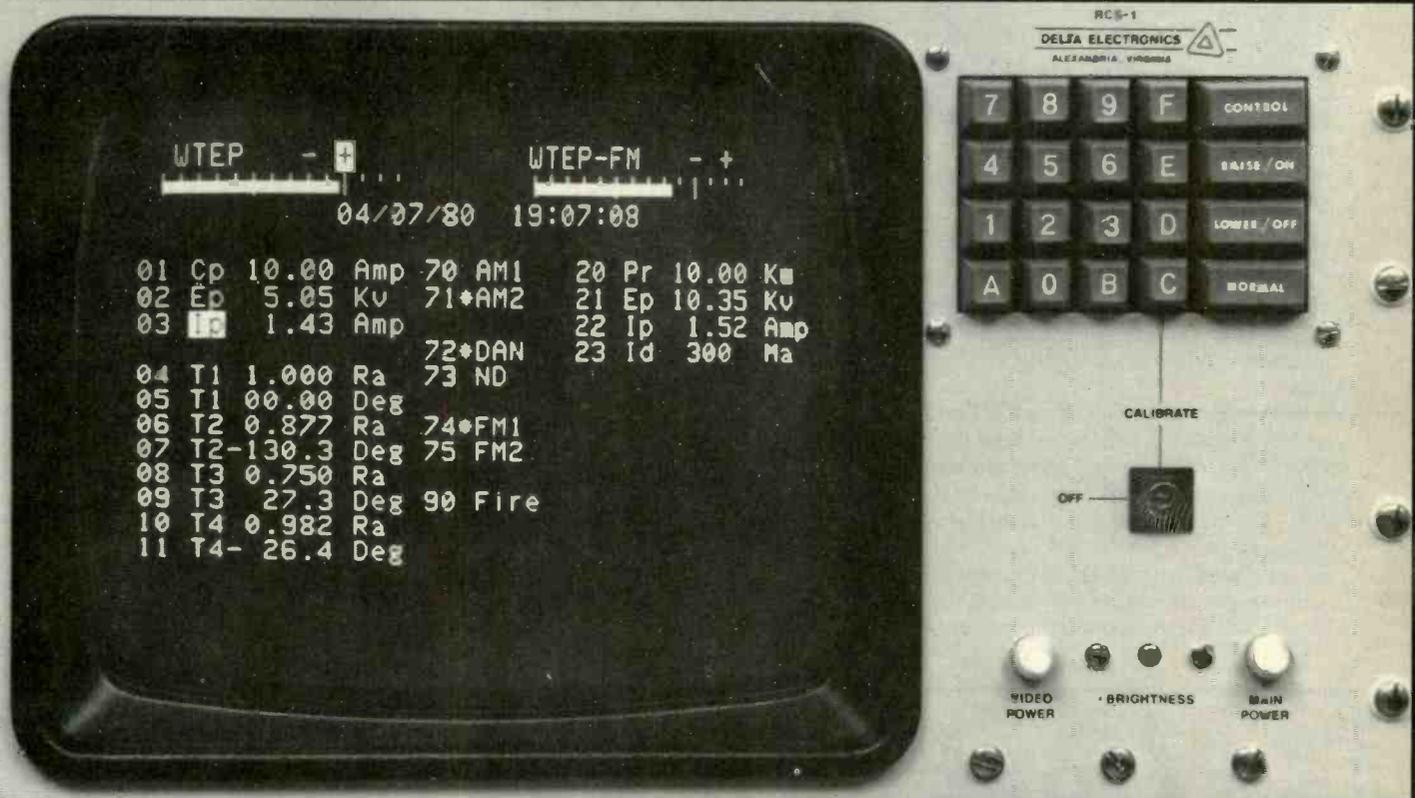

## THE DELTA RCS-1 REMOTE CONTROL SYSTEM

*A simple, yet sophisticated approach to AM, FM and TV Remote Control*

### SIMPLE.

- All parameters are displayed for the operator.
- Hands-off operation until an actual control function is required.
  - Automatic logging option ends the nightmare of forgotten or incorrect log entries.

### SOPHISTICATED.

- Features not found on other remote control systems:
- Modulation bargraph with peak flashers.
  - Direct antenna monitor interface.
  - Telephone coupler with speech synthesizer providing telephone interrogation.

The RCS-1 is designed to grow with your plant. Additional control, input, and alarm boards can be added to the systems, thereby meeting any new station requirements. In addition, the RCS-1 contains the fundamental building blocks for ATS, permitting conversion to a combination Remote Control/ATS System at a later date.

Write or call for a descriptive data sheet and pricing.

**DELTA ELECTRONICS**

5730 General Washington Drive, Alexandria, VA 22312 703-354-3350 TWX 710-832-0273

Circle 181 on Reader Service Card



## NAB SHOW IN PRINT



The advent of DBS service to home downlinks like this one lead Oki to see an expanded role for standards conversion

system.

In fact, all DPS-100 Series modules are premised upon a unique diagnostic system that provides constant microprocessor checks of all 100 series circuits.

The system provides both a CRT and hardcopy readout of faults that may occur in any of the modules and isolates them down to board, circuit, or IC level. Several status and alarm levels are formatted to tell the user how serious any problem is. The system will even suggest temporary alternative solutions and advise on ordering informa-

tion for any needed spare parts. The system provides continuous on-air monitoring and off-line system testing.

For off-line testing, a DPS-175 test signal generator provides all digital test signals in component form. Optional is a new Zone Plate test signal for H,V, and timebased frequency response evaluation. The new series also offers the DPS-162 master sync generator, which provides totally digital RS-170A sync outputs.

The TBC, Model DPS-103, is designed for any heterodyne VTR and features a six-line correction window. Also microprocessor-controlled, the TBC is fully conversant with the other DPS-100 series modules. The 103 is priced under \$10,000.

Edutron, long a source of the CCD analog TBCs, jumped into the digital



One of the boards that constitute the new DVS-103 system, all part of the DVS100 diagnostic system

fray with its Y-688<sup>32</sup> Total Error Corrector system. The new unit is a digital TBC (32-line window) and signal processor designed specifically to correct not only time base errors but also errors resulting from the color under process.

The Y-688<sup>32</sup> accepts composite or component video but works in component. Correction is provided to reduce luminance and chrominance noise, increase horizontal details, sharpen horizontal and vertical transitions, remove chroma-luminance delay errors, sharpen chroma rise times, and eliminate second order ringing. This processing can be applied selectively by the user or it can be accomplished automatically if the Faroudja Laboratories Record One pilot signal is recorded. Record One is part of Faroudja's series of enhancement products. The Y-688<sup>32</sup> system is priced at \$18,500.

Time base correctors from other manufacturers such as Harris Video Systems, NEC, and MCI/Quantel were essentially unchanged. Manufacturers of one-inch Type C VTRs continued to be the main source of special-purpose TBCs designed for the variable-speed functions of their VTRs.

For more information: Microtime T-120, 636; Digital Video Systems DPS-100, 637; Edutron Y-688<sup>32</sup>, 638.

# A REEL THAT FEELS

say goodbye to  
*pinch* rollers and  
shake hands with our  
new tape handler.....  
introducing the **AS-100**

- ALL DC SERVO CONTROLLED From 1 7/8 ips to 120 ips
- DIRECT CAPSTAN DRIVE Eliminating Pinch Rollers
- 14 inch REEL to REEL CAPABILITY in 150 mil, 1/4", 1/2"
- AVAILABLE ON
  - 1) High Speed Tape Duplicators
  - 2) Reel to Reel Recorders
  - 3) Slow Speed Loggers
  - 4) Cassette Evaluators

Call or  
Write to:



**ACCURATE SOUND CORPORATION**  
Sales and Service  Professional Equipment  
Consultants  Studio Design

114 Fifth Avenue, Redwood City, California 94063  
Phone Area Code (415) 365-2843 Telex 34-8327



It's all in our CM-33 B HIR  
Color-Critical Monitor

- High resolution
- .31 mm. dot screen
- Shadow mask in-line gun picture tube
- Seven mHz video amplifiers standard

## ELECTOR

Exclusive North American distributor  
for Barco A/V products

5128 Calle Del Sol  
Santa Clara, California 95050  
(408) 727-1506

31 Progress Court, Scarborough  
Ontario, Canada, M1G 3V5  
(416) 439-9333, Telex: 065-25431

# Go Beyond Uninterruptible Power!

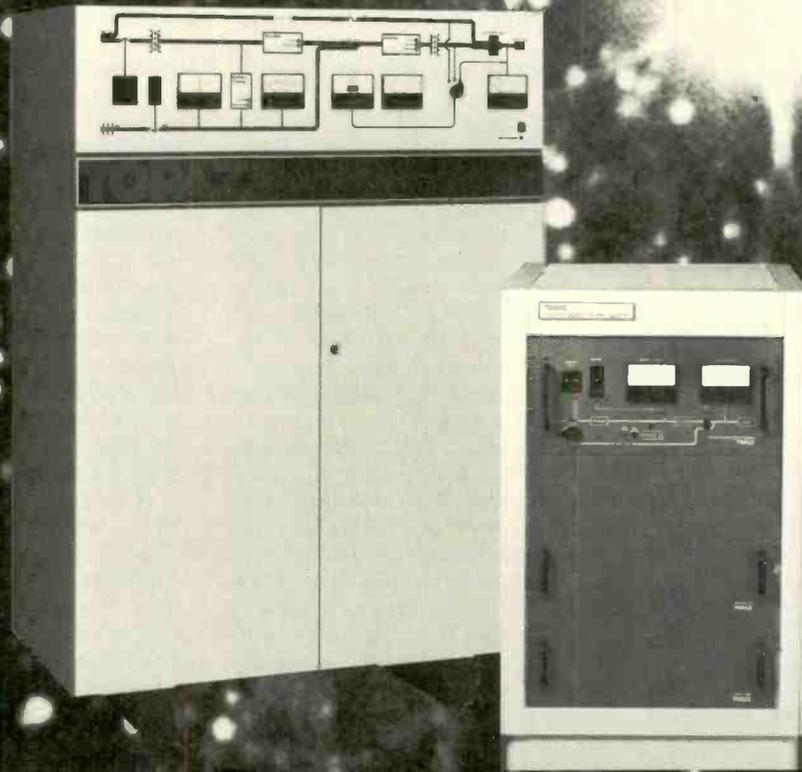

The Uninterruptible Power System is a vital link in the continuous operation of security systems, telecommunications networks and many computer applications. But Topaz UPS go beyond providing power when the utility source fails. They also protect against voltage variations, power line noise and brownouts — all of which occur more frequently than voltage outages. That's why you owe it to yourself and your customers to provide the ultimate in protection against voltage sags, surges, lightning, brownouts and blackouts

which can interfere with proper computer operation or telecommunications transmission.

The protection you need is a Topaz Uninterruptible Power System. You can rely on these systems to protect your critical loads against power line disturbances and loss of commercial power. Topaz UPS are UL listed and immediately available in cabinet assemblies complete with batteries.

Tear out this ad and mail it to us with your business card, circle the reader service card or call us direct.

**TOPAZ** SOLUTIONS TO  
POWER PROBLEMS  
ELECTRONICS DIV. <sup>TM</sup>

9192 Topaz Way, San Diego, California 92123—(714) 279-0831—TWX (91C) 335-1526

# Adding up Cetec's CP/FM antenna score

It's a score of years — more than 20 years of design and performance progress in CP/FM signal transmission. Now we offer the entire antenna range, from very low to very high power. Omnidirectional or directional; with radomes or deicers; very well-built and carefully tested; and with Cetec's two-year warranty.

For the ultimate in CP/FM antenna performance, Cetec also performs pattern optimization.

When it comes to CP/FM, CP/TV or HP/TV transmitting antennas, Cetec has the best score in broadcasting!



Hi-power  
CP/FM antenna  
from Cetec.

All-purpose  
Cetec CP/FM  
star performer.



## Cetec Antennas

6939 Power Inn Rd, Sacramento, CA 95828  
(916) 383-1177 Telex: 377321

Circle 185 on Reader Service Card

## NAB SHOW IN PRINT

### Analog video processors, color correctors, subsystems

Faroudja Laboratories introduced two new devices in its line of video processing equipment. Record-Ex is a low-cost, \$995, video signal processing unit intended to enhance the subjective image. Small details generally degraded by color under VTRs are enhanced and the "cartooning" effect eliminated. The unit weighs just 12 ounces and measures five by five by 1.5 inches, so it can be easily mounted to portable VTRs with Velcro™ strips.

On the other end of the Faroudja spectrum, a new Wide Band Playback One processor has been added. Like the regular Playback One system, the new wideband version provides luminance and chroma noise reduction, H and V enhancement, automatic correction and eliminates ringing when used with a Record One encoded videotape. Designed for use with wideband VTRs, the \$6750 unit has 4.5 MHz bandwidth rather than the 3 MHz bandwidth of the Playback One system.

Leitch Video, Ltd. introduced a new VPA-330N video processing amplifier, a smaller version of its VPA-300N proc amp. The new device is just one rack unit high and features an internal sync generator that can provide system timing. RS-170A pulse parameters can be maintained, and the "fade to black" feature can be selected in a mode that will not affect VITS.

Thomson-CSF showed its IV Series of image enhancers, which includes Models 8010, 8310, and 8410. The 8010 is intended for use on the program line while the other two are intended for processing of camera feeds. Each element of the picture is compared to its adjacent horizontal and vertical elements within the picture field to generate a detail signal, which is then combined with the main video signal to enhance sharpness. A Combed H process removes the color subcarrier from the detail signal before it is inserted in the main video. Enhancement is applied to both H and V. Dynamic black and white detail clipping clips only the black and white peaks of the detail signal. Image crispening is also featured.

Among the new color correctors appearing at NAB was the system from Dubner Computer. According to Dubner, the system was designed in response to needs expressed by post-production users of color correction. The computerized system, with either dual floppies or cassette, can provide approximately 300 correction events. Operator commands are input either through keypads or the 32 pots associated with the control panel. The system, which is primarily intended for

film-to-tape transfers, monitors a number of film direction and frame change impulses in order to apply the appropriate correction.

Another color correction system primarily intended for a role in telecines is Thomson-CSF's system, which includes a corrector, remote control unit, and sensor unit. The system samples black and white portions of the signal for anomalies and generates chrominance signals of exactly the same amplitude but opposite phase. Then, in a summing process, the incorrect chrominance is cancelled. The system allows for an automatic mode when the operator assumes no color problems.

Broadcast Video Products showed a range of processing gear from the U.K.'s Michael Cox Electronics, Ltd. The 339 Color Balance Corrector from Cox derives correction vectors from the separated chroma and adds them at the recombination point of the luminance and chrominance signals. Either conventional pots or a joystick control are offered for gain and hue. Chroma level, luminance, level, and setup are also adjustable from the remote panel. Delays of up to 350 ns are provided to cure ghosting in color under video. The unit is priced at \$6400.

Thomson-CSF showed its Model 7011 chroma insert keyer for NTSC. The 7011's primary function is to minimize color crawl through a comb filter. Since the bandwidth of the 7011 key signal is the bandwidth of the color difference signal, the key is quieter than a full bandwidth key of typical RGB-type keyers.

**For more information:** Faroudja Record-Ex, 639; Playback One, 640; Leitch VPA-330N, 641; Thomson-CSF Mark IV Series, 642; color correction system, 643; 7011 chroma insert keyer, 644; Dubner color corrector, 645; Broadcast Video Products (Cox) 339 color corrector, 646.

### Distribution amps and system modules

A line of video distribution amplifiers new to the U.S. market was shown by Avitel. The Avitel video modules are designed to work hand-in-hand with the Philip Drake Series 7000 audio modules. The products of both manufacturers are available in the U.S. through Television Equipment Associates of South Salem, N.Y.

The Avitel 300 Series includes VDAs, video EQ, video delay and EQ, PDAs and delay units, power supplies, and a video eight by one switch module. Each module is designed to plug into a standard rack. The circuitry of all modules was designed to meet tight BBC specifications. The same design parameters allow the Avitel modules to carefully match the Philip Drake audio modules, which include DAs, PAs, mic

# LGT: 25 YEARS OF EXPERIENCE IN THE PROFESSIONAL T.V. INDUSTRY

- Complete range of television transmitters and transposers using advanced technology for all transmission standards (many ideas carrying LGT patents).  
program Power: 100 mW to 1 kW.  
Frequency: 40 MHz to 900 MHz.
- Design studies and development of low power television stations using solar power and wind/solar power energy sources.
- Remote control systems, telemetry, aerials, programmes multiplexers, accessories, etc.
- More than 8,000 equipments are in service throughout the world.
- The world leader in low and medium power television stations.
  - Young and dynamic groups of engineers are at your service for the installation, commissioning, training of your technicians and after sales services.



**laboratoire général des  
télécommunications**

51, bd de la République - BP n 17  
78400 Chatou  
Téléphone : (3) 071.92.60 - Télex : 696 833 F

#### CONTACT

THOMSON-CSF BROADCAST INC.  
37, Brownhouse road  
STAMFORD, CONNECTICUT 06902  
Telephone : (1.203) 327 77 00  
Telex: 57 474 3346 TCSF LAB STD  
Circle 186 on Reader Service Card



# LGT

## NAB SHOW IN PRINT

amps, and others.

Dynamic Technology showed its type 2342 DA, which features 12 outputs for each amplifier. This distribution amplifier will work for video or pulse distribution and contains complete EQ. The module can be configured for three outputs at \$303, or for the full 12 outputs for \$363.

Viscount brought its Model 804 VDA, a self-contained unit with PC board that carries four individual video DAs (each with a loop-through input) and four 75 ohm terminated outputs. The units can be stacked in multiples of four from eight on up.

Hedco added three new modules to its VDA line. The EDA-102 is an equalizing DA to supplement the VDA for cable runs of up to 500 of 8281 cable. The PDA-108 is a linear pulse DA with loop-through input, six 4 V p-p outputs, and only 30 ns of transit time. The third new module is the SCA-105 subcarrier DA, which features front-panel phase selection of 0, 90, 180, and 270 degrees plus a fine range of 100 degrees.

Datatek showed a new line of VDAs and other modules designed for larger plants. The D-609 and 609F VDAs have cable equalizing and gain controls

mounted externally. Modules may be interchanged without adjustment.

Datatek also displayed a preliminary program amp, the D-513 DA and 514 monitor amp, with remote gain control.

**For more information:** Avitel video DAs, 647; Hedco EDA-102, 648; PDA-108, 649; SCA-105, 650; Datatek D-609, 651; 609F, 652; D-513 DA and 514 monitor amp, 653.

### Digital video gets boost through new filters

While SMPTE toiled over digital video standards, discussions began to focus on the issue of filters and their cost. The meeting which took place at NAB (see sidebar) heard testimony that anything less than 14.3 MHz would result in costly filtering problems for manufacturers of video systems other than recorders.

Filter manufacturers at the show, however, said that lower sampling frequencies did not necessarily correlate to higher filtering costs. In fact, Matthey Electronics showed a line of "triple filters" that cover the 12:6:6 and 14:7:7 sampling structure range. These filters are intended for component sampling. A 13.5 MHz filter was shown at NAB operating in component at 13.5 MHz:

6.75:6.75. These filters were designed for use at the input and output A/D, D/A converters. Two types were discussed a Triple Filter MTF 135P and a Triple Filter MTF 135SP with:

$$\frac{\text{sine}}{x} \times$$

equalization.

Allen Avionics showed a new line of conventional filters and delay lines. Among the new products were the delay trimmers VAR011 and VAR005. These units permit an infinitely small delay adjustment and can be used as trimmers or in conjunction with other delay boxes to build custom delay times.

**For more information:** Matthey triple filters, 800; Allen Avionics delay trimmers, 801.

### Telecines adapt to new film

The dearth of new telecine equipment on display at the 1981 NAB made this area not terribly exciting. After all, RCA introduced its full-featured TK-29 systems last year and the Fernseh FDL-60 CCD scanner had been shown before. Rank Cintel's Mark III is known everywhere. Perhaps the most significant news was the reintroduction by Fernseh of the old TeleMation tele-

# FIDELIPAC CARTRIDGES USE TAPE FOR ONLY SOUND REASONS.

Somebody else's  
reasons are  
highly unsound.

Magnetic tape is sacred at Fidelipac. That's why we only use it to record and reproduce audio. Not to do jobs it was never intended to do. Like act as part of the cartridge brake. Induce drag. Or increase tape tension.

Fidelipac cartridges use a brake on the reel assembly. Not on the tape surface. Which means no stretched or broken tape, feathering or dropout. And far less wear and abrasion to critical tape surfaces.

Now you decide. Do you want a cartridge designed for sound reasons? Or for reasons that are highly unsound?

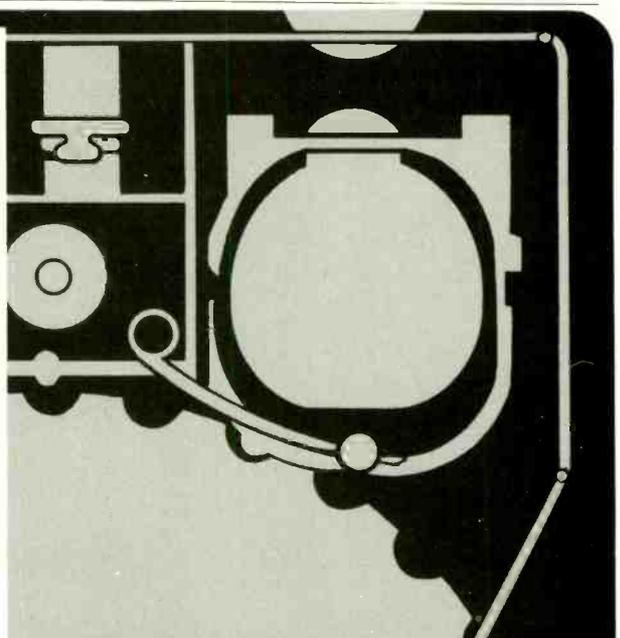

**FIDELIPAC®**  
BROADCAST TAPE CARTRIDGES

Fidelipac Corporation  
109 Gaither Drive • Mt. Laurel, NJ 08057 • USA  
TWX/TELEX 710-897-0254 FIDELIPAC MTLR  
609-235-3511

Who knows more about tape cartridges than Fidelipac?



# Two Assignments

Canon J13 x 9B IE plus Canon J25 x 11.5B IE and your camera

Two assignments, one location. For example, get great action shots of a football game and also get player interviews at half-time. You can do it with one cameraman and one camera—like the one shown here—with Canon's amazing E.F.P. lenses. Here's how:

Mount our J25 x 11.5B IE on a tripod at your principal location. Its 2/3" system was designed specifically to work with ENG cameras, yet this lens provides a 25-to-1 zoom ratio, power zoom and focus, automatic iris and the image quality you'd expect from a Canon broadcast lens. Another choice is the Canon J20 x 8.5B IE, with a 20-to-1 zoom ratio. (Both these lenses have built-in extenders, too!) With your ENG camera attached, you've got full capability.

Detach your camera from the fixed lens, mount the famous

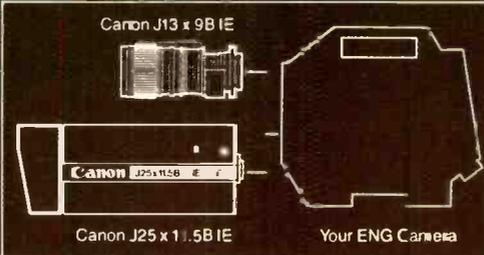

Canon J13 x 9B IE and head for the locker room!

You've got a 13X, f1.6 lens now and can move about freely for your interview shots.

The J13 x 9B IE is unsurpassed as an ENG lens, with Cable Drive and auto iris capabilities

plus built-in extenders and auxiliary wide-angle and telephoto accessories available as well.

Electronic Field Production is a reality. A practical reality because you don't have to send two crews or even two cameras to a single location if all you really need is one ENG camera and two Canon lenses. And, costs notwithstanding, sometimes you just don't have enough cameras to go around. Selecting the right combination of Canon lenses could actually double the utility of the ENG cameras you already own. And that's something even your accountant can appreciate!

Find out more. Use the coupon or write on your letterhead for the facts on the Canon J25 x 11.5B IE and J20 x 8.5B IE lenses, as well as our popular J13 x 9B IE. We'll also be happy to arrange a practical demonstration for you. A very practical demonstration!

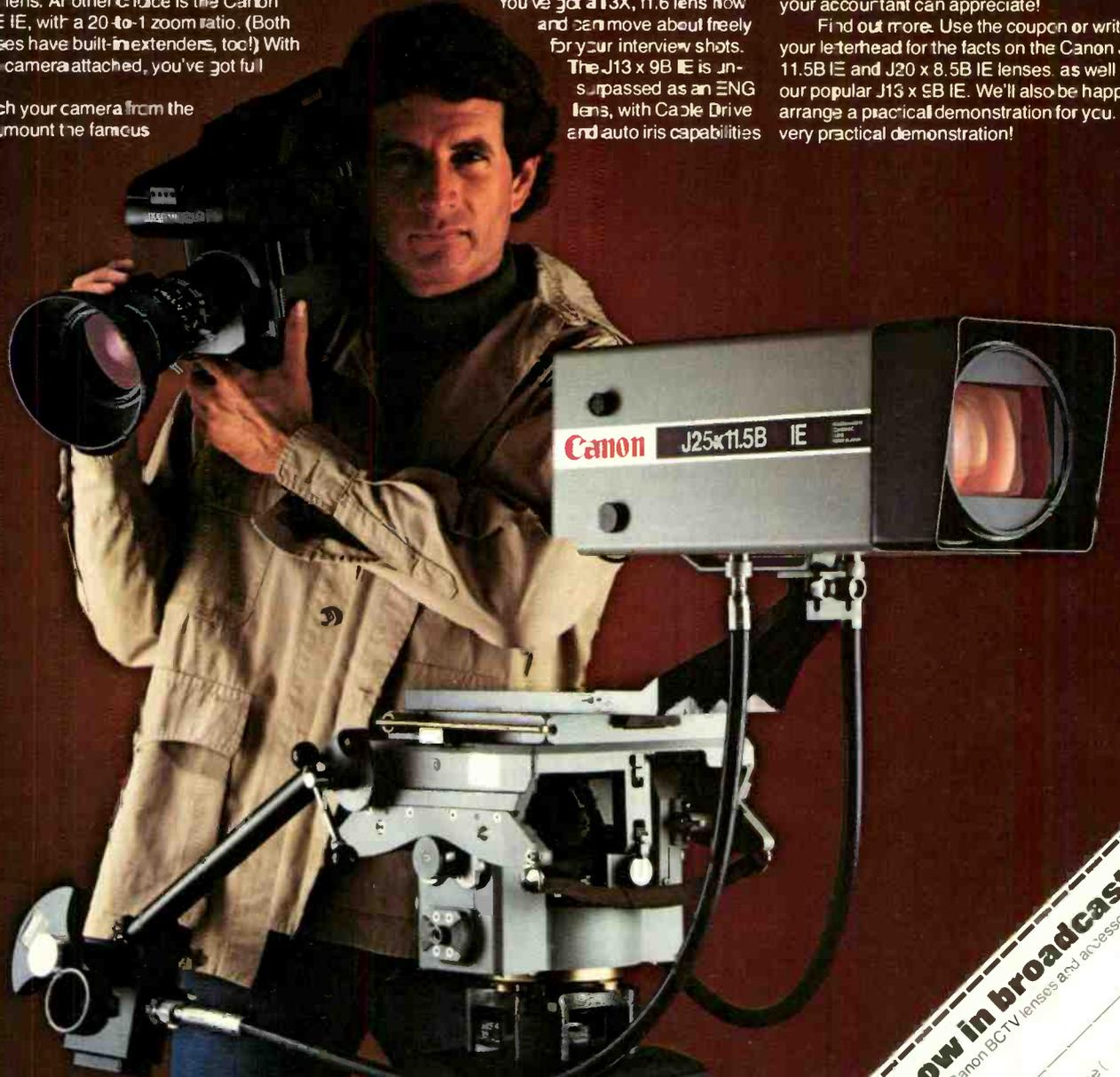

# Canon

Optics Division

Canon U.S.A., Inc. Head Office: One Canon Plaza, Lake Success, N.Y. 11042 (516) 464-5700  
 140 Industrial Drive, Elmhurst, N.Y. 11333 (312) 833-3070 • 13 Paulding Avenue East, Costa Mesa, Ca. 92626 (714) 979-6300  
 Canon Optics & Business Machines, Canada Ltd., 3245 American Drive, Mississauga, Ontario L4V1B8, Canada  
 Canon Amsterdam B.V., Industrial Products Division De Boelelaan 8, Amstelveen, Netherlands  
 © 1981 Canon U.S.A., Inc.

Circle 188 on Reader Services Card

**The name to know in broadcasting.**  
 Please send me information on Canon BCTV lenses and accessories.

Name \_\_\_\_\_ Title \_\_\_\_\_  
 Company/Organization \_\_\_\_\_ Phone (\_\_\_\_) \_\_\_\_\_  
 St \_\_\_\_\_ City \_\_\_\_\_ State \_\_\_\_\_ Zip \_\_\_\_\_

## NOW! CONTINENTAL'S 5 KW AM

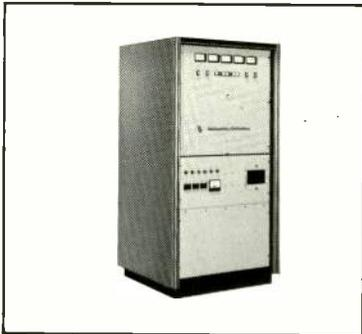

**Pulse width modulation** in an efficient 5 kW package; clear, crisp sound of transformerless modulation; ready for AM stereo. Stability of 12-phase power supply with Switch-mod system allows maximum modulation at all power levels IPL and other circuits combine to give you outstanding audio with cost-effective operation.

Write for brochure on 315R-1;  
Continental Electronics Mfg. Co.  
Box 270879 Dallas, TX 75227  
(214) 381-7161

**Continental**  
**Electronics**

Circle 189 on Reader Service Card

## "On-Board"™ Frezzi™ Battery Packs

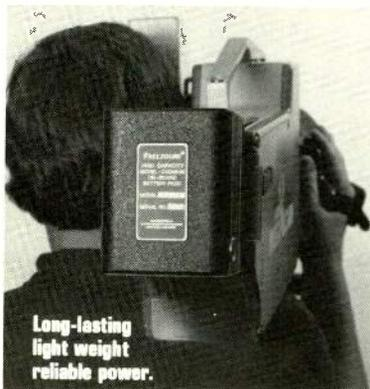

Long-lasting  
light weight  
reliable power.

Reliable, high-capacity O.E.M. or replacements for Hitachi, Ikegami, Philips, RCA, Sony and others. Less than 1 hour re-charge time with "Frezzi-Fast"™ Chargers. Made in U.S.A.

For information IN.J. 201) 427-1160 (N.Y.C. 212) 594-2294

**Frezzolini Electronics Inc.**  
7 Valley St. Hawthorne, N.J. 07506 USA  
TWX: 710-988-4142

Circle 190 on Reader Service Card

## NAB SHOW IN PRINT

cine, the TCF-3000 Plus, and some new Rank Cintel options.

The TCF-3000 Plus features a number of improvements, including remote gamma, paint, and diode gun Plumbicons for increase resolution and reduced lag. A new preamplifier design improves noise, gamma control, and auto balance performance.

Improvements to the FDL-60 CCd scanner telecine included the System 60 XL programmable frame-by-frame color corrector, a pan scan conversion kit, higher performance preamps, and improve black stretch circuits.

Color correction in the FDL-60 is based on the computerized color correction system of Computer Communications Consultants, Inc. (described in last year's Show-in-Print). The system provides 32 color correction parameters, all under computer control. The XL system is well suited for film-to-tape transfer.

Telecine systems on exhibit at RCA's booth included the RF-35B 35-mm projector, the FR-16 film handling system, and the PM-86SL magnetic sound recorder/reproducer.

Rank featured two new optional accessories for the Rank Cintel Mark III flying spot telecine equipped with T.O.P.S.Y. The X-Y zoom option permits the operator to control both the size and position of the picture being displayed. This permits reproduction of wide-screen format films and cropping of photos for special effects. At the September IBC show, the zoom control was limited to approximately 2:1. Use of T.O.P.S.Y. (Telecine Operation Program System) gives the unit an 8:1 zoom range.

The second accessory shown by Rank Cintel was the VDU video display unit. This option to T.O.P.S.Y. displays alphanumeric information on a CRT (which can be used for color correction or tape transfer instructions).

Another new product from Rank Cintel, shown for the first time at NAB, was Vidigrade. This is a precision color correction system for composite video systems. It can be used to color balance ENG videotape scenes during editing or to match various picture sources during post-production.

It can match film to TV camera pickups or film to video tape.) In operation, composite signals are fed into a precision comb filter decoder and separated into R, G, and B. These signals are individually color-corrected with a joystick control that controls master and differential LIFT, GAMMA, and GAIN functions.

Complete telecine systems (using tube pickups) were shown by Ikegami and Cohu; both had been shown at pre-

vious NAB conventions. New from Cohu this year was an option allowing the 1550B telecine system to handle color negative film. The option permits reproduction of pictures with saturation and control characteristics more similar to live color cameras. (Negative film also has the advantage of being more suited to rapid processing.)

A new large image optical multiplex stand, Model 752, was offered by Zei-Mark. It's similar to the three-input, two-output 750, but offers a preview mode of the input signal by virtue of mirror manipulation.

Zei-Mark also exhibited a new 8-mm telecine projector, the Orytec TV 1515. It is priced at \$2000.

Another new projector was offered by Rangertone Research, Inc.: the Hokushin 16-mm easy-TV projector SC 105. The quiet-running machine features an auto-threading system and an automatic loop restorer. It is priced at \$2500.

In the higher price range; RRI showed the Rangertone 35-mm telecine projector, TC-210. It is designed for use as a direct motion picture projector or as a telecine. The \$12,900 NTSC model incorporates a special designed 3-2 Geneva mechanism.

The main thrust of the Rangertone exhibit was the digital interlock system, widely used in the film industry. Stepping motors energized by pulses permit synchronizing operation of several sprocketed film transports. Rangertone film transports can be locked to VTRs with SMPTE time code readers.

L-W International showed the Athena 4000 and Athena 6000 telecine projectors (both previously exhibited). Laird Telemedia's multiplexer systems incorporated no new features. A zoom option was available this year from Thomson-CSF for its TTV 2705 color slide scanner.

**For more information:** Fernseh TCF-3000 Plus, **654**; FDL-60 improvements, **655**; RCA PA-3000 multiple-event programmer, **656**; Rank Cintel X-Y zoom option, **657**; VDU option, **658**; Vidigrade, **659**; Cohu color film option, **660**; Zei-Mark 752 multiplex stand, **661**; Orytec TV 1515, **662**; Rangertone Hokushin projector, **663**; TC-210, **664**.

### Film-to-tape transfer prominent

The merging of film/tape technologies was apparent at NAB '81, and this subject was the theme of the Eastman Kodak exhibit. EK promoted the notion of producing a program on film for "that film look" (and the flexibility that film cameras still offer over TV cameras), but recognized that distribution might well be on tape. The company heaped praises on the Rank Cintel Mark III telecine as a transfer

The new EC-35. World's First Electronic Cinematography Camera. Designed for the cinematographer, it makes network quality features on tape instead of film to substantially cut production costs.

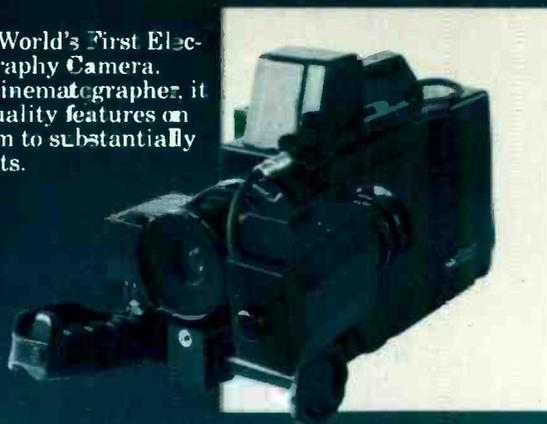

The new HK-302 Studio/Field Camera. Ideal for the sophisticated program originator who wants a high performance camera with the important operational automatics at an affordable price. This compact, high-quality camera, featuring excellent sensitivity and stability, delivers superior colorimetry.

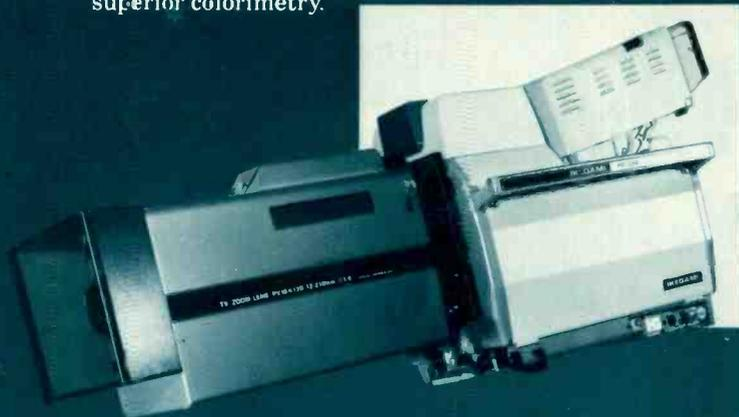

The new HL-83 initiates a new era in ENG/EFV simplicity and versatility. Smaller, lighter and requiring 30% less power than other broadcast quality ENG cameras, it utilizes proven, dependable 3/4" Plumbicon\* and Saticon\*\* tubes. It provides plug-in convertibility for various system configurations. And it's ready to accept the soon-to-be-announced attachable VCR's for self-contained operation.

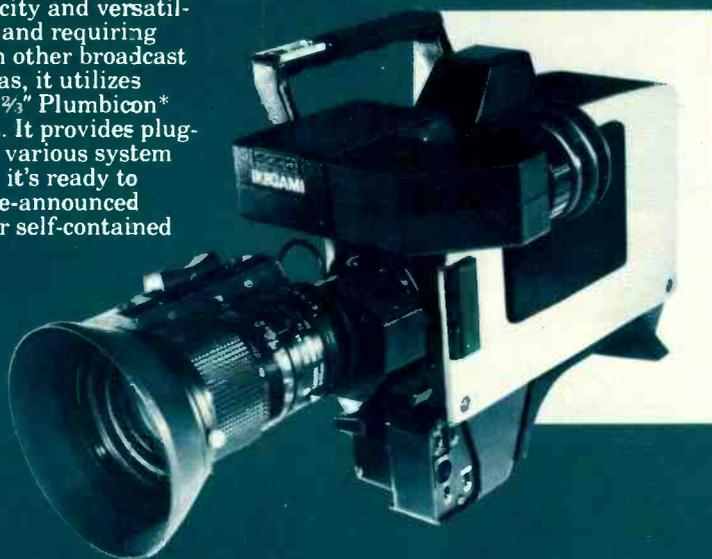

The new Series 9 High Resolution Color Monitors confirm Ikegami's position as the leader in both quality and value. Excellent color reproduction is achieved through I/Q decoding, high resolution by close dot pitch color mask and comb filter. Stability is enhanced through a new era inline gun (convergence adjustments are eliminated).

# Best of Show

Ikegami's reputation for equipment excellence and reliability drew quite a crowd at NAB '81. And, those who came were most impressed with our new products. So if you missed them in April, the show still goes on at Ikegami. For more information, contact: Ikegami Electronics (USA) Inc., 37 Brook Avenue, Maywood, NJ 07607; (201) 368-9171. West Coast: 3445 Kashiwa St., Torrance, CA 90505; (213) 328-2814.

Southwest: 330 North Belt East, Houston, TX 77060; (713) 445-0100. Southeast: 522 So. Lee St., Americus, GA 31709; (912) 924-0061.

\*PLUMBICON is a reg. T.M. of N.V. Philips. \*\*SATICON is a reg. T.M. of Hitachi Ltd.

## Ikegami



Best Picture:

**SCOTCH ONE-INCH  
VIDEO TAPE**

"Scotch" is a registered trademark of 3M.

For the second year in a row, Scotch® 479 won the award for the best picture of the year in a test of one-inch video tapes.

We scored well in all of the twelve categories tested, but especially well in the categories that commonly represent picture quality: color dropouts, high frequency dropouts, chroma noise, signal-to-noise ratio and stop motion.

These were scientific, quantitative tests, conducted as you would conduct them yourself, with no room for brand bias. The meters didn't play favorites. The standards were the same for every brand tested. And we tested every brand.

These kinds of test results don't surprise us. We pioneered the invention of video tape. And we've been setting the standard for quality ever since.

Our quality has always been consistent from the first replay to the

last. In fact, our sophisticated binder and oxide coating are more advanced than the binders and oxides on some quad tapes. They had to be advanced to meet the special durability demands of one-inch video production.

So choose Scotch 479 for your one-inch video production. You'll find it looks good from repeated mastering all the way through post production. And we've seen the test results to prove it.



**3M**

## NAB SHOW IN PRINT

device that makes it possible to convert film to tape without degradation.

Color negative film, which can be transferred to videotape for speedy post-production, is playing an important role in production, according to EK. With more and more film-to-tape equipment becoming available, such as the Fernseh FDL-60, producers can use either medium to its best advantage, said EK.

Magnasync/Moviola, which showed the Videola film-to-tape transfer system last year (based on a unique Flickerless Prism® optical sub-system), said it now has production machines. New this year was the V2000, which houses the transports in a new cabinet configuration that locates one of the transports of a slope panel. Transfer with Videola is independent of TV synchronization so the film can run at a high speed. Films with separate magnetic sound tracks can be handled.

Showing an inexpensive multimedia system for the conversion of motion picture film and slides to videotape was tri-Tronics. The system is based on a color television camera head with a high-resolution vidicon tube.

Several new strictly film items were unveiled at the show by Research Technology, Inc. Among them were a Cine Scan™ high speed previewer and a low-cost computerized information reporting system for film inspection editing and previewing, Data-Film. The Lipsner-Smith subsidiary of IRT showed a new compact CF-200 ultrasonic film cleaner machine and a new film cleaning system, the CF-3000, that consumes less cleaning solvent.

**For more information:** Magnasync/Moviola V2000, 665; Tri-Tronics system, 666; RTI Cine Scan™, 667; Data-Film, 668; CF 200, 669; CF-3000, 670.

### Picture monitors

The explosion of computerized color graphics systems has caused a flood of introductions of high-resolution color monitors from most manufacturers.

Amtron introduced new high-resolution monitors in the 7800 Series, but the big news from Amtron was the inclusion of a safe title grid as a standard feature on all high resolution monitors. The switchable, pre-set display includes cross hairs to mark absolute center of raster in addition to safe title markers.

Another new feature to aid in setting up and testing picture information is Micro-Rule, an internally generated marker display at 1 μ intervals arranged as a digital horizontal line. Micro-Rule

is adjustable over the screen and can be used as a guide for scene matching.

Asaca showed two ShibaSoku high-resolution monitors, the CMM20-11 and the CMM14-11. Both monitors feature digital sync circuits, I-Q demodulation chroma decoder, a built-in comb filter, and remote control operation.

Conrac showed off its new QQA graphics display monitor by having it hooked up to Ampex's AVA and feeding the output to its booth for "live" comparisons. The QQA will lock on any field rate from 15 to 60 fields per second and any horizontal line rate between 15 kHz and 37 kHz. The horizontal can handle from 500 to 1225 lines per frame. Any three line rates can be preset and selected from the front panel. The monitor comes in 14- and 17-inch models. Conrac also showed its complete line of monochrome and color monitors.

Electrohome had two new color monitors with 800 lines of resolution, a nine- and a 12-inch. Fifteen-, 17-, and 23-inch models were available with 1000 lines of resolution. Electrohome also featured a number of high-resolution monochrome monitors.

Fernseh entered the high-resolution graphics market with the MC-51BAH 20-inch monitor, which includes front panel aperture correction, internal or external sync, pull-out drawer for convergence and other secondary control, and remote control of signal input, sync mode, brightness, chroma, phase, and contrast. A number of other configurations of the 20-inch MC-51BA series were shown.

In the monochrome line, the FMM Series was shown in 9- and 12-inch models. The series offers 800-line center/700-line corner resolution and dynamic focus.

Ikegami had three new series of high-resolution monitors, the 8, 9 and RH series. The 9 Series features an in-line gun CRT with a black matrix, comb filter, and signal generator for checking deflection linearity.

The RH Series features a high-resolution CRT with comb filter, Automatic Frequency Phase Control (AFCP), normal/underscan and remote control.

The 8 Series comes in a modular design consisting of a decoder, a deflection unit, and a power unit for the TM25-8, TM20-8, and TM14-8. The TM14-8R consists of a decoder/power unit, a deflection unit, and a convergence board.

The full line of Barco monitors were shown by both Rhode & Schwarz and E&O Systems, now known as Elector.

Sony introduced two new monitors, the BVM-1900 and the BVM-4050. The BVM-1900 is a 19-inch broadcast evaluation monitor offering 900 lines of

"No-Stretch"  
Phillystran® HPTG

**the only  
flexible  
FIELD  
PROVEN  
electrically  
transparent  
tower-guy system**

1. eliminates EMI and FFI at broadcast sites
2. simplifies installation of AM, FM, AM directional and TV towers. Lightweight, flexible, yet as strong as extra-high-strength galvanized steel\* . . . negligible creep, negligible elongation with new HPTG\* for tension-ance and walk-away installations.
3. maintenance free. Non-conducting, non-corroding, nonmetallic. No internal corrosion. No white-noise arcing across insulators. No insulators required.
4. no more expensive re-guying.

\*Comparative stress-strain data and information about other physical properties available on request.

**Call/write for:  
10 REASONS WHY  
YOUR BEST BUY IS  
PHILLYSTRAN®  
and the new  
PHILLYSTRAN® HPTG**



**PHILADELPHIA  
RESINS CORP.**

20 Commerce Drive  
Montgomeryville, PA 18936  
(215) 855-8450

**an uncommon  
organization  
doing big things worldwide  
in a quiet way.**

Circle 192 on Reader Service Card

# FROM MICRO-TRAK

## NEW MODEL 6509 5 CHANNEL STEREO ROTARY OR LINEAR



## NEW MODEL 6411 STEREO HIGH PERFORMANCE PHONO PRE AMP

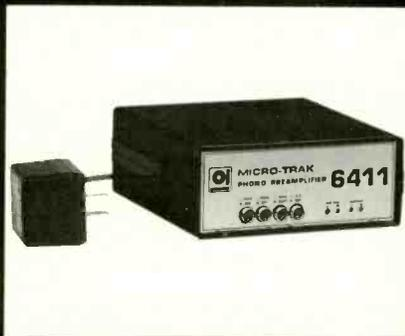

## NEW SPORT IV 4 CHANNEL SPORTS/REMOTE



**MICRO-TRAK**  
620 RACE ST.  
HOLYOKE, MA.  
413-536-3551



Circle 193 on Reader Service Card

## NAB SHOW IN PRINT

resolution, built-in comb filter, and RGB output.

The BVM-4050 is a 3.7-inch field monitor with a high definition Trinitron® tube, pulse cross function, and blue only function for setup. It is plug-compatible.

Tektronix introduced its new 690SR color monitor, a high resolution 19-inch monitor featuring a delta-gun dot shadow-mask CRT, convergence within 0.5 mm, and a pullout drawer containing adjustment and convergence controls.

Videotek introduced a new 26-inch color monitor, the VM-26P, which features A-B inputs, internal-external sync, RGB gun switchers, RGB background and drive controls, raster size regulation, and dynamic focusing with options for pulse cross and underscan.

QSI Systems, Inc., featured a number of source identifiers, including the new QSI VALID Video (Affiliated Line Identifier), which identifies video fields via a digital code on the vertical interval.

QSI also introduced a new master clock system that automatically displays both time and temperature.

**For more information:** Amtron 7800 Series, 671; Asaca CMM20-11, 672; CMM14-11, 673; Conrac QQA, 674; Electrohome, 675; Fernseh MC-51BAH, 676; FMM Series, 677; Ikegami 8 Series, 678; 9 Series, 679; RH Series, 680; Sony BVM-1900, 681; BVM-4050, 682; Tektronix 690SR, 683; Videotek VM-26P, 684; QSI, 685.

### Lighting

Avab America is now manufacturing some of its products in the U.S., including its new Designer Digital Dimmer series. The Dialpatch allows for re-patching the dimmer bank by dialing in the proper channel. Each module in the system can process up to 36 kW.

Electro Controls showed its computerized Lite Cue, which can handle 64 channels and 500 cues and features cassette storage. The portable system has a two-tiered display on the CRT that gives constant visual readout of what is taking place both in preview and "real time."

The Great American Market featured the Lighthesizer™ 212 programmable sequencer, which has eight programmable sequences and 32 steps per sequence. There are 12 channels, an adjustable clock, a master relay output switch, and one master dimmer output.

Kliegl Brothers added a remote control unit to its Performer II™ control console. The remote unit controls all the functions built into the Performer

II™, which can handle up to 125 channels and 500 dimmers with over 200 memories. Also shown was the Kliegpac 9® dimming system. The system includes a dimmer bank and a control console, but each can be used separately.

To add more flexibility to its Cuelog computerized lighting system, Skirpan has increased the number of MCPs (Modular Control panels) available. The single-function module can be expanded to any configuration needed. MCP modules include faders, masters, timer, matrix, houselight, and non-dim or special effects.

Strand Century introduced two dimming systems with multiplex control signals. Mantrix is a manual four-scene preset control console with eight submasters, split crossfader, and matrix patch for grouping of up to 288 2.4 kW dimmers to 84 channels.

Strand Century also featured the CD80 Pack, a portable version of the CD80 dimmer bank.

Teatronics introduced the Datacue II which is a computerized lighting control console designed to interface with other manufacturers' dimmers. Datacue II handles up to 128 channels, up to 1263 cues, 10 group submasters, and timed crossfades.

As for the lights themselves, Anton/Bauer introduced a new handheld light called the "Black Beauty." Officially designated the LG-30, the light can be operated with one hand, including focus and on/off control. The LG-30 includes a swing-away dichroic filter.

Arriflex introduced to this country the Arri Daylight HMI. The system is intended as a total design based on the energy efficiency of HMI, including safe ballasting and distribution. The range of lights includes 200 W, 575 W, 100 W, 2500 W, and 4000 W models.

Belden Communications featured the Lee 200 W HMI portable daylight sungun. The unit had been out of production for a number of years, but is now available again.

Walter S. Brewer Co. showed the Brewer Super Softlite, equipped with four 1000 W quartz lamps. There are individual switches on the front of the panel so that the lighting can be varied from 1000 W to 4000 W depending on the need. There is also an option for a 6000 W version.

Cool Light showed a 2K lamp that it claimed would come within 10 percent of the light from a 10K light. As with all Cool Lights, the heat is dissipated so effectively that one almost has to be inside the light before heat is noticeable.

Also at the Cool Light booth was Starbrite Production Services' Star Pak, a super-compact light kit that includes practically everything one would need in a news or documentary

# UN- LIMIT- ED.

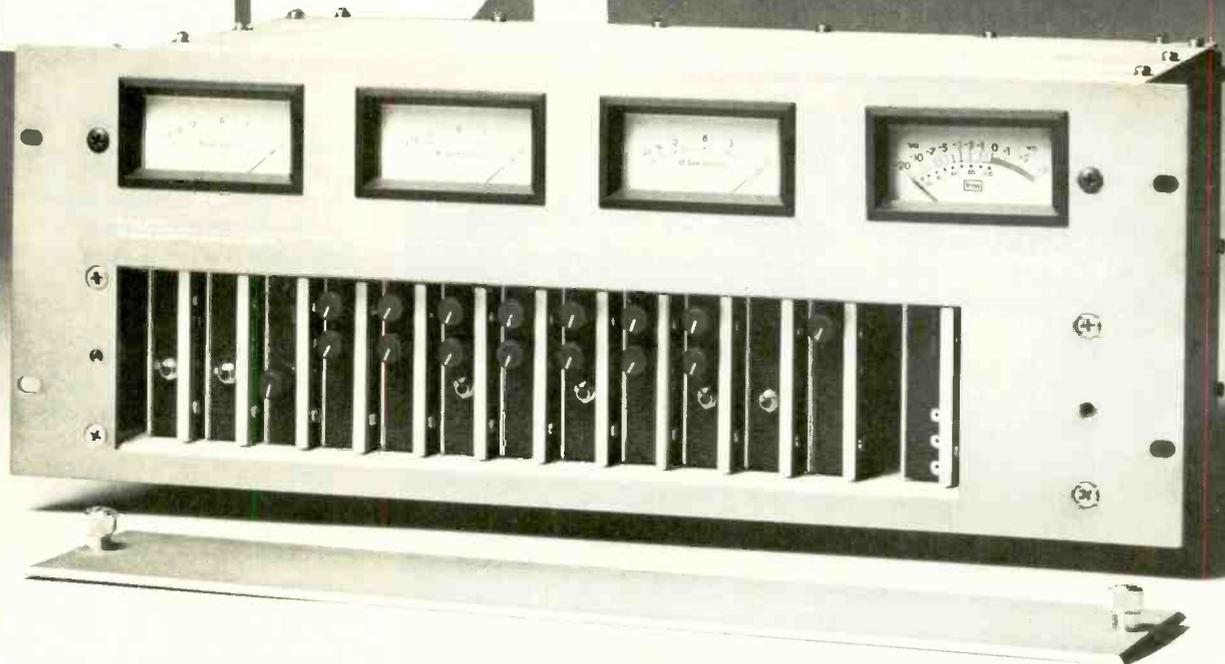

Unlimited in application. Unlimited in flexibility. Unlimited in performance. Don't be limited by the constraints of conventional audio processing. Providing flexibility in adjustment of processing parameters, Gregg Laboratories offers audio processing systems for AM/FM/TV and recording applications.

An all new AM multiband audio processing system has just been introduced by Gregg Laboratories, featuring the only full frequency discriminate gain control and limiting.

**Gregg Laboratories**

2120 East Howell Avenue, Suite 505, Anaheim, California 92806 (714) 937-1100

Circle 194 on Reader Service Card

**CLEAN UP YOUR ACT.** Get rid of unwanted noise from carts and transmission systems. With dbx Type II Noise Reduction, you get a full 40 dB increase in dynamic range. The new dbx Model 140 provides two channels of encoding and two channels of decoding—usable separately or simultaneously. Provision for Jensen output transformers. Active balanced inputs and other good stuff. See your dbx Pro dealer, or write for complete technical information.

\*Manufacturer's suggested retail price.



Model 140 Type II Noise Reduction System

dbx, Incorporated, Professional Products Division,  
71 Chapel St., Newton, Mass. 02195 U.S.A.  
Tel. (617) 964-3210, Telex: 92-2522. Distributed in  
Canada by BSR (Canada) Ltd., Rexdale, Ontario.

**dbx**®

Circle 195 on Reader Service Card

## NAB SHOW IN PRINT

situation. The basis of the Star Pak is the small but powerful Mini Cool light.

Phoebus Manufacturing made its first appearance at NAB, displaying its Ultra Arc follow spot. The unit is built to provide high intensity light in a lightweight package. A long throw version throws a beam about 300 feet; the short throw version goes to 125. Both have six color gels and an autofader.

Strand Century featured the Ianiro line of lights, including HMI Fresnelbutes in 575, 1200, 2500, and 4000 W versions; Bambino 1000 to 10,000 W Fresnels; Pulsar, an all-fiberglass unit



Artel's fiber optic cable system for ENG cameras. The reel holds thousands of feet of cable

for camera mounting; and Mizar, a 500 W fresnelite that, according to Strand Century, is the most powerful lightweight fresnel on the market.

Mole-Richardson showed its line of lights and featured its new Tweenie Mole Solarspot, which puts out 600 W.

Berkey Colortran featured a new eight-inch 2 kW fresnel spot with the sweep focus located on the side of the housing. The lens also opens on the side for ease in changing the gels. Berkey was also showing a new zoom ellipse rated at 1000 W.

GTE-Sylvania and English Electric featured their entire lines of lamps.

**For more information:** Avab America Designer Digital Dimmer, **688**; Electro Controls Lite Cue, **689**; Great American Market Lighthesizer, **690**; Kliegl remote control unit, **691**; Kliepac 9", **692**; Skirpan Cuelog updates, **693**; Strand Century Mantrix, **694**; CD80 Pack, **695**; Anton/Bauer Black Beauty, **696**; Teatronics Datacue II, **697**; Arriflex Arri Daylight HMI, **698**; Belden Lee 200 W HMI, **699**; Brewer Super Softlite, **700**; Cool Light 2K lamp, **701**; Star Pak, **702**; Phoebus Ultra Arc, **703**; Mole-Richardson Tweenie Mole Solarspot, **704**; Berkey Colortran fresnel, **705**.

### Fiber optic sources grow

Fiber optics cabling is not yet a

**LIGHTNING FAST  
YET PAMPERED**

That unique combination of  
20-minute Burp Charger and  
camera mounted, slide-lock,  
super ni-cad battery.

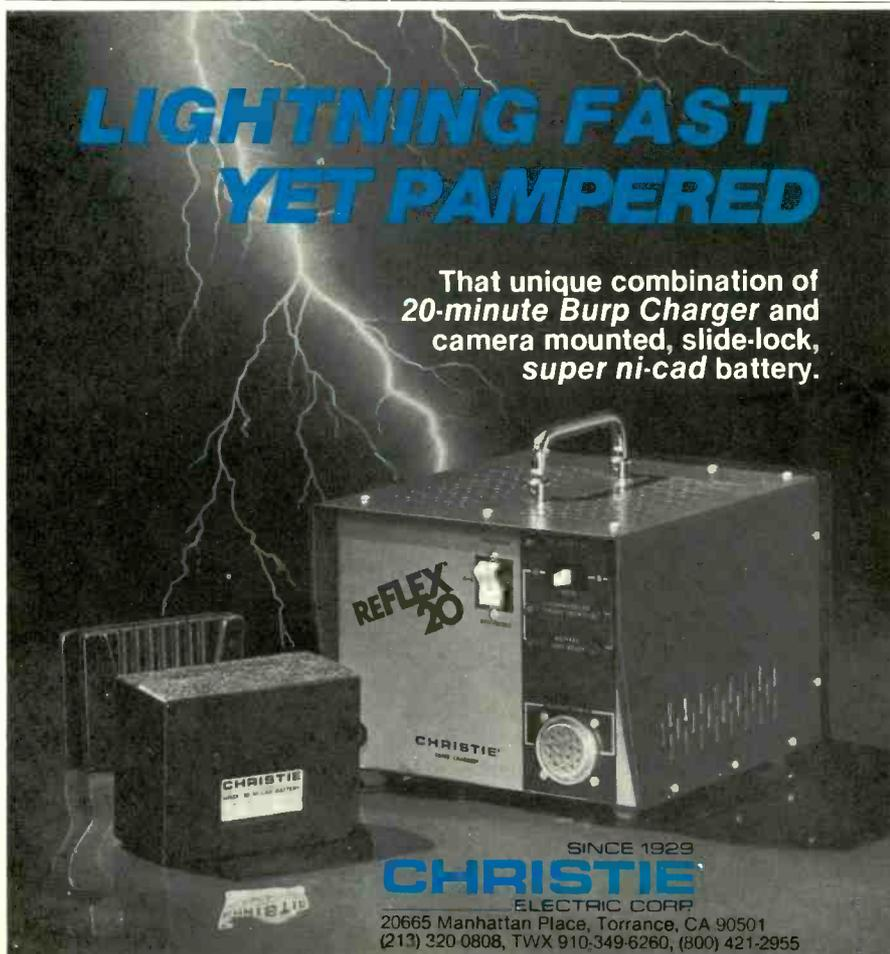

SINCE 1929  
**CHRISTIE**  
ELECTRIC CORP.  
20665 Manhattan Place, Torrance, CA 90501  
(213) 320-0808, TWX 910-349-6260, (800) 421-2955

Circle 196 on Reader Service Card



common everyday experience in television despite ABC's discovery of another suitable application at last year's Democratic National Convention, when the net tied hotel cameras to a remote studio 1200 feet away with a Valtec VS-100 baseband video system — without RFI troubles.

Valtec, now a Philips-M/A-Com venture (50-50), demonstrated the VS-100 system at NAB '81 — along with a variety of fiber cables and other systems designed for data communications.

Telemet, another pioneer in producing a video baseband system (the model 4210 optical transmitter receiver), this year demonstrated the ease of making up cables — adding connectors and making splices — with the hope of encouraging broadcasters to increase their use of fiber optics. Grass Valley Group continued to show a fiber optics video distribution system. More camera manufacturers announced fiber optic cable options. Despite this activity, the subject has not exactly caught fire.

Hoping to set off a charge to get fiber optics the recognition it deserves, a new company, Artel, hit NAB '81 with a bang.

Artel, announced, earlier in April by two former Valtec executives, said in a press release, "We will initially be serving markets that the corporate giants are ignoring. Our first line of products will be aimed at solving special problems of broadcast video transmission."

Indeed, Artel showed up with a complete ready-to-go ENG/EFM system, the EN-1000. This is a field-portable video/audio link intended to connect ENG cameras to news vans or mobile control centers. A small transmitter is carried on a shoulder strap. Miniature Hand-carried portable cable reels pay out optical cable up to several km in length. The system produces a cleaner transmission path than wire cable, more portable microwave, says Artel. Another product is the SL-2000 19-inch rack mounted system, designed as two-mile STL or microwave replacement.

Both systems employ baseband high-intensity LED modulation and PIN detection circuitry and have built-in self monitoring testing and diagnostics. S/N ratios of 70 dB achievable with either system.

For more information: Artel EN-1000, 686; SL-2000, 687.

#### Cables, connectors, hardware

Manufacturers of cables and connectors have served the industry well over the years and it is difficult to find something newsworthy in this field. New connectors and cables tend to track the

# "It's about time."



## TDM-8000 Audio Time Compressor

The TDM 8000 allows recorded audio material to be played back at faster rates than at which it was recorded with the original pitch remaining unchanged. Its patented technology allows the TDM 8000 to handle the most complex program material, with the lowest possible distortion and minimum listening fatigue.

You'll find the TDM 8000 will be invaluable for

compressing video taped segments, first run movies, records, commercials, interviews, etc., to fit pre-determined time frames. And audience retention will actually be improved.

If you've been thinking that it's about time someone produced a truly workable and practical time compressor, the time has come for you to look into the TDM 8000.

### INTEGRATED SOUND SYSTEMS, INC.

29-50 Northern Blvd., Long Island City, N.Y. 11101 (212) 729-8400  
A Subsidiary of The VSC Corporation  
Dealer/Distributor Inquiries Invited

Circle 197 on Reader Service Card

*Still more*

## REASONS WHY BUSINESS COMPUTERS SHOULD COME FROM US

- 7 OUR "MPI" SYSTEM. Provides a MUSIC PLAYLIST AND INVENTORY System as part of BAT® Billing, Accounting, and Traffic.
- 8 OUR "PPI" SYSTEM. Adds FILM/PROGRAM PACKAGE INVENTORY for TV to your BAT System.
- 9 OTHER "ADD-ONS". Lots of them, to make BAT Systems super-flexible, super-suitable to your needs.

BAT Systems have proven, comprehensive options to tailor them to your needs, large station or small, single or group. For better management/headquarters control, profits, and opportunities. Call (800) 243-5300 or (203) 622-2400, or write 600 West Putnam, Greenwich CT 06830.

## STATION BUSINESS SYSTEMS

 a division of  
CONTROL DATA CORPORATION

Circle 198 on Reader Service Card

## NAB SHOW IN PRINT

new cameras available. Thus, Boston Insulated Wire featured many new connectors for the TK-47. BIW also described its expertise in building fiber optic cables, but that was hardly new since it offered the same service last year.

Trompeter offered a new series of TEI connectors for broadcasters installing fire-resistant coax cables made with non-flammable, low-smoke producing FEP materials. Since FEP cables are demisionally different from PVC-type cables, new connectors are necessary, Illinois Cable Co., incidentally, was selling fire-protective signaling cable.

ADC featured a variety of connectors and jacks for mounting directly onto printed circuit boards, plus new QCB terminals, blocks, and broadcast jackfields. Audio patchfields were featured by Farrtronics. Wireworks Corp. had a *big* line of audio interconnect items. A new illustrated price list showed over 800 items, including the company's unique microphone multi-cable component group.

Fast-fit RF coaxial connectors of the BNC/UHF type were shown by Cambridge Products Corp. Both crimp and twist-on types were offered.

For more information: Boston Insulated Wire TK-47 connectors, 708; Trompeter TEI connectors, 709; ADC terminal blocks & jackfields, 710.

### Shipping cases

With more and more stations developing the confidence to travel with ENG equipment, the need for good travelling cases has become more than a ho-hum subject. Most case manufacturers at NAB were making their show debuts.

Anvil Cases is taking the systems approach to shipping cases. The company says it has designed its newer cases to be permanent homes for the equipment. Its first for this purpose houses the Sony BVU which, according to Anvil, "does not need to come out of its protective environment in order to operate."

Cases, Inc. made its first appearance at NAB with its complete line of Roadrunner® ATA cases. The newest addition to the line is the Roadrunner® Endura, which the company describes as one of the strongest, lightest cases made.

Parsons Manufacturing Corp., also making its premiere appearance at the show, displayed its complete line of heavy-duty and lightweight cases.

Another newcomer, Excalibur In-

dustries, featured a complete line of cases, taking the systems approach with a number of cases designed for in-case operation of recorders, audio consoles, and EIA rackmounts. Excalibur cases were shown at the Great American Market booth.

Environmental Container Systems (ECS) is new to NAB, but has specialized for some years in building shipping and operating cases for computers and other delicate electronic equipment. To show how strong the molded fiberglass laminated cases are, ECS tested the cases by firing a .357 Magnum hollowpoint at the case. The bullet got no farther than the first ply of the 10-ply case.

Fiberbuilt, already familiar to the NAB, also displayed a complete line of its ATA cases.

Thermodyne International introduced its new Shok-Stop™ cases. The company says the new polyethylene cases are more shock-absorbent than fiberglass or metal cases. The cases come off the shelf to fit most standard equipment, but can also be custom-made.

For more information: Anvil BVU case, 711; Cases, Inc. Roadrunner® Endura, 712; Parsons, 713; Excalibur, 714; ECS, 715; Thermodyne Shok-Stop™ cases, 802.

## SMPTE EDIT-CODE READER AND CHARACTER-GENERATOR



### THE NEW STANDARD OF THE INDUSTRY

**FEATURES:** The McFadin Window™ wide range digital decoder, highly legible and unique FONT, 1-3/4" rack mounting, vertical interval display, all front panel controls, drop frame indicator, choice of Time-Code or User-Bits, regenerated Time-Code output (DUB). MODEL DR-107A

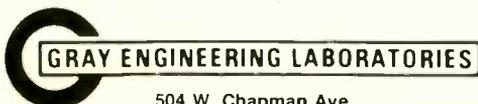

504 W. Chapman Ave.  
Orange, Ca. 92663 714-997-4151

Circle 199 on Reader Service Card

## A NEW FACE ON AN OLD FRIEND

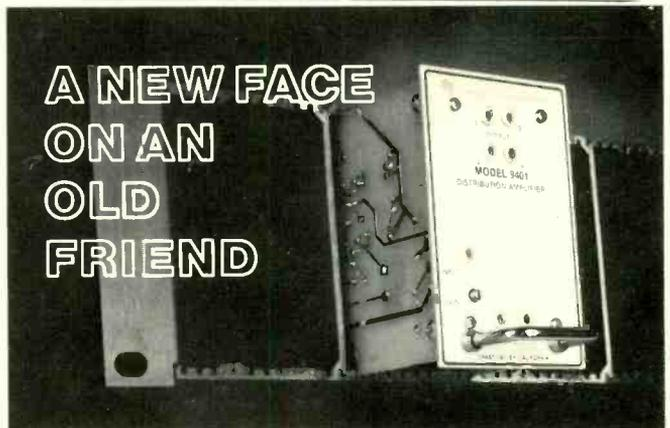

## GRAHAM-PATTEN SYSTEMS

Introduces a New Series of Video  
Line and Terminal Equipment  
that is Plug-in Compatible with  
The Grass Valley Group  
900 Series Equipment

- AVAILABLE NOW — Model 9401 Video, Pulse and Subcarrier DA
- COMING SOON — Specialty DAs, Video Keyers, Mixers and DSKs
- DELIVERY — Stock to Four Weeks



GRAHAM-PATTEN SYSTEMS  
P.O. BOX 1960 GRASS VALLEY CA 95945  
(916) 273-8412

Circle 200 on Reader Service Card

# Why 4 out of 5 earth stations for TV broadcasting are from Scientific-Atlanta

Model 8010 7-Meter Antenna. Designed specifically for television broadcasting. Exceeds all broadcast earth station requirements.

Factory-installed de-icing systems available for severe weather conditions.

Full geostationary satellite arc coverage.

Highly reliable GaAs Fet low noise amplifier. Fully enclosed for weather protection.

Easy to install. Minimal space requirements.

Scientific-Atlanta has designed, built, and delivered more broadcast earth stations than any other company in the world. A lot more. Here are some reasons why.

## SCIENTIFIC-ATLANTA MAKES THE ENTIRE SYSTEM

Scientific-Atlanta builds complete satellite earth station systems for the television industry. Our earth station packages give you everything you need to turn satellite signals into programming revenues. Antennas, receivers, low noise amplifiers, and installation and service.

## THE RIGHT SYSTEM FOR YOUR NEEDS

As the industry's largest manufacturer, we offer a wider choice in complete system packages. And we have the practical, total systems experience to help you put together the earth station to fit your technical requirements. *And your budget.*

A broadcast earth station can be as simple as our Model 8501 Basic Receive-only system. It consists of an antenna assembly, a low-noise amplifier (LNA), and a video receiver.

This is the basic downlink system. It's perfect for operations such as taping satellite programming for future broadcast.

For added flexibility as well as improved reliability, many broadcasters choose our Model 8502 Receive-Only Earth Station. It includes a second set of electronics to give simultaneous reception on two different satellite channels—a significant increase in signal receiving ability.

What's more, the additional electronics serve as back-up units for the primary

set, giving full station redundancy.

Should a malfunction occur in your primary on-line components, protection switching devices are included in the Model 8502 package which will automatically switch those functions over to the redundant stand-by units without interrupting on-line reception.

## SUPPLY YOUR OWN PROGRAMMING

Scientific-Atlanta has supplied 97% of all the satellite uplinks currently in use by commercial TV broadcasters.

When you buy a Scientific-Atlanta uplink, you get the entire package, from the initial site planning advice to the final proof of performance procedure.

If you prefer, the uplink package can include frequency coordination, FCC licensing, and supervision for pouring of the foundation (using local construction crews for minimum cost).

## MORE SATELLITE COVERAGE MEANS MORE PROGRAMMING

Scientific-Atlanta broadcast earth stations are available with full geostation-

ary satellite arc coverage. Your system can "see" all current and future domestic communications satellites from anywhere in the continental United States.

No other antenna system offers more satellite coverage.

Pre-programmable motor-drive systems are available for 7- and 10-meter antennas. You can switch from one satellite to another in 60 seconds or less.

For example, by entering a simple two-digit code into our remote-control antenna positioning unit, your antenna can be switched to a different satellite during a commercial break.

## WRITE OR CALL FOR INFORMATION

Clip this coupon for more information on the most advanced satellite earth station systems available for the television broadcast industry. Or call or write Ron Pearl at (404) 449-2064.

## Scientific Atlanta Communications

BM/E-6-81

Attn: Mr. Ron Pearl  
3845 Pleasantdale Rd.  
Atlanta, Georgia 30340

Please send more information on satellite earth stations for television broadcasting.

NAME \_\_\_\_\_  
TITLE \_\_\_\_\_  
COMPANY \_\_\_\_\_  
ADDRESS \_\_\_\_\_  
CITY \_\_\_\_\_  
STATE \_\_\_\_\_ ZIP \_\_\_\_\_  
BUSINESS TELEPHONE ( ) \_\_\_\_\_

United States: One Technology Parkway, Box 105600, Atlanta, Georgia 30348. Telephone 404-441-4000. TWX 810-766-4912, Telex 0542898  
Canada: 1640 Bonhill Road, Unit 6, Mississauga, Ontario L5T 1C8, Canada. Telephone 416-677-6555, Telex 06983600  
Europe: Horton Manor, Stanwell Road, Horton, Slough SL3 9PA, England. Telephone Colnbrook (02182) 3211, Telex 849406

# SELECT THE ROUTING SWITCHER YOU NEED

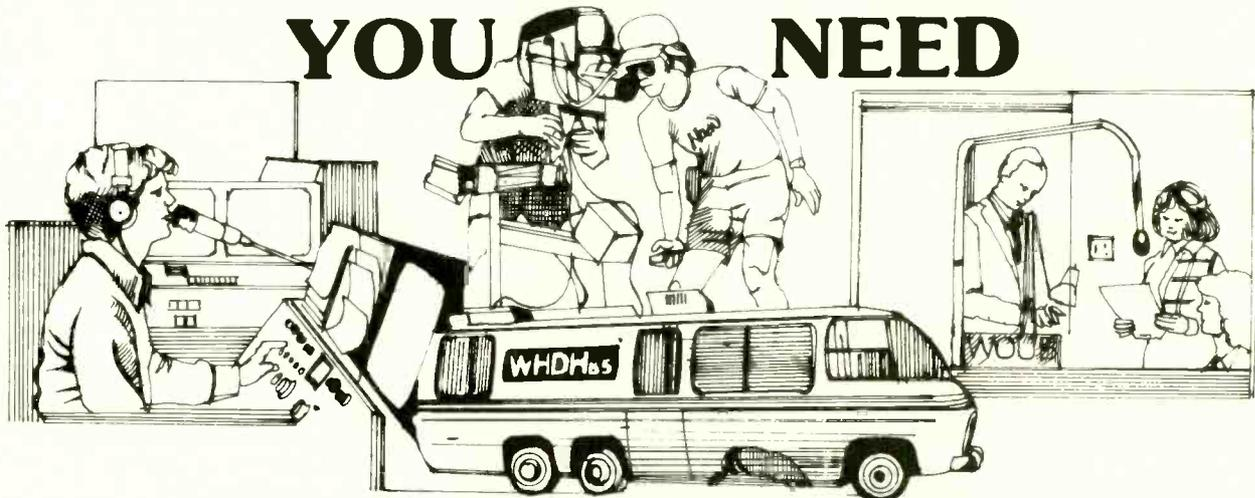

## FROM ONE SOURCE... **di-tech**



**MODEL 5400**  
Matrix Sizes: 4x1, 8x2, 12x2,  
or 3-4x1 or 4x3, AFV



**MODEL 5412**  
Matrix 12x1 with dual audio.



**MODEL 5500**  
Matrix from 16x2 to 28x2, AFV

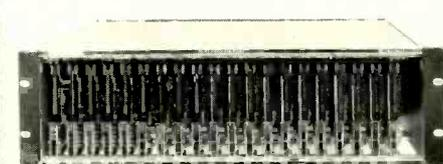

**MODEL 5800\***  
Video Assembly expandable beyond 20x15\*  
Audio Assembly expandable beyond 20x15\*

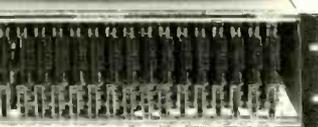
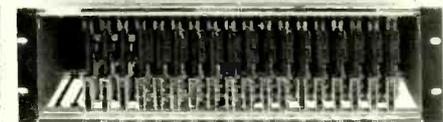

**MODEL 5815**  
Matrix 20x7, AFV with up to  
2 channels of audio per input.



**MODEL 5820**  
Matrix 20x6, AFV with up to  
3 channels of audio per input.



**MODEL 5840\***  
Video Assembly expandable beyond 40x15\*  
Audio Assembly expandable beyond 40x15\*

di-tech knows your needs aren't the same as every other broadcaster, so when we build equipment like audio and video routing switchers we build a whole line of them. That way you can select the exact matrix size and mechanical configuration that meets YOUR requirements, for audio only, video only or audio-follow-video with 1, 2 or 3 channels of audio per input. So why settle for less when you can select di-tech's surprisingly affordable equipment custom-tailored to your needs?

Whether the application be for a radio or television station, mobile vans, remotes or unattended sites, di-tech has equipment for you.

- VIDEO PRESENCE DETECTORS
- TOUCH TONE SYSTEMS
- A/V ROUTING SWITCHERS
- AUDIO MONITOR AMPLIFIERS
- TRANSMISSION LINE SUPERVISION SYSTEMS
- A/V PULSE DISTRIBUTION AMPLIFIERS
- COMPUTERIZED REAL-TIME WEEKLY EVENT CONTROLLERS.

Call or write for more information  
or our FREE catalog today!

**\*Both MODELS 5800 and 5840 feature:**

- up to 3 channels of audio per input within the same frame
- expandable inputs and outputs beyond the stated matrix
- audio only, video only or AFV; V.I. switching

Discover for yourself why industry leaders are switching to di-tech!

# di-tech

311 WYANDANCH AVENUE  
NORTH BABYON, N.Y. 11704  
Tel. # (516) 643-4040

# NAB SHOW IN PRINT RF TRANSMISSION EXPLORES NEW TERRITORY



**Broadcasting has gone after full utilization of available spectrum. Whether point-to-point, satellite, or conventional transmission from the station to the market, equipment has been developed to meet the need.**

## LPTV equipment everywhere

With nearly 5000 applications filed with the FCC, for low-power television stations, it was no wonder that equipment manufacturers were on hand ready to be of service. Indeed, there was equipment and literature on the subject everywhere. Of course, a great deal of this interest was piqued by programming sessions such as "How to Apply for a Low-Power TV Station" and "Low-Power Television, High Priority." In addition, Acrodyne sponsored two three-hour sessions on the subject of low-power television. On its program were a lawyer, a consulting engineer, several antenna experts, and a satellite earth station specialist, as well as Nat Ostroff of Acrodyne.

Sharing the exhibit floor were manufacturers of low-power TV trans-

*EMCEE showed systems for low-power television, including new 1000-watt amplifier expandable into a translator*



Acrodyne showed 1-kW UHF translator and new 10-kW VHF transmitter. Also new were 100- and 200-watt VHF transmitters and translators

mitter/translators, antennas, earth station receivers, and STV decoders. Keen interest was shown in all of this equipment.

Although the FCC put a freeze on all LPTV and translator applications the week before NAB to give itself time to catch up with the flood of applications, the delay was not viewed with alarm by anyone, except translator manufactur-

ers. The extra time (until September) gave all of those who were thinking about filing, but hadn't, time to sort out their plans.

New at the Acrodyne exhibit were 100 and 200 W solid state VHF transmitters and translators, as well as a new 10 kW VHF single-tube transmitter. The new 100 W (Series TT-3300 VH) and 200 W (series TT-3320 VH) units are similar except for the number of hybrid combined amplifier modules. Both have redundant power supplies and rely on proven techniques for transient and surge protection. Acrodyne also introduced a single-tetrode 5 kW aural transmitter amplifier, the model A 1480-U.

Emcee heavily promoted its capability to provide LPTV turnkey systems and hardware. New at NAB was a TVA 1000 C amplifier for which FCC-type acceptance has been applied. This amplifier can be expanded into a translator. Emcee says the unit features high gain, high efficiency, and reliability. It includes solid state control circuits and LED status indicators. The RF stage is a slide-out type. The unit is compact and occupies only a single bay.

Television Technology Corp. showed a new 10 W VHF translator and a solid state 20 W UHF type. TTC also



# THE "MIX AND MATCH" EDITING SYSTEM.

With a Convergence ECS-90 microprocessor-based videotape editing system, you can **mix** 1/2-inch and 3/4-inch formats to your heart's content — and **match** almost all manufacturers' models in these formats.

This means our ECS-90 will fit right in with your existing equipment. Even more important, the ECS-90 will not become obsolete as

you upgrade your VTR equipment, no matter which manufacturer you select.

Best of all, you're getting the fastest, easiest-to-operate edit controller available on the market today, without exception. The ECS-90 works like a high-end editing system, but costs much less.

Easy joystick control of tape speed; high speed search to selected tape location; frame accurate in

SMPTE/EBU time code; auto-tag and recall features; built in sync generator; programmable pre- and post-rolls; and independent audio/video control — plus optional Liplock<sup>®</sup>, Blade<sup>™</sup>, and the many interface options — are just some of the many features that make the ECS-90 the best-selling editing system on the market today. Write or call us for more information.

**CONVERGENCE  
CORPORATION**

1641 McGaw, Irvine, California U.S.A. 92714, (714) 549-3146, TWX (910) 595-2573  
1 Lochaline Street, London W6 92J, United Kingdom, Telephone: 01-741-7211, Telex: 851-27950 MONREF G (Ref. 3801)

Circle 203 on Reader Service Card

## NAB SHOW IN PRINT

offered an informative booklet on LPTV, including equipment prices for various power output and antenna combinations from Scala and Bogner.

At the Thomson-CSF stand, LGT's equipment for LPTV was on display. Since LGT is a world leader in the manufacture of translators, its technology was closely scrutinized. On exhibit were a 100 W transmitter and a 10 W translator for small area coverage, and a 200 W translator and 1 kW transmitter in the UHF area. Efficient units can be solar-powered.

Townsend Associates introduced a totally new concept in the low-power UHF field, combining a solid state transmitter with the antenna. The transmitter antenna of the "Phaestar" (Phase Solid State Transmitter Array) consists of a solid state 100 W amplifier and a broadband printed circuit antenna packaged into a single compact module. Several modules can be combined and phased to form a high gain antenna with omni or directional characteristics. Ten units can be combined to produce 1 kW of transmitter power and an ERP of 80 kW.

Townsend said the Phaestar transmitter antenna eliminates the need for transmission lines and associated losses, requires no transmitter building, and circumvents the need for vacuum tubes and high-voltage circuitry.

Townsend offered two conventional LPTV translators as well: the TA-10 ATH 10 W unit and the TA-100 ATH 100 W unit. The power amplifiers in these series are all solid-state modules with gains of 10 dB. They are wideband and use hybrid combiners. No tuning is required. The amplifiers employ a pair of RF powered transistors in a broadband circuit operated class AB push-pull. Townsend also offered two standard lower power UHF series, the TA-100 ATU and the TA-1000 ATU. The 100 W transmitter becomes the driver of the 100 W unit. An RCA 4228 tube is used as the final.

There were several companies on hand offering turnkey or other engineering services. Both Compucon and ComSearch offered their services regarding site locations, interference possibilities, frequency search, and application preparation. Microwave Associates Communications said it was ready to apply its long expertise in broadcast microwave to LPTV. It offered a turnkey service and stood ready to help plan live satellite or prerecorded programming distribution.

Antennas for LPTV, besides the Townsend Phaestar, were shown by Bogner and Micro Communications, Inc., with information on Scala types available from several translator man-

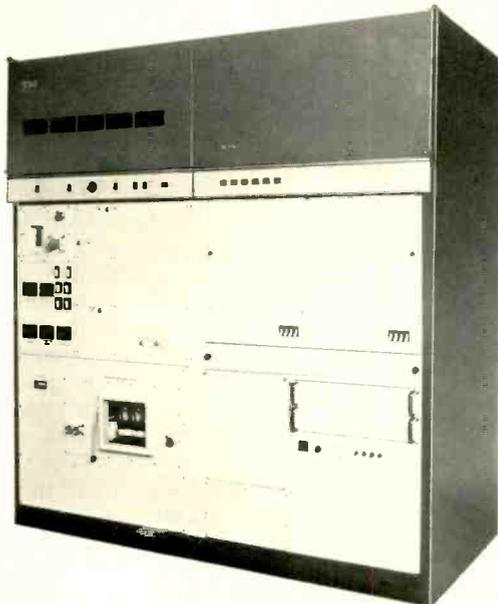

A single-tube 12-kW VHF transmitter was introduced by RCA. It will be available for NTSC, SECAM, and PAL.

ufacturers. The standard Bogner slot assembly seemed to be the most popular low-power UHF type. These 12 dB gain units range in price from \$2950 for the LPS-4 (channels 53-69) to \$3800 for the LPS-1 (channels 14-24).

A useful handout at the Micro Communications, Inc. exhibit was an LPTV RF planning manual. This book analyzed coverage, cost, and performance using MCI 95000 series panel antennas in one- or two-bay arrays for VHF and two-, four-, or eight-bay arrays for UHF.

**For more information:** Acrodyne 100 W, 716; 200 W transmitters, 717; A 1480-U transmitter amp, 718; Emcee TVA 1000 C amp, 719; TTC 10 W VHF translator, 720; 20 W UHF translator, 721; Townsend Associates Phaestar, 722; Compucon, 723; ComSearch, 724; Microwave Associates, 725.

### More high-power developments

BM/E's separation of television transmitter equipment into low-power and high-power products creates a bit of a problem because there is a continuum in power ratings. Companies best known for their low power work such as Acrodyne, Emcee, and LGT, also cross over into the higher power world. Our previous section on LPTV essentially cut off at power levels of 100 W VHF and 1000 W UHF (FCC rules for LPTV). This section on high power therefore really extends downward to include some relatively low-power devices not part of the LPTV series.

Acrodyne introduced a new 10 kW VHF transmitter, the TT-3500 VHF. Using a 200 W solid state driver, the TT-3500 VH uses a single tetrode output stage. Hypervapotron® cooling helps to offer a quiet compact system with good overload protection. All circuits in the new transmitter are broadband. Visual and aural signals are com-

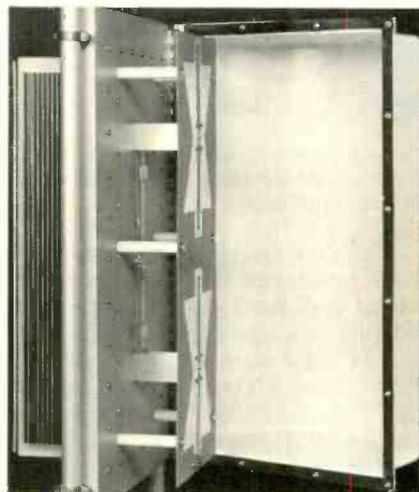

Townsend's "Phaestar" combines a UHF 100-watt amplifier and antenna into one unit; ten units can be put together for 1 kW RF, 80 kW ERP.

bined at lower levels and amplified together in the output stages. Acrodyne says the high linearity of the tetrode produces very low intermodulation generation. The final tetrode stage, with a coaxial cavity, has a bandwidth rating twice the signal bandwidth.

Canadian General Electric this year introduced a high-band 30 kW unit, the TCC 30000 FH. The transmitter employs low-level IF modulation and is completely solid state except for two tubes — one in the final visual, the other in the final aural. A practical, highly efficient design is achieved with UHF/microwave power transistors and combinations of lumped and Microstrip distributed circuit elements, combined with coax hybrid couplers. Each power module consists of two transistors operating push-pull to reduce second harmonic distortion. The modules are connected via quadrature couplers to permit parallel operation. The entire unit is contained in four cabinets.

## NAB SHOW IN PRINT



Eimac brought a new power amplifier cavity, CV-2240, for low-band TV; amplifier uses 3CX10.000U7 triode

Canadian GE also introduced 2 kW UHF translators. These units combine visual and aural carriers through an internal diplexing circuit. The exciter is a 2 W solid state unit followed by a driver using a YD 1381 plan, a triode, and a PA stage with ultralinear tubes of the RS 1054L type.

Comark Industries, in keeping with its heavy emphasis on high-efficiency UHF transmitters, introduced a fiber optic mod anode pulser to achieve the highest level of energy efficiency. The unique feature of this equipment is the fiber optic link between the video input control chassis and the floating high voltage switching circuit. Not only is dielectric isolation provided, but the system is immune to RFI and EMI distortion. The CTP-4500 includes high voltage interlocks and other safety features.

Another new Comark product was an automatic switching system for multiplex purposes. Visual and aural amplifiers can be switched without connecting and disconnecting cumbersome patch panels. Both coaxial and wave guide types were offered. Also introduced was a new remote control system incorporating a new-generation microprocessor. The CI5080 provides control and monitoring of a number of functions over two-way audio frequency channels. The system handles 250 status command circuits. Data is displayed on a video monitor and is organized on a page basis. Commands are entered by a keyboard.

Harris introduced a new low-band 30 kW VHF transmitter, the TV-30L. Among its features is an ultralinear driver with solid state IPA and broadband amplifiers. It operates broadband class A. A single conservatively rated tetrode is in the visual driver.

Vestigial sideband filtering in the visual exciter is accomplished with Surface Acoustic Wave technology. The Transversal Side Band (TSB) filter displays a nearly ideal bandpass function for systems M (FCC) and B bandwidth, according to Harris. This, combined with the filter's true linear phase characteristic, offers excellent reproduction of pulse waveforms and encoded information.

The TV-30L has low-level IF modulation and features true linear power amplifiers. The transmitter can be configured in many ways and is designed for remote control and ATS operation.

LGT showed a 1 kW VHF hybrid modulation transmitter based on a new highly efficient TV signal generation process.

NEC, a major transmitter supplier to Japan and other parts of the world, has begun to make inroads in the U.S. The NEC exciter's ability to handle stereo audio (FM-FM signal), as shown at NAB '81, makes it attractive to those anticipating a U.S. move in this direction. At NAB '81, NEC brought its PCU-700 line, which ranges from 5 kW to 80 kW. A PCU-711 is rated at a 110 kW through paralleling. The series uses high-efficiency klystrons of the 1AV57, 67, and 97 series. The high-performance exciter includes non-distortion compensation circuits and pedestal AGC to maintain constant output power levels. SAW VSB filters are used.

NEC also discussed its PCN-1200 series VHF transmitters, which include broadcast power amplifiers with a minimum number of vacuum tubes. Power outputs range from 1 to 25 kW.

RCA, which in previous years introduced 16, 30, and 50 kW transmitters (the G-line), this year broadened its line to include a high-band 12 kW unit, the TVG-12H, system M. This transmitter combines visual and aural amplification and eliminates the aural driver tube.

With only a one-tube amplifier stage, the transmitter is simple to operate and maintain. All other circuitry is solid state. The exciter employs only one TCXO (Temperature-Compensated Crystal Oscillator) operating on a standard frequency. A unique phase-lock frequency synthesizer generates any other channel. The transmitter takes up only two cabinets and is equipped for remote control. In the event of a power interruption of up to 10 seconds, the control system will bring the transmitter on the air within two seconds of

power restoration.

The Townsend Associates exhibit stressed the company's role as a major UHF transmitter source by virtue of the 20 UHF models it offers, ranging from 10 to 220 kW. Most models operate with klystrons, but a "tetron" series was also shown, which uses a tetrode aural amplifier in 10 and 30 kW transmitters. The company has designed solid state aural drivers of up to 200 W. A new innovation this year is a fully solid state pulser utilizing fiber optics for high voltage isolation.

The fiber optics isolate video and the IF chassis from high voltage circuits. Townsend says its pulser also overcomes the awkward and even dangerous interface of the pulser with the beam power supply by employing two small bias supplies as source voltages rather than using beam supply directly.

**For more information:** Acrodyne TT-3500 VHF, 726; Canadian GE TCC 30000 FH, 727; 2 kW UHF translator, 728; Comark fiber optic pulser, 729; auto switching system, 730; CI5080 remote control, 731; Harris TV-30L, 732; LGT 1 kW VHF, 733; NEC PCU-700 line, 734; RCA TVG-12H, 735; Townsend pulser, 736.

### Improved transmitter tubes

Should your UHF transmitter have klystrons or tetrodes? If you opt for klystrons, should they be external cavity tuned or internal? These are not easy questions to answer since there is much development work going on regarding tubes and cavities.

Tetrodes are more efficient than klystrons, but generally they have been limited in power. At high power levels it has been difficult to get high gain and to achieve high linearity and the tubes are prone to spurious oscillations. Thomson-CSF says it has overcome these limitations, citing its TH382 10 kW tetrode as an example.

EEV stressed its K 3276 high efficiency four-cavity amplifier klystron for high power. This tube produces 50 kW in the 470-596 MHz band.

NEC said its external cavity UHF TV klystrons of the 1AV57, 58, and 59 type (10-12 kW output) are very efficient—typically 55 percent at saturation levels.

Varian distributed at its exhibit a special report on high efficiency UHF TV, authored by RCA and Varian engineers. The conclusion said that internal cavity klystrons could be made as efficient as external cavity types by means of a visual output coupler designed by Varian. Both new and existing transmitters can reach maximum efficiency with the coupler, the report said. This coupler, although still experimental, was shown at both the Harris and RCA exhibits. Meanwhile, Varian's Palo Alto Microwave Division showed some high efficiency external cavity klystrons, the 4 KM series,



# Don't let your station sound like a phone booth.



Every broadcaster knows the problems of on-air telephone links. The garbling when announce-feeds go out simultaneously through the board and the phone. Or the mysterious cutoffs in the middle of an important interview when line noise or sibilants generate 2600 Hz for a disconnect signal.

A lot of stations—network flagships and others—who've had to face the problems have also found the answer: the Studer Telephone Hybrid.

With sidetone attenuation of up to 40dB, producing maximum isolation between send and receive circuits through an active self adjusting bridge network, and a 12-Henry choke on the input to ensure positive exchange lock-in, the Studer Telephone Hybrid is simply designed to do the job right. 30dB/octave receive and 12dB/octave transmit filters eliminate unwanted signals that would muddy the on-air clarity you've built into your station. All phone line requirements are automatically matched, and a built-in limiter

and white-noise generator are included to give you adjustable overload protection and privacy. All in a 1¾ inch rack mount unit.

Studer can ensure a clean link for all your console feeds. The Telephone Hybrid maintains air quality on telephone talk shows, news feeds, and phone interviews. And our active-circuit Stereo Balancing Unit couples balanced ins and outs to single-ended recorders, equalizers, limiter/compressors or other unbalanced gear.

For more information on how to keep your station from sounding like a "wrong number," call or write today.

## **STUDER INTERNATIONAL AG**

Headquarters: Regensdorf, Switzerland: tel. (01) 840 29 60  
USA (Nashville): (615) 254-5651, France (Paris): 533 5858  
England (Hertfordshire): 01 953 0091  
Australia (Sydney): 406 4557  
Brazil (Rio de Janeiro): 021 287 6198

## NAB SHOW IN PRINT



Microwave Associates had ENG system installed in remote-pickup car; also shown were airborne ENG systems



"Copter Pod" from Nurad is airborne ENG system; company also showed new "Mini Pod", a smaller version, also with four directional antennas pointing left, right, fore, aft

which use 10 percent less power than older types.

The Eimac division of Varian promoted the new CV-2200 low-cost practical cavity for high-performance tubes in the FM band. In this cavity, tubes are grid driven for high gain.

Other cavities on display were designed for high linearity and high stage gain triodes in the low TV band and high band. Eimac tubes on display ranged from high mu-triodes to power tetrodes. One was the 4CX12000A/8989, for which Eimac claimed high RF operating efficiency. The highly efficient 4CX40000G was described as a state-of-the-art ceramic-to-metal air-cooled power tetrode ideal for FM, RF linear power amplifiers, and VHF linear amplifier service. A relatively new tube was the 4730 planar triode, intended for TV translator service. A series of travelling wave tubes for satellite use was also shown.

For more information: Thomson-CSF TH-382, 737; Eimac CV-2200 cavity, 738.

### Microwave for ENG

Harris Farinon Video came out with what had to be the most agile of the

frequency-agile transmitters. The Global IX is built to operate on any 2 GHz plan in the world. It allows for selection of 55 channels in each of the 16 different frequency plans in the 1900-2700 MHz range. The output is 3 W with an auxiliary 12 W amplifier. It will accept either a standard video line input or a 70 MHz IF input.

Microwave Associates took to the air with its new transmitter for helicopter use. The MA-2MX Mini-Mac<sup>TM</sup> is a frequency-agile unit with 21 channels that operates in the 1.990 to 2.110 GHz range. Power output is 12 W. The remote control unit allows full control over the transmitter from inside the helicopter. Both units weigh less than six pounds. The company also emphasized the total airborne system. Everything was shown from Sky Scan<sup>TM</sup>, auto tracking to retractable antenna mounts.

Nurad is also heavily into the airborne use of ENG microwave technology. This year Nurad introduced a smaller version of its Copter Pod<sup>TM</sup> system, the Mini Pod<sup>TM</sup>. The new system incorporates many of the features of its big brother: four circularly polarized directional transmit antennas pointing left, right, fore, and aft; Auto Transmit<sup>TM</sup> control on the MS2 antenna selector switches to the antenna closest to the receive point; the optional MiniPAC<sup>TM</sup>

**"We evaluated all carts and have standardized on the Audiopak<sup>®</sup> AA-3" for music"**

—Bob Kanner  
Chief Engineer  
KRTH, FM 101  
KHJ, AM 93  
Los Angeles

"Our test results show that the Audiopak<sup>®</sup> AA-3 holds stereo phasing better than any other cart on the market."

"The excellent phase stability of the AA-3 will be of major importance as AM stations convert to stereo."

"The High Output, Low Noise (HOLN) tape in the AA-3 gives us excellent frequency response combined with 6db more headroom."

"The AA-3 maintains excellent tape motion with low wow and flutter."

"The AA-3 is the 'state of the art' in cartridges — it meets or exceeds the specifications of the current NAB standards."



Capitol Magnetic Products  
A Division of Capitol Records, Inc.  
6902 Sunset Boulevard  
Los Angeles, California 90028  
(213) 461-2701

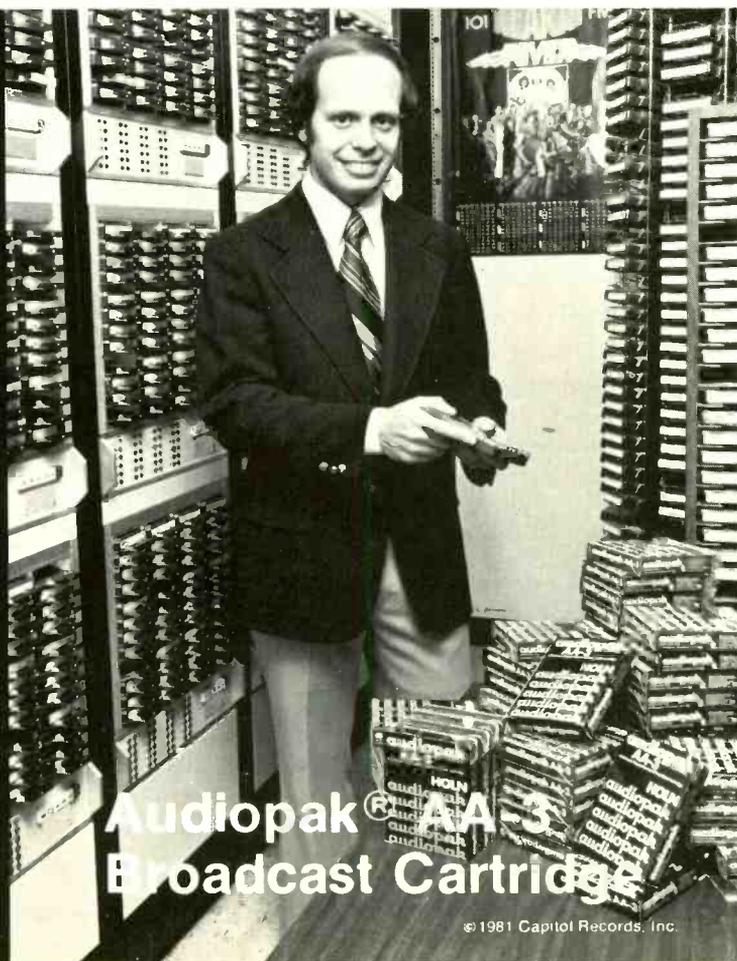

**Audiopak<sup>®</sup> AA-3  
Broadcast Cartridge**

© 1981 Capitol Records, Inc.

lightweight, frequency-agile transmitter/receiver which can also be used for non-airborne ENG operation.

Nurad was also showing the new version of its Goldenrod<sup>TM</sup> antenna, the Goldenrod<sup>TM</sup> D series. The new series features switchable circular polarization (CW/CCW) on a wide band (2–2.7 GHz). A new amplifier, the 20PA15, powers the antenna. The 20PA15 is mounted at the antenna atop the mast, cutting RF line insertion loss to a minimum. The built-in RF/dc diplexer eliminates a separate power cable.

RF Technology introduced its compact frequency-agile (21 channels) transmitter, the RF-212, which has a high/low switch for 3 or 12 W. The RF-212 is designed for both airborne and ground use with minimal change-over time. A mounting bracket for tripod use contains a combination heat-sink and power supply.

Tayburn also joined the super-compact frequency-agile transmitter sweepstakes with its new TBT-50-A transmitter, which has 21 channels on the 1.990–2.110 GHz range or nine channels on the 2.450–2.500 range. When used in conjunction with its companion receiver, the TBR-50-A, it forms the lightest of the airborne transmit/receive systems. Hughes Helicopter has made much of its use of the TBT-50-A in its smallest chopper, the

300C, as a lower-cost method for stations to get into airborne broadcasting.

TerraCom has a new lightweight transmit/receive system, the TCM-7 Miniwave. While it isn't designed for helicopter use the way some of the super-compact are, it is nonetheless extremely portable. The frequency agility for the Miniwave is provided by interchangeable RF modules that cover the frequencies from 1.7–15.35 GHz.

**For more information:** Harris Farnon Global IX, 739; Microwave Associates MA-2MX Mini-Mac<sup>TM</sup>, 740; Nurad Mini Pod<sup>TM</sup>, 741; Goldenrod<sup>TM</sup> D, 742; RF Technology RF-212, 743; Tayburn TBT-50-A, 744; TerraCom TCM-7 Miniwave, 745.

### Weather radar systems

Computer assistance has been giving a leg up to weather radar and satellite systems, those newsroom tools that barely existed four years ago. Last year, only a handful of companies showed weather systems designed for television. This year no fewer than 10 manufacturers arrived in Las Vegas with weather reporting systems.

The hot ticket this year came from Weathercaster, a Salt Lake City company at its first NAB, which showed its CT-1000, a dual-processor computer system that forecasts local weather for

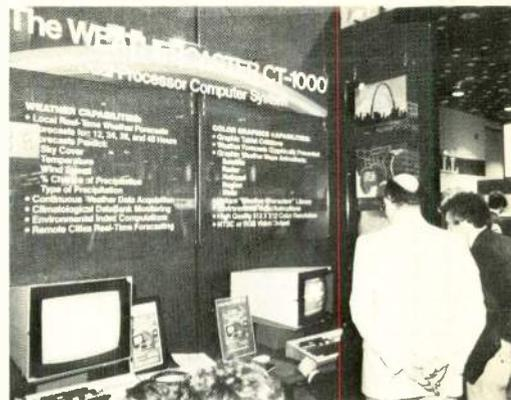

Weathercaster had computerized system for making local forecasts, presenting them in many graphic forms

up to 48 hours. The CT-1000 combines two computers — one for color graphics creation and display, the other for processing information from rooftop sensors that are part of the system's \$69,000 package. Software includes weather equations customized for the broadcaster's locality (the system covers a radius of about 40 miles), which, when taken with information from the rooftop sensors, can be combined with computer graphics to animate weather map forecasts.

Although Weathercaster's local real-time forecasts are its selling point, other presentations that can be created

## Choose from two new recording electronics packages from Inovonics.

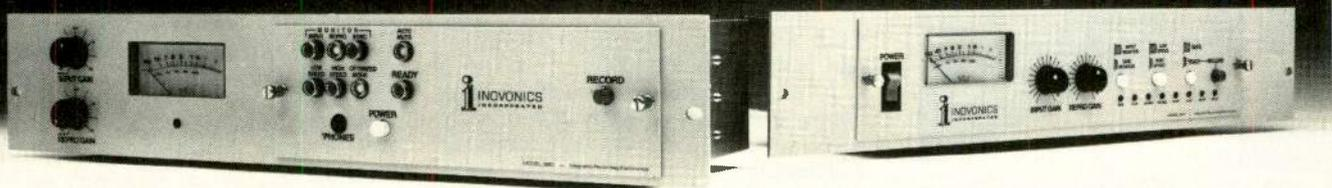

**Model 380** is the upgraded successor to our well-known 375, used in hundreds of studios and stations around the world. With your tape transport and our 380, you have the ultimate analog recorder. Features of the 380 include:

- Advanced circuitry to reduce the effects of tape compression and phase distortions.
- Unprecedented signal and bias headroom for

full compatibility with highest-coercivity tapes.

- Two "workhorse" EQ and bias settings, plus an optimized mode with separate setup for best performance from "super" tapes.
- Compatibility with virtually any combination of transports and heads.
- SYNC reproduce, "pick-up" record and exclusive auto mute.
- Remote control of all functions.

## The perfect pair

Use the 380 to create new, ultimate-performance recording equipment, or to give your old tape or mag-film recorder a sound so clean you must hear it to believe it. \$820.00

**Model 370** is intended for routine replacement use. It is compatible with most studio transports and a wide variety of original and replacement heads. The 370 will make "new" machines out of your older studio recorders, delivering superior performance and great reliability. \$580.00

For more information, see your distributor or contact us today.

### Inovonics Inc.

503-B Vandell Way  
Campbell, CA 95008

Telephone  
(408) 374-8300



## NOW! CONTINENTAL'S 1 KW FM

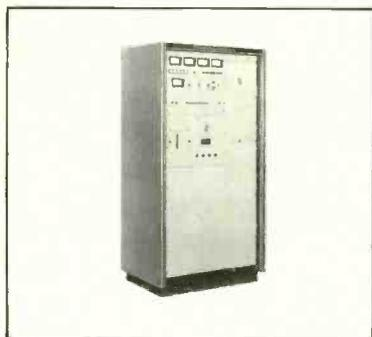

**High-Performance 1.25kW** transmitter uses field-proven exciter; delivers clean, crisp signal; has automatic filament voltage regulation, power control; is suitable for unattended operation; is solid-state except for one tube in final amplifier; provides efficient, cost-effective operation.

Write for brochure on 814R-2  
Continental Electronics Mfg. Co.  
Box 270879 Dallas, TX 75227  
(214) 381-7161

**Continental Electronics**

Circle 207 on Reader Service Card

## swintek

The Leading Name In  
Cordless Microphone Systems

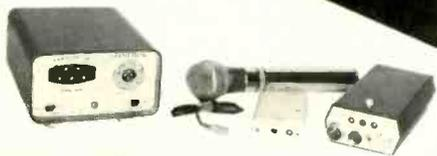

Transmitters small enough to be hidden almost anywhere, tiny microphones that are so unobtrusive that they probably won't even be noticed, hand-held microphones without the encumbrances of hundreds of feet of wire — that's what cordless microphone systems are all about. But there's one more factor of prime importance — reliability. If you're in television, radio or film and you want a cordless microphone system that not only offers the most advanced state-of-the-art electronics but the highest reliability rating in the industry, Swintek is the answer. There's a Swintek transmitter and receiver to fit your specific needs, no matter what your requirements. Check with us today about the greatest name in cordless microphone systems — Swintek.

**alan gordon enterprises inc.**

1430 N. Cahuenga Blvd., Hollywood, CA 90028  
Telephone: (213) 466-3561 • (213) 985-5500  
TWX: 910-321-4526 • Cable: GORDENT

Circle 208 on Reader Service Card

## NAB SHOW IN PRINT

include satellite, radar, and national map animations (as well as news and sports graphics) at a resolution of 512 by 512. For radio stations, the company offers its R-300, a standalone computer that gathers weather information and computer weather predictions. It will predict, within a 48-hour period, sky cover, probability of precipitation, temperature, and wind characteristics. An optional computer voice synthesizer for on-air broadcasts is available.

Last year, Information Processing Systems of Belmont, Calif., was touting its \$43,000 WP-3312 weather satellite recorder, which provides forward or reverse playback pictorial from National Oceanic and Atmospheric Administration (NOAA) satellite inputs. Now the company has pulled the wraps from two microprocessor-assisted color graphics systems that make this outfit a very serious contender in professional computer graphics.

IPS also showed the Model CGS-1000, a weather graphics color system that features a memory of 88 Kbytes, held on two image solid state storage frames with single-port access and a floppy disk. Any 14 of more than 4000 colors can be selected with a light pen from an interactive grid pad. Cost of this model, with a 256 by 242 pixel resolution, is \$15,800.

A higher resolution model (512 by 484 pixels), the CGS-4000, was not quite finished in time for NAB, but the company claims it will be ready about the time this report is in print. The CGS-4000 has a 280 Kbyte memory and is priced at \$21,000.

A new remote radar receiver and computer graphics display system with a 16-frame memory was introduced by Technology Service Corp. of Santa Monica, Calif. Designated the RRT 77-16, the unit can interface with Radio Shack, Apple, or any other inexpensive graphics control minicomputer.

Any of the 16 stored pictures, automatically recorded from weather radar, satellite, or computer graphic sources, can be randomly selected by an operator. Playback can be anywhere from 1/8 second to 10 seconds for each frame. Precipitation levels can be flashed from memory, and the unit features a 16-quadrant 2:1 zoom.

Sperry Marine showed up with something it lacked last year — a colorizer for its radar systems. Built by Denrad Technical Group, the rack-mount colorizer is microprocessor-based, with the flexibility to display a station's logo on one page and weather on another. The six-color display is resolved at 256 by 256, and a joystick cursor and selectable flash level are part of the

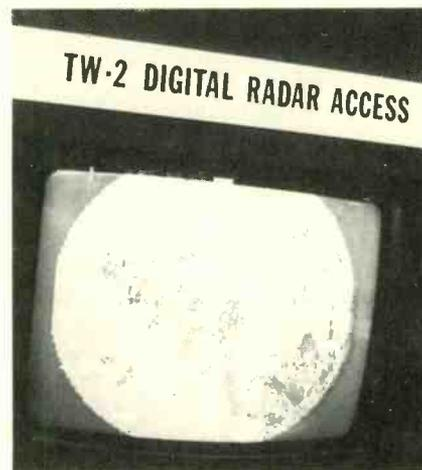

Arvin TW-2 digital access system interfaces with NOAA data and presents forecasts on display screen

package. The Sperry/Denrad colorized radar has three selectable ranges that can pick weather information up as far as 170 miles away.

New options that Weatheration is offering for its color remote system include a variable speed analog sweep line that rotates smoothly — it does not "tick" — from zero to 20 rpm. Four additional memories can be added to the system, which tracks weather from 70 to 300 miles, to give an eight-frame total memory. Another new option for the system is Quadsearch, a push-button-operated cursor that allows a 3:1 quadrant expansion.

The company also unveiled a high-resolution graphics system — 640 by 240 pixels — that features rotating image and intrinsic functions that the unit generates itself. Although dual eight-inch floppy disk drives are standard, a 30 megabyte Priam 3450 Winchester could be substituted for a disk.

Arvin came to the show with its SW-3 signal processor, an upgraded version of last year's SW-2 Sat-Weather, which converts NOAA satellite weather pictures into color video. Although digital disk storage — with a 200-frame memory — is not new to Arvin's Sat-Weather system, the new signal processor features selectable input (either GOES-TAP telephone line or WEFAX signal) and two picture storage memory, which prevents an incoming picture from being displayed until completed. Other features include four color underlay programs that can be stored and called up automatically, an auto-decode that automatically selects up to four preprogrammed pictures, a header blanking switch that displays time, date, and sector selectively, and a special graphics memory that holds and reinserts exact graphics.

Colorgraphics Weather Systems of Madison, Wis., was on hand with its LiveLine color satellite computer, which interfaces with Environmental



# Exceptional reproduction.

# Without exception.

For mastering and duplicating applications, you need audio tapes that are capable of flawless and dependable reproduction—all the time, under all circumstances. Editing and recording sessions are very demanding on all tapes. Maxell is made to take this kind of punishment, and then some! Our tape is manufactured with the studio engineer in mind, providing all the advantages of our most advanced tape technology.

You can depend on our state-of-the-art magnetic oxide formulas that can handle every signal with plenty of headroom to spare. And because of special calendaring techniques, our tape finish is mirror-smooth, virtually eliminating dropouts.

The advantages of Maxell audio cassettes and professional open reel product don't end with our superior tape. Our cassette shells and take-up reels are manufactured to tolerances far exceeding industry standards. They silently and dependably transport the tape without stretching, jamming or breaking. Not only do you get a more faithfully reproduced signal with Maxell tape, you get to keep it longer, thanks to our advanced binder and mixing techniques. There are many other advantages to using Maxell. To discover more about Maxell's superior products, call one of our Regional Sales Offices: Eastern Office, Moonachie, NJ (201) 440-8020 ■ Midwestern Office, Glenelg, IL (312) 469-3615 ■ Western Office, San Jose, CA (408) 238-2900

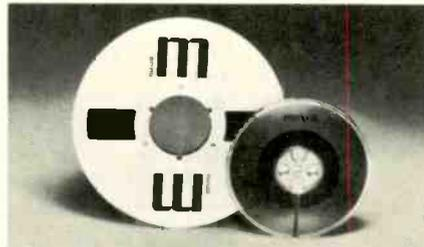

**maxell**  
PROFESSIONAL  
INDUSTRIAL  
PRODUCTS

*The Professional Advantage*

Maxell Corporation of America  
60 Oxford Drive, Moonachie, NJ 07074

## ULTRA-LIGHTWEIGHT TELESCOPING

### MICROPHONE POLES



#### THREE MODELS:

- ★ Sm.—15½" to 46½"—  
Wt. 8.5 oz!
- ★ Med.—22" to 67"—Wt. 9 oz.!
- ★ Lg.—4' to 13+ '—Wt. 22 oz.!

#### SUPER-STRONG, PLUS

- ★ No-glare black Epoxy finish
- ★ Smooth, silent telescoping
- ★ Ideal, comfortable balance
- ★ Knurled friction lock
- ★ Intl. Std. threaded stud

#### MICROPHONE SUSPENSION:

- ★ Simple, secure!
- ★ Wt. only 3.25 oz.!
- ★ Threaded yoke support  
—no nut necessary



**LTM CORP. OF AMERICA**

1160 N. La Palms Avenue, Hollywood, CA 90038 • (213) 460-6166  
LTM FRANCE: 104 Boulevard Saint-Denis • 92400 Courbevoie-France

Circle 210 on Reader Service Card

## For TV NEWS and RADIO

### MODEL MA 3CT MIXER-AMPLIFIER



- 3 MIKES OR 2 MIKES/HI LVL SOURCE
- AGC W/DEFEAT SWITCH
- HEADPHONE AMPLIFIER
- 2" X 4" X 5"
- TONE OSCILLATOR
- 50 DB and LINE LVL OUT

OVER 300 IN USE

[One Year Warranty]

Write for Brochure.

## Transist-O-Sound

728 YOSEMITE DRIVE  
INDIANAPOLIS, IN 46217  
PHONE: (317) 897-1549

Circle 211 on Reader Service Card

## NAB SHOW IN PRINT



Mobile satellite uplink of  
Transportable Earth  
Stations uses Compact  
Video 7-meter antenna  
and electronics

Satellite Data Inc.'s dial-up service. Processed weather satellite pictures — including enhanced cloud images — can be on the air within minutes. Colorgraphics and ESDI are working together to expand weather satellite data for real-time weather presentation.

Other weather systems that were displayed at Las Vegas were seen last year. They included Enterprise Electronics Corp.'s color weather radar system that is remoted by telephone lines, and McInnis-Skinner & Associates' NewsCan Weathergraphics, a mini-computer system that generates map displays either from Weatherscan's Oklahoma headquarters or from within the broadcaster's studio. Gorman-Redlich showed its receiver for NOAA weather radio, a rack mounted unit designated Model CRW that costs \$325.

**For more information:** Weather-caster CT-1000, 746; R-300, 747; IPS CGS-1000, 748; CGS-4000, 749; Technology Service Corp. RRT 77-16, 750; Sperry Marine colorizer, 751; Weatheration sweep line, 752; Quadresearch, 753; graphics system, 754; Arvin SW-3, 755; Colorgraphics LiveLine, 756.

### Satellites: post-show summary

In May, *BM/E* described briefly the satellite hardware and service exhibits at the show, based on a rapid survey made during the first day of the program. Later, interviews with a number of the exhibitors made it clear that this was, indeed, the turnaround year for broadcaster interest in satellites. A number of large-market stations, and especially group ownerships, were actively informing themselves on earth station technology and availability. The 19 dishes on the parking lot had scores of visitors who were finding out all they could about this new technology.

In our May report, Compact Video should have been included as a satellite service organization as well as a maker

of uplink and downlink hardware. Compact has a studio in Burbank, CA, allowing complete production of television and radio programs for sending to the satellite through 10-meter uplink systems on the spot. The studio is rentable to software producers who want to reach the ever larger audience connected, through radio, to satellite earth terminals. Compact Video is also emphasizing the uplinking of programs with its seven-meter transportable system, which can be sent anywhere.

Another company moving into satellite electronics (missed in our May report) is McMartin. At the show McMartin introduced two units, the SMR-1 modulator and SDR-1 demodulator, operating in the 50-80 MHz range, and useful for single-channel per carrier satellite communications. The SMR-1 accepts a +10 dBm audio input, and provides RF up to +10 dBm. The SDR-1 has squelch and alarm circuitry, and automatic search that re-locks on the carrier as far as  $\pm 5$  kHz off center frequency.

It seems likely that, taking into account the Mutual-, AP-, and UPI-sponsored radio earth stations, the next two years will see two to three thousand radio terminals installed, with the rate of installation rising steadily. Thus radio broadcasting will be on the satellites to a major extent in the near future.

**For more information:** Compact Video, Satellite Services, 757; McMartin, SMR-1 modulator, 758; SDR-1 demodulator, 759.

### Transmitter quality is up

The Harris and Continental 50 kW and the RCA all-solid-state 5 kW AM transmitters of improved audio quality were on the floor, the Harris MW-50B as an introduction.

Another new 50 kW model, the McMartin BA-50K, strongly continued

# HITACHI

## SK-91 ENG/EFP Color Camera with 3 Saticon or Plumbicon® tubes

- F1.4 Prism Optics
- 2 H Enhancer and ABO
- 9.7 Lbs +9 +18 db Gain
- Auto White and Black Balance
- 22 Watts

Includes 1.5 VF, camera cover, battery and charger, shoulder mount, 12:1-F1.7 9-108mm lens, auto iris servo zoom, tripod adaptor, carrying case, service manual, camera cable to VTR



## HR-100 Portable Type C 1" Helical VTR

- Conforms to all SMPTE standards
- features Video Confidence Head
- Sync Head, Built-in Time Code Generator, Back Space Editor
- Digital Servo System

Includes take-up reel, 1 hour 3M tape, battery and charger, operation/service manuals, set of extender cards



**Both \$59,700** Includes Delivery, One Year Service,  
Parts and Labor.

(215) 223-8200

### LERRO

ELECTRICAL CORPORATION  
COMMUNICATIONS SYSTEMS DIVISION  
3125 North Broad Street, Philadelphia, PA 19132

PLUMBICON® is a registered trademark of N. V. Philips of The Netherlands

Ask for Fred Dorn  
or Dick Murphy

# The Perfect Companions

VSM-5, the latest in a series of professional test equipment from Videotek. A television Vectorscope which provides bright, sharp, easy-to-observe vector displays on a 5-inch CRT. Available as a separate unit, or rackmounted ... *The Perfect Companion* to our popular TSM-5 Waveform Monitor.



Quality Endures



**Videotek, Inc.**

125 North York Street, Pottstown, Pennsylvania 19464 / Telephone (215) 327-2292  
9625 North 21st Drive, Phoenix, Arizona 85021 / Telephone (602) 997-7523

Circle 213 on Reader Service Card

**FIGHT CLEAN AND WIN.** Increased use of carts makes tape noise reduction more critical than ever in your fight to stay competitive. With dbx Type II Noise Reduction, you have an affordable way to get high quality sound whether you're into classical music or drive-time rock. Our **\$260\*** new Model 941 offers two channels of encode, the new Model 942 two channels of decode.

Combine them for simultaneous encode/decode. Get up to 16 channels in one 5 1/4" high rack mount frame. Broadcast noise reduction is the latest addition to the dbx 900 Series modular signal processors. All interchangeable, all compatible. See your dbx Pro dealer, or write for complete technical information.

\*Manufacturer's suggested retail price. Model 941, Model 942, \$270.



Model 941 Encoder and Model 942 Decoder

dbx, Incorporated, Professional Products Division,  
71 Chapel St., Newton, Mass. 02195 U.S.A.  
Tel. (617) 964-3210, Telex: 92-2522. Distributed in  
Canada by BSR (Canada) Ltd., Rexdale, Ontario.

**dbx**®

Circle 214 on Reader Service Card

## NAB SHOW IN PRINT

the welcome high-quality trend of the three mentioned. The BA-50K uses extremely high RF efficiency to get good audio performance in a high-level plate-modulated design. Frequency response, control of distortion, and square wave response show the advance to new AM performance criteria.

Singer Broadcast Products of Cherry Hill, N.J., came to the show as the new owner of both the CCA and the Sintonic transmitter lines. A spokesman for Singer told *BME* that all current models in both lines would be continued, and full service maintained for all transmitters of the two brands now in use. However, over some reasonable period there will be a consolidation and updating of models, with Singer to manufacture and market a unified line.

Continental, in addition to the 50 kW 317C-2, had on hand representative models from the Collins line, acquired by Continental late last year. Included in the list are the Collins AM units and the FM transmitters from 1.25 to 50 kW; all are now being made by Continental. Also in full production is the FM exciter formerly made by Collins, now designated Type 510R-1.

Broadcast Electronics, continuing to add FM transmitting units to its line, showed a new stereo generator, Model FS-10, with high-level characteristics. It has a digital modulator and pilot generator for high stability, given as  $\pm 1$  Hz, 0 to 50 degrees, for the pilot. Total harmonic distortion is rated 0.05 percent or less, intermodulation distortion 0.05 percent or less, transient intermodulation distortion 0.1 percent.



McMartin's new BA-50K, 50-kW AM transmitter was in full operation on high platform, with the 50 kW of RF power going into dummy load



The unit has selectable preemphasis at 0, 25, 50, and 75  $\mu$ s and dynamic separation 45 dB or better.

Broadcast Electronics also showed the FX-30 synthesized FM exciter which has similar top-of-the-art characteristics including harmonic distortion of a composite signal at 0.08 percent. The company also brought a new transmitter, a 1.5 kW FM model using the firm's exciter and stereo generator.

Magnavox, with exemplary fortitude, had a complete display of its AM stereo system, with a mini-transmitter set up for a live demonstration in feeding several types of experimental receivers.

**For more information:** Harris MW-50B, 760; McMartin BA-50K, 761; Broadcast Electronics FS-10, 762; FM transmitter, 763.

### Upgrade the STL, too

Radio broadcasters today look carefully at the STL for its effect on audio quality. Micro Control Associates of Cleburne, Tex., showed a new FM STL system with an interesting new design aimed at lower distortion. The STL receiver at the transmitter site, Model ULX-2001, does not demodulate the signal, but heterodynes it first down to the 10.7 MHz IF frequency to supply adjacent channel rejection, then up to the carrier frequency. The STL receiver, in other words, also functions as the FM exciter.

All the conversions are crystal-controlled, locked to a single oscillator frequency. Micro Control says that this system avoids the degradations in the demodulation/remodulation of the usual STL-transmitter linkage. Micro Control's specifications for the system make this claim persuasive: audio is within 0.4 dB, 30-55 kHz; harmonic distortion 0.4 percent or less; intermodulation distortion 0.25 percent or less; S/N 65 dB or better. These figures are based on the use of the Micro Control PTS-10C STL transmitter with the system. The system was type-approved by the FCC just prior to NAB.

**For more information:** Micro Control Associates STL, 769.

### Remote control for radio

For years remote control systems for radio have been gaining in resourcefulness, in the number of things they will do, and in the number of channels, transmitters, and parameters they will keep track of and control. The makers of remote control systems did not let us down at NAB '81.

Time and Frequency Technology, for example, brought its Series 7900 system with completely revamped software for greatly expanded

capabilities. It includes microprocessor action at both the remote and the control sites. The system will handle up to 96 channels each of telemetry, status report, and control, *per site*, and up to 63 remote sites. It has four levels of alarm limit. The software will hold computation programs to determine derived values, such as direct power, indirect power, and efficiency. These and other computations can be done at the remote unit. The communication is based on a fast 1200 BPS time-division multiplex. Remote interrogation over telephone lines with operation at 300 baud can be added, with CRT readout of up to 80 result channels. The system can also take information from site security sensors.

TFT points out that the system is very well suited to control of remote satellite earth terminals. This function is sure to spread through radio broadcasting over the next few years. The refinement of the leading remote control systems has given the industry the power to handle easily the remote satellite earth station.

Moseley Associates, another of our main bulwarks in remote control technology, brought a new, highly refined system, the MRC-2. This building-block system is capable of handling up to 99 remote sites with 16 each of command, telemetry, and status lines at each site. It is expandable with optional blocks to 225 of each line.

A third high-performance system that was new at the show came from Delta Electronics — Model RCS-IV, which is expandable up to 48 channels of raise/lower control, 48 of alarm, and comparable coverage for status and telemetry. The system is very easily modified to become an ATS. It is programmed by the station's engineer for the monitoring format and automatically presents the results on the CRT readout. Out-of-tolerance readings can trigger an alarm, and also appear on the readout in a reverse video flag. Optional additions to the system are a remote modulation display, autologging, and a telephone access system.

Introduced in early form at the 1080 NAB and now in production, the Marti RMC-15 remote control system was demonstrated at the '81 show. Another high performance system, it has a standard 15 channels, expandable to 30 channels, of digital command and telemetry, using internal FSK modems. Each channel supplies one data readout and two commands. Linkage can be by telco line or radio.

A company new in remote control is Comark, known for TV transmitters at earlier shows. Comark brought its new Model CI-5080 remote control system. It is expandable to 256 channels. Microprocessors at both the studio and the remote units give flexibility to operation, with software changeable to meet

## Field Service Engineers

The Grass Valley Group, Inc., a leading manufacturer of television broadcast equipment, is looking for people who want challenging professional positions. Openings exist in California, Indiana, New Jersey, and Georgia.

These challenging positions combine chances for U.S. travel plus marketing and engineering career opportunities. Individuals with experience designing and/or maintaining television broadcast systems are required to provide after-sales support for our wide variety of complex systems.

Interested and qualified candidates are invited to send a resume in confidence to Sylvia Smith, The Grass Valley Group, Inc., P.O. Box 1114, Grass Valley, CA 95945. An Equal Opportunity Employer M/F/H.

**The Grass Valley Group, Inc.**

A Tektronix Company

## NOW! CONTINENTAL'S 1 KW AM



**Pulse width modulation** in an efficient 1 kW package; efficiency and reliability of a tube-powered final; clear, crisp sound of transformerless modulation; ready for AM stereo. Switch-mod system allows maximum modulation level at all power levels while providing cost-effective operation.

Write for brochure on 314R-1:  
Continental Electronics Mfg. Co.  
Box 270879 Dallas, TX 75227  
(214) 381-7161

**Continental Electronics**

Circle 215 on Reader Service Card

# Beyond P.L.



## Broadcast Intercoms limited only by your creativity, Imagine:

- Live Remote P.L. and Cue Systems
- Battery Operated ENG/EFP Systems
- 4 Channel Studio and Post Production P.L. Systems
- Mobile Van P.L. Systems
- Cameraman's Headsets

### All NEW from Clear-Com

Send for our catalog on more ideas and technical information.

 **Clear-Com**  
intercom systems  
759 Harrison Street  
San Francisco, CA 94107  
(415) 989-1130  
TWX: 910-372-1087

Circle 216 on Reader Service Card

**First Class Broadcast Engineer for WQUE / WGSO, New Orleans.** Take charge of FM studio and transmitter operation. Able to assist AM directional operation. Contact Herb Korté, Insilco Broadcasting, P.O. Box 85, New Haven, Connecticut 06501. Phone 203/281-9600. Affirmative Action / Equal Opportunity Employer.



## VIDEO & PULSE DELAY LINES

- PC MOUNT
- BOXED
- RACK MOUNT
- DELAY CARDS

- TOP QUALITY
- LARGEST STOCK
- BEST DELIVERY
- LOWEST PRICE

CONTACT THE DELAY LINE COMPANY

## broadcast video systems ltd.

1050 McNicoll Ave.  
Toronto, Ont. M1W 2L8  
(416) 497-1020

1438 N. Gower  
Hollywood CA. 90028  
(213) 460-2949

Circle 218 on Reader Service Card

## NAB SHOW IN PRINT

user needs. Readout is in the form of graphics in composite video form, for display on any video monitor. System handles status and analog inputs from the transmitter, and sends relay commands to the transmitter.

For more information: TFT Series 7900, 764; Moseley MRC-2, 765; Delta RCS-IV, 766; Marti RMC-15, 767; Comark CI-5080, 768.

### A pride of towers

Antenna tower builders and suppliers have been appearing at NAB in larger numbers every year; 1981 brought a stronger contingent than ever. Towers are reaching higher, mostly for television, and a high-velocity trend is the adding of satellite antennas to tower lines.

Allied Tower was one of those moving higher with its towers, above the earlier limit of around 850 feet. The company specialized for years in microwave towers for oil company communications. At the show Allied made a strong pitch for TV business by offering to put up towers 1200-1500 feet and above. An Allied spokesperson said that the last few years have seen the broadcasting share of the company's business increase to about half the total.

Athans Communications, relatively new in broadcast towers of all heights, said it was planning to move into satellite dishes in the near future. The company's business has concentrated heavily on towers for cable television.

Fort Worth Tower, as noted in the May issue, has a strong position in satellite dishes but is also continuing to build operations in radio and TV towers, especially for cable TV. LeBlanc and Royle, new at NAB in 1980, had its line of AM, FM, and TV towers with the addition of a turnkey satellite dish service. Magnum is another old-line tower builder now expanding its TV business, but with cable towers still a large part of business.

Stainless, Inc. described some new very tall designs, including three at 2000 feet and one at 1800 feet.

For more information: Allied Tower, 772; Athans satellite dishes, 773; LeBlanc and Royle satellite dish service, 774; Stainless tall towers, 775.

### Antennas and transmission lines

Antennas and antenna expertise were evident in many exhibits, but relatively few new items were shown. A new CP antenna for UHF service, channels 14-70, was shown by RCA. This low-

wind load CP pylon is a direct replacement for many horizontally polarized UHF pylons. RCA's exhibit included five other CP antennas for VHF service.

Harris displayed both VHF and UHF antennas, both horizontal and CP types. The Bogner exhibit described that company's slot array for UHF, calling it the best-selling UHF type in 1980.

Another broad line of CP FM antennas came from Shively Labs. Tenna-plex Systems Ltd., North American distributors of Kathrein FM and TV antenna systems, showed photographs of some of the most eye-appealing antenna installations in the world.

One of the most intriguing antenna displays was that of AEG-Telefunken, in the Bayly exhibit. There, in model form, was a turntable-mounted wide-band folded dipole curtain antenna designed for HF transmitters. The antenna system, about 73 meters across and 79 meters high, rotates to provide coverage for any part of the globe.

One new product in the transmission line category was Cablewave System's Wellflex elliptical waveguide for the 17.7-20.3 GHz band. According to the company, it is stronger than coaxial waveguides and comes in longer continuous sections. The best rigid coax line in the industry was claimed by SWR, Inc. Thermo-probes located within SWR's watchband connectors improve heat transfer.

**For more information:** RCA CP antenna, 770; Cablewave Wellflex elliptical waveguide, 771.

#### Lightning: the guard must be up

It is a constant threat, and systems for protection against lightning are a constant for broadcasters. Lightning Elimination Associates has been marketing for more than 10 years its dissipation array system, which the maker says will prevent lightning from occurring in a protected area by "leaking" off the potential between cloud and earth.

At the show LEA introduced several more conventional protective devices to add to the line. A surge eliminator for coaxial and open-wire transmission lines goes into series with the line to control voltage surges. Intrinsically Safe Transient Eliminators go between hazardous area equipment and control room equipment to prevent damage to control room equipment. A guy charge dissipation choke goes into antenna guy wires to leak off static charges, while presenting very high impedance to operational frequencies.

**For more information:** Lightning Elimination Associates surge eliminator, 776; transient eliminator, 777; guy charge dissipation choke, 778.

## THE NEW STANDARD COVERS AM BAND PLUS HARMONICS TO 5 MHz



The Model FIM-41 Field Strength Meter has many more features —

- Measures Harmonics to -80 dB
- High Adjacent Channel Rejection
- Ganged Oscillator/Receiver Tuning
- Stable Operation over wide Temperature Range
- Low Battery Drain Circuits
- Front Panel Speaker
- Large illuminated Meter and Tuning Dial
- Indicates field strength accurately down to 10  $\mu$  volts/M
- RF input jack for tuned voltmeter applications

CONTACT US NOW FOR COMPLETE DETAILS  
ON OUR LINE OF FIELD STRENGTH METERS

**POTOMAC INSTRUMENTS**  
932 PHILADELPHIA AVE.  
SILVER SPRING, MARYLAND 20910 (301) 589-2662

Circle 219 on Reader Service Card



**DISCOUNT  
INDUSTRIES Ltd**

105 EAST 69th AVENUE  
VANCOUVER, B.C.  
CANADA V5X 2W9  
PHONE (604) 327-9446  
TELEX 04-508605

CALL OR WRITE FOR DETAILS

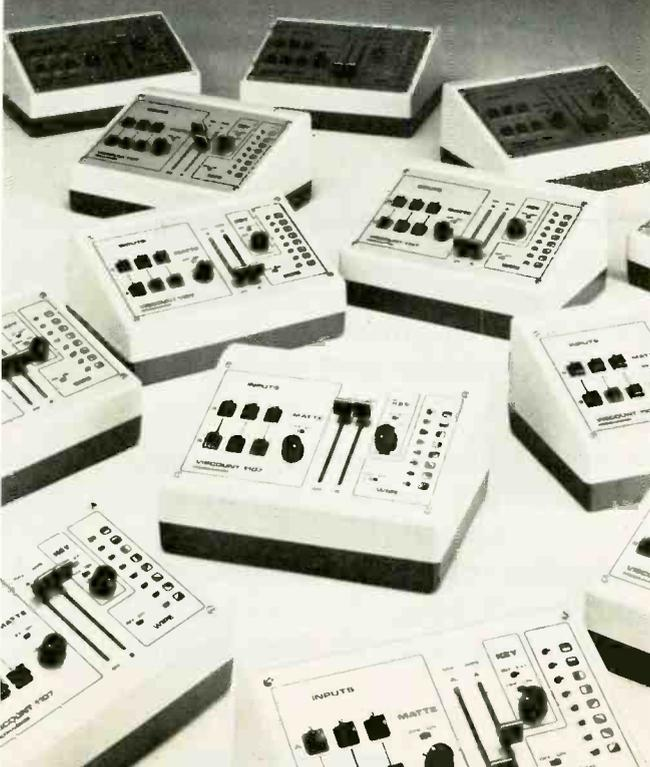

Circle 220 on Reader Service Card



# BROADCAST EXPERTISE...

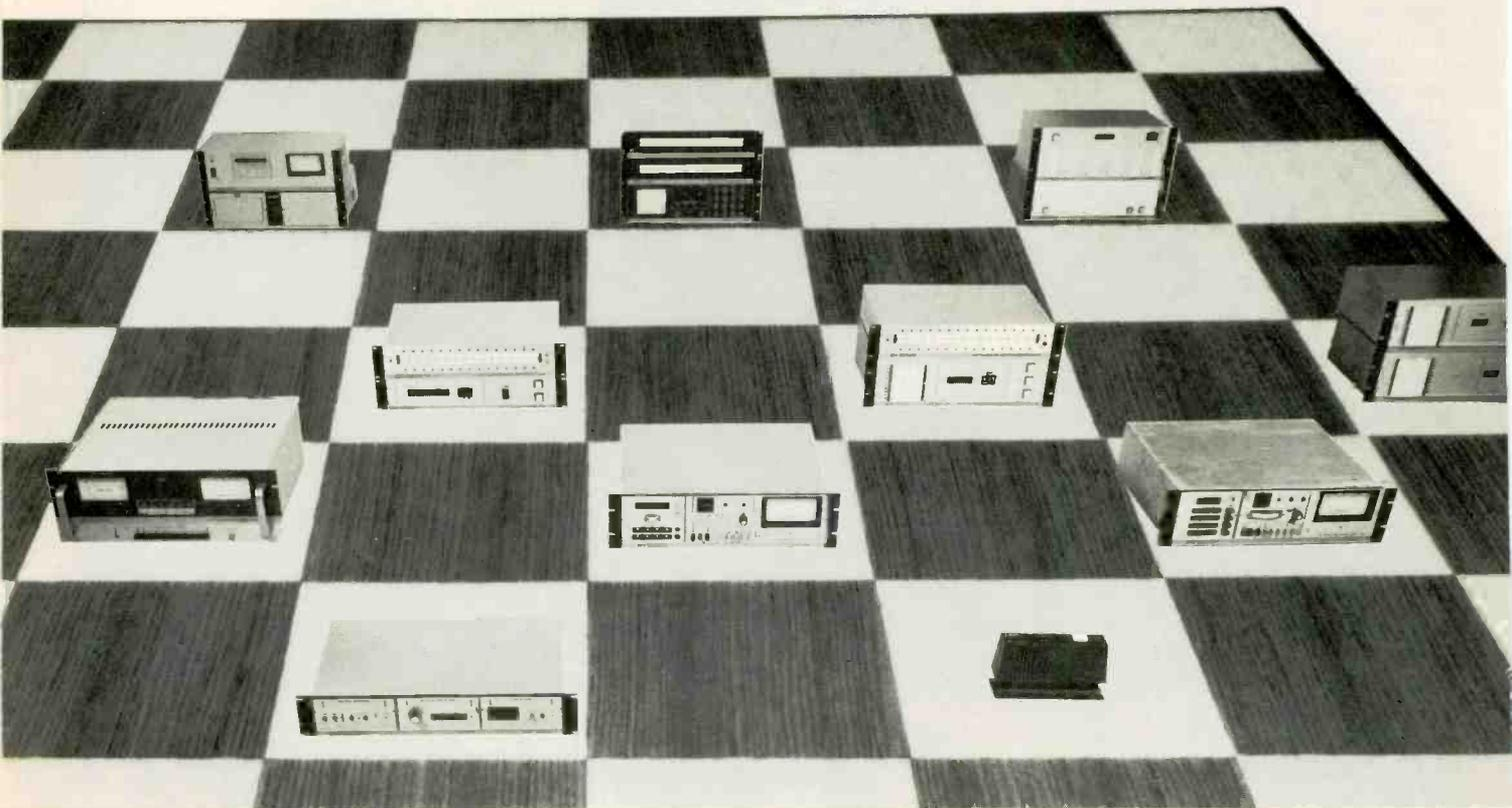

## ACROSS THE BOARD!

Since 1970, TFT, Inc. has been a pioneer in state-of-the-art broadcast technology. As such, we have been able to always keep one move ahead in cost-effective design to provide reliable, versatile and innovative products to the broadcast industry.

TFT was the first to use frequency synthesized circuits in its full line of AM, FM, TV, stereo and SCA **Modulation Monitors**. TFT concepts in **Remote Control Systems** now allow expansion all the way to micro-processor based data logging, display and

alarm systems. In the relatively new field of **Studio Transmitter Links**, TFT has made major contributions through the use of IF modulation transmitters and pulse counting discriminators to improve both S/N ratio and stereo performance.

Even in the **Emergency Broadcast System (EBS)**, TFT has taken a leadership role in the development of both EBS generators and receivers.

Now, it's your move! Call or write TFT today for full facts on their winning product lines.

(TIME & FREQUENCY TECHNOLOGY)



3090 OAKMEAD VILLAGE DR.  
SANTA CLARA, CA 95051  
(408) 727-7272 TWX 910-338-0584

Circle 221 on Reader Service Card

# INTERPRETING THE **FCC** RULES & REGULATIONS

## New Sponsorship ID Rules For Noncommercial Stations

By Frederick W. Ford and Lee G. Lovett; Lovett Ford and Hennessey, P.C., Washington, D.C.

IN THE WAKE of the Reagan Administration's proposed budget cuts in funding for public broadcasting activities, the Federal Communications Commission has loosened rules for fund raising and identification for corporate donors by non-commercial licensees. Among other developments, the FCC's April decision will permit non-commercial TV broadcasters to use corporate logos and similar identification for companies which help provide funding for particular programs.

The Commission said that it had amended the rules for public broadcasters to match them more closely to the underlying purpose and appropriate limits of non-commercial broadcasting. The rule changes also give public broadcasters greater discretion, and, therefore, greater responsibility, in the areas of programming and fund raising.

### Four-year proceeding

The April decision is the second Commission *Report* on the matter since the Commission issued its *Notice of Inquiry* in 1977.<sup>1</sup> The *First Report and Notice of Proposed Rule Making*<sup>2</sup> issued in 1978 proposed a series of rules which would have placed strict limits on some types of fund raising activities. The proposed rules had been drafted in light of comments and responses to 22 different questions in the *Notice of Inquiry*.

The 1978 *First Report* sought to ban the promotion of products or consumer services. For example, announcements stating the origination location by non-commercial broadcasters of events broadcast by a non-commercial licensee from theaters, auditoriums, arenas, or night-clubs, where tickets were required or food or drinks were sold, were permissible. However, urging listeners to attend any program origination point requiring an entry fee

was impermissible.

The Commission also proposed extensive rules governing the use of auctions as a fund raising activity. In recent years, auctions and telethons have proven to be favorite fund raising tools for non-commercial broadcasters.

In 1978, the Commission proposed rule changes which it thought would strike a reasonable balance between financial needs of non-commercial stations and their obligations to provide an essentially non-commercial broadcast service. In the intervening years of this proceeding, however, the Commission found that the record did not support many of the specific rules that it had proposed to strike that balance. The result was the April decision.

### April decision: promos out; logos in

The new basic rule governing fund raising activities by non-commercial educational radio and television stations prohibits the broadcast of program matter by those stations for which the licensee, its principals or employers receive any consideration, *with the exception of acknowledgement of contributions*. The principal changes involve the manner in which contributions can be acknowledged. The result envisioned by the Commission is that broadcasters would not be influenced by financial incentives (as are commercial broadcasters) but would have greater freedom to program in the public interest.

For non-commercial television broadcasters, the principal feature of the revision in rules involves the approval of the use of corporate logos. Although Commission rules still prohibit the *promotion of products*, as opposed to *identification of corporate benefactors*, the Commission eliminated the "name only" restriction on acknowledgements. It determined that the use of (1) corporate logos, (2) the location of the sponsor, and even (3) the identification of product lines did not conflict with the non-commercial nature of the educational broadcasting services. Along with the increased licensee discretion in these matters, however, come increased responsibilities

<sup>1</sup>*Notice of Inquiry, in the Matter of Commission Policy Concerning the Non-Commercial Nature of Educational Broadcast Stations*, Docket No. 21136, 42 FR 15927, FCC 77-162 (1977)

<sup>2</sup>60 FCC 2d 200, 43 RR 2d 731 (1978).

# Perfect Timing

## MASTER CLOCK SYSTEMS



If seeing the same time on all your clocks is important, select **ES 192** - Line Frequency timebase, for only \$312.

If a guaranteed accuracy of three seconds per month is what you want, choose **ES 160**-\$1,005.

How about one second per month? **ES 160/1**-\$1,179.

Or National Bureau of Standards accuracy! **ES 190** is synchronized to Radio Station WWV to provide a Master with unquestioned accuracy. \$1,179 with receiver and antenna.

For a Time/Temperature Master, ask for **ES 196**-\$737.

**ESE Master Clock Systems are simple to install. All Masters have a Serial Time Code output, able to drive twenty slave displays without buffering. Slaves range in size from .3" LED to 2" gas discharge displays, priced from \$152 to \$432.**

**IF YOU ALREADY HAVE A SYSTEM AND WANT TO EXPAND IT**, get the **ES 167** Serial Time Code Generator (\$141), then add any number of our low cost slaves.

Many, many options and accessories are available. Ask us about them. Our brochure tells the whole story, but not for long. We keep adding new products.



Write, Wire or Call: (213) 322-2136  
142 SIERRA STREET • EL SEGUNDO, CALIFORNIA 90245

Circle 222 on Reader Service Card

## FCC Rules and Regulations

on the part of the licensee to make sure that the non-commercial radio and television services do not become little more than a variation of commercial AM, FM, and TV stations.

The Commission expects licensees to utilize the greater latitude and flexibility to develop new policies for acknowledgement of corporate benefactors. These new policies, which remain consistent with the non-commercial status of the licensee, could stimulate new and broader sources of financial support for programs and general station operation. This has become a matter of increasing concern to public broadcasters since the announcement of President Reagan's proposed budget cuts, which included substantial reductions in funds available for non-commercial broadcasting.

### Part of broadcast deregulation

A unanimous Commission considered this decision to be another in the line of deregulation decisions made in recent years. Commissioner Washburn noted that although this decision only addressed fund raising rules, "nevertheless, the simplifications and clarifications to those rules signal a new era for public broadcasting stations, their audiences and their underwriters."

The FCC decided against placing limits on fund raising activities because excessive time devoted to fund raising would likely prove counterproductive in terms of declining audiences. In other words, the Commission determined that "market" forces, in this case referring to audience share rather than station profits, should be the determining factor in Commission regulation. Although the Commission decided not to place any time limits on fund raising activities, it determined that fund raising which disrupts normal programming and goes beyond an "announcement" must be for station purposes only. This would seem to clear the way for further telethon and auction activities.

The Commission also decided to permit non-commercial broadcast licensees to engage in the remote broadcasting of events such as sports contests, as long as licensees, their principals and employees do not receive any consideration for the promotion of the broadcast. It is difficult to anticipate how this proposal could affect anything other than amateur sports, since most professional sports and major intercollegiate athletic events are covered by lucrative advertising and affiliation contracts.

### Conclusion

The full text of this decision was not yet available at press time. Consequently, we still do not know the effective date of this Commission action. The Commission's determination to deregulate the non-commercial services along with commercial ones is quite clear. However, non-commercial broadcasters should be aware of the fine lines drawn by the Commission because of the particular statutory charges for the non-commercial broadcast services. This action provides greater flexibility for broadcasters buy relies on their good faith efforts to prevent abuses and maintain the essential character of the non-commercial broadcast services. Non-commercial broadcasters should consult with their communications counsel as to the best way of proceeding with new identification rules for corporate backers.

**BM/E**

# R for those suffering from high prices and delivery delays

the world's lowest-priced WFM & VSC . . . from the originators



**WM310B \$995**



**VS310B \$1495**

VS310B is not only an NTSC vectorscope ideal for camera-matching, but it offers full-bandwidth and chroma-only waveform display. It's also a 4mHz. serviscope. WM310B displays H, V, H-blanking, V-sync — full bandwidth, Y-only, chroma-only, plus variable VITS line selection. UA47 RackKit mounts up to 3 scopes in 5 R.U. height. UA50 RackKit mounts a 310-series scope with Panasonic WV5311 PCM.

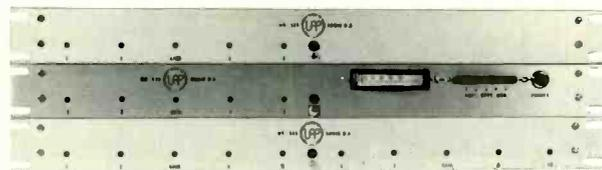

**MR5x5 \$795**  
**MR5x5M 995**  
**MR5x52 1395**  
**AUDIO DISTRIBUTION AMPLIFIERS**

Incredible! MR5x52 boasts 10 audio D.As, each with 5 transformer-isolated outputs in but 1 R.U. height. MR5x5 offers 5 such amplifiers; MR5x5M includes vu metering and headphone monitoring. 40db gain, flat 30-20kHz., 72db S/N, 65db isolation, 1% max. distortion, 10k ohm xfmr. bridge or cost-saving 100k ohms unbalanced input. Gain presetable from front.

**AM3 \$345**  
**RACKMOUNT AUDIO AMPLIFIER**



Ideal for close-up monitoring and mobile facilities. 3 clean audio watts from a -20dbm line. Transformer input, 2 R.U. height, headphone disconnects speaker, inputs front and rear, smooth response.

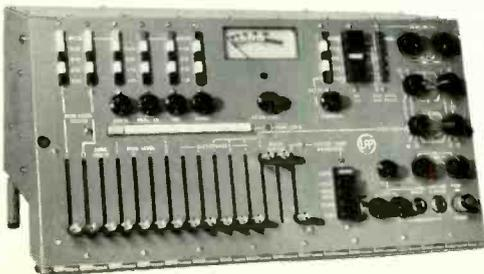

**MixMaster™ MS-105 \$2995**

The audio mixer/master-control with everything for the van and small tv studio. Voice-over with "ducking", group mastering, audition, cueing, paging, test and slating tones, slide-faders, 7 mic's and phono, 2 variable equalizers, compressor, 7 high-level inputs, accepts condenser mic's too, no tools for hookup, mounts in rack or 7" deskarm or tabletop, vu meter displays compression and levels, eliminates custom outboard facilities.

**"audio is our middle name"**



**Ultra Audio Ptxtec**

Div. of Audio International, Inc.  
 Post Office Box 921  
 Beverly Hills, CA 90213 U.S.A.  
 (213) 276-2726

Prices, styling and specifications subject to change without notice.



**APA52 \$350**

**AUDIO POWER**

The mighty mite where space is at a premium. Mount up to 3 dual-50 watt power amplifiers in 2 R.U. height . . . 300 audio watts in 3½ inches! Flat response 20-20kHz., input 20k ohms balanced, 8 ohms load, 90db S/N. Lower-cost AP250 has unbal. input.

**INDESTRUCTIBLE BATTERY-POWERED AUDIO MIXER**



**AMA41 \$595**

A 12-volt (internal/external) battery-powered audio mixer. 3 mic. positions & a 4th mic/line input, 1kHz. oscillator; vu meter; recessed components in rugged case for protection against dropping and stomping; headphone jack (can feed unbal. load); "XL" transformer-input connectors, spring-post transformer-coupled 600 ohms output; flat 20-20kHz., 90db gain; battery checking & fast replacement; low-freq. cutoff switches.

**new VIDEO AIDS from VAC<sup>®</sup>**

**INTRODUCING THE PULSE D.A.**  
**PULSE DISTRIBUTION AMPLIFIER MODEL PDA-1P**

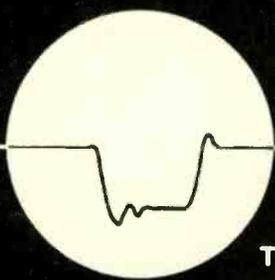
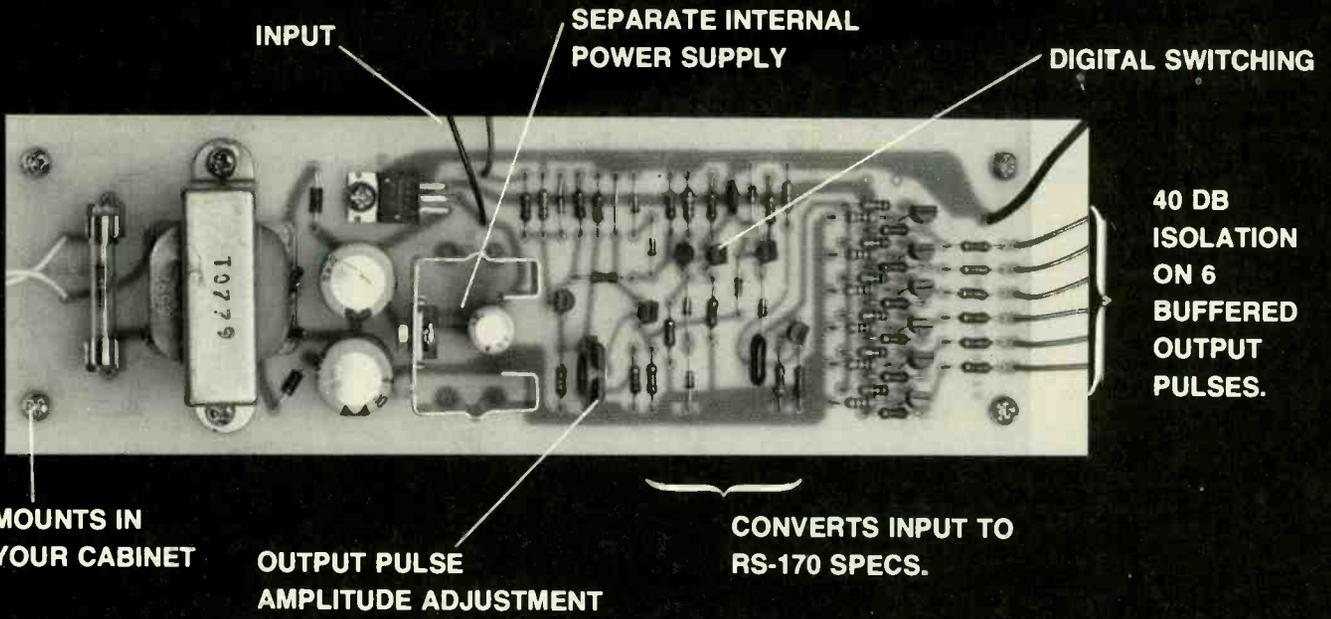

TYPICAL RAGGED INPUT PULSE . . .

**PULSE POWER**

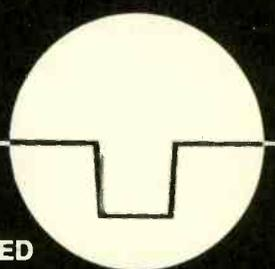

. . . CLEAN BUFFERED OUTPUT PULSES

CALL FOR THE NUMBER  
 OF YOUR LOCAL DEALER:  
 (303) 443-4950



1930 CENTRAL AVENUE · BOULDER, CO. 80301



# WINNERS

# GREAT IDEA

## CONTEST

THE VOTES ARE IN — and it's time once again for *BM/E* to congratulate a new set of Great Idea Contest winners. Three top winners in the 1980 contest, overwhelmingly selected by our readers, will each receive Texas Instruments programmable calculators (to use, we hope, in working out more Great Ideas!). They are: Gaetan Boivan, technical director at CKRS-TV in Jonquiere, Quebec, for his "Scanning TV Monitor" (Entry 16, July 1980); Lee Barrette, chief engineer at KOJM-AM, Havre, Mont., for his "Universal Line Amplifier" (Entry 4, February, 1980); and Bruce Mattson, chief engineer at WGPR-FM, Detroit, Mich., for his "Recorder Telephone Interface" (Entry 26, November, 1980).

Our congratulations also to the runners-up, who will receive engineering slide rule calculators:

Category 1, Audio: Ken Anderson, formerly CE at KARR/KOPR, Great Falls, Mont., for his "Auto Phone Feeder for Program Audio" (Entry 12, May, 1980).

Category 2, RF: D.M. Haworth, engineer at KHAS-TV, Hastings, Nebr., for his "Transmitter Ring Repair" (Entry 19, August, 1980).

Category 3, Control: N. Kevin Burris, news engineer at WBRZ-TV, Baton Rouge, La., for his "VTR Status-Start Indicator" (Entry 17, August, 1980); Ken Garber, AV/TV technician at St. Clair College TV Facilities, Windsor, Ont., for his "Disable Edit Suite Remote Position" (Entry 5, February, 1980); and Steve Ellis, director of engineering at WGIL-AM, Galesburg, Ill., for his "Two-Station EBS Test with One Encoder" (Entry 24, November, 1980). There were no runners-up in Category 4 (Video).

Once again, *BM/E* congratulates all the winners. If you have an idea that's made your life at the station easier, why not share it with your colleagues? *BM/E* is always on the lookout for Great Idea Contest entries. Send us your ideas — just read the rules and fill in the entry blank, reprinted here. Who knows — maybe *your* idea could be a winner!

**BM/E**

*Editor's Note: Before attempting to implement any Great Idea involving the modification of equipment, station personnel should check with the equipment manufacturer to insure that no violation of warranty will occur.*

*If the Great Idea involves any technical standards governed by the FCC, stations should make sure that the idea will in no way cause a violation of FCC rules.*

## Rules for *BM/E*'s 1981 Great Idea Contest

Mail to:  
Editors, *BM/E*  
295 Madison Avenue  
New York, New York 10017

1981  
Entry Form

Name \_\_\_\_\_ Title \_\_\_\_\_

Station Call Letters \_\_\_\_\_ City \_\_\_\_\_

State \_\_\_\_\_ Zip \_\_\_\_\_

Telephone No. \_\_\_\_\_

Licensee \_\_\_\_\_

Class of Station at which idea is used (check one)

TV \_\_\_\_\_ FM \_\_\_\_\_ AM \_\_\_\_\_

Category: Audio \_\_\_\_\_ RF \_\_\_\_\_ Video \_\_\_\_\_ Control \_\_\_\_\_

Objective or Problem: (In few words; use separate sheet for details)

Solution: (Use separate sheet—500 words max)

I assert that, to the best of my knowledge, the idea submitted is original with this station; and I hereby give *BM/E* permission to publish the material.

Signed \_\_\_\_\_ Date \_\_\_\_\_

**1. Eligibility:** All station personnel are eligible. Consultants to the industry may enter if the entry indicates the specific station or stations using the idea or concept. Manufacturers of equipment or their representatives are not eligible.

**2. How to Enter:** Use the Official Entry Form on this page or simply send *BM/E* a description of your work. State the objective or problem and your solution. Include diagrams, drawings, or glossy photos, as appropriate. Artwork must be legible but need not be directly reproducible and not exceeding three in number. Camera reproducible material is preferred. Length can vary, but should not exceed 500 words. *BM/E* reserves the right to edit material. Entry should include: Name, title, station affiliation, and the class of station—TV, FM, AM. Indicate if idea is completely original with you.

**3. Material Accepted for Publication:** *BM/E* editors will make all decisions regarding acceptability for publication. If duplicative or similar ideas are received, *BM/E* editors will judge which entry or entries to accept. A \$10 honorarium will be paid for each item published.

**4. Voting:** Every reader of *BM/E* is entitled to rank the ideas published. This can be done on the Reader Service Card in the magazine or by letters or cards sent to the *BM/E* office. To vote, readers should select the three ideas they like best and rank them 1, 2, or 3.

**5. Winners:** Top rated entries in the year-long tally will become winners in each of the three major categories (AM, FM, TV). Final winners will be picked in February, 1982, and announced in the March, 1982, issue of *BM/E*.

**6. Prizes and Awards:** Three top prizes will be awarded; a programmable electronic calculator will be awarded for the highest rated entry in the respective categories of AM, FM, and TV. Ten engineering slide rule calculators will be awarded as secondary prizes for the highest rated entries in the following additional categories (top three winners are not eligible for these prizes): audio (three prizes, one each in the AM, FM and TV categories); RF (three prizes, one each in the categories of AM, FM, TV); Control (three prizes, one each in the AM, FM and TV categories); Video (one prize in TV).

## Advertisers Index

Accurate Sound Corp.	132
ADM Technology, Inc	11
A.F. Associates, Inc	46
American Data Corp	23
Ampex Corp AVSD	43, 45
Asaca Corp of America	122
Audio & Design (Recording) Ltd	13
Belar Electronics Lab., Inc	170
Bell Helicopter Textron	39
Bogner	49
Broadcast Electronics, Inc	16
Broadcast Video Systems	162
BTX Corp	91
Cablewave Systems, Inc	87
Camera Mart, Inc	14
Canon USA, Inc	137
Capitol Magnetic Products	154
Central Dynamics Ltd	96-97
Cetec Antennas	134
Cetec Corp	130
Cezar International Corp	32
Christie Electric Corp	144
Chyron Corp	29
Cine 60, Inc	69
Cinema Products Corp	17
Clarion Production Services	66
Clear-Com Intercom Systems	162
CMX/Orox	3
Compact Video Services, Inc	98
Comrex	115
Comsearch, Inc	64
Conrac Corp	74
Continental Electronics Mfg Co	138, 156, 161
Convergence Corp	150
CSI Electronics, Inc	82
Datametrics, Inc	C3
Datatron, Inc	21
dbx, Inc	144, 160
Delta Electronics	131
Digital Video Systems	123
Ditech	148
EEV, Inc	125
Electro	132

Electro-Voice	12, 81
ESE	166
Eventide Clockworks, Inc	116-117
Everything Audio	85
Fidelipac	136
Frezzolini Electronics, Inc	138
Fujinon Optical, Inc	127
Alan Gordon Enterprises, Inc	156
Graham-Patten Systems	146
Grass Valley Group, Inc	7, 161
Gray Engineering Labs	146
David Green Broadcast Consultants Corp	20
Gregg Laboratories	143
Harris/Farino	62
Harris Video	72-73
Hitachi Denshi American Ltd	4-5
Hughes Electronic Devices Corp/HEDCO	128
Ikegami Electronics USA, Inc	61, 106, 139
Industrial Sciences, Inc	100
Inovonics, Inc	155
Insilco Broadcast Group	162
International Tapetronics Corp	78
US JVC Corp	103
Kaitronics	68
Knox Video Systems	118
Lenco, Inc	67
Lerro Electrical Corp	159
Lexicon	119
L.G.T.	135
LPB, Inc	126
LTM Corp	158
3M Corporate Div.	120-121
3M/Magnetic Tape Div	140
3M/Mincom-Video Products	35
Maxell Corp of America	157
MC/Quantel (Micro Consultants Inc)	113
Merlin Engineering	22
Microtime, Inc	40
Microtrak	142
Moseley Assoc., Inc	114
NEC America, Inc	C2
Rupert Neve, Inc	15
Nurad, Inc	19

O'Connor Engineering Labs, Inc	37
Orban Associates, Inc	112
Otari Corp	18
Pacific Recorders & Engineering Corp	93
Panasonic Matsushita	24-25
Philadelphia Resins Corp	141
Philips Test & Measuring Instruments	105
Potomac Instruments	163
Quantum Audio	114
Ramko Research	95
RCA Broadcast Systems	30-31
R-Columbia Products	115
Rohde & Schwarz GmbH Co	110
Sennheiser Electronic Corp	85
Scientific-Atlanta	147
Sharp Electronics Corp	53-55
Sony Broadcast	8-9
Sound Systems	145
Station Business Systems	145
Studer Revox America, Inc	153
Studio Film & Tape	170
Television Products Co	111
Telex Communications, Inc	84
Tentel	104
Thomson-CSF Broadcast	108-109
Thomson-CSF/DTE	129
Thomson-CSF/DRT	71
Time & Frequency Technology	164
Topaz	133
Toshiba America, Inc	59
Transist-O-Sound	158
Ultra Audio Products	167
Unemco Intl.	51
Ursa Major, Inc	124
Utah Scientific, Inc	77
Varian, Eimac Div	88
Video Aids Corp of Colorado	168
Videotek, Inc	160
Viscount Industries Ltd	163
Vital Industries, Inc	65
Ward Beck Systems Ltd	C4
Weatheration, Inc	56
Winsted Corp	128

use our new **3/4", 1", 2" CLEANING & EVALUATION SERVICE**

**SAVE:** capital equipment  
labor costs  
manpower costs  
long term contracts available

**STUDIO FILM & TAPE INC.**

630 Ninth Avenue, New York, NY 10036 212/977-9330  
6670 Santa Monica Blvd., Hollywood, CA 90038 213/466-8101

Circle 224 on Reader Service Card



**When accuracy Counts... Count on Belar  
for AM/FM/TV MONITORS**



**BELAR**  
AM MODULATION MONITOR



**BELAR CALL ARNO MEYER (215) 687-5550**  
**ELECTRONICS LABORATORY, INC.**  
LANCASTER AVENUE AT DORSET, DEVON, PA. 19333 • BOX 826 • (215) 687-5550

Circle 225 on Reader Service Card

## SALES OFFICES

**BME/E**

Broadcast Management/Engineering

295 Madison Ave.  
New York, New York 10017  
Telex: 64-4001

Eastern & Midwestern States

295 Madison Avenue  
New York, New York 10017  
212-685-5320  
James C. Maywalt  
Denis J. O'Malley

Western States

353 Sacramento Street  
Suite 600  
San Francisco, CA 94111  
415-421-7330  
William J. Healey  
Rodger Wadley  
3420 Ocean Park Blvd., Suite 3020  
Santa Monica, CA 90405  
213-450-7181  
Bob Hubbard

United Kingdom/Europe

Chilberton House  
Doods Road  
Reigate, Surrey, England  
Telephone: Reigate 43521

Bronwyn Holmes  
Derek Hopkins

Japan/Far East

Eiraku Building  
1-13-9, Ginza,  
Chuo-Ku, Tokyo 104 Japan  
03 (562) 4781  
S. Yasui  
K. Yamamoto

# DATAMETRICS TOOK THE TIME TO LISTEN TO YOUR TIME CODE NEEDS



Nobody knows better than production engineers how important equipment flexibility is in the efficient use of SMPTE Time Code. So Datametrics listened to engineers, and designed a comprehensive line of time code equipment to meet every need.

Rugged portable code readers. Highly legible displays. Low-profile readers and generators. Even comprehensive systems that incorporate complete generate, read and video display capabilities in one compact case. Datametrics has the package you need, but that's only the beginning.

Even our most cost-effective units incorporate features you'd expect to find on higher priced models.

For example, Datametrics' lowest cost studio code reader offers video insertion capabilities for monitor viewing and code burn-in to work prints. And we added options that offer even greater flexibility ... at lower cost.

But we didn't stop there. Datametrics leads the industry in innovative features that greatly extend the potential of time code. Our newest code reader offers automatic segment duration calculation. Video titling capabilities. And it decodes and displays Time and User data ... simultaneously.

Contact Datametrics. From basic time code management to the most technically advanced

computer-compatible systems, we make time code work to your advantage. Time after time after time.

**Ask for a free copy of the new SMPTE Time Code Handbook, and learn how to make more effective use of time code in your facility.**

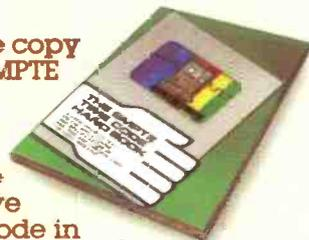

**D datametrics®**

Datametrics Inc.  
340 Fordham Road, Wilmington, MA 01887  
Tel. (617) 658-5410/TWX: 710-347-7672

# Ward-Beck ♥ NY!

Morning and evening,  
major personalities and  
events cover the nation  
from ABC Television in  
New York.

"Good Morning America"  
and "20/20 News Magazine"  
now originate from  
ABC's new Studio TV2  
featuring this highly  
sophisticated Ward-Beck  
console system.

Ward-Beck loves New York!

**WBS**

First by Design.

Ward-Beck Systems Ltd., 841 Progress Avenue, Scarborough, Ontario, Canada M1H 2X4.  
Tel: (416) 433-6550.

Ward-Beck Systems Inc., 6900 East Camelback Road, Suite 1010, Scottsdale, Arizona 85251.