

# AMATEUR TELEVISION QUARTERLY

APRIL 1991  
VOL. 4 #2

ISSN: 1042-198X  
USPS 003-353

DEVOTED ENTIRELY TO AMATEUR TELEVISION



## DAYTON ATV FUN

Friday: ATV party Holiday Inn North  
Saturday: Forum, & ATV Party Rodeway Inn  
ATVQ Booths 338, 339 Come Visit!

W1AW an ATV'er? Story Inside.

## ATV IN SPACE:

COMPLETE COVERAGE: STS-37!  
PROJECT EXCELSUS ATV BALLOON/ROCKET!  
12 ATV BALLOON LAUNCHES THIS SUMMER!

## BUILD IT PROJECTS:

TRAIN CAM ATV, LINEAR 75 W ATV "BRICK",  
SIGNAL SNIFFER, UHF SWR BRIDGE,  
10 GHz. FM ATV TX/RX, MUCH MORE!!



This ATV receiver will fly on STS-37.  
Complete story inside.



More than Radios, a behind the scenes look in this issue.  
Visit their reception Saturday night at the Rodeway Inn.



The STS-37 crew. Seated (L to R) Ken Cameron KB5AWP, Steve Nagel N5RAW and Linda Godwin N5RAX. Standing (L to R) Jay Apt N5QWL and Jerry Ross N5SCW. Photo courtesy NASA.

ICOM

IC-970 All Mode Transceiver

# Tomorrow's Transceiver Today.



## The New IC-970

Designed for the serious operator on 144, 440 and 1200MHz, ICOM's IC-970 brings futuristic technology to DX, digital and satellite communications.

### Versatile Communications.

The IC-970 comes fully equipped as an all mode dual bander for 144MHz and 440MHz. Expand your limits on 1200MHz with the optional UX-97 band unit or listen to the world with the UX-R96 50-905MHz receive unit.

### Satellite Communications.

Reach beyond the stars, communications via satellite has never been easier. The amazing IC-970 automatically tracks uplink and downlink frequencies as the tuning control

is rotated. Ten memory channels specially designed for quick satellite communications emphasize ICOM's total commitment to your future communications needs.

### Progressive Quality Throughout.

Dual band watch lets you receive both main and sub band audio simultaneously. Multiple scanning systems on the main and sub bands, plus 99 memories, an easy-to-read multi-function display and ICOM's DDS system create the transceiver of tomorrow. Additional features include a built-in pager, code squelch function, direct keyboard entry and ICOM's CI-V system.

See tomorrow's transceiver today at

your local ICOM dealer. You'll see why the IC-970 is the transceiver of a new generation!

CORPORATE HEADQUARTERS  
ICOM America, Inc., 2380-116th Ave. N.E., Bellevue, WA 98004  
Customer Service Hotline (206)454-7619  
CUSTOMER SERVICE CENTERS  
3150 Premier Drive, Suite 126, Irving, TX 75063  
1777 Phoenix Parkway, Suite 201, Atlanta, GA 30349  
3071 - #5 Road, Unit 9, Richmond, B.C. V6X 2T4 Canada  
2380-116th Ave. N.E., Bellevue, WA 98004

All stated specifications are subject to change without notice or obligation. All ICOM radios significantly exceed FCC regulations limiting spurious emissions. 970190

For a brochure on this or any other ICOM product, call our Toll-Free Literature Request Hotline 1-800-999-9877.

**ICOM**  
First in Communications

DAYTON BOOTH 21-23, 46-48



# CONTENTS

V4 #2  
APRIL 1991

## STAFF

### PUBLISHER:

Henry Ruh KB9FO

### CO-PUBLISHER

Bill Brown WB8ELK

### SALES MANAGER

Pamela Dass

### PHOTO EDITOR

Dave Williams WB0ZJP

### TEXT ENTRY

Nicki Sell

### MAILING

Jan Robinson

### Amateur Television Quarterly

(ATVQ) is published four times per year. Subscriptions are \$15 year US, \$20 Canada and \$25 DX. All mail should be sent to: Amateur Television Quarterly Magazine, 1545 Lee St., Suite 73, Des Plaines, IL 60018. Post Master NOTE: Change of address should be sent to Amateur Television Quarterly Magazine, 1545 Lee St., Suite 73, Des Plaines, IL 60018. Phone 708 298 2269. FAX 708 291 1644.

Inquiries about advertising should be sent to: Pamela Dass, PO Box 105, West Peterborough, NH, 03468. She can be reached at 603 924 6119 or 603 924 9455.

For subscription and other inquires reach us at 708 298 2269. Leave your zip code when making inquiry about subscriptions. ATVQ is available in most Ham Radio stores.

Amateur Television Quarterly is Copyright 1991. All rights reserved. No portion may be reproduced without written permission. Non-US publications may reproduce portions provided credit is given in the title page of any item used.

Amateur Television Quarterly is mailed as Second Class Printed Matter, U. S. P. O. permit # 003-353. Principle office of entry, Des Plaines, IL 60018.

## BACK ISSUES

ATVQ has sold out of every issue published. We have no back issues available. Back issues may be available at some retail ham stores.

## REPRINTS

Reprints of ATVQ issues and articles are available from:

**ESF COPY SERVICE,**  
4011 Clearview Dr.  
Cedar Falls, IA 50613.

## INDEX OF ARTICLES

DAYTON ATV FUN SCHEDULE	
Where the action REALLY is!.....	4
STS-37 HAM CLUB IN SPACE!	
Far Out ATV for you and me!.....	5
PROJECT EXCELSUS	
A rockoon ATV speed record.....	10
UP, UP, AWAY! Launch schedules	
over 12 ATV balloon launches.....	13
ATV NEWS BRIEFS	
our usual fine selection.....	16
GO FLY A KITE!	
lets do it again, but better!.....	20
75 W LINEAR BRICK FOR 70 CM	
solid state without distortion.....	23
SUPER SIGNAL SNIFFER	
RF can't hide from you now!.....	26
913 MHz. LOW LEVEL SOURCE	
handy shack project for you.....	28
LIONEL RAILSCOPE	
from train to space for peanuts....	29
10GHz. FM ATV SYSTEM	
get above it all cheaply!.....	32
HOMEBREW UHF SWR BRIDGE	
high prices are for the birds!.....	35
MORE THAN RADIOS	
a look behind the scenes.....	36
ATV RECEPTION IMPROVEMENTS	
improve your looks.....	40
2C39 CAVITIES, the real story	
a definitive design review.....	43
1991 ROSE PARADE ATV	
public service atv.....	48
A PHOTO HISTORY OF ATV	
where we came from and how....	50

## ADVERTISER INDEX

AEA.....	BACK COVER
AMSAT.....	12
BATC.....	49
C.A.T.S.....	19
COMET/NCG Antennas.....	11
DOWNEAST MICROWAVE.....	31
ELKTRONICS.....	54
ICOM America.....	INSIDE FRONT COVER
INTERNATIONAL CRYSTAL MFG.....	12, 39
LINDSAY ANTENNAS.....	60
MICRO COMPUTER CONCEPTS.....	39
MITCHELL INDUSTRIES.....	19
OLDE ANTENNA LABS.....	19
PAULDON ASSOCIATES.....	31, 42
PC ELECTRONICS.....	24, 25
RADIO SCAN MAGAZINE.....	19
RUTLAND ARRAYS.....	47
SATELLITE CITY.....	34
SCIENCE WORKSHOP.....	14
SPECTRUM INTERNATIONAL.....	22, 27
WYMAN RESEARCH.....	9



*Sorry to disturb you Mr. President, but Henry Ruh KB9FO is returning your call about ham TV for the White House.*

## AUTHORS COMPENSATION

ATVQ pays authors of original technical material. Compensation varies from \$5 to \$35 per item according to published length. Authors may receive the compensation as an extension of their subscriptions or cash.

ATVQ is always looking for news, activities and technical material. Send all contributions to ATVQ, 1545 Lee St. #73, Des Plaines, IL 60018. Photos should be in black and white but color are acceptable. Diagrams should be in black ink and neatly drawn.

HAM CLUB PUBLICATIONS may obtain a blanket authorization to reprint news and articles from ATVQ by sending in a written request. Send a sample copy of your newsletter with your request and provide a copy of any issue in which you have included a reprint. A credit line should be added to the title page or any reprinted item.

# DAYTON ATV FUN

## FRIDAY

### ATV PARTY

7:30 pm till midnight

**FREE ADMISSION, REFRESHMENTS**

**HOLIDAY INN NORTH EXIT 57B off  
I-75. 2301 WAGGONER RD.**

**MAIN BALLROOM SEATS 300 IN  
C O M F O R T**

**SPEAKERS INCLUDE:**

*Al Chandler K6RKF of AEA, topic: VSB techniques and RF power measurement.*

*John Beanland G3BVU of Spectrum International, topic: antenna stacking and weather satellite reception.*

*Bob Rau N8IYD, topic: new video overlay ID system and model rocket ATV.*

*Larry Hillier N8EWV, topic: The latest in kite ATV experiments.*

*Bill Brown WB8ELK, editor 73 Magazine, topic: Next generation ATV balloon experiments and future payload display.*

*Dick Wolf W18Z, How to get yourself on cable TV and use their free production equipment for ATV or Ham Radio programs for public viewing.*

### **HOME BREW CONTEST WIN \$100 CASH**

***Bring your favorite home brew item, or if too big to lug in, bring photos and a description. Enter the contest, judges chosen from audience. Grand prize \$100 CASH you can spend on goodies or give to your wife!***

### **EYEBALL QSO**

***Meet the movers and shakers of ATV from around the world. Meet interesting people, eat, drink, have a good time! Play with the goodies, bring a SHORT tape of local ATV activity to share/duplicate.***

## SATURDAY

### More than Radios Reception

7 pm till midnight

**FREE ADMISSION, REFRESHMENTS**

**RODEWAY INN, FIRST EXIT SOUTH  
OF I-70/I-75 JUNCTION.**

**MAIN ROOM 2nd FLOOR  
ACROSS FROM THE RAMADA INN.  
SEATING FOR 150 IN COMFORT**

*Sponsored by ICOM, Zman Productions, WWATS*

*This is a reception.*

*There will be lots of food and drink and a number of really special surprises, door prizes and fun. Another opportunity to meet interesting people and socialize.*

*A very different video has come into the ham scene but where did it come from? Who created it? What is the story and the reason behind the message?*

*Meet the people behind the movie, More than Radios. Here is your chance to talk to the ATV group which helped make the latest ham radio movie. Meet and chat with the cast and crew. View the movie. Sneak preview of a behind the scenes video showing how the movie was made. Get ideas on how to use ATV to promote HAM RADIO in your area.*

*The movie will also be shown at the Friday FM BASH*

---

### **UPS RATE INCREASE**

ATV'ers might want to buy their next item on the new toy list at Dayton or before May 1. UPS has raised their rates 16%. Mirage has announced a coming price increase of 6%. It is expected all manufacturers will have to raise prices to cover increasing parts and shipping costs.

# THE SPACE SHUTTLE

## SAREX VIDEO EXPERIMENT OF STS-37

### Voice, Packet, SSTV and Fast-Scan ATV!

*The next SAREX (Shuttle Amateur Radio Experiment) mission, STS-37, is currently scheduled to lift off April 4th. Onboard the Atlantis will be the first all ham crew: Ken Cameron KB5AWP, Jay Apt N5QWL, Linda Godwin N5RAX, Steve Nagel N5RAW and Jerry Ross N5SCW.*

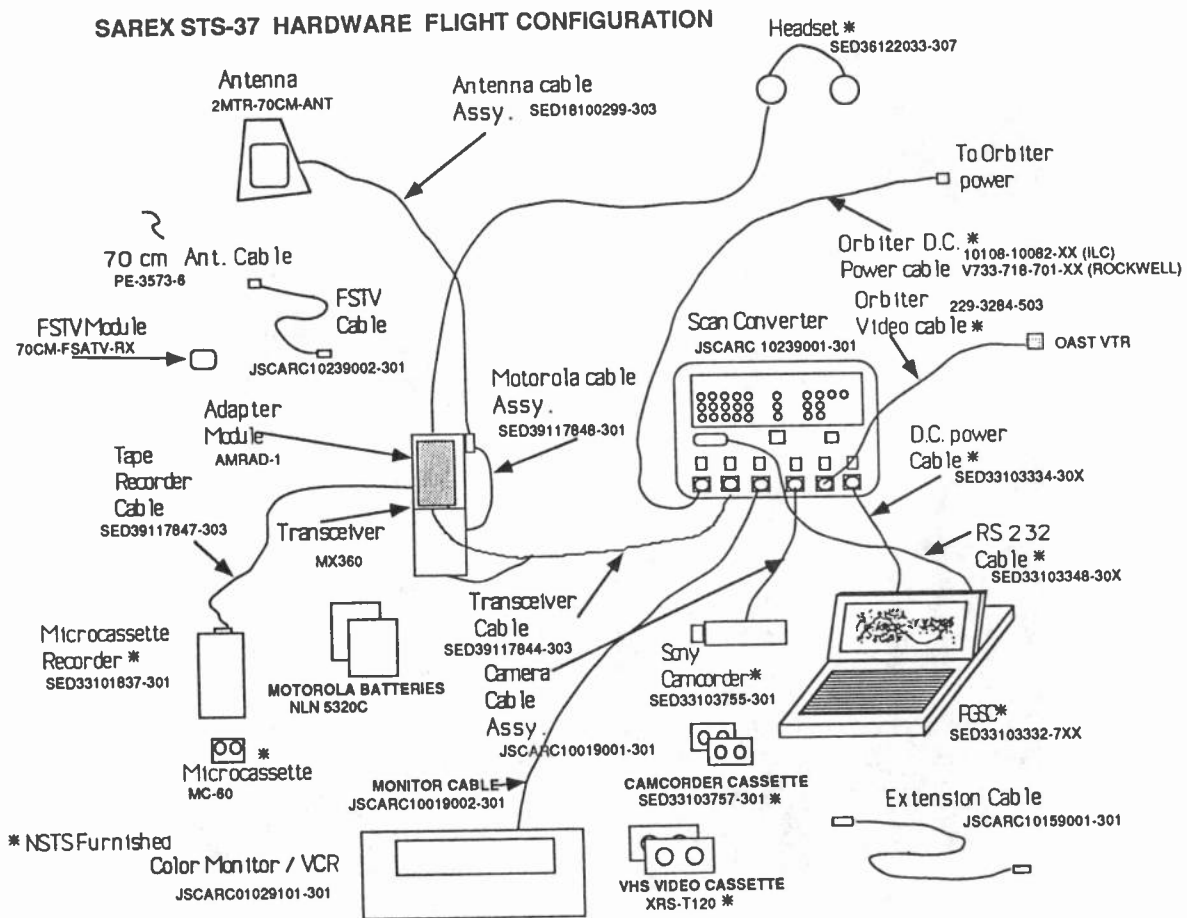

Photo. The STS-37 crew. Seated (left to right) - Ken Cameron KB5AWP, Steve Nagel N5RAW and Linda Godwin N5RAX. Standing (left to right) - Jay Apt N5QWL and Jerry Ross N5SCW. Photo courtesy of NASA.

# THE SPACE SHUTTLE

## SAREX VIDEO EXPERIMENT OF STS-37 Voice, Packet, SSTV and Fast-Scan ATV!

Another mission first will be the attempt to send a "live" full motion TV picture up to the shuttle via fast-scan ATV on the 70 cm band. Only a limited number of stations have been approved for this experiment primarily at the NASA space centers. If this is successful, it will be the first time any fast-scan video has been uplinked to any U.S. manned spacecraft. Please don't attempt to send any video up to the Shuttle unless you are part of one of the pre-arranged uplink sites. The uplink frequency is on a non-standard frequency and the astronauts won't be able to tune you in. If everything goes well with this ATV experiment, look for more ATV in future flights.



The following are the frequencies that will be used for the STS-37 SAREX mission:

Mode:	downlink Freq. (MHz.)	Uplink Freq. (MHz.)
Voice or SSTV:	145.55	144.95 (144.91 & 144.97 alternate)
Packet:	145.51	144.91 (144.93 & 144.99 alternate)

Thanks to Lou McFadin W5DID, Chuck Biggs, Roy Neal K6DUE and Bill Tynan W3XO for the above information. Diagrams supplied by Lou McFadin and Chuck Biggs.

# THE SPACE SHUTTLE

## SAREX VIDEO EXPERIMENT OF STS-37

### Voice, Packet, SSTV and Fast-Scan ATV!

*Four modes of communications are being planned (voice, packet, SSTV and ATV) during the five day mission. Direct voice contacts may be possible at any time. When the crew is busy with other duties, the packet robot (similar to STS-35) should be operational. Please note that it's only necessary to receive a QSO number from the robot to qualify as a valid contact. However, it's important to send in a copy of your contact for a QSL.*

## STS-37 APRIL 1991

## FLIGHT

## CAPABILITIES

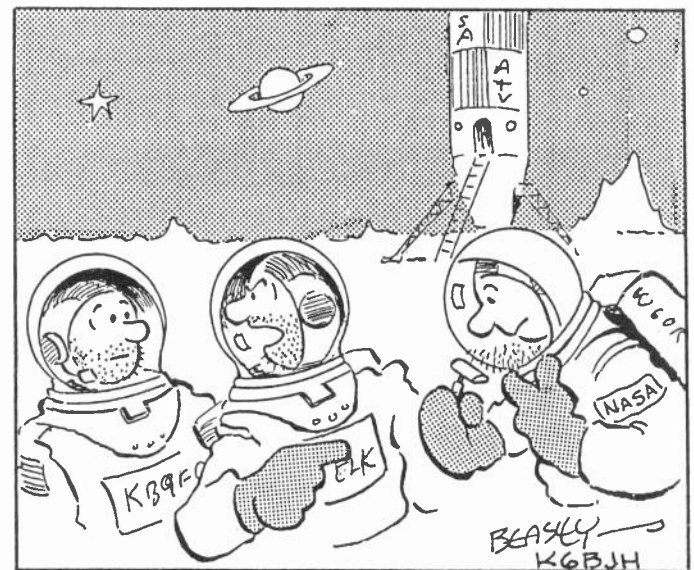
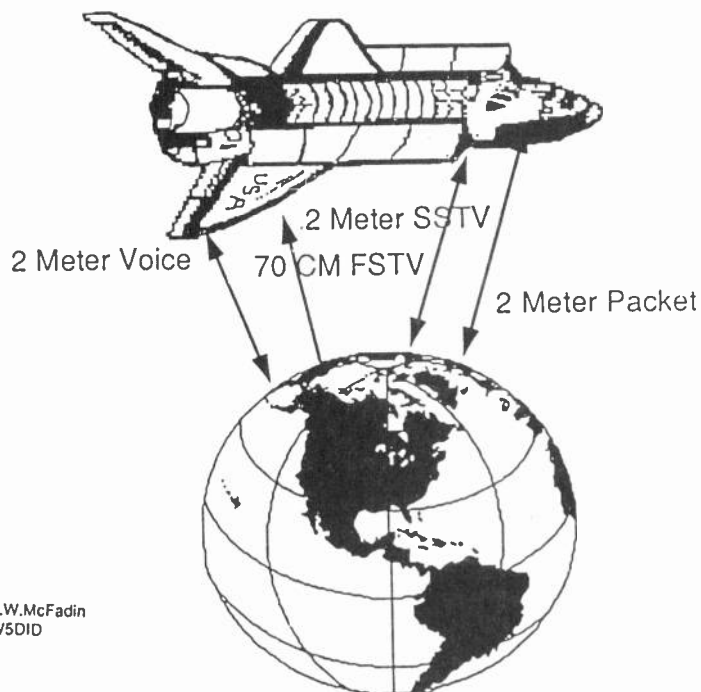

HOW DOES HE DO THAT?

L.W.McFadin  
W5DID

# THE SPACE SHUTTLE

## SAREX VIDEO EXPERIMENT OF STS-37

### Voice, Packet, SSTV and Fast-Scan ATV!

*The SSTV downlink should provide us with some spectacular views. Look for this mode during spacewalk activities and in particular during the release of the Gamma Ray Observatory (GRO). The SSTV transmission may be the only source of live video of the release since the NASA Ku band video link may have to be used for other data at that time. During the several scheduled school contacts, the astronauts plan to send down occasional SSTV pictures directly to the students.*

#### SCAN CONVERTER BLOCK DIAGRAM

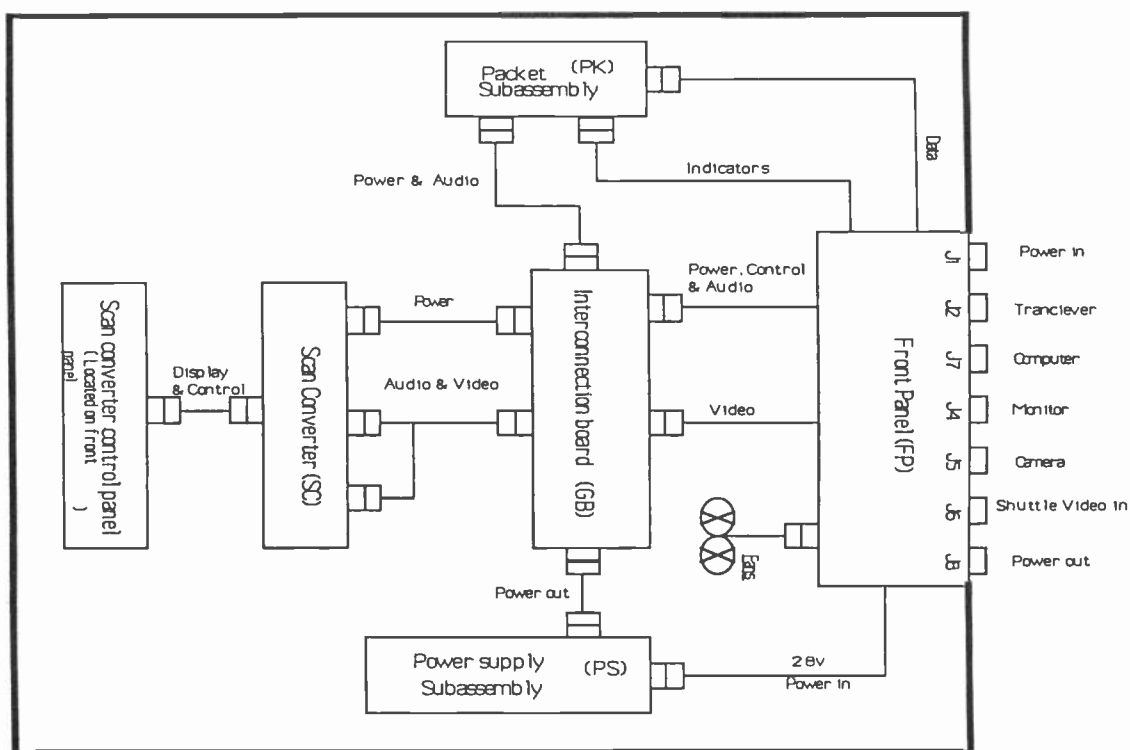

L.W. McFadin  
W5DID

**FOR SALE:** BETA MOVIE tapes used once. Erase and use over. \$2 each. UPS/US prepaid. W6LOU, Fred Plante, 10020 Sky Ct. CLR, Kelseyville, CA 95451, 707 277 7377. **FOR SALE:** unused software: PFS First Publisher, Printvision, Lotus Express, others. c/o ATVQ, booth 338.339 Dayton. Also: Sony BVU200B 3/4" editing, time code VCR, \$500 Telemet test signal generator \$500, Tandy DWP230 printer \$150, pair new 4CX250's \$150, Microwave Modules 1296 converter and 1296 preamp \$75 each. New, 1 each PCE 900 and 1200 MHz. downcon-  
**PAGE 8**

verters \$80 each. RCA TK76 complete with lens, cables, p/s carry case and spare "guts" \$500. Icom IC505 all mode (cw,ssb,fm,am) 6 meter 10 W portable/mobile, with book, works FB, \$350, PCE TX23-1 Transmitter, never used, \$300. 4 J-Beam MBM-88's with H frame, RG214 harness, now in use 2 yrs, buyer removes \$500 (putting up much larger array). new Mirage D100TVN amp \$300. Complete ATV repeater 921.25 in, 426.25 out, racks, 300 W Motorola amp, much more not at DeVry Chicago site. \$1500. (Over \$3,000 in hardware).

**ATVQ DEVOTED ENTIRELY TO HAM TV**



# WYMAN RESEARCH INTRODUCES NEW TRIDON LINE

ONLY  
\$249.95

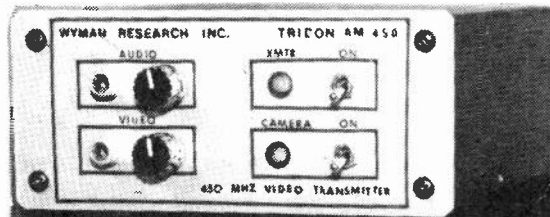

TRIDON AM 450 MHZ  
TRANSMITTER

\$319.95



TRIDON 2000 AM  
450 MHZ TRANSCEIVER

\$359.95

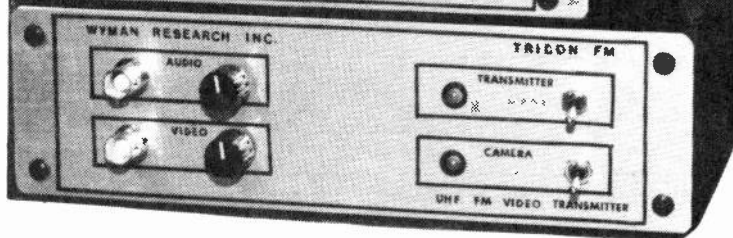

TRIDON FM  
TRANSMITTERS  
900 MHZ  
1200 MHZ  
ALSO 440 MHZ TOO

## 450 TRANSMITTER

- POWER OUTPUT IS 3 W PEAK
- TWO INDEPENDENT AUDIO SYSTEMS  
(Sub-carrier and On-carrier)
- 10 PIN CAMERA CONNECTOR ON BACK-BNC OR RCA CONNECTORS ON FRONT
- SYNC STRETCHER FOR OPTIMUM COMPOSITE VIDEO
- STANDARD CRYSTAL FREQUENCY: 439.25 MHZ or 434.00 MHZ
- POWERS VIDEO CAMERA (10 Pin Connector)
- REQUIRES 13.8V DC AT 600 MA PLUS CAMERA POWER ( 1 amp)
- RF TIGHT ALUMINUM CABINET WITH BRUSHED ALUMINUM PANEL CUSTOMED DESIGN-ED BY W9YL
- CABINET SIZE: 2.2"x5.25"x5.5"
- INCLUDES SEND-RECEIVE RELAY

## FACTS 450 TRANSCEIVER

- POWER OUTPUT - 3 W PEAK
- 10 PIN CAMERA CONNECTOR ON BACK PANEL, BNC OR RCA CONNECTOR ON FRONT PANEL
- MONITOR VIDEO FROM CAMERA OR DETECTED VIDEO OUTPUT
- ALL NEW VIDEO AND AUDIO CIRCUITRY WITH SYNC STRETCHER
- NEW TWO CHANNEL AUDIO SYSTEM ON TRANSMIT (SEE OPTIONAL RECEIVER BELOW)
- NEW MORE POWERFUL VIDEO TRANSMITTER
- STANDARD CRYSTAL FREQUENCY: 439.25 MHZ or 434.00 MHZ
- .8 DB NF GaAsFET PRE-AMPLIFIER
- RF TIGHT ALUMINUM CABINET WITH BRUSHED ALUMINUM PANEL CUSTOMED DESIGN-ED BY W9YL
- SIZE: 2.2"x7"x5.75"
- RELAY SWITCHED ANTENNA

## FM TRIDONS

BOTH HAVE —

- PRE-EMPHASIS CIRCUITRY
- "N" CONNECTOR
- RF TIGHT ALUMMINUM CABINET WITH BRUSHED ALUMINUM PANEL CUSTOM-ED DESIGNED BY W9YL
- CABINET SIZE: 2.2"x8.2"x5.5"
- REQUIRES 13.8 V DC AT 2 AMPS
- LARGE HEAT SINK
- 900 MHZ OR 430 MHZ**
- 915 OR 430 MHZ FM-ATV TRANSMITTER
- POWER OUTPUT IS 8 WATTS
- 4.5 MHZ AUDIO SUB-CARRIER
- USES NEW PHASE LOCK LOOP CRYSTAL CONTROLLED EXCITER
- 1200 MHZ**
- 1255 MHZ FM-ATV TRANSMIT-TER (Any optional freq.)
- POWER OUTPUT IS 4-5 WATTS
- 6 MHZ AUDIO SUB-CARRIER (Requires 1 V PP Audio)
- USES MILITARY QUALITY WOOD-DOUGLAS CRYSTAL CONTROLLED EXCITER

# WYMAN RESEARCH, INC.

R.R. #1 BOX 95  
WALDRON, INDIANA 46182  
(317) 525-6452

INDIANA RESIDENTS 5% SALES TAX

Don & Sue Miller  
W9NTP  
W9YL

DAYTON BOOTH 211

SHIPPING \$4.50

# PROJECT EXCELSUS

by Bill Brown WB8ELK

*Southeastern Community College students to send ATV transmitter and camcorder into SPACE! Instructors Ben Frink and David Couvillon KC4WDW along with Simms Spears have organized a space launch group of engineering and physics students at Southeastern Community College (Whiteville NC).*



*The Logo for Project Excelsus*

They are currently building a unique rocket/balloon system (Rockoon) as a class project. The plan is to lift their rocket up to 100,000 feet with a helium balloon (Raven Industries, Inc model 54k Astrofilm). Since this is above 99 percent of the Earth's atmosphere, a fairly small rocket launched from the balloon can achieve heights in excess of 50 to 100 miles! This is SCC's second balloon flight...see the January 91 issue of ATVQ, p. 61 for the story of their first flight.

The 10 foot long fiberglass rocket will house a SONY color camcorder, a lithium cell battery pack and a 1 watt PC Electronics KPA5-RC ATV transmitter. The rocket downlink will be on 439.25 MHz. AM & 1255MHz. FM (vertically polarized). The rocket motor (M size) is being made by Vulcan and should supply nearly 10,000 Newton- Seconds (2300 lb-sec.) of thrust. For comparison, the typical hobby store model rocket uses an A through F motor. Each letter designation is an order of magnitude more thrust!

The Rockoon system will carry three separate ATV transmitters and cameras. The rocket system is self-contained. The second module contains the telemetry and control package. It will have another camera (GBC CCD-100 b/w) pointed at the rocket. This module will transmit during the balloon ride up to 100,000 feet on 426.25 MHz. It will also give ATVers within 400 miles of the balloon a ringside view of the rocket launch! A VHF packet link will be used to downlink telemetry and

PAGE 10

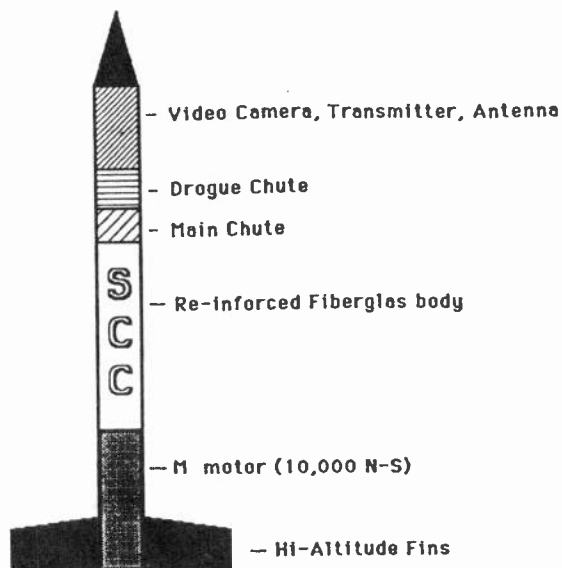

*Details of the SCC space Flight Rocket.*

to issue the ignition instruction. The rocket ATV system will be activated just prior to liftoff. After ignition, it should only take a few minutes to reach the maximum altitude of 50 to 100 miles. At this altitude, ATVers as far away as 700 miles may be able to see the spectacular views from space!

Even though the rocket motor only burns for 0.8 second, it will probably approach a velocity of 3000 mph (MACH 4). Unfortunately this is nowhere near orbital velocity. Once it gets up to the maximum altitude, it'll come right back down. The whole flight into space will take only a few minutes.

The balloon will be launched from the NC coastline and should drift about 50 miles out to sea. At this point, the rocket will be fired and should allow it to splashdown harmlessly into the Atlantic. Several ambitious chase boats will attempt a recovery.

Further updates and announcements can be obtained from AMSAT bulletins (during their nets and on your local packet BBS). Also we will announce the final launch date on the weekly ATV net on 3.871 MHz. (tuesday nights at 8 pm Eastern).

An HF net will convene just before launch on 7.155 MHz. for launch information and reception reports. You can contact Ben Frink at SCC for additional information at (919) 642-7141. or Southeastern Community College, Hwy. 74 West, P. O. Box 151, Whiteville NC 28472.

The planned launch date is mid May.

ATVQ DEVOTED ENTIRELY TO HAM TV

# COMET

ANTENNAS FOR THE PROFESSIONAL AMATEUR

## CYA-1216E

16 Element Yagi Beam 1260-1300MHz  
 Gain: 16.6dB  
 VSWR: 1.5:1 or less  
 Impedance: 50 ohms  
 Max. Power: 100 watts  
 Polarization: Vertical or Horizontal  
 Length: 4' 5"  
 Weight: 8 lbs. 11 ozs.  
 Mounting Mast Diameter: 1 1/2"  
 Connector: N-type  
 Construction: All Aluminum

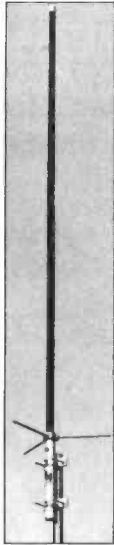
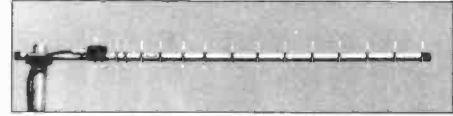

## CA-1243Z

Dual Band  
 440-450MHz  
 1250-1300MHz  
 Base/Repeater Antenna  
 5/8 Wave x 4 446MHz  
 5/8 Wave x 9 1200MHz  
 Gain: 446 9.4dB  
 1200 12.8dB  
 Impedance: 50 ohms  
 VSWR: 1.5:1 or less  
 Max. Power: 446 150 watts  
 1200 50 watts  
 Length: 7' 5"  
 Weight: 2 lbs. 8 ozs.  
 Connector: N-type  
 Construction: Heavy Duty Fiberglass



## CA-1221S

Mono Band  
 1260-1300MHz  
 Base/Repeater Antenna  
 1/2 Wave 21 Step  
 Collinear  
 Gain: 15.5dB  
 Impedance: 50 ohms  
 VSWR: 1.5:1 or less  
 Max. Power: 100 watts  
 Length: 8' 6"  
 Weight: 2 lbs. 3 ozs.  
 Mounting Mast Diameter: 1 1/4-2 1/2 inches  
 Connector: N-type

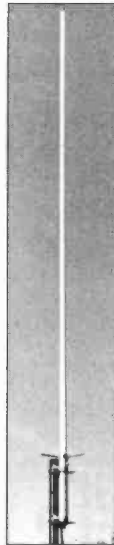

## PVA-913

Base 13 Element Yagi  
 904-920 MHz  
 Gain: 15.8dB F/B ratio  
 over 20dB  
 Max. Power: 150 watts  
 VSWR: 1.5:1 or less  
 Length: 4' 8"  
 Connector: N-type  
 Construction: Aluminum

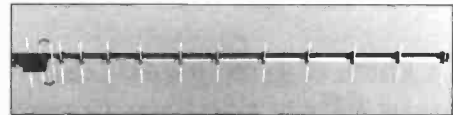

## MINI SWR

Power Meters

		Max. Power	Insertion Loss
CA-200	140-150MHz	45 watts	0.1dB
CA-300	200-240MHz	60 watts	0.2dB
CA-400	420-460MHz	50 watts	0.2dB
CA-420	140-460MHz	50 watts	0.1-0.2dB
CA-900	840-950MHz	60 watts	0.2dB
CA-1200	1225-1325MHz	60 watts	0.25dB

Measurements: 2.25" w x 2.25" h x 1.1" d  
 Weight: 5.25 oz.  
 CA-200, 300 and 400 have SO 239 Connectors  
 CA-420, 900 & 1200 have N Connectors

## FP-19

Base/Repeater  
 935-925MHz  
 Gain: 16dB  
 Impedance: 50 ohms  
 VSWR: 1.2:1 or less  
 Max. Power: 100 watts  
 Length: 7' 4"  
 Connector: N-type  
 Construction: Heavy Duty Fiberglass

## CF-4130

446/1200MHz  
 dB Loss: 1.3-460MHz 0.2dB  
 900-1400MHz 0.3dB  
 Band Rejection: 55dB Down  
 Max. Power: 146MHz 800W PEP  
 446MHz 500W PEP  
 1200MHz 700W PEP  
 Connectors: N-type



NCG CO. 1275 North Grove Street • Anaheim, CA 92806 • (714) 630-4541 • Orders (800) 962-2611

**CALL FOR THE DEALER NEAREST YOU!**

# PROJECT EXCELSUS

CONCEPTUAL DESIGN

Scheduled for May 18th Launch

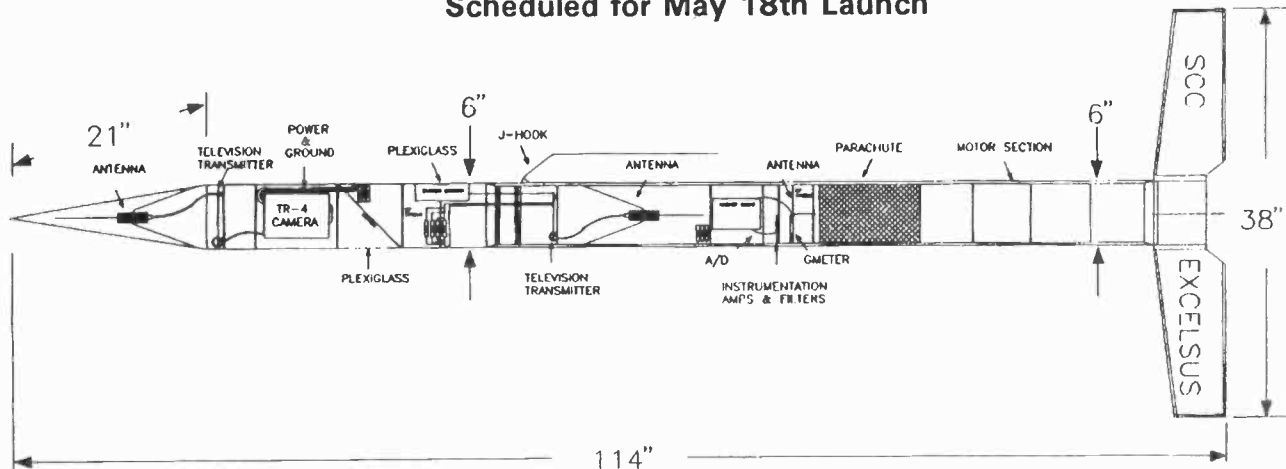

SOUTHEASTERN COMMUNITY COLLEGE  
 ELECTRICAL ENGINEERING DEPT.  
 P.O. BOX 151  
 WHITEVILLE, N.C. 28472  
 (919) 642-7141 EXT. 251

Designed specifically for amateur television in the 70cm band...

# FL407 INTERDIGITAL FILTER

**7-Pole Interdigital Vestigial Sideband Filter for Frequency Ranges of 420 MHz to 440 MHz**

The 6 MHz nominal bandwidth and low loss design are perfect for transmitter or receiver use. Two filters can be used for repeater applications.

Heavy duty construction insures stable operation and long life.

**Ordering Information:** The FL407 may be ordered on any frequency between 420 and 440 MHz. Please specify video carrier frequency when ordering.

**Dimensions HWD:**  
2 1/8" x 8 13/16" x 20 5/8"

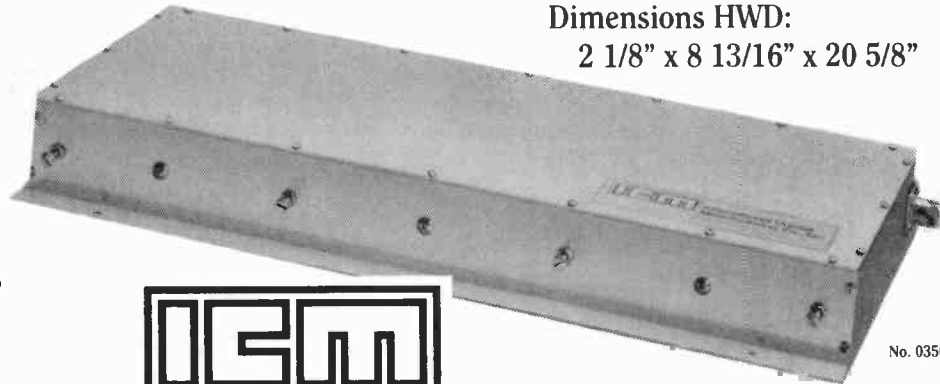

No. 035026



**International Crystal Manufacturing Co., Inc.**

P.O. BOX 26330 • 701 W. SHERIDAN • OKLAHOMA CITY, OK 73126-0330 • (405) 236-3741 • FAX (405) 235-1904

## SATELLITE TRACKING MADE EASY

WITH SOFTWARE FROM  
**AMSAT**

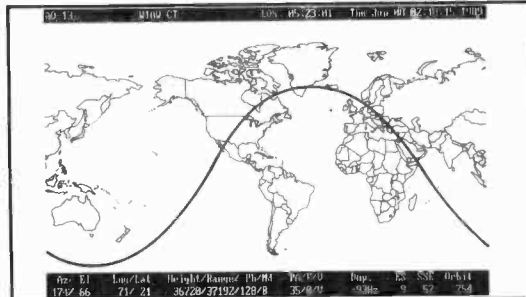

Line representation of QuikTrak 4.0 World Map

### QuikTrak 4.0

Whether you want to identify the next time Oscar 13 will provide communications between two cities or if you just want to know the next time you can visually sight the Soviet space station MIR, QuikTrak will let you plug in the latest Keplerian elements for up to 100 satellites using a new full screen editor. QuikTrak also supports autotracking. *Hardware requirements*, IBM PC, AT, PS/2, or clone with a minimum 512K memory. CGA or EGA graphics required. Numeric coprocessor not required but recommended.

### InstantTrack 1.0

For those concerned with greater speed and capability, InstantTrack offers all of QuikTrak's features plus instant visibility for your "favorite" satellites before you issue the first keystroke. More than 200 satellites and 1754 cities are on the menu and will be in full-color high-resolution EGA or VGA modes. *Hardware requirements*: IBM PC, AT, PS2 or clone with at least 512K memory. EGA or VGA graphics required. Numeric coprocessor not required but recommended. Mouse not required but can be used on the map screens.

*These are only a few of the features of QuikTrak and InstantTrack. The figures below reflect suggested donations to defray production expenses and benefit AMSAT's non-profit, educational activities.*

Recommended Donations:		Member	Non-Member
QuikTrak 4.0	5 -1/4"	\$55	\$75
InstantTrack 1.0	5 -1/4"	\$50	\$70
AMSAT membership \$30/yr U.S.; \$36/yr Canada & Mexico; \$45/yr Foreign			

**AMSAT PO Box 27 Washington, DC 20044**

301-589-6062 Voice, 301-608-3410 Fax

# UP!

# UP!

# AWAY!!

## Balloon Launch Schedule

They're popping up everywhere!

by *Bill WB8ELK*

*Weather balloon amateur radio payloads are becoming more and more popular. The idea of sending a radio to the edge of space has also inspired quite a few radio clubs and schools to put together some really innovative packages; makes a great group project.*

Simpler payloads, such as a small 10 m. or 2 m. beacon have made it relatively easy to put together a fun experiment. Look for a lot more flights this year over the US and S. Africa (quite an amateur radio balloon group there!).

Here's a list of upcoming balloon flights for the next few months. These dates could be tentative and, of course, could be delayed due to weather. It's best to check into the ATV net on 3.871 MHz. (every tuesday evening at 8 pm) or check your local packet BBS for any updates. When possible I've also listed a local contact person for information as well.

### ***The KB7JGM "Earthwinds" manned test flight with live color ATV***

This flight (see details in Jan. 91 ATVQ and the March ATV column in 73 Amateur Radio Today) has been delayed until September. Larry Newman KB7JGM should treat us with spectacular views from 17,500 feet as he and his crew drift across the whole country.

### ***April 13th (morning) WB9SBD Balloon from Hillsboro, WI***

A full-fledged 2 M. FM repeater will be flown up to 100,000 feet. Input will be on 144.48 MHz. and output 147.48 MHz. The non-standard split is used to minimize desense. If your 2 m. rig can't handle the odd split, just stay on simplex and whirl your tuning to the input frequency to transmit. Should be interesting to see who makes the furthest contacts. A special QSL is available to anyone sending in reception reports. Contact Joe Mayenschein WB9SBD, Rt. 1, Box 235A, Hillsboro, WI 54634 for further information. There will be an HF net on 7.155 MHz. just before and during the flight.

### ***April 27th @ 10:00 am EDT W3ADO Balloon from Annapolis, MD***

As part of a student experiment, this balloon will be launched from the US Naval Academy at Annapolis. It'll carry a 2 m. FM (100 mW.) transmitter on 144.34 MHz. sending down a CW telemetry beacon. The message sequence consists of a CW ID following by a series of tones indicating temperature (inside and outside) and pressure (altitude). The CW message may change during different phases of the flight. They'll be tracking the balloon with a 40 foot dish antenna! Contact Bob Bruninga WB4APR at the Aerospace Dept., U.S. Naval Academy, Annapolis, MD 21402. (301) 267-4380.

### ***May 4th or 11th @ 9:00 am CDT WB5HLZ balloon from Houston, TX***

Live camera ATV on 434 MHz. along with video ID (voice ID with several messages on the subcarrier). 2 m. FM on 147.435 MHz. with packet telemetry. Also there will be a 50 mW. ten meter CW beacon on 28.322 MHz. HF net on 7.155 MHz. as well as 28.332 MHz. (for 10 m. beacon reception reports). This experiment should be heard over a good share of Texas, Oklahoma, Louisiana and into Alabama. The 10 m. beacon should cover the country. Contact Burns Cleland WB5HLZ at 5106 Elm St., Houston, TX 77081 for more info or send a packet message to Alan N5LKJ & N5LKJ.

### ***MAY 4th @ 9:30 am MDT AA0P Balloon from Denver, CO***

ATV - Live camera (GBC CCD-100) via 426.25 MHz. (PC Electronics KPA5 into a horizontally polarized Little Wheel antenna), 2 m. FM (2 watt Hamtronics TA-51) on 144.34 MHz. with voice telemetry and a quarter watt 10 m. CW beacon on 28.8 MHz. HF net on 7.232 MHz. (Eileen WD0DGL will be net control) as well as 28.790 MHz. A 400 mile range is possible from the Denver area. Contact Jack Crabtree AA0P at 4327 W. Bellewood Dr., Littleton, CO 80123 for more info. Sponsored by Edge of Space Sciences, Inc. (303) 795-7736.

THIS IS THE ONE THEY ARE ALL TALKING ABOUT!

"DON'T SPEND KILO-BUCKS!"

*The Poor Man's*  
*Spectrum Analyzer*  
*Receiver Kit.*

*(Prices start at \$100)*

NOW TUNES FROM  
APPROX. 2 TO  
1,500 MHz!

FOR FULL DETAILS  
SEND A SELF ADDRESSED STAMPED ENVELOPE  
TO:

SCIENCE WORKSHOP  
BOX 310-C  
BETHPAGE, NY 11714

*Visit us at the Dayton Hamvention*  
*Booth 323*

## Balloon Launch Schedule

**May 18th (morning)**

**KC4WDW Rockoon flight from SE NC**

See the story in this issue about the Southeastern Community College ATV space rocket. 350,000 feet or more altitude with three sources of video. The rocket will transmit on 439.25 MHz. AM as well as 1255 MHz. FM activated just before takeoff from 100,000 feet. The launch platform will be on 426.25 MHz. throughout the flight). 2 m. packet telemetry downlink (frequency to be announced). HF net on 7.155 MHz. before and during the flight.

**June 15th (morning)**

**W6BHZ Balloon from Edwards AFB, CA**

ATV - live camera on 434 MHz. (vertical). 2 m. FM packet telemetry downlink. This is a student engineering experiment (the teen technical project) sponsored by the Society for Women Engineers (SWE) from Cal Poly University in San Luis Obispo. A large sounding balloon (RAVEN 19k cu. ft.) will lift an atmospheric sampling apparatus up to around 80,000 feet. Ought to be quite an adventure chasing down the payload in the desert. I imagine the southern California T-hunt club will bring this one back alive! There will be an HF net on 7.243 MHz. (West Coast ATV net frequency) starting up just before the launch. For more info write to the Cal Poly Amateur Radio Club, UU Box 53 - Cal Poly, San Luis Obispo, CA 93407 or call David Fichou KB6OEN at (805) 546-9369. The SWE group can be reached at the following: The Society for Women Engineers, California Polytechnic University, Student Life and Activities, Box 162, San Luis Obispo, CA 93407.

**June 29th @ 9:30am EDT**

**W8BI Balloon from Dayton, Ohio area**

Live camera video transmitted on 439.25 MHz. (horizontal) using a PC KPA5-RC transmitter and a Uniden B/W camera. 2 m. FM (Hamtronics TA-51 modified for 100 mW. output) with voice ID on 144.34 MHz. 20m CW transmitter on 14.035 MHz. (Ramsey QRP-20 kit). Sponsored by the Dayton Amateur Radio Association (DARA), this balloon will lift off from an actual weather bureau radiosonde launching site near Huber Heights. HF net will convene on 7.232 MHz. starting at 7:30 am. Contact DARA for more information: Dayton ARA W8BI, P.O. Box 44, Dayton, OH 45401-0044.

**July/August (morning)**

**W0RPK Balloon from Des Moines, Iowa**

Packet robot system which will also relay telemetry on 2 m. FM. Downlink frequency is 145.55 MHz. and uplink on 144.95 MHz. (similar to the STS-35 operation). Telemetry will consist of inside/outside temperature,

atmospheric pressure (altitude) and the actual Latitude/Longitude as determined from an onboard Loran C receiver (Interphase DC-2000). Telemetry control is performed using a 68HC11 microcontroller (similar to the one in the May 89 issue of Ham Radio, p.23). In the fall, a series of flights carrying school experiments will be launched. Contact Ralph Wallio W0RPK at 1250 Hwy G-24, Indianola IA 50125 for more info. Packet messages can be sent to W0RPK @ W0AK.

**Look for periodic launches from the following locations during the spring and summer:**

**Palestine TX**

Bob Moody K7IRK will continue his low-power (50 mW.) ten meter flights attempting to send a miniature package to the East Coast. His two previous flights have been heard at good signal levels in over ten states!

**Hancock NH - WB8ELK/1**

OK, what's the ELK up to?. I'm currently planning a series of small 10 m. (28.322 MHz.) 2 m. (144.34 MHz.) and 70 cm (433.6 MHz.) CW or FM test flights to prove out a R/C controllable balloon system. Also I'll be trying out a simplex 2 m. repeater and a cross band repeater 2 m. to 10 m. or 70 cm to 2 m. Watch for these during the spring and early summer months over New England. The idea is to choose your landing sight and bring your payload down to land at your feet!

**Midwest - WB8ELK ATV  
Repeater Balloon - Summer 1991**

Look for an ATV REPEATER flight with an input on 1280 MHz. FM or 1255 MHz., I may also have a 910.25 MHz. AM alternate input) and output on 439.25 MHz. AM. This flight will be flown from the midwest (Ohio or Illinois - KA9SZY & KA9SZX near Champaign, IL) and could potentially allow 2 way ATV QSOs between stations over 600 to 700 miles apart (maybe further). Since there are over 20 active FM ATV stations in the midwest, there won't be video chaos on the uplink (now is the time to start building up your FM TV transmitter on 23 cm!). The downlink on 439.25 MHz. will allow everyone to watch the fun.

Is this your  
copy of ATVQ?  
Subscribe today!

# ATV NEWS BRIEFS

## ATV TO BE FEATURED AT MARYSVILLE, OH HAMFEST

Many ATV forums and demonstrations will be featured this year at the bigger and better Marysville Hamfest and Computer Show to be held on Sunday, August 25th, at the Fairground in Marysville, Ohio. (Near Columbus, Ohio in the center of the state.) The world famous "HAMCAM" ATV van will be on display and operating during the fall event. Many commercial vendors have agreed to attend the show and a huge flea market will be presented. XYL's and children are to be admitted free this year, with craft shows and more to keep them entertained all day. On Saturday night there will be free entertainment for the overnight campers. All local ATVers are invited to attend, and see ATV in action at the Hamfest.

## CHICO, CA Tom Park W6SYX

Here is a little news item for ATVQ. The magazine has been of great value in setting up our repeater. ATV activity in the Chico area in Northern California began last fall with simplex operation between Tom W6SYX, Dan N6RZJ and Ken KB6RHC on 70 and 33 cm. The N6RZJ repeater went into service in May with input on 910.25 MHz. and 10 watts out on 427.25 MHz. Ken and Dan did the design and installation. The repeater site is at 3,500 feet elevation in the Sierra foothills east of Chico with good coverage over a 50 mile radius.

Chico ATV operators in the area at the time of this writing (June) are Ken WB6RHC, Dan N6RZJ, Joel KB6QVI and Cecil WD6CUK. Tom W6SYX is on from Paradise and Al N6YCK sends his video from Red Bluff. Interest is high and a number of other hams intend to join the ATV gang in the near future. A demonstration scheduled for the November meeting of the local radio club will probably result in more recruits for the video hobby.

## Dayton Amateur Radio Association ATV Balloon Launch 29 June 1991, 0930L, 1330 UTC

### Payload:

ATV transmitter operating on 439.250 MHz. with live camera and alpha-numeric telemetry video interlace showing altitude and outside temperature. Also, a 2 meter 100 mW FM transmitter with digitized voice will be operating on 144.340 MHz. Additionally, a 20 mtr. beacon on 14.035 MHz. will be a part of this payload.

70 CM ATV antenna  
Horizontally polarized little wheel 2 meter antenna:  
vertically polarized 1/2 wave

20 meter antenna  
Vertically polarized end fed 1/2 wave

Total flight duration will be approximately 2 1/2 hours.  
Expected apogee will be 100,000 feet +.

A 40 meter net will be conducted on 7.232 two hours prior to balloon launch.

For Further Information please contact Dave Pelaez, AH2AR, at 513-233-1641 or Gerry Stephens, W8LLW, at 513-890-5920.

### Launch Site

To be announced (within the greater Dayton area).  
Payload weight: 4 pounds. Lifting body: weather balloon with helium. Total power current budget: approximately 1 amp current draw. Expected ATV 20 meter transmitter life: 7 hours. Expected 2 meter beacon life: approximately 30 hours.

## NASHVILLE, TN Bob Wiggins KJ4ZQ

I'm always thinking of ways to let people know about ATV. I decided that an exhibit at the Cumberland Science Museum might be a good idea. We had a whole room all to ourselves. Curt, N4MEY and Troy, KB4RBY and myself set up a pretty nice exhibit and demonstration (if I do say so myself). We brought in the Nashville ATV repeater and antennas. I was able to get the local Circuit City to loan us a big screen TV and Troy rigged up a creepie peepie for a demo. Curt spoke to the spectators about ATV and answered questions. I'm not a very good photographer but my son opened the camera in the middle of a roll of film. In spite of this, we did get a few pictures. Tom, WA4CGF arranged for Senator Al Gore to come to the Cumberland Museum. Senator Gore was introduced by Ashley, KC4RFV, and gave a short speech in support of Amateur Radio.

We are also transmitting the Nashville Amateur Radio Club (NARC) meetings on ATV hoping this might stir up some interest. We're having a lot of fun with ATV and if you want, let us know about ATV airplane or balloon flights on short notice, or leave me a message on the WA4JUB packet bbs in Nashville.

We are transmitting QSO Amateur Radio TV show on our ATV repeater. I called in after you did to the voice portion.



# ATV NEWS BRIEFS

## NEW 1691 MHz. WX RECEIVING SYSTEM

Spectrum International would like to inform you of their new weather satellite receiving system equipment. They are now offering a complete system, including the PC controller, as opposed to only a pre-amplifier and down-converter.

Following the demise of Microwave Modules, Ltd. they have concluded an agreement with Time Step Electronics, also in England, to import and distribute their product line into North America. SI is very excited about the Time Step units and consider ourselves to be very fortunate. The picture quality and performance of the new units are excellent and we are proud to place our name on them.

The design approach used for the new system differs from the Microwave Modules scheme. Instead of using a down-converter from 1691 MHz. to 137 MHz. and then feeding the signal into a 137 MHz. receiver, the new 1691 MHz. design uses a dedicated 1691 MHz. receiver. The companion low noise GaAsFET pre-amplifier has increased gain and better filtering than the equivalent Microwave Modules design.

Another feature of the new system is the availability of a companion decoder board (IBM-PC VGA compatible, short slot "half-card") and software. The board has two input channels, the second one to receive input from a second (137 MHz.) receiver. The board gives VGA 800 x 600 resolution by 256 colors in standard VGA systems and 1024 x 768 by 16 colors (256 colors if your video display board has 1 Mbyte memory) in high definition video display systems.

The new radio units are far superior to the old designs. For only \$45 more than before you now get a higher gain pre-amplifier and a complete receiver instead of just a pre-amplifier and a down-converter. The receiver takes advantage of the latest IC design techniques and includes a threshold extension circuit for better reception of low level (noisy) signals. Such pictures would be classified "unusable" if received on a traditional receiver. Every radio function in the new receiver is either automatic or is controlled from the computer's keyboard.

An attractive feature of the new units is their very reasonable price; together they cost only \$45 more than the Microwave Modules pair and you get a complete receiver not a down-converter.

The prices of the items are:  
1691 MHz. pre-amp, model TS-1691-P.Amp \$175  
1691 MHz. receiver, \$625  
model TS-1691-Recvr \$450  
Decoder Board & Software TS-VGA-SAT3 \$300

Also available are:  
Low Loss (microwave) coaxial cable (65 ft.) with connectors, part # 1691-coax ass'y \$45  
Loop-Yagi antenna, model #1691-LY(N) \$92  
Loop-Yagi extension, model # 1691-LY-XTN \$75

The PC-SAT SYSTEM (all of the above) is available as a complete system, FOB Concord, Mass for only \$1100

The sizes of the new units are:

Pre-amplifier 1.5" x 1.5" x 4"

Receiver 5" x 4" x 1.5" the complete receiver!

Decoder Board IBM-PC (or clone) short slot, half card.

Best of all we currently have stock, on the shelf, available for immediate delivery.

A "demo" disc (IBM PC format) with picture signals recorded from the new system is available for \$5.00, post free.

137 MHz. equipment pricing:

137 MHz. Low Noise Pre-amplifier RNg137 \$80.00

137 MHz. antennas: 2XY-137-C \$85.00

5XY-137-C \$115.00

Spectrum International, Inc.  
P. O. Box 1084  
Concord, Mass. 01742  
(508) 263-2145

## NE FREQ. COORDINATION Lyn W1NRE

Just a quick note to make you aware of the ongoing efforts in the tri-state area in regard to frequency coordination.

With recent election of officers to the tri-state amateur repeater council (NY, NJ, CT), the mood is right for favorable decisions on the part of ATVers in the area.

As one of the Connecticut directors on the council, I was asked to provide some technical input to the board. As a result of this, the enclosed report and a short video tape on the aspects of ATV and its relationship to other operating modes was presented at a general meeting of the council on February 2, 1991. The report was received favorably by the council. Note the liberal use of ATVQ material. A very good representation of ATV operators was also made at this meeting.

The detail band plan for the 70 cm. band has not yet been adopted by the council, but decisions will be based on technical merits and level headed thinking. We are pushing real hard to have 434.00 become a coordinated pair with 421.25, but the council presently seems a little reluctant. They are interpreting the rules to the letter of the regulations even though other coordinating councils are allowing it. Perhaps you could provide a little ammunition on this topic.

A new ATV repeater is now in operation in the northern part of the state near the Massachusetts border. Their input is 439.25 with the output at 426.25. They are also considering inverting their frequencies as a result of packet operations on their inputs.

# ATV NEWS BRIEFS

## NEW OMNI "STICK" ANTENNA

New vertical fiberglass omni "stick" antenna from Diamond covers inband 70 cm ATV repeater frequencies. RF Parts announced that they have just got in two new band segments of the model F-718 vertical omni. The 9.3 dBd gain 18 half wave transposed coax section antennas are made to cover a 10 MHz. segment of the band with a little overlap. The first model F-718A covered 440-450 (good for 439.25) but now you can get the F-718J 430-440 (for 434.0) or F-718L 420-430 MHz. (for 421.25, 426.25 or 427.25 ATV). Inband ATV repeaters can get high gain at a reasonable price to run two antennas rather than one expensive broad band one with a duplexer and extra filter. Price of the antenna is \$229 and are UPS shippable even though they are 15 ft. long when the three sections are screwed together. They will handle up to 250 watts. For more info contact RF Parts or P.C. Electronics.

## DAYTON ATV FORUM

1445-1700 Amateur Television (Fast Scan ATV) Forum Room 3. Moderator, Tom O'Hara, W6ORG

### SPEAKERS

"Using and Linking ATV repeaters for Sky-Wam and Space Shuttle Video" - Dave Baxter, W5KPZ

"ATV in the classroom" - Carol Perry, WB2MGP

"ATV special events and applications" - Bill Brown, WB8ELK

## SAREX STS-37 AUTHORIZED ATV STATIONS

The ARRL applied for and received a waiver of 97.209(b)(2) of the FCC rules last year to enable specific earth stations to transmit ATV outside the 435-438 satellite sub band segment during the STS 37 space shuttle flight. Only these stations are authorized to transmit to the space shuttle for the SAREX experiment. Kindly be aware of these stations activities and do not transmit during the space shuttle exoperiment as this may cause interference. The future experiments for ATV in space depends largely on the success of these stations being able to make video contact to the shuttle during STS 37. The authorized stations are: W6VIO, Jet propulsion lab, Pasadena, CA; WA3NAN, Goddard Space Flight Center, Silver Springs, MD; W1AW, ARRL, Newington, CT; W5RRR, Johnson Space Flight Center, Houston, TX; WA4NZD, Marshall Space Flight Center, Alabama; KE4PT, Motorola, Coral SPrings, FL; AK8Y, Lewis Research Center, Cleveland, OH; N9AB, Andy Bachlor, Mundelein, IL; KC6A, Long Beach, CA, alternate for W6VIO.

## CHEAP 900 MHZ. TX/RX

The low power TV "relay" transmitters which are advertised to operate on low UHF TV channels ie ch. 14-25, or offered as ham TV (420-450MHz.) transmitters are ILLEGAL. to use to transmit your VCR rental movies, broadcast or cable TV.

There is a LEGAL alternative. The FCC changed part 15 of the rules to allow low power TV home/industrial transmitters and receivers in the 900-930 MHz. band. These units can be used to relay any video source over short distances by anyone. They are not protected from interference such as HAM TV! So get ready for an audience! DAK Industries, 8200 Remmet Ave., Canoga Park, CA, 91304 offers these TV units as a transmitter/receiver set at a new low price of \$69.90. Order # 5704 and reference this note in ATVQ.

## SATELLITE HAM RADIO TV PROGRAM

As we mentioned last issue, those tuning around the satellite TV channels may have been surprised to see a satellite delivered TV program about HAM RADIO! The program was on Spacenet 3 Channel 4 at 9 PM to 10 PM CST. The host is Jack WA2QYT of Auburn, NY. The program, on video tape, is mostly Jack in his ham shack explaining ham radio. Recent programs have covered packet and ATV and repeaters.

The program has expanded to two nights. Monday from 9 PM to midnight on S1 ch 15, talk show on 6.2 MHz. audio and video/audio on 6.8 MHz. from 10-11 PM EST. On Tuesday from 9 PM to midnight on S3 ch 4, chat on 6.2 MHz. and video program with audio on 6.8 MHz. from 10-11 PM EST. The program has been cleared of commercial matter and the producers are asking that ATV'ers provide re-transmission of the ham TV program, called QSO Amateur Radio. Some ATV clubs and individuals are already doing this after discovering the program or reading about it in the our January 1991 issue. Contact them at QSO Amateur Radio, PO Box 254, Syracuse, NY 13215 or Jim Bass at 315 673 3752.

The program producers are also looking for videos about ham radio. If you have a video tape which explains or shows a particular aspect of ham radio, send it in.

It is also easy to use the promotional TV program to attract new hams by requesting that your local cable company carry it! Then put up signs in stores, bulletin boards, and if you can, get some local radio/TV news time to tell about it. If you're clever, you can write a PSA (public service announcement) or press release which promotes the program and where it can be seen (ie via your local company or via Ham TV).

# WHEELS

( Little, Mini, Micro )

“AS USED AT THE  
EDGE of SPACE”

- Omni-Directional ANTENNA
- HORIZONTAL Polarization
- Very Lightweight
- used on Balloons, Kites, R/C
- Available for 70cm, 23cm & 13cm (33cm Special Order)

P4 signals have been sent 393 mi.  
Using 3 watts into a little-WHEEL  
From the Edge of Space.\*

Assembled/  
Tested — \$29.95

KIT — \$24.95

Add \$3 for Postage — SPECIFY BAND  
& CONNECTOR

Dave Clingerman W60AL  
**Olde Antenna Lab**  
4725 W. Quincy  
DENVER, CO 80236  
303-798-5926

\*—(KDOFW Balloon Flight — FEB. 10, 1990) DAYTON BOOTH 338

## Micro-Video Camera

SMALL SIZE 2"x3"x1"

Feather Weight 4 oz.

NTSC Output 240 TV Lines

Low Light 2 Lux 7-15 VDC/<100ma.

Typical Applications: ATV, Robotics, Computer  
Vision, Security, Remote Monitoring, Phone Vision

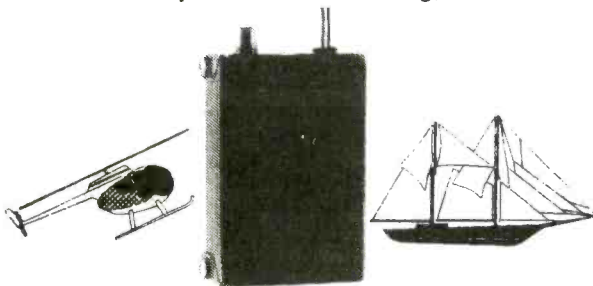

Factory New \$ 299.95

NOW ATV Special

2 or more \$ 279.95 ea.

Add \$5.00 S/H Ca. add 6.75%

## Micro Video Products

1334 So. Shawnee Dr. • Santa Ana, CA 92704

1-800-473-0538 (714) 957-9268

# C.A.T.S.

Rotors, Parts and Repair Service  
Reconditioning Large or Small  
American Made Rotors

Repairs - \$20.00\*

Rebuilds - \$40.00\*

All parts in stock for immediate delivery.  
New units for sale. Trade-ins welcome.



# C.A.T.S.

7368 S.R. 105 Pemberville, OH 43450

Call N8DJB at (419) 352-4465

10:00-5:00

\*LABOR ONLY —

PARTS & SHIPPING ADDITIONAL

# RADIO SCAN MAGAZINE

SPECIAL AMATEUR REPORT

Introductory

S A V I N G

Certificate

Only \$14.95, A Saving of \$21.00 (12 issues).

This Certificate entitles the bearer to subscribe to  
*Radioscan Magazine*, and get up to \$21.00 off the cover  
price. Complete and return with your payment of \$14.95  
by check or Money Order to:

RADIOSCAN MAGAZINE

Our new address is:

8250 N.W. 27th Street, Suite 301

Miami, Florida 33122

(305) 594-7734

Name \_\_\_\_\_ Call \_\_\_\_\_

Address \_\_\_\_\_

City \_\_\_\_\_ State \_\_\_\_\_ Zip \_\_\_\_\_

Please allow 4-6 weeks for first issue. Spanish version available.  
Subscription outside U.S.A., \$50.00 by air mail.

# GO FLY A KITE! THE NEXT GENERATION

by Larry Hillier N8EWV

*Northeastern Ohio ATVers provide a different aerial view via ATV*

*ATV, the most exciting mode of my hobby is going higher and higher these days. It has taken off after working with a fine group of area hams building the KD8PE ATV repeater here in Northeastern Ohio (Youngstown, Salem, Beloit).*

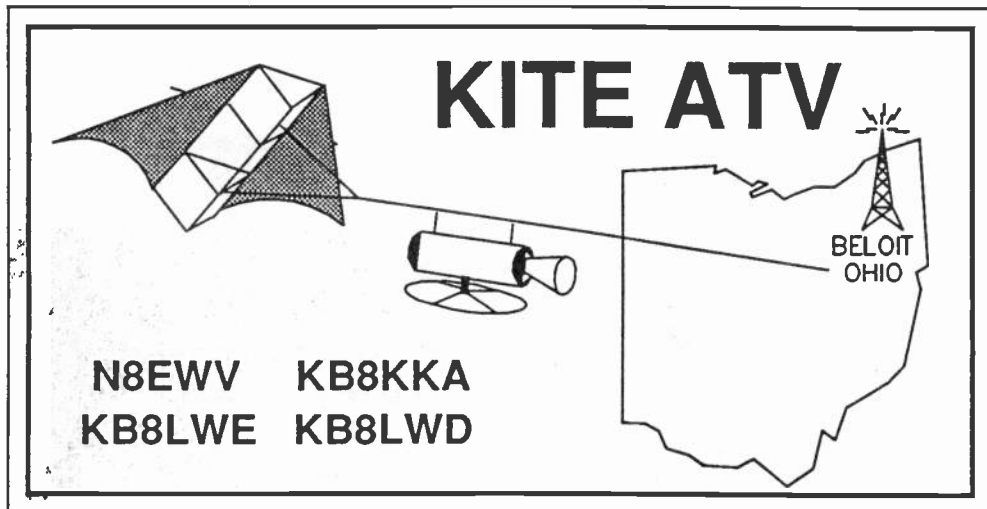

*The ATV Kite Logo and Flight Train*

*The Kite in Flight*

The system works great at 40 miles plus. The in/out frequencies are 439.25 MHz. and 426.25 MHz. Some of the members of our group decided to make things interesting and fly our 1-watt ATV transmitter high in the sky with a camera, timer, identifier and a motor driven mirror to allow us to scan a wide area of the ground below. The kite is a 14 foot Sun Oak compound style box kite with quite a bit of lift. We mounted the 2.5 pound ATV system in a tube which hangs from the kite string about 50 feet below the kite itself. See the Figures for details.

They say the higher your antenna the better. We've done this in a big way with our many ATV kite flights (more than we even care to count!) On one of our first flights we kept getting P5 reports through the repeater as well as direct from area stations. Jim N8DOD had us P5 from Warren, Ohio (30 miles to the north). He told us, "...Just like looking downtown from an airplane!". Hal KE8II had excellent reception via his homebrew collinear in Sebring, Ohio.

With every launch, we (Larry N8EWV, Jeff KB8LWE, Cory KB8LWD and Dick KB8KKA) keep thinking of even better ideas. Changes are quickly made, the package gets more streamlined, longer flights are made, better antennas, etc. John N8GIE and Larry KE8VE, both from Alliance, have helped with building timers and power

sources as well as flying their own kites. Lens changes have made the resolution even better and the good reports keep coming in. In a stiff wind, it gets pretty difficult to bring the kite back to solid ground. It would take a couple of us just to reel the thing in. Dick KB8KKA made a great contribution when he built a power kite retriever that brings it all down in under 10 minutes with no work at all!

We've been giving demos for clubs and plan to do the same for area hamfests. We have had an occasional failure, like the time our line broke at 500 feet altitude during a demo for the Salem Radio Club's benefit breakfast. Although the attendees were somewhat disappointed, all of the talk about the kite recruited 3 new ATVers.

Recently Dick KB8KKA added a large American Flag to the kite line about 200 feet below the kite itself. People were honking their horns as they drove by to show their support of the troops in the Gulf. It looked awesome high in the sky! Area hams have been telling their friends to tune their TV sets to cable channel 58 or 60 to watch the kite video. Even the local barber shop has it tuned in!

*NOTE: Readers who would like to duplicate this project can obtain the kite needed from the author. The address is: 18334 RT 62, Beloit, OH 44609. The author recently became a dealer for the kites.*

# GO FLY A KITE! THE NEXT GENERATION

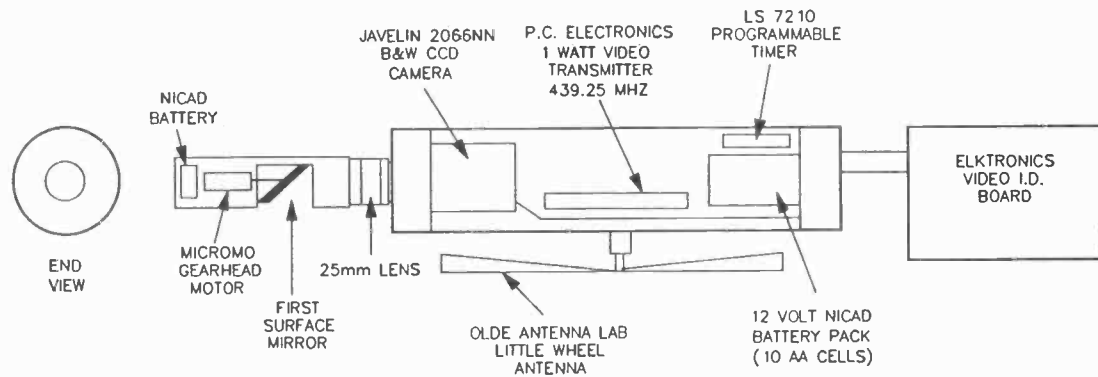

ATV KITE TRANSMITTER PACKAGE

*Figure 2. Diagram of the ATV kite payload showing the motorized mirror mount.*



*Jeff KB8LWE and Larry N8EWV prepare the kite and payload ready for takeoff.*



*Close-up of the kite ATV payload mounted in the plastic cylinder. An Olde Antenna Labs mini-wheel is mounted below the tube.*

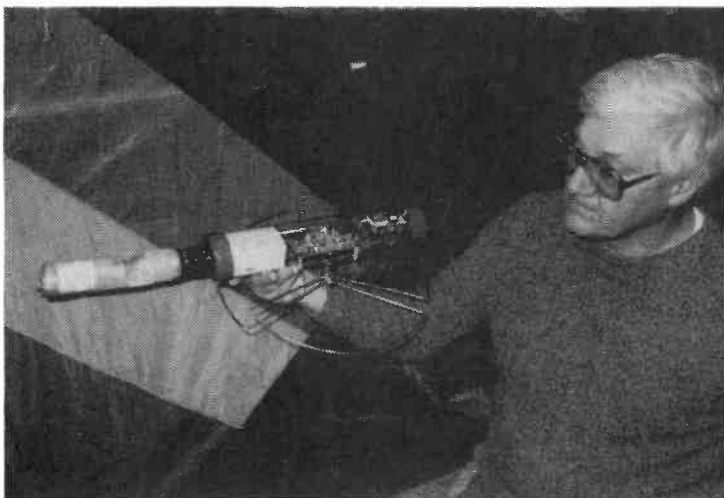

*Larry N8EWV holding the package. Note the motorized mirror mount attached in front of the camera lens.*



*Dick KB8KKA mans the power kite retriever.*

# si JAYBEAM

## SPECTRUM INTERNATIONAL, INC.

Post Office Box 1084-T  
Concord, Massachusetts-01742  
508-263-2145

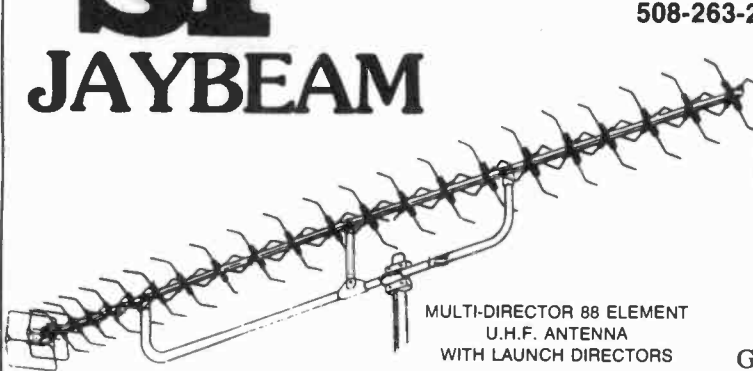

MULTI-DIRECTOR 88 ELEMENT  
U.H.F. ANTENNA  
WITH LAUNCH DIRECTORS

### MBM88/70cm

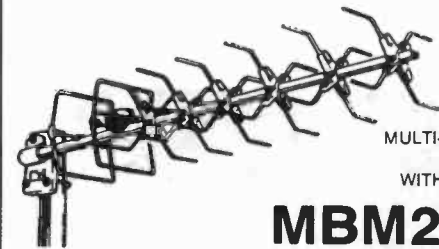

MULTI-DIRECTOR 28 ELEMENT  
U.H.F. ANTENNA  
WITH LAUNCH DIRECTORS

### MBM28/70cm

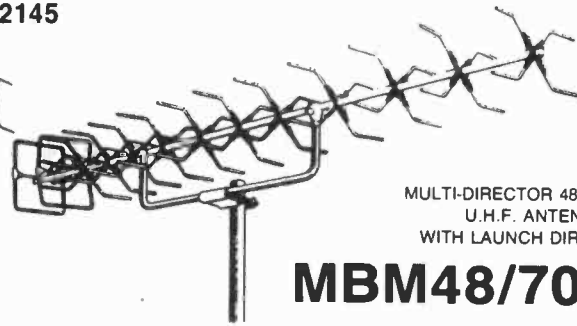

MULTI-DIRECTOR 48 ELEMENT  
U.H.F. ANTENNA  
WITH LAUNCH DIRECTORS

### MBM48/70cm

General Specs:-  
Frequency Range  
Impedance  
(Built-in Balun)

420 MHz - 450 MHz  
50 Ohms

	MBM28	MBM48	MBM88
Gain	11.5dBd	14.0dBd	18.5dBd
Beamwidth (E)	40 deg	28 deg	23 deg
(H)	45 deg	35 deg	28 deg
Boom Length	4 ft	6 ft	13 ft
	\$ 60.00	\$ 110.00	\$ 150.00

#### VHF/UHF BANDPASS FILTERS



KNOCK OUT INTERFERING  
QRM OR SELF-DESENSE!

The PSf . . . series of Band Filters are for receiver pre-selector and transmitter use. The filters are 3 pole, 7% bandwidth, 0.1 dB ripple designs with 30 dB shape factor of 4:1.

The PSf . . . ATV series of TV Channel Filters are 5 pole, 6 MHz bandwidth designs. They are used to protect your TV receiver from inband QRM and to "strip-off" the unwanted sideband of your transmitted vestigial sideband signal.

BNC Standard  
TNC or Type 'N' optional  
(slightly higher prices)

Model	PSf144	PSf220	PSf432	PSf900	PSf1296	PSf1691
Freq (MHz)	140-150	216-228	420-450	890-940	1250-1340	1650-1750
Loss (typ)	0.1 dB	0.1 dB	0.15 dB	0.2 dB	0.25 dB	0.25 dB
	\$190.00	\$160.00	\$105.00	\$105.00	\$105.00	\$105.00

Model	PSf421-ATV	PSf426-ATV	PSf439-ATV	PSf910-ATV	PSf1253-ATV
Loss (typ)	2.0 dB	2.0 dB	2.0 dB	2.5 dB	3.0 dB
Std conns.	BNC	BNC	BNC	N	N
	\$155.00	\$155.00	\$155.00	\$180.00	\$180.00

All prices FOB Concord, Mass.

PRICES SUBJECT TO CHANGE WITHOUT PRIOR NOTICE

## SPECTRUM INTERNATIONAL, INC.

Post Office Box 1084-T  
Concord, Massachusetts-01742  
508-263-2145



DAYTON BOOTHS 66, 67

# 75 WATT AB-1 POWER MODULE FOR 70 CM.

by JOHN P. SPAETH KD0LO

*Here is another answer to your prayers for a class AB1 power amplifier for ATV. The folks from RF Parts have imported yet another Mitsubishi hybrid power amplifier, the M67728, capable of 50 watts average power output with excellent linearity. This module exhibits most of the forgiving characteristics of the other linear modules in that it has a 50 ohm input and output, uses 12-14 Vdc B+, uses 0-10 Vdc Bias, and has 10 dB min. gain over the entire 70 cm amateur band.*

The module reaches its 1 dB compression point at 58 watts, sync compression was tolerable to the 50 watt output level. The module I tested performed better than specification with 10 dB gain up to a power input level of 5 watts, 12.5 Vdc Vcc, 8 Vdc Vbb. The idling current draw is 500 mA, and at the 50 watt avg. output level the unit draws 9.5 amps with the voltage listed above. 3rd order IMD is -25 dB, 5th order IMD is -31 dB. IRE tilt was negligible to the modules 1 dB compression point, and high frequency response was excellent. There were no major phase distortions or shifts noted with a color signal.

As illustrated in fig 1. the module has 5 connections to the circuit board as follows: 1-RF In, 2-1st stage B+ (VCC), 3-Bias Voltage (VBB), 4-2nd stage B+ (VCC), 5-RF Out.

An 8 volt regulator was added to the circuit board for bias voltage regulation. This voltage must be regulated, as does the B+ supply. All power leads must be bypassed heavily for video with the values listed below. The RF module is internally bypassed for RF, but a general precaution should be taken by using a feed-through capacitor at the chassis, particularly for repeater operation.

Fig 1 is a circuit board print, the board should be etched on FR-4 (G-10) board, double sided, with all components surface mounted. The top and bottom sides of the board should be tied together with plate through holes either with eyelets or small pieces of wire soldered on both sides. If you elect to use axial lead capacitors

rather than chip capacitors, the ground side of the capacitor can be brought through to the bottom of the board and soldered on both sides.

The parts for the hybrid power module are as follows: c1, c2, c3 = .1 mFd; c4, c5, c6 = 10 mFd tantalum; c8 = 22 mFd; c7 = 1000 mFd; VR-1 = 8 volt 3 terminal regulator.

One final word about heat sinking. It is extremely important to find a heat sink with adequate dissipation. This power module must be mounted on a flat surface with silicone conductive grease. The heat sink I use for 100% duty cycle measures 14" L, 8" W, 2" H. This heat sink will not dissipate the heat satisfactorily so I force air through the fins with a small muffin fan. Also be very careful with drive levels! The module is rated for a maximum input power of 14 watts however, ATV's should never have occasion to use more than 5 watts of rf drive to the unit. The module is extremely intolerant of over-voltage, so do your dc measuring with a voltmeter not your power module!

This power module is available from RF Parts for \$119.00. Although this may seem a bit "pricey" at first, when one considers that a Mirage D-1010 is in the \$300.00 range with no more average power output available, and the M67728 is class AB-1 and infinitely more linear the price becomes more palatable.

This module driven by the lower power Mitsubishi module make for a full compliment class AB-1 power amplifier system, approaching commercial TV broadcast standards. 73's John

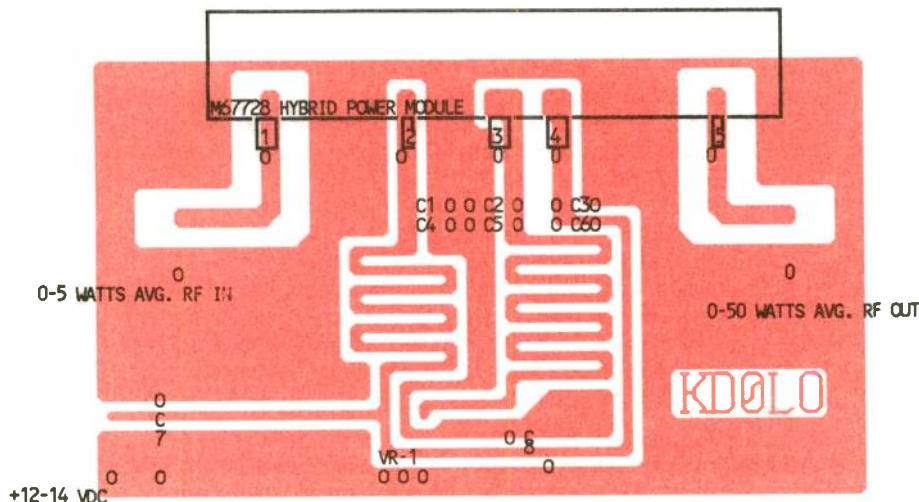

*A brick is a brick! Here is a 1:1 board layout and overlay for parts placement. If you have worked with any of the Motorola or other amplifier modules, such as a MHW-710 this should look the same when done except that this unit puts out a healthy 50 watts of linear video modulated RF!*

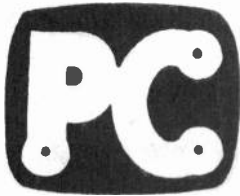

ELECTRONICS

P.C. ELECTRONICS 2522 PAXSON LANE ARCADIA CA 91007-8537 USA

TOM (W6ORG) & MARYANN (WB6YSS) O'HARA

(818) 447-4565

24 hr FAX order line (818) 447-0489



## THE "KREEPIE PEEPIE" ATV TRANSMITTER

THIS IS THE ATV TRANSMITTER BOARD YOU HAVE READ ABOUT THAT HAS SURVIVED MANY BALLOON FLIGHTS TO OVER 100,000 FEET AND BACK. ALSO USED FOR R/C MODELS WHERE AN ALL IN ONE BOARD WITH SOUND IS DESIRED OR DEDICATED LINKS AND REPEATERS. JUST THE THING FOR THE BUILDER WHO WANTS TO PACKAGE AND MAKE HIS OWN PORTABLE 70 CM ATV TRANSMITTER OR HOME TRANSCEIVER WITH A WIRED AND TESTED BOARD.

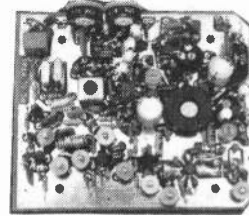
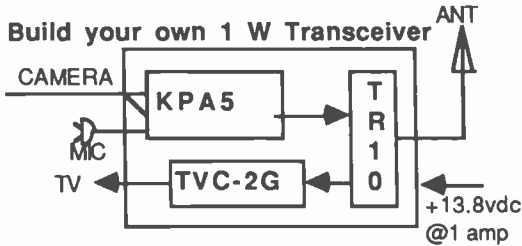

KPA5-E board only \$169



### KPA5-E 70CM ATV XMTR BOARD FEATURES:

- 1.5 Watts P.E.P. typical RF output. Run barefoot for portable, but if needed for greater DX, the output properly matches the Mirage D15N 15 watt, D26N-ATV 50 Watt linear amp for full output or D100TVN to over 70 Watts with an adjustable sync stretcher.
- FULL COLOR AND SOUND on a small 3.25x4" board
- Wired and tested board runs on external 13.8 Vdc @ 300 mA. supply or 12 V battery. Weighs only 3 oz.
- Accepts composite video from cameras, camcorders, VCRs, computers, etc. 2 audio inputs, one for low Z dynamic mic, & one line level from most cameras & VCRs. Transmit monitor output enables seeing your own true RF detected video.

### KPA5 APPLICATION:

**PORTABLE CORDLESS TV CAMERA.** Think of it as a video HT. Place the KPA5 in one of the Hammond Dicast aluminum boxes, AEA HR-4 half wave "hot rod" on top or at the end of 50Ω coax attached to a headset. Plug into a 12-14 v source such as a 12 Vdc battery pack. Depending on terrain & receiving antenna DX is typically over 1 mile. With KLM 440-16Xs at both ends DX is 22 miles snow-free line-of-sight. Price only \$169 supplied with one xtal on 426.25, 434.0, 427.25 or 439.25. 2nd xtal add \$15. Specify frequency(s) when ordering, check with local ATVers, ARRL Repeater Directory or call us. Sold only to licensed radio amateurs.

### ACCESSORIES:

- Hammond 1590D 7.3x4.7x2" roomy alum. box.....\$18
- 1590C 4.6x3.6x2" aluminum box, smaller tighter fit.....\$12
- 800J 10 pin VHS color camera chassis connector.....\$10
- 100 Ohm panel pot for video gain control.....\$5
- TVC-4G 420-450 MHz to CH3 receiving downconv.....\$89
- TR-10 RF T/R relay module, mounts on chassis N conn.....\$29
- MIRAGE D15N-ATV 1.5 in /15 out all mode amp.....\$159
- MIRAGE D26N-ATV 1.5 in / 50 out all mode amp....\$219
- MIRAGE D100TVN 1.5 in/50 out all mode amp.....\$319

- AEA HR-4 "Hot Rod" half-wave portable antenna.....\$23
- 450 ISOPOLE omni 4 dBd vert. gain antenna.....\$89
- KLM 440-6X 8.9 dBd ant., 28" boom, >50 deg. BW.....\$57
- KLM 440-10X 11.2 dBd, antenna, 64" boom.....\$68
- KLM 440-16X 14 dBd antenna, 10.5 ft boom.....\$119
- UG21 type N male connector for Belden 9913 coax.....\$5
- UG58 N female flange type chassis connector.....\$2
- VOR-2 Video (horiz sync) operated relay board.....\$45

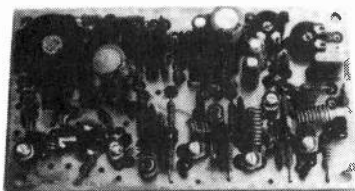

### NEW SMALL TXA5-RC 1 WATT ATV TRANSMITTER.....\$129

Designed primarily for Radio Control models, rockets, balloons, etc. with it's small 2.25 x 4 inch size and 2 oz. weight. Adjustable power output from 1.5 p.e.p. to 100 mW. Draws 250 MA @ 13.8 Vdc. Has adjustable sync stretcher and provisions for sound from the FMA5-E board (pg 2) in case your application needs higher power sometimes or subcarrier sound. Comes wired and tested ready for you to mount in a shielded enclosure, connect up coax from antenna and camera and wires to power source. Plan on shielding your R/C receiver and adding the simple antenna low pass filter outlined in the application note supplied. Receive with one of our 70 cm downconverters listed on page 3 and a TV set Specify frequency, 426.25 MHz suggested for R/C, other standard ATV frequencies available. Sold only to verified licensed radio amateurs in the Callbook or send copy of new license.

### UNIDEN VM110 CCD BLACK & WHITE CAMERA.....\$125

Low cost per crash camera just right for R/C applications or second camera for call letter ID or DX. Size 4.7x3.9x2.2" and weighs less than 7 ounces. Requires 11 to 14 Vdc at 200 MA. Lens included. 19440 pixel, 120 line resolution with standard composite video output.







P.C. ELECTRONICS 2522 PAXSON LANE ARCADIA CA 91007-8537 USA  
 TOM (W6ORG) & MARYANN (WB6YSS) O'HARA (818)447-4565

24 hr FAX order line (818) 447-0489



ELECTRONICS

## NEW TX70-1A AND RTX-70 TRANSMITTER

The family of full feature ATV transmitters for home, link or repeater use is now complete. We have models for all 3 of the popular ATV bands - 23, 33 and now 70 CM.



TX Series

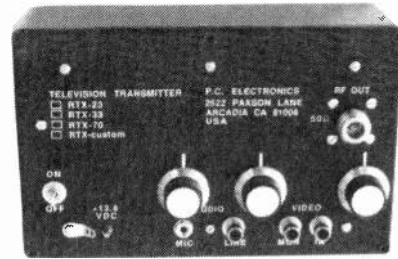

RTX Series

### Features found on all 3 transmitters:

- >1 Watt pep with adjustable sync stretcher to properly match amateur linear amps. Sets the blanking pedestal for proper video to sync ratio to compensate for the linear amps high power gain compression curve.
- RF detector right on antenna output to see what is really going out on the air and that your video gain, focus, etc. throughout the whole transmitter is set up correctly. Detected composite video monitor outputs to a RCA jack in transmit, and loops thru in receive to enable camera set up before flipping the transmit switch.
- Independent gain control of mic and line audio to enable external mic mixing with VCR or camera mic audio. New temperature compensated 4.5 MHz sound subcarrier generator with line audio pre-emphasis and soft limiting between the broadcast standard 25 kHz average & 40 kHz peak deviation.

**CHOOSE THE TX SERIES FOR HOME AND PORTABLE USE.** Has built-in RF T/R relay switching for easy connection through a BNC cable to the companion TVC downconverter. Rear panel video & audio jacks for VCR or Camcorder, or use front panel VHS camera jack. Mic & push to look jacks in front. Shielded cabinet 7x7x2.5", 1.6 lbs.

- NEW TX70-1A** has 2 frequency capability in the 425-440 range, 1.5 W pep on sync tip typical output.....\$279  
 one crystal included - we stock most used 439.25, 434.0 & 426.25, plus 427.25 & 425.25. 2nd crystal add \$15.
- TX33-1** single frequency - specify 910.25 the most common simplex, 911.25 or 923.25 MHz .....\$329
- TX23-1** single frequency - specify 1289.25 the most common simplex, 1277.25, 1265 or 1253.25 MHz.....\$329

**CHOOSE THE RTX SERIES FOR DEDICATED REPEATER AND LINK USE.** Uses same transmitter in a completely shielded Hammond 1590D diecast aluminum box but without T/R switching.

- NEW RTX-70** specify repeater or link output frequency, 421.25 MHz most popular for inband output.....\$299
- RTX-33** specify frequency - 923.25 MHz is the most used crossband repeater or link frequency.....\$329
- RTX-23** specify frequency - 1253.25 MHz best first repeater output crossband freq., then 1277.25 MHz.....\$329

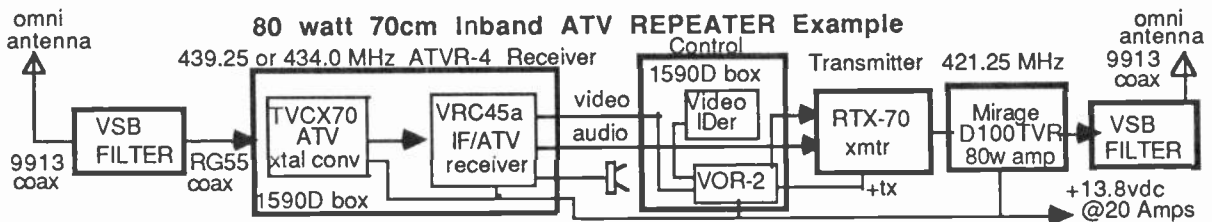

Select an ATVR Receiver (catalog pg 4) & a RTX Transmitter for the bands you want, add the appropriate linear amp, VSB filters & antennas, ID & VOR-2, power supply and coax for your own repeater. We suggest low in / high out for crossband. VOR-2 Video Operated Relay board...\$45, keys RTX upon detection of horizontal sync. 10 min. & end of transmission momentary relay for switching to video ID to meet FCC regs. Contact Bill Brown, WB8ELK at (419) 4228206 for the VDG-1 video IDer directly. 33 & 23 CM Amps - Downeast Microwave Bill (207)9483741, Omni gain Vertical Ant - NCG Co. Bruce (714) 6304541, VSB Filters - TX/RX Systems Jon (716) 5494700.

**CALL TO DISCUSS YOUR APPLICATION & TO GET A COMPLETE CATALOG NOW!**

# SUPER SIGNAL SNIFFER

Louis Hutton K7YZZ

*As I mentioned in my article on the Low Level Crystal Controlled Signal Source, I used a gadget that I had built called a Super Signal Sniffer to detect the presence of an RF signal. I am not the designer of this circuit and a search of my library did not turn up just where I found the diagram, but I am passing along the information on the unit I built as it is a very nice piece of test equipment to have in the shack.*

I am sure the reader is aware of the old sniffer consisting of a diode, a pickup coil and a microamp meter. This circuit may be found in most handbooks on test equipment. The Super Signal Sniffer is much more sensitive as it includes a DC amplifier. The weak RF signal is picked up by a small loop held near the radiating source and is rectified into a DC voltage and fed to the amplifier. The output of the amplifier is connected to a "S Meter". A control pot is used to adjust the gain of the amplifier. Yes, that is correct, I goofed and did not install a battery test circuit. The "Mark II" model just may have that feature!

The circuit is built on a small piece of Perf-Board mounted on metal stand offs. The 9 volt battery is mounted underneath that circuit board and is held in place by a metal clip. The black plastic box is 2 5/8" wide by 5

1/16" long by 1 5/8" deep (RS 270-233). Here again the meter used was one found in a surplus catalog. Lettering was done with black rub on letters (RS 270-201).

Using the little gadget is very easy. The Sniffer power is turned on and the gain control advanced to full on for maximum sensitivity. The loop is then held near the RF source under question and if all is radiating as expected, you will get a reading on the meter. If the RF is so strong that it pins the meter, then move the little loop away further from the RF source. This also helps in not overloading or detuning the coil doing the radiating. I have set the Sniffer up so that it was picking up RF from a coil under consideration and was then able to carefully resonate the said coil via slug adjustment watching the Sniffer meter for maximum output. IT WORKS!

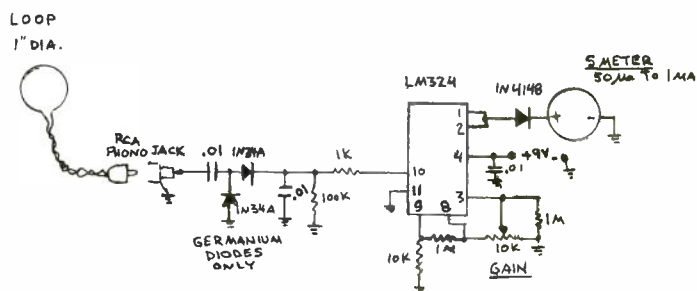
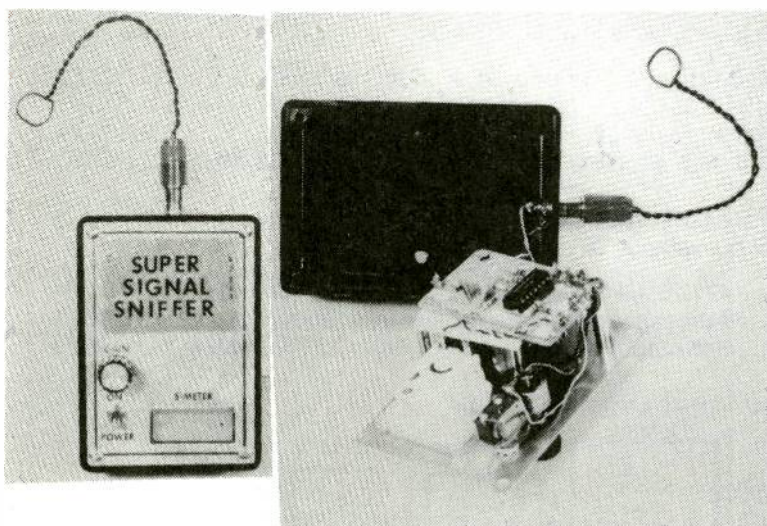

SUPER SIGNAL SNIFFER  
K7YZZ 1-10-88

**FOR SALE:** Video image enhancer, noise reducer, InterVideo model VP-5050. 3 inputs front panel selected, modes: off, color, mono, bypass, controls, detail, sharpness, noise core. Built in DA, 4 outputs. Also selects 1 channel audio (mono) or use for video only. RCA phono

connectors. \$75. Also, W0LMD design SSTV keyboard. Nicely built with all updates and options. Nice titles for SSTV or to make QSO tapes without tying up your 1200!. \$75. Both units available at the ATVQ booth, Dayton unless sold earlier.

# 1691 MHz Weather Satellite System

Spectrum International, Inc. is pleased to announce their appointment as North American and International distributor of **Time-Step Electronic's Weather Satellite Receiving System.**

This high quality, low cost system consists of:

- |   |       |
|---|-------|
| 1691 MHz GaAs FET Pre-ampl. model TS-1691-P.Amp | \$175 |
| 1691 MHz Receiver model TS-1691-Recvr           | \$450 |
| Decoder Board & Software model TS-VGA-SAT3      | \$300 |

Also available to complete the system are:

- |   |       |
|---|-------|
| Low Loss (microwave) Coaxial Cable (65 ft) with connectors. model 1691-coax ass'y | \$ 45 |
| 1691 MHz Loop-Yagi Antenna model 1691-LY(N)                                       | \$ 97 |
| 1691 MHz Loop-Yagi Extension model 1691-LY-XTN                                    | \$ 80 |

**WX-SAT System** (all the above items) **\$1100**

Demonstration Disc (IBM-PC VGA compatible) of signals recorded from WX-SAT system. \$ 5

Shipping: FOB Concord, Mass. Prices subject to change without notice.



**si** SPECTRUM INTERNATIONAL, INC.  
Post Office Box 1084-T  
Concord, Mass. 01742, U.S.A.  
Phone: (508) 263-2145

# INLINE™ Coaxial Antenna Relay Switching System

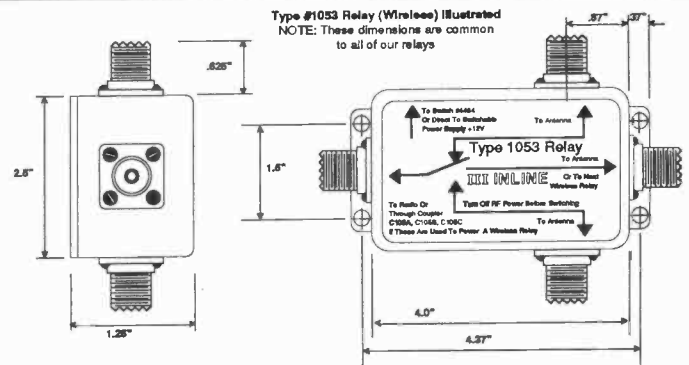

- Rugged Construction
- Waterproof
- High Reliability
- No Insertion Noise
- Uses a Single Coax
- Economical

INLINE™ coaxial relays are rugged, weatherproof devices that can be mounted on virtually any surface, indoors or out, wherever the relay is used to switch between two or more antennas while using only a single coaxial cable to the transceiver. Our relays are available in one of two styles WIRED or WIRELESS.

The WIRELESS style uses a separate coupler module installed near the radio. The coupler combines the RF signal and the relay energizing voltage to allow the coaxial cable to carry both signals simultaneously yet independently. This permits existing systems to be expanded with little modification. These relays and couplers have narrower bandwidths than the wired models, since their internal circuits contain filters which minimize harmonics beyond the relays' passband.

INLINE™ relays and couplers are capable of high power operation yet contribute no insertion noise in the receiving or transmitting modes. The INLINE™ design uses technology incorporating microstrip techniques resulting in a relay life expectancy of at least 10,000,000 transfer operations, offering many years of trouble free service in the field.

INLINE™ couplers can also be used to utilize D.C. voltage remotely via the coaxial cable to power other devices such as amplifiers and other equipment. Isolated D.C. energized relays are also a modification which is available and permits three-way switching in mobile applications from a common power source.

DESCRIPTION	TYPE 105	TYPE 105U	TYPE 105N	TYPE 105S
Switch Type	Two Position	Two Position	Two Position	Three Position
Frequency to...	180MHz	300MHz	950MHz	180MHz
Impedance	50Ω	50Ω	50Ω	50Ω
Energizing Coil	190Ω±10%	190Ω±10%	190Ω±10%	190Ω±10%
Energizing DC	±10V to ±16V	-12V to 0V to +12V	-12V to 0V to +12V	-12V to 0V to +12V
Insertion Loss Max. (dB)	0.2 to 30MHz 1.0 to 180MHz	0.2 to 250MHz	0.4 to 500MHz 1.8 to 950MHz	0.2 to 30MHz 1.0 to 180MHz
VSWR (or "SWR")	1:1	1:1	1:1.2 to 500MHz 1:1.30 to 950MHz	1:1.1 to 30MHz 1:1.1 to 180MHz
Insertion Noise	NONE	NONE	NONE	NONE
RF Power W.CW	1250W to 30MHz 150W to 180MHz	750W to 100MHz 800W to 250MHz	300W to 500MHz 185W to 950MHz	1250W to 30MHz 150W to 180MHz
RF Power W.-SSB	2500W to 30MHz 300W to 180MHz	1400W to 100MHz 1200W to 250MHz	700W to 500MHz 250W to 950MHz	2500W to 30MHz 300W to 180MHz
RF Power W.-AM/RTTY	750W to 30MHz 150W to 180MHz	400W to 100MHz 400W to 250MHz	200W to 500MHz 100W to 950MHz	750W to 30MHz 150W to 180MHz
Crosstalk (dB)	-45 to 30MHz -30 to 180MHz	-45 to 100MHz -40 to 250MHz	-35 to 500MHz -30 to 950MHz	-45 to 30MHz -30 to 180MHz
Switching Time (Sec.)	0.01	0.006	0.005	0.01
Standard Connectors	SO239	SO239	Type N	SO239
Suggested Couplers	C105A (fixed) C105B (variable)	C105U (fixed) C105JU (variable)	C105N (fixed) C105JN (variable)	C105S (variable)

**Unadilla**

87 Belmont Street North Andover MA 01845  
PH# (508) 975-2711 FAX (508) 474-8949

# 913 MHz. LOW LEVEL CRYSTAL CONTROLLED SIGNAL SOURCE

Louis Hutton K7YZZ

*This little piece of test equipment was built to meet a need for a very low level source of a 913 MHz. RF carrier. It is used during the testing of low noise Pre-Amplifiers and Down Converters for the 923 MHz. ATV band. Several years ago I built a VHF-UHF SIGNAL SOURCE that gave me a very low level signal on 432 and 1297 MHz. My article describing that unit was published in the VHF-ER Magazine of November 1965. This little battery operated unit is still in the test equipment cabinet in the K7YZZ ham shack. Using that design as a background, I built a unit similar to it for use in the 923 MHz. ATV band.*

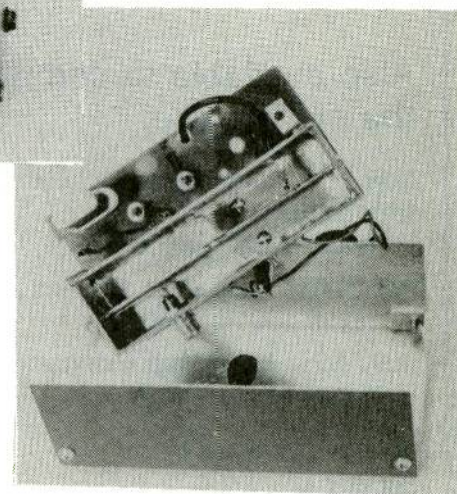
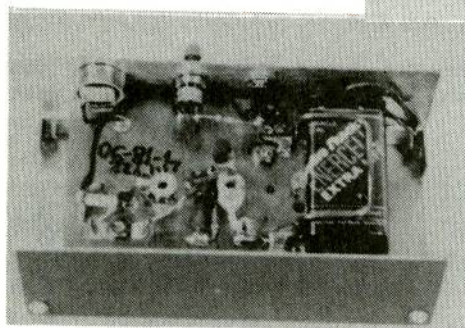

The RF Signal Generator consists of a crystal oscillator driving a tripler whose output is fed through a germanium diode connected to a halfwave cavity tuned to 913 MHz. RF output is obtained by a small link coupling to the tuned center conductor of the cavity. The diode generates strong harmonics of the RF coming from the tripler output and the resonant tuned cavity selects the desired frequency.

The resonant frequency of the slug tuned coils was determined by using a grid dipper test set. Sensing the RF output from each stage was done by detecting the presence of a signal with a SIGNAL SNIFFER.

This unit is described in an article in this issue. The SIGNAL SNIFFER was also used to sense the RF coming out of the cavity on 913 MHz. Although I was hoping to get the unit to come out right on 923 MHz., the only

crystal in my "Junk Box" that I could find was on 76.16 MHz., which came close enough (913 MHz.) to the desired frequency of 923 MHz.

The battery test circuit was added to this unit as a result of finding dead batteries several times in the test set, and wondering why it did not work when I turned it on after having been on the shelf for several weeks. The little voltage test meter was located in one of the many parts catalogs that I receive in the mail.

The home made cabinet was painted two different shades of grey and decal'd with rub on lettering. The 1 K resistor value in the battery test circuit was hand selected to provide near full scale meter deflection from a new 9 volt battery. Other meters may require a different value to obtain the proper reading.

*continued....*

# THE LIONEL RAILSCOPE

by Bill WB8ELK

*World's narrowest (and possibly the most inexpensive) TV camera is now available to the masses for under \$70! For some time now I've been trying to obtain the TV camera from the Lionel Railscope train engine. Until recently, you had to purchase the whole model train engine.*

While leafing through the January issue of Popular Science, I noticed a rather interesting ad entitled "Video Breakthrough for sale - \$69.95 + \$5 handling". Naturally any camera under \$100 gets my attention. After further investigation, it turns out to be the Railscope camera/transmitter and receiver modules. After a couple of weeks I finally had one in my hands!

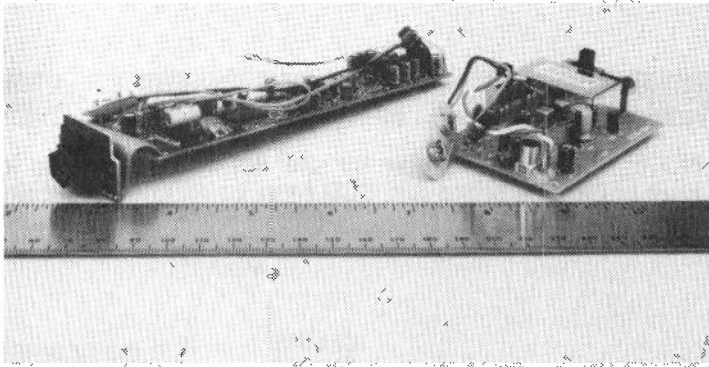

The Railscope camera/transmitter board sends out a 4 MHz FM TV signal which is coupled through wires into the train tracks. A companion receiver board hooks up to the tracks and allows you to receive the signal on your TV set (channel 3 or 4). The resolution is not fantastic (162 H by 120 V). However, I think it's a better image than that produced by the Uniden camera. In addition, the electronic auto-iris circuit really works quite well on the traincam. Once you move the camera around a bit, your eyes tend to average out the "jaggies" and it really doesn't look bad at all. You do need a fair amount of light since it takes about 40 LUX for best results. The field of view is 22 degrees and the lens focuses from 4 inches to infinity.

There are two disadvantages with the Railscope camera: The current drain is about 350 milliamps at 6 to 9 volts; also you need to locate and tap the video signal off of the board. Really not too bad of a compromise considering the price! I did some sleuthing around the board for video, and finally found a source of 0.5 volt p-p video off of pins 21 or 22 on the 48 pin LA7307 surface mount device. You may need to amplify this up to 1 volt p-p depending on how you set up your ATV transmitter. The best point to tap the video is off of capacitor C53 on the bottom side of the board as shown in the figure.

The Railscope's unusual configuration seems custom made for other amateur TV applications however. Since the camera is only 1.25 inches wide, it'll fit in some of the hobby store variety of model rockets! Also, you could put it in some very small R/C aircraft. No longer do you need a humongous missile or quarter scale model to launch your TV system. We should have a companion micro-ATV transmitter that'll fit in an ESTES model rocket in our next issue. Also the CCD camera sensor hooks up to the camera board via a ribbon cable. This feature makes it easy to point the camera in just about any direction possible. This camera ought to have some possibilities for "LookieTalkie" packages as well. We should have more modifications and information on the train cam in our next issue. Have fun experimenting with this incredible micro camera! The Railscope camera/receiver modules are available for \$69.95 + \$5.00 shipping/handling from (800) 727-7297.

## 913 MHz. Signal Source continued....

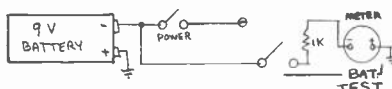
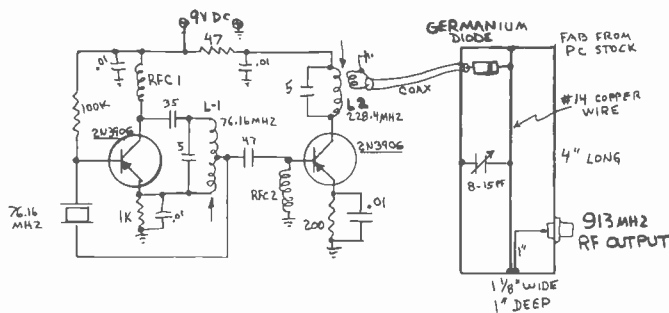

RFC 1 = 5.6  $\mu$ h    RFC 2 = 1.5  $\mu$ h  
L1 = 8T #20 ENAMELED  $\cdot \frac{1}{8}$ " D, SLUG TUNED  
TAPPED 4 TURNS FROM EMITTER END  
L2 = 2T #20 ENAMELED  $\cdot \frac{1}{8}$ " D, SLUG TUNED  
2 TURN LINK OVER COLD END

CRYSTAL CONTROLLED  
913 MHz SIGNAL SOURCE  
K7YZZ

# THE LIONEL RAILSCOPE

## Miniature Video Camera Circuit Board, With TV Modulator Receiver Board

### CAMERA CIRCUIT BOARD

Picture .....	Black & White (CCD)
Output to RX Via Cable .....	4MHZ, FM
Band Width .....	2 MHZ
Resolution .....	162 x 120 Pixels
Viewing Angle .....	30 Degrees Horizontal x 22.5 Degrees Vertical
Focus .....	4 Inches to Infinity
Required Light .....	40 LUX thru Sunlight
Irising .....	Electronic
Power .....	7.0 Vdc - 9.0 Vdc @ 350 mA
Power Connector .....	Radio Battery Clip
Size .....	Approx. 1"Hx1.25"Wx7"L

### RECEIVER CIRCUIT BOARD

Output Frequency .....	TV Channel 3 or 4 Switch Selectable
Distance Thru Cable .....	Approx. 500' Maximum
Distance Thru Air .....	Will Not Operate Thru Air
Output Connection .....	RCA Approx. 75Ω (With 300Ω Matching Transformer)
Power .....	7.0 Vdc - 9.0 Vdc @ 150mA
Power Connector .....	Radio Battery Clip
Size .....	Approx. 1"Hx2.5"Wx3.5"L

**CAUTION: Static Sensitive Device**

### CONNECTION AND OPERATION

Connection from the camera to the receiver is made by connecting the thin copper wires from the camera board to the white and green wires on the receiver board. Caution should be used to avoid shorting the copper wires together. This connection can be made longer by using extra wire. The signal is not polarity sensitive, although the picture quality may be better one way than the other. The power switch for the camera is in the wires to the battery clip. The power switch for the receiver is the switch on the board closest to the 9 volt battery clip wires. The output connector on the receiver circuit board is an RCA type, and a cable goes from that connector to the television. The channel selector switch on the receiver board is located adjacent to the RCA output jack. With the switch toward the jack it outputs on channel 3.

NOTE: Underside view of the camera board is shown for clarity. Camera board and CCD must be mounted right side up.

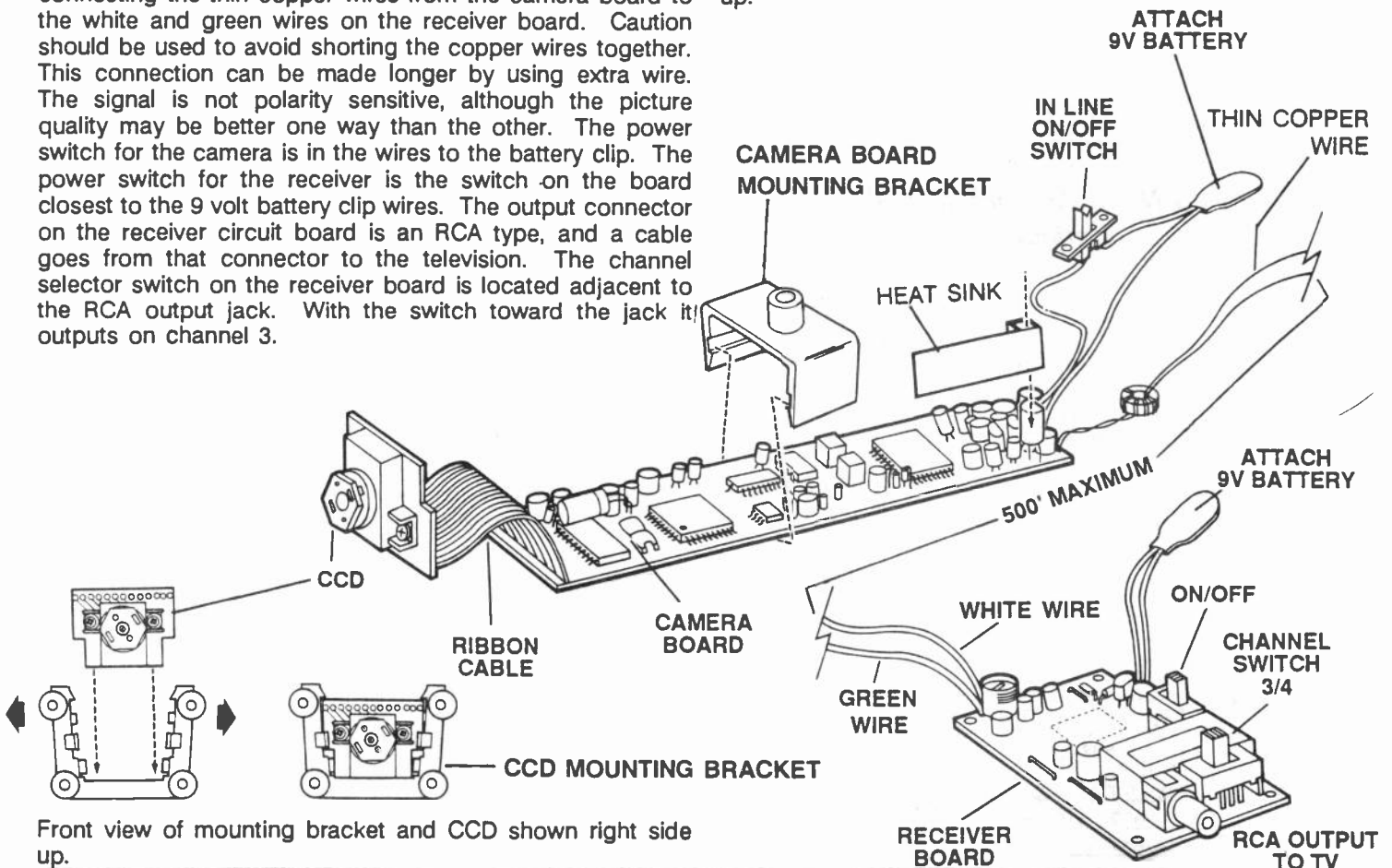

Front view of mounting bracket and CCD shown right side up.

**CAUTION: Static Sensitive Device**

## DOWN EAST MICROWAVE

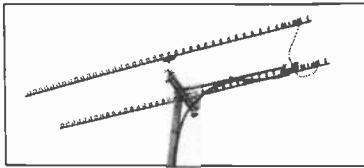

### MICROWAVE ANTENNAS AND EQUIPMENT

- Loop Yagis • Power Dividers • Complete Arrays • GaAs FET Preamps
- TROPO • EME • Weak Signal • OSCAR • Microwave Transverters

902 1269 1296 1691 2304 3456 MHz  
 2345 LYK45el 1296 MHz 20 dBi \$89  
 1345 LYK45el 2304 MHz 20dBi \$75  
 3333 LYK33el 902 MHz 18.5dBi \$89  
 Above antennas kits available assembled.  
 Add \$8 UPS a/h  
 Add \$11 UPS a/h West of the Mississippi.

### MICROWAVE LINEAR AMPLIFIERS SSB, ATV, REPEATER, OSCAR

2316 PA 1w in 18w out 1240-1300 MHz \$265  
 2335 PA 10 in 35w out 1240-1300 MHz \$315  
 3318 PA 1w in 20w out 900-930 MHz \$265  
 3335 PA 10 in 40w out 900-930 MHz \$320  
 23LNA preamp 0.7dB N.F. 1296 MHz \$ 90  
 33LNA preamp 0.9dB N.F. 902 MHz \$ 90

### NEW PRODUCT ANNOUNCEMENTS

**New Loop Yagis**  
 1845 LY Loop Yagi 1691 MHz 20dBi \$99  
 945 LY Loop Yagi 3456 MHz 20dBi \$89  
 Above antennas assembled and tested

### New Preamps

13LNA 0.7dB N.F. 12 dB 2.3 GHz \$140  
 18LNA20 0.8dB N.F. 20 dB 1.69 GHz \$140  
 SLNA 1.0dB N.F. 10 dB 2-2.7 GHz \$150

### New Wideband Power Amplifiers

2370 PA 3w in 70w out 1240-1300 MHz \$695  
 2340 PA 2w in 35w out 1240-1300 MHz \$355  
 2318 PAM 1w in 18w out 1240-1300 MHz \$205

Rack mount Amplifiers for repeater use available.

### NO TUNE MICROWAVE LINEAR TRANSVERTERS

From SHF SYSTEMS a new line of transverters designed by Rick Campbell KK7B and Jim Davey WA8NLC

Available in kit form or assembled/tested

- 903 1269 1296 2304 3456 MHz
- microstrip filters eliminate tune-up
- 2m Hi, PIN diode switched
- sequencer standard in complete unit
- low profile packaging, mast mountable

All active equipment - 13.8V

DOWN EAST MICROWAVE  
 BILL OLSON, W3HQT  
 Box 2310, RR-1 Troy, ME 04987  
 (207) 948-3741

**pauldon**  
 ASSOCIATES

210 Utica Street  
 Tonawanda, NY 14150

716-692-5451

DAYTON HAMVENTION

DAYTON OHIO 1991  
 SPECIAL PRICES BOOTH #319

### A.T.V. Video Samplers:

(3 styles to choose from or in a partial kit (wired board only). Prices range from \$45.00 to \$66.00. Kit board with components \$25.00.

### A.T.V. Power Amplifiers (Linear) for 70 CM - 33 CM - 23 CM.

Mini power amplifiers for 902-928 Mhz. band. (200 MW = 1.5 watts). This little power amplifier gives you the extra power to drive your larger power amplifier to full output. PD-33VLP. Some P.A. for the listed frequency use have preamps.

The input of any of our power amps. can be customized to meet your needs. Prices range from \$49.00 to \$285.00.

### Doublers:

70 CM to 33 CM with 1/2 watt input at 70 CM, a choice of either 1/2 watt or 1 watt output.

### Preamplifiers:

Low noise (0.6-0.7 DB Gain 12 to 18 DB)  
 2 MTR through 2.3 GHZ. some tower mounted type with T/R Switching. All preamps. are noise tested and a gain check made before being shipped.

### Single Frequency Transmitters for F.M. use (900 MHZ.)

Receivers also available for this frequency range.  
 See us at Dayton for reduced prices.

WARRANTY IS 1 YEAR ON LABOR AND 6 MONTHS ON PARTS.  
 EXCEPTION IS P.A. OVERDRIVE OR TRANSMITTING THROUGH A PREAMPLIFIER THAT IS NOT A T/R TYPE. YOU MAY RETURN ANY UNIT WITHIN 30 DAYS IF YOU ARE DISSATISFIED OR THE UNIT DOES NOT PERFORM TO YOUR SATISFACTION.

# THE LIONEL RAILSCOPE

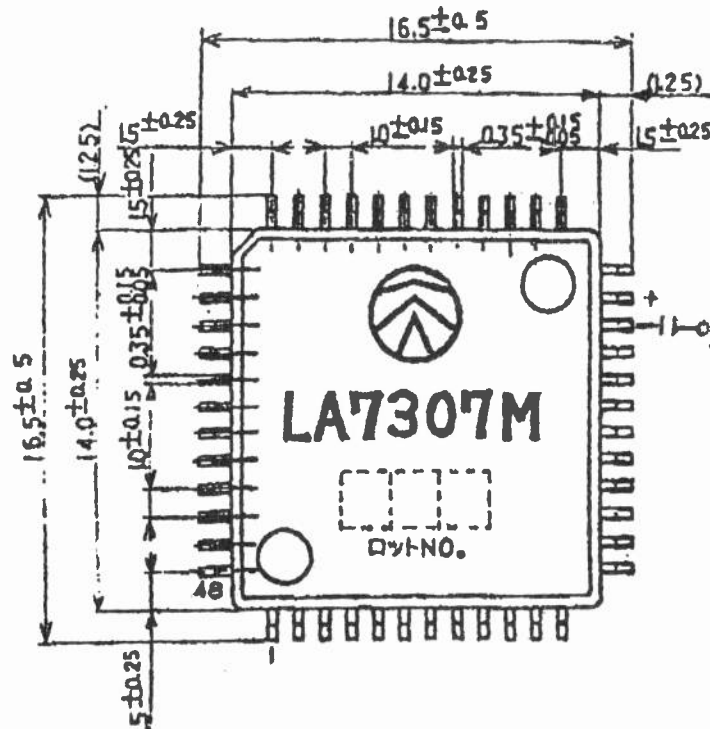

RAIL FANS! Maybe we could try this in its intended place, in a model train! Imagine televising your layout engineer's view via ATV to your friends! Take that Amtrak trip you always wanted but couldn't afford!

Video Output GND



Bottom view of Camera

CCD Sensor

# 10 GHz. FM ATV SYSTEM

by Dan M. Fish KBØXC

Previous articles written on this subject gave Mike Steiner and myself the incentive to try some experiments. Here at the Satellite City store in Minneapolis we have access to some 70 MHz. single conversion satellite receivers. These satellite receivers have a 70 MHz. I.F. input and are also available at a very reasonable price at many hamfests. The idea was born to see how easy we could put together a complete 10 GHz. FM TV system using these inexpensive receivers.

## BLOCK DIAGRAM

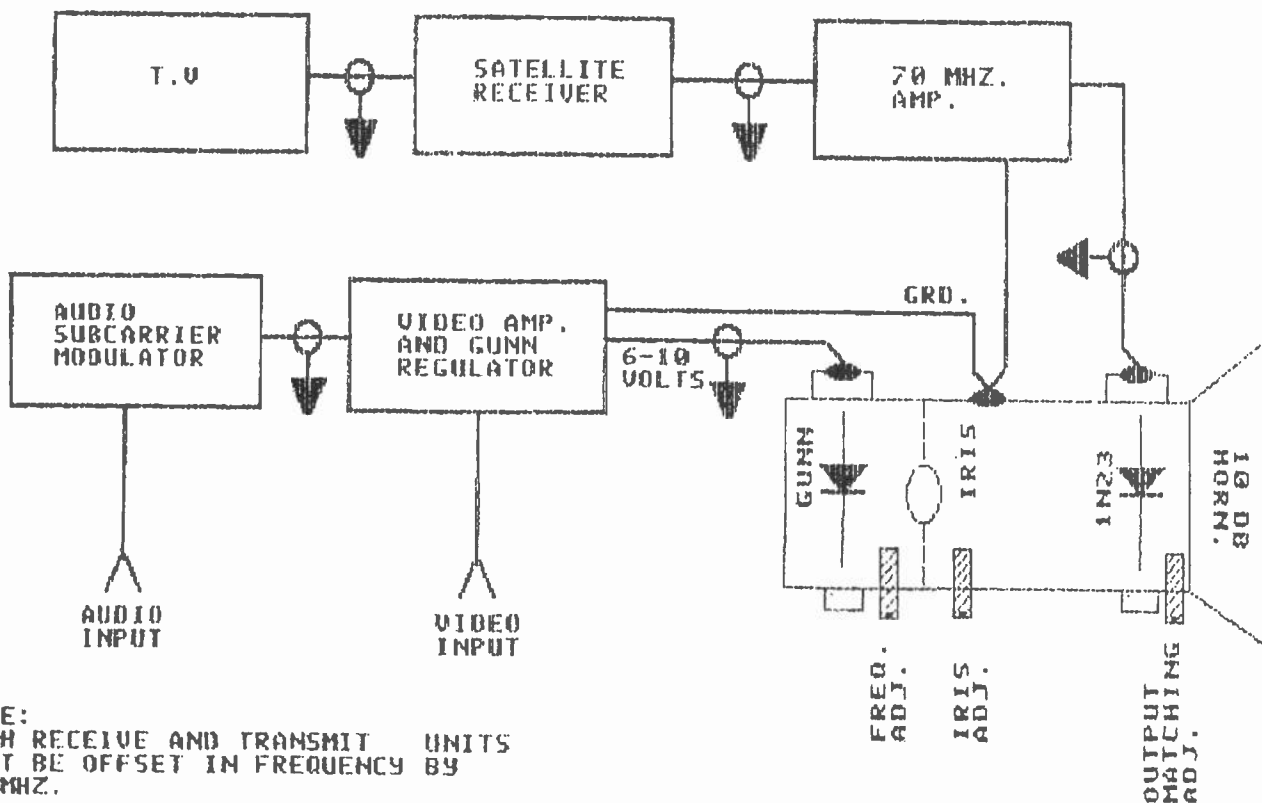

NOTE:  
BOTH RECEIVE AND TRANSMIT UNITS  
MUST BE OFFSET IN FREQUENCY BY  
70 MHZ.

Figure 1. Single side of a duplex system showing hookup to a Gunnplexer unit.

The block diagram shows a single side of a full duplex transmitter and receiver. The audio and video can come from any standard NTSC source (TV camera, VCR, etc.). The audio drives the audio subcarrier modulator which is mixed with the video in the video amp and Gunn regulator circuitry. The 12 volt supply was tapped out of the satellite receiver. Any source of 12 volts at about 200 milliamps should suffice.

The Gunn diode's output is used as the injection source for the mixing action in the 1N23 detector diode. The signal source is either +/- 70 MHz. different than the output of the Gunn device shown.

The units we have experimented with were easy to tune. In fact, we found them quite temperature tolerant. I imagine this is due to wide deviation used (8 MHz. or so). This means that the drift is smaller with respect to bandwidth.

The units need not be used to transmit video. The test unit had a CD player plugged into the video port. The audio was extracted from the satellite receiver's video output. No difference in audio quality or noise pick up could be detected. I would venture to say that an Ether type network could be established in this way as well. There is no end of ways to use such a handy low-cost microwave system.



# 10 GHz. FM ATV SYSTEM

## VIDEO AMPLIFIER BOARD

The video amplifier and regulator combine the modulated subcarrier audio and the 1 volt p-p video signal. The combination of these two source's make up the composite video which is found at the collector of Q2. Q1 provides pre-emphasis for the video and buffers the subcarrier from the low impedance of the video. Pre-emphasis is provided for greater retention of detail and color. After Q1, the signal passes through a 2.2 uF capacitor, then it is combined with the subcarrier.

Q2 provides about 10 dB of gain for the amplification of the composite video level. At this point, the signal level is about 0.2 volts p-p (collector). This signal is then superimposed on the regulated voltage from the LM317. This regulated voltage is determined by the 500 ohm frequency adjustment control. This control adjusts the voltage to the Gunn diode from about 5 to 10 volts. This also adjusts the frequency of the Gunn diode oscillator.

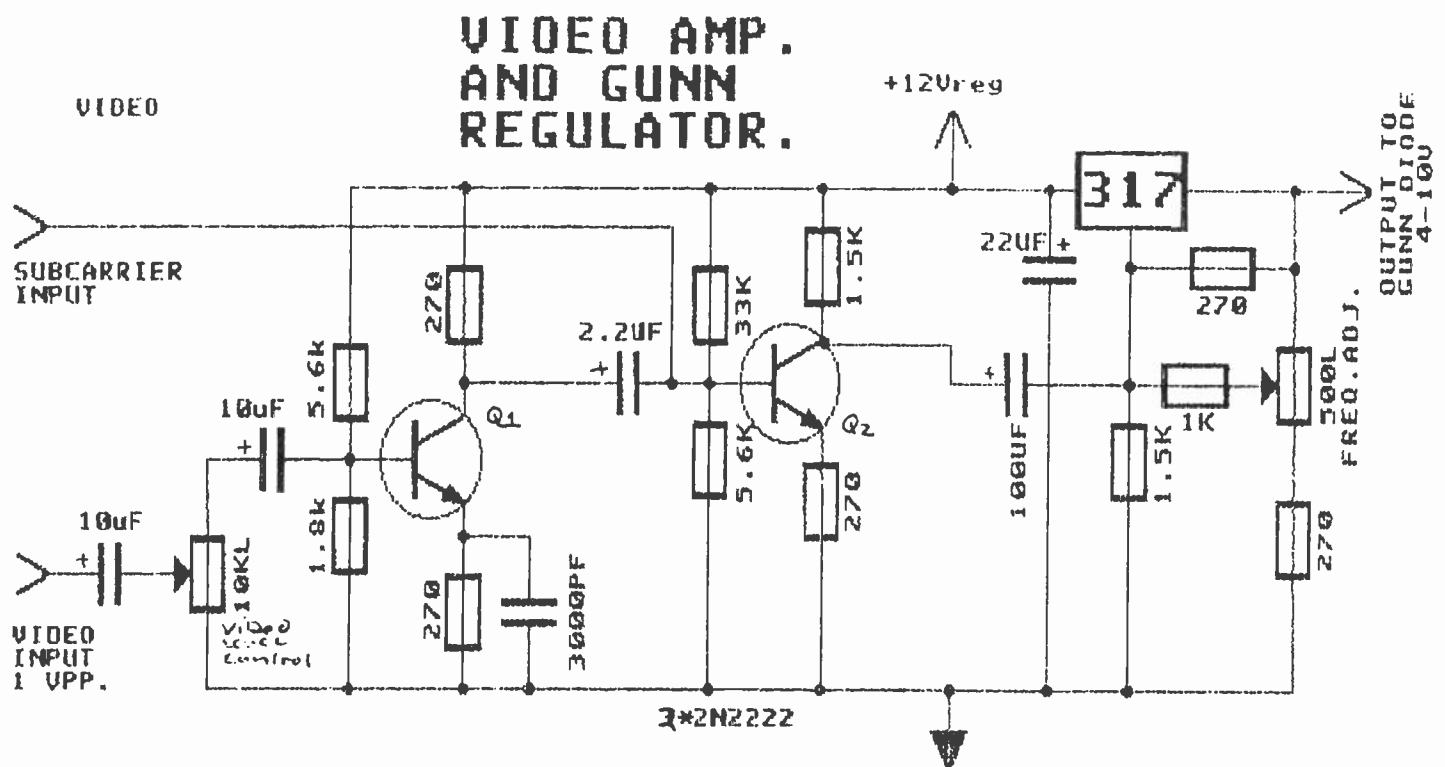

Figure 2. Video amp and Gunn Regulator

## AUDIO SUBCARRIER MODULATOR

The audio subcarrier modulator takes audio and combines it with a frequency from 6 MHz. to 7 MHz. When the audio enters the circuit, its level is set by a 10k pot. Q1 amplifies the signal by about 10 dB. The oscillation at Q2 is frequency modulated by the output of Q1. The 470 ohm resistor in the collector of Q1 forms a voltage divider in conjunction with the 1 MEG linear taper pot. This variable voltage along with the audio

output of Q1, causes the frequency of Q2 to vary in direct relationship to the pot setting and amplitude input. This variable frequency output is fed into Q3, which acts as a buffer and amplifier. The 0.68 uH coil and 1000 pF capacitor act as an untuned tank circuit centered on 6.2 MHz. The output feeds the regulator stage through the 75 pF output coupling capacitor.

*You Bet* Minnesota

# ICOM • YAESU

Satellite City

2663 County Road I, Mounds View, MN 55112

National 1-800-426-2891 Local 1-612-786-4475 State 1-800-279-1503

The Minnesota Ham Store



## 10 GHz. FM ATV SYSTEM

### 70 MHz. PREAMPLIFIER

The input tuned tank consists of a 5 pF capacitor and a 9 uH coil. This acts as a bandpass filter and impedance matching for the first amplifier. The coil also provides a DC return path for the detector diode in the feedhorn. The MRF 901's and associated 100k and 470 ohm resistor form two 20 dB gain broadband amplifiers. As the signal passes to the first amplifier, the signal is attenuated by the 1000 pF capacitor. This attenuation of about 6 dB was required to maintain stability. The output of the second amplifier passes through a filter centered on 70 MHz. and matched to a 75 ohm output.

### OPERATION

Fire up both ends of your link. Both receiver and transmit units must be offset in frequency by 70 MHz. for this system to work properly. You now should have a full duplex microwave video link. Gunnplexer units as well as some 70 MHz. satellite receivers are available from Satellite City, 2663 County Rd. I, Mounds View MN 55112. (612) 786-4475.

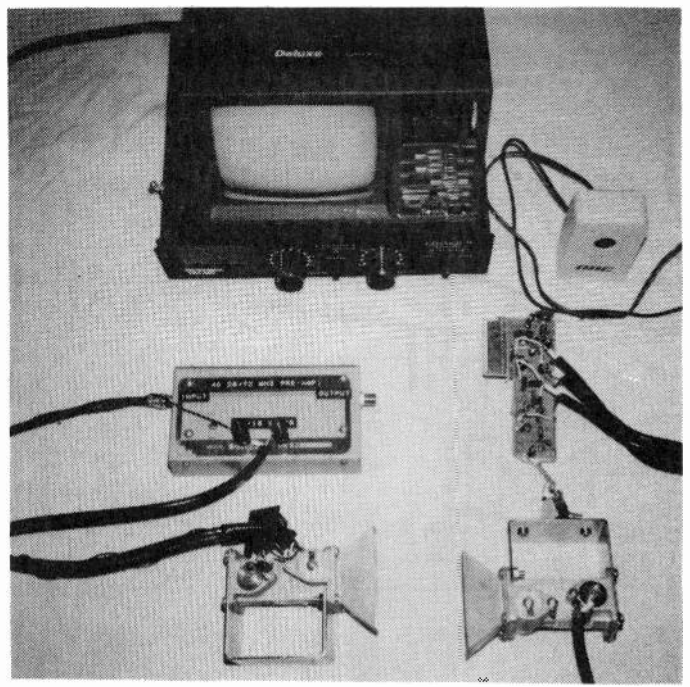

Components of the 10 GHz. duplex FM ATV system.

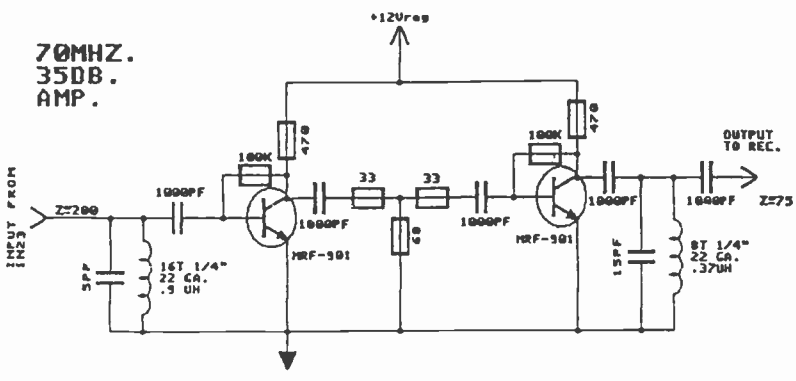

Figure 3. Subcarrier modulator

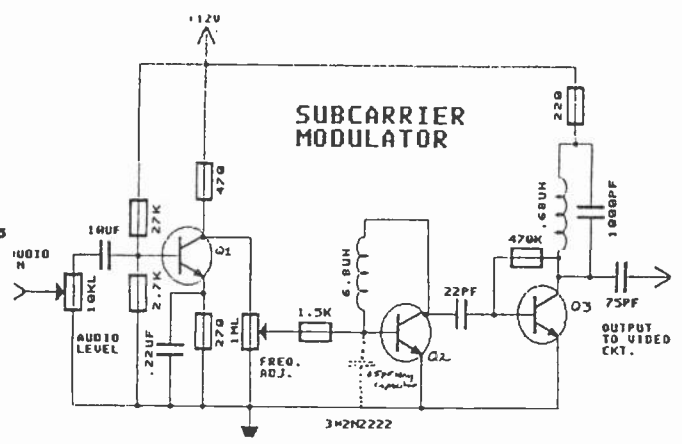

Figure 4. 70 MHz. preamplifier (35 dB gain)

# HOMEBREW UHF SWR BRIDGE

## *Test Equipment*

Louis Hutton K7YZZ

*When I began the construction of my ATV station the only SWR test equipment I had was a Heathkit SWR bridge that would cover the 2.0 to 150 MHz. band. Since I had planned to build and test different types of antennas on 434 MHz., I found that I had no way of determining if the antenna under construction was really resonant on the ATV frequency.*

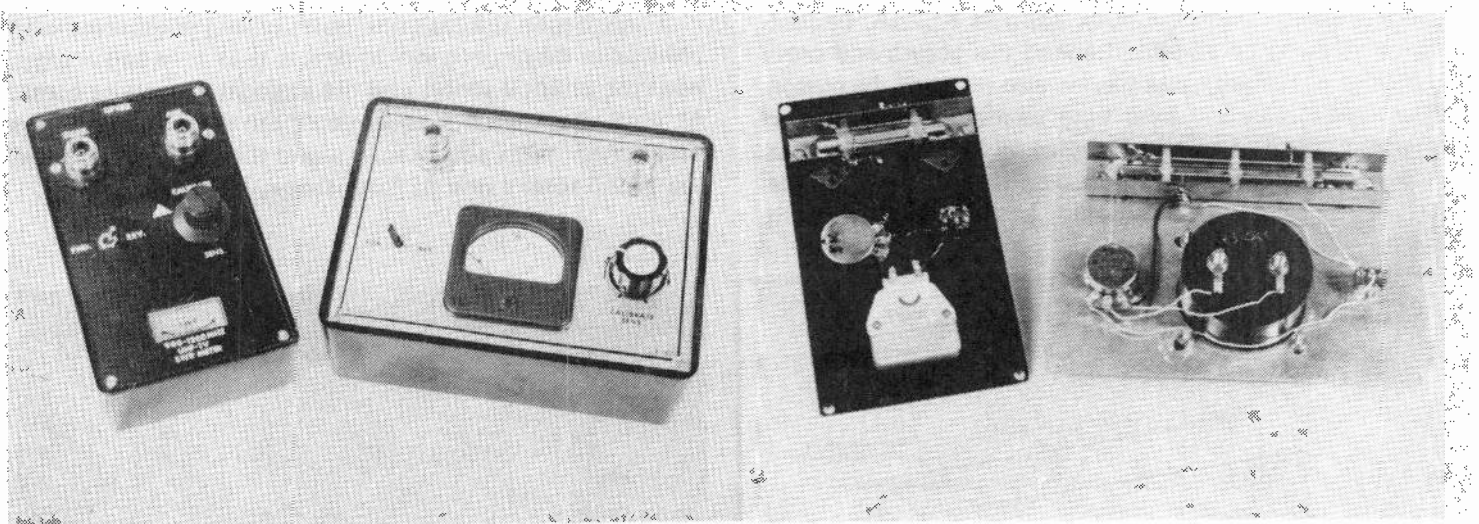

My ATV transmitter was assembled from components bought from PC Electronics and was capable of delivering around 10 watts in high power and about 2 watts low power to the coax feed line. The antennas that I had under construction were long Yagi's, Big Wheels, Alford Slots, Beach Ball, Ground Plane, and Dual Quad. These antennas were checked for SWR at the operating frequency, then taken up on the roof of my house and installed in my "Antenna Farm" for on-the-air testing. Some worked pretty good and others were a disappointment.

I took a good look at how that little Heathkit SWR bridge was built and then extrapolated the design. I built two different antenna bridges, one for 434 MHz. and another later for 923 MHz. The only difference between the two units is the length of the sensing unit. The drawing shows the construction of the 434 MHz. bridge. The sensing unit in the 923 MHz. bridge is 3 5/8" long for the brass trough and 2 1/4" long for the 1/4"

diameter brass center tube. The two pickup wires are 1 1/2" long. Construction and circuitry is the same for both units.

The case for the 434 MHz. units is 6 3/4" wide by 5 1/4" high by 2 1/4" deep. The 923 MHz. unit is 3 3/4" wide by 6 1/4" high by 2" deep. Both cases are of plastic and are internally shielded by gluing sheets of kitchen aluminum foil inside the boxes. The front panels are of aluminum. The meters were taken apart and a SWR scale was added to the face of the meter using rub on numbers.

I have found that the SWR bridges work best when driven with RF power in the 100 mW to 5 Watt level. Too much power seems to overwhelm the circuit and give inaccurate readings. So don't try and connect the bridge on the output of your 50 watt ATV amplifier! Also, use either BNC or type N chassis connectors, not UHF like you see on CB SWR meters. UHF connectors are not a good thing to use on ATV feedlines.

# MORE THAN RADIOS

## A BEHIND THE SCENES LOOK

by Jenny Zappala KB7FHD

*A very different video has come into the ham scene, but where did it come from? Who created it? What is the story and the reason behind the message?*

### A VERY SPECIAL MESSAGE FROM HAMS TO HAMS

On January 16, 1991, several hams and special guests were invited to the grand premier of a new video, More than Radios, in Bellevue, WA. The premier was an exclusive showing, presented by Icom America and Zman Productions, as a thank you to the cast and crew.

The video's director, Chuck Zappala KE7SA, handed out awards and personally thanked the actors and crew for making the project possible. He also revealed the reason behind the project, a long time secret he had kept to himself a tribute to Larry Douglas WA1EFO. Larry was an old time friend who introduced and helped Mr. Zappala into the ranks of Amateur Radio. Larry became a Silent Key in 1986.

Around June of 1990, work began on a concept for the video and it was shown to Icom, and encouraged the writers to complete the script. Chuck Zappala, Dixie N7OYY and I, spent many summer nights writing and rewriting the script.

Then, began the task of finding willing volunteers who believed in the project, would devote their time and energy, keep the script a secret and the majority had to be hams. At first, the search was difficult but soon a crew was assembled. With seven actors and the production crew, the grand total came to forty-three.

### UHF SWR BRIDGE *Continued...*

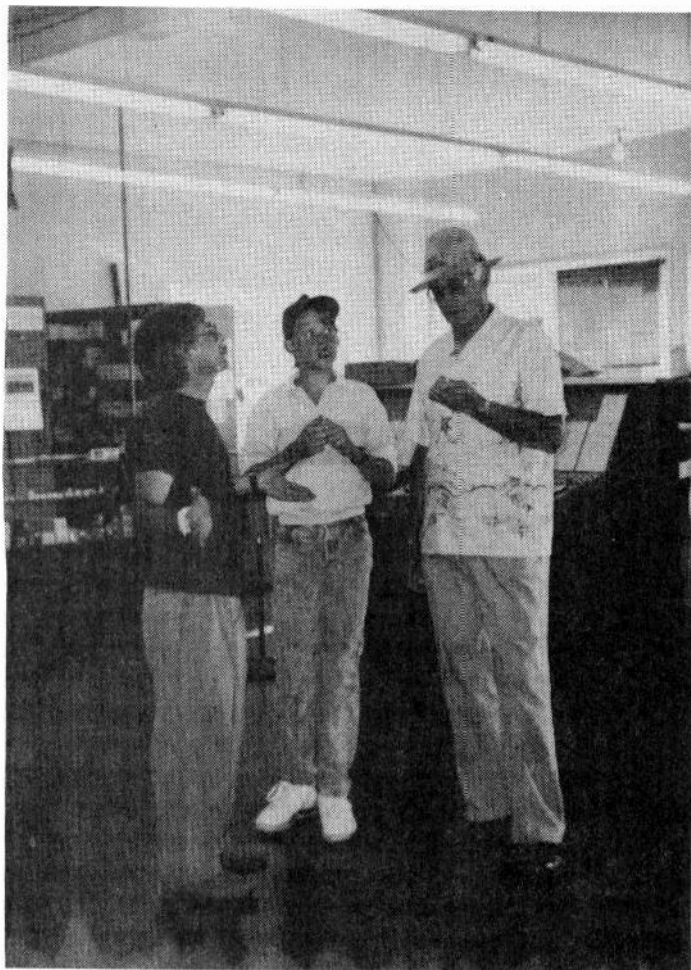
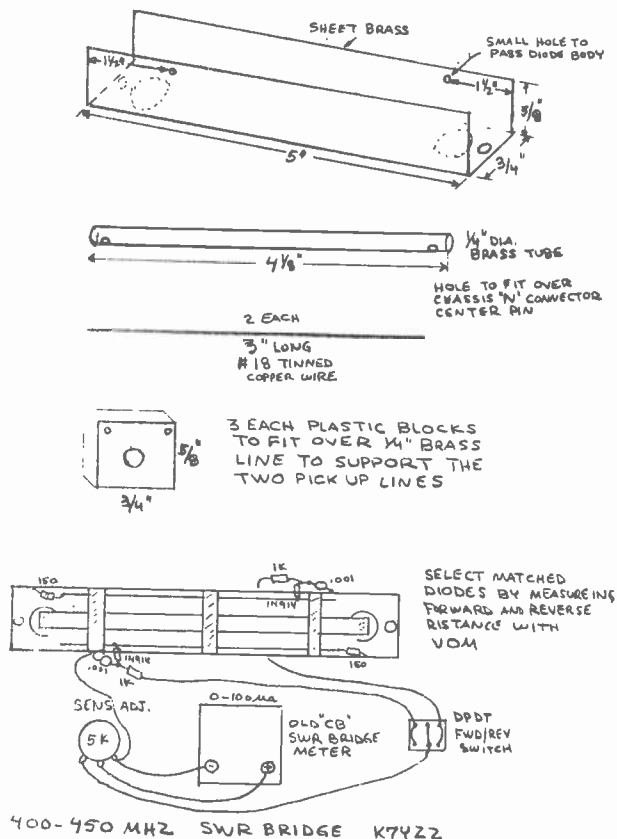

Crew rehearse and prepare for shots in local Seattle ham radio store.

# MORE THAN RADIOS

## *A BEHIND THE SCENES LOOK*

Work began to locate and organize shooting locations around the Seattle area to accommodate cast and crew. Most of the shoot locations were located in Edison and Sammish Island, in Skagit county. Most of the interior shots were done at the homes of Gary Storm, K7PQS and Mike Cusson, KF7YB.

Shooting actually began in August. The crew tried to work primarily in the early mornings and evenings with interior shots well past midnight to avoid the usual hot weather. The cast and crew was provided for with drinks and meals during shooting from the Crew Services Team, headed by Cathy Cox, who still has resisted our efforts to become a ham.

The crew worked hard, living up to the crew's motto of, "a rolling party guaranteed!" About two hundred photos were taken and a separate video of bloopers and documentary was shot by Bob Casteneda, KC7QR.

The video was shot in Hi8 format using two pro-density CCD chip cameras. The new Cinema Products Steadicam JR gave the video the fluid movements seen in the video. The second camera unit was headed by Richard Keller, W7TWU. Almost eight hours of raw footage was shot to cover problems later. Some locations could only be set once because of the difficulty in getting to locations some 80 miles away. After shooting, a work tape was made and the field tape masters were put away for safe keeping. After several days, each of the 432 shots were logged onto a computer database shot list using two tape decks.

The computer organized the shot list into a rough cut edit list to aid in the creation of a rough cut tape in only two days. After a short break the rough was examined for technical and story problems. A second rough cut was made to correct problems and a temporary music track was added. The second rough cut was viewed by a very small test audience. Listening to the testers suggestions, the tape was taken back into rough editing for changes. Chuck and Dixie Zappala did all the rough cutting.

Finally the master field tapes were taken back out and the selected shots were dubbed to broadcast Betacam video tape. Time code was also added to facilitate the special effects and requirements for precise editing. From there the tape was edited to one inch broadcast format. Mark Stienway performed all of the final editing, special effects and final sound tracks. The whole process took a week and this ended in late October.

Music was selected from the Omni Library. The video needed a full rich sound that everyone could enjoy. A full day was spent laying the music track from digital CD to the video master. Broadcast rights were obtained so that the video could be shown on commercial TV.

Then test dubs were made from the one inch masters to VHS to test quality. Sharp ears and eyes detected several defects and the master tape went back to correct technical flaws. Again VHS dubs were checked and everything was fine. A first copy was presented to Icom in early November.

**Producer Chuck Zappala instructs crew**



# MORE THAN RADIOS

## A BEHIND THE SCENES LOOK

Meanwhile the crew was becoming very anxious to see the final product. The original plan called for the premier in April of 1991, but that was discussed and soon dropped with the ideal of opening around Christmas 1990. December became too busy for many of the cast and crew. Finally, on January 16th, 1991, a very special message was presented to the Amateur radio community, from hams to hams.

Already the video has brought much attention and praise as one of a kind. Many hams have declared that nothing like this has ever been seen in amateur radio. It's quite true, it is very difficult to leave without a tear in your eye.

More Than Radios is a special message to all hams, everywhere. After you see this video you too will agree that this is really, well, more than radios.

*Editors note: This video was shown via satellite on Feb 24th and those who made recordings are allowed to show these to clubs and at other events. If additional copies are needed, do not violate the copyright or degrade the technical quality by making a dub. Additional copies can be obtained for the asking from Icom America.*

*The movie will be shown again at Dayton at the following times and locations: Friday night FM Bash, Friday night ATV Party at Holiday Inn North, Saturday night at the WWATS ATV party at the Rodeway Inn.*

*Cast and crew will be in attendance at all showings.*



Above: On location during a scene shoot.

Right: Last minute script checks.

Below: Chuck discusses the essence of the story line with cast and crew.



# CUSTOM CRYSTALS

## Crystals for many applications

For over 40 years, ICM has manufactured the finest in quartz crystals for every conceivable purpose.

A wide selection of holders are available to fit most any requirement. Our computer database contains crystal parameters for thousands of equipment types.

Need crystals for communications, telemetry, industrial, or scientific applications? Let ICM's sales department assist you to determine which type of crystal is best for you.

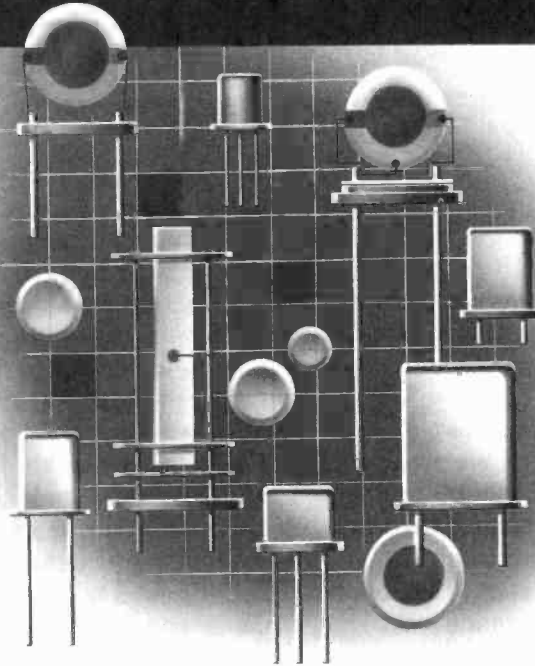

## Can we solve your crystal problem?

For special purpose crystals, special holders, special sizes, call our crystal sales department. We will be pleased to provide recommended data.



**International Crystal Manufacturing Co., Inc.**

P.O. Box 26330, 701 W. Sheridan,  
Oklahoma City, OK 73126-0330  
Phone (405) 236-3741  
Telex 747-147  
Facsimile (405) 235-1904

## NEW!

From  
Micro  
Computer  
Concepts

## VS-100 ATV REPEATER CONTROLLER Remote Video Switcher

- Repeat, Scan, and Manual Modes
- 10 Video and 4 Audio Inputs
- Touch Tone Controlled
- Videc ID Input/ELK Board Support
- ATV and Audio Repeat Control
- Features for ATV Use
  - Space and Power for Ad-on's
  - 19" w x 1.75" h x 10" d Enclosure

VS-100 Wired & Tested w/Manual . . . \$ 399.95  
Manual . . . . . \$ 9.95  
Phone Line Interface . . . . . \$ 99.95



**Micro Computer Concepts**  
7859 Rustic Woods Drive • Dayton, OH 45424

## 513-233-9675

# ATV RECEPTION IMPROVEMENTS

Mike Collis WA6SVT

*How often do you hear fellow ATV'ers talk about QRM to the picture, sound is noisy and has sync buzz, your color is weak through the repeater? In this article we will explore the reasons why and how to correct the problems.*

Most TV and VCR IF's are designed to receive P4 to P5 pictures with little or no adjacent QRM. These IF's were not intended to be used in the demanding service that ham TV requires. A good comparison to the HF world would be using a general coverage shortwave re-ceiver with a BFO and a wide band width filter that was intended for broadcast reception to be used for CW reception on the ham bands.

Many ATV'ers have told me that stacking two or three preamps is what is needed to bring out the weak signals. This may work in rural areas but not in the urban areas where out of band signals can overload the preamp or mixer stage resulting in intermod in the picture.

To design the ultimate receiver, let's start at the base-band end of the IF and work back to the antenna jack. The best type of IF boards I have found so far are the ones used in the newer VCR's that use a saw filter for the picture and a crystal filter for the sound. The first thing to find is a low impedance output or add an emitter follower to its' output. Next is to insert a multiburst signal modulated on 45.75 MHz. and look at the flatness on a scope or wave form monitor. There is usually a transformer between the first IF amplifier and the saw filter. This can be adjusted to help compensate for the reduced frequency response due to the vestigial sideband of the signal.

Most TV's, and VCR's to a lesser extent do not care if the upper video frequencies and color are reduced as they are receiving a strong signal and it is not a problem. When going through a repeater, or worse yet a network of repeaters, resolution, and color is poor or lost all together. While interconnecting the repeaters in the A.T.N. system we found this out early on. Another step that can be used to flatten out the response is to adjust the series resistance between the output of the video detector and the crystal 4.5 MHz. sound trap. This was suggested by Steve Franklin of TD Systems and to my surprise it worked very well to help flatten out the response. The saw filter that is used in the IF may not have a flat response and can roll off the sound carrier by several dB as well as affect the color sub-carrier somewhat. A new saw filter can be installed if needed to give a flatter response. The type that is used in TV up converters and cable TV modulators usually are very flat and can be installed in place of the original if pinouts and impedances are matched.

Now for the sound IF. Most IF's use a single two pole crystal filter that is 100 KHz. wide. That is connected via a 470 ohm resistor for impedance matching to the video detector. The other end of the filter then connects to an I.C. used as an IF amplifier and discriminator plus output buffer. While testing a VCR IF board and reducing the input

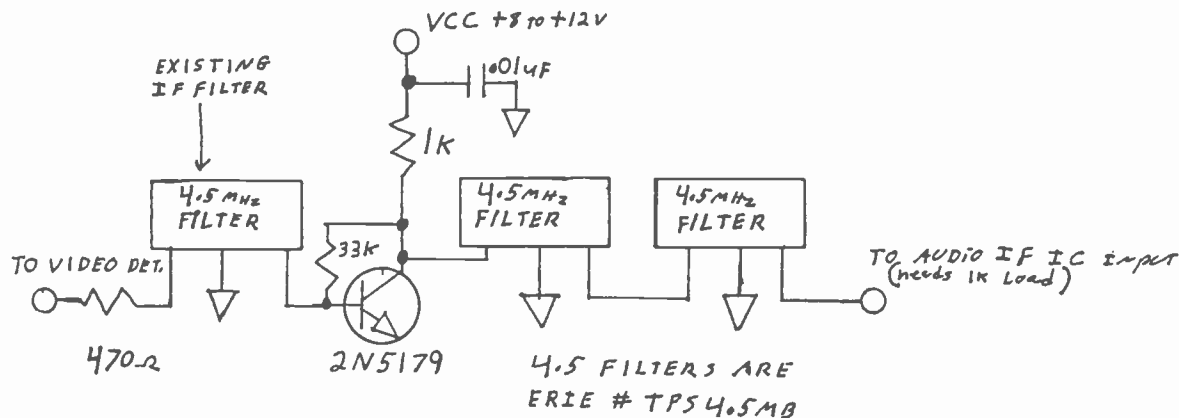

Figure 1. Added audio IF filter circuit.



# ATV RECEPTION IMPROVEMENTS

signal, the audio output not only got noisy but its' output level was also going down (AM detection). Another problem especially on repeaters is the other users on the band with links or repeaters near the audio frequency can cause desensitization to the audio. I tried cascading an additional 4.5 filter and it helped reduce the desense greatly but the audio was terrible due to the increased insertion loss.

While talking to Steve Franklin, I had commented about the audio problem that I was having on the Santiago ATV repeater and asked if he had tried to cascade 4.5 filters to sharpen the audio IF response. Steve suggested adding an additional IF amplifier and one more filter to my IF. He also sent me a few suggestions on this amplifier and filter over the fax and I tried it and the repeater has the best audio I have ever heard on ATV (see the diagram below for details). I can pick up full quieting audio with less sync buzz on weak signals that were marginal before.

The down converter should have a good dynamic range mixer such as a double balance type followed by a post amplifier to both terminate the mixer as well as amplify the signal. The local oscillator should have sufficient level as required by the type of mixer that you are using or suffer excessive conversion loss and reduced intermod rejection. The L.O. needs to be well filtered so sub-harmonics or any other spurious response is at least 40 dB down. A phase locked VCO or a simple tunable L.O. will usually accomplish this requirement.

Crystal oscillator plus multiplier accomplish this requirement. Crystal oscillator plus multiplier chains usually require some form of filtering to meet the -40 dB spurious requirement. The RF amplifier should provide about 15 to 25 dB of gain to overcome mixer noise and loss. It also needs to be filtered on the output to reduce the output noise and signals on the image frequency. The input also needs filtering to reduce the out of band response to prevent front end overload. If a long run of antenna cable is used that has 3 dB or more loss it may be worth adding a mast mounted preamp. GaAsFet is the preferred type but many do not have enough filtering to reduce intermod and overload in urban or other RF polluted areas. A simple two to four section filter made from Hobby tubing works well as a filter. Try to keep the loss in the .2 to .5 dB area when building up your filter. This mast mounted filter and amplifier should be placed in an outdoor electrical "J" box with a small drain hole in the bottom to prevent condensation from corroding the amplifier. A good designed ATV receiver should have a heavy texture of snow with no signal present but care should be exercised with adding extra RF preamplifiers as you may overload the IF's dynamic range on strong signals. I have usually connected the RF AGC terminal on the IF strip to control the RF amplifier that feeds the mixer. This extends the dynamic range by 30 dB or so.

Panasonic VJ8507169  
PV-1360 VCR IF  
UNLESS OTHERWISE SPECIFIED,  
WATTAGE OF RESISTORS ARE 1/16W.

TV DEMODULATOR SECTION  
NOTE: REF. NO. ON C.B.A. IS PRINTED AS FOLLOWS.  
EXAMPLE: C.B.A....R2, REF. NO. 700 SERIES  
SCHEMATIC DIAGRAM... R702  
( R702 IS ABBREVIATED TO R2)

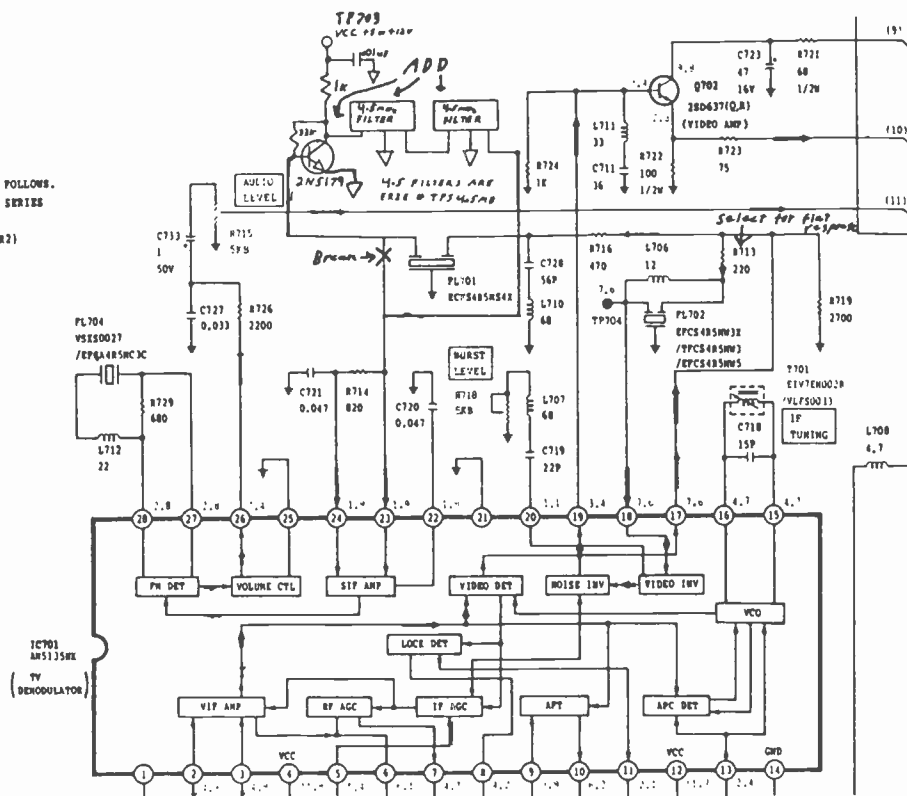

Figure 2. Adding the new audio filters to a typical VCR audio circuit. Also additional circuit changes.

# TOWER MOUNTED PREAMPLIFIERS WITH 100 WATT CAPACITY

PD-144TR-L  
(2 mtrs.)  
\$129.00

PD-220TR-L  
(220Mhz)  
\$129.00

PD-440TR-L  
(70 Cm.)  
\$139.00

N.F. 0.6 DB Gain 18 DB

N.F. 0.5 DB Gain 16 DB

## PREAMPLIFIERS

PD-144 dual gate 0.6 db. NF & 18 db. gain (2 mtr)	\$47.00
PD-144TR same but T/R switched	\$79.00
PD-220 dual gate 220Mhz.	\$47.00
PD-220 same but T/R switched	\$79.00
ABOVE IN KIT FORM NOT T/R	\$18.00 & \$35.00
PD-440S 70cm NEWEST DESIGN	
NF 0.5 db. & gain 18db.	\$67.00
PD900 33 cm. 0.6db. & gain 17db. (BNC) & PD-1200 (23cm) Same Specs.	\$75.00
In diecast box with "N" connectors	\$86.00
With T/R switching	\$129.00
PD-2300 2.3 Ghz. Can be used on 1.8ghz.	\$95.00
NF 1db. Gain = 17db.	
ATV-SAMPLERS Low Insertion Loss	\$49.00 & \$63.00
Transverter Kits for 900 mhz.	\$199.00
BRICKS & EXCITERS FOR 900mhz., 1.2ghz. & 70cm.	Call or Write
FREE CATALOG	Call or Write

ALL PRODUCTS ARE WARRANTED FOR 1 YEAR PARTS & LABOR  
EXCEPTION: Overdrive on P.A. or transmitting thru a preamplifier which is not a T/R type.  
Money back within 30 days if you are not satisfied.

## POWER AMPLIFIERS

PD-440N 1 to 2 watts in 18 watts out (linear) T/R	\$109.00
2 to 4 watts in 25 watts out (linear) T/R	\$149.00
440 Mhz.	
902 to 928 Mhz. FM & Linear	
PD-900 ½ watts in 8 to 10 watts out (FM)	\$50.00
Same but larger heat sink	\$65.00
1 watt in 18 watts out (linear)	\$210.00
Same but T/R switched	\$260.00
PD-1200N Brick Type 1 watt in 18 watts output 1.2 Ghz.	\$149.00
Same as above but larger heat sink	\$165.00

## POWER AMPLIFIERS

1.2 Ghz.

P.A. - Listed below are in diecast boxes

PD-1200TR (1 watt in 16 watts out T/R switched)	\$199.00
PD1200N-1 (2 watts in 30 watts out)	\$289.00
PD1200N-2 (4 watts in 50 watts out)	\$525.00

## ATV

Video Sampler

This unit picks up your transmitted ATV signal by sampling the transmission line with negligible insertion loss. It uses 2 "N" connectors for input and output connections. A BNC is used on the video output. The detected output is connected to your monitor and scope so that you may accurately adjust your transmitter for proper video & sync levels. We provide two different models. Both have relative power output meters, but one has a greater accuracy. There are 2 external controls, one for video level and the other for power output on PD-VDI. This beats an on the air adjustment.

PD-V.D.	\$49.00
PD-V.D.-1	\$63.00

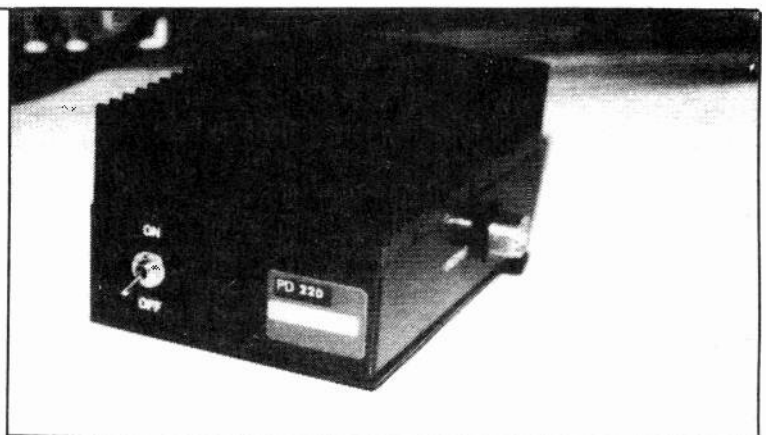

**pauldon**  
ASSOCIATES

DAYTON BOOTH 319

210 Utica Street  
Tonawanda, N.Y. 14150  
716-692-5451

# 2C39 CAVITIES

## THE REAL STORY!

Ottmar J. Fiebel, W4WSR

18860 Loxahatchee River Road  
Jupiter, FL 33458

*Over the years many articles have appeared describing amplifier cavities for the Amateur 23 cm and 13 cm bands. Not only was there a lack of similarity between them, but even their "mode" of operation conveyed confusing signals to would-be experimenters. Also, if construction details were not followed to the letter, they just would not work. This paper explores these anomalies and shows you what is important and why.*

### INTRODUCTION

It is interesting to note that despite the tremendous progress made in RF design methods over the years, understanding the design of "cavities" utilizing tubes still appears to be cloaked in black magic. Experimenters with an intuitive sense of what should or should not work, are left scratching their heads when a design similar to a so-called "proven" design fails to work. Operating "mode" concepts such as "loaded half-wave resonant circuit" (Ref. 1), "rectangular TE11 cavity" (Ref. 2) and "radial mode cavity" (Ref. 3) used to describe published designs are usually erroneous and give the experimenter a false understanding of their operation. As a result, the intuitive approach based on these alleged truths more often than not leads to utter failure.

Then there is the fellow with a successful design who brags about machining his cavity from solid block to a tolerance of better than .0005 inch, believing that this is the true secret to making it work well. He does, in fact, stress this requirement so strongly that it literally intimidates others who would like to duplicate his work. Contrary to this is the chap who claims to have made a cavity from a tuna can using just a pair of tin snips. Such claims are obviously ridiculous! Or are they!....

*CREDIT: This article was first presented as a paper at the Microwave '88 conference at Estes Park, CO and appeared in the ARRL publication Proceedings of Microwave Update '88. With the permission of ARRL, the author and ATVQ have edited and updated the information for publication here. The author is also the owner of Hi-Spec, a company which manufactures UHF/SHF power amplifiers, power supplies and inter-digital filters. The address is PO Box 387, Jupiter, FL 33468, twx 407 746 5031. If you make an inquiry refer to the ATVQ version of the article.*

### THE TRUTH

Regardless of the claimed mode, using a 2C39 family tube will invariably result in operation in the TEM mode. While it may sometimes be possible to force it into the TE11 mode, the fundamental mode of operation will remain the TEM. To simplify, the design is essentially the familiar old quarter wavelength coaxial line loaded by the tube. In the case of 13 cm however, we literally run out of line; or so it would seem. In reality, the internal construction of the tube is such that it presents a line having an inner conductor diameter of .365" by approximately .300" long. The *effective* length, however, is a function of how well both the grid and plate terminals are returned to RF ground potential. More on this later. The real difference between the various published designs is the method used to tune the cavity. Sliding wall configurations achieve resonance by varying the line's impedance. Most other designs use some method of introducing additional capacitance to bring the cavity down to resonance. I have encountered occasional problems with the latter which are interesting to note. In particular is the case where the resonant frequency of the tube and cavity is either way too high or way too low. In these cases apparent resonance is achieved, not by bringing the line into resonance, but rather the tuning system itself (usually a capacitive loaded plunger) becomes the resonant structure! Coupling in this case must be made to the resonant structure. While this method is frequently used in cathode circuits, it is not the method of choice for tuning the anode cavity. Let's take a look at some of the previously published designs and clarify the misnomers.

# 2C39 CAVITIES, THE REAL STORY

## CAVITY TYPES

### #1 "Loaded Half Wave Resonant Circuit"

This design, whether using one tube or two, uses a fixed length (height) of transmission line the impedance of which is varied by making one or more of the outer walls moveable. It is merely coincidence that in a particular situation the distance from the tube centerline to the adjustable wall approximates one quarter wavelength, thus making the total distance a "loaded half wavelength".

*Comment: In actual practice it should be noted that best performance appears to occur when all dimensions are symmetrical about the axis of the tube(s) and approach a square configuration.*

### #2 "Rectangular TE11 Cavity"

This design is similar to #1 except that the cavity wall dimensions result in a transmission line impedance BELOW that required for resonance. The resultant higher resonant frequency is brought down by the introduction of a variable capacitance.

### #3 "Radial Mode Cavity"

This is identical in operation to #2 except that the cavity wall configuration is round rather than rectangular. There are a few more configurations that have appeared in Amateur Radio periodicals over the years. They are as follows:

### #4 "Offset or Eccentric Line Cavity", (Ref. 4)

This is a 13 cm cavity wherein the tube is offset from the cavity centerline. By doing so, the impedance of the line is lowered, thus allowing a larger "cavity volume". It operates exactly as #2.

### #5 "Diagonally Loaded Cavity", (Ref. 5)

In this case the tubes are aligned along the cavity diagonal instead of perpendicular to the cavity walls. It makes no difference; the performance description is the same as for the rectangular configuration.

### #6 "Ring Cavity", (Ref. 6)

This configuration utilizes a series of tubes located around the circumference of what would appear to be a rather large diameter cavity. It is in fact a transmission line which has a series of smaller (though not readily identifiable) cavities aperture coupled to its outer diameter. It is mentioned here for identification only as its performance is rarely on a par with other designs.

All descriptions thus far have dealt with only the anode side of the "cavity". Input capacitance of the tube is too high to allow construction of a similar quarter wave resonant structure. Input coupling networks usually consist of variations of PI, T, coupled line networks or 3/4 or even 5/4 wavelength transmission line.

## CAVITY CONFIGURATIONS

### Anode Tuning

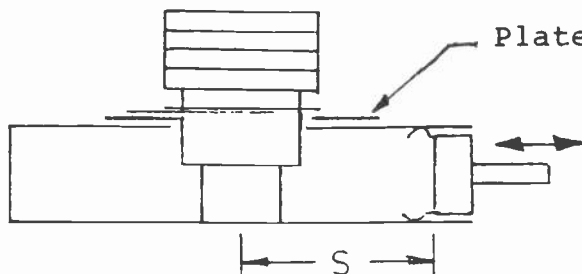

#### SLIDING WALL TUNING

Square or rectangular cavity. One or more walls adjustable. Resonant frequency increases as dimension S decreases.

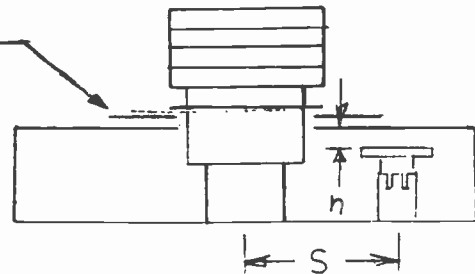

#### CAPACITIVE TUNING

Any shape cavity. Smaller dimension S gives greater range. Resonant frequency decreases as dimension H decreases.

# 2C39 CAVITIES, THE REAL STORY

## THE CRITICAL STUFF

If there is anything that is truly critical in building cavities using 2C39 series tubes it is the RF grounding of both grid and plate elements. It is this area that is also most compromised when trying to duplicate someone else's work. More often than not, the identical finger contact arrangement is not used thereby altering the value of inductance between true ground and the tube element. You can make the rest of the cavity out of aluminum, brass, copper or tin cans if you wish and it will probably work provided you used the same finger contact arrangement!

However, there is a caveat. Many designs, particularly those of European origin, utilize versions of the 2C39 which have a uniform diameter grid contact as opposed to the stepped version such as the 3CX100A5 or 7289. Finger contact destruction will invariably occur if the latter types are inserted. However, those able to accommodate the stepped grid contact will work with the uniform grid contact as well. In any new design it would be wise to use contact fingers which have been designed specifically for use with this tube series. They are available from Instrument Specialties Company (Delaware Water Gap, PA) as part numbers 97-70 (plate) and 97-74 (grid).

Just how well the RF is bypassed to ground is also critical. While the typical plate bypass capacitor is reasonably effective, I have yet to see an effective grid bypass. It is therefore recommended that in all designs the grid contact be returned directly to ground. This will require that the filament circuit be isolated from ground and other circuits, but that is a minor disadvantage.

As to plate bypassing, what is needed is a good low reactance path. Most existing designs seem to be adequate enough. However, many seem to advocate dielectric thicknesses of .01 to .02 inches. When one considers that the dielectric strength of most dielectrics exceeds 1000 Volts per mil, using such thick dielectrics is pure overkill! What is really desired is a bypass capacitor having a very low reactance. A good design should have a capacitive reactance of less than 1/1000 of the plate load resistance (plate voltage/plate current). While Teflon ( $E_r=2.5$ ) is by far the most popular bypass insulator, drafting mylar ( $E_r=5$ ) is a readily available and excellent choice. Even ordinary dry paper works ok!

### RESONANCE FORMULAE

Length required for resonance:  $l = \lambda \text{TAN}^{-1}(x_c/z_0)$   
 Impedance required for resonance:  $Z_0 = X_c/\tan(2\pi l/L)$   
 Where:  $L$  = physical length,  $Z_0$  = line impedance  
 $X_c$  = grid-plate capacitive Reactance  
 $\lambda$  = free space wavelength

APRIL 1991 VOL. 4 #2

## THE NOT-SO-CRITICAL STUFF

Just what material is used to fabricate the cavity is entirely up to the builder. While it is true that heavily silver plated copper represents the optimum choice, the relative performance of cavities constructed of brass or aluminum is still quite high. Rigidity and the ability to conduct the heat away from the tube are the real factors to consider.

As regards tuning methods, the choice again is entirely up to the builder. While it is obvious that good contact is required on "sliding wall" tuning systems, it should be noted that the center portion of the sliding wall is the most critical. In many cases only along the center third of the wall! RF leakage problems would undoubtedly occur in the later configuration unless properly shielded.

Tuning systems which use the screw thread as the RF return path should be avoided if possible. Unless a tight locking nut is used, they will invariably cause trouble. If a screw is used to drive a flapper system, an insulator of high quality must be placed between the screw and flapper. Direct metal to metal contact will prove extremely erratic. Poor insulators, such as nylon, will deform badly when exposed to high RF levels. Teflon or even a piece of G-10 epoxy board as a barrier work great.

## LINE CONFIGURATIONS

### CONCENTRIC LINE

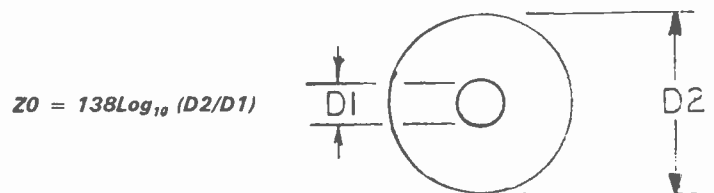

### ECCENTRIC LINE

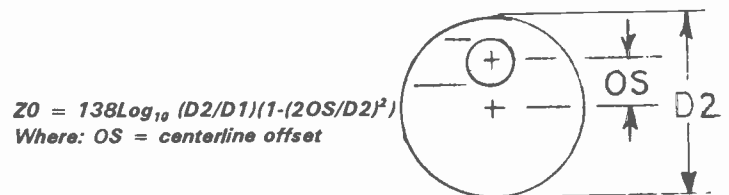

### PARALLEL LINE

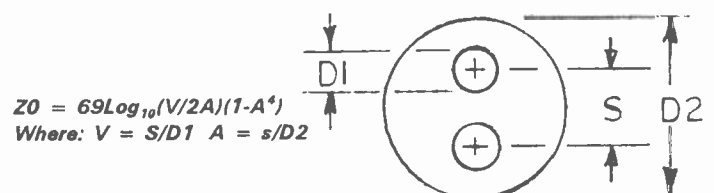

NOTE: For 2C39 calculations  $D_1 = .365"$ ,  
 minimum length = .300"

# 2C39 CAVITIES THE REAL STORY

## MECHANICAL CONSIDERATIONS

Contrary to common thinking, mechanical tolerances need not be as tight as might be thought. Since most designs use tuning systems which lower the resonant frequency of the cavity, errors on the short side are usually no problem. It should be noted that cavity height is much more critical than cavity width. In any event, when duplicating existing designs, tolerances of  $\pm .015$  in. at 13 cm should be quite acceptable. At lower frequencies, they may be proportionally larger.

Mechanical integrity is a must! Surfaces which bolt together must make good contact along the entire interface. Also, the distance between bolts should not exceed approximately  $1/8$  wavelength. Cavities made of sheet metal must be carefully soldered together. A cold solder joint is just asking for trouble. Again, choice of material is not that critical. Whatever the construction material, the final assembly should be extremely rigid.

Cavity shape is not particularly critical. If your round cavity looks more like something a two year old drew, it will probably still work ok! Likewise, square or rectangular cavities need not be perfect parallelograms.

## OUTPUT COUPLING TECHNIQUES

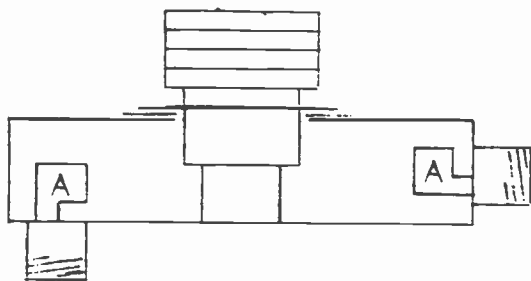

Inductive (loop) coupling

Loop area & rotation control coupling which is max. when plane of loop is as shown.

## Output Coupling

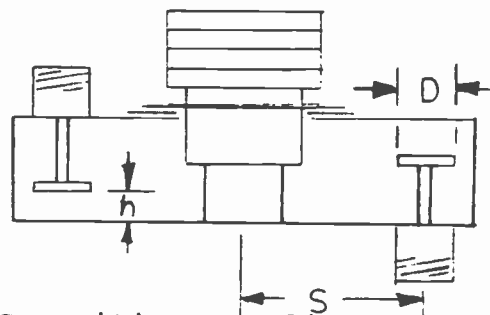

Capacitive Coupling

Disk dia. (D), separation (S) & spacing (h) control coupling increasing as (D) gets larger, (S) & (h) get smaller.

I like loop coupling!!! A loop may be rotated or moved in and out for optimum power transfer. Also, it may be introduced from any direction (top, bottom or sides) and is for all practical purposes fool proof! If it's too large you make it smaller and vice versa. While capacitive probes can also be used, they tend to have more de-tuning effects and generally lead to designs that look more like an octopus than a well designed structure. Fixed coupling systems, such as used in the design of #4 should be avoided. You might have it right on the nose, but you'll never know!

## INPUT COUPLING METHODS

The choices here are interestingly varied. At frequencies below 13 cm even the classic lumped element PI network can be used. I personally prefer the T network. However, *any* network which allows optimum RF power transfer is satisfactory, but *do keep things simple!* Use only the minimum amount supporting structure and avoid poor quality insulating material. Nylon is a no-no!

Despite all the choices, the input network is in reality the most critical as it pertains to overall gain. It operates at a higher Q and, as a result, is subject to greater losses.



## What's New at the Q

### We fired the typesetter!

In past issues we produced most of the pages using our Tandy LP-1000 laser printer, and the printer's typesetter would do the cover, headlines, photo lines and index page. Well, the typos were obvious, even to us! So we fixed it! ATVQ now has a new H-P LaserJet III printer and we bought some scaleable fonts. The contents of this issue, except for the ads which are as received from the advertiser (unless they asked us to do it for them) were all done on the new printer. We have also upgraded the word processor program software.

## HELP WANTED

As we strive to bring you better issues, we are in need of someone who can re-do diagrams to a standard format using CAD or similar software. If you are interested in a low paying job with the Q (most of the income goes to pay for printing and mailing costs) drop us a note or see us at Dayton. Access to a FAX machine is a plus.

We also can't make all the hamfests we would like. If you or your club would like to be a sales rep at hamfests for the Q to earn some money for yourself or your club, selling copies and subscriptions drop us a line or see us at Dayton.

## 2C39 CAVITIES, THE REAL STORY

### DESIGNING YOUR OWN CAVITY REFERENCES

This dissertation was not intended to provide you with absolute methods for designing your own. Rather, armed with what is presented here along with dimensions shown for previous designs, the experimenter should be able to develop variations of existing designs which suit his purposes. Trial and error approaches should be more fruitful now that the cause and effect relationships are more clearly understood. However, the formulae and illustrations will be of great value for those who want to "roll-their-own".

- 1, Fisher, Schaible, Schober, Turrin, "A Power Amplifier for 1296 .", HAM RADIO, March 1970.
- 2, W. C. Taft, "Tripling to 1296 .", CQ, Sept. 1959
- 3, Garrett and Manly, "Crystal Control on 10,000 Mc", QST, Nov. 1963
- 4, W. J. Foot, "A 2304 . Power Amplifier", HAM RADIO, Feb. 1975
- 5, P. Laakman, "Cavity Amplifier for 1296 .", QST, Jan. 1968

#### CATHODE TUNING

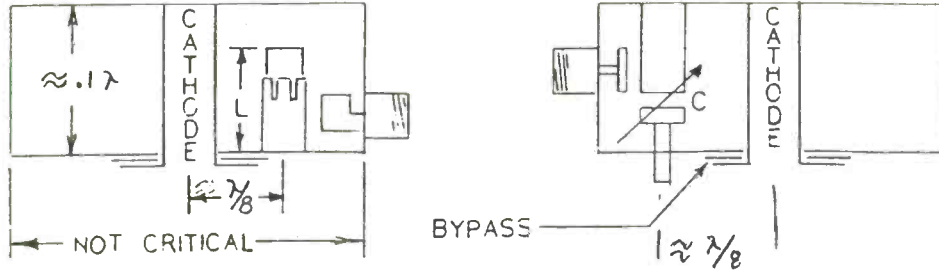

#### RESONATOR COUPLING

*Note that the resonator may be fastened to the top or bottom and may be tuned by varying its length L or varying the loading capacitance C. Note also that the loop or capacitive coupling may be used with the loop nearer the "cold" end and capacitive at the "hot" end.*

### RUTLAND ARRAYS PROUDLY ANNOUNCES THE **FO22-ATV**

**MEASURED GAIN >14.8 dBd FROM 420 TO 450 MHz**

Model: **FO22-ATV**

**\$94.95**

**ELECTRICAL SPECIFICATIONS:**

Gain peak ..... 15.8 dBd (436 MHz)

VSWR ..... < 1.33:1 415 to 450 MHz

E-Plane beamwidth ..... 23 Deg.

H-Plane beamwidth ..... 24 Deg.

Sidelobe attenuation

1st E-Plane ..... -17.5 dB

1st H-Plane ..... -15.5 dB

Maximum power ..... 1500 Watts

F/B ratio ..... 22 dB

Impedance ..... 50 ohm

**MECHANICAL SPECIFICATIONS:**

Length ..... 14 Ft.

Boom ..... 1" OD 6061 T-6 Al

Elements ..... 3/16" Al rod

Mast ..... up to 1.5" dia.

Wind surface area ..... .78 Sq.Ft.

Wind survival ..... 90+ MPH

All Stainless Steel Element Hardware

Coax connector ..... N-type

Polarization: Horizontal or Vertical

**ALSO AVAILABLE**

RA4-50, RA7-50, RA8-2UWB, FO12-144, FO15-144, FO16-220,  
FO22-432, FO22-ATV, FO25,432, FO33-432, FO22-440  
POWER DIVIDERS ..... STACKING FRAMES

WRITE FOR INFORMATION ON OUR  
COMPLETE LINE OF VHF/UHF HIGH  
PERFORMANCE YAGIS

ADD \$5 UPS S/H  
\$7 West of the Mississippi  
PA residents add 6% State sales tax

**DAYTON FLEA MARKET SPACES 2114, 2115, 2116**

AVAILABLE FROM:  
**WYMAN RESEARCH**  
OR  
**RUTLAND ARRAYS**  
1703 Warren St.  
New Cumberland, PA 17070  
(717) 774-5298 7-10 pm EST

### AMATEUR TELEVISION QUARTERLY SUBSCRIPTION

DEVOTED ENTIRELY TO AMATEUR TELEVISION

	US Delivery	Canada	Elsewhere
<input type="checkbox"/> 1 YR	\$15	\$20	\$25
<input type="checkbox"/> 2 YR	\$30	\$40	\$45
<input type="checkbox"/> 3 YR	\$40	\$55	\$65 (all US Funds)
<input type="checkbox"/> 4 YR	\$50	\$70	\$85
<input type="checkbox"/> 5 YR	\$60	\$85	\$100

### VISA AND MASTER CARD ACCEPTED

Call: \_\_\_\_\_ Name: \_\_\_\_\_

Address: \_\_\_\_\_

City: \_\_\_\_\_

State/Prov: \_\_\_\_\_ ZIP: \_\_\_\_\_ Country: \_\_\_\_\_

Gift? \_\_\_\_\_ From: Call: \_\_\_\_\_ Name: \_\_\_\_\_

Card # \_\_\_\_\_

Expires \_\_\_\_\_

Signature \_\_\_\_\_

1545 Lee St., Suite 73  
Des Plaines, IL 60018

**SUBSCRIBER HOTLINE**  
708 298 2269

# 1991 ROSE PARADE ATV

The 1991 Tournament of Roses parade has been a sorrowful event due to Doc, WB6MOQ, passing away in the prime of his life. Doc has been instrumental in parade activities as well as an ATV'er for years. Cam, KI6VK, called the ATV'ers to order, at the request of Jeanie Nordland (Doc's wife). It was Doc's wish to continue with the ATV and radio communications for the parade. Mike, WA6SVT, loaned the Crestline ATV repeater and set it up on the Pacific Telephone building in Pasadena. We had 9 active TV camera positions and 3 monitor locations. The Tournament officials are so impressed that they are allocating money for a permanent receive site equipment at Tournament House and also help us with portable repeater modules. DE: Mike WA6SVT

Camera	1	Nick, N6UUL, & Mike, KB6IZK
	2	Eva, WA6YQT, & John, WB6YQT
	3	Bob, W6LUY, Tom, KB6EFH, & Frank, N6KXL
Also	4	Cam, KI6VK, Don, N6ROR, & Berry, KCOXK
Repeater		
Site	5	Doug, WB6KNY
	6	Jim, KA6KOM, Lee, K6ZVA, Betty, KB6ERS, & Dick, WA6BYT
	7	Jan, WB6VRN, & Dave, WA6PMX
	8	John, KB6MMF, & Bud, KB6MID
	9	Canceled
	10	Jamie, KK6CU, & Paul, N6VLV
Net Control		Koiohi, KB6EL

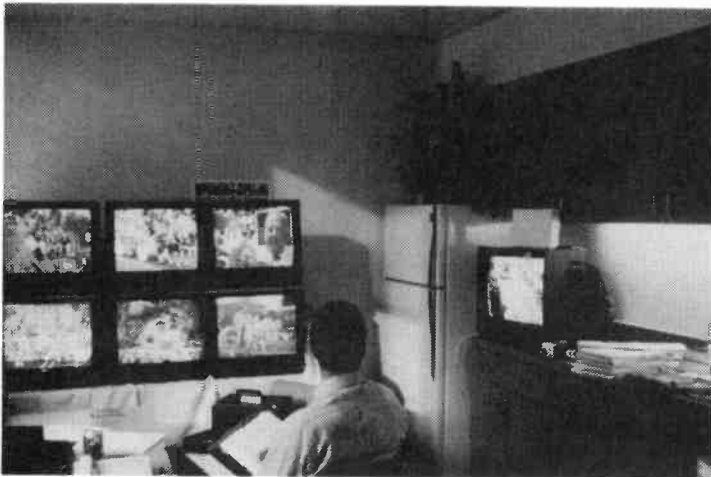

**Media Room**

*This is where the parade coordinator directs the mixing of bands and floats with the proper timing for a smooth running parade. ATV is on the far right hand monitor.*



*Test pattern from the repeater at Pacific Bell Building in Pasadena. 434 in, 919.25 out.*

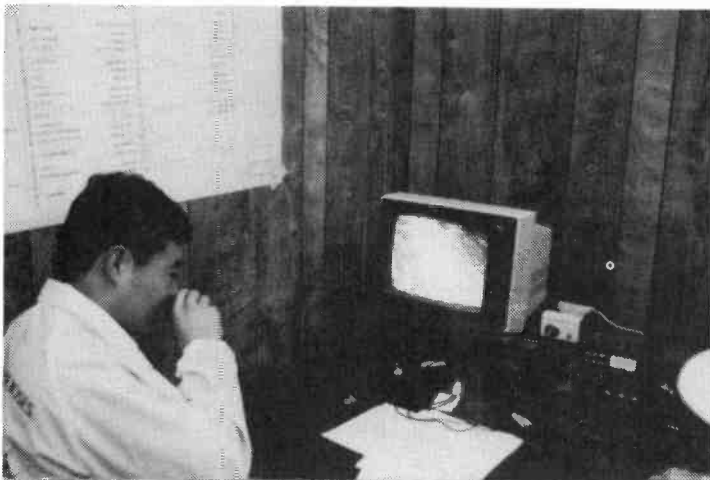

*ATV net control in the command trailer. KB6EL operating.*



*Medical emergency at the parade.*



# THE BATC

## ARE YOU A MEMBER ?

YOU CAN BE FOR AS LITTLE AS \$18 PER YEAR

(\$27 PER YEAR TO RECEIVE YOUR MAGAZINE BY AIR MAIL)

FOR THIS VAST SUM YOU WILL RECEIVE FOUR ISSUES OF THE CLUB'S MAGAZINE, CQ-TV, WHICH IS ALWAYS PACKED WITH UP-TO-DATE PRACTICAL INFORMATION ON ATV DESIGNS. PRINTED CIRCUIT BOARDS AND SPECIAL COMPONENTS ARE ALSO AVAILABLE FROM THE CLUB AT REDUCED RATES. A SERIES OF HANDBOOKS HAVE ALSO BEEN PUBLISHED BY THE CLUB, DEALING WITH ALL ASPECTS OF ATV, FROM SETTING UP YOUR FIRST STATION, TO THE LATEST IN STATE-OF-THE-ART MICROWAVE GEAR. MANY OTHER SERVICES AND FACILITIES ARE AVAILABLE TO MEMBERS AND PRACTICAL HELP IS AVAILABLE ON ANY TV RELATED TOPIC

FOR FURTHER INFORMATION AND MEMBERSHIP APPLICATION FORMS ETC, CONTACT OUR UNITED STATES AGENT DON MILLER AT:

WYMAN RESEARCH INC, BOX 95, WALDRON, INDIANA 46182

TEL: (317) 525 6452

(CHEQUES PAYABLE TO WYMAN RESEARCH PLEASE)

## *COMING IN THE NEXT ISSUE OF* **CQ-TV**

CONSTRUCTION AND TECHNICAL ARTICLES FEATURING: A VIDEO MIXING DESK & EFFECTS GENERATOR, VIDEO FILTER FOR 70CM, SATELLITE DISH EL/AZ CONTROLLER, TUNED UHF PREAMPLIFIER, MORE 10GHZ ATV TX/RX PROJECTS, STUDIO VISION & AUDIO TECHNIQUES, DIGITAL VIDEO FOR ATV VIA PHASE 3 & 4 SATELLITES, PLUS LOTS OF NEWS & VIEWS. MAKE SURE YOU GET YOUR COPY, SEND YOUR SUBSCRIPTION TO DON AND JOIN THE 2500 ATV'ers WORLDWIDE WHO MAKE UP AND ENJOY BEING A PART OF

THE BRITISH AMATEUR TELEVISION CLUB

# A PHOTO HISTORY OF ATV MAGAZINES



# A PHOTO HISTORY OF ATV MAGAZINES

text by Henry Ruh KB9FO

photo work by Dave Williams WB0ZJP

*Nothing happens without some earlier effort. As Newton said, "If I've accomplished anything it is because I have stood on the shoulders of giants who preceded me." Likewise ATVQ is a continuation of earlier work by myself as 7 year publisher of Amateur Television Magazine and others who preceded and followed. Here is a photo history and some comments about ATV magazines from the start.*

---

***If Hiram Percy Maxim, W1AW, were alive today, he would be a charter subscriber to ATV Magazines and operating ATV mobile!***

---

That may shock some of you but think about it for a while. Here are some historical facts which might surprise you. Hiram was an inventor and scientist. Among his early works he built a gasoline powered vehicle with three wheels, invented the silencer for guns, and owned a company which produced electrical and aircraft components. Hiram is best known for his efforts to get Ham Radio back on the air after WW I and starting the ARRL. But Hiram was also a charter member, organizer and President of the Amateur Cinema League. With his interests in promoting use of higher frequencies (then 200 meters and down) later the short wave bands it is easy to conjecture that Hiram, with his interests and inventions in cars, electronics, HF and Cinema, would have combined those interests to become an ATV operator! That must be making the anti-ATV folks at the League turn white! But it's true!

Early television started on HF. Some of the earliest TV transmissions, using mechanical scanning systems such as the Nipkow Disk were transmitted over existing AM broadcast stations. Later experimental stations operated in the 2-6 MHz. region, transmitted live video up to 600 miles during daylight and further at night. One of the earliest documented TV stations was in Lafayette Indiana at Perdue University.

These "low resolution" transmissions gave way to electronic scanning and use of VHF frequencies. The first known ham TV operator/station was Mel Dunbrack W1BHD, who was given a special authorization to identify as W1BHD-TV. One of only a very few so licensed because the FCC did not have any rules governing TV transmissions when Mel began using his own home brew equipment in the late 1920's, fashioned after the systems used by Baird and others in the commercial TV experiments. No mean feat as devices to make and display TV images were not something you went to Radio Shack to buy!

Mel got the TV Bug early and got several of his friends to build receivers. To get activity started in Ham TV he put out a local newsletter, a single sheet, soliciting ham TV operation. To the best of my knowledge, this is the first effort to organize and publish an ATV newsletter. Mel is still active on ATV today and it's been his life long favorite mode.

---

## FIRST ATV PUBLICATION June 1962-November 1964

---

*Commercially organized ATV publications started with another. Mel. Mel Shadbolt W0KYQ of Dakota City, Nebraska and Wayne Green W2NSD, as respectively editor and publisher started ATV EXPERIMENTER and the first issue was June-July 1962.*

The publication lasted three years and 18 issues, 17 of which are pictured on the following page, although all 18 issues are in my collection. Wayne Green was just starting his ham Publication 73 Magazine at this time and had ideas of several special interest publications covering RTTY, ATV etc. Mel Shadbolt eventually started a company called ATV Research, today known as Century 21, and still operates from 130 Broadway, Dakota City, NE. 68731.

In these early days, transistors had just become available (Remember the CK721, CK722, 2N35 etc?) and although you could buy a TV set, getting a camera was a little more difficult. Many of the early articles were concentrating on BUILDING your own camera, with articles on lenses, pick-up tubes, deflection coils, monoscopes, flying spot scanners and other early imaging devices. The first public service ATV activity noted was the March Of Dimes fund drive. The activity was provided by the LaGrand, OR, ATV hams, Fred K7KRP and Marvin W7LWM, Vic W7ZTC. The signals fed into an early CATV system feeding 2800 homes.

Among other efforts documented was a petition by Wayne Green W2NSD published in Vol 1 # 5, which asked the FCC to permit narrowband ATV (1 MHz. bandwidth) to be allowed to operate on 6 and 2 meters which were at that time largely vacant! The main resistance was from Columbia Broadcasting (CBS) which feared interference to channel 2 TV (on which there were a large number of CBS owned and affiliated stations).

# A PHOTO HISTORY OF ATV MAGAZINES

*Early operations were crude by today's standards and required a good level of technical competence.*

Everything was built from scratch or heavily modified. Early transmitters used a 6AF6 which might manage 2 watts on a good day. Having 60 watts from a converted military 420 MHz. transmitter was considered high power.

There are accounts and photos of early DX peditions to mountain tops and other portable stations. Listings in each issue provided a growing list of ATV stations in all parts of the country and Canada.

By Volume 3 #2 there was activity noted in every populous area of the US with NY, CA, FL, OH, IL, IN, MI, VA, PA, NJ, CT, TN, IA, TX, OR, WA, AL, NM, MT, MD leading the pack.

The magazine also showed the early VKR500 linear track VIDEO TAPE RECORDER, with, later, a user/builder report by Mel Shadbolt, the first documented home VCR owner! For those who only know VCR's as Beta or VHS, this first attempt at a home VTR was based on using high speed and long reels of 1/4" "audio" tape. By today's standards it was nothing to write about, but back in 1964, it was plenty good enough to even get a picture to record and playback.

At the end of three years many hams who would also become famous had appeared in its pages. Ralph Taggart WA2EMC, (now WB8DQT) later to be a pioneer in SSTV, digital and WX sat provided a low noise UHF preamp using 6CW4 nuvistor tubes. Vanguard Labs who today sell WX sat equipment, Denson Electronics, who's owner, Al Denson was an ATV'er sold industrial TV equipment to schools and business also advertised his goodies in ATV Experimenter. Others in early issues included Don Miller W9NTP and his wife Sue W9CNW (now W9YL) of Wyman Research today and an SSTV pioneer, Al Lipkin W3AEH, later to be part owner of A5 Magazine, Bill Parker W8DMR who also had articles in Radio Electronics on building your own TV equipment. SSTV was mentioned with OSCAR III, as Don W9NTP and Bob W7FEN prepared to make the first space relayed ham TV contact using SSTV.

Lastly, the FCC was noted to have changed their dual ID rules 97.87 (a)(2) which thus permitted a RTTY, ATV or FAX station to ID in its primary mode or CW ID including automatic station ID (using "reasonable CW speeds").

ATV Experimenter ended with a letter of explanation from its editor, Mel, explaining how despite thousands of hours, piles of magazine hand-outs and volumes of correspondence, the effort had failed to achieve an income level capable of sustaining publication.

---

## A SECOND ATV PUBLICATION September 1967-July 1970

---

*You can't keep a good mode down!*

*The second commercial venture was A5 Magazine an effort by Donald Lewine WB2UMF and Martin Balk WB2SZW both of New Jersey. Eighteen issues were published, all pictured on the next page.*

Technology advanced quite a bit during the three years between the end of ATV Experimenter in 1964 and the start of A5 in 1967. SSTV had gotten off to a good start and had advanced beyond the STA stages. OSCAR was a new exciting mode and the introduction of the first microprocessor IC. Video equipment was becoming available at reasonable prices and in some cases as surplus.

A5 concentrated on SSTV theory and operation. Although there was some coverage of FSTV. One cover photo showed a mobile ham TV station with an open chassis tube camera mounted on a tripod inside a convertible car. Another "new comer" broke ground in the July 1968 issue as HAM RADIO MAGAZINE made its debut.

Emphasis was still on home brew equipment including cameras, converters and modulators. Most were still using tubes although transistors started taking over by issue 12. This issue, July 1969, also featured an ad by a new company destined to become the premier source of ATV equipment, P. C. Electronics aka Tom O'Hara W6ORG.

The first IC circuit was a utility amplifier based upon an RCA CA3020. Its purpose was to provide some video gain to make up for "low camera output and long cable losses." Readers were still treated to sources for home brew parts especially tubes, cameras and emerging video recorders.

The publications to this point were all in the older small magazine format of 8 x 5 inches. Most issues were 12-16 pages and no color was used. It was obvious these were no "QST's" but the amount of effort to even put out these little issues was far beyond the small income they produced. A5 ceased after the July 1970 issue (#18) and the authors, recently having obtained their FCC commercial radio telephone operators licenses, concentrated on college classes and life.

The first issue of the next publication alludes to the existence of an issue #19 by indicating it would be #20 under the old numbering system, but searches have not turned up any such issue. If anyone has an issue #19 copy and would like to send it to me or send a copy I would appreciate it.

# A PHOTO HISTORY OF ATV MAGAZINES

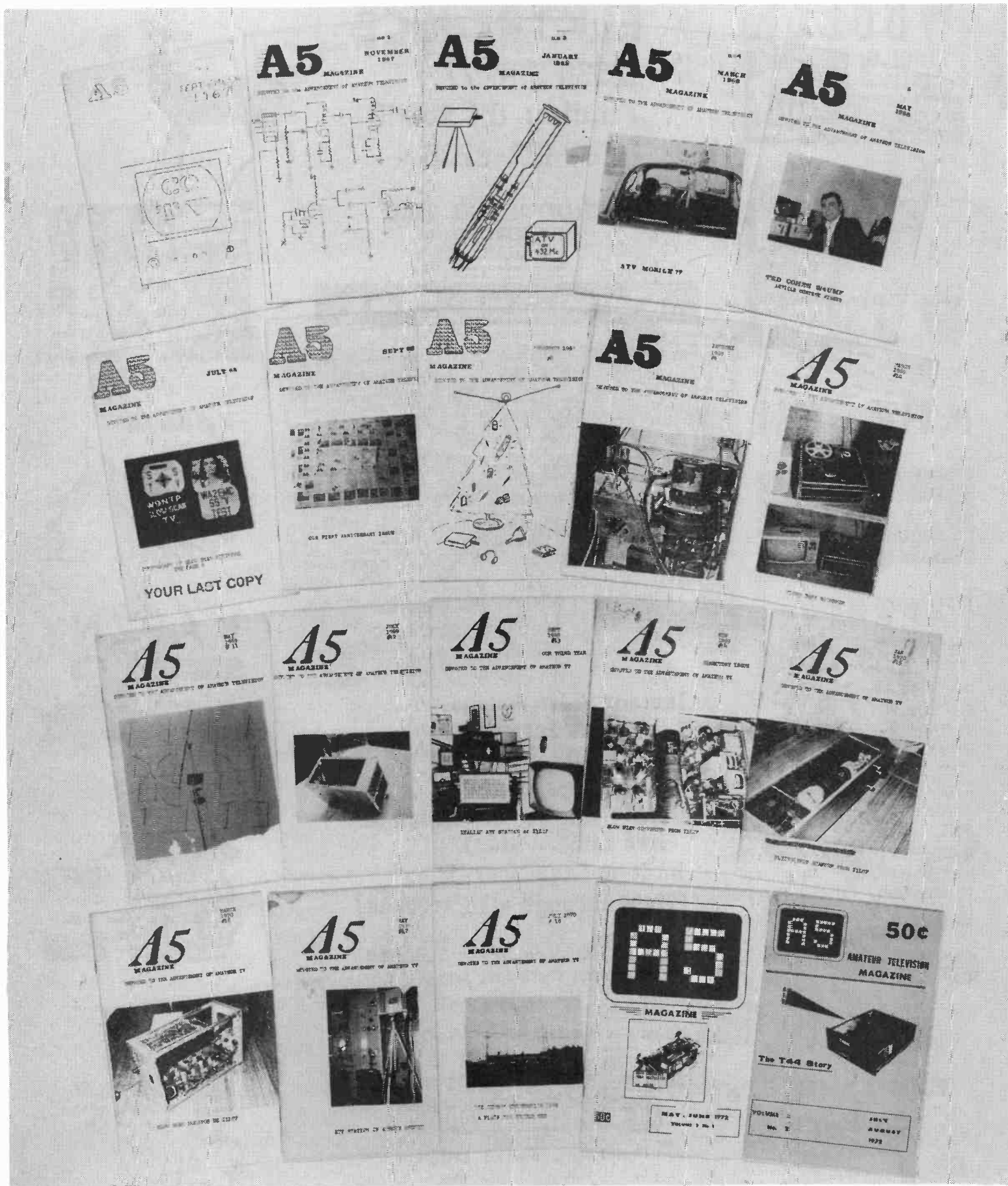

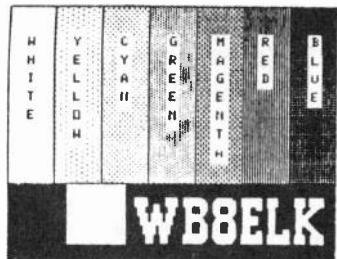

**KA0JAW**

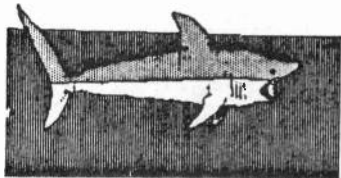

**N2CAI /r**

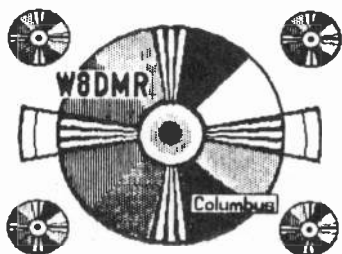

**KA8LWR**



IN BUCYRUS, OHIO

# ELKTRONICS

12536 T.R. 77  
Findlay, OH 45840  
(419) 422-8206



INTRODUCING THE

**VDG-1**

**VIDEO I.O.**

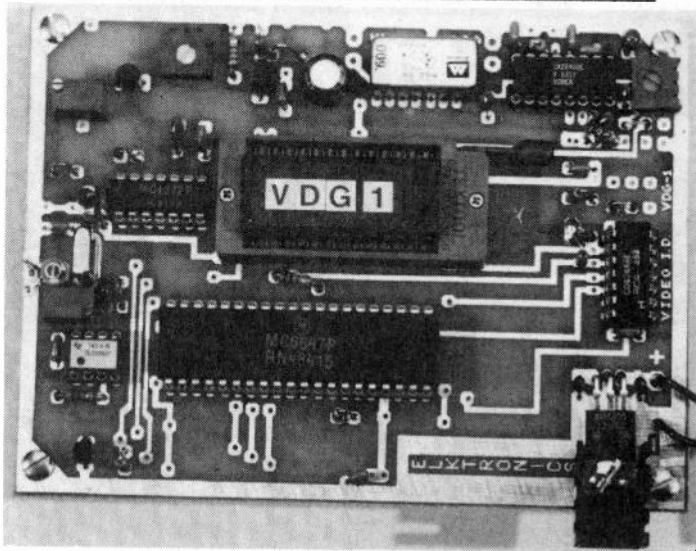

- Instant Video Source
- 4 Graphics Screens (2 Hi-RES / 2 Colorbar)
- 12 V D.C. Operation
- Video Relay for switching in live camera video
- Built-in Sequencer/Timer (Steps through all 4 screens)

VDG-1 with Pre-Programmed Custom Callsign Logo

- \$99 ppd.

(Quick-release socket option)

- \$10

**Call or Write for CATALOG of available Graphics**

Additional Programmed EPROMS

- \$19

Now available as a Kit

- \$89 ppd. Blank PCB - \$19



**KA8EEE**

Jim  
Marion Ohio



**KA8ZNY**

GROVEPORT



**KA8WLV**

WHERE NO ATV'ER HAS GONE BEFORE



# A PHOTO HISTORY OF ATV MAGAZINES

*Yet another pair of hams attempt to bring ATV out of obscurity.*

---

## A THIRD ATV PUBLICATION May 1972-April 1974

---

*With the popularity of SSTV rising quickly and three manufacturers producing SSTV equipment, ham TV was much better known by 1972. Although UHF operation was still not as simple and easy as today, at least you could buy cameras and equipment. SSTV was expensive to operate with special SSTV cameras and P-7 monitors, but work was afoot to generate solid state scan converters and new technology was present everywhere.*

In May 1972, almost two years after the demise of A5, Ron Cohen K3ZKO and Al Lipkin W3AEH made arrangements to restart A5. By the second issue this had changed to A5 Amateur Television Magazine although nearly everyone who remembers the issues first hand, it remained A5.

Ron and Al are ham buddies in Philadelphia. They spent a great deal of time to produce a publication which had a more professional look and feel. Layout and art work improved. Only 12 issues were published but it was much more widely known to hams than previous efforts. The issues even sported colored paper covers and grew to as much as 44 pages.

The issues were printed and assembled in the basement of their homes. The appearance improved much over previous efforts. Circulation increased as well as the inclusion of "high class" ads from major ham equipment manufacturers. We saw the debut of RPT Magazine in the July 1972 issue. The emphasis was on modifying commercial FM 2-way equipment to ATV operation. The Motorola T-44, RCA CMU 15, Link 2375, and GE hardware from FM surplus dealers made it cheap and easy to get on ATV. A few simple mods and the addition of a video modulator made most of these earlier radios video transmitters. Plus you had the built in NBFM sound capability of the original radio!

The first sync generator on a chip, Fairchild 3261, made its debut. This single chip saved building a lot of electronics just to generate horizontal and vertical sync signals and also allowed easy gen-locking of video sources for the first time.

On the SSTV scene were the first color SSTV transmissions using field sequential techniques. Robot equipment had dominated the market with more from Venus Electronics. Don Miller W9NTP and others were busy experimenting with different color SSTV systems including the Land 2 color system and beginning to talk about other scan rates and schemes including "medium scan" and "sampledot" both forerunners of telco tv efforts.

The September 1973 issue noted the formation of an

ATV club in Canada and another in Washington, D. C. The latter, started by Terry WB4JFI, Mike WB4DVD, Paul WB4KCM and Bruce WB4YTU, was destined to be a major player in the future of ham TV. Also a new source of surplus equipment was being provided by a small company in Michigan, Communications Unlimited. Together, Metrovision ATV Club and C. U.'s owner WB8HEE (now KB9FO) would later lead the ATV charge in Washington to save the fast scan mode from the ARRL and government efforts to banish it to oblivion!

---

## ATV POPULARITY WAS GROWING AND SO WERE ITS GROWING PAINS!

---

Power levels of some of the hardware started to become high enough that articles began to include warnings about the dangers of high voltage and UHF RF. It was now fairly common to use a 4CX250 or a pair in the K2RIW 440 MHz. design amplifier for ATV. This provided as much as 400 watts of video RF, more if you were brave enough to run the tubes to the limit. Printed was the concern for UHF energy being biologically harmful. Well, an RF burn always hurts! But the concern was also that just radiated power, either from the chassis or from the gain end of the array on the roof could be biologically harmful. Microwave ovens had just been invented which used the "water line" a resonant frequency of the molecule H<sub>2</sub>O to cause molecular excitation (heating) and thus cook food. This caused early concern about other frequencies. The main worry was the human eye and cranium were susceptible at 450 MHz.

Robert Suding W0LMD wrote of his digital SSTV converter in the March 1974 issue. Also a landmark in technology was featured on the front cover, WR4AAG, the first licensed fast scan in-band ATV repeater!

All the issues are pictured here, the first two on the previous page and the remainder on the following page.

Ron and Al also had booth or display space at ham-fests all over the east and midwest. This public showing of ATV increased awareness and popularity of the mode greatly. But this also caused concern in Newington as the FM mode began to take over the VHF-UHF bands. The political wars were about to start and ATV was the "cannon fodder" the League was going to use to promote FM mode.

Ron and Al ended their efforts with a very late March 1974 issue and the magazine might of ended there except for yet another ATV fan and equipment dealer, Henry Ruh WB8HEE (today KB9FO)!! FM and FM repeaters were growing and repeater sub bands had been created to carve out spectrum for FM mode users.

# A PHOTO HISTORY OF ATV MAGAZINES





## A PHOTO HISTORY OF ATV MAGAZINES

*During the early 70's the FM mode grew quickly. Efforts to organize and slow the growth were made by the ARRL and the FCC by ways of new regulations which restricted FM repeaters. During 1972 and 1973 several new rules were proposed and put in place which restricted repeaters. The thought was that only FM mode would use a repeater! In 1973 Henry Ruh WB8HEE (now KB9FO) and 10 others led by Wayne Green W2NSD assaulted the restrictive rules. This included testimony before the Commission in Washington The Rules were proposed and promoted by the ARRL who feared growth of FM would cause chaos, neglecting, as usual, that hams are self regulating, even though it wasn't easy. Repeater councils and coordination groups formed and eventually most of the growth problems were ironed out without the help of the ARRL or the FCC. Just hams trying to co-exist. But an out growth of this was also the idea that repeaters could be used for other modes including ATV! The end result was we finally got most of the repeater rules repealed and let self rule and common sense take over.*

---

### THE FOURTH ATV MAGAZINE January 1975-February 1985

---

*The publication of Amateur Television Magazine represented the longest continuous effort to produce an ATV only publication. It also provided a special interest group with yet another series of improvements in the quality of an ATV magazine and broke new ground in many areas.*

In December 1974, Henry Ruh WB8HEE, then a subscriber of and an advertiser in A5 Magazine was worried that there had not been an issue since March. Contacting the former owners proved that they had indeed ceased publication and yet another ATV publication had died. Henry made arrangements to meet Ron and Al in a Howard Johnson's restaurant in Pennsylvania. The result of that meeting was that Henry would start a new publication and gain the rights to the name A5, the use of the A5 Logo, and the mailing list. Also the typewriter and home made saddle stapler changed hands. Ron and Al would be listed as contributing editors but in fact the effort was all Henry's.

January brought the first issue which sported for the first time a glossy paper stock, and higher quality interior white stock. The cover featured a live photo of the WR4AAG ATV repeater with Bruce Brown WB4YTU, Terry Fox WB4JFI repeater builders. Subscribers of the defunct A5 were informed that their subscriptions would be honored even though none of the funds were available to the new publisher. The magazine was funded by Henry's electronic store business but this didn't last long as the recession soon forced the doors closed at CU. The lack of income the first year was particularly hard since there were also nearly no renewals, only some new subscriptions and the financial base was eliminated by May of 1975.

The new publication almost died again at that point but Henry went back to work in Broadcasting, first in Los Angeles, then Topeka, then Bloomington, IN. The magazine had sported new efforts to make it more viable as an entity in and of itself. These included a cartoonist who added humor to the publication from Henry's ideas, and an effort to remain at about 50 pages per issue on good paper stock. The last two issues of the year were printed and mailed at almost the same time and did not represent as good an effort as earlier issues of the year. But circulation was rising, and a lower cost printer had been found in Topeka.

---

*The early days of "desk top" publishing were hard. There were no cheap home computers, printers or word processor programs. Everything was typed by hand, many times over, in an attempt to rid as many typographical and spelling errors as possible. But still many got through. Typing 50 pages several times per issue was not fun.*

---

Everything came back together in early 1976. Mailing was done by hand until the subscription list had grown to over 1000 at which time a commercial mailer was given the job. By November 1976 subscriptions had grown to 1699 and total circulation to 2100 per issue. Renewals and new advertisers had brought needed cash flow to the magazine and by January 1977 the personal subsidy of its financial operations had decreased to an annual tide it through level. Subscriptions were concentrated at the beginning of the year and there were not enough renewals for the last three issues to have a positive cash flow year round.

1976 Also started a couple of significant points in ham radio history. The preparations for the 1980 WARC were begun and Henry took active participation in the Washington, D. C. meetings. At the same time the FCC/ARRL were trying to eliminate ATV by rules changes at the same time that Bruce Brown was operating his ATV repeater on a continuing series of STA's.



*You can never tell where Henry and ATV will show up. Here he is at the 1990 NAB convention with a couple of "public figures"!*

# A PHOTO HISTORY OF ATV MAGAZINES

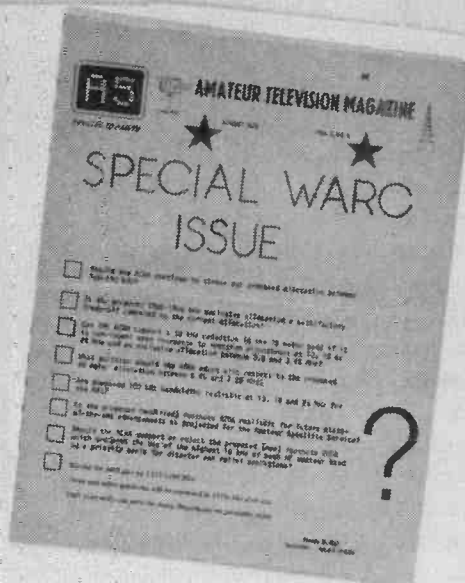
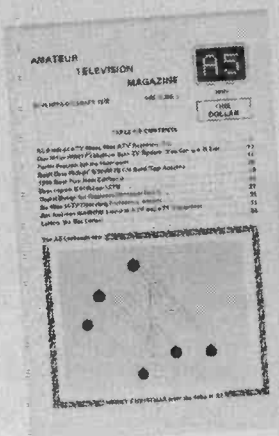
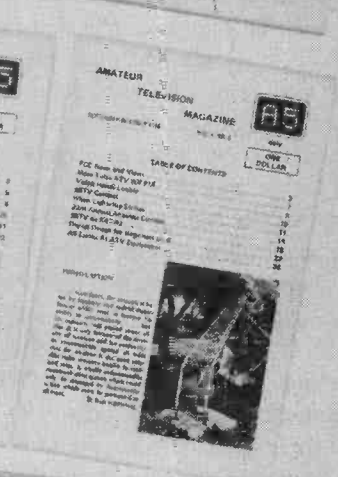
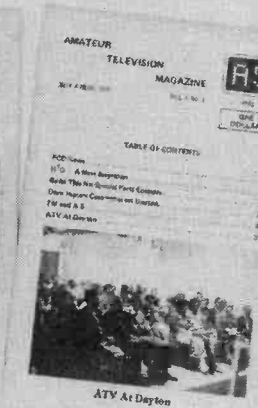
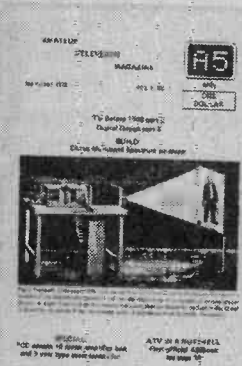
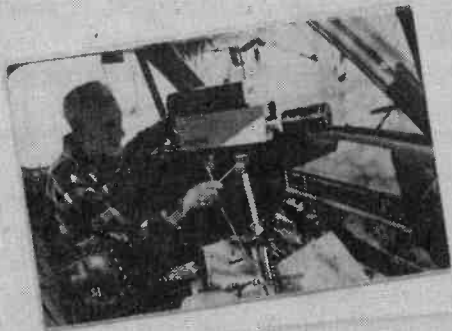
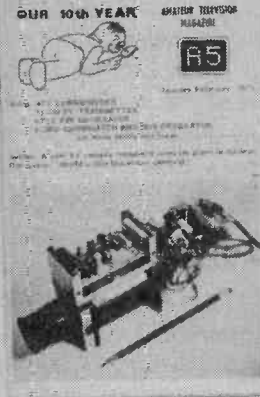
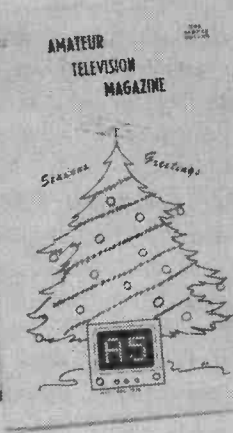

## A PHOTO HISTORY OF ATV PUBLICATIONS

*Various forces came together in the late 1970's which allowed ATV to continue in the 450 MHz. band, allowed ATV repeaters to be permitted in the 450 MHz. band and above, and showed that ATV was alive and well and helped retain and gain UHF spectrum in the 1980 WARC effort.*

Near constant efforts were made to achieve three objectives: A) get the FCC to change the rules so that an ATV repeater could be built and operated in the 420-450 MHz. band anywhere in the country; B) prevent the ARRL/FCC from passing docket 20777 which would have eliminated ATV operations from the 450 MHz. band by bandwidth restrictions to only 35 KHz. maximum and; C) make a convincing argument that the ham bands should be saved from commercial interests, especially the 450 Mhz band.

As history has shown, we did it! Not only did we not lose the 450 MHz. band, except for the A Line along the Canadian border, but we gained the 900 MHz. band, got three new HF bands, although there were losses in the SHF and microwave spectrum. Being a presence in Washington and having a reasonably decent magazine helped form an image of strength in numbers before the FCC and ARRL, who relied in part on ATV activity to justify the continuation of the 30 MHz. allocation at 420 MHz.

After some real knock-down battles between the various parties, ARRL, FCC, Bruce Brown, Metrovision, Henry Ruh, Amateur Television Magazine, we got the rules changed to allow ATV repeaters in-band on 420-450 MHz. A permanent rules change allowed ATV repeaters to operate outside of the allocated FM repeater sub-bands but not within the CW or weak signal sub-bands, or by local coordination efforts which were recognized to pre-exist in some instances, especially in southern California where ATV operated on 434 MHz.

The covers of these issues are shown on the adjacent pages.

The magazine continued in the small format until a special WARC issue was printed in August 1978. But full color had arrived with the July 1977 issue, showing the inside of the WB9WWM (now KB9FO) ATV mobile operation. Again a full color cover to show full color SSTV came with the January 1978 issue.

Coverage now was good in both ATV and SSTV areas. Emphasis was still on build it projects and a regular SSTV column by Dave Ingram K4TWJ began. Dave would go on to write many ham technical books for TAB as well as for other, bigger magazines in the years to come.

A fully type-set issue made things look good and material on many subjects was pouring in. All in all it seemed the age of ATV had begun. Amateur Television Magazine switched to the larger 8 x 11 inch format with the January 1979 issue. This provided much more room for diagrams, and the old method of typing on an 8 x 11 page then having it reduced to fit the 8.5 x 5.5 page was eliminated making reading a lot easier.

The magazine continued to grown in size and circulation as time passed and actually began to show a positive cash flow and modest profit which must have been a landmark in itself for ATV publications.

In 1979 a new SSTV'er, Mike Stone WB0QCD stopped by after a hamfest held in Bloomington, IN. He was mostly curious about the aluminum "Christmas Tree" on a 100' tower in the yard of WB9WWM/KB9FO that had among many other antennas: 4, 48 element J-Beam 450 MHz. antennas! Mike was a general class ham and had worked a little slow scan on 10 meters. He was shown the ATV shack of Henry's which was well equipped at the time with broadcast equipment. Mike would later begin to make regular contributions to the magazine on the topic of SSTV.

March 1980 issue of Amateur Television Magazine sported a full color cover, and for the first time a full color ad, part of a two page spread by Robot to announce their new 800 SSTV system. Mike WB0QCD also started as a regular SSTV column writer. Dave K4TWJ was also an SSTV column writer for this issue!

---

### AWARDS FOR ATV OPERATORS

---

Under Henry's editorial and publisher guidance, the magazine also was providing recognition to efforts by ATV'ers. It started with a story about Warren Weldon W5DFU's weather watching tower mounted camera and his ATV link to the National Weather Service in Tulsa, OK. This was sent to the White House. Jimmy Carter, President of the United States responded with a letter to Warren commending him on his efforts.

Having inherited some old pull-out image orthicon tubes I came up with the idea of a Good Image Award for public service. This became an annual award with the first going to Warren Weldon. Other recipients included the JPL for its N6V Viking probe video of Mars ATV/SSTV efforts.

---

*All the awards were to promote ATV activity, home construction and public service. Three areas still promoted by ATVQ today.*

---

Another award was the Master Scanner award. It was a nice desk top plaque for outstanding technical articles published during the year.

The first was awarded to Takao Yabana JA0BZC for his \$100 solid state SSTV scan converter.

Also offered was the SSTV operator of the year. The first recipient was Dave Guthrie 5N0DOG of Logos, Nigeria. Dave later returned to the USA.

# ANTENNAS by

# Lindsay

**Amateur TV Repeater, Verticals and Yagis Transmit & Receive Antennas**

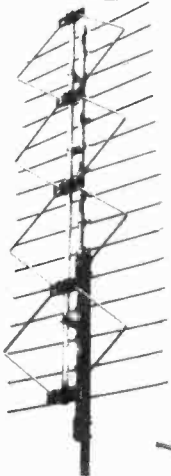

4ZZ-420

AC-144

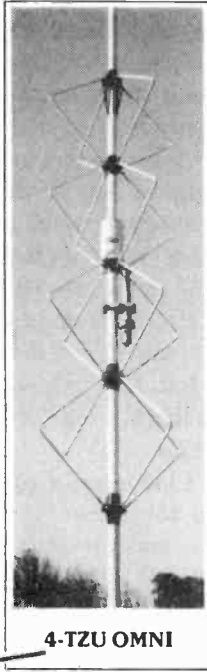

4-TZU OMNI

ATV-8 SLOT

**LPTV & MMDS Transmit & Receive Antennas**

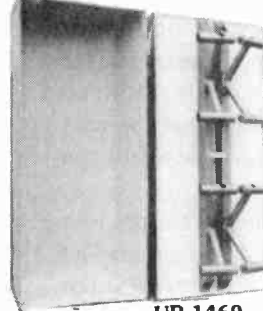

UP-1469

LS4  
LS8  
LS16  
SLOT

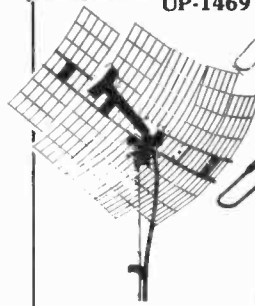

MDG-2717

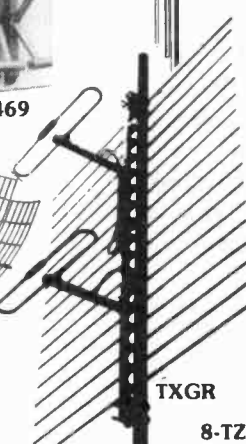

TXGR

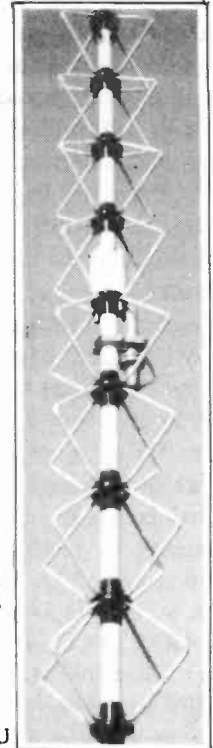

8-TZU

**Cable TV & SMATV Headend Yagis, Log Periodics, Pre Amps and CLI Antennas**

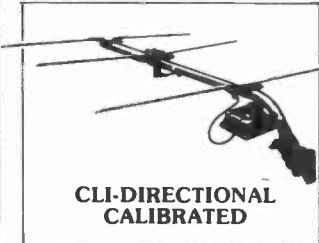

CLI-DIRECTIONAL CALIBRATED

ZIG-ZAG SERIES

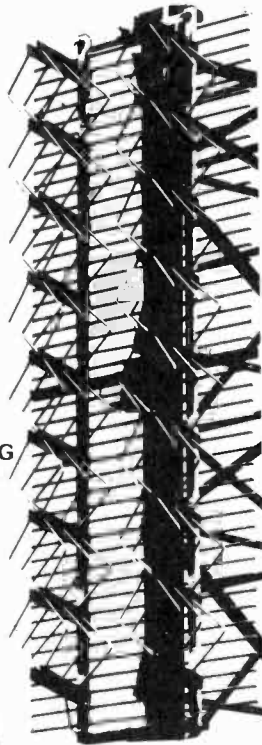

**'FREE' SITE SURVEYS UPON REQUEST ...**

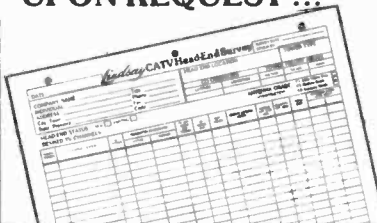

**Commercial 2 Way Cellular Base Station and STL Antennas**

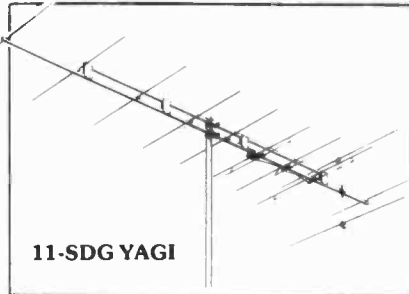

11-SDG YAGI

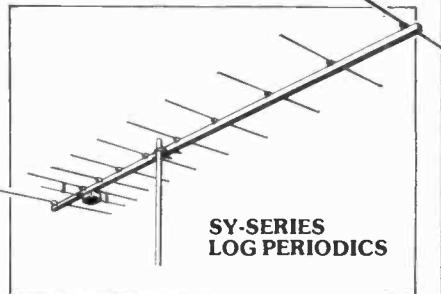

SY-SERIES LOG PERIODICS

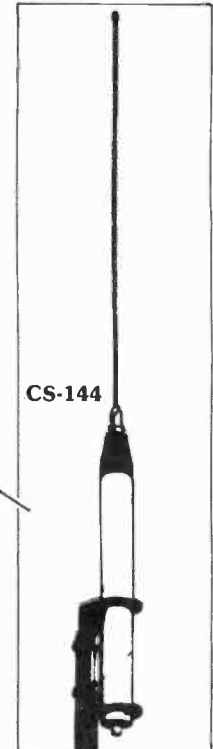

CS-144

**DEALERS AND DISTRIBUTORS WANTED WORLDWIDE**

**LINDSAY SPECIALTY PRODUCTS**

50 Mary Street, Lindsay, Ontario, Canada K9V 4S7

Telephone: (705) 324-2196

Fax: 705-324-5474

# A PHOTO HISTORY OF ATV MAGAZINES

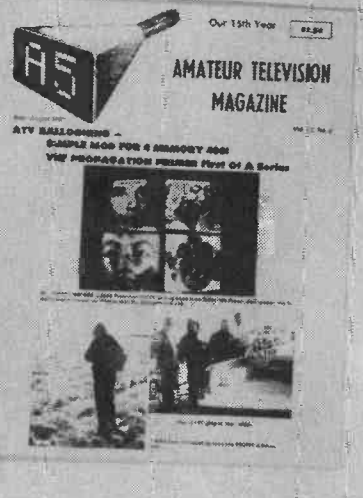
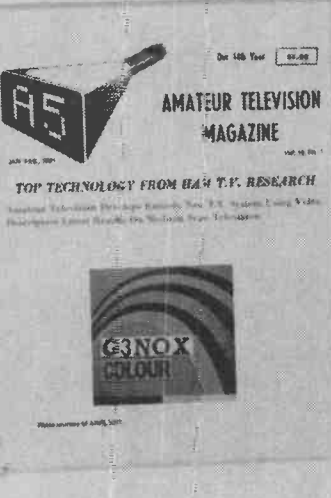
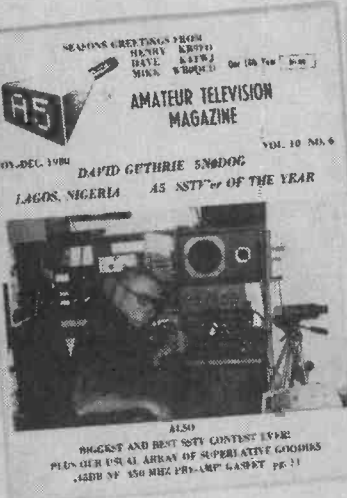
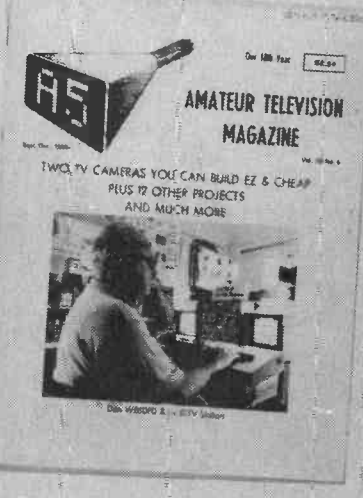
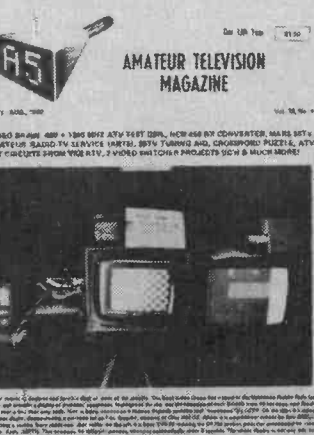
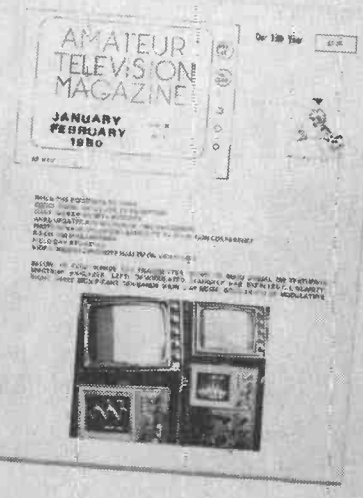

# A PHOTO HISTORY OF ATV MAGAZINES



FOR SALE: CVS/Harris Time Base Corrector. Model 520. Works with VHS, Beta, 8mm, 3/4", 1", consumer or broadcast. 16 line/infinite window (line, H or V lock) pull proc amp controls, lots of capability. \$1200. Also: JVC Industrial VHS duplicator, 2 hr, 6 hr modes, stereo audio, rack mountable (included) record/play, with timer, TV tuner etc.

\$100. Also: Tektronics 602 "video display" scope. Use as X-Y, vectorscope (with R-y, B-y inputs) or general purpose. Works great as spectrum analyzer display with Science Workshop kit. \$250. All available at ATVQ booth 338, 339, Dayton if not sold earlier.

## A PHOTO HISTORY OF ATV MAGAZINES

*In the summer of 1981, Amateur Television Magazine was sold to Mike Stone WB0QCD. The magazine had managed to show a modest profit and life's challenges were increasing for Henry as he quit his 6 year long job at Indiana University in order to seek fortune as a broadcasting consulting engineer and build his own FM broadcast radio station. With an increase in family responsibility with wife and son, and the increased demands of self employment, time for ham radio and the publication grew shorter and shorter. The decision to sell the business to Mike would later turn out to be the nadir of ham TV, but for a while it helped ATV and was the only alternative to ending yet another good ATV magazine venture, albeit on the upside for once.*

With a publisher who had little else to do but promote the magazine and operate HAM TV, the magazine grew as expected. In 1982, as the FCC announced it would accept a rules change proposed by Henry Ruh KB9FO to allow SSTV in the general class portion of all HF bands, the magazine went to monthly publication. This was also in part necessary to support its publisher who had quit regular employment and was trying for the first time, to make a living off the income derived from an ATV publication.

The extra issues per year meant more advertising dollars per year, although partially eroded by mailing and printing costs. The publisher also began to offer a lot of subsidiary items, computer programs, SSTV audio cassette tapes, video tapes and booklets of collections of past ATV Magazine articles. These anthologies provided additional income and the extra work involved could have only been done by someone with nothing else to do.

Earlier issues under Henry had provided a complete TVRO series, way before any other magazine printed a word about satellite TV. Likewise, in 1982 and 1983 a new series of build it yourself TVRO articles appeared before the other media bothered with the subject.

Feeling the economic pinch of supporting his family, his ATV repeater, his ham radio hobby and publishing a monthly magazine, Mike came up with the marketing ploy of forming the USATVS. In January of 1983 it was cover material for the issue. Representatives were appointed by Mike, and some never knew it until they read about it in the magazine. The multi-page promotions began early and continued, espousing the virtues of this one man society and marketing arm of the magazine.

By 1984 the publication got farther and farther away from ATV/SSTV with articles on FAX, RTTY, satellite/OSCAR, and other modes. The creation and promotion and production of thousands of "Hamfest" board games was the economic turning point for the publication. Facing a huge inventory of the slow selling item, the pressure was on to make money with the publication. Expanded sales pitches for "USATVS buying service" and computer programs, tapes, cassettes etc. filled the pages. The amount of ATV material decreased and the other topics began to take over.

The last issue of Amateur Television Magazine was February 1985. The next issue was titled Spec-Com. It was explained that it would be a magazine to cover many special interest communications modes. Thus ended yet another ATV Magazine.

### A VERY FEW WORDS ABOUT SPEC-COM

Enough said.

In early 1988 Bill WB8ELK and Henry KB9FO were contacted by several ATV'ers, a couple of ham radio magazine editors and some ATV equipment manufacturers asking if they would *please* start another ATV publication. Only after meeting for the first time at Dayton 1988 did ATVQ take form.



*This is an off the air picture of air to air ATV. Henry KB9FO is flying the Cessna pictured. Tom W6ORG is flying a Piper nearby. The video is from Tom's ATV transmitter as received by Henry's ATV receiver in N11578. The reverse was also done for a complete 2-way ATV aircraft to aircraft QSO. Later Henry changed the Tail number of the Cessna to N73TV, for obvious reasons!*

# A PHOTO HISTORY OF ATV MAGAZINES

COVER FEBRUARY 1984 VOL. 13 NO. 2 PUBLISHED MONTHLY \$3.00

**SPACE SHUTTLE!**  
RETURNING UNDO JPL CALIFORNIA METROV LIVES AND COLOR INTO ACTING SYSTEMS CABIN VIDEOS TO BE AT YEAR END SPECIAL LINEAR!

TELEVISION  
SPACE 9  
LINEAR 44

FEBRUARY 1984 VOL. 13 NO. 2 PUBLISHED MONTHLY \$3.00

**FCC SAYS 'NO' TO NO-CO-ORDINATED SHUTTLE COLLECTIVE TESTS MISSION SPEC DON HIRSH VENDOR PURCHASES SILVER-HALL ELECTRONICS**

1000 Components  
1/2000 Special Reporting  
4770 Reporting  
4770 Reporting  
4770 Reporting  
4770 Reporting  
4770 Reporting  
4770 Reporting  
4770 Reporting  
4770 Reporting  
4770 Reporting

MARCH 1984 VOL. 13 NO. 3 PUBLISHED MONTHLY \$3.00

**NEW 'UNITED STATES'**  
BY JIM MORGAN. TO BE MISSING FROM COMING TO CHARLOTTE, N.C. SPECIAL ISSUE

APRIL 1984 VOL. 13 NO. 4 PUBLISHED MONTHLY \$3.00

**SEVERAL NEW SSTV/SSV/FAX SYSTEMS TO BE IN AMATEUR RADIO GEOS 2'S VERY OWN GAME DAYTON SPECIAL ISSUE**

MAY 1984 VOL. 13 NO. 5 PUBLISHED MONTHLY \$3.00

**ATV IS ALIVE AND WELL IN NORTH AND SOUTH CAROLINA FIRST TRANSATLANTIC 'FAX' DX PICTURES EXCHANGED! NEW ATLAS/AMATEUR 4500 VIDEO PRINTER REVOLUTIONIZES SOCIETY**

JUNE 1984 VOL. 14 NO. 6 PUBLISHED MONTHLY \$3.00

**DAYTON 84 DAZZLES WITH NEW ATV/SSV NEW SSTV/SSV SYSTEMS REQUEST FOR COMMENT ROBERT RESEARCH, INC. DISPLAYS ANVY 2700C V COMPUTER EXPRESSED OVER ICORN 2700 MHz BAND 1**

JULY 1984 VOL. 14 NO. 7 PUBLISHED MONTHLY \$3.00

**HAM-TV ENJOYS 51 TV STATIONS READY FOR AUGUST 67MHz COMPLETES 1150 TEST OF 130-150 MHz BAND 1**

AUGUST 1984 VOL. 14 NO. 8 PUBLISHED MONTHLY \$3.00

**FALL 1984 AS/USATVS NATIONAL CONFERENCE TO BE AT FORT COMBES IN CALIFORNIA 1300 1100 MHz, AND 4500MHz 100MHz BAND 1100 MHz BAND 1**

SEPTEMBER 1984 VOL. 14 NO. 9 PUBLISHED MONTHLY \$3.00

**FCC APPROVES DOCKET 82-83 ON EXPANSION OF 43.7MHz (GENERAL ADVANCED DATA CLASS SSTV BY NEW UNITED ON 43.7MHz) 100MHz BAND 1100 MHz BAND 1**

OCTOBER 1984 VOL. 14 NO. 10 PUBLISHED MONTHLY \$3.00

**SPECIAL 10TH ANNIVERSARY (SSTV) 100MHz BAND 1100 MHz BAND 1**

DECEMBER 1984 VOL. 14 NO. 12 PUBLISHED MONTHLY \$3.00

**WDFW 900 & 1300 MHz BAND 1 HOUR SPECIAL 'MAGAZINE' UNDO VIDEOS TRANSANTS ENTIRE AMATEUR, 9**

NOVEMBER 1984 VOL. 14 NO. 11 PUBLISHED MONTHLY \$3.00

**SPACE SHUTTLE 51-B 100MHz BAND 1100 MHz BAND 1**

DECEMBER 1984 VOL. 14 NO. 12 PUBLISHED MONTHLY \$3.00

**HOLIDAY GREETINGS FROM TV 100MHz BAND 1100 MHz BAND 1**

JANUARY 1985 VOL. 15 NO. 1 PUBLISHED MONTHLY \$3.00

**SSTV SPACEFLIGHT SHUTTLE TO CARRY SSTV REPEATERS 1300 1100 MHz, BAND 1100 MHz BAND 1**

FEBRUARY 1985 VOL. 15 NO. 2 PUBLISHED MONTHLY \$3.00

**SPECIAL EFFECTS FOR AMATEUR - TVI 100MHz BAND 1100 MHz BAND 1**



# A PHOTO HISTORY OF ATV MAGAZINES

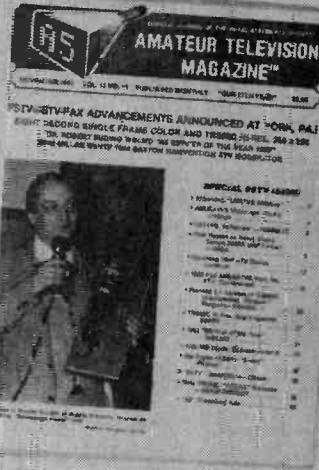
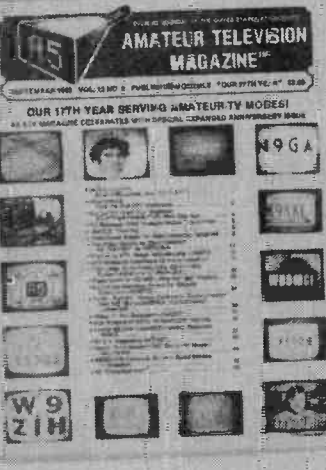
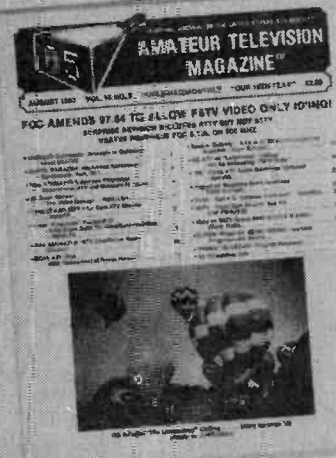
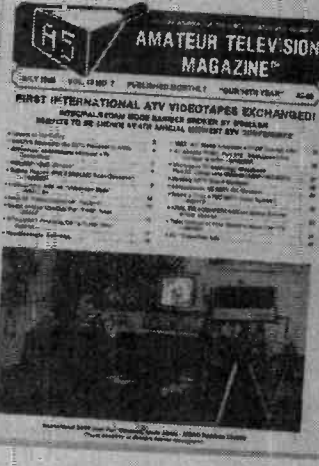
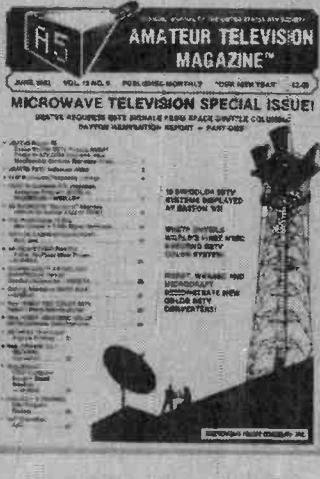
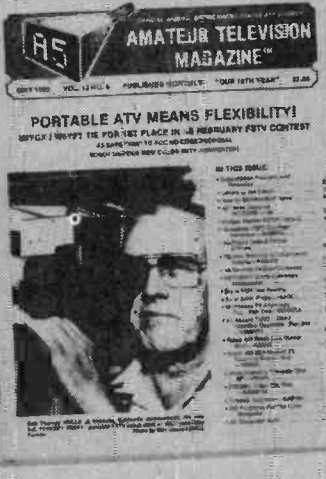

# A PHOTO HISTORY OF ATV MAGAZINES

1971.06  
**AMATEUR TELEVISION QUARTERLY**  
 VOL. 1.12



SUMMER 88  
**AMATEUR TELEVISION QUARTERLY**  
 VOL. 2.12

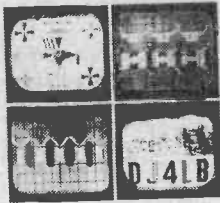

JANUARY 1982  
**AMATEUR TELEVISION QUARTERLY**  
 Devoted Entirely to Amateur Television  
 VOL. 2.17 80 Pages

PUBLIC SERVICE ATV TO BE SEEN WORLD WIDE - LIVE - JANUARY 2 ON 3  
 PLUS PAGES OF OPERATING NEWS, NUMEROUS TECHNICAL ARTICLES & MORE

83.95  
**AMATEUR TELEVISION QUARTERLY**  
 DEVOTED ENTIRELY TO AMATEUR TELEVISION

92 204

**AMATEUR TELEVISION QUARTERLY**  
 DEVOTED ENTIRELY TO AMATEUR TELEVISION

**AMATEUR TELEVISION QUARTERLY**  
 DEVOTED ENTIRELY TO AMATEUR TELEVISION

HOME VIDEO CONTEST WIN NEWEST ICOM TRANSCEIVER  
 Details page 37

HOME VIDEO CONTEST WIN NEWEST ICOM TRANSCEIVER  
**AMATEUR TELEVISION QUARTERLY**  
 DEVOTED ENTIRELY TO AMATEUR TELEVISION

83.95  
**AMATEUR TELEVISION QUARTERLY**  
 DEVOTED ENTIRELY TO AMATEUR TELEVISION

**AMATEUR TELEVISION QUARTERLY**  
 DEVOTED ENTIRELY TO AMATEUR TELEVISION

ANOTHER 100+ PAGE ISSUE WITH MORE TECHNIQUE AND BUILD PROJECTS THAN 4 OUT OF 3 HAM MAGAZINES!

83.95  
**AMATEUR TELEVISION QUARTERLY**  
 DEVOTED ENTIRELY TO AMATEUR TELEVISION

HAM RADIO IS ...

... MORE THAN RADIOS -- EXCLUSIVE STORY PAGE!

83.95  
**AMATEUR TELEVISION QUARTERLY**  
 DEVOTED ENTIRELY TO AMATEUR TELEVISION

Ham Radio TV Programs On Satellite TV Channels  
 H.M. 73 - Effort to save Ham Frequencies  
 J.G.T.A. ATV  
 Much more

## A PHOTO HISTORY OF ATV MAGAZINES

*A new ATV publication, Amateur Television Quarterly Magazine, was born in 1988. A group of ATV'ers, manufacturers and other interested persons spoke informally throughout the Dayton hamfest. The result was the formation of ATVQ by Bill WB8ELK and Henry KB9FO, in July of 1988. Our goal was and is today, to provide a high quality technical publication for ATV.*

### ATVQ, AMATEUR TELEVISION QUARTERLY MAGAZINE

#### THE FIFTH ATV MAGAZINE

July 1988

The first issues of ATVQ as the magazine quickly became to be known were published in the latter half of 1988. Issues were called Summer and Fall 1988 (Volume 1 #'s 1 & 2). Only a limited number of copies of each were printed and they were done as an announcement of a new effort to bring out a new ATV magazine. Proud owners can claim a first edition! These two starter issues were small format and only had a few articles each. Just enough to raise the issue of whether anyone had an interest in an ATV only magazine.

The response was a tidal wave of positive response. Advertisers quickly responded and subscriptions sold briskly. I had remembered the older FM mode magazines, FM, RPT, and others who had a much larger operator base, but couldn't attract enough subscribers. We were blessed with the immediate supply of complete sales lists from advertisers, ATV club rosters, and Bill and I went through our log books to make a mass mailing list. When done we had collected over 3500 known ATV'ers. This has since grown as more clubs sent in their entire membership rosters and requesting sample copies be sent to members.

And as they say, the rest is history! Pictured are the covers of all issues to date. Among other highlights, every issue has had a full color cover, many interior pages have been full color and we recently changed from newsprint to white stock for interior pages. Each issue has had improvements including changes in layout, photo work, and editing. The paid staff has grown to include regular typists to enter the contributed articles, a sales manager Pamela Dass formerly of 73 Magazine, and Dave Williams WB0ZJP as photo editor.

ATVQ has had full color centerfolds for the April issues, and a concentration of high quality technical material from a number of sources. But the best has yet to come.

The growth and expansion of ATVQ, which included issues of 104 pages, 96 pages, also takes its toll in eating up material. ATVQ has budgeted on a 68 page format and is constantly on the search for new material. In case you didn't notice, ATVQ pays for technical articles! You also get the satisfaction of being published in the LEADING ATV magazine in the world! ATVQ's high quality full color issues inspire news stand sales at electronics outlets. These single copy sales generate new awareness and good images of ham TV operation. Our phone line message system 708 298 2269, helps ATVQ respond to readers inquiries and keep in touch with the ATV world.

#### PROMOTING ONLY A POSITIVE IMAGE FOR ATV AND HAM RADIO

Our ads in Tune In the World, 73, and previously in Ham Radio and CQ Magazine are a constant source of information to attract new ATV'ers. Not to forget great word-of-mouth by our loyal readers!

In case you hadn't noticed, Bill and I have now been to 49 states, 6 provinces in Canada and 5 foreign countries gathering ATV activity news and promoting ATV activity.

Of course, we invite you to visit our double booth at Dayton, #338, 339, and the Friday night ATV Party and Home Brew contest at the Holiday Inn and the Saturday night ATV party at the Rodeway Inn, just south of I-70/I-75 jct.

And despite the slings and arrows of outrageous editorials and distortions in Spec Com, ATVQ continues to grow, prosper and provide a positive image for ham TV and Ham Radio.

---

#### WRITE FOR THE LEADER, ATVQ! SEND IN YOUR ARTICLES AND NEWS TODAY!

---

Nothing beats being #1. Here at ATVQ we value your input. Its only by meeting our customers expectations in quality, content, value, and accuracy, that we will continue to be #1. We listen to our readers and have made improvements and changes in response to that input. We want your comments and articles, news and ideas. ATVQ is YOUR magazine and will reflect the desires of its readers. Your help and participation as a reader, contributor or promoter is what makes ATVQ as good as it is and will make it even better with each issue.

Our thanks to everyone that contributed to ATVQ's progress and success over the past three years. We appreciate your continued support for the years ahead.

Bill WB8ELK and I do ATVQ because of our love for the Ham Radio hobby and especially ham TV. We both work full time jobs, Bill as editor of 73 Magazine and I as engineering manager for the world's largest video duplicator (100 million + copies a year!). A good portion of our spare "ham time" is used to put together each issue, service subscriptions and advertisers. We are happy to do this at no pay as a service to our ham radio hobby which has enriched our lives and family. We do this for the fun. Let us keep it that way.

# INTRODUCING 'S NEW ATV SYSTEM



**A**dd a new dimension to your amateur radio communications with AEA's Amateur Television (ATV) system. If you hold at least a technician-class license, you can transmit and receive live or taped audio and video Fast-Scan TV (FSTV) information that rivals broadcast quality. Now you can share more than conversation over the air with this new mode of "personal communications."

## It's Easy and Inexpensive.

If you have a video camera or camcorder and a standard TV set, you may already own the most expensive components of an ATV system. AEA's ATV system includes a transceiver and antenna. Simply connect the camera, TV and the antenna to the transceiver, and you're on the air LIVE with one watt P.E.P.! Your TV set will

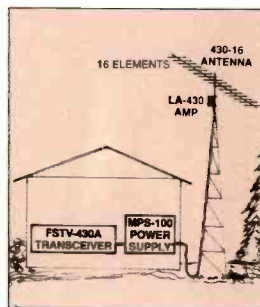

monitor your transmitted and received pictures. If you want to broadcast with more power, AEA also offers a 50 watt mast-mounted linear amplifier with power supply.

**The FSTV-430A Transceiver** features a low-noise UHF GaAsFET preamp with a typical noise figure of less than 1.5dB and a crystal-controlled or variable tuning down converter. Output is available on channel 3 or 4 for signal reception AND monitoring transmissions. Two frequencies can be selected from the front panel for transmission (one crystal is included). The AEA design is also optimized for superior video and audio quality without sync buzz even with weak signals. The FSTV-430A is the only transceiver you need to work ATV and it also allows you to use the same TV set to monitor your transmitted and received pictures.

**The LA-430/50 Amplifier with Power Supply** gives a boost to your ATV signal. It includes a 50W P.E.P. mast-mounted Linear Amplifier (patent pending) covering 420 to 450 MHz and a GaAsFET preamp which utilize the antenna feedline for DC power. The mast-mount eliminates the line loss between the amplifier/preamplifier and the antenna to improve both transmission and reception, and is the equivalent of a 100W amplifier in the shack with a 3dB line loss. The amplifier is housed in a weather-resistant alodized aluminum case. The MPS-100 power supply also provides a 13.6 volt output for the FSTV-430A.

**The 430-16 Antenna** is a high-performance, computer-optimized yagi specifically designed for ATV operation. It features broadband frequency coverage from 420 to 440 MHz, 14.3dB gain, O-ring sealed connectors, 28 degree E plane and 32 degree H plane beam widths and 16 elements on a 10-foot boom.

**See AEA's FSTV System** at your local authorized AEA dealer. Put yourself in the ATV picture and join the fun!



## What is the advantage of Vestigial Sideband (VSB)?

AEA's FSTV-430A Vestigial Sideband operation drastically reduces adjacent-channel interference. VSB requires much less bandwidth than existing double-sideband designs; it's the standard method of modulation required by the FCC for all U.S. broadcast TV stations. Similar in principle to SSB, VSB puts all of the audio energy and most of the video in ONE sideband instead of two. Using about half the spectrum space of competitive units, the FSTV-430A is the ONLY ATV unit that conserves spectrum space by using VSB. Even with AEA's LA-430/50 amplifier, one sideband is reduced more than 30dB. VSB presents an obvious advantage to the bandwidth-conscious ATV operator.

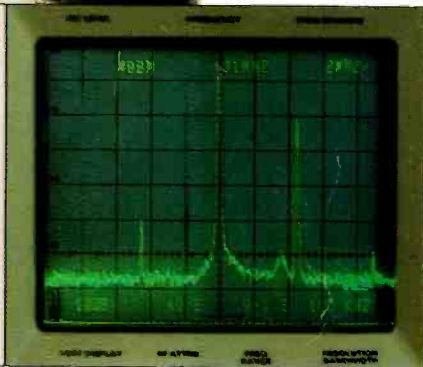

## Advanced Electronic Applications, Inc.

2006-196th St. SW/P.O. Box 2160 Lynnwood, WA 98036 206-775-7373

Prices and specifications subject to change without notice or obligation.  
Dealer inquiries invited. Copyright 1989.

**AEA Brings You  
A Better Experience.**