

**HOME VIDEO CONTEST  
WIN NEWEST ICOM TRANSCEIVER**

**\$3.95**

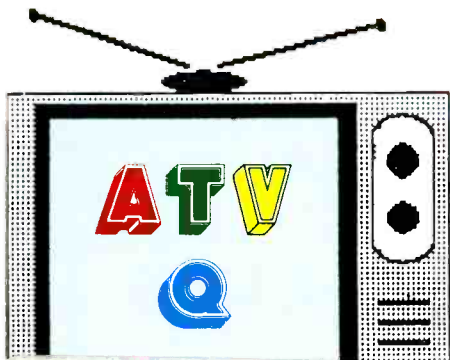

EXPIRES: V3 #4  
AJ2X Mark R. Nelson  
17 Wentworth Rd.  
Natick MA 01760  
USA

# AMATEUR TELEVISION QUARTERLY

JANUARY 1990

VOL. 3 #1  
ISSN: 1042-198X  
USPS 003-353

DEVOTED ENTIRELY TO AMATEUR TELEVISION



**Bill Pilgrim VE3GKC**  
one of the builders of the  
439-25/1253.25 ATV RPT, London, Ont.



**Kenny, WB5JLZ,**  
B.R.A.T.S. President, shown here at remote camera and  
transmitter atop LA State Capitol which is 460 ft. high.

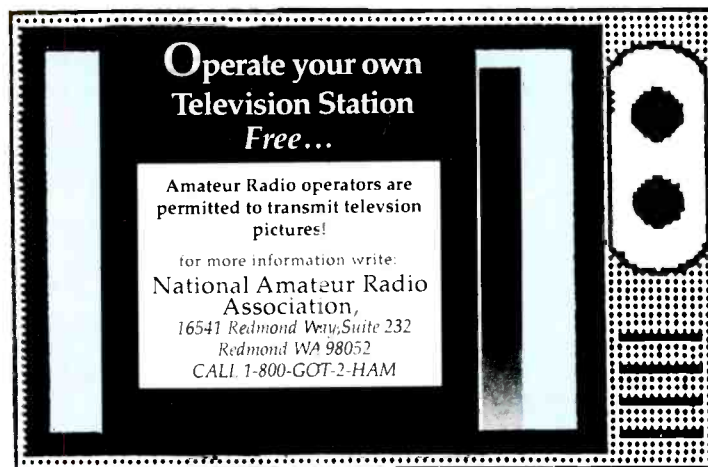

**NARA ADS  
PROMOTE HAM TV**

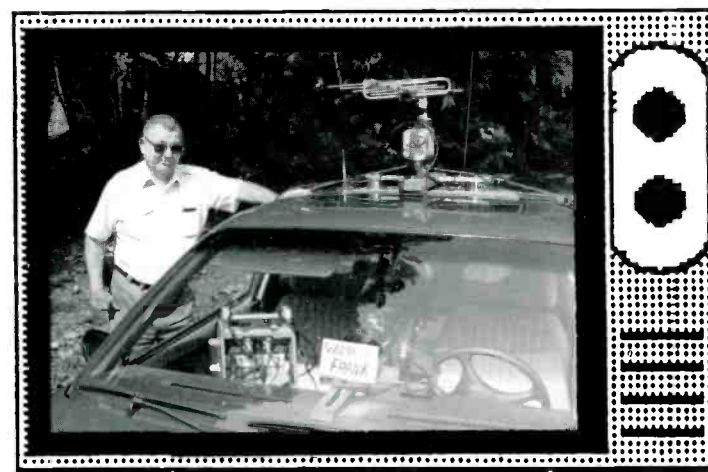

**Frank, WB9KCC,**  
with his Mobile ATV Seismic Station.

# WESTERN WASHINGTON AMATEUR TELEVISION SOCIETY AND AMATEUR TELEVISION QUARTERLY

## AMATEUR TELEVISION VIDEO TAPE CONTEST

--- first prize: ICOM IC 1275 1.2 Ghz ALL MODE TRANSCEIVER\* ---

--- second prize: AEA FS430 ATV TRANSCEIVER ---

third prize: PC Electronics RX converter of your choice

**20! additional prizes to be announced**

Have we gotten your interest? Are we motivating you? GOOD!  
All you have to do is make a VIDEO about ham radio using your home VHS/Beta or 8mm video equipment!

### RULES OF THE CONTEST

All licensed amateur radio operators are eligible to win except members and families of the Western Washington Amateur Television Society (WWATS), Amateur Television Quarterly Magazine (ATVQ), or publishers or staff of any other ham radio magazine. That leaves about a half million US hams and any other ham in the world!

Your video tape should be about ham radio (any aspect) and have been made since May 1988. The tape must not exceed 15 minutes in length. You cannot use professional video equipment (3/4", 1") in your production chain, only consumer grade equipment: ie S-VHS, VHS, Beta, 8mm, Super Beta, etc.

Only one entry per licensed amateur please. Video must be amateur radio related and can be a documentary, educational, technical or entertainment.

Entries will be judged on the basis of creativity, technical merit and effective use of the video medium. Contestants must be original producers. Violation of copyright laws is prohibited and disqualifying.

Winners will be selected by the WWATS appointed judges. Their decision is FINAL. No substitution of prizes or exchange for cash value allowed. Any state, local or federal tax applicable is the responsibility of the recipient. Offer void where prohibited by law. Winners may be required to attest to compliance with rules of the contest.

Winners will be announced at 1990 Dayton Hamvention. Winner need not be present! All entries become the property of WWATS and ATVQ for the promotional use of ham radio and editorial and promotional uses.

Entries must be post marked no later than March 1, 1990. Postage due mail will not be accepted. Sponsors and prize donors assume no responsibility for lost or damaged entries. Return postage must accompany any videocassette to be returned, otherwise entries become the property of WWATS. WWATS is responsible for delivery of prizes to winners.

### OFFICIAL ENTRY FORM

CALL: \_\_\_\_\_ NAME: \_\_\_\_\_

ADDRESS: \_\_\_\_\_

CITY: \_\_\_\_\_ STATE: \_\_\_\_\_ COUNTRY: \_\_\_\_\_ ZIP: \_\_\_\_\_

Certification: I hereby enter the WWATS/ATVQ contest and agree to abide by the rules as stated above and accept the decision of the judges. My entry is enclosed. I declare that I am the producer of this video and release all rights of copyright to WWATS and ATVQ in exchange for consideration for the prizes listed above.

DATE: \_\_\_\_\_ Signature: \_\_\_\_\_

\*Agreement with Icom requires 100 valid entries to contest. Enter soon, tell your friends!

SEND ENTRY TO: WWATS/ATVQ VIDEO CONTEST, 353 S. 116TH ST. SEATTLE, WA 98168  
Entry form may be copied as needed.

**ENTER EARLY ENTER OFTEN**

**ATVQ DEVOTED ENTIRELY TO HAM TV**



# WYMAN RESEARCH INTRODUCES NEW TRIDON LINE

ONLY  
\$229.95

TRIDON AM 450 MHZ  
TRANSMITTER

\$319.95

TRIDON 2000 AM  
450 MHZ TRANSCEIVER

\$399.95

TRIDON FM  
TRANSMITTERS  
900 MHZ  
1200 MHZ



## 450 TRANSMITTER

- POWER OUTPUT IS 3 W PEAK
- TWO INDEPENDENT AUDIO SYSTEMS  
(Sub-carrier and On-carrier)
- 10 PIN CAMERA CONNECTOR ON BACK-BNC OR RCA CONNECTORS ON FRONT
- SYNC STRETCHER FOR OPTIMUM COMPOSITE VIDEO
- STANDARD CRYSTAL FREQUENCY: 439.25 MHZ or 434.00 MHZ
- POWERS VIDEO CAMERA (10 Pin Connector)
- REQUIRES 13.8V DC AT 600 MA PLUS CAMERA POWER ( 1 amp)
- RF TIGHT ALUMINUM CABINET WITH BRUSHED ALUMINUM PANEL CUSTOMED DESIGN-ED BY W9YL
- CABINET SIZE: 2.2"x5.25"x5.5"

## FACTS 450 TRANSCEIVER

- POWER OUTPUT - 3 W PEAK
- 10 PIN CAMERA CONNECTOR ON BACK PANEL, BNC OR RCA CONNECTOR ON FRONT PANEL
- MONITOR VIDEO FROM CAMERA OR DETECTED VIDEO OUTPUT
- ALL NEW VIDEO AND AUDIO CIRCUITRY WITH SYNC STRETCHER
- NEW TWO CHANNEL AUDIO SYSTE ON TRANSMIT (SEE OPTIONAL RECEIVER BELOW)
- NEW MORE POWERFUL VIDEO TRANSMITTER
- STANDARD CRYSTAL FREQUENCY: 439.25 MHZ or 434.00 MHZ
- .8 DB NF GaAsFET PRE-AMPLIFIER
- RF TIGHT ALUMINUM CABINET WITH BRUSHED ALUMINUM PANEL CUSTOMED DESIGN-ED BY W9YL
- SIZE: 2.2"x7"x5.75"
- RELAY SWITCHED ANTENNA

## FM TRIDONS

### BOTH HAVE —

- PRE-EMPHASIS CIRCUITRY
  - "N" CONNECTOR
  - RF TIGHT ALUMMINUM CABINET WITH BRUSHED ALUMINUM PANEL CUSTOM-ED DESIGNED BY W9YL
  - CABINET SIZE: 2.2"x8.2"x5.5"
  - REQUIRES 13.8 V DC AT 2 AMPS
  - LARGE HEAT SINK
- ### 900 MHZ
- 915 MHZ FM-ATV TRANSMITTER
  - POWER OUTPUT IS 8 WATTS
  - 4.5 MHZ AUDIO SUB-CARRIER
  - USES NEW PHASE LOCK LOOP CRYSTAL CONTROLLED EXCITER
- ### 1200 MHZ
- 1255 MHZ FM-ATV TRANSMIT-TER (Any optional freq.)
  - POWER OUTPUT IS 4-5 WATTS
  - 6 MHZ AUDIO SUB-CARRIER (Requires 1 V PP Audio)
  - USES MILITARY QUALITY WOOD-DOUGLAS CRYSTAL CONTROLLED EXCITER

# WYMAN RESEARCH, INC.

INDIANA RESIDENTS 5% SALES TAX

Don & Sue Miller  
W9NTP  
W9YL

R.R. #1 BOX 95  
WALDRON, INDIANA 46182  
(317) 525-6452

SHIPPING \$4.50

# DAYTON ATV PARTY

**FRIDAY NIGHT, TRAVELODGE MOTEL JUST OFF I-75, 7 PM-MIDNIGHT.  
BEST ATTENDED, BEST ORGANIZED, BEST SPEAKERS, FREE FOOD AND DRINKS  
HOME BREW CONTEST, WIN \$100 CASH, BRING YOUR ENTRY OR CLEAR PHOTOS  
AND WRITE-UP OR VIDEO TAPE SHOWING YOUR BEST  
HOME BREW EQUIPMENT TO ENTER AND WIN.**

**WINNERS OF HAM VIDEO CONTEST ANNOUNCED AND WINNING VIDEOS SHOWN.**

**BE PART OF THE ACTION: SEND PRESENTATION REQUESTS TO  
CHUCK NORTHCUTT W7SRZ, 353 S. 116th ST., SEATTLE, WA 98168.**

**HOST: ATVQ, MC, CHUCK NORTHCUTT W7SRZ,  
HENRY RUH KB9FO, BILL BROWN WB8ELK**

**ONLY 200 YARDS FROM SSTV MEETING HELD AT HOLIDAY INN NORTH.**

## AMATEUR TELEVISION QUARTERLY SUBSCRIPTION

DEVOTED ENTIRELY TO AMATEUR TELEVISION

US Delivery Canada Elsewhere

- |                               |      |      |                     |
|-------------------------------|------|------|---------------------|
| <input type="checkbox"/> 1 YR | \$15 | \$20 | \$25                |
| <input type="checkbox"/> 2 YR | \$30 | \$40 | \$45                |
| <input type="checkbox"/> 3 YR | \$40 | \$55 | \$65 (all US Funds) |
| <input type="checkbox"/> 4 YR | \$50 | \$70 | \$85                |
| <input type="checkbox"/> 5 YR | \$60 | \$85 | \$100               |

- |   |                |
|---|----------------|
| <input type="checkbox"/> BATC Compendium        | \$10           |
| <input type="checkbox"/> Rose Parade Video Tape | \$20           |
| With 3 Yr. Sub.                                 | \$10           |
| With 5 Yr. Sub.                                 | \$ <b>FREE</b> |

Call: \_\_\_\_\_ Name: \_\_\_\_\_

Address: \_\_\_\_\_

City: \_\_\_\_\_

State/Prov: \_\_\_\_\_ ZIP: \_\_\_\_\_ Country: \_\_\_\_\_

Gift? \_\_\_\_\_ From: Call: \_\_\_\_\_ Name: \_\_\_\_\_

### Optional Info

operate: FSTV SSTV FAX other \_\_\_\_\_

ATV/SSTV bands \_\_\_\_\_

Phone (kept confidential) \_\_\_\_\_

Best ATV or SSTV DX \_\_\_\_\_

Grid locator or Lat/Lon. \_\_\_\_\_

ATV RPT? \_\_\_\_\_ QTH \_\_\_\_\_

Station Equipment \_\_\_\_\_

Comments: \_\_\_\_\_

### TECHNICAL NOTES

In the October issue of ATVQ (V2 #4) an article about a low cost 23 cm phase locked loop exciter has created some excitement. Several ATCO members have inquired requesting a source to purchase the SP-5060 (Plessey) IC. The fixed modulus frequency synthesizer may be purchased in quantities of 6 or more at a cost of \$15.-05 each. Dick W8RVH located the source, Pioneer Electronics, 1200 Troy St., Dayton, OH 45404. Delivery takes about 6 weeks ARO. W8RVH, WB8URI, WM8P, W8DMR and others have successfully duplicated the 23 cm PLL exciter using the PC TVG-12A and the SP-5060 IC. Total cost to construct the exciter is less than \$48.25. The article on pages 39-41 and color photo on the front cover were authored by W8DMR. The concept of a 1280 Mhz PLL was first offered at the ATCO technical symposium in 1988. de Bill W8DMR.

### HELP!

W3WFF, Alfred Gussman of 618 Moredom Rd., Huntingdon Valley, PA 19006 needs help getting on ATV. He has TX432 (VHF Engineering) transmit strip and needs a video modulator (Check back issues of old A5, it was in there many years ago). He also has a TVX-10/ATV Xtronix transmitter which doesn't work and would like a schematic. As memory serves this dates to about 1976. Can any reader help Alfred?

### NEW ATV RPT

K2CBA says he will get an ATV repeater on air soon in the Petersburg, NY area. Watch for announcement here. It is planned as 439.25 in and 1250 out, and will link to Mt. Graylock.

### BACK ISSUES

ESF COPY SERVICE  
4011 CLEARVIEW DR.  
CEDAR FALLS, IOWA  
50613

### READING YOUR LABEL:

V3 1990, V4 1991, etc #1 January  
#2 April, #3 July, #4 October.  
yellow stripe time to renew  
red stripe subscription expired

**ATVQ DEVOTED ENTIRELY TO HAM TV**

**AMATEUR TELEVISION QUARTERLY  
1545 Lee St., Suite 73  
Des Plaines, IL 60018  
708-298-2269**



JANUARY 1990  
ISSN #1042-198X

AMATEUR TELEVISION QUARTERLY MAGAZINE  
USPS #003-353

VOLUME 3 #1  
Forwarding & Return Postage Guaranteed

Amateur Television Quarterly Magazine is published four times a year by Henry B. Ruh KB9FO at 540 E. Oakton St., Des Plaines, Illinois 60018-1950. Annual subscription rate for domestic delivery is \$15 per year. Canadian delivery is \$20 per year in US Funds sent first class mail. Delivery to other countries is \$25 per year US funds and sent as air-mail, printed matter. Second Class Postage paid Des Plaines, Illinois and additional offices of entry. Second Class Mail Permit Number USPS 003-353. POSTMASTER: Send change of address to: Amateur Television Quarterly Magazine, 1545 LEE ST. SUITE 73, Des Plaines, Illinois 60018. All inquiries, subscriptions and submittal should be sent to: Amateur Television Quarterly Magazine, 1545 Lee St. Suite 73, Des Plaines, Illinois 60018. The logo and trademark of Amateur Television Quarterly Magazine is ATVQ as displayed on our front cover. The Business phone number is 312-298-2269. Note that the phone company will be changing the area code in January 1990. Co-publisher is Bill Brown WB8ELK. Technical Editor is Tom O'Hara W6ORG. Editor is Sylvia Kurcz. Typist and word processing by Laurie Woisniewski. Editorial offices are located at 540 E. Oakton St., Des Plaines, IL 60018-1950. However, because of curb side delivery it is preferred that all mail be addressed to 1545 Lee St. Suite 73, Des Plaines, IL 60018.

ATVQ Amateur Television Quarterly. Copyright 1989. All rights reserved. No portion of Amateur Television Quarterly in whole or in part may be reprinted without written permission of the copyright holder. Publications in foreign countries may reproduce portions of a current issue provided source credit is printed in the heading of any such reproduction and a copy of the publication containing the reproduction is sent to ATVQ.

### TABLE OF CONTENTS

ATV SATELLITE; WEBERSAT ATV IN SPACE!	6
VIDEO AGC FOR REPEATERS - Howard W4PPN	12
PITTSBURG/WARREN/YOUNGSTOWN ATV	14
MICROBALLOON - Bill WB8ELK	15
YORK ATV CONFERENCE	16
HOME HAM VIDEO CONTEST ENTRY FORM	18
W6ORGy NOTES	19
MOBILE ROTATOR ANTENNA MOUNT - Frank WB9KCC	29
MISSISSIPPI ATV	30
KD0FW ATV BALLOON	31
ATV REPEATER CONTROLLER - Trevor G8CJS	32
ROANOKE, VA AND DAVENPORT, IA	39
AEA/AMIGA SSTV AMIGA VIDEO TERMINAL - John KD0LO	40
CELLULAR AMP FOR 900 MHZ ATV - Bob WB4APR	44
LITTLE WHEEL ANTENNA - Dave W60AL	45
IMPROVING ATV RECEIVE PERFORMANCE - Dick WA3USG	48
ATV NEWS	49
1250 MHZ LOOP YAGI ANTENNA - Ken G4BVK	55
VIDEO DISTRIBUTION AMPS from CQ-TV	56
1280 MHZ FM TV RECEIVER - Mike ZL1ABS	59
900 mhz TAKEN FOR VEHICLE LOCATION SYSTEM	61
SOUND IN YOUR ATV STUDIO from CQ-TV	62
DX RECORDS AND A TOUR OF THE ATVQ HAMSHACK	64

# RADIOSCAN

MAGAZINE

LA REVISTA INTERNACIONAL  
del Radioaficionado Hispano

¡Gratis!

Solicite un Ejemplar  
de  
RADIOSCAN MAGAZINE

¡Gratis!

175 Fontainebleau Blvd.  
Oficina 2K-5, Miami, FL 33172  
Tel. (305) 551-7225 • Fax 551-1785

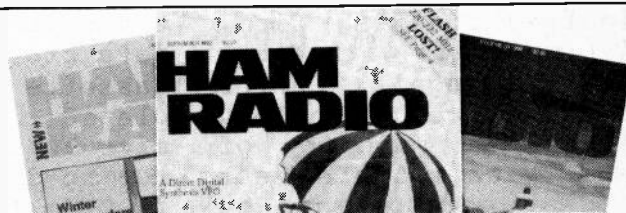

## It's NEW and Exciting!

HAM RADIO is full of projects and the kind of technical articles you are looking for. From easy-to-build Weekenders to state-of-the-art equipment, HAM RADIO has it all. In addition there are four special issues plus some of the most respected columnists too! Take a trial subscription today and see for yourself what HR has to offer!

Regular One Year Rate  
\$22.95

Special Trial One Year Rate  
**\$19.95**

HAM RADIO Magazine  
GREENVILLE, NH 03048 (603) 878-1441 MT

## ATV SATELLITE to be Launched

During the first part of January (Jan. 10th as of this writing) a series of amateur satellites called Microsats will be launched from Kourou, Fr. Guiana via the ARIANE rocket. One of these is known as WEBERSAT and has as one of it's main goals the transmission via packet of a view of the Earth and Moon as seen from it's on-board color CCD Camera. Also a P.C. Electronics downconverter has been included which will allow reception of live ATV on 1265 Mhz which will be digitized and relayed back to earth via the packet link as well as an easily recorded "fast video download" described below.

This satellite was built in cooperation with AMSAT and was technically managed by Orchid Engineering, a Utah based electrical engineering firm, under contract with Weber State College's Center for Aerospace Technology (CAST). The majority of the fabrication and test work was accomplished by Weber State College students and by outside volunteers.

Video from the satellite's Canon 610 color CCD TV camera is digitized by the on-board computer via a command from the control station. This signal can be sent back to earth via two different methods.

### PACKET IMAGE DATA

One digitized frame of the standard NTSC video is stored in a 166k block of memory. If sent back to earth via 1200 baud packet this will take about 20 minutes. Since this may be longer than one pass over your QTH, you may have to receive two passes to see the

whole picture.

### FAST VIDEO DOWNLOAD

The digitized image can be clocked into a Digital to Analog converter (DAC) at a rate 1000 times slower than the original digitization resulting in an analog signal which can be sent via a standard FM voice channel (A form of slow scan TV but not compatible with our SSTV units). This can be sent down via the FM modulator on-board and takes only 7 seconds. Although some distortion may result this can be filtered out in the image reconstruction program and won't require anything more than a 437.075 Mhz FM rig and an audio tape recorder to store the image. This system will also allow a digitized voice message to be uploaded and stored in the computer memory for later retransmission. The video data stored on your audio cassette can then be replayed into an inexpensive audio frequency analog-to-digital converter (ADC) and stored in your home computer. Software is being written at Weber State to decode both of these transmissions using an IBM PC supporting various graphics boards (EGA, VGA and possibly CGA). Dr. Robert Summers has written a program which allows the user to print out a high resolution image on a standard dot matrix printer and to perform some statistical filtering and manipulation of the image. Other programs written by Bob Argile and Chris Williams will support the compression and decompression of video data and allow extraction of RGB color images from the digitized composite video image.

Software will be available in April from AMSAT P.O. Box 27, Washington, D.C. 20044.

Although the other Microsats won't be available for general use for several weeks after launch, the WEBERSAT will start sending back pictures within the first few orbits. Even though software may not be available to decode these pictures until April, you may want to start saving picture data you receive. Since the video portion of this satellite is only a part of the total experiment package, the picture download feature won't be continuous. Check your local BBS for schedule updates from AMSAT or listen to the various HF AMSAT nets. We will also relay current information on the weekly ATV net every Tuesday night at 8pm Eastern Time on 3.871 Mhz.

The ATV uplink mode on 1265 Mhz will be attempted on a pre-arranged schedule with the Weber State command station and control stations around the world. Due to the low gain antenna on the satellite and the altitude, it will take a substantial uplink ERP to send a picture to the satellite. For an overhead pass the closest approach will be 310 miles and the satellite could be as far as 1800 miles away on the horizon. Your best chance is to wait for a high elevation pass and hit it with all the power you can generate into an AZ--EL steerable array. Use a test pattern of very large high contrast call letters. Using W6ORG's path loss program (see April 89 ATVQ p.78) we see that with an 18 W

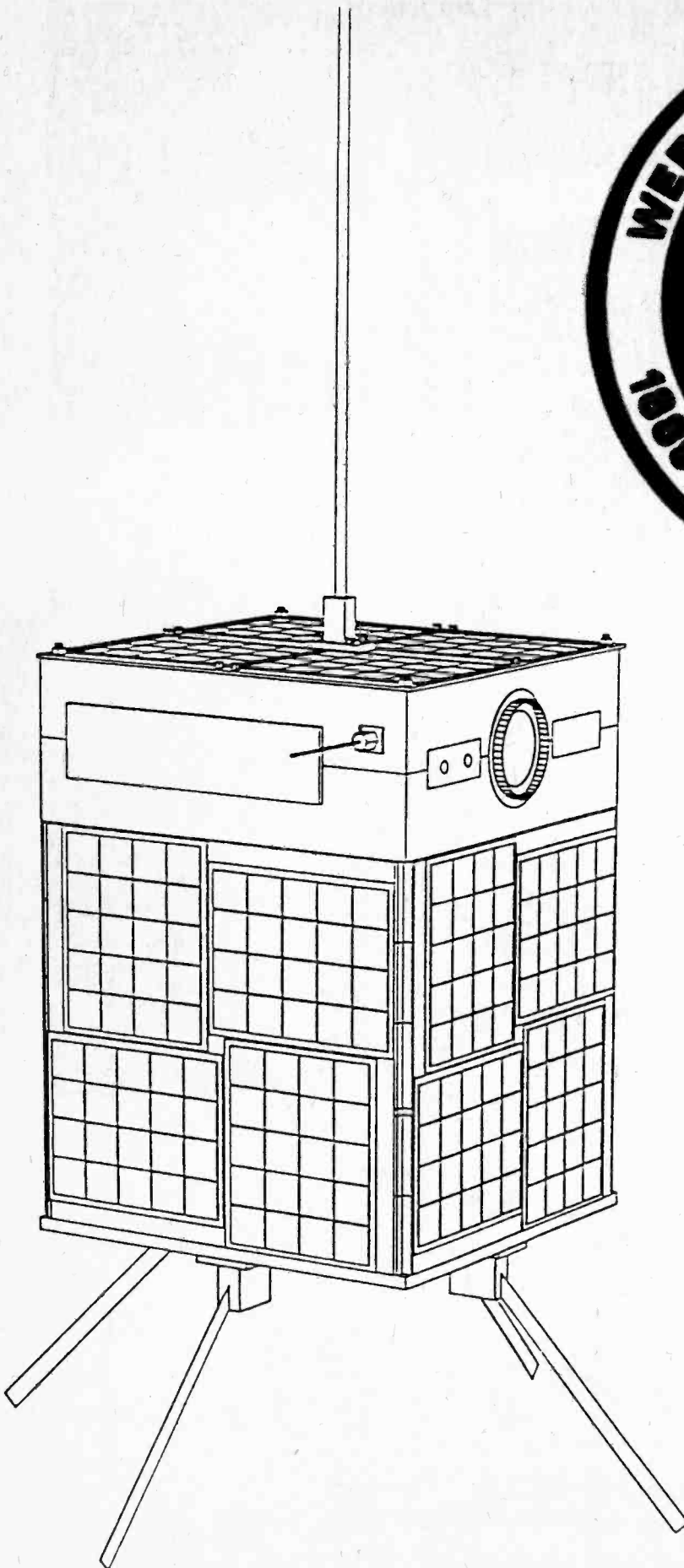

AMSAT - NA  
Dick Jansson, WD4FAB  
1130 Willowbrook Trail  
Maitland, FL 32751 U.S.A.  
March 2, 1989

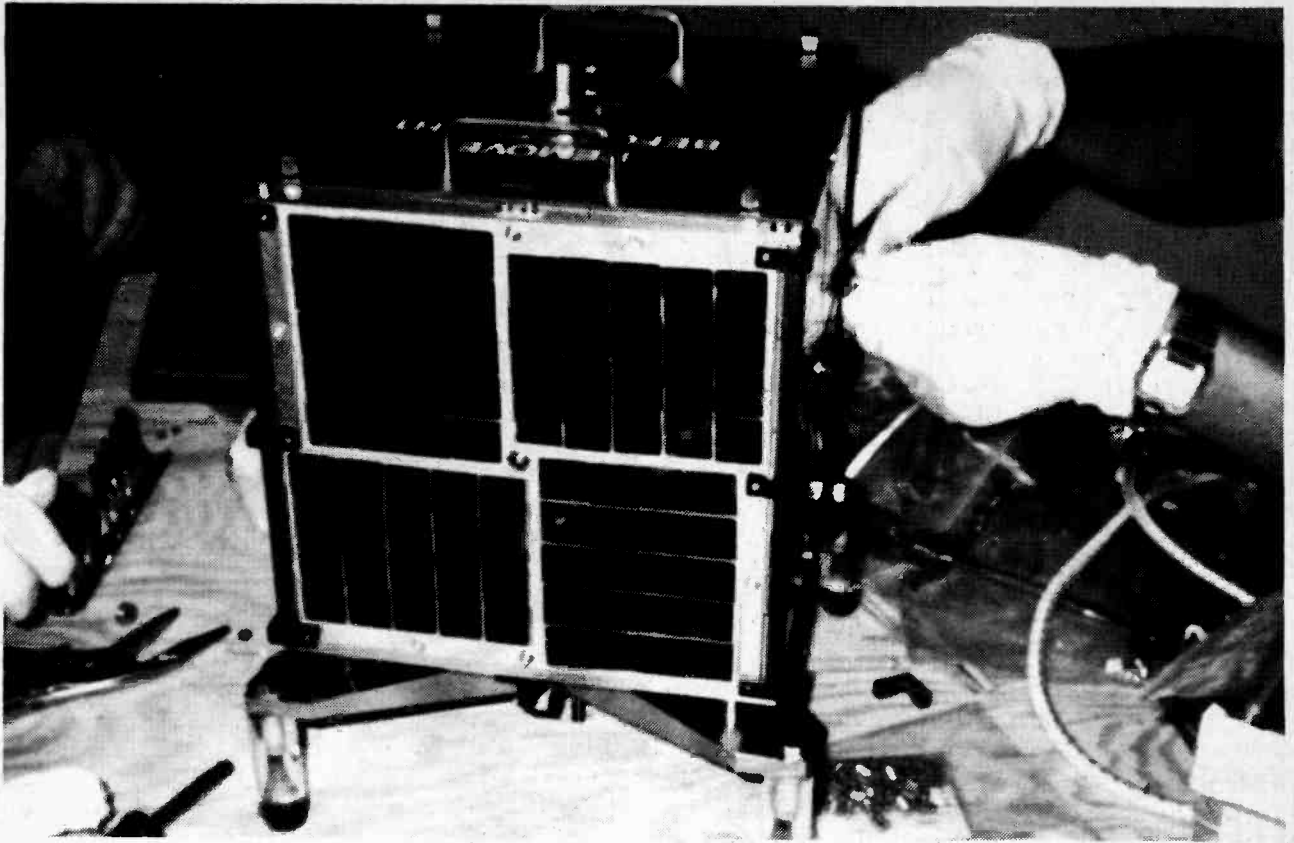

**Microsat Package**

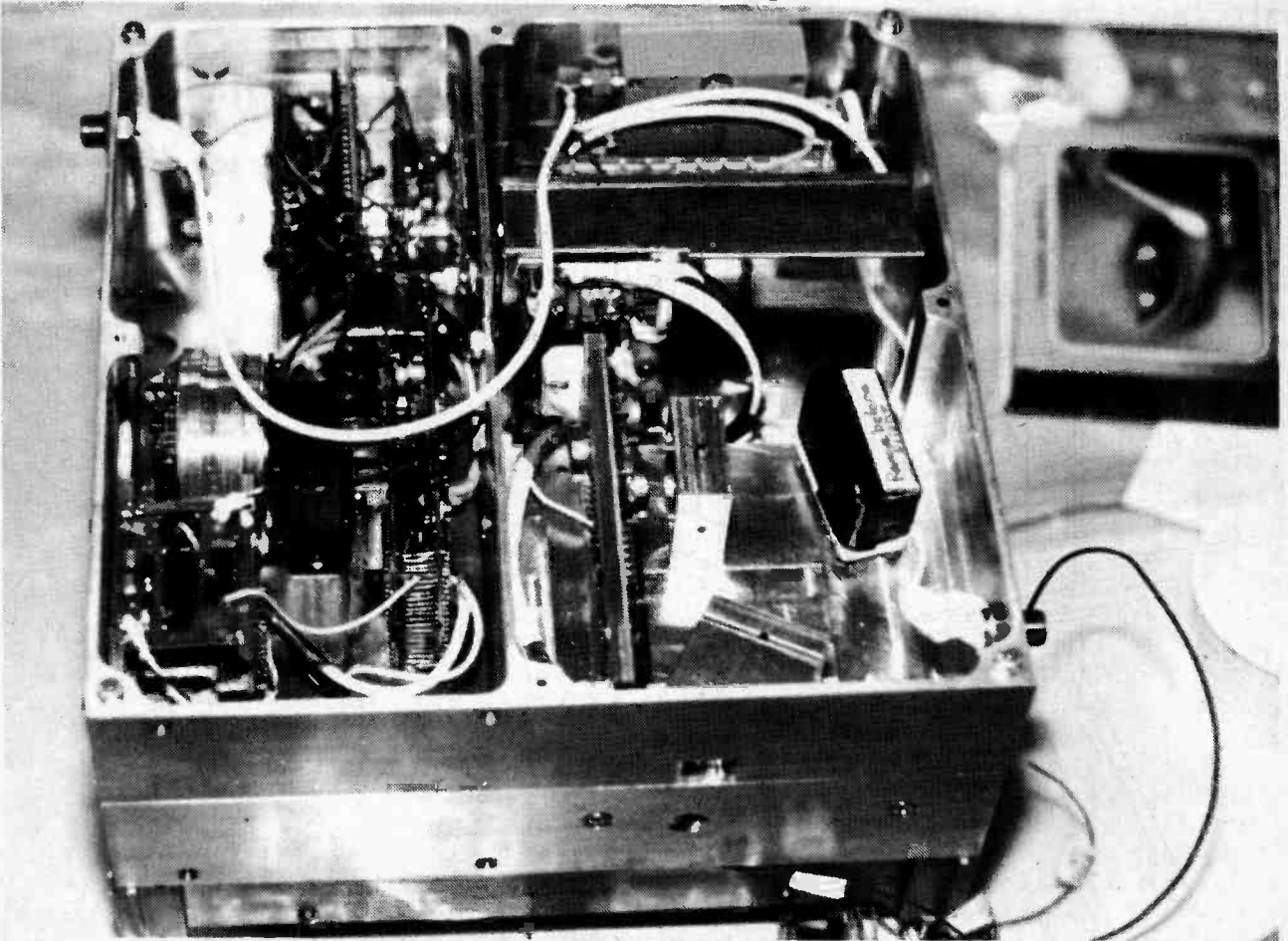

**Color CCD TV Camera Module**



transmitter into a 22 dBd gain array we can only hope to achieve a C/N of 15.5 db (approx. P2) at the closest approach and a virtually unusable 1.8 dB at 1500 miles. 100 W into the same array will give us a decent 23.0 dB (P3+) at best and 9.3 dB (P1) at worst. It appears that an antenna gain of 27 dBd (7 foot dish) will be required with a 100 W transmitter to produce a P4+ color picture. In the case of the 18 W transmitter it would take an 18 foot dish for a P4+! Don't let this totally discourage you as an 18 W transmitter into a single yagi (16-18 dBd) could produce a recognizable P1 picture under the right conditions. Comparing actual reports vs. the calculated path loss of the last few ATV Balloon flights over the midwest showed, around a 5-10 dB increase over the predictions. Add at least a P-unit to above estimates if this is the case. This increase may be due to the way the eye integrates a noisy picture to enhance it. Even though the on-board digitizer doesn't have the advantage of the human eye we may be surprised at how well lower power levels work. In fact lab tests at the college indicate that decent pictures could be digitized and relayed with just 10 dB of C/N. Image processing can be done at the receiving ground station which could enhance this into a fairly good picture. Regardless of your station's capabilities, it's certainly worth giving it a try!

1265 Mhz AM ATV transmitters as well as antennas are available from P.C. Electronics. High power

amplifiers can be obtained from Downeast Microwave, Box 2310, R.R.#1, Troy, ME 04987 and HI-SPEC, P.O. Box 387, Jupiter, FL 33468. Also antennas can be obtained from Spectrum International, Downeast Microwave, Wyman Research, KLM etc.

#### WHAT IT WILL TAKE:

##### FAST VIDEO DOWNLOAD

Narrowband receiver on 437.075 Mhz with minimal gain antenna (turnstile or J-pole may be all that's needed), audio tape recorder, inexpensive A/D converter circuit and an IBM PC. Note: A hardware interface may be in the works which will take the audio data and display it directly on your monitor (just like a SSTV converter).

##### PACKET IMAGE DOWNLOAD

437 Mhz SSB OSCAR type Satellite receiver or converter, AZ/EL antenna (low gain ok), PSK modem (TAPR kit \$110 call (602) 323-1710, Pac-Comm assembled unit \$219 or the G3-RUH kit), any packet TNC, IBM computer, software available from AMSAT 301 589-6062.

##### ATV UPLINK - 1265 Mhz

ATV transmitter and amplifier capable of 18 W or (better) 100 W and 22 dbd gain antenna with AZ-EL mount (quad stacked array of loop yagis or 4 foot dish). A system capable of producing over 100 W would include a 1 W P.C. exciter to a 18 W Downeast solid state Amp feeding a 100 W + Hi-SPEC Tube Amp.

##### SCHEDULE

The schedule of experiments to be performed will be dependent on the users. Since the ATV uplink and digitization command has to be activated by a command station, stations wishing to uplink to the satellite

will have to initially schedule the attempt with the appropriate command station for your part of the world. If the fast video downlink mode is a success, the satellite can be set up in a mode which will snatch a picture and relay it down in 7 seconds, constantly repeating this cycle. This way no schedules will be necessary and lots of pictures can be uploaded and downloaded per pass. The real beauty of this satellite is that it is totally programmable and can be set up in many different configurations. A hardware/software interface may be available in the next few months which will make it easy to display the fast downlink images much like a SSTV converter.

If you have the capability of transmitting a 1265 Mhz ATV signal up to the satellite please contact Bill Brown WB8ELK, 12536 TR 77, Findlay, OH 45840 Ph:(419) 422-8206 or Robert Twiggs, Director - CAST - Weber State College - School of Technology - Ogden, UT 84408-1805. Ph:(801) 626-7272 to arrange a schedule. If you have a 1265 Mhz ATV station, an IBM PC and an OSCAR station with PSK modem capable of working the Microsats contact us about becoming a command station.

A WEBERSAT User's Group is being formed by Robert Twiggs in order to distribute information and updates. He'd like to hear your inputs and suggestions to help determine the uplink and downlink image schedule.

This unique satellite will provide us with some fantastic imagery and hopefully add a new dimension to ATV in SPACE!

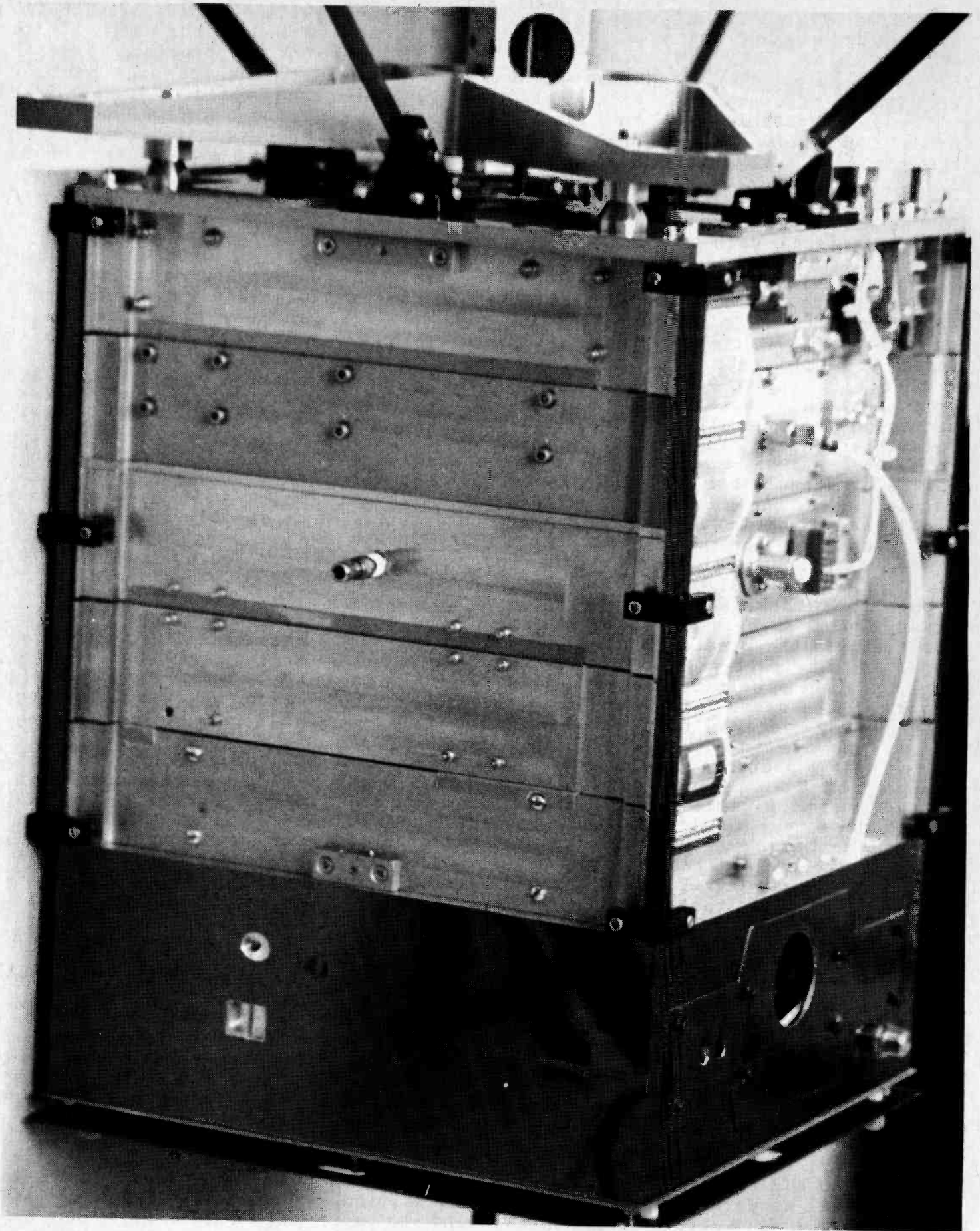

Stacked Modules in Microsat

# 900 MHZ LINEAR POWER AMPS. 1W IN 17W OUT

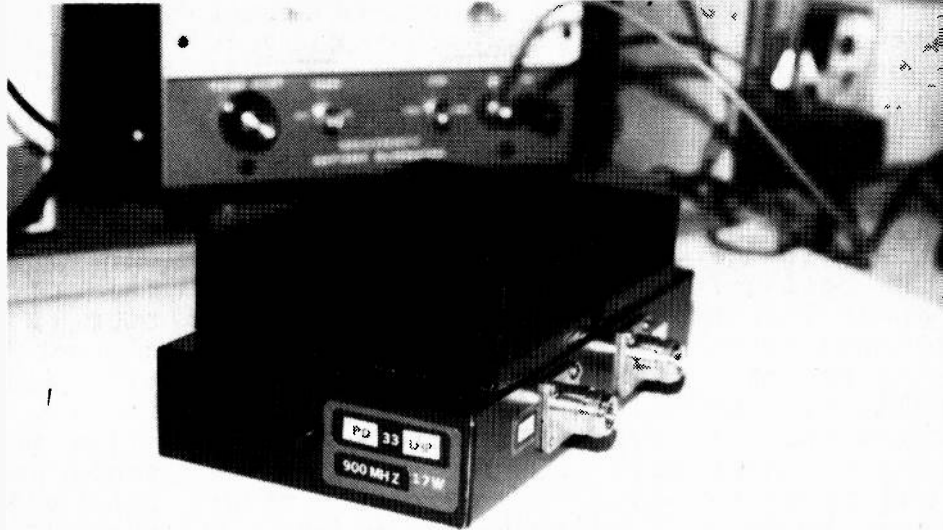

The low power driver is a separate stage from the high power output stage. Each unit is encased inside a separate die cast box which is enclosed in a large 4-1/2" x 8" cabinet with a double heat sink. The linear has power binding posts, is fused, has an "ON" light, and is diode protected. Connectors supplied are "N", but other types are available. The units are spray painted black with an acrylac finish.

PD-33LHP .....\$210.00

## 1.2 GHZ LINEAR POWER AMPLIFIERS 1 watt in 18 out

Uses a power gain block. Same design as above, but smaller in size .....\$139.00  
with T/R switching.....\$169.00

## 902 to 928 MHZ

FM power amps., 1 watt transmitter exciters, excellent pre-amps. NF average 0.6db. Gain 16db.  
pre-amps.....\$ 62.00  
Tower mounted pre-amps T/R.....\$139.00

1.2 GHZ pre-amps.....\$ 62.00  
Tower mounted pre-amps T/R.....\$149.00

VHF & UHF POWER AMPLIFIERS & PRE-AMPS  
BRICKS, TRANSISTORS, and SOME PARTS  
SEND FOR CATALOGUE (2) 25 cent stamps please.

210 Utica St.  
Tonawanda, NY 14150

1-716-692-5451  
W2WHK

**pauldon**  
ASSOCIATES

## VIDEO AGC FOR YOUR REPEATER

Howard Cochran W4PPN - 5600 Birchhill Rd. - Charlotte, NC 28227

In the July 1989 issue of ATVQ there was an excellent article by W5KPZ covering repeater desense. Dave's article prompted me to write about another repeater problem, that of variable video levels as received by the repeater.

The repeater owner has to strike some happy medium when setting his video levels at the transmitter. This means that the incoming signal at either end of the acceptable range will be less than optimum. Only those video levels that match the level settings of the transmitter chain adjustments will be repeated as received. All others will have their sync levels and or video levels increased or decreased by some amount.

There are two items that can be placed in your video chain before reaching your repeater transmitter that will aid in having constant video levels available at the transmitter: A Proc-Amp and a Video AGC Board.

Mike Collis WA6SVT wrote a Proc-Amp article in the April 1989 issue of ATVQ. See page 53 for a description. Kits and assembled units for this circuit, are available from Elktronics - 12536 TR 77 - Findlay, OH 45840. Also Griffin Enterprises carries a Proc-Amp kit. Contact Hap Griffin WA4UMU - P.O. Box 6104 - Sumter, SC 29150-6104. These Proc-Amp kits will permit you to do some neat things in the shack. Hopefully Hap can put together a future article that will show what can be done.

The AGC amplifier that I will describe is also a kit that is available from the Worthing and District Video Repeater Group. It is available for seventeen

pounds (British Currency). You can obtain one by writing to R. Stephens G8XEU, Toftwood, Mill Lane, High Salvington, Worthing, Sussex, BN13 2SX, England. I have been advised by Mr. Stephens that you need to send your money in the form of Pounds Sterling as it is difficult for them to convert American Dollars. With the rise and fall of the exchange rate, the amount they get with the conversion may be less than the price of the kit.

### Circuit Description:

This circuit will accept video input variations from 0.15 Volts P-P up to 2.5 Volts P-P while providing a constant output level of approximately 1.0 Volts P-P. The time constant of the AGC is in the range of 3-4 seconds and both input and output present a common 75 ohm impedance.

The main active element in the circuit consists of an IC used in the luminance circuit of most VCR's. This chip, an ECG1264, is capable of doing more than what it is being used for here. In this application the AGC function is the primary task being accomplished. For those of you who may want to branch out into other uses, Pre-Emphasis, De-Emphasis and filtering are available. Sync pulse clamping and peak white clipping can also be obtained.

### Tune Up:

After you have completed the circuit, tune up is rather straight forward. The use of a scope is helpful. Hook up a monitor and an adjustable video source to the board. A dual-trace scope makes this demo a piece of cake.

You can observe the effect as you view the input and output signals on the scope. It is also visually apparent when you have a monitor hooked up at both input and output. As you vary the input signal between the range of 0.15V to 2.5V you should see the output signal settle down to the 1.0V level within 3 to 4 seconds. If you are running color through your repeater then it is necessary to adjust the coil to reject the chroma sub-carrier signal. Otherwise changes in color saturation will cause variations in the output level. To align the coil place your scope probe at the junction of the 470 ohm and the 1.5K ohm resistors. With a color signal applied at the input, adjust the coil for minimum color burst amplitude. If you do not have a scope available (How can you run an ATV repeater without a scope?) adjust the coil for maximum contrast on the monitor. The change is small and the contrast may need to be reduced on the monitor to allow the change to be visible.

Data on the IC can be found in the ECG Master Replacement Guide ECG212P, Page 1-216.

My thanks to the Worthing and District Repeater Group for bringing this circuit to the attention of ATV'ers. Also thanks to Geoff Mather G8DHE for his technical description.



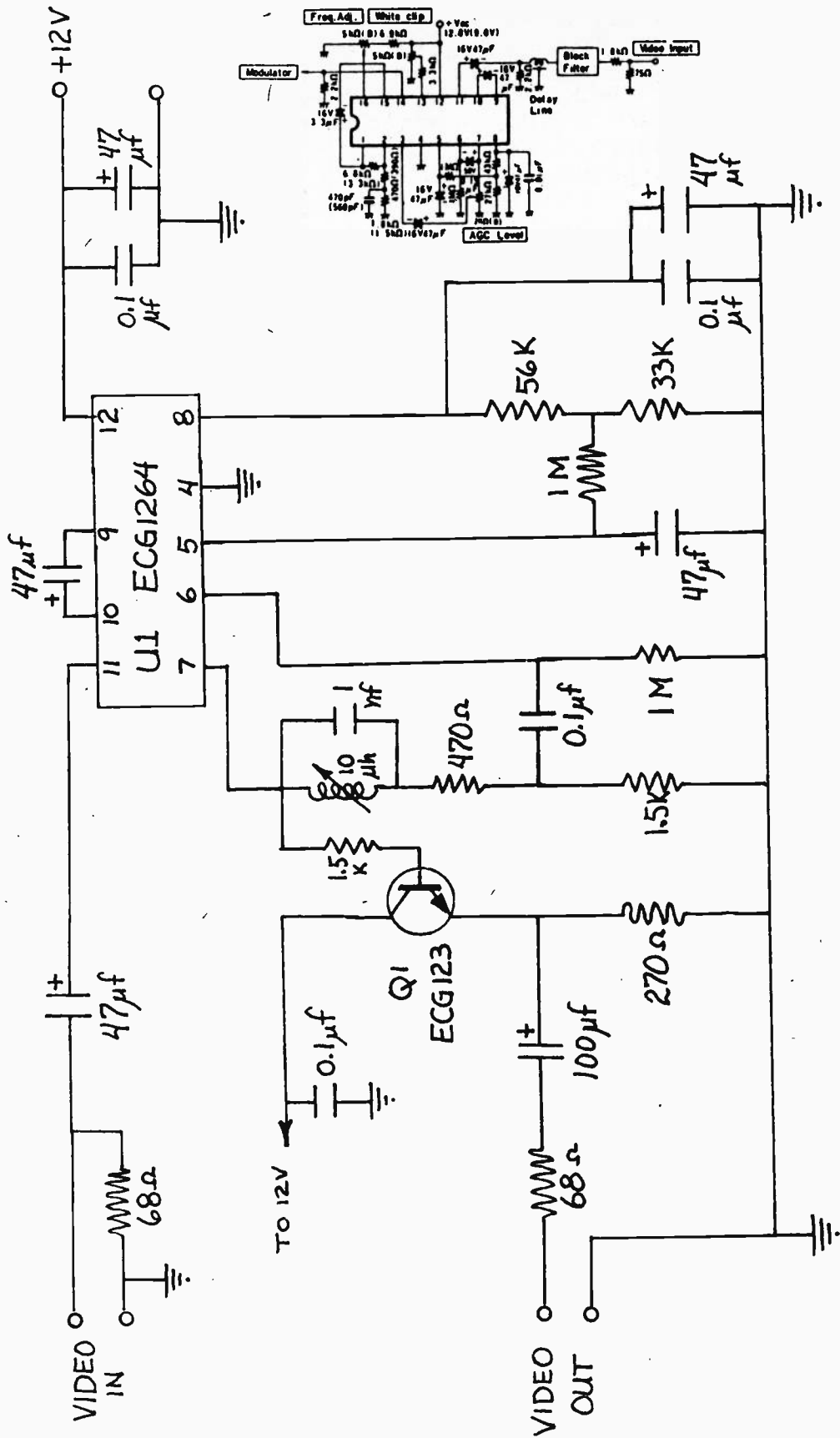

VIDEO AGC AMPLIFIER

## ATV NEWS

### PITTSBURGH ATV REPEATER

After many months of diligent searching, the Western Pa. ATV Group has finally found a suitable site to install a repeater. The new home for the repeater will be on the property of W3KWH, the Steel City Amateur Radio Club, located in Carnegie, Pa. about eight miles northwest of downtown Pittsburgh, Pa., and not far from the Pittsburgh International Airport.

The site is around 1450 ft. above sea level, and with the proposed antenna installation at 50 ft. will give us a total height of around 1500 ft.

The initial antenna installation will be vertically polarized simply because we have them on hand. However, if the repeater is successful, we will go horizontal as soon as possible.

The repeater will receive on 439.25 Mhz, and transmit on 426.25 Mhz. The power will be around 35 to 50 watts. The repeater is nearing completion, and is now undergoing shake-down tests at the QTH of Frank W3QNI.

Besides normal sync bring-up, it has not been established as to what 2 meter or 70 cm frequency will be used to control the repeater, as this will depend on what is available at the site for our use.

ATV activity in the local Pittsburgh area has been sporadic, however, there is never a week goes by that a few of the gang aren't on for a few hours. It is hoped that when the repeater is installed that activity will increase to where it was several years ago when we had around thirty active ATV'ers in the area.

Will W3UGI in Washington, Pa. has built a two bay Alford Slot Antenna, and the results have been surprisingly good.

Frank W3QNI, Don N3BMT and Andy K3IBD have installed the feed rotation control and motors available from Debco Electronics, Cincinnati, Ohio, on their antennas and are now able to go from vertical to horizontal polarization by merely pushing a button.

ED NOTE: This is a U-100 and control box for under \$30 from both Debco and Wyman Research.

By W3OSE has the new AEA ATV rig and antenna on the air and is real happy with what 1 watt will do. This is his first venture into UHF and he is having the time of his life, but with the hilly terrain around here, he needs and wants more power!

All of the ATV gang around this area enjoy ATVQ. It's just what we needed--keep up the good work!

### WARREN/YOUNGSTOWN, OHIO

The ATV repeater is up and running with good reports from some distance away. P4 to P5 reception has been observed by several ATV'ers in the Warren area over 20-30 miles from the repeater site as well as being seen near the Pittsburgh, Pa area. The repeater is located near the town of Salem, Ohio in Beloit and is maintained by Larry N8EWV. Currently they have two Lindsay horizontal antennas mounted at Larry's QTH. The input is 439.25 Mhz with 426.25 Mhz output. The D-1010N recently overheated so power will be limited to 10 watts for the near future. They are currently looking for a new amp. The local talk frequency is 144.34 Mhz simplex and al-

so the 146.865 (- 600) repeater. A call on the repeater will usually scare up one of the group.

### MICRO BALLOON



KA9JYI Prepares for launch.

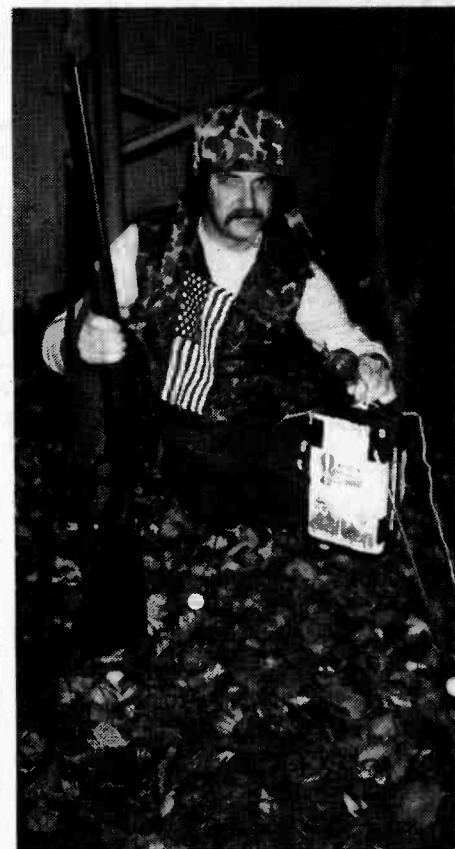

WD9I Bags a 5-point Elk

## MICRO-BALLOON Launched Oct. 28th (STRYROSAT 1)

Bill WB8ELK

Two weeks after the Oct. 7th flight of the ATV camera balloon, Mark KA9SZX indicated that he had a substantial amount of helium left. In an attempt to use up the remaining gas before returning the tank, we decided to develop the Micro-Balloon concept. Styrosat 1, as we dubbed it, would be designed in an effort to see how inexpensively we could launch a working amateur radio package considering we never expected to find this one! A visit to the local surplus store netted us a \$1 scanner crystal (155.165 Mhz-10.8 Mhz Bearcat IF frequency) which put us on 144.366 Mhz using the small 2 meter CW transmitter built by Carl WA4ADG (See July ATVQ, p.10). A CW ID'er was built with a thermistor controlled timing circuit. By varying the morse code speed with outside temperature we were able to simply determine the outside temperature. This thermistor is available from some Radio Shack stores for under \$1 including an attached calibration chart (Resistance vs. Temperature). Calibration was easily accomplished just by replacing the thermistor in the timing circuit with a pot adjusted to the values on the chart. At room temperature the CW ID'er keyed the transmitter at about 20 wpm. At it's highest altitude (about -50 degrees outside) it ran at a very slow 4 wpm. The total current drain for this system was less than 35 mA at 9 volts and produced a powerful? 10 milliwatt signal. We used a small 9 volt lithium pack made up of 3 SAFT LX1634. These will cost you about

\$8 new but I had a few lying around the shack. Otherwise a cheap 9 volt lithium cell probably would have worked. This was all mounted in a 1 inch thick styrofoam package with a 2 meter quarter wave groundplane complete with a small foam pumpkin impaled on the whip. (It was Halloween after all!) Total package weight came in at a very light 14 ounces (The pumpkin accounted for 2 ozs!). Including the helium and balloon, the total price tag came to under \$40.

With the assistance of Tim KA9SZY, Pam KA9UOU and Debbie KA9JYI, a small 3 foot sounding balloon (KAYSAM 50P) was inflated with about 14 cubic feet of helium. With the remaining helium, Debbie launched a small foam UFO with attached note to determine the wind direction (This was found 3 weeks later in Niles Michigan - 160 miles away). Mark KA9SZX released the Styrosat balloon at 9:33 am. (Only 3 minutes late - probably went off on-time since I wasn't there!). The bright red balloon was visible for quite some time as it drifted away from Tim's farm near Champaign, Illinois. It took about 2 hours to reach the final altitude of 60,000 feet. At this point stations over 300 miles away were hearing the signal. K8HVA in Plymouth, Ohio had over an S-2 level at 300 miles. Under 100 miles the signal was nearly pegging S-meters. The balloon burst just north of Lafayette, Indiana and parachuted down to land near Remington, Indiana.

Since balloon chasing is the ultimate challenge, at least one enthusiastic fox

hunter from Indianapolis made an extensive effort to track down and find the package. Cliff N9FHF kept up with the balloon but lost it when it landed. You don't have to very far away to loose a 10 mW signal! After plotting the many antenna bearings provided by the stations on the 40 meter net we determined that it had landed within a few miles of Remington (82 miles from launch point).

While Cliff combed the area trying to find a hint of signal, Ed WD9I from Monticello decided to join in the fun using nothing more than an HT and a portable scanner sitting on the passenger seat. After driving around the area he got lucky and heard the signal on his HT. Soon the scanner came to life! He jumped out of the car and saw a white object 100 yards away in the middle of a freshly plowed field. He ran out to investigate and discovered a package with a pumpkin face staring at him! He'd just bagged a 5 point ELK! (2 meter whip and radials). The secret to fox hunting is to be in the right place at the right time!

This winter we will be putting together some different balloon packages. A possible Round-the-World effort may go up as early as April. This will have a 2 meter FM rig and a 1 watt 10 meter transmitter relaying telemetry via morse code. This should be heard just about anywhere in the world due to the excellent conditions on 10 meters.

Also this summer a cross-band ATV Repeater will be flown to 110,000 feet over Ohio. This will have a 910.25 Mhz input and a

439.25 (or 426.25 Mhz) output and should allow two way contacts over 700 miles away. Stay tuned to the weekly ATV net (Tues. night at 8pm on 3.871 Mhz) or your local packet BBS for updates.

1990 planned flights

Jan.-Feb. WB8ELK Mini Balloon Findlay, OH 144.34 FM, 28.235 Mhz CW

Jan. Feb. WA4ADG transponder Knoxville, TN 10 mtr in 2 mtr out.

Feb. KD0FW ATV Independence, MO 439.25 Mhz.

March/April WB8ELK/PY2BJO Sao Paulo, Brazil 145.55 FM 28.235 Mhz CW (Round the World attempt)

Spring/Summer WB8ELK, KA8TEF Findlay, OH 2 meter Packet/ATV

Spring/Summer W0RPK

Des Moines, IA 2 meter packet

Spring N2AAM/KA2OHP New Jersey 70cm, 2 meter FM repeater

Spring/Summer WA0AUQ, KA0YRE Muscatine, IOWA 70cm to 2 meter FM repeater

Summer N4EEB Daytona Beach, FL 2 mtr packet & ATV

Summer NJ9Y Rockford, IL

Summer WB8ELK Findlay, OH ATV Rpt 910 in 439 out

## YORK ATV CONFERENCE

Bill WB8ELK

Saturday evening, Sept. 23rd, saw ATV'ers from all over the East gather at the Homestead restaurant in Dover, Pa. to participate in the YORK ATV conference. Even though slightly weathered from the tail end of Hurricane Hugo, the attendees had just come from the enjoyable York hamfest. Henry KB9FO and myself had arrived the night before to the warm hospitality of the York ATV group and met with the members at their mountain-top clubhouse (which also

houses the W3HZU ATV repeater 439.25 in / 426.25 out horizontal soon to have a 910 Mhz additional output). This repeater covers a wide area of southeastern Pa. from Harrisburg to northern Maryland.

About 50 ATV'ers met for the dinner and talks with some coming as far away as Ohio. After the excellent dinner, the master of ceremonies (John W3HMS) started off the evening with introductions and Henry KB9FO presented ways of stirring up ATV activity. Rick WA3USG described activity in the York area complete with a hilarious video tape. If only network TV was this entertaining! Bill WB8ELK showed his latest balloon packages with slides and video footage from the latest efforts. The original "Captain Video", Ron K3ZKO, talked about the Philadelphia ATV Repeater and activity in his area.

Following the talks a homebrew contest was held with various prizes going to the seven contestants as follows:

K3TAZ Remote Control ATV "PONG" video game.

W3WVV Homebrew super low level light TV camera & 900 Mhz ring yagi.

KA3ATH "Quickee Big Wheel" antenna

WA3USG 16 element PVC Collinear for 439 Mhz.

N3AGG Briefcase portable ATV station complete with Uniden camera.

K3ZKO 900 Mhz. Alford Slot antenna

K3GXU MRF 901 Homebrew Preamp.

KA3IUO Winner of Main Prize drawing.

I wish to thank John W3HMS and the York, Pa. ATV club for organizing this event and also to Rick WA3USG for sharing his house and hamshack.

Plans are in the works for next year's conference which will be announced in a future ATVQ.

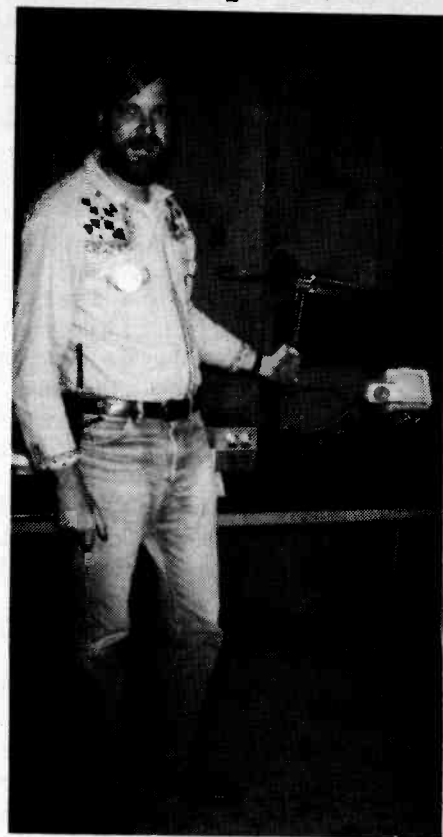

N3AGG - Briefcase portable ATV



K3ZKO 900 Mhz Alford Slot



# MORE YORK HOME BREW CONTEST WINNERS

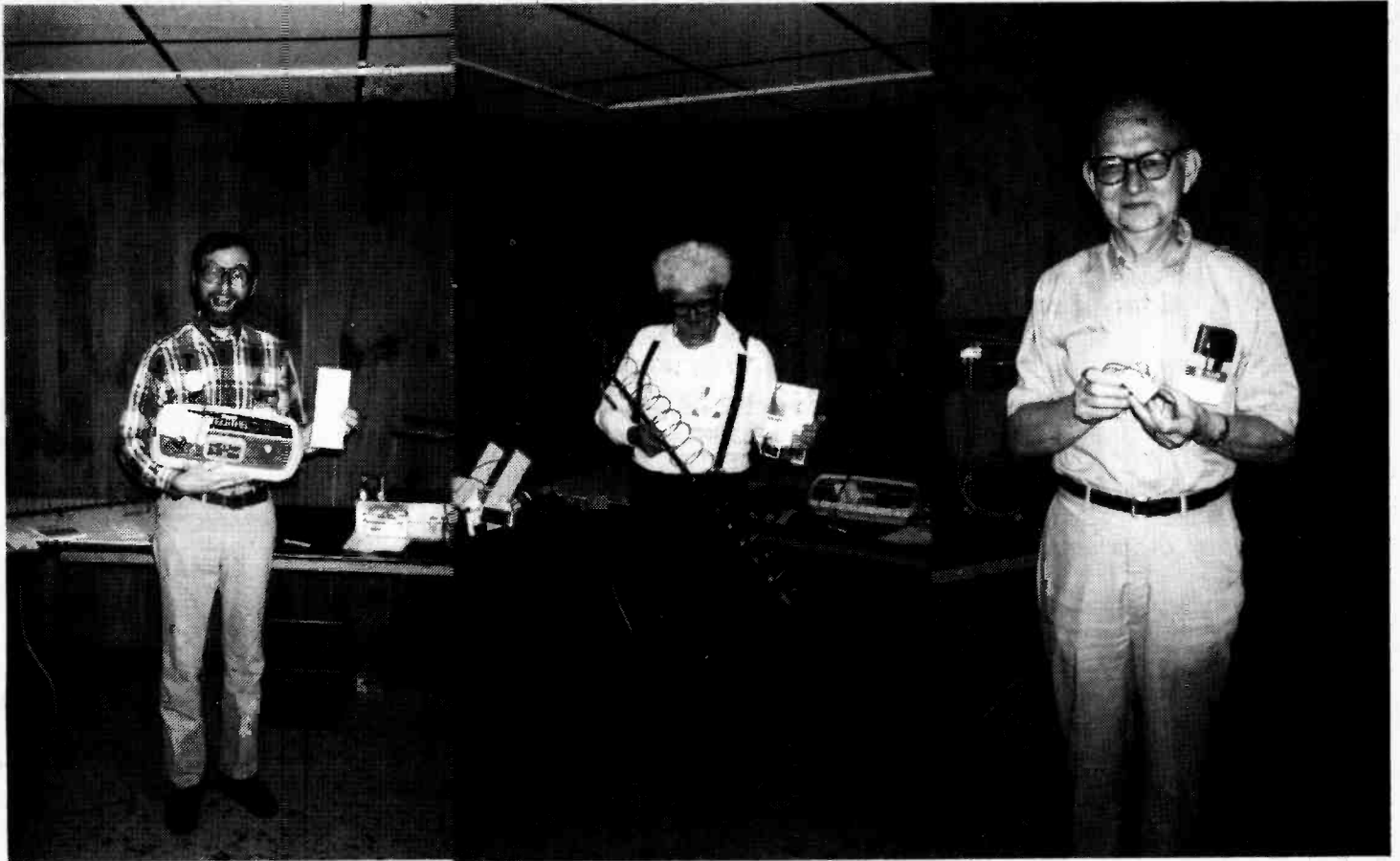

**K3TAZ "ATV Pong"**

**W3WV 900 Mhz Loop Yagi.**

**K3GXU MRF 901 Pre-amp**



**KA3ATH - Big Wheel**

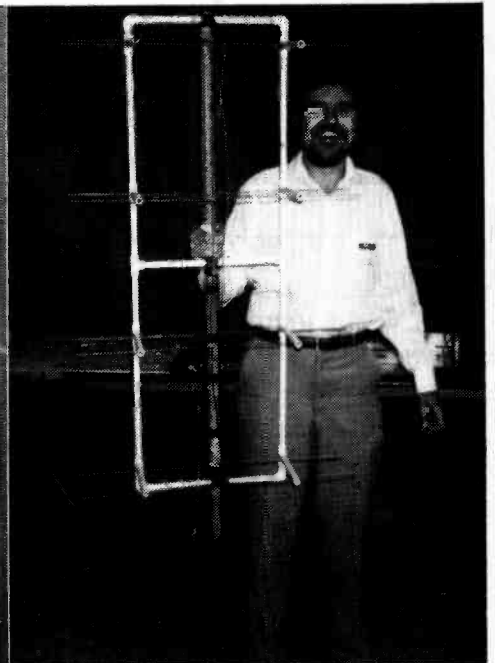

**WA3USG - PVC Collinear**

# WESTERN WASHINGTON AMATEUR TELEVISION SOCIETY AND AMATEUR TELEVISION QUARTERLY

## AMATEUR TELEVISION VIDEO TAPE CONTEST

--- first prize: ICOM IC 1275 1.2 Ghz ALL MODE TRANSCEIVER\* ---

--- second prize: AEA FS430 ATV TRANSCEIVER ---

third prize: PC Electronics RX converter of your choice

**20!** additional prizes to be announced



Have we gotten your interest? Are we motivating you? GOOD!

All you have to do is make a VIDEO about ham radio using your home VHS/Beta or 8mm video equipment!

### RULES OF THE CONTEST

All licensed amateur radio operators are eligible to win except members and families of the Western Washington Amateur Television Society (WWATS), Amateur Television Quarterly Magazine (ATVQ), or publishers or staff of any other ham radio magazine. That leaves about a half million US hams and any other ham in the world!

Your video tape should be about ham radio (any aspect) and have been made since May 1988. The tape must not exceed 15 minutes in length. You cannot use professional video equipment (3/4", 1") in your production chain, only consumer grade equipment: ie S-VHS, VHS, Beta, 8mm, Super Beta, etc.

Only one entry per licensed amateur please. Video must be amateur radio related and can be a documentary, educational, technical or entertainment.

Entries will be judged on the basis of creativity, technical merit and effective use of the video medium. Contestants must be original producers. Violation of copyright laws is prohibited and disqualifying.

Winners will be selected by the WWATS appointed judges. Their decision is FINAL. No substitution of prizes or exchange for cash value allowed. Any state, local or federal tax applicable is the responsibility of the recipient. Offer void where prohibited by law. Winners may be required to attest to compliance with rules of the contest.

Winners will be announced at 1990 Dayton Hamvention. Winner need not be present! All entries become the property of WWATS and ATVQ for the promotional use of ham radio and editorial and promotional uses.

Entries must be post marked no later than March 1, 1990. Postage due mail will not be accepted. Sponsors and prize donors assume no responsibility for lost or damaged entries. Return postage must accompany any videocassette to be returned, otherwise entries become the property of WWATS. WWATS is responsible for delivery of prizes to winners.

### OFFICIAL ENTRY FORM

CALL: \_\_\_\_\_ NAME: \_\_\_\_\_

ADDRESS: \_\_\_\_\_

CITY: \_\_\_\_\_ STATE: \_\_\_\_\_ COUNTRY: \_\_\_\_\_ ZIP: \_\_\_\_\_

Certification: I hereby enter the WWATS/ATVQ contest and agree to abide by the rules as stated above and accept the decision of the judges. My entry is enclosed. I declare that I am the producer of this video and release all rights of copyright to WWATS and ATVQ in exchange for consideration for the prizes listed above.

DATE: \_\_\_\_\_ Signature: \_\_\_\_\_

\*Agreement with Icom requires 100 valid entries to contest. Enter soon, tell your friends!

SEND ENTRY TO: WWATS/ATVQ VIDEO CONTEST, 353 S. 116TH ST. SEATTLE, WA 98168  
Entry form may be copied as needed.

**ENTER EARLY ENTER OFTEN**

# The w6ORGy Notes

By Tom O'Hara, W6ORG

## THE 100 WATT SOLID STATE 70 CM AMATEUR AMP BARRIER HAS BEEN BREACHED!

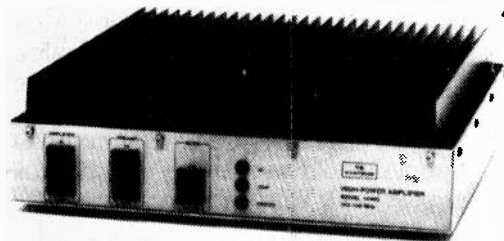

TE Systems now has a 180 Watt amp for the guy that just has to have the biggest solid state amp on the block.

Dave, K6QDD, chief engineer at TE promised me a 4450G 10 in / 180 out amp to check out and ATVize but unfortunately it did not arrive in time to present the results in this issue. Those that can't wait can call me or sit on pins and needles for the next thrill packed ATVQ issue.

However from their ad and talking to Dave, the first thing to note is that you need a 13.8 Vdc regulated power supply capable of 39 Amps. Jumping up to this level requires checking the AC load pull of your already over worked wall sockets in the ham shack, as well as making sure the legs on the operating table are sturdy enough to handle the added power supply weight (Astron RS50M's weigh 46 lbs). The amp is about 3 x 10 x 12" and weighs 8 lbs.

The amplifier itself is quite broad in bandwidth. The preamp is actually why they ask you to specify a desired 10 MHz slot in the 70 CM band. They designed the preamp bandpass filter to be a little over 3 dB down over a 10 MHz bandwidth to cut down some strong near by just outside the band commercial transmitters. You can order the amp without the preamp if desired. The GaAsfet preamp gain at it's center tuned frequency is listed as 12 dB with a noise figure of 1.1 dB. This is enough to cover the insertion loss in receive of the attenuators you might have to put in to reach the right drive level.

T/R switching is automatic with RF sensing or by remote control. There is thermal shut down for the alligators

among us, or a continuous duty repeater version. Besides the 10 Watt input amp there is also a 25 Watt input model. Price is listed at \$503 for the 4450G (10 in) and \$479 for the 4452G (25 in) amps.

## FIRST ATV UP TO A MANNED SPACE VEHICLE MAY HAPPEN THIS YEAR.

Not only will this be the first amateur real time video received by the Space Shuttle, but also the first time by NASA. The NASA Select video we have been seeing and repeating on local ATV repeaters, is only one way from the Shuttle, they have no uplink video receive capability. The astronauts will for the first time be able to see who they are talking to. Some of the wives and families might be at one of the uplink sites during the mission.

I have been working with Andy Bachler, N9AB, and the Motorola ARC in Schaumburg Il for some time to get ATV into one of the Shuttle flights. NASA asked the Motorola group to build a new window mounted antenna that would cover both 2 meters and 70 CM, and an ATV receiver.

As a starting point they used the P.C. Electronics TVCX-70 crystal controlled downconverter into a VRC45 receiver. They re-laid it all out with some mods to make it as small as possible and to fit a specific form factor that would be compatible within the Shuttle.

The hardware side however is the easier part of the task. Fitting amateur radio operations into a Shuttle mission and getting all the OK's is the tough part.

Most hams do not know that there is a separate set of FCC rules for space operation. They can be found in subpart H of part 97 titled Amateur-Satellite Service. For instance, any intended station for operation in space has to submit information to the FCC beginning 27 months in advance. Only an extra class can be the licensee (not enforced on previous Shuttle flights) of the space transmitter. The space frequencies

are limited to small segments of the amateur service bands.

In order to use the wide ATV bandwidth or any of the other variables that were not foreseen when the Amateur-Satellite Service rules were drawn up, a request for Special Temporary Authority (STA) must be made and approved.

Andy, N9AB, met with the ARRL "Hams in Space" SAREX (Shuttle Amateur Radio Experiment) committee last November and presented the status on the antenna and ATV equipment. While the meeting emphasis was on packet for the STS-35 mission, there still seems to be a possibility for ATV on STS-37 with Pilot Ken Cameron, KB5AWP, some time mid year. We hope to have an update for you next time and at the Dayton Hamvention Saturday afternoon ATV Forum.

Members of the SAREX committee are: Roy Neal, K6DUE, Chairman, Jon Bloom, KE3Z ARRL HQ Staff, Lou McFadin, W5DID, Johnson Space Center ARC, and Bill Tynan, W3XO, AMSAT. It would help if you dropped one or all of them a short note supporting ATV on STS-37, future Shuttle missions and the Space Station.

The SAREX committee needs to know that there is a large body of hams out there that are on and use ATV, and are also interested in Space activity. If your local repeater has the NASA Select video mention that also especially if anyone has set up a receiver at a local school. Keep your note short and positive, we need to get the ATV mode started and in the minds of the mission planners.

This first use of ATV is an experiment and hopefully will be a successful foot in the door for future Shuttle missions and onward to the Space Station. These first few experiments will list only 8 NASA affiliated radio clubs on the STA's as the ground stations. If all works out then expansion later to two way video and to the general amateur population via the home stations or centralized repeater/uplink stations might be possible.

One of the plans is for JPL (Jet Propulsion Lab in Pasadena CA), as one of the NASA affiliated radio clubs

on the STA list, to uplink video of some of the school children as they ask questions of the Shuttle crew. In fact JPL has a Teaching Resource Center where many of the personnel are hams and have a close relationship with local schools to promote science and space exploration. I have been a member of the JPL radio club ever since the first Voyager mission where I set up video links and a repeater to enable So. California hams to see the direct video right out of the computer processor.

### HAZ-MAT, THE LATEST BUZZ WORD FOR NEW EQUIPMENT REQUIREMENTS AMONG EMERGENCY SERVICES GROUPS.

HAZardous MATerials, pollution, contamination, toxic chemical fires and spills are all in the news these days. How does ATV fit in? Fire departments and emergency response groups are asking hams in their RACES and AREC groups for ATV remote camera coverage on the haz-mat site, transmitting to command and control centers when instantaneous decisions have to be made but it is too dangerous to have a person on the scene. Now in the aftermath of the earthquake and hurricane this year, emergency service groups have found that the same gear can be used for remote damage assessment.

A camera, tripod, antenna and transmitter are quickly carried to the scene by a protected individual, turned on and left. The video is received a safe distance away to be observed by the field supervisor.

This can be done with any of the 1 Watt 70 CM portable transmitters on 426.25 MHz or on 33 or 23 CM to give the least chance of receiver overload from public safety radios above 450 MHz. Spectrum International PSF 426 - ATV VSB filters may be required on the antenna coax line depending on the other radios frequency and power.

I suggest the use of small 6 element beams rather than omni's not so much for the added gain, but to minimize the multipath reflections. The KLM 440-6X has 8-9 dBd gain and a very alignment forgiving 60 degree beamwidth.

Some areas have expanded their capabilities with portable crossband repeaters. Crossband repeaters are easier to put together because they are much less susceptible to desense and more forgiving as to construction practices than inband repeaters. The portables transmit to the on site communications van which in turn retransmit the video to headquarters direct or through the local ATV repeater.

In this case I suggest the portable transmitters be on 910.25 and the retransmitter on the same frequency as your local ATV repeater input. Although VSB or broader bandpass filters may not be a requirement to prevent desense at your portable crossband repeater, given judicious placement of antennas and shielding, it is a good idea to plan on it if there are any other transmitters close by that could overload your receiver or vice versa.

The ELK video identifier and VOR-2 board in it's own shielded box would take care of the ID requirement automatically without having to remember the 10 minute or final transmission rule.

Actually there is no reason why anyone cannot have a simple crossband repeater or full duplex system at home by just plugging the video and audio outputs from some equipped TV's or VCR's with built in tuners into the transmitter. This would give much more flexibility by having numbers of ATVers in the area capable of retransmitting from the portables in the field through their home repeater. In addition these people would be able to also run full duplex ATV with others.

### THINKING ABOUT PUTTING UP AN ATV REPEATER? PART II

Last time we talked about planning and the importance of picking the site and frequencies. The next step is to make tests at the planned site to see what the coverage and interference patterns might be. I suggest two trips.

The first time to do it is when the other site transmitters are on the air, and the second when convenient to get most of the ATVers in the area on the air. I know of people who thought they had a nice quiet site when they went up to the hill top on a nice Sunday afternoon with their ATV transceiver and had no problems, but were wiped out by intermods from pagers and RCC transmitters during normal business hours. Or the one ATVer who was your best supporter has a multipath ghost or building blocking the path.

So make your tests over a long enough period of time during the peak use segments of the day that the other transmitters are operating. Get the word out to the local gang about the test hours, day, ATV frequency and 2 meter coordination talk back channel in plenty of time.

Each case of interference is unique and the cure can be equally unique such that it could take up many installments in this column itself. But most often the cause is insufficient filtering and shielding both by the ATV system and other systems at the same site or within a few miles.

You may find some interference from other mode users quite a distance away will appear with the antenna now quite a bit higher in the air than you have at home. While frequency coordinators may give you

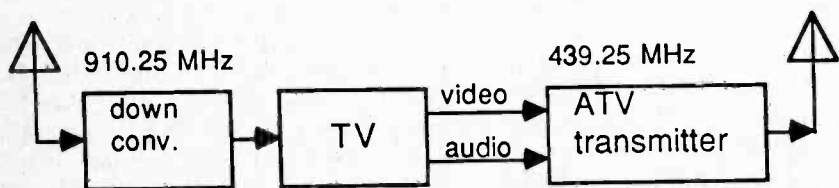

Basic home or emergency crossband repeater. Use an AC/12VDC small portable TV or VCR with a tuner that have video and audio outputs - simply jumper over to the ATV transmitter. Or connect camera instead for full duplex simultaneous xmit and receive ATV.



## The w6ORGy Notes Cont.

a frequency, it is difficult to accurately predict if a distant link or repeater could be seen at your site.

Assuming the site checks out good and your potential users and supporters are happy with the signal strength from your test transmissions at the site, and you have a test coordination, you are ready to start building the machine.

The longest lead item is usually the VSB filters and should be ordered first. I suggest TX RX systems for the least insertion loss and highest power handling capability especially for the transmitter. Spectrum International has a little higher insertion loss, lower power handling capability and lower cost. I suggest only using them on the receiver antenna coax line or on transmitters up to 50 Watts if cost is more of a factor than performance with your system.

Next is feed line. All coax needs to have 100% shielding both down from the antenna as well as all interconnects. RG55 double shielded 50 Ohm coax is good for interconnects.

With the antenna line you have performance verses cost considerations. The best line to the antenna would be 1" copper hard line down to Belden 9913 depending on the length you need to run. Up to 100 ft, 9913 at 2.5 dB loss per hundred feet is not too bad. Over 100 feet on 70 CM or on 33 and 23 CM, the largest copper hardline you can afford to keep the loss down to 2-3 dB is the way to go.

Use one continuous run and type N connectors to minimize moisture contamination or connector losses. I do not suggest aluminum hard line as the shield often oxidizes and loosens at the connectors from moisture and wind vibration (job security for many cable company maintenance personnel).

Route the cable separated from other cables as much as possible, especially the receive, to minimize cross talk. After you verify all is well with a power meter check at both the transmitter and load ends of the cable, weather proof all outside connectors with coax seal or 2 layers of vinyl electrical tape. Secure the cable up the tower at different distances to minimize mechanical resonances that can occur in high wind conditions.

Most all repeater antennas are intended to be omni directional. They will probably only be omni if your antenna is the one in the clear on top. But at any shared electronic site yours will be one out of many at the antenna farm. You may not have many mounting options that would not greatly affect the antenna omni pattern.

All you can do is to try to stick it out 2 or more wavelengths from any other metal supports or antennas on an arm. This is another reason to know what frequency your neighbors are on so you can have the most vertical separation from those closest to your frequency.

Think of the worst storm in your area you can remember, add many pounds of ice, and then solidly mount your antenna to the structure with that in mind...plus keep your fingers crossed! Support the antenna with a cross arm not only at the bottom, but an insulated one at the top.

When the repeater antenna and coax is installed it is not a bad idea to check out the coverage again, just to see if the mounting didn't happen to put a null right toward the meanest most vocal ATVer in the area. Moving the mounting a few inches can often change the pattern to a new set of conditions.

With all omni antennas, vertical or horizontally polarized, the higher the gain, the narrower the vertical beam width. This could be a problem for those close to the repeater if the site is 500 ft or more above the average terrain. The cure would be a down tilt antenna (usually the resonant length is just above the transmitting frequency for the down tilt) or a lower gain and therefore broader beamwidth antenna. Antenna placement again could be the cause by putting a null right at the wrong guy (another one of Murphey's laws). You generally want the highest gain at the horizon in the vertical lobe for DX. The signal is usually still quite strong close in such that the vertical lobe gain roll off at large angles below the horizon will still give a snow free picture.

Telewave, Sinclair, DB products and others make 70CM 6 to 10 dB broadband exposed dipole type vertical omnis. Lindsay makes the TZU zig zag type horizontal omni. Since the antenna measuring contest at Dayton last year they have done some work on the TZU to improve the circularity and also have a new 8 bay version with 9 dBd. Other amateur vertical omnis can be used, but make sure they have gain and low VSWR at your chosen 70 CM frequency, especially at the low end of the band. Most were made for 440-450 MHz.

On 33 and 23 CM, NCG Co. and RF Parts have 10 dBd vertical omnis in the \$100 to \$150 area. I am not aware of any commercially available horizontal omnis for these bands. Homebrew omnis have periodically appeared in the magazines and almost every year I have had someone present the latest horizontal omni designs at the Saturday afternoon ATV Forum in Dayton.

I have not heard of anything new past the W6OAL big wheels last summer. But then late spring and summer is when most of the antenna work is done by those of you in the colder climes and also the various UHF Conference antenna measuring contest are held then.

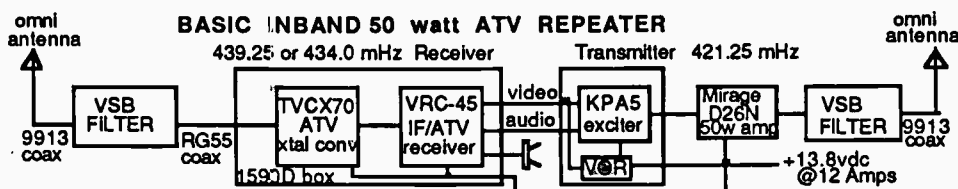

Frequencies and modules will vary depending on inband or crossband repeat. Inband may also use a TX-RX Duplexer to one antenna instead of two. The Video Operated Relay may be put with a WB8ELK video ID board in it's own 1590D box instead of in the exciter box and the video cable run in and out of it.

**DOWNEAST MICROWAVE  
SOLID STATE 70 WATT  
23 CM AMP.**

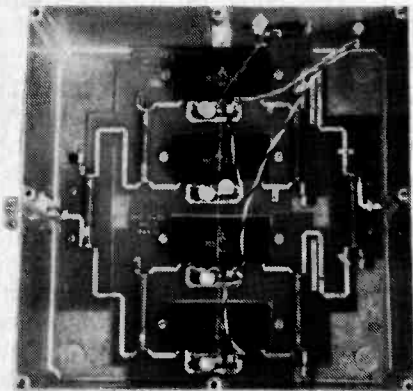

Bill Olson finally sent me the 4 Mitsubishi brick 2370PA amp to check out on ATV. It did a nice job and I only had to add a few caps on the + lines to keep the modulated video waveform from loading. The + leads from the feedthrough cap need to be larger (L and R drop) as well as a note to use large diameter wire (#10 or better) to the power supply.

This prototype amp I received had bricks from different production lots. So according to Bill, the power matching was not optimum. All future amps will have same lot bricks in them. His tests with matched bricks yielded 78 Watts out in saturation with 5 Watts input. The amp had good linearity on ATV up to about 50 Watts out with almost 2 Watts drive such that you could almost get away without a sync stretcher. Above this level the sync stretcher in the TX23-1 came more into play and the pedestal pot had to be reset to maintain the proper video to sync ratio.

One watt from the TX23 transmitter gave 39 Watts out which is just a little more than the 35 watt amp with 2 bricks previously tested. In order to get full power out of the 2370PA, a 2305PA intermediate amp has to be placed between them.

IN	OUT	dB	Amps	Eff%
.25	13	17.2	8	12
.5	23	16.6	10	17
.75	31	16.2	11	20
1.0	39	15.9	12	23
1.5	48	15.1	14	25
2.0	55	14.4	15	27
3.0	60	13.0	16	27
5.0	64	11.1	17	27

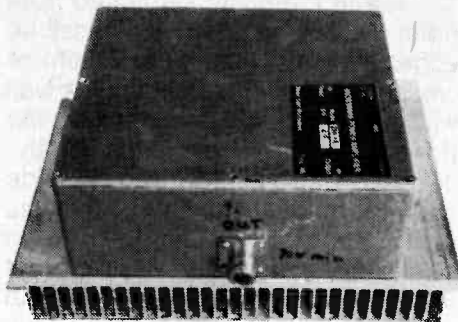

Cables and connectors were quite critical at the test frequency of 1277.25 MHz and high power. I suggest only 1/2" low loss coax like Belden 8214 be used for interconnections and 9913 as a minimum to the antenna. Watts were lost going from a 2 ft RG 58 cable to the power meter versus direct connection with a double male N connector.

Idling current with no drive was 2.7 Amps and over a long period of time will warm up the heat sync. Air needed to be blown over the fins while in operation if powered on for more than 5 minutes at a time.

This would be a great crossband repeater output amp for any mode. It could also be good for trying to get into the Webersat if you have enough antenna and low loss feed. For those that want more, I suggest the 2316PA sold state amp driving one of the Hi-Spec 100-200 Watt tube amps.

**UNIDEN CCD BLACK  
AND WHITE LOW COST  
CAMERA FINALLY  
AVAILABLE WITHOUT  
THE MONITOR**

Although announced at Dayton last year, the cameras have not come into distribution until now. Known as the model VM110, it has been successfully used already on ATV in a R/C helicopter (KC6CCC) and a large kite (WM8W). I described the whole system in last issues column. Price from PC is \$120 delivered.

The reason Uniden supplies the camera separate now is because they have a 3 camera switcher to add to their basic monitoring/intercom system. They assume that you have the manual to hook it up from when you bought the OnSight VM100 or

200 system. So no info comes with the VM110 camera.

However there is little need for a manual since it connects up and works quite simply. There are three 66 foot long wires. Black is common ground, red is +12 Vdc @ 200 mA and yellow is composite video out. Since this is not high resolution black and white video, they seem to be able to get away with not running 75 Ohm coax on the video. I would bet however that the supplied cable is close to a balanced 75 Ohms.

If you want to connect it to a 10 pin VHS plug, black goes to pin 9, red to pin 10 and yellow to pin 1. The plugs are hard to find and expensive. However I suggest calling Digi-Key at 1-800-3444539 for their catalog and the 10 pin VHS plug. It is their part number HR-106 and runs about \$11 + shipping and handling. Their 140 page catalog has a lot of parts and goodies besides video connectors.

**AEA IS ADVERTISING A  
NEW A MODEL FSTV-430  
TRANSCEIVER AND  
ANTENNA MOUNTED 50  
WATT AMP**

I called Mike Lamb, president of AEA, to get the straight poop on the A model, amp and discuss some of the technical points they brought out in the ad.

The A model will have most of the changes I outlined in previous issues plus a bigger transistor in the final in order to better preserve the low level VSB filter passband. As I noted in last Januaries issue, the intermod component of an amplifier re-inserts the rejected VSB. The rule of thumb is to select a device that is linearly run at 10% of it's saturated power. Therefore a 10 to 15 Watt device is biased and run at 1 Watt.

I am anxious to check out the new A model to see the improvement. The spectrum analyzer picture in the ad really doesn't tell the story since the video gain is turned down to zero. I can duplicate the ad picture with a tweaked DSB rig video gain and sync stretcher turned to zero, and the sound subcarrier cranked up. A 100% modulated video multiburst like we did in last months issue tells the true story. I hope to get one for test before the next issue.

## The w6ORGy Notes Cont.

The new LA-430/50 antenna mounted amp and power supply looks very interesting. It should work for all 1 Watt ATV rigs. The amp has linear 28 Vdc devices in an effort again to maintain low IM preservation of the FSTV-430 rolled off LSB. The ad says that the one sideband is still reduced 30 dB. The power supply has a voltage control to set the gain of the amp to match the transceiver output power less the feed line loss.

Mike said they were going to calibrate the knob in feet of RG213, but I suggested instead a set up procedure like we have for any amp with a power meter in the output. There are too many variables to make that calibration of any use: transceiver output power, various types of coax and connectors used, variations in amplifier gains in production, etc. He said that for 50 Watts out on the prototype it took .5 Watt in (20 dB).

Care will have to be taken with the coax installation to keep clean low Ohmic contact between the cable and connectors since the DC voltage uses the same RF coax. Mike said that they were able to filter the DC sufficiently in the amp to keep the video AM/DC power loading from adversely affecting the color and also the fact that 28 Volts runs half the current that similar 13.8 Vdc amps would run.

The companion MPS-100 power supply also has 13.6 Vdc to run the companion transceiver. Price is not yet set but they say they will try to get it down to what a comparable 50 Watt amp and dual power supply would be.

Mike also mentioned that they are going to beef up the boom to a round one from the original square one on their 430-16 antenna. They have not gotten it to any of the antenna measuring contests yet, but maybe Dayton this year.

Prices are not listed in the new AEA ads, it may mean that the higher cost of the final transistor in the FSTV-430 A model will have to be passed on and the actual production costs have yet to be determined. We probably won't know for sure until AEA starts delivering some time in the last part of the first quarter of this year.

The ad also has some misleading statements that I think need to be clarified. It seems to me that it took quite a stretch of an ad man's

imagination to say that VSB is similar in principle to SSB. Some that I have talked to miss-interpreted that all the power advantages given for AM vs SSB voice were the same for VSB vs DSB video. There is no reduced carrier and less than 10% of the actual camera video modulated lower sideband power is attenuated.

VSB does minimize interference to the lower adjacent channel, but on 70 CM ATV what would be the adjacent channel is not generally used. As with broadcast rules, an adjacent channel is not assigned in any given area, but may be a great distance away, over 100 miles depending on terrain and field strength.

VSB helps protect those located in between in a weak signal area to both, or gives enough attenuation in the TV set to receive a weak on channel station in the presence of a strong one 2 channels away. Cable can use adjacent channels because they equalize the amplitude of all channels and have very sharp VSB filters at the input of the combiners.

On 70 CM ATV, the channels are varied and not normally 6 MHz apart as in broadcast. Only one channel is normally used by most ATVers in an area. Those on 439 don't have to worry about getting into someone on 426. Repeaters use more than 2 channel separation or >12 MHz.

However in some areas there may be some odd separations where VSB would help the overlap if both channels are in use at the same time. For instance a station on 434 DSB would have LSB sound and color subcarriers within the passband for someone receiving on 426 or 427.

Actually most of the video energy is in *both* sidebands VSB or DSB. Over 90% of the video power in the average picture is within the first MHz of both sidebands. VSB only starts rolling off at -.75 MHz. Take a look at the spectrum analyzer picture of a VSB broadcast TV station in chapter 20 of the ARRL Handbook. Also the desired response bandwidth is not about half for VSB but closer to 2/3 (9.1 MHz vs 6.0 MHz).

VSB modulation is not required by the FCC for broadcast stations, just the radiated spectrum must follow the VSB 6 MHz channel attenuation spec in the rules. Most broadcast TV

stations modulate DSB with grid modulation at the 100 to 500 Watt level and all have to have VSB filters in the antenna line to assure high out of passband attenuation and intermod rejection.

## NEW PART 15 RULES AND AVM WILL LIKELY GIVE ATVERS INTERFERENCE PROBLEMS

SCRRBA, the Southern California Repeater and Remote Base Assn. has suspended all coordination on the 33 CM band (902-928 MHz). This is because International Teletrac Systems has notified SCRRBA that they will occupy 904-912 MHz with their commercial radio location service beginning this year, and will be in 38 other major metropolitan areas by 1992.

The AVM (automatic Vehicle Monitoring) systems and ISM (Industrial Scientific and Medical) services have priority over the Amateur service. Therefore repeater councils cannot assign any repeater systems in the used segments by these services once interference is noted or they are notified.

ATV repeaters in the affected large metropolitan areas on 923.25 MHz will probably be unaffected, and low power occasional simplex will go unnoticed on 910.25 MHz to the AVM multiple hill top sites.

You could also come upon 1 watt video or data signals anywhere in the band from those licensed in the ISM service.

New part 15 rules could allow your neighbors to legally put unlicensed transmitters on 33 CM as long as the radiated field strength does not exceed 50,000 microvolts per meter of antenna measured at 3 meters. This is enough to get a snow free picture over a tenth of a mile away.

Intentional radiation on broadcast TV channels is still forbidden, but on 70 CM the field strength limit is enough to get a picture 100 ft away. Depending on what your neighbor has on camera, it could be interesting.

*73 es Happy New Decade,  
Tom O'Hara, W6ORG  
2522 Paxson Lane  
Arcadia CA 91007  
(818) 447-4565*

# SCRRBA

Southern California Repeater and  
Remote Base Association  
P.O. Box 5967  
Pasadena, California 91117

\*\*\*\*\*NEWS RELEASE FOR IMMEDIATE PUBLICATION\*\*\*\*\*

## SCRRBA SUSPENDS COORDINATION ON 33 CM

Effective December 7, 1989, the Southern California Repeater and Remote Base Association (SCRRBA) will suspend all coordination on the 33 CM band (902 - 928 MHz). International Teletrac Systems (ITS), a subsidiary of Pacific Telesis Group, will begin operation of a commercial radiolocation service in the greater Los Angeles/Orange County area in 1990. This system will occupy 8 MHz of spectrum (904 - 912 MHz) and is capable of locating more than 3 million vehicle positions in a 24 hour period of time.

The ITS radiolocation system is on the air in Los Angeles on the 33 CM band. Suspension of coordination by SCRRBA is in accord with CFR Title 47, FCC Rules & Regulations, 97.303 (g)(1). The Amateur Radio Service (ARS) is secondary to automatic vehicle monitoring systems (radiolocation) and shall not cause them harmful interference. The SCRRBA Technical Committee will meet with ITS to evaluate Southern California ARS use of the band. The Technical Committee will then determine what options are available to the ARS community in Southern California. Some of the options to be considered are as follows:

- o Continue coordination with the current band plan
- o Make minor adjustments to the current band plan
- o Sponsor a band planning meeting for a new band plan

This news release should serve to alert other Coordination Councils and/or Coordinators that similar issues will soon face them. A published schedule of commercial radiolocation service by ITS includes the following 38 metropolitan areas:

By 1991 - Atlanta, Baltimore, Boston, Chicago, Dallas, Detroit, Houston, Miami, New York City, Philadelphia, Pittsburgh, San Diego, San Francisco, & Washington D.C.

By 1992 - Buffalo, Cincinnati, Cleveland, Columbus, Denver, Ft. Lauderdale, Hartford, Indianapolis, Kansas City, Memphis, Milwaukee, Minneapolis, Newark, New Orleans, Phoenix, Portland, Rochester, Sacramento, Salt Lake City, San Antonio, San Jose, Seattle, St. Louis, & Tampa/ St. Petersburg,

SCRRBA will make additional announcements as events develop.

Bill Kelsey, WA6FVC  
Chairman

\*\*\*\*\*





P.C. ELECTRONICS 2522 PAXSON LANE ARCADIA CA 91007-8537 USA  
 TOM (W6ORG) & MARYANN (WB6YSS) O'HARA (818)447-4565

24 hr FAX order line (818) 447-0489



ONLY  
**\$329\*** Delivered

Value plus  
 quality from over  
 25 years in ATV

**AMATEUR  
 TELEVISION**

**TC70-1 TRANSCEIVER**

WITH THE 1990 TC70-1dYOU GET:

1. Improved sync stretcher with both adjustable blanking pedestal and sync controls.

Allows you to better set up any amplifier for optimum video to sync ratio and stretch the sync without cutting off the sound by driving it into saturation. By setting the sync tip to just 1.5 dB (86%) of your ATV amplifiers saturation power, you get enough headroom to be able to increase the sound injection to -15 dBc and make it go farther without being chopped up at the sync rate (sync buzz). -15 dBc is the FCC limit for TV translators or those that do not run separate sound transmitters. The limit is due to the fact that the sound will bottom out at a fully modulated white level (12.5%) when the sound is added to the video waveform.

2. SET UP YOUR CAMERA PICTURE IN THE MONITOR WHILE RECEIVING ANOTHER ATVER.

Camera video is now present at the transmit video monitor output while in receive. While watching other stations, you can point and set up your camera well before it is your turn to transmit. When in transmit you still are switched to seeing the actual detected video present at the antenna output. This is the only true way to see what is really being transmitted after it passes from your camera and all the stages of the transmitter.

WITH P.C. ELECTRONICS YOU ALWAYS GET:

Total prices listed delivered to you via UPS surface with no fine print handling, shipping or charge card costs. The widest variety of ATV gear available with most telephone orders shipped within 24 hours. We are your one stop ATV source for equipment and information. We have been telling it like it is over 25 years. No one else has our service policy without a time limit. Parts have different life times and in circuit stress ratios. We have even repaired a 12 year old TC-1 at no charge because we could see no customer or normal use reason why a .1 disc ceramic cap decided to open up. Customer caused service on the TC70-1 is only \$40 + parts cost and most repairs are turned around within 3 days after we receive them, we want you back on the air!

**COMPLETE 70CM ATV STATION**

1/90

 <p>YOUR TV SET          YOUR HOME TV CAMERA          OR CAMCORDER</p>	 <p>TC70-1...\$329          ATV Transceiver          &gt;1 WATT P.E.P.</p>	 <p>Mirage D15N.....\$155          (optional) 15 watts RF out.          Mirage D26N.....\$219          (optional) 50 watts RF out.          Mirage D100TVN..\$319          (optional) 70 watts RF out.</p>	 <p>KLM 440-16X 14dBd \$119          KLM 440-10X 11dBd \$65          KLM 440-6X 8.9dBd \$51</p>
---	---	--	--

13.8Vdc  
 Pwr. Sup.

**CALL (818) 447-4565 NOW AND ORDER YOURS! MOST ITEMS SHIPPED WITHIN 24 HOURS**

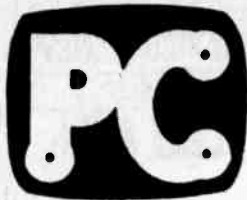

P.C. ELECTRONICS 2522 PAXSON LANE ARCADIA CA 91007-8537 USA  
 TOM (W6ORG) & MARYANN (WB6YSS) O'HARA (818)447-4565

24 hr FAX order line (818) 447-0489

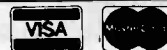

ELECTRONICS

## FULL DUPLEX OR HOME REPEATER SPECIAL

Buy the TX33-1 Transmitter at the 1989 price of \$299 between January 1 and April 1, 1990, and you can get one of the companion TVC-9G Downconverters or TVC-4G or TVC-12G Downconverter at \$30 off it's regular price if purchased at the same time. Price of the TX33-1 goes up to \$329 April first.



### TX33-1 FEATURES:

- >1 Watt p.e.p. output to properly drive the Downeast Microwave 18 Watt amplifier within it's linear range. Sync stretcher - adjustable blanking pedestal to enable fine adjustment of the video to sync ratio out of the amplifier. Specify 910.25, 911.25 or 923.25 MHz.
- Transmit video monitor output. Samples actual video modulated waveform at the antenna connector so you can see exactly what you are transmitting for best video gain and camera setup. In receive you also see your camera video at this jack to enable camera setup before you transmit.
- Built-in RF transmit / receive relay. Downconverter output jack on the back connects to your TVC-9G through your 50 Ohm BNC cable to allow transceive on 33 CM if desired. Switched +13.8 Vdc is also available to power the TVC-9G. RTX-33 dedicated repeater or link version is also available at \$329 without the T/R relay and mounted in a diecast aluminum box.
- Separate mic and line audio controls allow independent mixing of the microphone with the camera, VCR or repeat receiver audio for voice-overs or audio ID.

### TVC-9G 33CM ATV Downconverter.....\$99

Low noise 1 dB noise figure dual gate GaAsfet preamp transistor followed by another one in the mixer to maintain low system noise figure and wide dynamic range. Comes with a wall plug type 12 Volt power supply, or you can connect for external 12 to 14 Vdc from the TX33, mobil, portable, etc., power sources. Knob varicap tunes the whole 902 - 928 MHz band down to channel 2, 3 or 4 (which ever is not used in your area) of your TV set. We also stock the **Tonna 20923** 23 element 16 dBd gain yagi antennas for this band for only \$70 delivered via UPS.

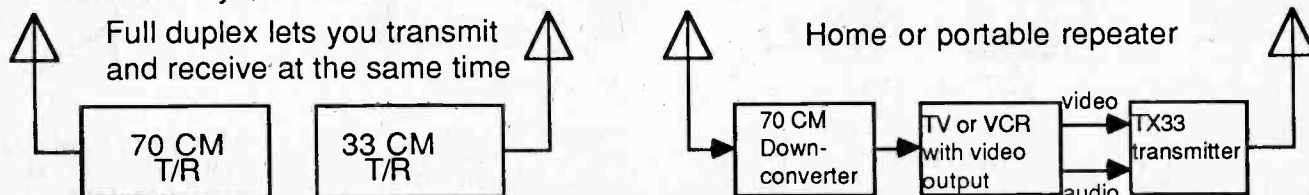

**CALL TO DISCUSS YOUR APPLICATION & TO GET A COMPLETE CATALOG NOW!**

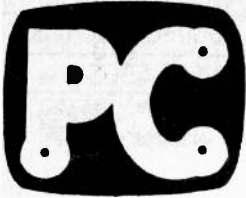

**ELECTRONICS**

**P.C. ELECTRONICS 2522 PAXSON LANE ARCADIA CA 91007-8537 USA**  
**TOM (W6ORG) & MARYANN (WB6YSS) O'HARA (818)447-4565**

24 hr FAX order line (818) 447-0489



## **NEW SMALL TXA5-RC 1 WATT 70 CM VIDEO TRANSMITTER**

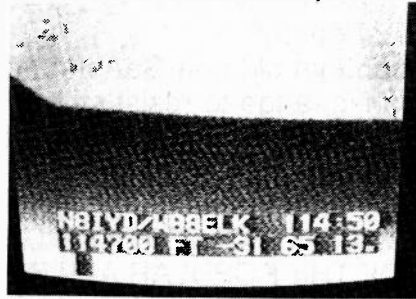
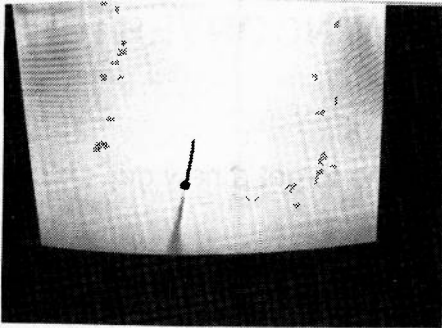

**As a result of the successes of the KPA5 used on 3 of the WB8ELK balloon flights, various kites, rockets and R/C aircraft, we came up with a small video only board to better fit into these crafts.**

### **TXA5-RC FEATURES:**

1. Size only 2.25 x 4.0 inches. Weight 2 ounces. Draws 250 mA at full power with 13.8 Vdc.
2. Comes with single crystal on your specified frequency: 426.25 most popular for R/C, or any of the other standard ATV frequencies of 439.25, 434.0 or 427.25 MHz are stocked.
3. Although not necessary for the R/C application, it does have the sync stretcher incase it is to be used with a higher power amplifier and a sound subcarrier input to accept the FMA5-E. This way it has the flexibility to also be used in portable public service applications, etc., where all of the features of the KPA5 are not necessary but still could be added.
4. Introductory price of \$129. Availability March first.

**UNIDEN VM110 CCD BLACK AND WHITE CAMERA IS HERE!**  
**NEED A LOW COST PER CRASH CAMERA FOR YOUR R/C MODEL, KITE, BALLOON, ETC? THE VM110 IS ONLY \$125 delivered.**



The camera was made for home security applications where low cost, ease of installation and use were more important than high resolution, color, or low light level capability.

Depth of field is less than 1 foot to infinity and has auto iris.

View angle is 40 degrees with the included lens system.

Size is 4.7 x 3.9 x 2.2 inches, weighs less than 7 ounces.

Requires 11 to 14 Vdc at 200 mA

Horizontal resolution is 120 lines with 19440 pixels

Camera with 4.8" monitor model VM100 is \$175

Camera, monitor with intercom audio model VM200 \$199

**KOYO TVC-4000-2 600 LINE RESOLUTION BLACK AND WHITE CAMERA .....\$199**

Low cost for those who cant afford a camcorder yet, or want to leave a camera on a black and white call card for working DX.

120 Vac 60 Hz line locked 2:1 interlace 600 lines horiz. res.

f1.6 C mount lens included.

4 x 2,4 x 8.5 inches, 1.7 lbs.

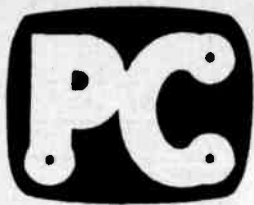

**ELECTRONICS**

**P.C. ELECTRONICS 2522 PAXSON LANE ARCADIA CA 91007-8537 USA**

**TOM (W6ORG) & MARYANN (WB6YSS) O'HARA**

**(818)447-4565**

24 hr FAX order line (818) 447-0489



## ASK YOURSELF, IS IT TIME FOR A NEW DOWNCONVERTER?

Lightning strike, or it has taken it's last gasp?

Like to get a little more sensitivity than that old non-GaAsfet model?

How about good gain but wide dynamic range to resist strong overloads?

Want the latest state of the art model for yourself and loan out the old one to get a new guy on?

I need a new toy!

**WE HAVE TUNEABLE OR CRYSTAL CONTROLLED BOARDS OR READY TO GO GAASFET DOWNCONVERTERS FOR ALL 3 OF THE POPULAR ATV BANDS.**



Tunable wired and tested boards:

TVC-2G 420-450 MHz to ch 3 .....\$49

TVC-9 902-928 MHz to ch 3 .....\$59

Tuneable ready to go in a shielded cabinet with wall plug power supply:

TVC-4G 420-450 MHz to ch 3 .....\$89

TVC-9G 902-928 MHz to ch 3 .....\$99

TVC-12G 1240-1300 MHz to ch 8 .....\$109



Crystal controlled wired and tested boards:

TVCX-70 specify freq. in 420-440 range to ch 3 or IF ...\$99

TVCX-33 " " " 902-928 " " " " " " " " " " ...\$109

TVCX-23 " " " 1240-1300 " " " " " " " " " " ...\$119

Ready to go in 1590C diecast aluminum box add \$30

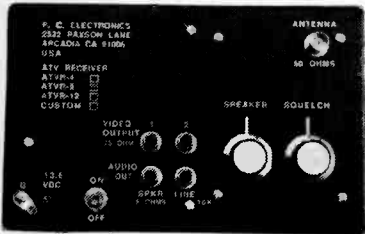

## COMPLETE CRYSTAL CONTROLLED RECEIVERS

Designed for dedicated repeaters or links, these can also be used by those who want to have composite video out to drive a monitor.

2 composite video outputs, 8 Ohm speaker and line audio outputs.

Audio has a variable squelch control. Requires 12 to 14 Vdc @ 250 mA.

Contains TVCX board and VRC-45a receiver boards in a 1590D box.

ATVR-4 specify 420-440 frequency.....\$299

ATVR-9 " 902-928 " .....\$309

ATVR-12 " 1240-1300 " .....\$319

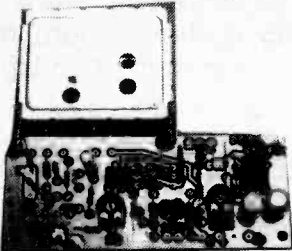

VRC-45a 45.75 MHz IF/receiver module for those who want to package their own system .....\$99

**CALL OR WRITE NOW FOR THE FEBRUARY 1990 CATALOG, A FEW PRICES HAVE CHANGED SINCE THE LAST ONE, AND WE ARE EXPANDING THE LINES.**

**THE FRENCH CUSTOMS STRIKE IS OVER, WE NOW HAVE GOOD STOCK ON THE TONNA 33 AND 23 CM 23 ELEMENT YAGI ANTENNAS.**

**SEE US AT THE TROPICAL HAMBOREE IN MIAMI FEB. 2 BOOTH 10, DAYTON HAMVENTION AT THE SAME SPOT - OUR LUCKY 13TH YEAR.**

Frank WB9KCC in Attica, Indiana has added a new dimension to ATV mobile. He has mounted a modified U-100 rotor to his roof mounted KLM 6 element ATV beam and can actually point his beam as he drives along from the driver's seat. He has made up a number of plywood mounting structures to quickly install his complete ATV mobile station. When arriving at his destination he can remove the self contained ATV station (including battery pack) and carry it immediately to his portable site. Contained in his dashboard console he has an altimeter as well as a Fluxgate compass to determine actual antenna position.

Frank has modified the U-100 rotor as follows:

1) Open up the rotor case and remove the position stops.

2) Remove the AC motor and gear and replace it with a similar sized DC motor with appropriate gear. (You may have to enlarge the mounting holes for the new motor.

3) Use only a 2 wire DC motor. A control box is made such that the polarity is switched for left or right rotation (center off position)

4) Mount the Rotor and antenna assembly to the car roof using a plywood structure with protective felt under-backing and bungie cords to secure it.

5) A quick way of mounting the end mounted 6 element beam is to make up a screw on plumbing coupling. This will allow you to loosen up the coupling and rotate the beam to either horizontal or verti-

#### WB9KCC MOBILE ROTOR MOUNT

cal polarity quickly.

6) Have fun but remember if you run any longer beam not to extend it over the edge of the car or you may have some close encounters with Semi-trucks!

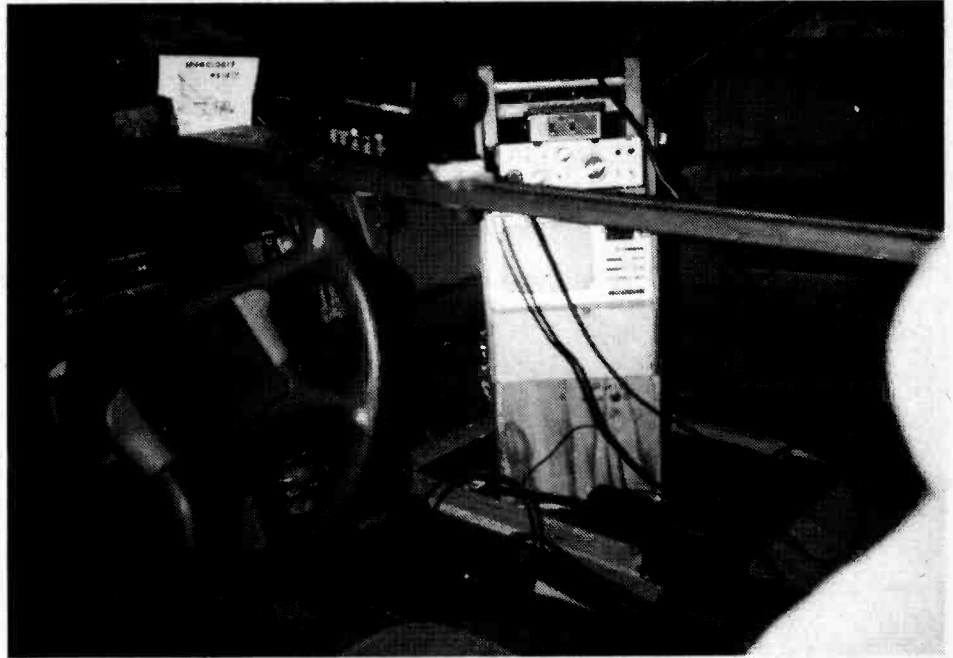

# WB9KCC

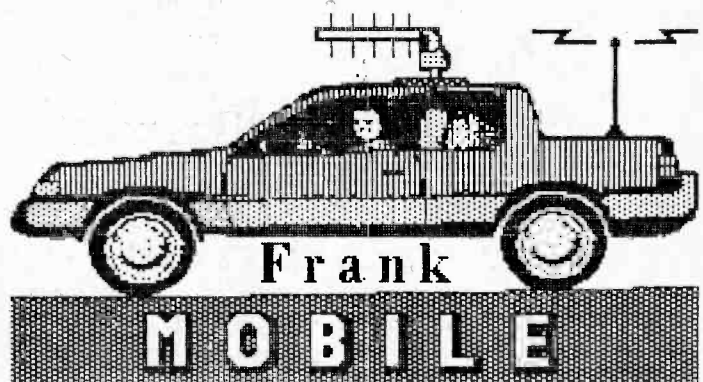



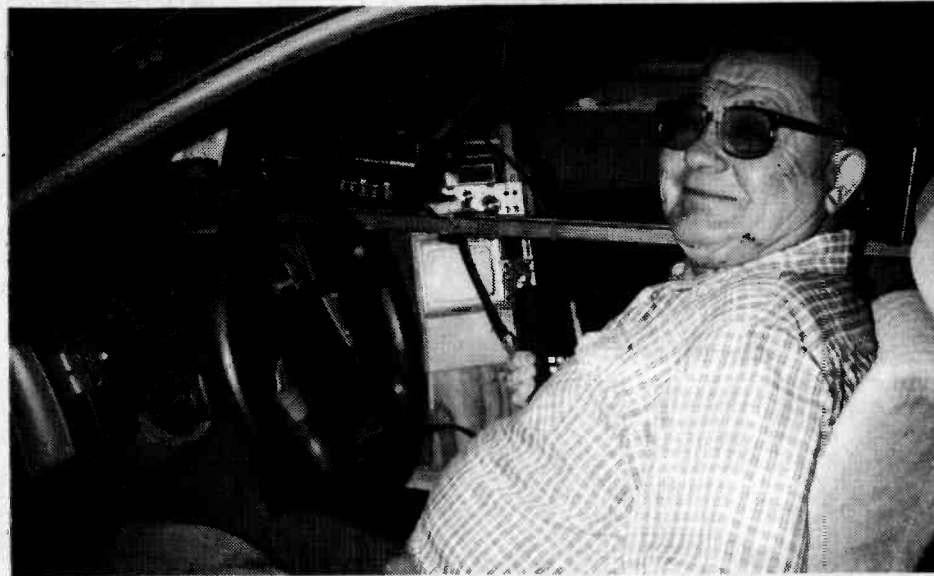
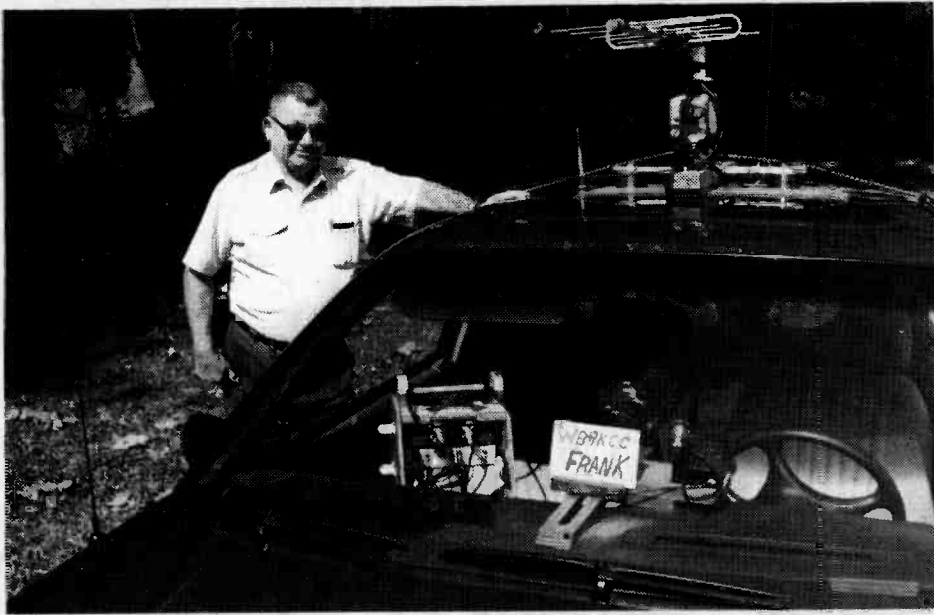

### Mississippi

The first meeting of the Gulf Coast ATV society was held on Dec 9 at Fountain's Restaurant in Biloxi. A total of 19 attended with Warren N4RUC hosting. Represented were Baton Rouge, New Orleans, Ocean Springs, Picayune, Mobile and Pensacola. Bob Spahn WD5BJW was elected NET manager of the weekly voice mail net on 3.878 monday and friday nights. Ron KB5BB was elected chairman and Danny N4UXY was appointed forum manager for the March 31 meeting.

Ken WB5JLZ presented a news release of their repeater in Baton Rouge and agreed to submit articles to various publications about their efforts. Plans were discussed to link the gulf area on ATV. Future meetings will be in March, July, Oct. and the Fort Walton Hamfest. TNX N4RUC



Ken WB5JLZ at Baton Rouge remote camera site (story pg. 52)

## DOWN EAST MICROWAVE

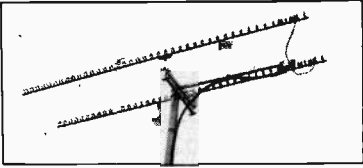

### MICROWAVE ANTENNAS AND EQUIPMENT

- Loop Yagis • Power Dividers • Complete Arrays • GaAs FET Preamps • TROPO • EME • Weak Signal • OSCAR • Microwave Transverters

902 1269 1296 1691 2304 3456 MHz  
 2345 LYK45el 1296 MHz 20dB: \$89  
 1345 LYK45el 2304 MHz 20dB: \$75  
 3333 LYK33el 902 MHz 18.5dB: \$89  
 Above antennas kits available assembled.  
 Add \$8 UPS s/h  
 Add \$11 UPS s/h West of the Mississippi.

### MICROWAVE LINEAR AMPLIFIERS SSB, ATV, REPEATER, OSCAR

2316 PA 1w in 18w out 1240-1300 MHz: \$265  
 2335 PA 10 in 35w out 1240-1300 MHz: \$315  
 3318 PA 1w in 20w out 900-930 MHz: \$265  
 3335 PA 10 in 40w out 900-930 MHz: \$320  
 23LNA preamp 0.7dB N.F. 1296 MHz \$90  
 33LNA preamp 0.9dB N.F. 902 MHz \$90

### NEW PRODUCT ANNOUNCEMENTS

#### New Loop Yagis

1845 LY Loop Yagi 1691 MHz 20dB: \$99  
 945 LY Loop Yagi 3456 MHz 20dB: \$89  
 Above antennas assembled and tested

### New Preamps

13LNA 0.7dB N.F. 12 dB 2.3 GHz \$140  
 18LNA20 0.8dB N.F. 20 dB 1.69 GHz \$140  
 SLNA 1.0dB N.F. 10 dB 2-2.7 GHz \$150

### New Wideband Power Amplifiers

2370 PA 3w in 70w out 1240-1300 MHz \$695  
 2340 PA 2w in 35w out 1240-1300 MHz \$355  
 2318 PAM 1w in 18w out 1240-1300 MHz \$205

Rack mount Amplifiers for repeater use available.

### NO TUNE MICROWAVE LINEAR CONVERTERS

From SHF SYSTEMS a new line of transverters designed by Rick Campbell KK7B and Jim Davey WABNLC

Available in kit form or assembled/tested

- 903 1269 1296 2304 3456 MHz
- microstrip filters eliminate tune-up
- 2m H, PIN diode switched
- sequencer standard in complete unit
- low profile packaging, mast mountable

All active equipment - 13.8V

DOWN EAST MICROWAVE  
 BILL OLSON, W3HQT  
 Box 2310, RR-1 Troy, ME 04987  
 (207) 948-3741

CIRCLE 242 ON READER SERVICE CARD

## KD0FW Balloon Launch Feb 4

Mike, KD0FW plans to launch a helium balloon from Independence, Missouri on Feb. 3 at 9am CST. The payload will have a 15 watt ATV transmitter (P.C. TXA5-2 with MHW-710 amplifier) on 439.25 and a 100 mW signal on 144.34 FM. The 2 meter transmission will consist of a digitized voice message and the video ID will be a timed sequence from a VDG-1. The ATV antenna will be a W6OAL horizontal "Little Wheel" and the two meter antenna will be a 1/4 y groundplane. Since this will be a substantially more powerful signal than used in the previous midwest balloon flights we expect to see a P3 (or better) out to over 350 miles. Although maximum range will be about 380 miles, you should look for it if you live in those locations covered by the shaded area shown on the coverage map due to the fact the balloon may drift towards you. There will be an HF net starting at 8:30 am on 7.155 Mhz for launch coverage and reception reports. Also anyone wishing to help out in the fox hunt effort should contact Mike. This should provide some ATV DX to a good portion of the central states and help make up for the winter DX doldrums. Stay tuned to your BBS as details will be made available a week or two before launch. Also listen to the ATV Net on 3.871 Mhz every Tues. night at 8 pm for launch status. If the weather is bad, the next launch opportunity may be the next day or the following weekend. Contact Mike Bogard KD0FW 2128 S. Norton, Independence, MO 64052 for details.

### Shack Photo of the quarter:

Angelo Fronimos, SV1PL, well known DX'er and ATV'er, Athens, Greece. 5BDXCC, 5BDWAZ, 5BDWAC, CQDX Honor roll, WPX Honor roll, DXCC honor roll, DXCC 160M.



## KD0FW BALLOON

Range at Maximum Altitude  
 (Shaded Area = Max. Potential Reception)

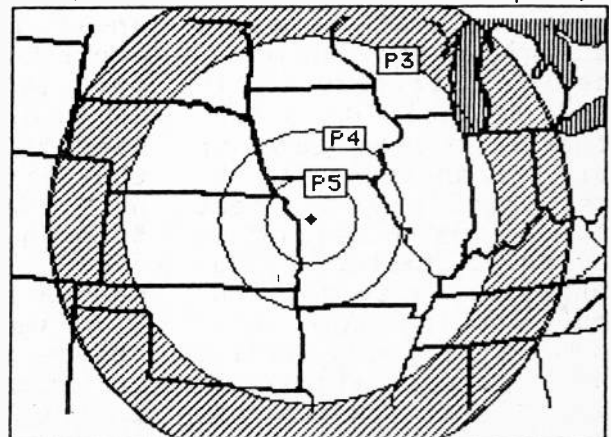

## UK REPEATER CONTROLLER

Trevor Brown G8CJS, 14 Stairfoot Close — Adel, Leeds LS168JR

### England

In the April issue of AT-VQ, page 80, Earl KS8J explains how to control an ATV repeater using the 8052 AH. This chip can be programmed using BASIC Language instructions and is ideal for repeater control applications.

In the UK several TV repeaters use a Z80 based micro-controller which pre-dates the 8052 AH and still has some advantages in cost and ease of construction. The controller is called Teletron and is built on a pc board in a couple of hours using only 5 chips. The PCB is available at a UK price of 4 pounds and even when populated (a process which takes about two hours and 5 chips) represents a considerable cash savings over the 8052 AH.

The input-output again uses the 8255 and any software is EPROM based. The only disadvantage is the use of Machine code to programme the unit. To this end the CPU is a Z80 which uses one of the most easily understood instruction sets. What you gain on the hardware construction front you lose on the programming front. Not a bad trade as learning can be more fun than building, particularly if you are a lethargic type like me.

The UK ATV repeaters differ from their USA counterparts in that they run their transmitters all the time, radiating a test pattern when no input is available. The task of the controller is to pole the input looking for video and when it is satisfied that a video signal is present then switch the input of the transmitter away from the test pattern

and across to the RX. The controller is also required to send out CW idents at regular intervals. Because of the standard operating system of the UK ATV repeaters, it is possible to supply repeater groups with off the shelf software in the form of pre-programmed EPROMS customized with the individual repeater callsign.

Figure 2 shows the circuit diagram of the controller (RAM memory is not required for the standard UK repeater programme and may be omitted). Link 1 is for interrupts which again are not used in the standard repeater programme. Link 2 sets the EPROM type. The input/output is via an 8255 which provides 24 lines, of which only 4 are used. The I/O lines are all available on the card edge connector, and some are routed via a 24 pin dip socket to enable simple additional hardware to be mounted in this socket. C port bit 4 is set up as an input to check when incoming video is present. C port bit 3 is setup as an output which can be used to switch between two electronic test patterns when no video is present. This give a clear on-air indication that the controller is running. C port bit 2 sends out the CW ID and C port bit 1 is used to switch the relay that either routes the RX or the test pattern through to the TX input.

Very little additional hardware is required. Fig. 5 shows the filter that rounds off the square wave computer generated tones in the CW Idents. Fig. 3 is the relay driver for the relay that switches

the sound and pictures between TX and test pattern-controller generated CW ID. The most complex is the video detector (Fig. 6) which is used to monitor the output of the RX and generate a logic level on the controller C 4 port when a video signal is present. This circuit must be able to distinguish between white noise and a video signal. The video signal is used to drive a sync separator, the resultant stripped sync fed to a phase locked loop which is set to free run at 15.625 Khz (UK TV LINE FREQUENCY - Set to 15.750 Khz for US NTSC standard). If the phase-locked loop locks (as in the case when it is fed with the correct frequency syncs) the controller will switch the RX to the TX input, when the signal is removed the test pattern will be switched back and a 'K' sent in CW.

I hope some of the above is useful to would be USA repeater builders. The PCB is available at a cost of 4 pounds plus postage to the States, I can also supply a print out of the Z80 source code used in the standard UK repeater programme should someone be able to produce a USA version EPROM. The PLL can be made to run on USA line frequency by a simple resistor value change.

The Teletron computer is used to control the UK ATV repeater GB3ET. This is an FM ATV repeater with an input on 1249 Mhz and the output on 1316 Mhz. Sound should be on a 6 Mhz sub-carrier and pictures should be pre-emphasized as per CCIR 405. This is all standard for UK repeaters. What is not standard

# TELETRON

FIG. 2

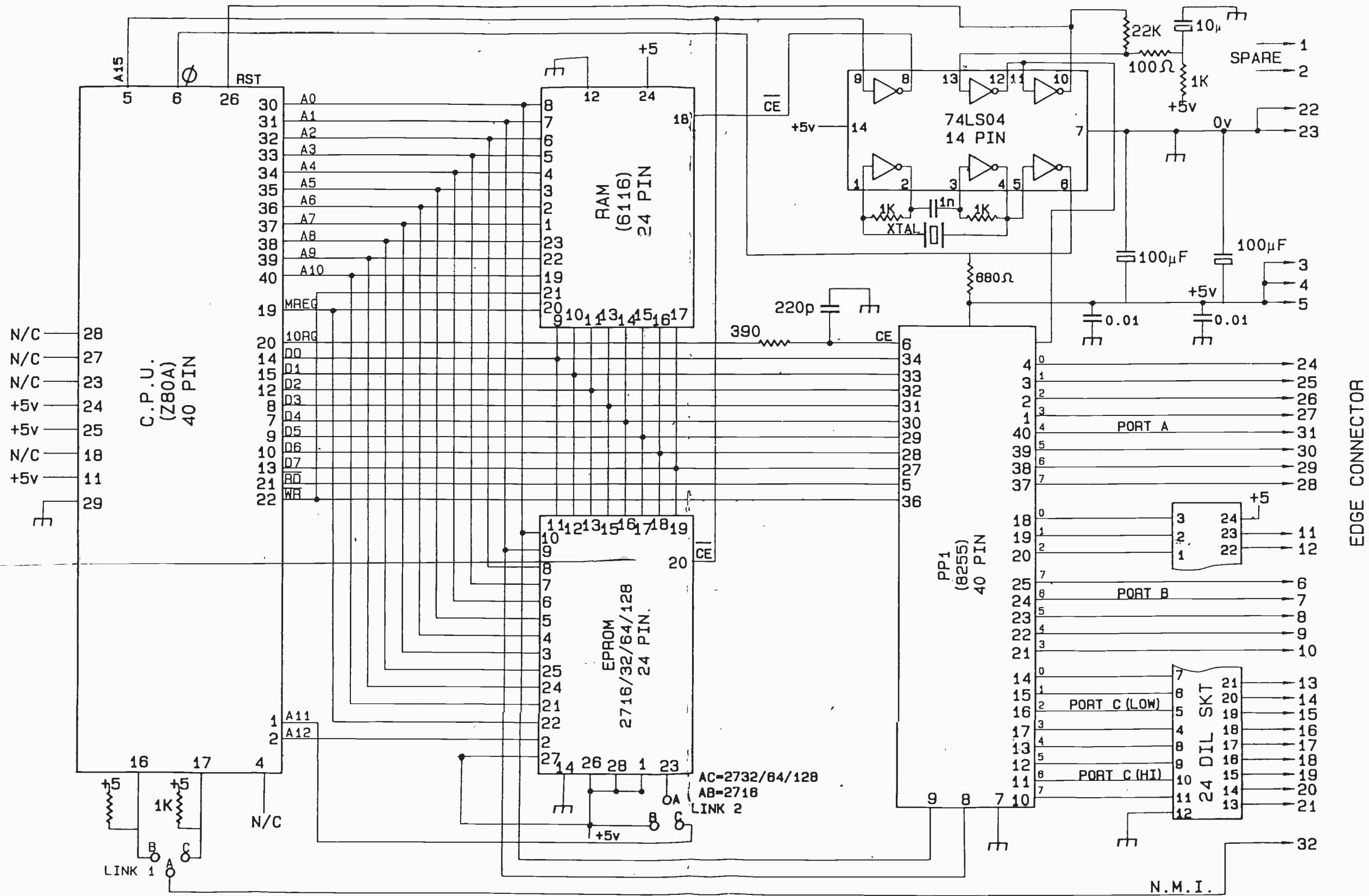

TREVOR BROWN ©

Pass 1 errors: 00

;GB3ET REV4 24/3/88

```

0000 2 *H;GB3ET REV4 24/3/88
0000 4 ORG 0
0006 6 TC EQU #06
0007 8 RX EQU #07
0002 10 CARD1 EQU #02
0003 12 CARD2 EQU #03
0003 14 PORT EQU #03
;BEEP MAC
    
```

```

0000 16 *H;BEEP MAC
0000 18 BEEP MAC
0000 20 LD A,#05
0000 22 LD H,#02
0000 24 LD L,#40
0000 26 LD BC,PORT
0000 28 OUT (C),A
0000 30 DEC L;FED UP
0000 32 JR NZ,$-6
0000 34 LD A,#04
0000 36 DEC H
0000 38 JR NZ,$-13
0000 40 DEC D
0000 42 JR NZ,$-20
0000 44 LD BC,#5000
0000 46 DEC BC
0000 48 LD A,B
0000 50 OR C
0000 52 JR NZ,$-3
0000 54 ENDM
    
```

;DELAY MAC

```

0000 56 *H;DELAY MAC
0000 58 DLY MAC
0000 60 LD BC,#F000
0000 62 DEC BC
0000 64 LD A,B
0000 66 OR C
0000 68 JR NZ,$-3
0000 70 ENDM
    
```

LOOK MAC

```

0000 72 *H LOOK MAC
0000 74 LOOK MAC
0000 76 LD D,#08
0000 78 LD BC,#02
0000 80 IN A,(C)
0000 82 BIT 4,A
0000 84 JR NZ,$+37;LOOK1
0000 86 LD BC,#FFFF
0000 88 DEC BC
0000 90 LD A,B
0000 92 OR C
0000 94 JR NZ,$-3
0000 96 LD BC,#02
0000 98 IN A,(C)
0000 100 BIT 4,A
0000 102 JR NZ,$+20;LOOK2
0000 104 LD BC,#FFFF
0000 106 DEC BC
0000 108 LD A,B
0000 110 OR C
0000 112 JR NZ,$-3
    
```

```

0000 114 LD BC,#02
0000 116 IN A,(C)
0000 118 BIT 4,A
0000 120 JP Z,AIR;LAST LOOK
0000 122 LD BC,#FFFF
0000 124 DEC BC
0000 126 LD A,B
0000 128 OR C
0000 130 JR NZ,$-3
0000 132 DEC D
0000 134 JR NZ,$-53
0000 136 ENDM
    
```

;START DELAY

```

0000 138 *H;START DELAY
0000 140 DLY
0008 142 DLY
0010 144 DLY
0018 146 DLY
0020 148 DLY
0028 150 DLY
0030 152 DLY
0038 154 START DLY
    
```

;SET PIO UP

```

0040 010300 156 *H;SET PIO UP
0043 3E98 158 LD BC,#03
0045 ED79 160 LD A,#98
162 OUT (C),A
    
```

;TEST CARD TO TX

```

0047 1E40 164 *H;TEST CARD TO TX
0049 3E06 166 COLD LD E,#40;COUNTER
004B 010300 168 LD A,TC
004E ED79 170 LD BC,PORT
172 OUT (C),A
    
```

;IDENT

```

0050 1690 174 *H;IDENT
0052 176 LD D,#90;G
0070 178 BEEP
0072 180 LD D,#90
0090 182 BEEP
0092 184 LD D,#30
00B0 186 BEEP
00B8 188 DLY
00BA 190 LD D,#90;B
00D8 192 BEEP
00DA 194 LD D,#30
00F8 196 BEEP
00FA 198 LD D,#30
0118 200 BEEP
011A 202 LD D,#30
0138 204 BEEP
0140 206 DLY
0142 208 LD D,#30;3
0160 210 BEEP
0162 212 LD D,#30
0180 214 BEEP
0182 216 LD D,#30
01A0 218 BEEP
01A2 220 LD D,#90
222 BEEP
    
```

for UK repeaters is the location. GB3ET is located in the equipment room at the TOP of the Emley Moor TV mast (900 Ft. AGL)! The photos show the TV mast (the equipment room can be seen just below the commercial TV aerials), and inside the equipment room with the rack which houses GB3ET along with two Ham radio beacons for other bands. The TX aerial is mounted on the roof of the equipment room and can be seen on the back cover of the "ATV Compendium". ED. NOTE: \*\* The ATV Compendium is available from ATVQ \$10 post paid.

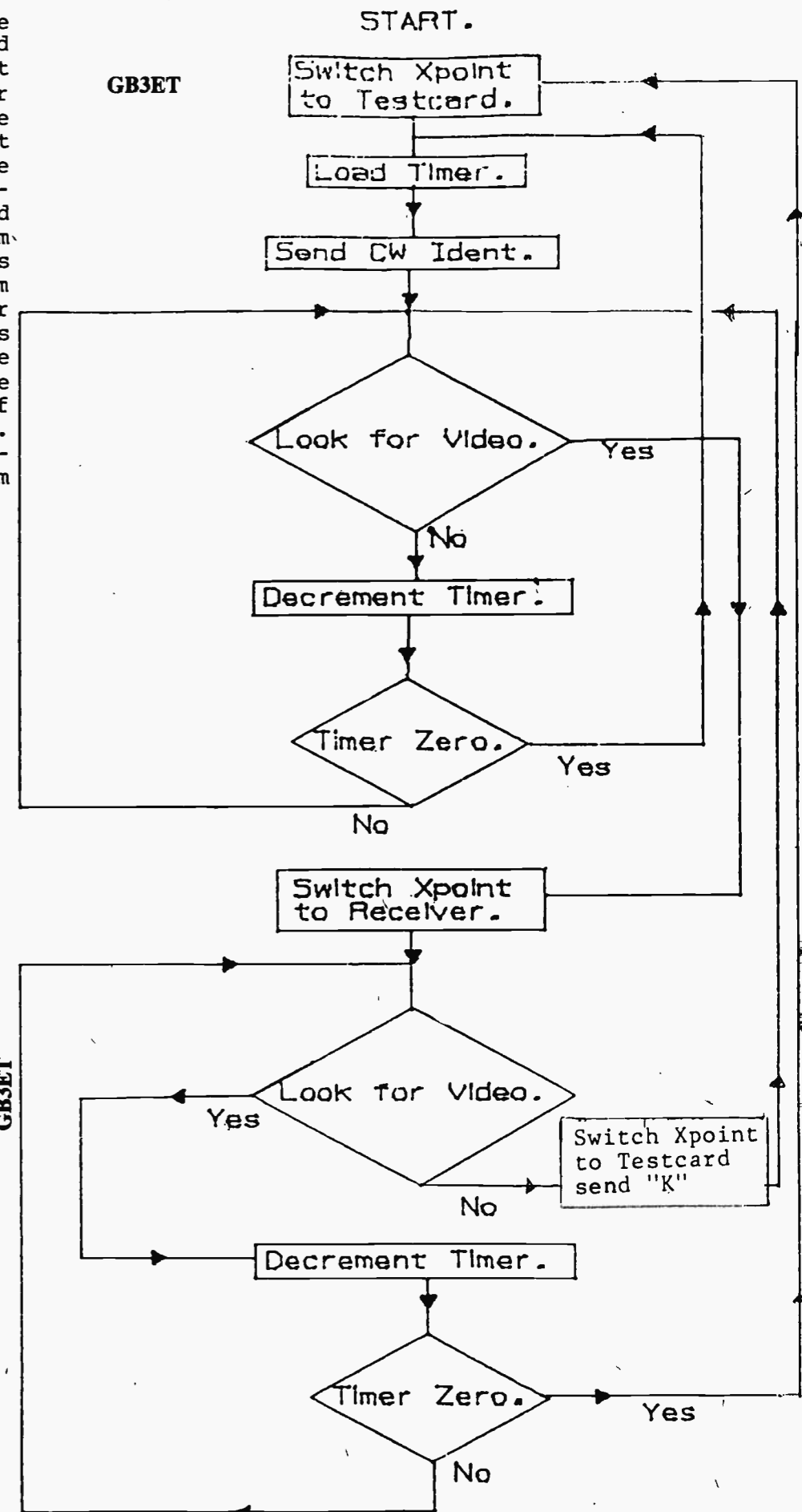
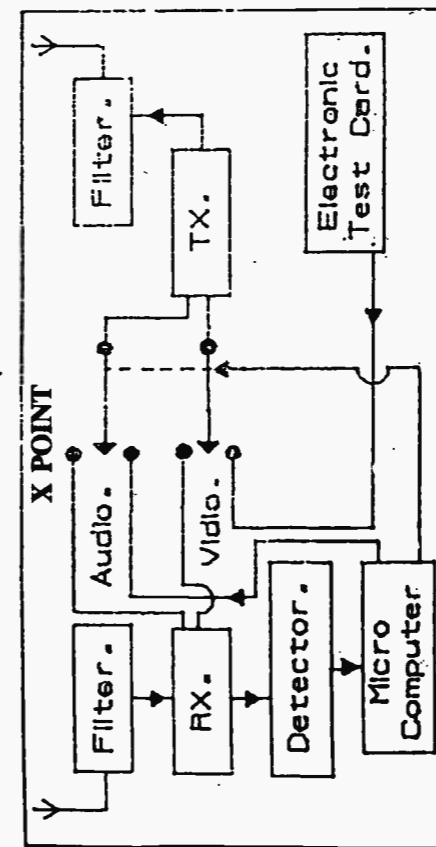



01C0 1690	224	LD	D, #90	298 *H; ON AIR
01C2	226	BEEP		700 AIR LD D, #20
01E0	228	DLY		705 LOOP LD BC, PORT
01E8 1630	238	LD	D, #30; E	710 LD A, RX
01EA	240	BEEP		715 OUT (C), A; ON AIR
0208	242	DLY		720 DLY
0210 1690	256	LD	D, #90; T	725 LD BC, #02
0212	258	BEEP		730 IN A, (C)
0230	260	DLY		735 BIT 4, A
0238	262	DLY		740 JR NZ, K; V. GONE
0240	264	DLY		745 DEC D
; LOOK VIDEO				750 JR NZ, LOOP
	266	*H; LOOK VIDEO		755 DEC E
0248	268	NEXT LOOK		760 JR NZ, AIR; NOT TIMED OUT
; TEST CARD 1				765 JP COLD
	270	*H; TEST CARD 1		
0281 010300	272	WARM LD	BC, PORT	0308 1620
0284 3E02	274	LD	A, CARD1	030A 010300
0286 ED79	276	OUT	(C), A	030D 3E07
; LOOK VIDEO				030F ED79
	278	*H; LOOK VIDEO		0311
0288	230	LOOK		0319 010200
; TEST CARD 2				031C ED78
	282	*H; TEST CARD 2		031E CB67
02C1 010300	284	LD	BC, PORT	0320 2009
02C4 3E03	286	LD	A, CARD2	0322 15
02C6 ED79	288	OUT	(C), A	0323 20E5
02C8	290	LOOK		0325 1D
0301 1D	292	DEC	E; COUNTER	0326 20E0
0302 C28102	294	JP	NZ, WARM	0328 C34700
0305 C33800	296	JP	START	765 JP COLD
; ON AIR				770 *H; VIDEO GONE
	282	*H; TEST CARD 2		775 K LD A, TC
02C1 010300	284	LD	BC, PORT	780 LD BC, PORT
02C4 3E03	286	LD	A, CARD2	785 OUT (C), A; OFF AIR
02C6 ED79	288	OUT	(C), A	790 DLY
02C8	290	LOOK		795 LD D, #90; K
0301 1D	292	DEC	E; COUNTER	800 BEEP
0302 C28102	294	JP	NZ, WARM	805 LD D, #30
0305 C33800	296	JP	START	810 BEEP
; ON AIR				815 LD D, #90
	282	*H; TEST CARD 2		820 BEEP
02C1 010300	284	LD	BC, PORT	825 DLY
02C4 3E03	286	LD	A, CARD2	830 DLY
02C6 ED79	288	OUT	(C), A	835 DLY
02C8	290	LOOK		840 DLY
0301 1D	292	DEC	E; COUNTER	845 JP NEXT
0302 C28102	294	JP	NZ, WARM	
0305 C33800	296	JP	START	

Pass 2 errors: 00

AIR	0308	BEEP	0000
CARD1	0002	CARD2	0003
COLD	0047	DLY	0000
K	032B	LOOK	0000
LOOP	030A	NEXT	0248
PORT	0003	RX	0007
START	0038	TC	0006
WARM	0281		

Table used: 172 from 351

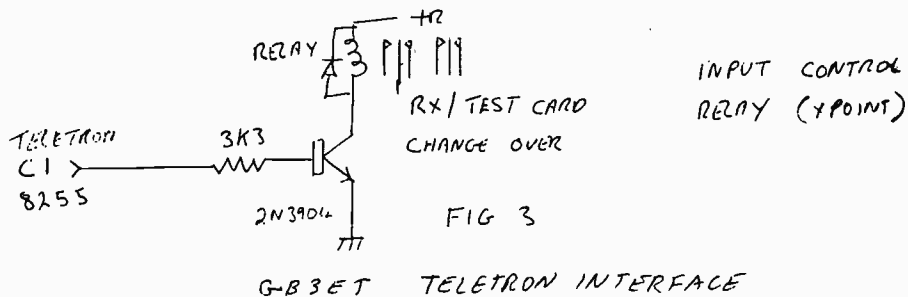
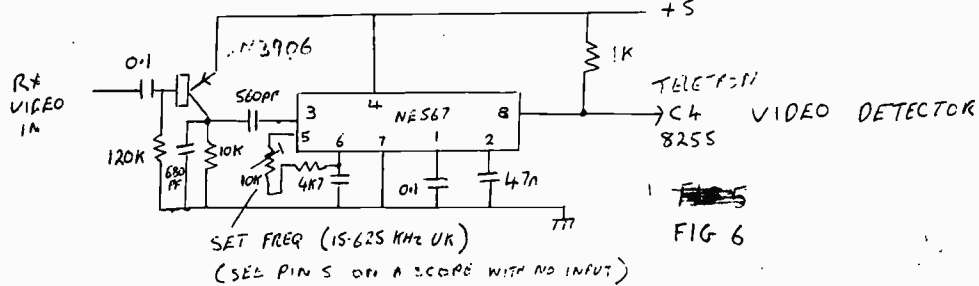
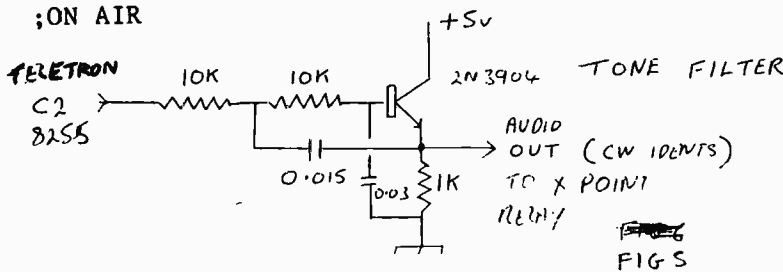

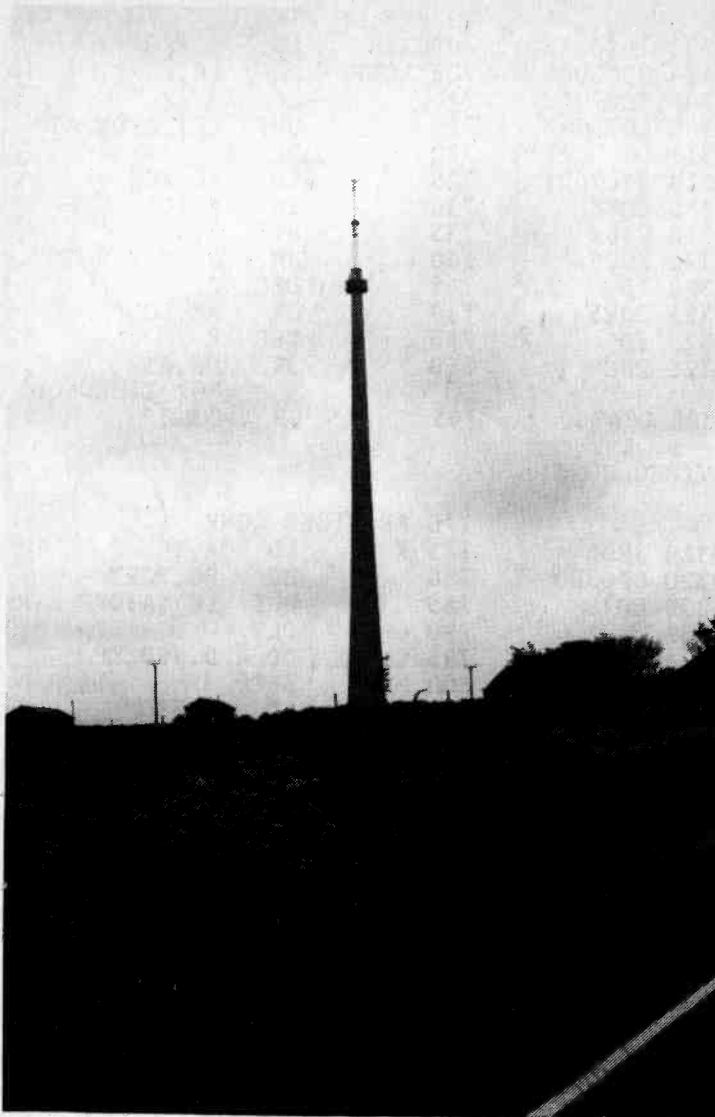

**GB3ET Repeater**

**Equipemnt door at top of tower**

**GB3ET Repeater**

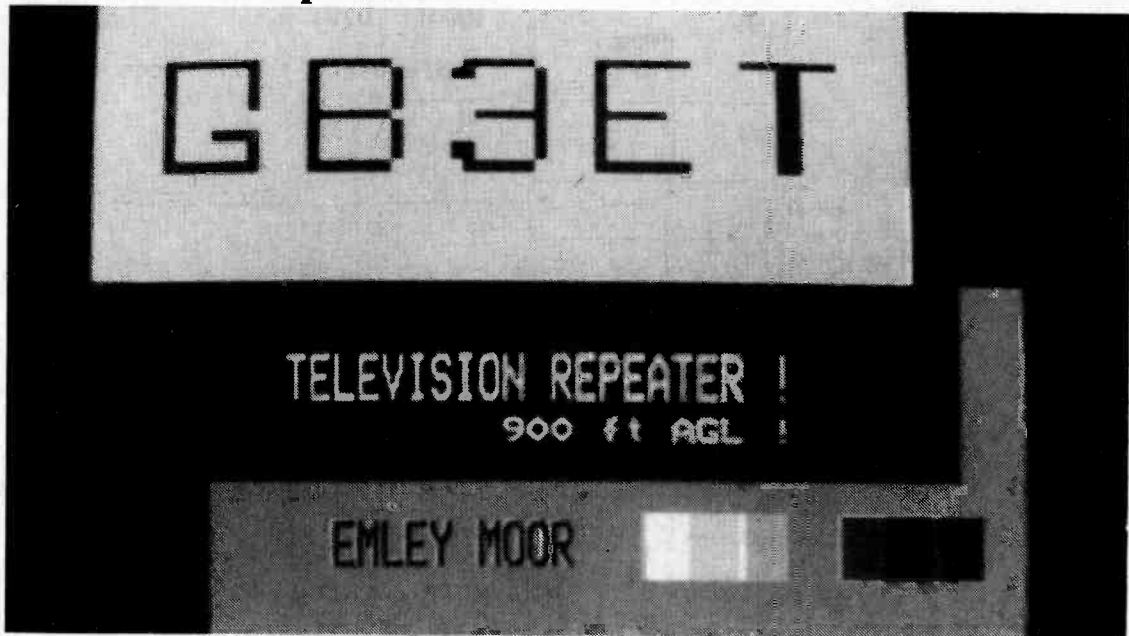

**GB3ET Call Sign**

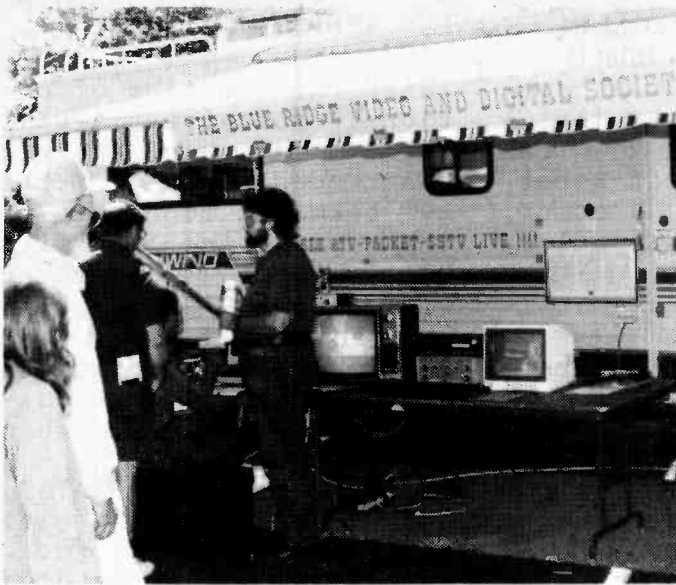

Photo by David Jones - N4JED

The Blue Ridge Video and Digital Society put on a 'live' display of ATV, SSTV, and packet radio at the recent Roanoke, VA Hamfest. Live action shots were transmitted back and forth between the outside flea market and the inside displays generated quite a bit of interest.



Photo by David Jones - N4JED

'Breakfast Call' being transmitted via ATV by N4FHC to other members of the Blue Ridge Video and Digital Society at the Relent Roanoke, VA Hamfest. Live ATV, SSTV and packet demonstrations were featured by the group.

#### ROANOKE, VA

The Blue Ridge Video and Digital Society put on a 'Live' display of ATV, SSTV and Packet Radio at the Roanoke, Virginia hamfest. Live action shots were transmitted back and forth between the outside flea market and the inside which generated quite a bit of interest. ED. NOTE: Photos and info supplied by David Jones - N4JED

Photos above

#### BATC CONVENTION 90

The BATC convention will be held may 6th at the Harlaxton Manor in Grantham. For further details contact Paul Marshall, BATC secretary, GBMJW, Fern House, Church Road, Harby, Nottinghamshire, NG23 7ED, UK. tel.0522-703348.

#### DAVENPORT, IOWA

On my way to the AMSAT conference in Des Moines, the roving ELK had a chance to view the WB0BIZ ATV repeater operation firsthand. Excellent signals were received out to over 20 miles from my mobile station. Craig WB0-OLX and Merle W9DNT put the repeater through it's paces showing off all the multiple video feeds complete with weather radar and the KWQC remote tower camera. The repeater is working quite well from it's new home near the KWQC studios and is using one of Merle's Alford Slots. Thanks to Matt N0-GIK for the grand tour of the repeater and the KWQC facilities. The Davenport group meets every Sunday evening for an ATV net on 144.34 Mhz.

Photo →

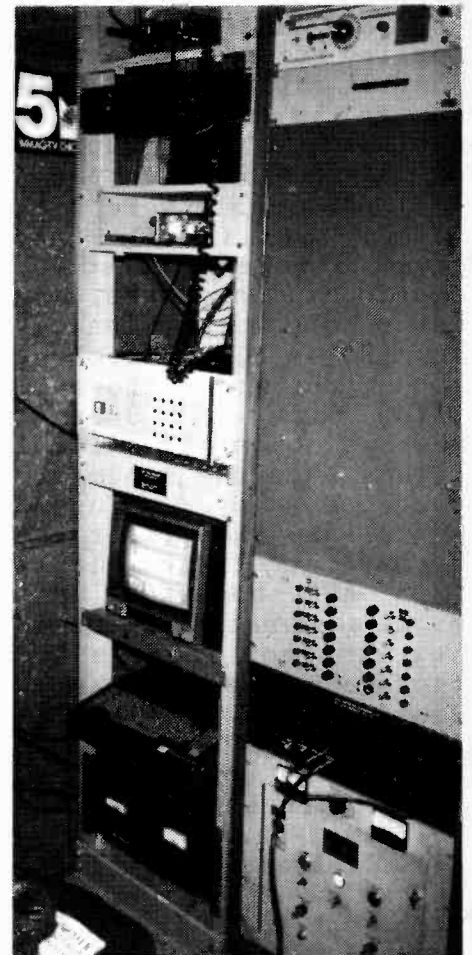

WB0BIZ ATV Repeater  
Davenport

## SLOW SCAN TELEVISION and ADVANCED ELECTRONICS APPLICATIONS

By John P. Spaeth KD0LO

Never before has one single piece of gear caused such a clamor on the slow scan frequencies. I am talking about the slow scan television interface for the Amiga computer. ATVQ first reported this unit to you in APRIL 1989. Since that review, Advanced Electronic Applications (AEA) has begun producing and distributing the units for Black Belt. Here's the deal. If you purchased a unit from Black Belt, AEA will accept your old unit for credit towards the new model. If you own one of the Black Belt built units, you should have received a certificate from them authorizing your credit to AEA.

I have my new unit, serial #37, and it surpassed the original unit not only in quality but also function. The AEA unit (pictured) is housed in an attractive cabinet with power supply. A computer audio and parallel port cable were provided. The unit also has five software selected audio input connectors, one xmit audio output connector and an RJ11 telephone connector. About the only thing this unit doesn't have is an on/off switch! Figure 1 is the schematic provided with the users manual and except for the eprom, at first glance this AVT terminal unit might seem rather unassuming. In fact it is a deceptively small package. Rest assured that this is an attractive hardware addition to your shack. Enough already about the hardware!

Ben Williams has delivered software which will turn your Amiga into a universal slow scan television demodulator. The unit is compatible with both

NTSC and PAL Amiga systems. With the AVT (AMIGA VIDEO TERMINAL) one can copy all speeds of Robot, Scotty S1 and S2 color, Martin M1 and M2 color, Volker-Wrasse.

This represents the ability to receive 26 sstv types. But WAIT there's more!

The software includes a new mode applicable only to the Amiga, called the AVT mode. With resolution exceeding 640 by 400 as compared to the Robot high resolution of 256 by 240. With this new mode one realizes not only a resolution enhancement but several other options which make operation more flexible. Including a three dimensional mode used in conjunction with optional Haitex 3-D glasses and a qrm mode which enhances operation during poor signal or high qrm periods.

The software also displays an audio oscilloscope trace with calibration markings for sync, black, and white. This oscilloscope is extremely useful in tuning another station. The scope function is complete with audio filters and a trigger circuit. The trigger circuit will actually trigger the display as one tunes across the slow scan signal. The scope will trigger on the sync tip just like your stand alone oscilloscope.

Beyond sstv but somewhat related, are other image modes which are gaining popularity amongst hams. The pseudo-visitel mode will send a 5 second picture over the telephone. Also included are several fax modes 120 lpm (weather fax), 60lpm (newsfax), 240 lpm (geofax).

With the addition of optional software (AREEX) the computer can be left unattended. And with the AVT terminal connected to the phone line with its RJ11 jack, the computer will either answer the phone or dial out and send an image or images to another Amiga perhaps during off peak hours when rates are lower.

Black Belt, Ben AA7AS, and AEA have done a nice job with this project. There appears to be good user support from both the original author, Ben, and from AEA. AEA has already sent out one software update since I received my unit and supposedly more will be available as improvements are made to the system.

This system works best on Amigas with at least 1.5 megs of memory and really benefits from a "fatter agnes" chip which gives the computer a full megabyte of video ram. I run the system with the stock fat agnes chip and three megs of ram and am very pleased with the overall system performance.

This review would not be complete without mention of the operation manual for the AVT system. This is more than your usual owners manual that we are all used to seeing with our ham gear. This baby is 141 pages long and is really more of a slow scan encyclopedia than a users manual. Ben Williams has not only outlined the operation of his own system, with tutorials, but has also included a rather extensive historical perspective of all the slow scan modes and has also given technical data on the composition of the various slow scan signals.

I can't say enough about this manual, in fact if you don't have an Amiga I recommend contacting Deborah Davis (N7IHY) at AEA and see if you could purchase just the manual. This is recommended reading for any slow scan operator! This manual is printed on heavy stock with the covers being glossy card stock. My hat goes off to AEA for indulging Ben in printing a manual of this magnitude.

The total cost of this system including the computer is around \$1500.00, of course the total cost of the other available high end stand alone sstv converter is \$1200.00 without computer capability, and with only one mode of operation. If one were going to invest in a high end sstv unit clearly the Amiga system is less expensive and at the same time delivers more capability for the dollar!

I must agree with the crowd on 14.230 MHz, this is indeed the premier slow scan terminal unit for computer generated image transmission.

de John KD0LO

#### FOR SALE

As new Robot 1200C color SSTV converter. Used once! Going Amiga! \$1100 or bo. Also Tandy 1000EX computer 640K, 2 disk drives, extra ports, various accessories \$500. Also 2; Sony VO2630S NTSC/PAL (switch selected from front panel) record/play 3/4" U-matics. Excellent condition. \$500 each. Tektronic 1421 PAL vectorscope like new \$750. Also, 2 F9FT 55 element 1295/1255 Mhz yagis with stacking boor. Assembled but never on the tower. (replaced with 5 meter fiberglass dish for 1250/2300) Also 5 foot Andrew dish and mast mount brackets for 2.3 Ghz or other bands, you add feed. Best offer. Will consider trade for big HF amp, KT34XA, PAL color monitor. Buyer pays shipping or picks up. Henry Ruh c/o ATVQ. 708 298 2269. (usually home after 6 pm CST)

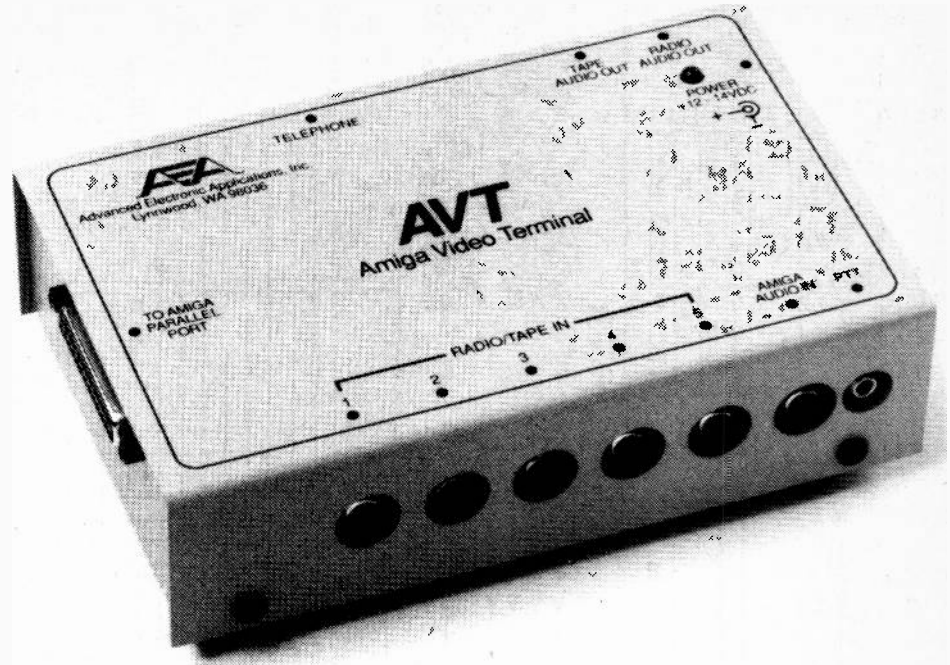

continued next page

#### R/C ATV

I am interested in light weight ATV equipment and camera for model aircraft use. My initial project is for a camera looking down out of the bottom of the fuselage with video on 439.25, later a mirror mounted to look forward or sideways. Ron KA9CAP 1003 S. Philo Rd., Urbana, IL 61801

#### WANTED

VHS C to CHS cassette adaptor. Service info or photocopy of schematic of JVC HR-C3U video recorder. Lyn Cyr 83 Bayard Ave. North Haven CT. 06473 PM-203 248 3142 AM-203 852 5247

#### BRITISH COLUMBIA

Biggest problem in BC is finding cheap cameras! ATV airwaves are filled with VE7BBB, VE7DSM, VE7RJ and 6 others. Mostly on 439.25 also on their local repeater, 439.25 in, 923.25 out. They need an amp for the repeater output. (Try Downeast Microwave. ed.)

VE7CVI in Kelowna is now on the air with 1 watt. VE7BBB successfully modified a TS790 for ATV and says it works great with 35 watts out. He has used the same mod for a 471A for 20 watts out which also works and does not affect the normal look or operation of the radio! VE7RJ has a simple Commodore 64 or Vic20 ATV beacon program. For more info write: VE7BBB Orin Beebe, Box 477 Penticton, BC, Canada V2A 6K6.

#### SAVANNAH, GA

Joe, N4OYT sends along information that the N4OYT ATV Repeater will be operational from Savannah, Georgia with an input on 434 Mhz and output on 421.25 Mhz (Horizontal polarized). Local talk frequency is 146.55 Mhz. Ed was able to link up with us on SSTV during the latest ATV Net and may be able to show us some of the local activity via SSTV.



**BLACK BELT SYSTEMS**

**TITLE: AVT BOARD**

DESIGNED BY: BEN WILLIAMS-AR7AS 137 JOHNSON RD  
 DRAIN BY: BEN WILLIAMS-AR7AS RT BOX 4272  
 GUNESVILLE, TX 75640

DATE: JULY 7TH, 1989 906-367-5583

REVISION: PCB-VBR3, SCH-RC

NOTES: A-B

**NOTES:**

- A - ALL IC'S HAVE .1UF CAPS ACROSS THE IR POWER SUPPLY PINS INCLUDING THOSE WITH 100 PULSES AND 100UF ELECTROLYTIC CAPACITORS LOCATED AT ELECTRONICALLY STRATEGIC POSITIONS AROUND THE PCB.
- B - VDD IS NOMINALLY +12 VDC PROVIDED FROM A SUPPLIED WALL TRANSFORMER UNIT DERIVED FROM VDD USING A LDR85 REGULATOR AND VEE IS DERIVED FROM VDD USING A CHARGE PUMP. AS DETAILED IN THIS SCHEMATIC.

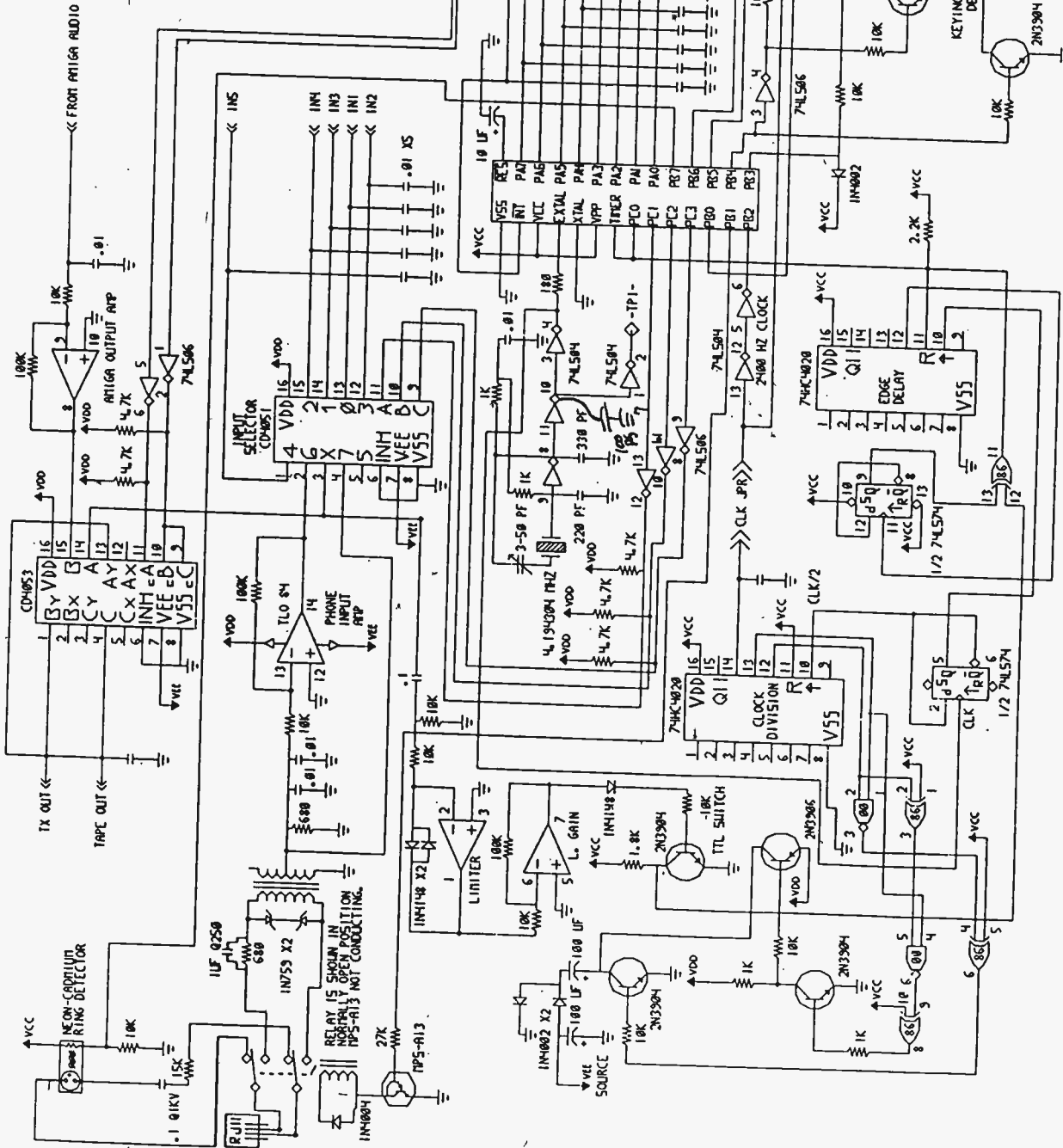

THE AVT SYSTEM WAS DESIGNED USING BLACK BELT SYSTEMS ELECTRON MASTER SCHEMATIC GENERATION SOFTWARE FOR THE AMIGA AND THE AVT PC BOARD WAS DESIGNED USING BLACK BELT SYSTEMS BOARD MASTER PCB GENERATION SOFTWARE FOR THE AMIGA. THIS SCHEMATIC, THE PCB DESIGN, AND THE AVT FILES ARE COPYRIGHT 1989 BLACK BELT SYSTEMS. ALL RIGHTS RESERVED.



# The Radio Amateur's Journal



**ON THE COVER:** With his retirement from the U.S. Senate, Barry Goldwater, K7UGA, finds more time available for his life-long hobby of Amateur Radio from his home QTH in Scottsdale, Arizona.

FEBRUARY 1989

VOL. 45, NO. 2

## FEATURES

POLAR BRIDGE EXPEDITION.....	Wade Luce, N7KQU	11
BUILD A COAX ANTENNA SWITCH FOR YOUR STATION	Lew McCoy, W1ICP	18
CQ REVIEWS: THE UNIDEN HR-2510 10 METER SSB/CW/FM TRANSCEIVER.....	Dave Ingram, K4TWJ	20
THE WNZ AWARD: YOU CAN DO IT!.....	Patty Winters, N6BIS	26
A MAG-MOUNT CONVERSION FOR UNDER A BUCK	John R. Somers, KC3YB	32
CRAZY ANTENNAS I HAVE USED.....	Jeff Lackey, K8CQ	34
HAROLD S. BRIDE, HEROIC TELEGRAPHER OF THE R.M.S. TITANIC.....	David O. Norrlis, N8HKV	36
CQ SHOWCASE: NEW AMATEUR PRODUCTS.....		40
AND BLESSED BE THE XYL.....	Kristi Jenkins-Smith, VK9NL	42
CQ REVIEWS: CODEMASTER 100.....	Jonathan L. Mayo, KR3T	44
THE EVOLUTION OF AN HF SUITCASE STATION	John J. Schultz, W4FA/SV0DX	52
ANNOUNCING THE 1989 CQ WW WPX CONTEST.....		56
BILL'S BASICS: POTPOURRI 1989.....	Bill Welsh, W6DDB	60
WORLD OF IDEAS: MORE KEYS REVISITED	Dave Ingram, K4TWJ	64
THE PACKET USER'S NOTEBOOK: PACKET DUPLEXING	Buck Rogers, K4ABT	72
WASHINGTON READOUT: ENTRY INTO THE AMATEUR RADIO SERVICE—IS IT TIME FOR A CHANGE?	Frederick O. Mala, W5YI	79
ANTENNAS AND ACCESSORIES: READER FORUM, PART II	Karl T. Thurber, Jr., W8FX	82

## DEPARTMENTS

AWARDS: STORY OF THE MONTH—JOHN R. SPARK, W4LHP	Dorothy Johnson, WB9RCY	76
CONTEST CALENDAR: CONTESTS FOR FEBRUARY AND EARLY MARCH, NA RESULTS OF THE DUTCH PACC CONTEST.....	Frank Anzalone, W1WY	88
PROPAGATION: CONDITIONS DURING 1988 WW DX PHONE CONTEST, FEBRUARY VHF OPENINGS	George Jacobs, W3ASK	93
DX: NEWS, VIEWS, TIDBITS, AND LORE FROM THE WORLD OF DX.....	Hugh Cassidy, WA6AUD	96
ZERO BIAS.....	4 OUR READERS SAY.....	8
ANNOUNCEMENTS.....	6 HAM SHOP.....	104



The Radio Amateur's Journal  
76 North Broadway, Hicksville, NY 11801

JANUARY 1990 VOL. 3 #1

# Tune in with



## The Ham's Magazine

All year long CQ brings you the best writers... the best reading in Amateur Radio. Written and edited to be enjoyed as much as you enjoy Ham Radio itself. Not just good. It's the best!

### Subscribe and SAVE!

IMPORTANT: BE SURE TO ENCLOSE YOUR CHECK OR MONEY ORDER

## SAVE 36% OR MORE ON YOUR COPIES OF CQ

Subscribe now and save \$10 a year or more over the cost of buying your issues on the newsstand.

Yes! I want every issue of CQ delivered to my door, so sign me up.

- 1 year · 12 issues **\$19.95**  
(Save \$10.05)
- 2 years · 24 issues **\$38.00**  
(Save \$22.00)
- 3 years · 36 issues **\$57.00**  
(Save \$33.00)

Canada/Mexico—One year \$22.00, two years \$42.00, three years \$63.00; Foreign—one year \$24.00, two years \$46.00, three years \$69.00. Foreign Air Mail—one year \$77.00, two years \$152.00, three years \$228.00.

(Please print clearly)

Name \_\_\_\_\_  
Street \_\_\_\_\_  
City \_\_\_\_\_  
State \_\_\_\_\_ Zip \_\_\_\_\_

Check or Money Order enclosed  
Bill to  Mastercard  Visa

My account number is:

--	--	--	--

Expiration date: \_\_\_\_\_

Note: Allow 6-8 weeks for delivery of first issue.

# USING CELLULAR AMP FOR ATV

by Bob Bruninga WB4APR

59 Southgate Ave. Annapolis, MD 21401

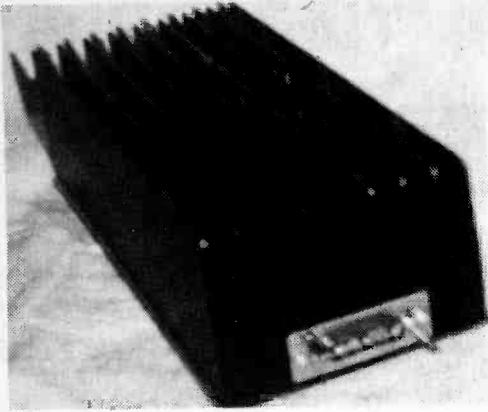

Our ATV repeater, featured in a past issue of ATVQ has its viewer output in the 900 Mhz band. The transmitter which is enclosed in a weatherproof enclosure on top of a 180 foot water tower consists of a PC TXA5-33 exciter feeding a readily available Cellular 800 Mhz 50 watt amplifier powered by a 5 amp 24 V power supply. Although only 2.5 amps are needed for average video power levels the extra amperage is conservative and handles full CW sync power for initial set up. The cellular amp is a typical FM class C amp but does appear to work fine. The purpose of this article is to share our experience using a class C amp for ATV.

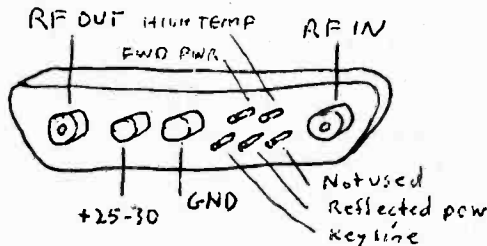

no power to full power output was about 10 db. But after trying it on the air we realized that the independent pedestal adjustments on the PC Electronics exciter allows us to develop good sync pulses and by adjusting the video level to modulate fully within the narrow input range of the amp we could get wide dynamic range modulation on the output.

It has been seven months since the exciter and amp were installed on the top of the tower. The combination has never been adjusted in place since it left there workbench but we get reasonably good video. After several lightning storms and two computer crashes on the ground the transmitter survived at least two two week periods of constant key down!. The power is about 3 db below the initial value but there should be plenty of range available to adjust the back up to about 10 watts average and the exciter is only running on 12 volts not 13.8. Right now we do not get good color and the contrast is a little low but we expect the loss of color may be roll off of the amp at 923 Mhz where we are currently operating until we get up to change the crystal to 910 Mhz. Remember the amp is unmodified from its original use on 850 Mhz and the amp circuits and circulator probably begin to roll off higher in the 900 Mhz band. The contrast should be correctable by cranking up the video level on the exciter. (care not to white out video, ed.)

The photo is the unmodified amp with its original connectors. These amps should be available from your local friendly cellular service repairman since there is one on line for every frequency at every cell site in America. There are over 1500 of them here in the Washington DC area. Since the automatic level control circuitry is a common failure in these amps, hopefully you can talk someone out of one with a defective control circuit, which you promptly bypass for ATV!. While we do not conclusively endorse this amp for ATV because of its class C power curve, it does give us something useable on 900 Mhz. Our local plan is to have all local ATV repeaters on 910 Mhz output with 426 and 1280 Mhz band inputs and cross links.

At first we thought the amplifier would not work for ATV since the total dynamic range of the amp driven from the exciter from

## "Little Wheel" Antenna for ATV

David A. Clingerman W60AL

Here in the Denver area the ATV group has decided to use horizontal polarization. This decision for the most part was borne out of the fact that there is considerable FM activity throughout the 450 Mhz band. The FM activity is of course, vertically polarized and by being cross polarized ATV will be afforded a certain amount of adjacent channel protection. Vertical or horizontal polarization is fine for operation in the open where there are no reflecting surfaces like mountains, buildings and vehicles. Such is not the case for most of us and our operation. So, we'll have to accept a degree of multipath and learn to live with it. In order to eliminate this multipath problem circular polarization must be employed but that's the subject of a future article.

Round table operation during our activity nights are difficult using a beam antenna. In order to prevent working a rotor to death an omni-directional horizontal antenna would come in handy. The repeater for Denver is at a fairly good location and most, if not all, of the group have copied it with some degree of success. Since we've elected to use horizontal polarization in this area, the repeater had to have an omni-directional, horizontally polarized antenna. My early days on OSCAR's six and seven afforded me an opportunity to experiment with omni-directional, horizontally polarized antennas, namely the Turnstile. Some of my OSCAR operation was mobile and the Turnstile was used not only for its omni-directionality but

**JANUARY 1990 VOL. 3 #1**

also because it exhibited circular polarization skyward or above the structure. As most of you are aware a Turnstile is simply a pair of crossed dipoles (physically 90 degrees out of phase) and then fed electrically 90 degrees out of phase using a quarter wavelength coaxial phasing section. The three Turnstiles I've built and have employed in this area serve their purpose well, however, we HAMS are never satisfied, so there must be a better mousetrap. I have also in the past used the Halo antenna for 6 meter and 2 meter SSB operation but they, contrary to popular belief, can exhibit some directivity depending on where they are placed on a vehicle.

An antenna developed in the 1950's by WLFVY and WLIJD called the Big Wheel was a boon to mobile 2 Meter SSB VHF work. It had gain over the Turnstile and Halo, a more uniform omni-directional pattern and very broad frequency response. Built for a frequency of 146 Mhz, the VS-WR was negligible at +/- 2 Mhz of center frequency. Describing a Big Wheel probably takes more time than actually building one. It looks like a Three Leaf Clover where each leaf is a 1/4 wavelength element. The three elements are in parallel. As you know paralleling elements, resistors or inductors yields a quotient, the result of, the inverse of the sum of inverse to the (n), i.e.

$$\frac{1}{\left[ \left( \frac{1}{n} \right) + \left( \frac{1}{n} \right) + \frac{1}{n} \right]}$$

The overall impedance is

lowered to about 12 to 16.67 ohms and is brought back to 50 ohms with an inductive stub.

At 70 cm the entire array can be built on a BNC connector and be fairly rigid. I cut two triangular plates from 0.035" thick brass stock, one is 0.5" on a side, the other is 1". The larger one is used as the ground contact. A "UG-625 B/U" BNC panel connector was used - it has a 0.275" (9/32") threaded area, where the M39012/21-000274868 has a 0.410" (13/32") threaded area. I mention both as both may occur in your junk box as they do in mine. The shorter threaded one is the one to use. A 0.430" (7/16") hole is drilled in the center of the ground plate. A 0.090" (3/32") hole is drilled in the center of the small plate. Fit the ground plate on the BNC connector and make fast with a lock washer and nut. Place the small triangle over the center pin of the BNC, align the corners and solder in place with a liberal amount of solder. RF at 70 cm does not like mechanically loose hardware. It will arc and spark and cause you more headaches than you need so make things tight.

The elements are formed of 0.095" (3/32") diameter brazing rod and are 26.75" in length. Cut three of these, find the center of each and mark a spot 5" either side of the element center. Use these spots as the center points of two (2), 2" radius bends. Bend on this radius until the ends of the element meet. The angle formed by the meeting ends will be 100 degrees, or make it so. Shape this element so that

from the place where the ends meet to the center of the bent element is 6.75".

Place one end of one of the elements on the corner of the small triangle, bisecting the angle and using about 0.2" (13/64") of element, solder in place. The other end of this element is then placed about 2/3 of the way up the side of the ground plate from the corresponding soldered point of the small triangle and solder 0.2" of the element here. Follow this procedure with the other two elements. Cut a 0.8" (13/16") strip of 0.035" (1/32") brass, 0.250" (1/4") wide from stock. Bend this strip in a "u" with radius 0.1875" (3/16") and one leg 0.375" (3/8") longer than the other. You have just created the inductive stub. Place the long side of the stub against one of the small triangles edge, short side positioned down toward the large triangle and butt solder in place. The short side should be touching one of the large triangle's edge. If it is not touching make it so with some judicious shaping. Butt solder in place. Remove all excess solder flux with a denatured alcohol and cotton swab. THAT'S IT!

Testing the array requires nothing special. Place the array about one meter from all metal objects. Place a VSWR meter as close to the array as possible. Apply power, check the VSWR and find the array not to exceed 2.0:1 from 410 to 440 Mhz. If it's not, check all solder joints for one that might be cold or broken. Reflow the solder and try the VSWR test again. If a prob-

lem exists still, call me, (303) 798-5926. The antenna doctor will make it well for you, or I'll sell you one of mine.

There has been considerable response shown in this antenna not only for terrestrial ATV but mobile 70 cm SSB work, balloon and kite ATV. The antenna is supplied in kit form or completely built by OLDE ANTENNA LAB, Denver, Colorado and marketed by, ALLIED Appliance & Radio, 4253 S. Broadway, Englewood, CO 80110. Kit price is \$19.95 + \$3 postage and assembled is \$24.95 + \$3 postage.

I'd like to acknowledge and thank Mr. Ted Reynolds of Martin-Marietta Astronautics Group, Antenna Test Range - Denver, CO for his help in the initial testing of this antenna and for his time required in the discussion of theoretical issues concerning omni-directional, horizontally polarized, broadband radiating devices.

ELEMENT

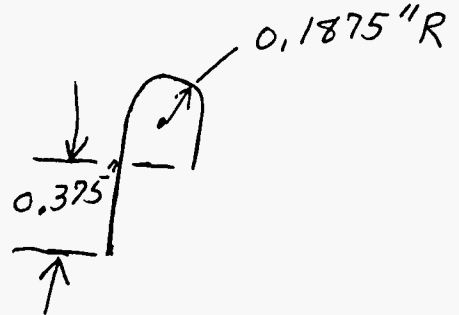
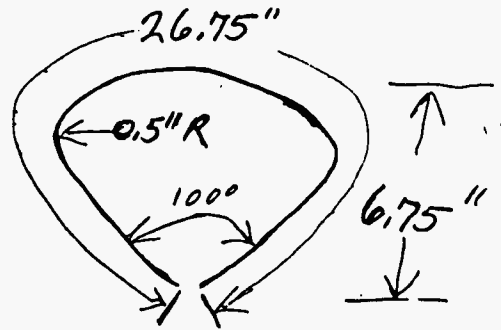

STUB

BEND DETAIL

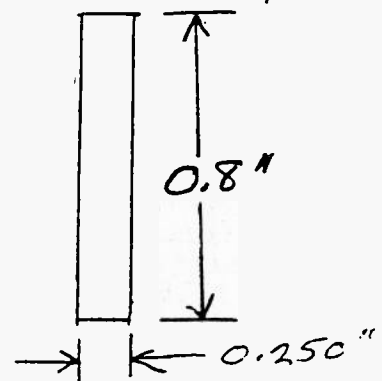

STUB

TOP PLATE

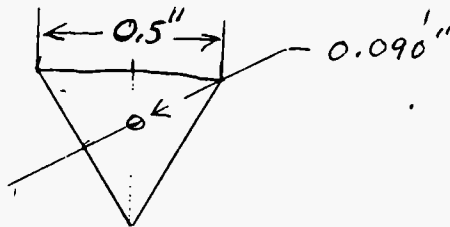

GROUND PLATE

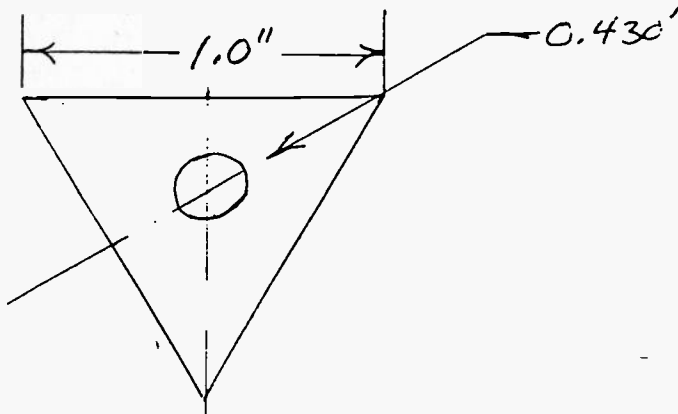



3-2-89

DAC  
W6OAL

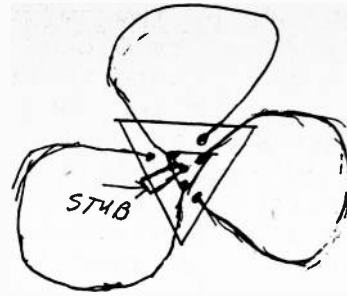

TOP VIEW  
(NOT TO SCALE)

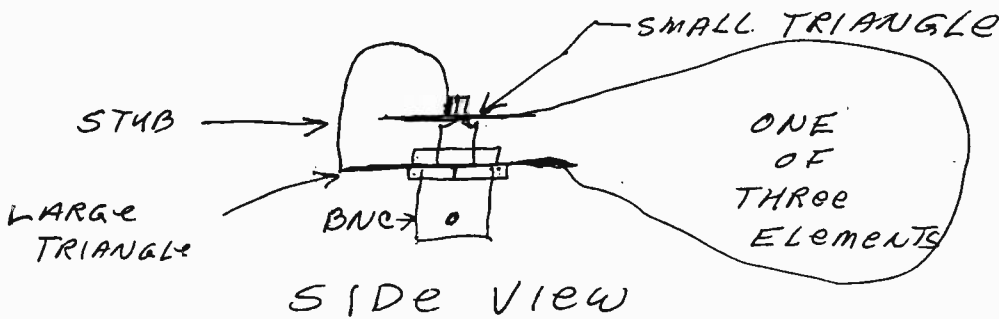

LITTLE WHEEL  
AS PER ATV  
ARTICLE BY  
W6OAL

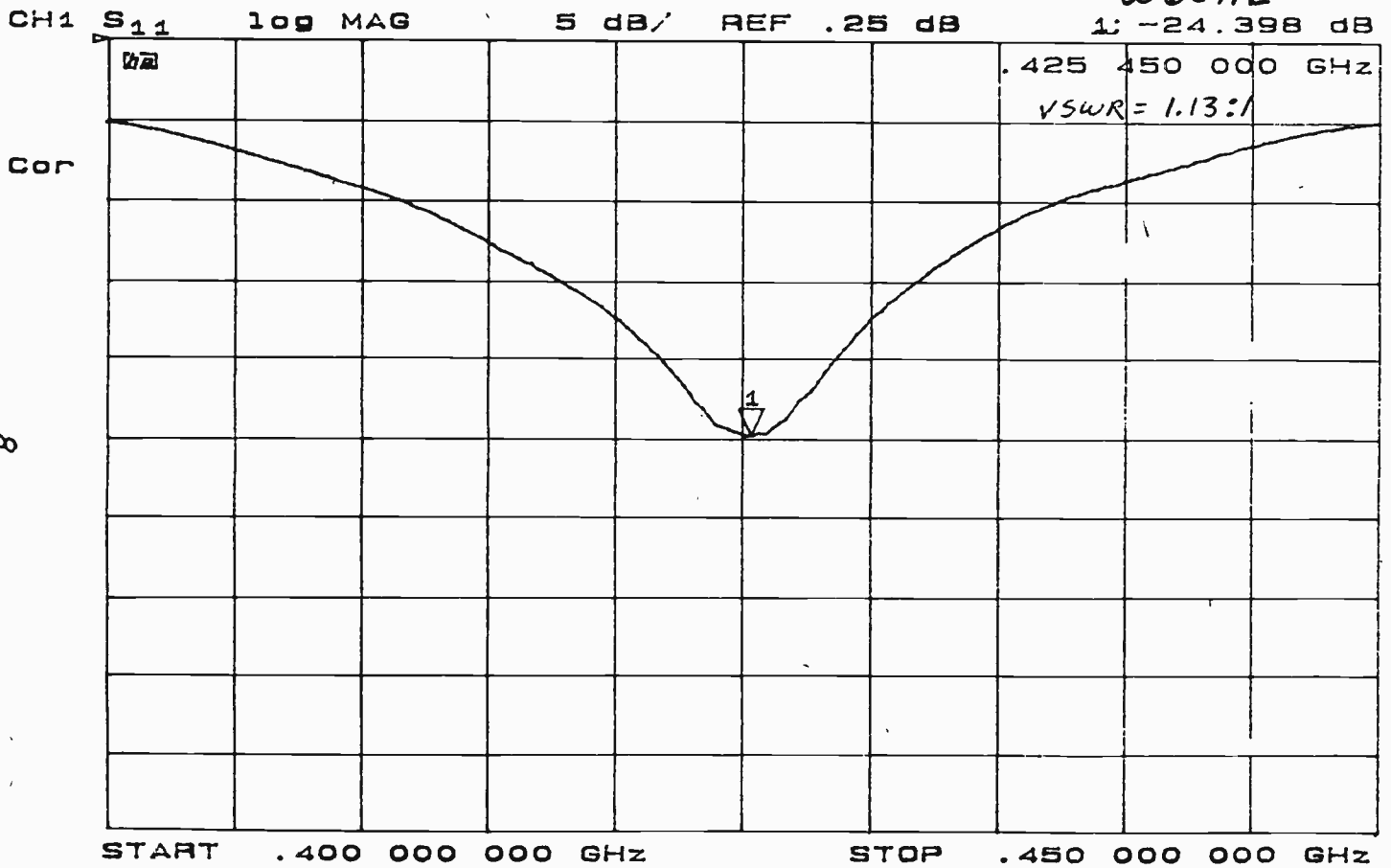

3dB POINTS = 423 - 428 MHz

2.0:1 VSWR = 410 - 440 MHz

## A METHOD of IMPROVING ATV RECEIVE PERFORMANCE

by Dick Goodman, WA3USG

During the last 6 months I have been experimenting with composite video output from the TV set connected to my downconverter on the 70 CM band. I use a cheap B&W TV set on ATV receive. I also use a state of the art Sony TV set to receive color on strong local signals. I have found that the B&W set outperforms the Sony and many other high end color sets when it comes to weak signal reception. I have also found that signals with marginal sync will lock up far better on the B&W set. I attribute this to the fact that the cheaper set has a narrower bandwidth in the IF stage than color sets. This being the case, the signal to noise ratio with the B&W set would be better and the set would effectively have more signal to work with. Desiring to confirm this, I built up a simple emitter follower and video amplifier on a small piece of perf board. I tapped into the output of the video detector in the ATV RX set and was able to obtain composite video. Looking at this video with an oscilloscope confirmed by suspicions about the limited bandwidth. There was no color burst on any received signal, even those of local commercial TV stations. Feeding this video into a good B&W video monitor proved the picture to have better contrast & stability than the TV set it was being received on. This is especially noticeable on weak signals. I also found that signals with marginal sync were better on the monitor than on the TV set that was detecting them. An example of this improvement is as follows. I

tuned in an ATVer about 25 miles away who had very marginal sync (I won't give his name or call but he has, since this writing, cleaned up his signal a hundred fold).

1. On the Sony color TV - P1 to P1.5, severe vertical roll & horizontal tearing.

2. On the B&W RX set - About a P2, NO horizontal tearing but hard to lock up vertically.

3. On the B&W monitor - A solid P2, no horizontal tearing, a little vertical jitter but locked up.

I gave some thought as to what further improvements could be made. I have seen in both ATV Magazines advertisements & schematics for three different configurations of video processing amplifiers. These devices accept composite video input and allow independent control of video gain, sync gain, and composite video gain as output. I used the schematic from the Griffin Proc-Amp 1 and built it up from parts purchased from Radio Shack.

\*\*\* NOTE: This cost me more than I could have purchased it built & tested from Griffin Enterprises. I placed this assembly in the video line between the RX TV and monitor and found that I could vary the amplitude of the video on the received signal quite smoothly, this allowed me to effectively brighten a somewhat dark picture or vice versa. The great part however is that I could add sync to those signals where it was marginal. In the example above, on the B&W monitor the signal was now LOCKED SOLIDLY BOTH VERTICALLY & HORIZONTALLY. It was amazing, on the color

set the signal was unusable but on the video monitor Frank (Oops... I used his name!) was perfectly visible & locked up. Another benefit of this system is that my VCR will lock on to received signals & record them almost perfectly down to about a P1 level (before it took a P4 to P5). The only disadvantage is that there is no color (the color burst is lost in the B&W RX set). This system is not a cure all, if a signal has REALLY BAD sync, it won't give you a rock solid picture. It seems to help on weak signals and is great for seeing sync bars on super weak signals that don't show up at all on the regular TV sets. It's a neat way to get just a little more performance out of your ATV station.

**KB9FO tries to improve his balloon and ATV space shuttle signal quality ...**



"THE PICTURE IS ABOUT P2 NOW, THE ATV SATELLITE ORBIT IS A LITTLE HIGHER, CAN YOU TILT ANOTHER 10 DEGREES?"

YORK, PA

We get letters:

"On behalf of the Keystone VHF Club of York, I would certainly like to thank you for the very fine ATV seminar held on 23 sep 89 in York, PA. We owe our gratitude to Captain Video, aka Henry Ruh with captain video emeritus aka Ron Cohen and space captain video aka Bill Brown.

We have reviewed all our feedback forms and noted some common threads expressed in words like, 'excellent, lets do it again, we need more of these, nothing I didn't like,' etc.

A surprise to me and perhaps to you is the fact that the non-ham ladies in attendance also enjoyed themselves probably because of the good visuals provided mainly by the use of video tapes.

We were all particularly pleased by the high quality prizes awarded by ATVQ for the home brew contest. We especially want to thank you for this extra effort. About next year, because of the positive feedback we are going to start talking about doing it again. Naturally we will keep you posted as we build our plans for we certainly want you and Bill with us again if this be possible.

Again, please accept our appreciation for a very fine job. (signed) John A. Jaminet W3HMS."

OK John, thanks for the fine letter and we are glad everyone enjoyed the York ATV seminar. But it won't hold a candle to what we have in store for the Dayton ATV Party Friday night!

CHEAP ATARI ST SSTV

John Langner WB2OSZ wrote in to advise readers of inexpensive color slow

scan TV for the atari ST computer. Featured include send and receive Robot, Wrasse SC-1 and AVT modes, screen contains two images 128 x 120 pixels of 256 colors, menu of available commands. Test pattern generator provides checkerboard, color bars etc. Image manipulation provides effects of mirror, rotate, zoom, shrink among others. Load and save images with various file formats such as NEOchrome, Degas or your own format with 256 colors.

Ten images can be kept in active memory for instant access. Using a dot matrix printer you can print with 17 levels of gray. A low cost (\$7) interface connects to modem and printer ports or a high performance interface for a MIDI port!

A free demo version of the software is available from numerous user groups. Two listed here specialize in ham radio applications for Atari computers: Atari Microcomputer Network c/o John Adams KC5FW, 17106 Happy Hollow, San Antonio, TX 78232, send a formatted disk and \$2 for p/p. Or ASTUR, Geeraert Michael, W. Elsschotlann 21, B-8460 Koksijde, Belgium. Send 2 discs and three IRC's, one disk will return to you.

The demo version is capable of sending and receiving loading pictures from files, printing, manipulating images and generating test patterns. It just has a few limitations and annoyances to encourage frequent users to purchase the most recent version. SSTV can be very expensive but it doesn't have to be. With the low cost interface and demo version of the software you can be sending and receiving col-

or SSTV for about \$10!73 WB2OSZ, 115 Stedman St. Chelmsford, MA 01824.

CHICO-PARADISE, CA

These two communities are about 10 miles apart with a combined population of 110,000. There had been NO atv activity here until September when Tom W6SYX started transmissions from paradise on 33 and 70 cm. This was followed very soon by Dan N6RZJ from Chico on 33 cm. Meanwhile Ken WB6RHC who operates FM repeaters in the Chico area on 2 meters and 440 has been preparing an ATV repeater which is tentatively scheduled for location at Cohasset in the mountains above Chico with 33 cm input and 50 watts out on 70 cm. KB6QVI Joel is assembling his ATV equipment and should be on the air soon. We anticipate a goodly number of recruits for ATV. Eventually we hope to link to the Mt. Diablo ATV repeater which puts in usually good pictures despite being 180 miles away near San Francisco! DE Tom W6SYX.

CONNECTICUT

The W1NRE ATV repeater has changed frequencies from 439.25 in and 426.25 out to 439.25 out and 426.25 in. The reversal of input/output was prompted by interference from packet operators on 438 Mhz. They have temporary approval from their FC which adopted the reversal in september. There have been no adverse effects except for the loss of seeing the band openings trip the repeater since DX is on 439.25. Packet operation had made the 439.25 Mhz input "useless". Meanwhile work continues on a 33 cm ATV rpt. So far the transmitter is operational at 922

.25 Mhz in parallel with the 439.25 Mhz transmitter. The original coordination was 910.25 in and 923.25 out but was changed to 922.25. The 900 Mhz transmitter currently operates at 9 watts. Plans are to have a picture in a picture output on 70 cm with both 70 and 33 cm band inputs available simultaneously. de W1NRE.

McDONALD, OH

Herman McCreary has just finished the new ATV repeater in McDonald. It operates on 439.25 Mhz in and 426.25 Mhz out. It currently is operating with 80 watts using a LPTV antenna from Lindsay Antennas of Canada. They have since purchased a second Lindsay antenna because of good results with the first. They report only a minor lobe irregularity to an otherwise fine antenna pattern.

FLORIDA

ATVQ will be at Orlando Hamcation in March, look for us! We were also down in the Orlando area for our annual thanksgiving week vacation in sunshine and warm temperatures. Well, certainly better this year, no hurricane! We worked mobile ATV along the way with contacts in Huntsville, AL, Atlanta, GA and central Florida. The Space shuttle made a night launch again and so the whole family loaded up in the new ATVQ Video Van (1990 Dodge Grand Caravan) loaded with 2, 450, 1296 all mode and of course ATV with our famous 20 element J-Beam circular polarized yagi! (Only 7 antennas on the van so far....) We parked at the Kennedy space center and got a good view live, taped it on VHS with the camcorder and also watched the down-

link and local TV broadcast. Downlink? Yup, local ATV John K4GCC was relaying NASA select on 434. After the launch John and I had a two way mobile contact as well as three other local stations. The only problem was getting through the traffic back to Orlando and our resort rooms. Local ATV club is TV BATS and area ATV'ers should contact K4RBD at 453 Watts Way, Cocoa Beach, FL 32931 for info and newsletter.

VISA/MC

We have gotten a few inquiries asking why we don't take charge cards. The answer is very simple, Visa and MasterCard are very expensive for a small business to use. The bank charges up to 5% plus a monthly maintenance fee. Our experience is that while a handful may want to charge their subscriptions, it can't be that much of a burden to write a check for \$15 and we have only received 2 bad checks to date for which the bank charges \$20 for a return item. So there simply is no economic advantage and a considerable cost to ATVQ to offer charge card service. You will note that several other small businesses no longer accept charge cards or add a surcharge to the cost to recover the bank charges. Banks always get their hands in too. When I published A5 the local bank allowed us to have a checking/savings account with no monthly charges even though it was a commercial venture, because the annual volume was small compared to any retail business. Today we are charged for each check, plus each deposit plus each item deposited.

A typical \$15 check costs 10 cents to deposit plus 25 cents for the complete deposit plus the monthly fees. We save deposit fees by banking once a week. That's using the lowest cost bank we could find in the area. Some local banks charge 50 cents per item, \$1 per deposit, 25 cents per check and \$25 monthly fee. And if you thought you could simply deposit the commercial checks in your personal account, sorry, bank regulations do not allow it. If the name on the account/check is a business it cannot be put in your personal account. I don't know how it is in the boonies but that's banking in Illinois! Since Bill and I do not take any salary, using all income to produce, distribute and promote ATVQ, the bank is the only profit center! So why give them more with charge card fees?

ATVQ VISITS AND TRIPS

Besides our annual thanksgiving week vacation, you will find Henry regularly in the LA region operating 2 meters and soon also 434 Mhz ATV using a new portable ATV package. A dual band mag mount will replace the 2 meter mag mount I usually carry with the 45 watt Kenwood FM rig. Now that I've "discovered" R/S velcro its easy to carry around a complete instant ATV station for portable/mobile operation, besides the California ATV'ers tell me vertical is better! hi hi. I'm usually there for a day or two and can be found mobile from the time I land to the time I return the rental car! Well, a few minutes out for sleep and work!

Other regular trips

include the Orlando Hamcation (and booth), of course Dayton, and several weekenders to Indianapolis. I expect to be at the NAB convention in Atlanta the last week in March. Summer and fall look for ATVQ to venture to Texas, Louisiana, Peoria superfest, February Davenport hamfest, and York in September. I'll get in at least 1 trip to the great wet northwest in 1990.

**ANCIENT TV SIGNALS SOUGHT**

Andy G8PTH has been looking for old TV test pattern slides or cards. You may have noticed his advert in this column in past issues. Here in the states technology long ago replaced cutmoded station ID test cards and slides with solid state test signal generators and call letter displays. A few of these might be in some dark dusty station closet but the chances of finding any in the USA is very small. But Andy did strike old gold in Hungary. The response was a set of slides showing TV idents from each of the eastern block (iron curtain) countries. Glosnost works!

So those of you who still work in TV, how about sending Andy a station ID slide, network ID, test pattern slide or card so we Yanks don't look like a bunch of rich kids with only the most modern state of the art electronic gizmos. Surely some little station out there still has an actual slide ID laying in the discarded equipment bins!? Send it to Andy Emmerson G8PTH, 71 Fallcutt Way, Northampton, England NN2 8PH. Andy will even pay postage. Even better, Andy and several other Brits will be our

guests at Dayton, so bring your test and ID slides to the friday night ATV Party and extend a little "Glasnost" from the old colonies to the Mother country!

**SERIOUS SWLing**

Those of you who enjoy scanning the bands beyond the edges of hamdom should check out the Grove Enterprises catalog! Receivers, special antennas, filters and pre-amps to do just about any RF listening you care to, including TV. Send inquiry to PO Box 98, Brasstown, NC 28902. 704-837-9200.

**SERIOUS VIDEO COLLECTING**

Check out the premier edition of Video Collector Magazine. Loaded with hard to get videos. Connected with Video SIG, a concern specializing in special interest videos, the magazine is a cornucopia of information for alternative video. The VideoSIG catalog has over 1000 special interest videos. \$6.95 Video Collector, 1030C E. Duane Ave. Sunnyvale, CA 94086. 800-245-6717.

**BATC/SEVERNSIDE**

Received a nice photo from the UK showing (l-r) TV chairperson Viv Green GLIXE, CQ TV Editor Mike Wooding G6IQM, Bob Plats G8OZP (4th person not identified) taken at the Leicester Radio Ralley. The group offers a number of ATV kits including pre-amps, antennas, converters and transmitters. All are state of the art and many for 1296 and 2.3 Ghz. For a catalog of items write to S. P. O'Sullivan, G8VPG, 15 Witney Close, Saltford, Bristol, England BS18 3DX. Send about \$3 for postage (L2). de Viv.

**BIGGER TYPE**

We have had several compliments about the quality and size of the type Tom uses for his pages. So to help those of you who use 21" portable TV's we will use uncondensed type whenever space allows. The difference is we got 3 2/3 pages of uncondensed type into 2 pages allowing us to get more in each issue. To compensate we will run more pages per issue!





**BATON ROUGE**

ATV activity is buzzing. The Baton Rouge ATS has recently been through much red tape with the Louisiana state government and permission was granted to the club to install a remote TV camera and ATV transmitter atop the Louisiana state capitol building which overlooks the entire downtown area, Mississippi river and bridges. This was done in cooperation with the local weather bureau and Louisiana state office of emergency preparedness. Furthermore the club has recently installed another remote camera which sees the weather fronts coming from the northwest. These installations were done as a club project and much good local public relations was gained. The club can also call up color bars and weather radar through the ATV repeater at will. Membership is growing and a local ATV net is held each Monday at 7 PM, simplex audio on 144.75.



LA. state capitol showing position of remote ATV camera and transmitter.

**CENTRAL CALIFORNIA**

Activity is just getting started in the San Joaquin Valley. Tulare county has three active ATV'ers with more interested by overhearing ATV activity being coordinated on local repeaters. The possibility of an ATV repeater is growing and a site at 3500' is available on Bear Mountain east of Fresno. The plan is for an in-band repeater on 430 Mhz. The repeater project is under Pat W6-YEP. Local club demos by Rick WB6HQU and John K6YDW are being done to entice more ATV activity. Adjacent Kern county more active ATV'ers. It is expected that they will be able to link to Bakersfield using the Bear Mountain repeater as test transmissions from the repeater site were seen P3 with the antenna on the ground! A 50 foot pole should give ground clearance and clear views to both cities. de K6YDW

**HEARTS DESIRES**

John N5GIG in Baytown, TX would like to see articles about gen-locking circuits, character generators, digital video, interfacing and such. Also a simple video mixer circuit. Any readers care to contribute items? (Ed note: Try two diodes and a 75 ohm resistor for the simplest video mixer!)

**HOME VIDEO CONTEST**

Tapes have begun to arrive from hopeful ATVers who want a chance at the new ICOM all mode transceiver first prize or the AEA FS430A ATV transceiver and the 20 additional prizes!. Enter early, Enter often! There is no limit to the number of entries and non-hams can enter a video provided a licensed ham gets the transceivers. Non hams can receive the non transmitting prizes of antennas, receive converters, books, subscriptions, video equipment, etc. Over \$2000 in prizes!!!!



Ron, KB5BB Club secretary, installing remote weather camera at ATV repeater site.

## Construction detail of the 28 & 48 el Loop quad

Ken Stevens G4BVK

All loops were made of brass rod and then silver soldered onto the top of 4mm countersunk screws and then bolted to the boom.

The simplest way to go about making the loops is to form the rod around a mandrill which can be made of wood. The rod is soft and can be wound around the mandrill in one long length some 9 feet or so. This should give you a tightly wound spring. You can mark across the coils with a marker pen before you slacken the spring. By simply cutting with a pair of wire cutters across the marks this will give you a number of loops which are ready for soldering.

The diameter of the loops decreases as you go along the boom therefore the mandrill must also decrease. The mandrill I used when turned down on a lathe cut in steps from the largest size to the smallest loops. After the loops are soldered you then can

reshape the loops by forming them with a hammer on the mandrill.

The driver is made up of three loops mounted on a phasing line. These loops are different sizes to cover the large bandwidth required. Building the driver unit: first bend the phasing line into a small trombone shape. Then solder the loops on one at a time starting with the largest loop first. The phasing line is then mounted onto the feeder bolt assembly. The feeder assembly is simply a brass bolt drilled out so the solid coax can feed through it. Then the bolt with the driver unit can be simply bolted through the boom. By threading the coax through the bolt and soldering it, this will secure the coax to the driver assembly.

The dimensions for the boom are all taken from the reflector and I suggest when measuring the boom prior to drilling you measure it in the same way.

The difference between the 28 and the 48 element loop quad is merely their length and the diameter of the loops. The difference in gain would be around 2-2.5dbs. Gain of the 28el = 20dbi and 48el = 22.5dbi.

### Materials for building the loop quad

1) Brass rod (2.38mm). To build the 28 element version you will need approximately 6 meters of rod and around 12 meters for the 48 el.

2) Materials for the boom: For the 28 element beam I suggest using the 15x15mm aluminum with a small trombone support arm. Length of boom approximately 2.25 meters. The 48 element beam is almost twice the length, so needs a stronger boom, therefore I suggest 3/4x3/4 ins aluminum.

continued pg 55

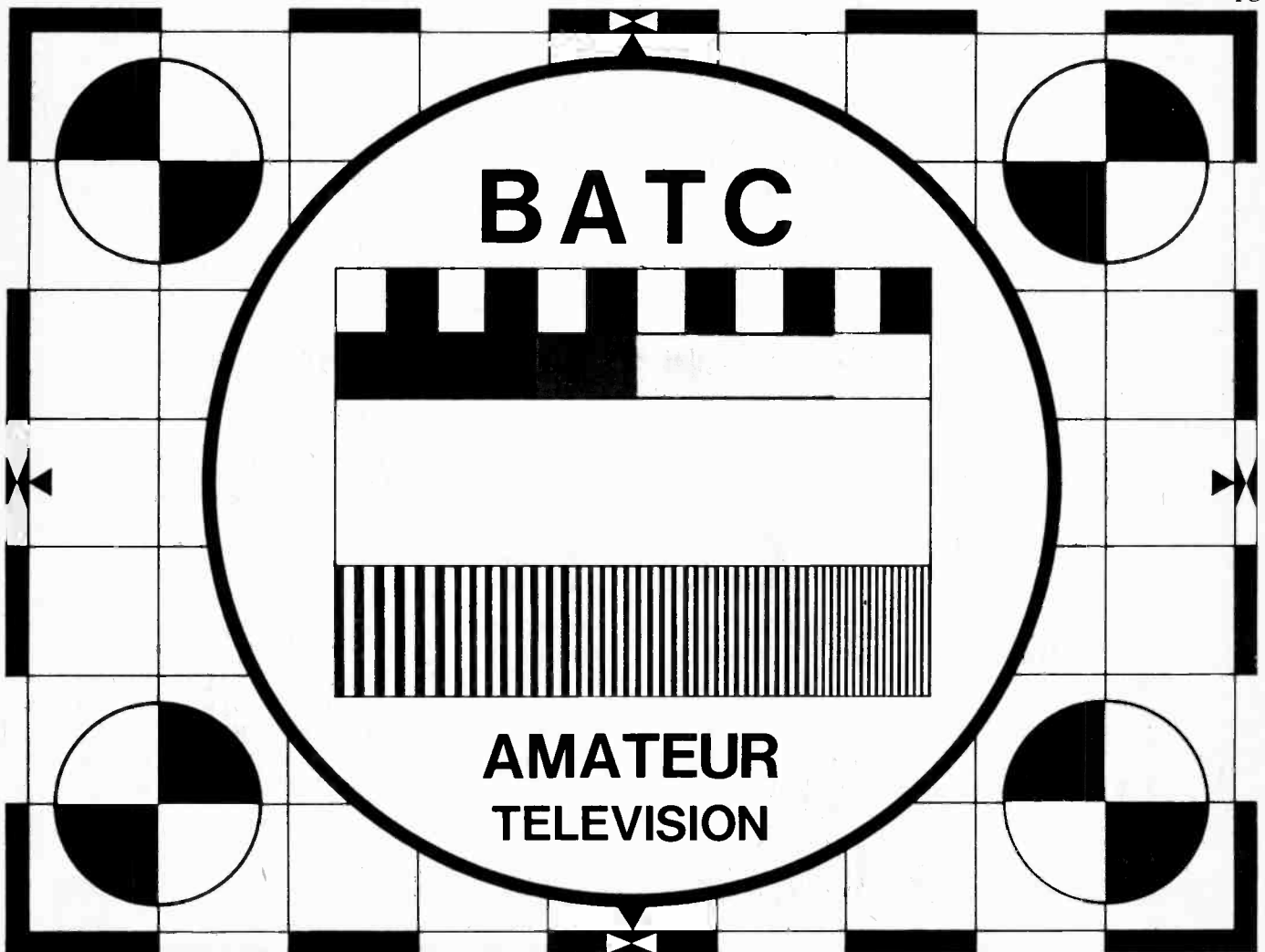

# THE BATC

## ARE YOU A MEMBER ?

YOU CAN BE FOR AS LITTLE AS \$12 PER YEAR.  
(\$19.50 PER YEAR TO RECEIVE YOUR MAGAZINE BY AIR MAIL)

FOR THIS VAST SUM YOU WILL RECEIVE FOUR ISSUES OF THE CLUB'S MAGAZINE, CQ-TV, WHICH IS ALWAYS PACKED WITH UP-TO-DATE PRACTICAL INFORMATION ON ATV DESIGNS. PRINTED CIRCUIT BOARDS AND SPECIAL COMPONENTS ARE ALSO AVAILABLE FROM THE CLUB AT REDUCED RATES. A SERIES OF HANDBOOKS HAVE ALSO BEEN PUBLISHED BY THE CLUB, DEALING WITH ALL ASPECTS OF ATV, FROM SETTING UP YOUR FIRST STATION, TO THE LATEST IN STATE-OF-THE-ART MICROWAVE GEAR. MANY OTHER SERVICES AND FACILITIES ARE AVAILABLE TO MEMBERS AND PRACTICAL HELP IS AVAILABLE ON ANY TV RELATED TOPIC

FOR FURTHER INFORMATION AND MEMBERSHIP APPLICATION FORMS ETC, CONTACT OUR UNITED STATES AGENT DON MILLER AT:

WYMAN RESEARCH INC, BOX 95, WALDRON, INDIANA 46182  
TEL: (317) 525 6452

(CHEQUES PAYABLE TO WYMAN RESEARCH PLEASE)

## *COMING IN THE NEXT ISSUE OF* **CQ-TV**

CONSTRUCTION ARTICLES FEATURING: A PARAMETRIC TRIPLER FOR 24CM, FUGI LENS MODIFICATION, BBC COMPUTER CONTROLLED SSTV, VIDEO DISTRIBUTION AMPLIFIER, DIY ROBOT-1200, STEREO AUDIO PRE-AMP, TUNABLE INTERCARRIER SOUND IF FOR DX-TV RECEPTION, PLUS LOTS OF NEWS, DX-TV NEWS, AMIGA SOFTWARE NEWS, SERIES ON USING OSCILLOSCOPES, PLUS LOTS MORE! MAKE SURE YOU GET YOUR COPY. SEND YOUR SUBSCRIPTION TO DON AND JOIN THE 2500 OTHER ATV'ers WORLDWIDE, WHO MAKE UP AND ENJOY BEING A PART OF

THE BRITISH AMATEUR TELEVISION CLUB

# G4BVK Loop Yagi Construction Details

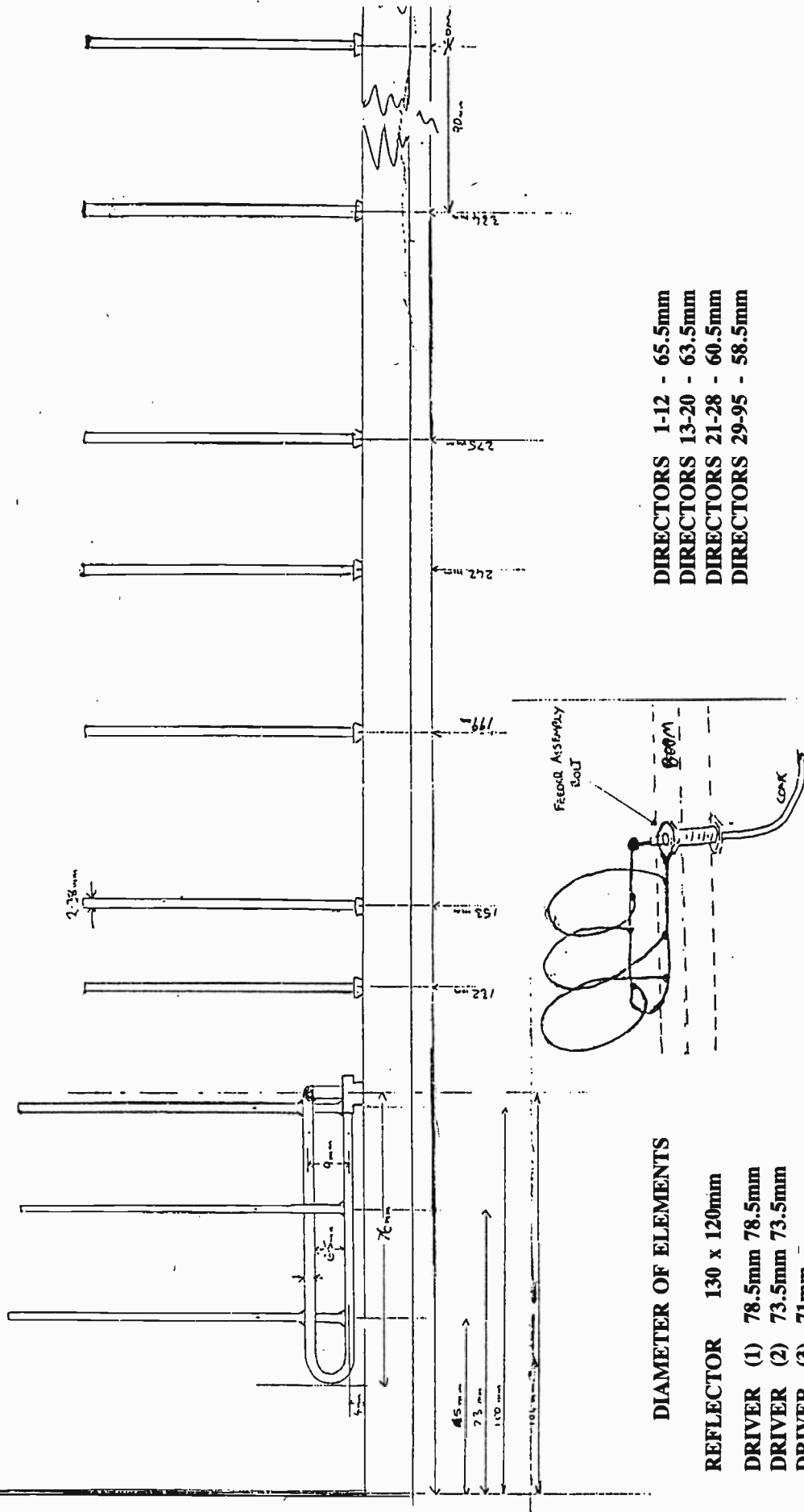

# Video Distribution Amplifiers

Extract from CQ-TV

Standard levels for both video and pulse distribution are defined as being measured when the source is correctly matched into the standard impedance of 75Ω. Consider Figure 1 which shows the equivalent circuit of matched source and load. This consists of a source of EMF ( $E_s$ ), in series with a resistance  $R_s$ , representing the source impedance. This is connected to  $R_L$ , the load, which, for correct matching, should be equal to  $R_s$ .

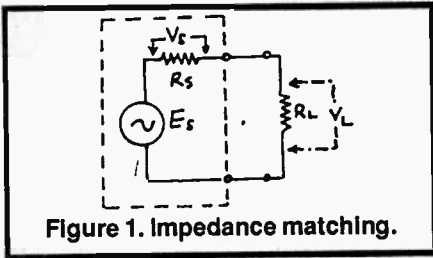

Figure 1. Impedance matching.

It can be seen that  $R_s$  and  $R_L$  form a 2:1 potential divider across  $E_s$ , and so if 1V of signal is required across  $R_L$ , the signal voltage  $E_s$  must be double this, 2V. Also, for the source impedance to be equal to  $R_s$ , the signal source  $E_s$  must theoretically have zero output impedance—in practice a value of a few ohms will be satisfactory.

Figure 2 shows a practical realization of Figure 1. In order to give a correctly matched 1V signal across 75Ω an amplifier with a gain of two and a very low output impedance is required to feed the potential divider  $R_s$  and  $R_L$ .

If the source is now fed into a load that is much larger than 75Ω, virtually all of the signal ( $E_s$ ) will be developed across  $R_L$ , and to all intents and purposes the signal will be doubled that when correctly loaded. The output is then said to be "unterminated".

It is possible to feed from very low impedances directly into  $R_L$  without a "build-up" resistor ( $R_s$ ) (see Figure 3). Although this will give the correct level across 75Ω without the necessity for a voltage gain of 2, it is incorrect as the source and load are not matched, and reflections could occur (particularly when feeding long cables). I do not

propose to go into transmission-line theory in this article, but this is the criterion that should apply to all video and pulse matching.

## Video distribution amplifier (VDA)

The purpose of a VDA is to accept a video input signal and provide several (usually three to six) mutually isolated 75Ω impedance outputs. The frequency response must be flat to at least 5MHz and preferably extend down to DC. The amplifier does not usually provide any overall voltage gain—a 1V p-p input signal will provide a 1V p-p signal across 75Ω at each output—but of course it is providing power gain. The input impedance is usually high (greater than 10kΩ) so that it does not load the signal source when "looped through". A switched 75Ω resistor is usually incorporated to "terminate" the input.

## ATVQ

1545 Lee, Des Plaines, IL 60018

*The place to send all those articles you have been waiting to see in print.*

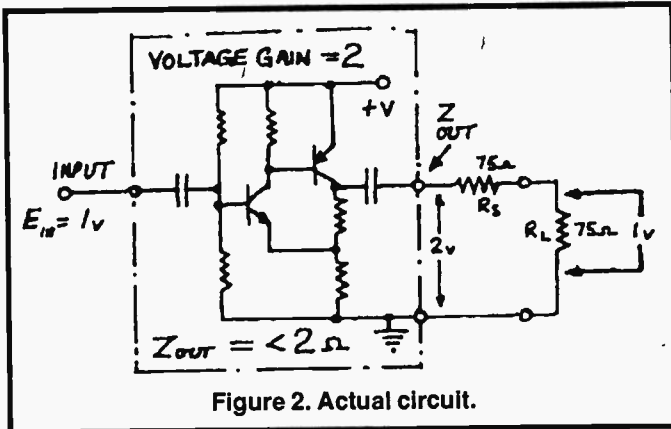

Figure 2. Actual circuit.

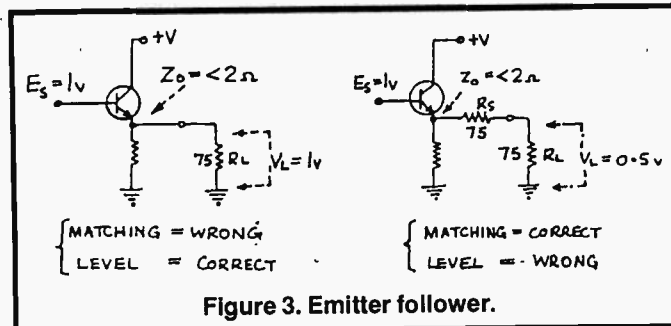

Figure 3. Emitter follower.

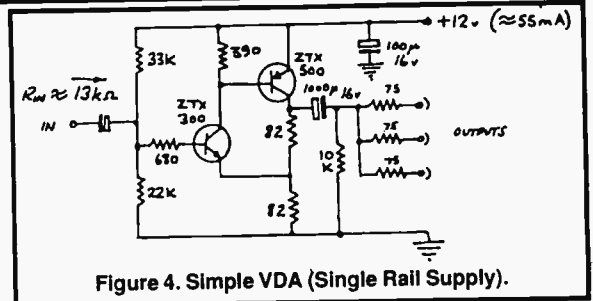

Figure 4. Simple VDA (Single Rail Supply).

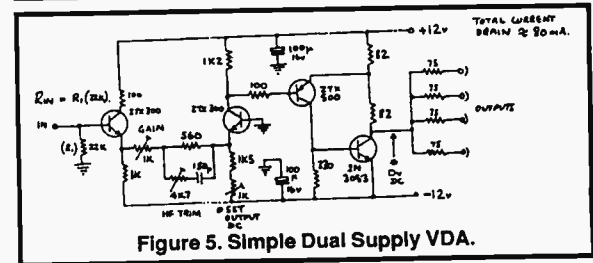

Figure 5. Simple Dual Supply VDA.

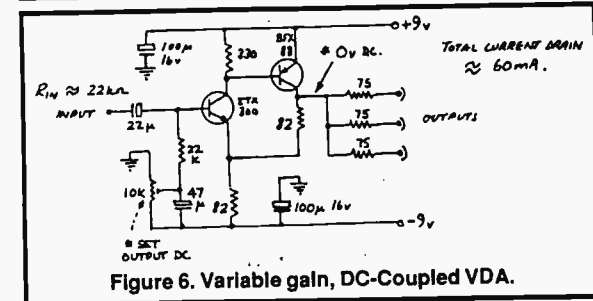
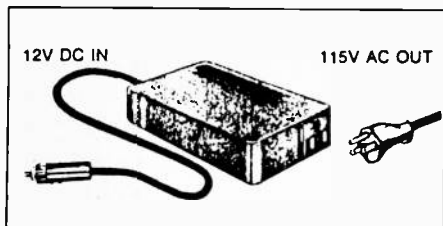

Figure 6. Variable gain, DC-Coupled VDA.



# Pocket Power Converter

**MODEL PC100 + - \$ 149 ppd.**



The Pocket Power Converter is the perfect way to operate your AC powered computer or peripherals from battery power.

Advanced technology and solid engineering have come together to make the Pocket Power Converter the smallest, most versatile and most reliable product of its kind.

Built-in features like instant-on, ultra high efficiency, complete electronic protection, low battery alarm (at 10.7 volts), and low voltage shutdown make it trouble free and simple to use.

### Specifications

Voltage In: 10-15 VDC  
Voltage Out: 115 VAC RMS  
Output Frequency: 60 Hz  
Peak Power: 200 Watts  
Constant Power: 100 Watts

Height: 1.2" (3.0 cm)  
Width: 3.5" (11.5 cm)  
Length: 4.5" (9.0 cm)  
Weight: 14 oz. (400 grams)  
Warranty: 6 months

## WA6SVT VIDEO PROCESSOR

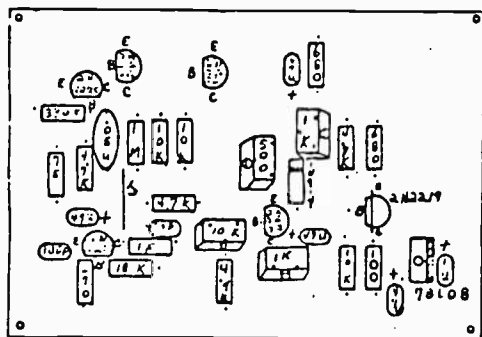

- INDEPENDENTLY CONTROL VIDEO & SYNC LEVELS
- CAN ADJUST COLOR BURST LEVEL
- SET WHITE CLIP LEVEL

Assembled / Tested ..... \$39  
Kit ..... \$29  
PC Board ..... \$ 7

### ELKTRONICS

12536 T.R. 77  
Findlay, OH 45840  
(419) 422-8206



Art K2AGT of DeBary, FL sent this photo of his mobile with K2AGT-TV license plate. A not too common call "tag". K2AGT by itself is on his other car!

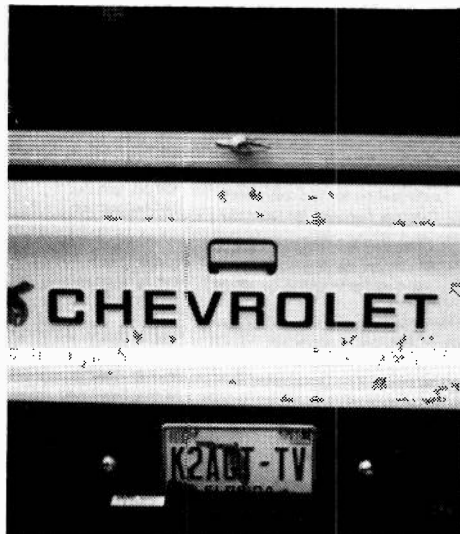

### ATV FROM ATN

The ATN group (So. Cal) has a new switching system developed by Mark Mumaw NU6X and Dan West K6DFM. The new system has multiple inputs/outputs for full interconnection between ATN repeaters. It features picture in picture and the first unit will be put in service at the Oat Mt. ATV RPT site. Santa Cruz Island link in now input 434 and output 910.25. The link has low power and a directional antenna to fill coverage of the coastal area from Ventura to Gaviota Beach later to link to Santa Barbara. Las Vegas may be added soon to the multiple ATV repeater system. Tests have been conducted on Mt. Potessie which is line of site with Crestline WB6VVV/R. Meanwhile

the Santa Barbara system is getting new equipment to link into Santiago Peak and Santa Cruz Island. Santa Barbara WB9-KMO/R has input at 434 and output on 1277.25. Dave WA6ZVE donated a Downeast Microwave 36 watt amp to the Oat Mt. ATV RPT improving signal quality greatly. TNX Mike WA6SVT

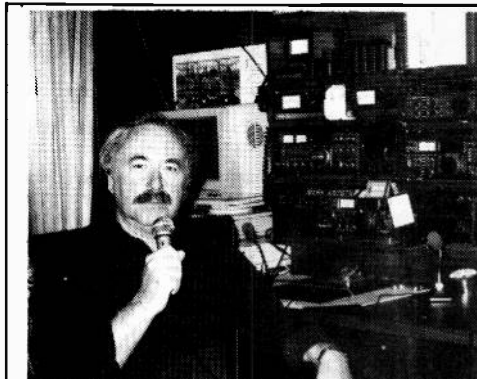

W7SRZ, Chuck Northcutt, president WWATS, Seattle host of Friday ATVQ ATV PARTY at Dayton 1990.

## MICROWAVE MODULES EQUIPMENT

Use your existing HF or 2M rig on other VHF or UHF bands.

### RECEIVE CONVERTERS

MMk 1891-137	333.00
MMk 1296-144G	235.00
MMc 436-ATV	99.00
MMc 432-28(R)	89.00
MMc 144-28(HP)	95.00
MMc 144-28	75.00

### LINEAR TRANSVERTERS

MMI 1296-144G	499.00
MMx 1268-144	395.00
MMI 432-28(S)	370.00
MMI 144-28(R)	499.00
MMI 144-28	265.00
MMI 435-28(S)	390.00



## VHF/UHF BANDPASS FILTERS

**KNOCK OUT INTERFERING QRM OR SELF—DENSE!**

3 and 5 pole models available

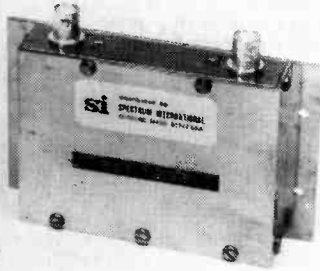

**BNC Standard TNC or Type 'N' optional**  
(slightly higher prices)

MMF-200-7	145 Mhz.
PSF 137-3	132-142
PSF 144-3	140-150
PSF 220-3	216-228
PSF 432-3	420-450
PSF 421-5	ATV Channel
PSF 426-5	ATV Channel
PSF 434-5	ATV Channel
PSF 439-5	ATV Channel
PSF 900-3	890-940
PSF 923-5	ATV Channel
PSF 1280-3	1230-1320
PSF 1280-5	ATV Channel
PSF 1296-3	1250-1340
PSF 1691-3	1650-1750

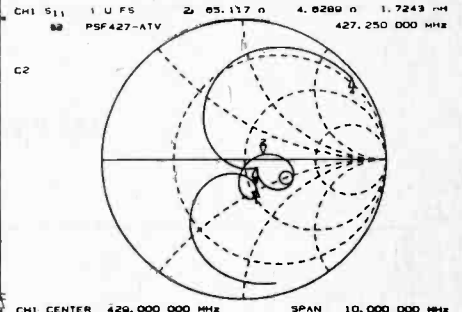
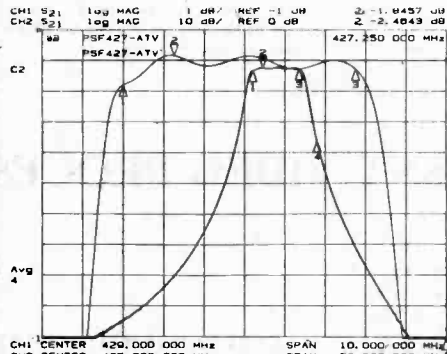

U.H.F. Filters	
MMI 200-7	\$ 55
PSI 137	175
PSI 144	175
PSI 220	145
PSI 432	95
PSI 421-ATV	145
PSI 426-ATV	145
PSI 434-ATV	145
PSI 439-ATV	145
PSI 900	95

Prices subject to change without notice.

U.H.F. Filters	
PSI 923-ATV	\$155
PSI 1280	95
PSI 1280-ATV	155
PSI 1296	95
PSI 1691	95

**Connector Options for Filters**

for MMI200-7 U.H.F.	\$ 45
Type "N"	15
for PSI... Type "N"	20

**General Information:** All prices are NET, FOB Concord, Mass. USA. Our terms are "Payment with Order" or C.O.D. Your personal cheque is welcome; Master Card and VISA are available for your convenience. On foreign orders, U.S. Dollar cheques drawn on a New York bank and Irrevocable Letters of Credit are acceptable. From Canada only, Postal Money Orders in U.S. Funds are convenient. Prices subject to change without notice.

**Delivery Information:** Domestic U.S.A. delivery is by U.P.S. or the Postal Service. Small parcels are sent U.P.S. Blue Label (air) where the service is available. Overnight express delivery via Federal Express or U.P.S. is available, n request, at increased charge.

Foreign delivery is by Registered (or Insured) Air Mail for small items. Large items and high value shipments are sent Air Freight, from Boston Int'l Airport, to your local airport for Customs clearance and collection. Air freight charges, etc. are payable in your local currency at time of collection of goods. Pro-forma invoices are available (if required) prior to placing your order. All facilities for Export Documentation are available.

**Returns:** All crystals are "non-returnable". Please request authorization before returning any item for check-out, repair or other reason. A re-stocking/re-testing charge of up to 15% of item list price will be levied on returns, plus a cancellation charge on cancelled orders.

Massachusetts residents add 5% SALES TAX to item cost.

Spectrum International, Inc. qualifies as a SMALL BUSINESS under Federal Procurement Regulation 1-1.702 and other govt. regulations.

# WORLD CLASS COMPONENTS AND ANTENNAS...

FOR THOSE WHO ARE SERIOUS ABOUT GETTING THE MOST OUT OF THE VHF, UHF MICROWAVE BANDS ON FM, SSB, FAX OR AMATEUR TV - WE HAVE WHAT YOU NEED!

## JAYBEAM 70 cm MULTIBEAMS

WIDEBAND IDEAL FOR ATV!

"THE DX'ER!"

"Our Most Popular Model!"

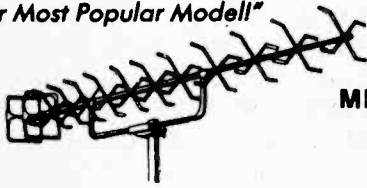

**MBM48/70cm**

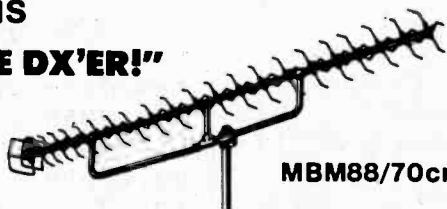

**MBM88/70cm**

2 way & 4 way Mounting Frames Available (Vertical slightly higher)  
MF4H MBM48 HOR \$69.00  
MF4V MBM88 HOR \$87.00

Antennas	
5XY-137 (137 MHz Weather)	\$ 90
10XY-2M	83
MBM28 - 70cm	65
MBM48 - 70cm	90
MBM88 - 70cm	135
DY20 - 900 (900/930 MHz)	89
1268-LY	65
1268-LY-XTN (add 21 elements)	89
1268-LY	65
1268-LY-XTN (add 21 elements)	65
1691-LY	75
1691-LY-XTN (add 26 elements)	70

Note: 1. All antennas include 50 ohms build-in BALUN.  
2. Order Loop-Yagi connector from accessory list below.

### 2 Mtrs. CROSSED YAGIS

"WE STOCK 2 AND 4 WAY POWER COMBINERS FOR 1268, 1296 and 1691 Mhz.!"  
NEW 900 Mhz. BEAM IN STOCK!

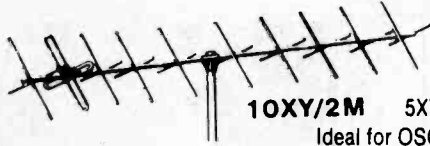

**10XY/2M 5XY12M or 137 Mhz. Models**  
Ideal for OSCAR or WEFAX Satellites!

Fourway harness



### PHASING HARNESSES

STACKING FRAMES AND MOUNTING KITS	
PMH2/2M	2 way phasing harness for two 2m aeriels
PMH4/2M	4 way phasing harness for four 2m aeriels
PMH2/70cm	2 way phasing harness for two 70cm aeriels
PMH4/70cm	4 way phasing harness for four 70cm aeriels
PMH/2C	2 way phasing harness for circular polarisation for two 2m aeriels
PMH137-C	Circular harness for 5x4/137

MF2-48	48 element stacking frame \$18.00
MF2-88	88 element stacking frame \$22.00
SVMK-48	Vertical Pol Mounting Kit \$22.00

All phasing harnesses and power combiners include Type 'N' (female) connector.  
"Write for Prices"

Harness Kits	
PMH-137C 137 circ Pol	\$ 20
PMH- 2C 2M circ Pol	23
PMH2-2M 2M 2-way	20
PMH4-2M 2M 4-way	55
PMH2-70 70cm 2-way	20
PMH4-70 70cm 4-way	37
900-2way (combiner)	ask
900-4way (combiner)	ask
1268-2way (combiner)	85
1268-4way (combiner)	95
1296-2way (combiner)	65
1296-4way (combiner)	95
1691-2way (combiner)	65
1691-4way (combiner)	95

Stacking Frames	
2-way	
MF2-48 MBM48 HV	\$ 20
MF2-88 MBM88 HV	24
4-way	
MF4-48 MBM48 Hor	\$ 69
MF4V-48 MBM48 Vert	79
MF4H-88 MBM88 Hor	89
MF4V-88 MBM88 Vert	99

SPECIFICATION	MBM28	MBM48	MBM88	1DXY	5XY-137	DY-20-900
FREQUENCY (MHz)	430-440	430-440	430-440	144-146	134-138	900-930
GAIN (dbd)	11.5	14.0	16.3	10.8	7.8	17 dbi
FRONT TO BACK RATIO	18 db	20 db	22 db	16 db		20 db
3db BEAMWIDTH	H45° E40°	H35° E28°	H28° E23°	E40°	H 58°	H 32° E 22°
DESIGN IMPEDANCE	50 OHMS	50 OHMS	50 OHMS	50 Ohms	50 Ohms	50 Ohms

PRICES SUBJECT TO CHANGE WITHOUT PRIOR NOTICE

# SPECTRUM INTERNATIONAL, INC.

Post Office Box 1084  
Concord, Massachusetts-01742  
508-263-2145



# 1280MHz FM TV Receiver

by Mike Sheffield, ZL1ABS



This receiver is built from a set of existing designs or modules that are already available. Figure 1 shows the make-up of the receiver.

The loop Yagi antenna is a design by ZL1TBG, already seen in *Break-In*.<sup>(1)</sup> The preamplifier is a VHF Communications design using an MRF901.

I used a PCB supplied by the Waikato VHF Group.

The first convertor is a simple design from the BATC Handbook. It is not crystal controlled but is adequately stable. It could be upgraded to use a balanced mixer and crystal oscillator if desired.

The second convertor/tunable IF

uses a Philips ELC2000 VHF/UHF TV tunable module. Its tuning range is quite sufficient to allow 1243MHz and 1280MHz to be received. The VHF part is not used in this receiver.

The FM-IF strip is another BATC design using two NE592 wideband amplifiers and an NE564 PLL IC. It works very well with the 38MHz output from the TV tuner module, and produces a standard 1V p-p video signal of either polarity, suitable for a monitor or RF modulator (to view on a regular TV set).

To recover the sound signal, I use a TBA120 $\mu$  sound discriminator IC in a basic circuit borrowed from the Philips data book.

This set of designs is described in a little more detail in the following, but I think the diagrams and the photos tell most of the story.

## BATC Converter

Input frequency: 1240-1330MHz (adjustable)  
 Output frequency: Adjustable over UHF bands 4 and 5  
 Overall gain: 25dB (typical)  
 Noise figure: around 4dB (optimized)  
 Bandwidth: +20 -40MHz from centre frequency at -3dB (typical)  
 Power requirements: 11-14V DC (12V nominal)  
 Overall size: 100mmx65mm

A BFR91 was chosen for the first signal amplifier which is adjusted for best noise performance. The second amplifier employs a BFR90 which is set for maximum gain. These transistors, although rather dated by today's standards, have proved among the easiest to use in this design, and are still readily available (Modular Electronics, Ambit International, etc). All the gain for the convertor is obtained from the two signal frequency amplifiers.

The mixer Tr3 is, for simplicity, a single-ended transistor type which is biased for unity gain. The IF is selected by the collector tuned circuit which will tune between 450 and 800MHz.

The local oscillator Tr4 uses an FET and is tunable over a wide range enabling virtually any IF in the UHF TV band to be used. The oscillator was found to be quite clean and to be sufficiently stable. It is quite important to use the specified FET, other types may not be satisfactory.

Although printed circuit techniques are used in order to ensure repeatability, it is not necessary to etch and drill conventional printed circuit boards.

Take a piece of good quality, single-sided fibreglass board 100mmx65mm and place it copper side uppermost. Cut out the pieces indicated by the shaded areas in Figure 2 from another

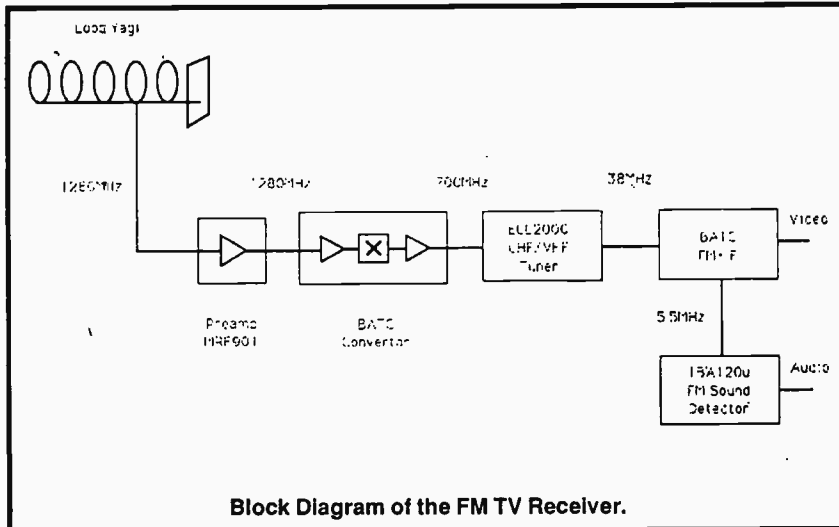

Block Diagram of the FM TV Receiver.

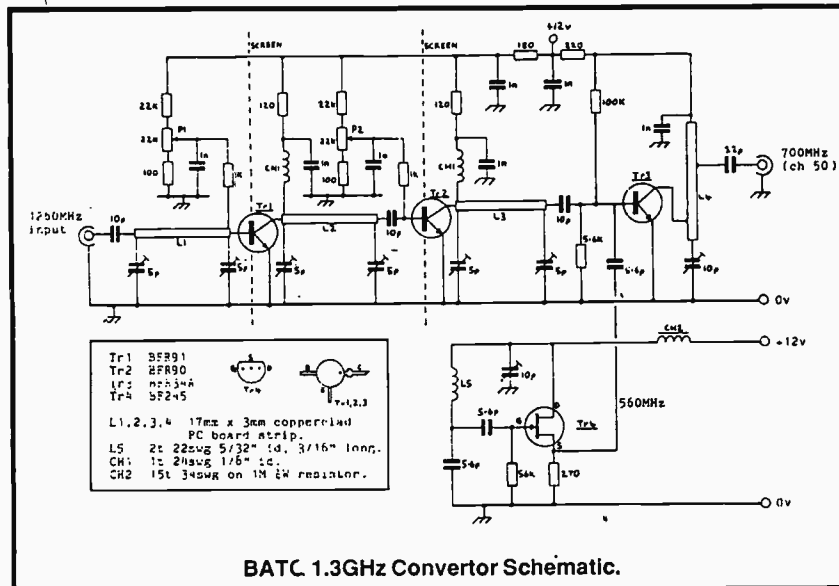

BATC 1.3GHz Converter Schematic.

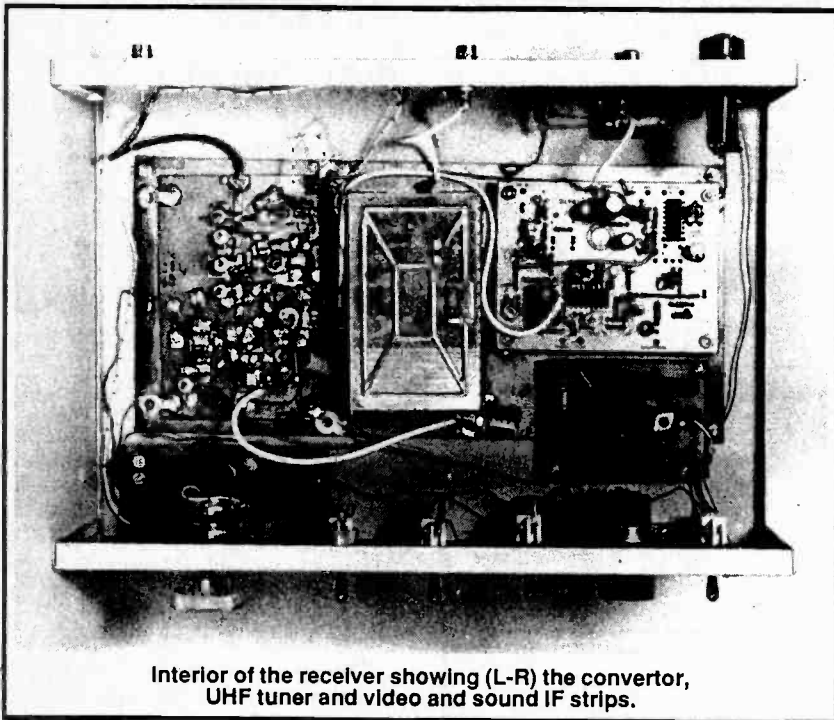
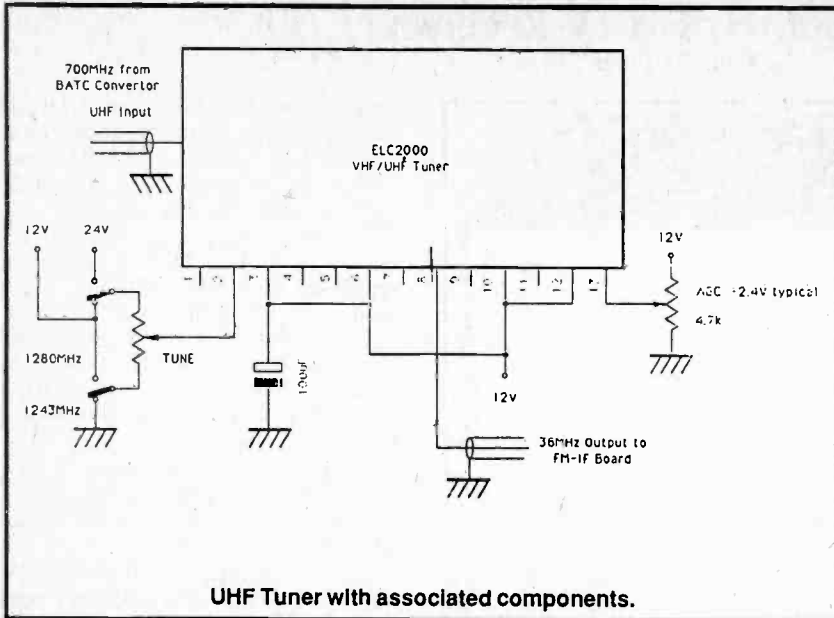

piece of similar material using a small saw. Glue these pieces, copper side up, to the main board so that the copper is insulated from the earth plane. The small pads should be about 3mm wide and no longer than that required. Screens, 12mm high, should be soldered to the ground plane in the positions shown. Thin gauge copper, brass or tin plate may be used for these.

### FM-IF Circuit Description

Input to the receiver is directly from a varicap tuner and is applied to gate 1 of Tr1. A MOSFET is used to give high amplification together with low noise performance. The (optional) tuned circuit L1, C5 and C6, provides some selectivity which helps the overall noise performance—R5 damps this circuit to provide sufficient bandwidth. The signal passes to an NE592 wide-band amplifier IC operating at the IF frequency. A gain control is provided but in this design will usually be set to maximum. The output of IC1 passes directly to the PLL demodulator IC2. This device was chosen for its superb linearity and ease of use. The circuit in various forms has been described before in CQ-TV. C14 sets the voltage controlled oscillator (VCO) which should be at the IF centre frequency. A test point is provided on the board for this purpose. The demodulated video signal passes through an emitter follower (Tr2) where the sound signal is extracted. The following passive circuit is a de-emphasis network whose response is set for the CCIR standard.

At present in the UK no emphasis standard has been established and indeed there may not be a need to do so for amateur work. Provision is made on the board though, in case de-emphasis is needed in the future, or in case the receiver is used for the reception of satellite TV. As not all received pictures may be pre-emphasized some may be degraded if the de-emphasis is left in circuit. For this reason constructors might choose to make the network switchable. Video passes to IC3—a

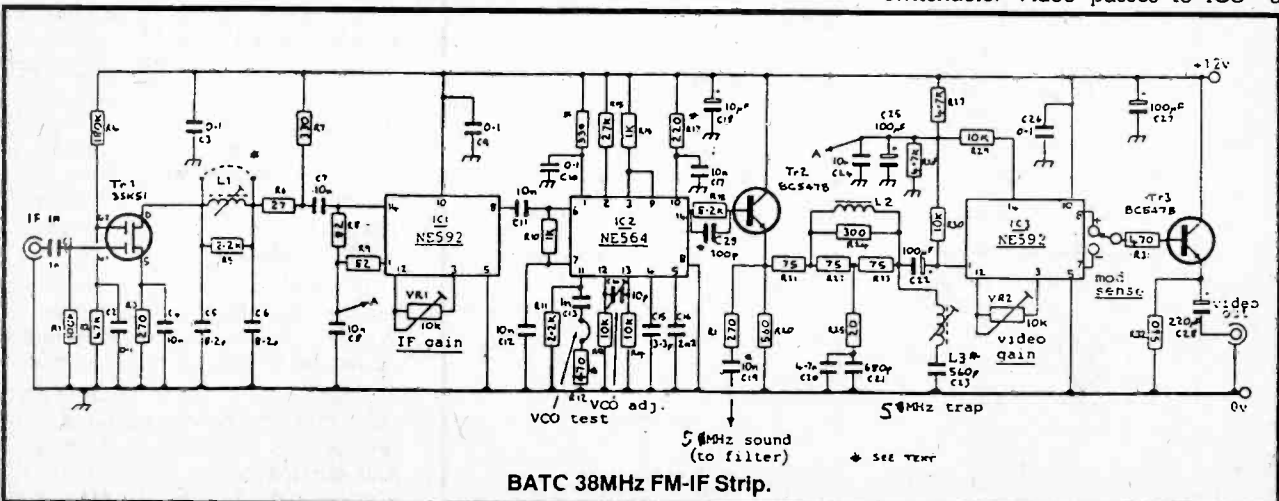

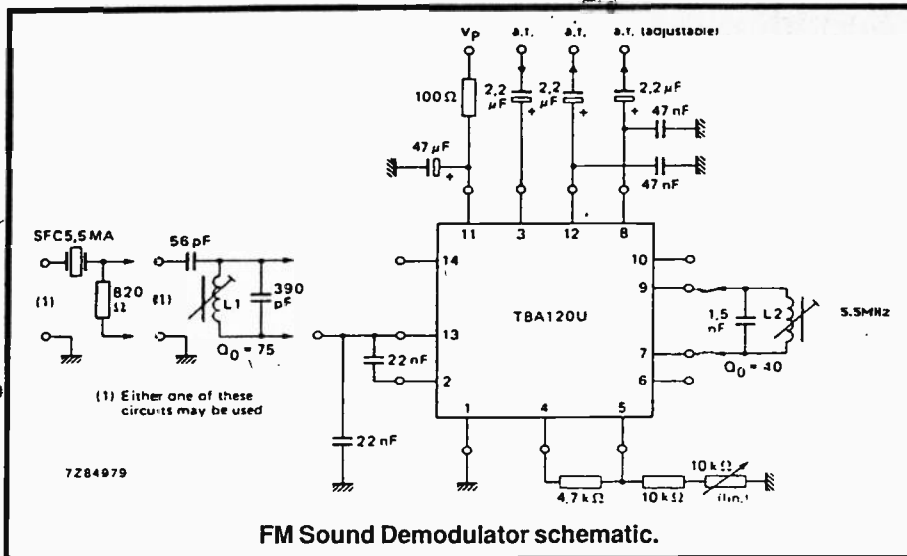

FM Sound Demodulator schematic.

## 5.5MHz FM Sound Demodulator

This circuit has general use for TV FM sound systems. It is used with the BATC FM-IF sound systems. It is used with the BATC FM-IF board so that sound and vision can both be demodulated from the SHF signals.

The TBA120μ IC has all the functions need in the one package. Other suffix versions (120s, 120t, 120a) are slightly different pinouts and functions. I have this data if required.

The ceramic resonator option was used. If a 5.5MHz IF coil is not available for the quadrature coil (Ls) a 10.7MHz IF coil can be padded down by extra parallel capacitors.

A fixed level output is available on pin 12, useful for squelch circuitry. Pin 3 is an auxiliary audio input. The TBA120μ gives about 1V of output. To drive a speaker a further audio amp such as an LM386 is needed. The 1V is fine if a video monitor with sound input is being used.

second NE592—this time acting as a video amplifier. This stage also has a gain control which sets the video output to 1V peak-to-peak into a 75Ω load. There are two outputs from IC3 providing both positive and negative-

going video signals. Provision is made to switch between these outputs enabling both standards to be received—useful for the continentals! Tr3 is another emitter follower providing a 75Ω video output.

## KISS 900 Mhz GOOD BYE

Just when you thought the fight for ham frequencies was over (for 220) Ham radio took another bite from the frequency grabbers. Amateur service is secondary on 900 Mhz and this band was just beginning to come alive in some areas, especially for ATV. We just received word that the FCC has approved Pacific Telesis (sound familiar...PAC-TEL) a PRIMARY service on 900 Mhz for a radio location system on 904-912 Mhz. This has the effect of immediate displacement of amateur users in this area of the band in the Los Angeles area, and soon some 25 additional met-

ropolitan areas. Stations operating on these frequencies in Los Angeles are reminded that they must cease usage of the frequencies in accordance with CFR Title 47, 97.303 g1. There will be announcements soon for new ITS service on these frequencies in Atlanta, Baltimore, Boston, Chicago, Dallas, Detroit, Houston, Miami, New York City, Philadelphia, Pittsburgh, San Diego, San Francisco and Washington DC in 1990. In 1991 additional areas will be Buffalo, Cincinnati, Cleveland, Columbus (Ohio), Denver, Ft. Lauderdale, Hartford, Indianapolis, Kansas City, Memphis, Milwaukee,

Minneapolis, Newark, New Orleans, Phoenix, Portland, Rochester (NY) Sacramento, Salt Lake City, San Antonio, Seattle, St. Louis, St. Petersburg and Tampa.

Frequency coordination in So. Cal has ceased for the band pending a meeting to see what will be left for amateurs to use and how to divide the available frequencies among the users. A word to the wise, choose a high end frequency for ATV (920-928) and get your ore in the water for a 1280 Mhz ATV frequency for your repeater in you are on 900 now. See your frequency coordinator now.

## INSTANT REPEATER OR AUTOMATIC ID

A quick and simple ATV RPT or mobile ID, mount an Elktronics ID board and a PC VOR-2 in a box. LEDs indicate power on, ID on, transmitter keyed. Switches select ID on/off/auto timer for automatic ID insertion every 10 min, and which of 4 ID "slides" from Elktronics unit. LED's of VOR-2 are remoted to front panel. BNC for video in/out, fuse and connector for power/TX key complete unit. Follow VOR-2 instruction sheet for simple connections. de Henry KB9FO.

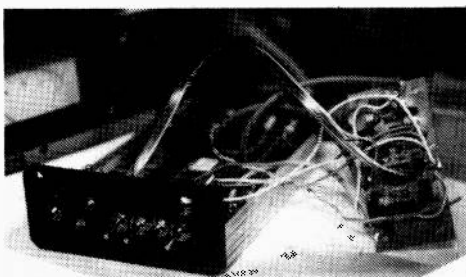

All wires connected, ready to mount VOR-2 board to top of box. LED's extended to front panel.

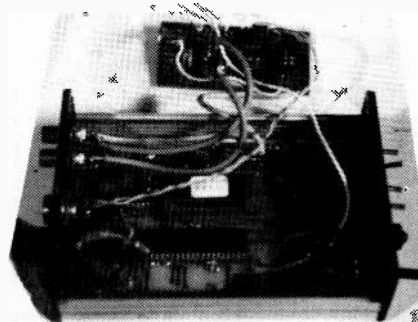

Elktronix board mounted to bottom of box, switches and connections wired and video/power leads run to VOR-2 board.



# Sound in the Studio

by John Goode, (CQ-TV)

When ATV is mentioned most people would first think of the visual signal, but the sound component is equally important. Often pictures without sound are completely unintelligible. So this article informs on the "sound in the amateur studio".

In a large professional audio setup balanced wiring for all sound feeds would probably be adopted. This means that a large number of input and output transformers will be used, in some cases for simple balancing, and in other cases for impedance matching.

For small scale amateur use, however, it would only be necessary to balance low-level microphone feeds, and then only if fairly long cable runs were used, or if it was necessary to operate in an electrically noisy environment. In TV studios the magnetic fields emitted by field scan generators, with

a fundamental of 50Hz plus harmonics, are particularly nasty, so try to keep low-level audio away from cameras and monitors. When this isn't possible, balanced microphone working could help. The other situation where balancing is essential is when phantom-powering of capacitor-mics is required. However, for the amateur, professional microphones with balanced outputs are rather expensive, the cheapest dynamic microphone of this type (I think) being the excellent AKG D190 at around £60. As for phantom-powered capacitor microphones, we are talking of £200 plus!

## Practical amplifiers

These days virtually all the low power requirements for audio can be met using operational amplifiers. For line level applications the 741 is usually adequate; for low noise amps, and application such as filters that need

high slew-rate the TL071 series of FET input op-amps can be used. All circuits are versions of the two basic op-amp configuration, see Figure 4. The non-inverting configuration gives virtually zero impedance at the inverting input (the so-called "virtual earth" point), and so it is an almost perfect mixing amplifier. This is because the input signals can be applied (via input resistors) as currents that will all flow into the virtual earth point as its impedance is much lower than that of the input resistors—this gives very good isolation between channels. See Figure 5.

## Distribution and switching

Figure 1a shows a simple distribution amplifier with a 600Ω output impedance, 50k input impedance, and a gain of two to overcome the matching loss. If 600Ω working is not required, simple voltage-follower can be used, see Figure 1b.

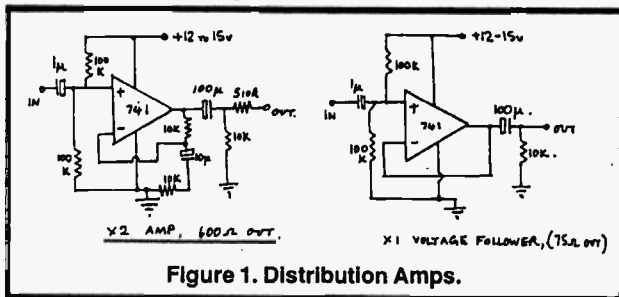

Figure 1. Distribution Amps.

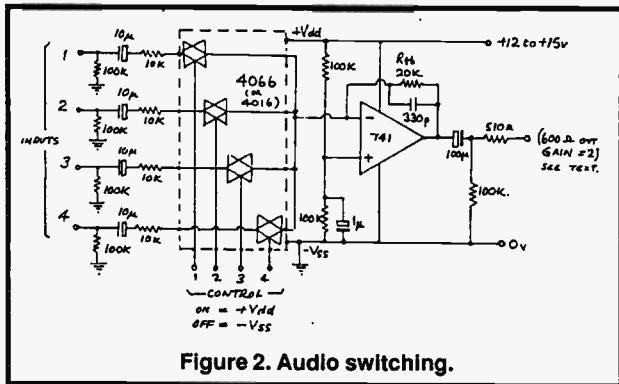

Figure 2. Audio switching.

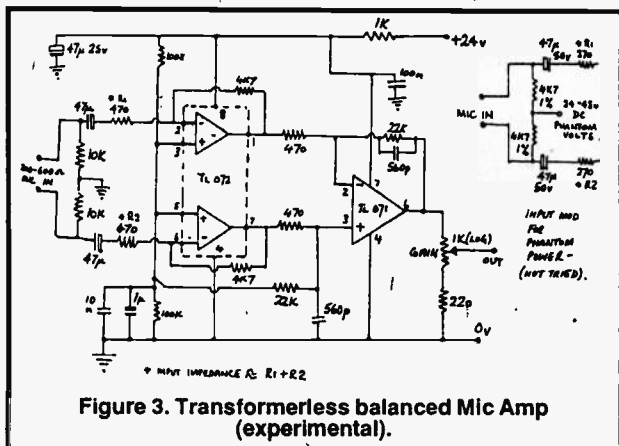

Figure 3. Transformerless balanced Mic Amp (experimental).

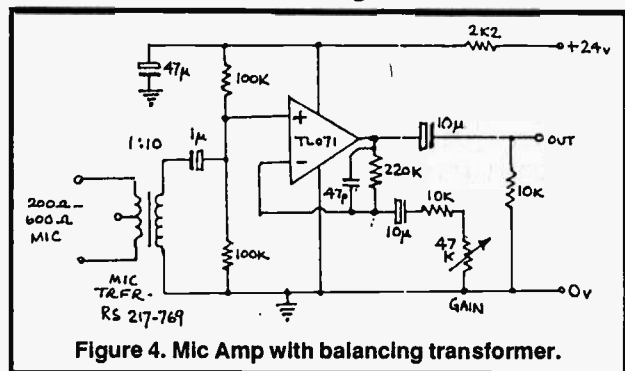

Figure 4. Mic Amp with balancing transformer.

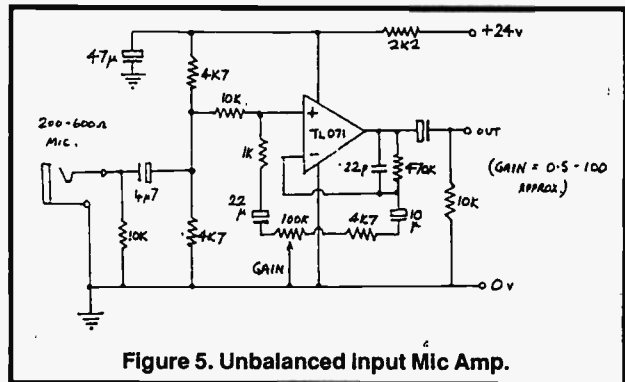

Figure 5. Unbalanced Input Mic Amp.

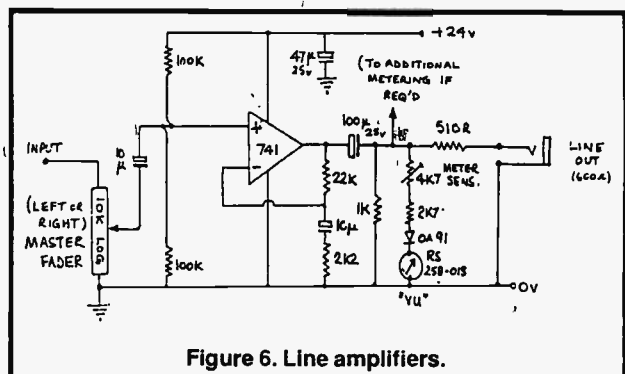

Figure 6. Line amplifiers.

Switching is best achieved using CMOS analogue transmission gates such as the 4016 and 4066—however, remember that the supply must be limited to 15V for these. A good method is to use them at the virtual earth point of a 741 mix amplifier—see Figure 2. Of course, switching audio with video is possible by deriving the control volts from a common switching system. In Figure 2 the amplifier is set to drive a 600Ω load; if this is not required the feedback resistor should be reduced to 10k for unity gain, and the bandwidth—limiting capacitor increased to 680pF. The 510Ω build-up resistor can also be omitted.

### Microphone amplifiers

An example of a balanced microphone amplifier is shown in Figure 4, using the RS 217-769 microphone transformer (available through Electromail), and a TL071 op-amp. The microphone transformer is for matching 200 to 600Ω microphones to 50kΩ; if we take the source as 500Ω, and apply the rule derived above:

$$(Z \text{ ratio}) = (T \text{ ratio})^2$$

$$(50,000/500) = 100$$

$$\text{Turns ratio} = 10:1$$

It's important to know the turns ratio, as the voltage step-up will contribute to the overall voltage-gain of the module. The amplifier itself is connected in the non-inverting mode, its input impedance being defined by the two 100k biasing resistors in parallel. The amplifier gain can be varied from 5 to 23, which, in combination with the transformer step-up, gives a voltage gain of 50 to 230. A further gain of about 1.0 is required to reach line level, and this would be supplied by the subsequent line amp in a sound desk.

The trouble with microphone transformers is their cost, as it is quite diffi-

cult to make a well-screened unit with a good frequency response for handling low level signals. The one specified above costs approximately £15, and so if several channels are required this can get pretty expensive. An alternative, but one that I have only "bread-boarded", and have not used "in service", is to use a differential input amplifier. For those of you that might like to experiment, I offer Figure 3, but remember that it is experimental, so don't write to me if it isn't good enough. (On the other hand, if it works brilliantly you may write to congratulate me!). The input circuit consists of a dual op-amp (TL-072) arranged to present about 1k to the microphone. This is higher than the nominal impedance, but as dynamic mics are inductive their impedance tends to rise at high frequencies. By choosing a figure slightly higher than nominal the upper end of the frequency response is maintained without causing too much of a mismatch. (This problem does not occur when using a transformer, as this, like the microphone, is inductive). Having matched to the microphone with the TL072, a TL071 is arranged as a differential amplifier to balance out any interference, thus serving the same purpose as an input transport. The inset drawing shows how phantom powering may be added using resistors matched to 1%. Note the change in polarity of the input capacitors. The gain is adjustable up to about 450.

Figure 5 is an unbalanced microphone amp, once more for 200–600Ω microphones. As with Figure 3, because the input is resistive, a figure of about 1.8k is presented to the microphone to maintain the HF end of the response. The arrangement of the TL071 here is interesting, as it is a variation on the non-inverting mode, this being combined with an input attenuator. In this way the gain can be

varied on a single control from about 0.5 to 100. This means that used in a mixer, this channel could handle signals from microphone level right up to about -20dB (say 75mV). For amateur use, this is probably the most useful of the microphone circuits I have shown, although as in Figure 4, a further 20dB of gain (x10) is required to reach line-level.

Figure 7 is a circuit for a line-up oscillator that can inject tone into the mix-busses. In a stereo mixer it is best to have two oscillators of different frequencies so that if tone is injected into both left and right channels simultaneously they do not add in phase, causing any derived mono outputs to indicate +6dB. The circuit itself is an RC phase-shift oscillator, oscillation being maintained by the inverted output from the collector of Q1 being shifted into phase at the base of three RC couplings that each give 120 degrees shift at the chosen frequency. The output preset is adjusted so that with the master faders at their nominal setting, the tone reads line-up level at the output of the mixer.

### Line amplifiers and monitoring.

A line amplifier with a gain of 10 is shown in Figure 6, following the master fader control. A build-up resistor to give an output impedance of about 600Ω is included; however, if it is preferred this may be omitted, and then the output impedance will be about 70Ω. If the mixer is to feed several destinations simultaneously, a low output impedance will probably be better.

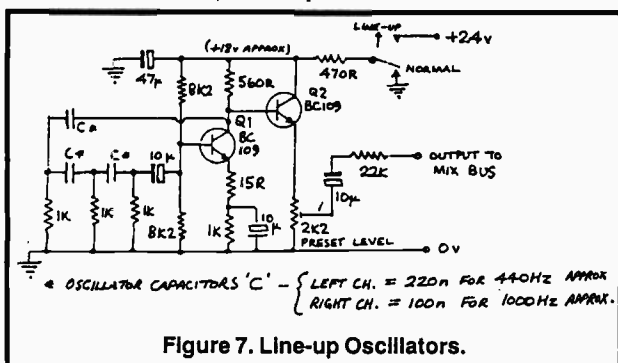

Figure 7. Line-up Oscillators.

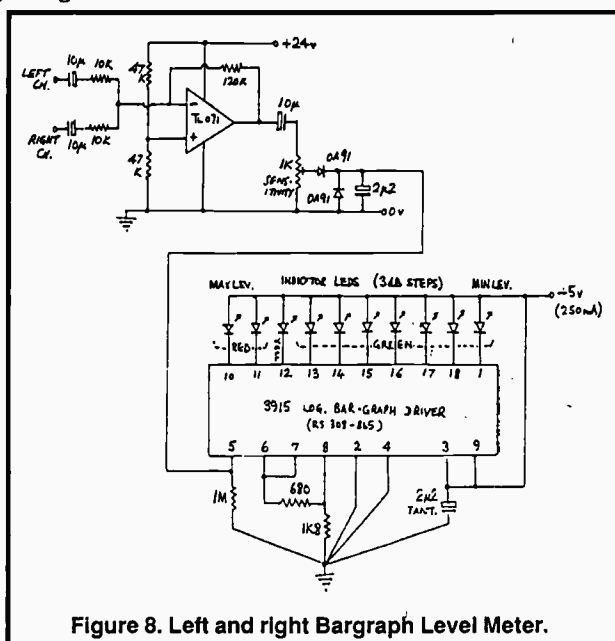

Figure 8. Left and right Bargraph Level Meter.

**Support the  
advertisers that  
support "ATVQ"**

# 1000

Is getting closer. Probably as you read this I am sending congratulations to our 1000th subscriber. We were less than 2 dozen away as I wrote the last of the January issue and sent it to the printer. We continue to grow with over 100 new subscribers since the October issue. We know its mostly the good reviews given by word of mouth (picture by ATV?), some from referrals from ATVQ advertisers (bless them all) and our own advertising and promotional efforts. We are seeing a lot of new ATVers join the ranks. About a quarter of the subscriptions lately have been from folks, "just getting started" or "new, not on air yet" as they comment on the sub form. Renewals are also ahead of our expected level. This tells us we must be doing what you want us to do.

This issue is a little late because Tom W6ORG was swamped by December business and couldn't get his column in on time. This also allowed us a little time for family at Christmas. Big doings at TV HQ was a lot of home improvement! The entire ham shack was taken out to put in all new copper plumbing, replacing the old mineral clogged iron pipes, and a new 200 amp buried electrical service. The new panel was put Dec. 21, just in time for the cold weather (-21 f). As soon as Edison puts the new service wires in I can hook up the radios and get back on the air. The ATVQ ham shack now has 4 Ampex quad tape (2") machines, 6 Sony 3/4", 3 VHS and 1

Beta, plus 1 Betacam (Broadcast not home Beta) and 1 VHS Camcorder. Buried in 8 racks of monitors, TBC's processors and such are another 72 filled AC outlets! The Ampex machines take 20 amps at 220V each (Edison will LOVE me!) and most of the rest, plus the entire house was on the old 60 amp service. Never had a ny problems with ice on the wires! Nice warm glow on a dark cold night! We have 1 12' satellite dish operating and will wait till spring to put up the 20' dish. The 20' dish will have xmit capability, the 12' is rx only. I'm also going to spend a few bucks with Bill Olson (Downeast Microwave) this spring for a bigger 900 and 1200 array. Anyone want a pair of F9FT 900 and 1280 Mhz yagis?

In the strange but true dept, I received in the mail a newsletter which I pay \$400 a year, a simple 8 page "typewritten" industry trade bi-weekly and two subs with comments, one said, lower our subscription rates, the other said he expected for \$15 a year to get a 5 page typewritten mimeo sheet and was pleased at the quality and color of ATVQ. Shucks, we just don't feed a family of 8 and our video habit from our small magazine so you get lots of pages of articles, news and color. Here are some shots of the ATVQ ham shack under construction. 73 KB9FO

ATV DX RECORDS -  
Worldwide  
The following DX records

have been claimed for 70 cm: W5VDS (Wimberly, Texas) and WA4GRK (Pinellas Park, Florida) 941 miles (1550 km). KOIWA (Burlington, Iowa) and W3POS (Erie, PA) 578 miles (931 km). G8LIR/P and DK1PZ during the 1988 International Contest 556 miles (895 km).

On the 1200 Mhz band, W5VDS and WA4GRK made a 941 mile contact (1550 km) on March 13, 1989. However this was not good enough for a world record since VK5QR in Adelaide, Australia worked. VK6WG (Albany, Australia) over a 1242 mile path (2000km) 11-19-'82 on 1290 Mhz.

Note that the world distance records on both 70 cm and 23 cm were both mainly water paths, across large bays or gulfs. Who'll be the first to take advantage of the nearly annual 2500 mile (4025 km) UHF opening every July/August (sometimes March/April) between Hawaii and southern California??

Other 23 cm first from the UK are France: G3YQC (Rugby) and G8VBC (Burton) to FLEDM (Le Havre) on 1/23/83. Netherlands: G8PTH (Northampton) to PELDWQ on 8/25/84. Germany: G6YKC (Nottingham) to DJ7JF on 6/18/89.

Thanks to the BATC for the above information.

Please send us your best DX reports (Time, Date, Freq, distance and signal report) for our best Worldwide List in an upcoming issue of ATVQ.

If you can supply lat. lon. station locations we have a program to calculate both FCC and great circle distances and reciprocal headings for your DX claims.

73 Bill WB8ELK

**Messiest Shack Of The Year Entry!**



**Back of the rack and storage shelves**

**KB9FO Under Construction**

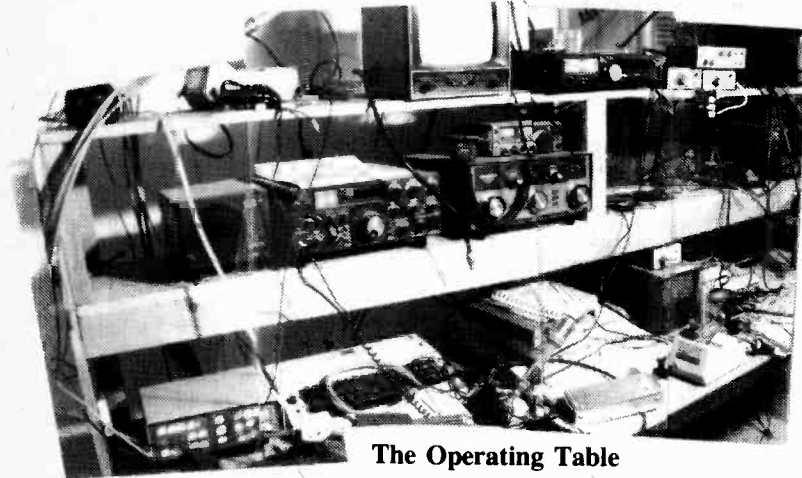
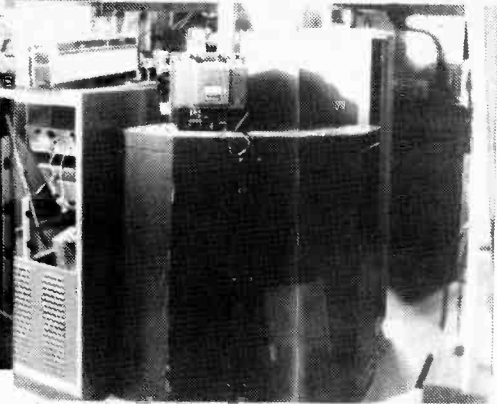

**The Operating Table**



**Tapes and goodies**

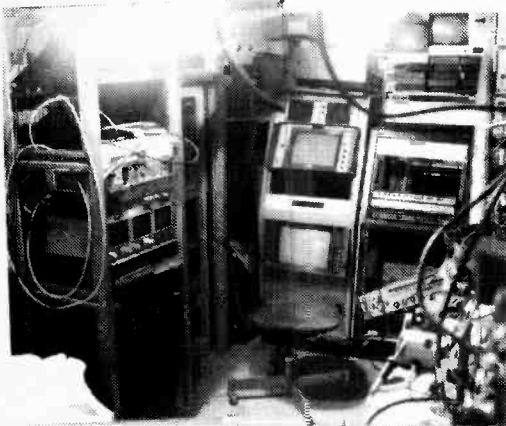

**Rack front**

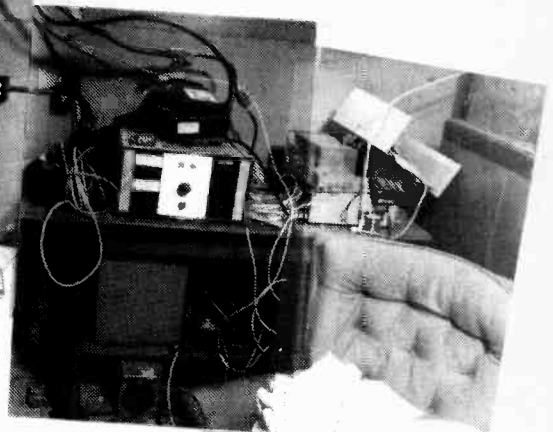
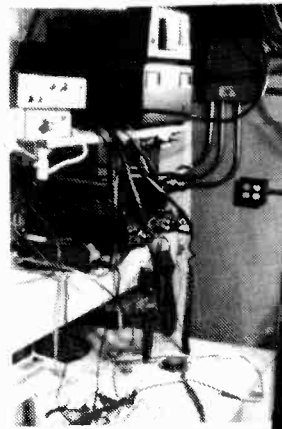

**RF Power**

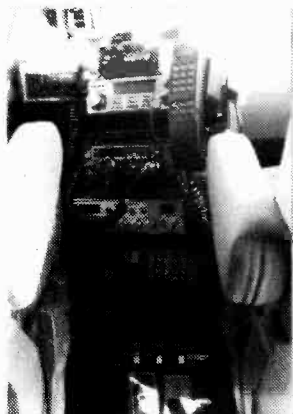

**Inside the new ATV Mobile**

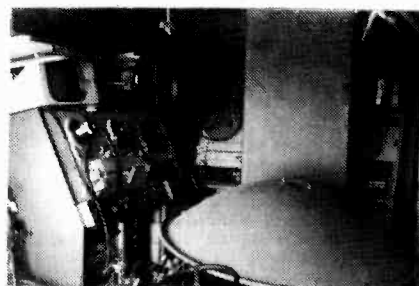

**The Garage**

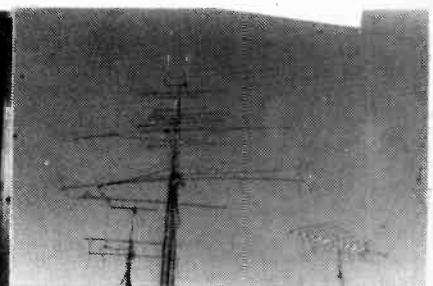

**The Farm — 6, 2, 220, 450, 900, 1200**



TDSYSTEMS

\* Soft Touch Electronic Switching  
\* Upgrades to Other Bands

\* Low Loss Cable NOT Required  
\* Built in Modulator

**ATV**

**AM & FM**

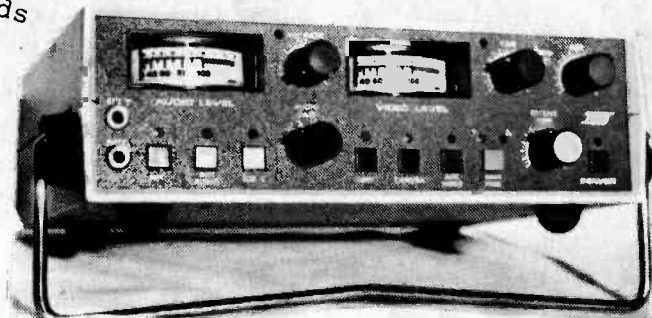

\* Automatic Mic Level

\* Video White Clipping Provided  
**CU-125 CONTROLLER**

\* AM, FM Or Both Modes

For Smooth, Easy Operation, and Flexibility in Your ATV System, Build up Your Own Station By Selecting the Appropriate R.F. MODULES of Your Choice.

The CU-125 Control Unit Produces All The Control, and Processing Needed To Send And Receive ATV Pictures on Any of The Bands Covered By Our Transmit and Receive Modules.

If You Decide To Update Your Band Of Operation Or Try A Different Mode, Just Add The Required Transmitter, Converter, or Both At The Antenna And Your In Business Without loosing the Old System. Just Switch Between The To.

**RCC-10 RECEIVE CONVERTER CONTROLLER**

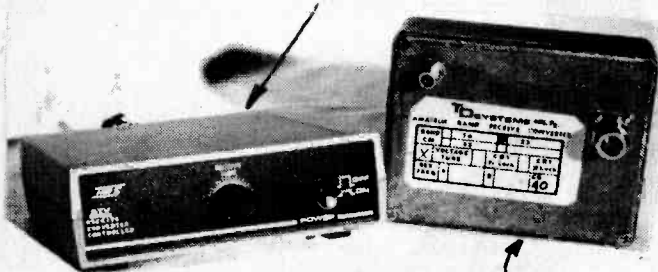

23 CM CONV

Incorporated in the CU-125 Control Unit is two Independent Video Inputs, One 10 Pin, and One RCA Jack. Each with its Own Video Level Control. Each Video Input after Selected, is Applied To A Video White Clipper Where Any Video Overdrive is Clipped Off, Reducing The Possibility Of Over Modulation An Automatic Pedestal Control Keeps The Proper Clipping Level At All Time. A Low Pass Filter IS Also Added To Remove Any High Frequency Noise On the Video Or Spurs Caused by The Clipping Action. One Item That Can Be Added At This Point is a Small Sync Stretcher PC Board That Mounts On The CU. From This Point A Low Impedance Line Driver Amplifies And Drives The Processed Video Down The Coax To The Transmitter. A Video Output Monitor Jack is Also Included To Monitor The Processed Video Before Or During Transmitting.

Both V.U. Meters And Led Clip Indicators And Monitor Outputs Jacks Is In Full Operation Before And During Transmission.

External Mic Audio Is Applied To An Automatic Gain Control Amp With An Input Level Control Added To Vary The Amount Of Audio Before Compression Starts. Aux Audio Is Applied To A Rear Panel RCA Connector With Its Own Level Control. A RCA Output Jack Is Also provided To Enable Monitoring The Audio AS Its Applied To The Audio Sub Carrier Gen.

A Crystal Controlled Sub Carrier Generator Is Also Provided Programed To 4.5 Mhz. Other Frequencies Can Be Programed By Changing PC Straps. Sub Carrier Injection Level Is Also Adjustable.

Power Requirements For The CU-125 And All Modules Is 12-14.5v D.C. Input. Complete Regulation And Filtering Makes This Unit Ideal For Base Or Mobile Operation Little Affected By Voltage Fluctuation.

CU 125 CONTROL UNIT \$229.00  
Box Size 2.52 x 8.10 x 6.12"

FM DEMOD BOARD  
\* SPECIALLY DEVELOPED NARROW BAND FM DEMOD MODULE WITH AN AGC IF, SHARP SLOPED SAW FILTER, AND A NEWLY DEVELOPED LOW THRESHOLD PHASE LOCK LOOP VIDEO DETECTOR

AM TRANSMITTERS  
70 CM -- T70A \$132.00  
33 CM -- T33A \$137.00  
23 CM -- T23A \$137.00

To add 2nd Frequency \$10.00  
If on carrier audio modulation is required \$10.00

FM TRANSMITTERS  
33 CM -- T33FM \$138.00  
23 CM -- T23FM \$138.00  
FM DEMOD BOARD \$169.00

(Installs in CU 125. Required to receive FM ATV)

REC CONVERTERS  
70 CM -- RVT-70 \$89.00  
33 CM -- RVT-33 \$103.00  
23 CM -- RVT-23 \$109.00  
FOR CRYSTAL CONTROL OPTION \$30.00  
To add 2nd Frequency \$10.00

SHIPPING & HANDLING  
Texas Residents add 7% sales tax

NEW!  
RCC-10 RECEIVE CONVERTER CONTROLLER 44.50

TD SYSTEMS  
6419 Rock Springs Drive  
Arlington, Texas 76017  
(817)483-4994





# ELKTRONICS

12536 T.R. 77  
Findlay, OH 45840  
(419) 422-8206

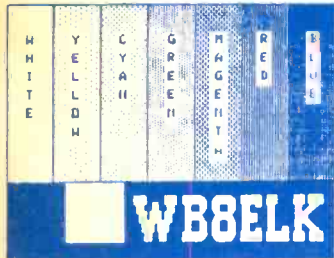

INTRODUCING THE  
**VDG-1**

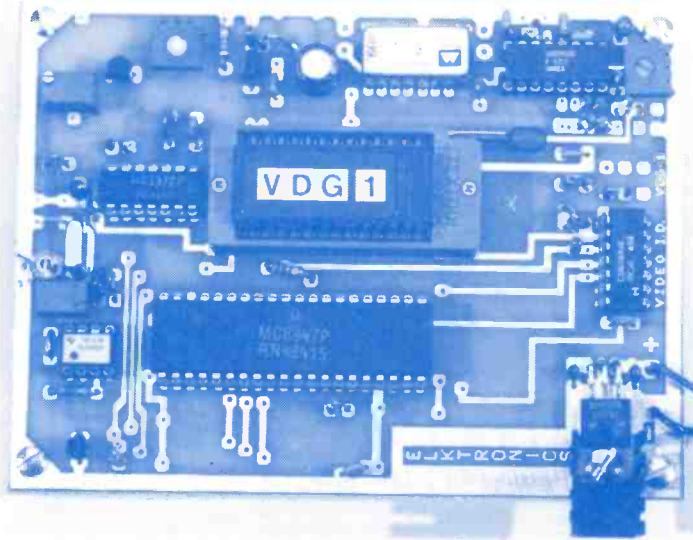

## KA0JAW

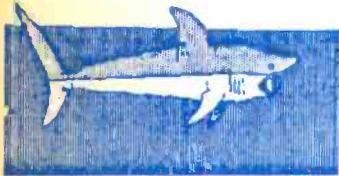

## KA8EEE

Jim  
Marion Ohio



## N9CAI / P



## KA8ZNY

GROVEPORT

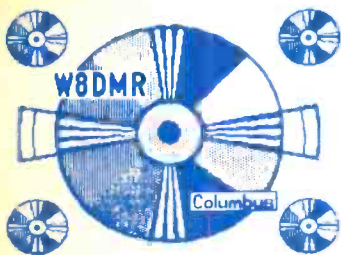

- Instant Video Source
- 4 Graphics Screens  
(2 Hi-RES / 2 Colorbar)
- 12 V D.C. Operation
- Video Relay for switching in live camera video
- Built-in Sequencer/Timer  
(Steps through all 4 screens)



VDG-1 with Pre-Programmed  
Custom Callsign Logo

- \$99 ppd.

(Quick-release socket option)

- \$10

**Call or Write for CATALOG  
of available Graphics**

Additional Programmed EPROMS

- \$19

Now available as a Kit

- \$89 ppd. Blank PCB - \$19

## KA8LWR



IN BUCYRUS, OHIO

## KA8WLW

WHERE NO ATVER  
HAS GONE BEFORE





# INTRODUCING **AEA**'S NEW ATV SYSTEM

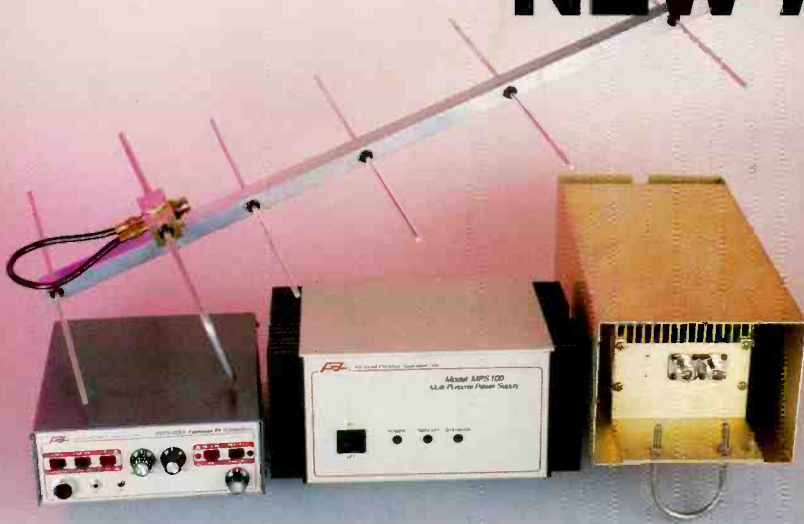

**A**dd a new dimension to your amateur radio communications with AEA's Amateur Television (ATV) system. If you hold at least a technician-class license, you can transmit and receive live or taped audio and video Fast-Scan TV (FSTV) information that rivals broadcast quality. Now you can share more than conversation over the air with this new mode of "personal communications."

## It's Easy and Inexpensive.

If you have a video camera or camcorder and a standard TV set, you may already own the most expensive components of an ATV system. AEA's ATV system includes a transceiver and antenna. Simply connect the camera, TV and the antenna to the transceiver, and you're on the air LIVE with one

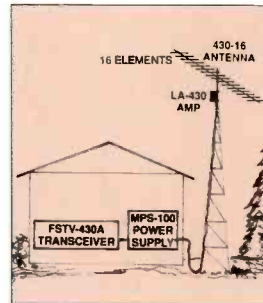

watt P.E.P.! Your TV set will monitor your transmitted and received pictures. If you want to broadcast with more power, AEA also offers a 50 watt mast-mounted linear amplifier with power supply.

**The FSTV-430A Transceiver** features a low-noise UHF GaAsFET preamp with a typical noise figure of less than 1.5dB and a crystal-controlled or variable tuning down converter. Output is available on channel 3 or 4 for signal reception AND monitoring transmissions. Two frequencies can be selected from the front panel for transmission (one crystal is included). The AEA design is also optimized for superior video and audio quality without sync buzz even with weak signals. The FSTV-430A is the only transceiver you need to work ATV and it also allows you to use the same TV set to monitor your transmitted and received pictures.

**The LA-430/50 Amplifier with Power Supply** gives a boost to your ATV signal. It includes a 50W P.E.P. mast-mounted Linear Amplifier (**patent pending**) covering 420 to 450 MHz and a GaAsFET preamp which utilize the antenna feedline for DC power. The mast-mount eliminates the line loss between the amplifier/preamplifier and the antenna to improve both transmission and reception, and is the equivalent of a 100W amplifier in the shack with a 3dB line loss. The amplifier is housed in a weather-resistant alodized aluminum case. The MPS-100 power supply also provides a 13.6 volt output for the FSTV-430A.

**The 430-16 Antenna** is a high-performance, computer-optimized yagi specifically designed for ATV operation. It features broadband frequency coverage from 420 to 440 MHz, 14.3dB gain, O-ring sealed connectors, 28 degree E plane and 32 degree H plane beam widths and 16 elements on a 10-foot boom.

**See AEA's FSTV System** at your local authorized AEA dealer. Put yourself in the ATV picture and join the fun!



## What is the advantage of Vestigial Sideband (VSB)?

AEA's FSTV-430A Vestigial Sideband operation drastically reduces adjacent-channel interference. VSB requires much less bandwidth than existing double-sideband designs; it's the standard method of modulation required by the FCC for all U.S. broadcast TV stations. Similar in principle to SSB, VSB puts all of the audio energy and most of the video in ONE sideband instead of two. Using about half the spectrum space of competitive units, the FSTV-430A is the ONLY ATV unit that conserves spectrum space by using VSB. Even with AEA's LA-430/50 amplifier, one sideband is reduced more than 30dB. VSB presents an obvious advantage to the bandwidth-conscious ATV operator.



## Advanced Electronic Applications, Inc.

2006-196th St. SW/P.O. Box 2160 Lynnwood, WA 98036 206-775-7373

Prices and specifications subject to change without notice or obligation.  
Dealer inquiries invited. Copyright 1989.

**AEA Brings You  
A Better Experience.**