



OFFICIAL JOURNAL OF:—  
THE AUSTRALIAN AERO CLUB.  
THE WIRELESS INSTITUTES OF AUSTRALIA AND NEW ZEALAND.  
THE MERCANTILE MARINE WAR SERVICE ASSOCIATION OF AUSTRALASIA.

Vol. II.—No. 22.

JANUARY, 1920.

Price, Ninepence.

## A PUBLIC APPEAL

Flimsy sheets of tissue paper, frail strips of matchwood, a gluepot, lengths of copper wire, some stout thread, and a heart infinitely stouter; with the aid of these were evolved a number of quaint-looking objects which earned for their inventor the good-humoured tolerance of his neighbours and the more or less public designation of harmless lunatic.

That was nearly forty years ago.

To-day, exhibited in a glass case on the top floor of the Technological Museum in Sydney, are seven of those quaint-looking objects, presented to the State by their inventor, the late Lawrence Hargrave. They are models of his box-kite. It is typical of the man that he did not call it "The HARGRAVE box-kite." Hargrave merely invented. The commercial exploitation of his work was left to others, and he lived to see it done.

Referring to old newspaper files one finds a dawning sense of Australia's debt to this great Australian in *The Sun* (Sydney) of May 11, 1911. The British and Colonial Aeroplane Co., Ltd., had sent out one of its demonstration machines, a *Bristol* box-kite, piloted by the late J. J.

Hammond. Hammond appears to have duly become "*The Sun's* Airman"—Sir Ross Smith at that period being a trifle too young to aspire to the distinction. "Mr. Hammond," the report reads, "went out to Woollahra Point to interview Mr. Hargrave on behalf of *The Sun*, and below will be found the story that resulted."

The "story" occupies two columns, and much of it is not material to the subject of the moment; certain portions, however, may well be quoted, particularly as their influence to-day will be greater than when they first appeared in print.

"The world of flying (wrote Hammond) is greatly indebted to Hargrave for what he has done in the science. . . I am convinced that Australia would have been first in the field with heavier-than-air machines if Hargrave had had his due . . . His box-kites—the same as were used in the South African War—were the germ of the principle of the modern flying machine, and the devices shown in his models have many improvements that must go into the aeroplane

as we know it now . . . Then there is the engine question; there can be no doubt that Hargrave was the father of the little *Gnome*. It was his idea before anybody else thought of it. He showed me a photograph of one of his engine models, taken years and years ago. 'That,' I said, 'is the *Gnome*'. 'Yes,' he replied quietly, 'it should have been the *Hargrave*.' And it should . . . In a kindly, smiling manner he remarked: 'You are only the jockey of the aeroplane, you know.' I admitted it. All of us who fly are only the jockeys. It is such men as Mr. Hargrave who have made our horses."

To another newspaper reporter, Hargrave once said: "I won't patent my inventions. Other men's ideas have helped me and I don't see why I should make money by applying my ideas to theirs. I work for the love of science and to help it on." "As a result (the report continues), Mr. Hargrave has to depend, in the absence of a subsidy which one would think any Government would gladly rush him with, upon his private means. He has to work out his ideas himself in brass and wood and iron and aluminium, and all that takes time. He has been experimenting now (1911) for over twenty years. Perhaps a man who worked for cash and had no objection to button-holing officials might have got the means to carry his work through sooner; but then he would have been a different kind of man. Hargrave works on steadily—inventing, experimenting, making slow but gradual progress."

An excellent pen-picture of the late inventor is contributed to this issue by Dr. Mary Booth, M.B., Ch.M., O.B.E., while other contributions from those who knew him more or less intimately will doubtless follow and be welcomed to these columns. Our immediate object is to secure world-wide publicity for the proposal to erect a suitable monument which will at once perpetuate the memory of the Australian scientist who discovered the principles of flight, and that of the first Australian airman to fly across the Planet, from England to Australia, in an aeroplane constructed on the basic principles of Hargrave's invention.

The project originated some months

ago during a conversation between Colonel Watt, O.B.E., and the present writer, (it was the Colonel's idea) and was publicly launched on January 7, by Major-General J. Gordon Legge, C.B., C.M.G., in the course of a lecture in Sydney, under the auspices of the New South Wales Section of The Australian Aero Club. In announcing the proposal, General Legge said: "I should like to recall to your mind the name of Lawrence Hargrave, really the first man to start the science of aeronautics on practical lines. Hargrave was the forerunner, and it is to his efforts that the flight from England to Australia has been made possible. The erection of an historical monument does not involve a tremendous amount of money, a thousand or two at the outside; it is intended as an expression of the feeling of the whole of the Nation, and a great many small subscriptions will be more acceptable than two or three large ones."

The Hargrave Memorial Fund is now open, and is administered on behalf of The Australian Aero Club (N.S.W. Section) by the President of the Section, Colonel Watt, and the Honorary Secretary, Mr. E. J. Hart, who have been appointed joint trustees. Donations will be acknowledged in *Sea, Land and Air* (the Club's official journal) in the issue immediately following receipt of same, the first list appearing in our February edition. Already several sums have come to hand, the list being headed by Colonel Watt, with a donation of fifty guineas, and the proprietors of this journal with five guineas.

The Premier of New South Wales, Hon. W. A. Holman, has agreed to dedicate a site for the monument in the Sydney Botanical Gardens or in the Domain, and it is suggested that the figure of the late inventor surmount the pillar, one side of the plinth to bear a carved replica of his original Hargrave box-kite, and the other a model of the Vickers-Rolls-Royce *Vimy* biplane which carried Sir Ross Smith and his party from England to Australia.

Cheques should be made payable to "The Lawrence Hargrave Memorial Fund," and addressed to The Trustees, 99 Clarence Street, Sydney.

## LAWRENCE HARGRAVE—Pioneer and Patriot

Especially Written for "Sea, Land and Air"

By Dr. MARY BOOTH, M.B., Ch.M., O.B.E.

(All Rights Reserved)

A few days and Sir Ross Smith will alight in Sydney from Europe by aeroplane! A unique interest attaches to the event in that he comes to the place which was the scene of the life and work of Lawrence Hargrave, the pioneer of Aviation. Hargrave laboured long and alone in Australia to discover the principles of aeronautics by which heavier-than-air machines could fly. His efforts and models were ridiculed during his life, yet within five years of his death his discoveries have been so successfully developed that a machine has actually flown 16,000 miles carrying four passengers.

Lawrence Hargrave was a son of the late Mr. Justice Hargrave, and came to Sydney when a boy. His youth was spent at their home at Rusheutters Bay, where his curious and daring inventions were the delight of his companions.

The judge used to tell a story of how one night he heard exciting sounds and laughter from the bottom of the garden bordering on Rusheutters Bay. "I went down to see what was afoot, and there I saw my noble son walking on the water." A party of friends was gathered on the shore cheering his efforts.

Hargrave was on the staff of the Sydney Observatory under the late Mr. H. C. Russell, and was one of a scientific exploring party to New Guinea which penetrated further inland than any other had previously done.

He retired after a few years on a moderate private income, and devoted himself to scientific experimental work. The results of his investigations were always given at

once to the world through the medium of the Royal Society, without reservations as to any possible subsequent financial benefits to himself.

His conception of the scientist as a servant in the cause of humanity, and his opinion of the state of aeronautical science in 1897 may be judged from the following extract from a paper given in that year, and published in the proceedings of the Royal Society, on "The Possibility of Soaring in Horizontal Wind." He read: "There is a publication called *The Aeronautical Annual*, edited by James Mears, of Boston. In No. 2 Mr. Chanute goes exhaustively into the question of sailing flight, and specifies every letter and article that bears on the subject. This paper may be said to take up the running where Mr. Chanute leaves off. My reasons for not writing to that periodical straight are that publication would be delayed for many months, and the state of the art is such that at any moment some one of the many who are investigating this subject may drop on the facts stated in this paper, take out a master patent which would rule the construction of all future flying machines, and tax us all round for our good, as the Protectionists say, thus throwing our work back for years. I, therefore, with your permission read this paper, and show the models that work as I describe, and thereby destroy the novelty of the invention for all time."

He concluded this paper with the statement: "A very few trials will convince the most sceptical that if we are not soaring in moderate breezes before the end of the century it will not be from ignorance of the way to do it."

In November, 1898, he speaks of advancing the Art of Soaring another step, and gives a *résumé* of those who have made soaring machines, and of their work.



MEDLOW BATH HYDRO,  
BLUE MOUNTAINS, N.S.W.

3 Jan 1920

Dear Dr. Booth

I am at present restricted - Dr. Ballmore has sent me here to rest some time after a rather severe time with my heart, & I must keep quiet, with my feet up whenever possible. You will understand I shall be very glad indeed if anything can be done to quell the public blunder of the value of Lawrence Hargrave's work when every dollar pinned or guffawed at the notion of men flying. Genius long before him had suffered the loss of the half-blind on the same here; & then again, when aviation is proved, the wiseaces curl their useless lips at the prospect of commercial aviation as a hare-burned project. Why, within three years we shall have aerial mail & passenger ships flying between Sydney and



MEDLOW BATH HYDRO,  
BLUE MOUNTAINS, N.S.W.

and sea Plymouth or harbours, with a post-junction station probably, at Cairns or Belchi

I wish I could take some active part in the ~~and~~ <sup>and</sup> ~~walking~~ <sup>walking</sup> of the public, but being sorrow it is forbidden me, at any rate just now. But Lawrence Hargrave is undeniably the man whose memory is to be honored, whatever the kind of memorial we should establish.

This is a silly superstition that the old judge originated the box-kite stuff. I knew both father & son very well. The former was very kind to me in my junior days at the Har. In the course of many conversations he never said a word to me on the subject of aviation or aerial mechanics. But while the old man was alive I went on Laurie's imitation to see the progress of the latter's experiments, & became convinced that he was working entirely "on his own". If the father had been concerned at all in the experiments - that is, as an originator - I am certain I should have heard something about it from my friends, the son. I should be glad to help you in any way short of coming to Sydney or speaking to you. Very truly  
Edmund Barton

The above letter to Dr. Booth from the late Sir Edmund Barton is believed to be the last written before his death. In it he pays eloquent tribute to the work of the late Mr. Lawrence Hargrave, and at the same time settles a point which threatened to become controversial.

He says: "In a matter concerning priority of discovery the credit must go to the man who first publishes his knowledge, and none at all to the one who knew and withheld his information with a view to exploiting humanity." A man of the strictest integrity, he could speak scornfully on rare occasions of anyone who infringed the scientist's code of honour, and "stole another man's ideas and sold them for his own." Concerning the neglect of himself, however, his philosophy of life only allowed him ten years after his epoch-making discovery given as above to the Royal Society in 1897, to observe in gentle irony when presenting to the Royal Society a paper on a One Wheel Car (1907): "It is the special privilege of members of this Society to have a journal as a sort of bank in which they can safely deposit ideas of a more or less bizarre nature, which, when presented, appear ridiculous, but when printed and circulated, have a way of being first looked into and examined by the most remote people, and their merit recognised and acted on. Then it may be after many years the invention, or an application of well-known laws is brought to its place of origin as a valuable foreign production. This, being the unalterable way in which humanity is built, must be accepted without demur."

He enjoyed, however, the recognition of distinguished contemporaries in other parts of the world. Sir Richard Threlfall, formerly Professor of Physics at the Sydney University, said: "Sydney will some day be noted not so much for its beautiful harbour, as for being the residence of the inventor of the flying machine, Lawrence

Hargrave." Sir Hiram Maxim always spoke of Hargrave as the discoverer of the principles that have made the aeroplane possible. One of the Wright brothers a few years ago, calling on Hargrave's daughter in Paris, said: "But for your father, we should not be flying now."

Hargrave was a man of simple tastes, retiring, of direct speech in a few well-chosen words, and an intense hater of shows and shams of every kind. It is proposed to erect a memorial in his honour. Let us be sure that it is something that will be in unison with the spirit of the man. A suggestion was recently made that the Government should convert the White City site into playing fields dedicated to the memory of Lawrence Hargrave, who lived most of his life in the neighbourhood. There would be room for boys to fly kites, to spin tops, to sail boats—how his spirit would be with these young experimenters in aeronautics!

Noble memorial gates, with reliefs showing the development of the art of aviation, and commemorating also Sir Ross Smith's great flight, would be worthy of these two Australians.

In erecting memorials, we Australians must remember that while we indulge in the expensive tastes and observances of older countries we have also our developmental works to carry out. Where we can combine use and beauty, let us do so.

One cannot think that the Knights of the Air would care to see their pioneer in statue only, but rather that his memorial should guard the entrance to an Earthly Paradise for the boys who, in a few short years, will become their successors in the air.



## WHEN THE "VIMY" CAME TO DARWIN

Epecially Written for "Sea, Land and Air" by ROY H. ALEXANDER.

(All Rights Reserved)

[Mr. Alexander's gift of observation is already familiar to readers of this journal in his contribution, "A War Prisoner's Diary." As his vessel, the *Changsha*, en route from Singapore, was due at Darwin simultaneously with the expected arrival of Sir Ross Smith and party, a telegram was despatched requesting that he bring back to Sydney an impressionist sketch of the historic landing. Some of the negatives which were intended to illustrate Mr. Alexander's notes have unfortunately gone astray in the post and will, if recovered, be reproduced in a subsequent issue. It is hoped also to publish the story of Captain Sir Ross Smith, who writes us from Brisbane deferring the matter until his arrival in Sydney.—Ed.]

On the now historic 10th of December, the steamer *Changsha*, pushing South with passengers and mails from China, was 24 hours off Darwin when we intercepted a message which H.M.A.S. *Sydney*, cruising in the vicinity, flashed through to that town: "Ross Smith's *Vimy* is in sight." The news thrilled Darwin and sent most of the inhabitants trekking out to Fannie Bay quite in the style of an old-time "gold-rush."

The aerodrome at Fannie Bay is a cleared tract lying some miles out of Darwin, and situated between the large Meat-Works and the Northern Territory Gaol; the raucous whistle of the former—a useful, if somewhat malodorous establishment—provided a noisy welcome from the time the big *Vimy* appeared above the skyline until she landed exactly in the middle of the large white circle marked out in the aerodrome.

On sighting the *Sydney*, the *Vimy* had paused in her Southward flight to drop a message of greeting on the cruiser's deck, but only an hour elapsed between the time the first wireless message was received at Darwin and when the machine landed at Fannie Bay; this fact speaks volumes for the enthusiasm and activity of the comparatively large crowd of Darwinites who had gathered to welcome the aviators.

One lady, wife of a certain Government official, had to be forcibly restrained by the Quarantine Doctor from boarding the 'plane before *pratique* had been granted. She led the van of enthusiasts who mobbed the machine, and in answer to the doctor's query as to whether she wished to run the risk of infection from any disease

which might have been contracted by the aviators during the journey, she replied: "I don't mind if I do, provided I'm the first woman to shake hands with Ross Smith!"

The local paper at Darwin boasts an advertisement which belongs to a newer era than any of the public notices in the big Southern dailies. This particular notice was to the effect that: *The Public are warned against boarding any aircraft from Asia until the machine has been passed by the Health and Customs authorities.*

During the days following the arrival of the *Vimy*, Darwin simmered with excitement; on the Thursday the *Changsha* added her quota of sightseers to the long, long trail which led to Fannie Bay; at 11 a.m. on Friday (the 12th) the town was startled out of its customary mid-morning placidity by the news that a second 'plane had been sighted bound for the aerodrome.

A rumour quickly spread that Poulet had at last arrived, but the adventurers proved to be Captain H. N. Wrigley, D.F.C., and Sergeant-Mechanic A. W. Murphy, D.F.C., in their *B.E.2E.*, who were completing the first transcontinental flight. The *B.E.* made a graceful landing alongside the Vickers machine.

At daylight on Saturday the *Montoro* arrived and a few hours later (at about 9.30 a.m.) the *Vimy* took off from the aerodrome. She described a huge circle round the town to vociferous cheering and whistling from the *Sydney*, *Changsha* and *Montoro* (to say nothing of the noise contributed by the Meat-Works), and finally vanished into the hinterland which lies across the bay from the picturesque green bluff whereon are clustered the galvanised-iron roofs of Darwin.



The Vickers-Vimy at Darwin, December 10, 1919.



Captain Sir Ross Smith, Lieutenant Sir Keith Smith, with Captain P. Roach Pierson (representing the Australian Aero Club) at Charleville.



Landing at Charleville.



Immediately After Reaching Charleville.



**The Late Captain Cedric Ernest Howell, D.S.O., M.C., D.F.C.**

Pilot of the Martinsyde A-1 biplane, wrecked off the Island of Corfu on December 10, 1919, while flying from England to Australia. By a sad coincidence it was on this date that Captain Sir Ross Smith arrived at Darwin. Captain Howell's aeronautical career, and that of his mechanic, were detailed in the last issue of this journal.





**Captain Howell's Mechanic.**

**The late Air-Mechanic George Henry Fraser.**

## IMPERIAL GIFT AEROPLANES

NINETY-FIVE READY FOR SHIPMENT TO MELBOURNE.

An Interview with Lt.-Colonel R. Williams, D.S.O.

Several months ago it was announced that the Department of Defence had definitely accepted the Imperial Air Ministry's offer of 100 gift aeroplanes, and that these would be despatched to Australia as soon as circumstances permitted.

Colonel R. Williams who commanded No. 1 Squadron of the Australian Flying Corps, and later acted as Liaison Officer in Great Britain, has recently returned to Australia, and during an interview which he granted to *Sea, Land and Air*, made available the following information regarding the selection of our new aerial fleet.

The Air Ministry, said Colonel Williams, had consented to present one hundred aeroplanes, together with twenty-five per cent. spare engines, the usual squadron field-transport (motor-tenders, cycles, sidecars, lorries), motor-workshops, tools, gunnery, photographic and W/T equipment of the latest type, with spares for the above, calculated on a basis of six months' war service which, in times of peace, is estimated to cover a period of twelve months.

In addition, the Air Ministry has promised a sufficient number of Bessoneau hangars for the housing (in the field) of three complete squadrons. The number of aeroplanes allotted to a flying squadron varies according to type of machine, the rule being: large machines, 10; medium, 18; small, 24.

The aeroplanes selected by Colonel Williams are of the following types:—

Thirty *S.E.-5a*.—Fitted with 180 h.p. Hispano-Suiza *Viper* engine (8-cyl. stationary).

Thirty-five *D.H.-9a*.—Fitted with 400 h.p. *Liberty* engine (12-cyl. stationary).

Thirty *Avro*.—Fitted with 130 h.p. *Clerget* engine (9-cyl. rotary).

The latest advice from England is that the machines are now ready for shipment to Melbourne, the work of packing being undertaken by the Royal Air Force, under the supervision of three officers of the Australian Flying Corps who remained in England for that purpose, *viz.*, Captain W. A. Coates, M.C., Lieutenant A. C. Mackinoly and Lieutenant A. A. Poole. Of these officers one is stationed at an R.A.F. *dépôt* which deals only with fabric parts, a second is responsible for the engines, while a third superintends the packing of spares and general stores.

Shipment is being arranged for by the High Commissioner in London, Hon. Andrew Fisher, and it is expected that the complete machines will be ready for assembly at the Central Flying School, Point Cook (Victoria), not later than the end of March. Immediately upon the formation of the long-promised Commonwealth Air Force the Imperial gift aeroplanes will be allotted to our first three training squadrons.

Colonel Williams, of whom much has been printed in this journal during the past two years, was Sir Ross Smith's commanding officer, and may be relied on to have selected the most suitable types of machine for the serious business in hand.

# THE AIR DEFENCE OF AUSTRALIA\*

By Major-General J. GORDON LEGGE, C.B., C.M.G.

Chief of Commonwealth General Staff.

General Foch has told the world how little we can rely on Peace until years and the gradual strengthening of the League of Nations alter the *morale* of the world's peoples, and not till *all* the powerful nations agree to disarmament, and with hesitating steps gradually achieve it, will the reign of Peace arrive. It is not in sight for many years to come, unless a miracle happens, and there may be great wars again and sooner than we expect.

People here in Australia who have not served abroad scarcely realise what war means, and even those who served have but little practical experience of the new powers of the air. In Australia Air Defence has not even been commenced, and it is none too soon for all who realise its importance to shout and go on shouting—

## “Wake up Australia!”

While you sleep others are preparing. Unless men think and discuss this subject, what inducement is there for any Government to take it up with all its difficulties? And the Government has a right to expect those who vote to make up their mind on the subject, and that soon.

Your neighbours, even those who took no part in the Great War, are making solid preparations. Siam even has an air force. China has lately made a contract with Vickers Limited, for £1,800,000, to construct aerodromes and provide 'planes and equipment. Japan has 600 military 'planes, and an arsenal which can build more. Holland and Portugal each has an air force. France and the United States of America are retaining very large numbers of airmen and 'planes from their war equipment. All these are our neighbours now, and as near to Darwin as Darwin to Melbourne. Truly,

the British race have only themselves to blame if they meet trouble.

An important aeronautical journal recently expressed astonishment at the way England “was losing ground in aeronautics, and apparently without a struggle, giving up the leading position it won in the war . . .” and said, “a situation full of dangerous possibilities is developing, and in the course of five or six years this country, if it permits its aircraft productive capacity and its expert personnel to be dissipated, will be compelled by panic measures, at vast cost, to try to win back what it could now quite easily conserve without much labour or expense. Germany is permitted to develop commercial flying without restriction. There is abundant evidence that she is doing it. In Middle and Eastern Europe there are possibilities of coalitions that might in the light of air power gravely menace Great Britain. A sudden unannounced blow might at least paralyse our nerve and action. Sea power in that event would not count.”

We, too, in Australia, run a similar but greater risk from other directions, and we have not even attempted any preparation.

There are many vital questions that may easily become causes of war around the coasts of the Pacific. Australia boldly proclaims its determination to remain White, but takes far less interest in preparing how to avoid a change of colour than it does over the Six O'Clock Closing Law, legalising the totalisator, and price-fixing.

Let me read to you two messages which I hope will bring home to you

## What May Happen to Australia.

Telegram received at Melbourne, 15th December, 192—, 7 a.m.—

“Darwin. Several hundred large 'planes landing at aerodromes. Firing beginning direction wireless at.....”

Message breaks off and no further communication with Darwin can be had. The

\* A lecture delivered before the South Australian Section of the Australian Aero Club, at Adelaide, on December 18, 1919.

state of the public mind may be guessed, especially when the following day the Premier of Queensland telegraphs at noon—

"Townsville and Rockhampton are reported destroyed by incendiary bombs, many inhabitants killed by poison gas, enemy messages dropped state all cities will hoist white signal of surrender to-morrow and hand over all coin and bullion to advanced parties, otherwise will be destroyed, great panic. What shall we do?—"

If you were the Prime Minister of Australia, what would you do?

A country is defended by—

Naval Power;  
Military Power;  
Air Power;

with behind these as a Reserve—

Man Power;  
Producing Power.

These are utilised in various degrees and methods, according to the nature of the problem. So far Australia has spent most on naval power, less on military power, and nothing on air or reserve powers.

The United Kingdom expended prior to the Great War the following sums annually—

Navy £48,000,000;  
Army (excluding India) £28,000,000;  
Air Force £300,000.

Australia, in proportion to her population, should have expended—

Navy £5,000,000;  
Army £3,000,000;  
Air £30,000.

Actually the amounts spent were—

Navy £1,378,000;  
Army £2,425,000;  
Air £5,700;

although the smaller population of Australia owns and has to guard a disproportionately larger area. For the present year the amount provided for the Navy is £9,000,000, of which, though it is a permanent service, £7,000,000 is found from War Loan; the Military Forces are given £1,000,000, exclusive of expenditure on the Australian Imperial Force, and the Air Service only £80,000.

The amount required to maintain an Air Force one-tenth the size of Great Britain's Force would be £1,500,000.

I have no blame for those who push strongly the claims of their own service; it is right that the people should hear the arguments in favour of their demands. But when the advocates of the three services have been heard, their relative importance should be judicially balanced and a due allotment made to each, so far as public means will permit. Lord Weir, a member of the British Government, stated on July 24, 1919, that "whatever sum might be apportioned for the defence of the Empire, it would be allocated between Air, Sea, and Land power, and it was clear that air power was the developing factor of the three"

Let us then examine the nature of the problem and the means to be used for defence.

In the first place I wish to point out the dissimilarity of England's case to ours.

Great Britain is an island like Australia, "guarded" by the sea, which at the same time provides a means of approach to an enemy from any direction. Great Britain does not grow enough food for her people, or produce enough raw material for her factories; she must, therefore, import or die, and so must guard her vulnerable sea routes. Australia produces more food than enough, more raw material than enough, not sufficient manufactures for comfort, but enough for necessity in time of war. She is not forced to import or die, and her export, if stopped, would cause loss, but not defeat. There is not the same necessity to guard sea routes, and the nations of the world who needed our raw materials would probably send for them. I do not say it is unnecessary to have a navy to guard sea routes, but simply point out that it is not vital, and this point needs to be borne in mind when the relative necessity of naval, military and air expenditure is assessed.

I know it is often boasted that the Navy won the war, but if the Armies had not kept the Germans back from the Channel the Navy would soon have been without a base. The Navy and the Merchant Service did a great service, but the war was won by the Allied Peoples, their armies, their air forces and their sea services, in indivisible shares.

Having, therefore, noted some of the different characters of the problem involved in the defence of Australia, let us turn to the means.

During the four years of war the great fleets of England and Germany faced one another in battle, but seldom; being for the most part immured in harbour behind booms and mine-fields. They were not afraid, but their commanders would not risk them among possible mine-fields and certainty to attacks by submarines. For practical purposes of what value were these big ships?

The light cruisers, destroyers and small craft did gallant work, but did not succeed in preventing the loss of over-sea ships nearly reaching the starvation limit.

Depth charges were useful, but not enough. The real check came through aircraft working with the sea service. So we must have air command.

Battleships can only be protected from submarines by aircraft. What is the good of a fleet to us if it is going to be locked up in another Scapa Flow?

Hostile fleets we must keep off with submarines, and to prevent the enemy checking them by air 'planes, we must have more or better 'planes, and so attain air mastery.

Light cruisers, submarines, destroyers, and aircraft, for protection to the Navy, we must have.

Failing to harm us by sea, an attack might be made by air, limited, perhaps, to destructive bombing and poisoning, but possibly culminating in the movement of troops by air. There is only one answer—we must again have command of the air, and be able to drive our hostile fliers off or destroy them. And for protection of fixed and vulnerable localities, like cities and forts, we must have anti-aircraft artillery.

Lastly, an invasion by air or sea is always possible, whatever our sea or air force, by an evasion of such force. Here we should reach the land battle, in which Australia's troops might easily be less numerous than the enemy, and therefore needing with greater urgency the help of their own airmen and destruction of the enemy 'planes.

Whichever way we look, we cannot but see in the future the air service taking a large and important, and sometimes, a decisive part in the battles of sea and land.

You, gentlemen, who well represent the people of Australia, must make up your minds whether the air above Australia shall be Australian air or somebody else's air. Australia must

### Fly or Die.

unless she is willing to change her colour from White to Yellow, Brown or Black.

I have, on a previous occasion, \* outlined the character of the Air Force which is necessary for Australia, as 16 squadrons of fighting and scouting 'planes; 2 squadrons of flying boats (each squadron of 25 machines); and in addition a reserve of 200 large passenger-carrying 'planes, normally in commercial use, and an arsenal or factory, either Government-owned or private, capable of manufacturing engines and metal parts of 'planes. Certain aerodromes, hangars and workshops are of course necessary.

The cost would be about £1,500,000 on capital expenditure, and £1,000,000 per annum for maintenance of the force. With economy this can be made to meet the case, but anything less will be insufficient. And here let me remind you that what I advocate costs less than a single battle-cruiser.

I have also explained publicly that such an air force is by no means an unremunerative investment. The fighting squadrons would be partly Permanent, partly Militia personnel, and the Permanent men would supply instructors for the School, practically an Aviation University for Australia. They would form outposts at various places, such as Perth and Darwin, and assist the supervision of the Customs Authorities over 'planes arriving from abroad. The mapping of the coasts and their shoals, and of the great blank spaces in the interior, the carriage of Government officials and explorers, mails to the unvisited homes of our people in the Never Never, the pursuit of criminals who travel by air, all these and many other important duties can be performed by the Permanent units.

\* *Sea, Land and Air*, November, 1919.

As regards the 200 passenger-carrying 'planes, these should be machines in constant use for commercial purposes, thus saving the Government the cost of maintaining such a class of transport. There is ample scope for their full employment in Australia, but, especially at the beginning, they would need subsidies, either in the form of mail contracts or of cash payments. It would pay the Government to grant £1,000 per annum for each 'plane having a useful load of 7,000 lbs. With these machines we can reduce the time between Perth and the Eastern States by three to four days, a saving of a week in receiving a reply letter from London.

With this in view, and with the small means at our disposal, my Department is now endeavouring to produce air route maps between the State Capitals.

Lastly we come to the Arsenal, by which I mean the various factories capable of turning out the engines and other special parts which cannot be made in the Air Force work-shops. The importance of an arsenal for war is little realised. It is the great reserve of material. The equipment maintained by any nation in Peace is seldom more than enough to keep the field for more than three months. If we cannot make our aircraft in Australia we may as well drop all pretence of air defence, for the arsenal would in war be required to work in three shifts and expand enormously.

You will, therefore, understand why I appeal to you gentlemen, representatives of the thinking people of Australia, and especially to all the old members of the Flying Service, to work out these problems, to make others think on them, and then to let your minds be known. **I commend to your notice the monthly publication known as "Sea, Land and Air," published in Sydney, which is doing great work for the Air Service, and which deserves to be read even more generally.**

I ask you all to lend a hand in getting us the means to defend our airways, and always to bear in mind that while it will be a good thing to be able to defend Australia, it will be much better to attack our assailants, and to carry war and destruction into their country. You have the men who can and will do it if you will give them the means.

If the Air Service were to cost ten times as much, you must have it.

Let me, therefore, close by recapitulating the main points—

Australia is 2000 miles from East to West.

Australia, in time of need, will get no help from outside in less than six months.

Australia is not 1500 miles distant from *five* foreign nations, and a 'plane can fly this distance without stopping.

Australia's cities and harbours invite air attack.

The Navy needs an air service.

The Army needs an air service.

To own our own air we must have an air service.

To-day we have *No Air Service!*

[On January 7 General Legge delivered a lecture in Sydney on "Commercial Aviation in Australia." This will be printed in our next issue.—Ed.]

### REFRESHER COURSES FOR QUALIFIED PILOTS OF A.F.C. AND R.A.F.

The following announcement for the information of returned pilots of the Australian Flying Corps and Royal Air Force has been issued by Major-General J. G. Legge, and forwarded to The Australian Aero Club by Mr. T. Trumble, Secretary to the Department of Defence:—

1. Since the armistice very few flying officers have had any practice as pilots, and approval has now been given in special cases for officers formerly of the Australian Flying Corps and Royal Air Force to undergo Refresher Courses under certain conditions.

2. Those officers who are employed, or are about to be employed, in commercial aeroplane enterprises, and produce evidence to that effect, may, on application to the Secretary for Defence, through District Commandants, be accepted for short refresher courses in dual control machines at the Central Flying School.

3. Those so accepted will be required to report, at their own expense, to the C.F.S., where they will be accommodated in the Officers' Mess at ordinary mess rates. No pay or allowance will be granted.

4. The course will vary according to requirements, but will, as a rule, consist of a few hours' flying in dual control machines, or such other instruction as is considered necessary.

5. Commandants will receive applications and cause inquiries to be made regarding the same before forwarding them to Melbourne. Only qualified pilots of the A.F.C. or R.A.F. are eligible for this course, and they must produce the necessary documents showing that they are qualified pilots. The course is not for pupils or Air Cadets, or those who have qualified for brevet or Aero Club certificates only. The object is to assist qualified pilots taking up commercial flying as an enterprise, and to afford them opportunities to regain their old efficiency without risk to the public.

## DEVELOPING AMERICAN AERONAUTICS

Especially Written for "Sea, Land and Air" by **FAY L. FAUROTE.\***

(All Rights Reserved)

The Australian will appreciate more keenly than the European what the last half year has meant in American aeronautics. Although the war is over, Europe is still busy with armaments of which flying equipment is in every case an important element. With the United States, as with Australia, the end of the war has meant a sharp reduction of Army and Navy, and the demands of the Aviation Sections on American aeronautical producers have been modest indeed. What it means, then, to say that American aviation has not slumped but boomed, may well be imagined. It means

the entire flying industry. There is not time at the writer's disposal for the preparation of such an article. At the same time, his close experience with the Curtiss Aeroplane and Motor Corporation has given him facts with regard to that organisation which amply warrant a separate account, touching, as they do, the trans-atlantic flight of the Navy-Curtiss machines, the development of two distinct types of commercial machines, and the appearance of two important engines, as well as the re-purchase and disposal of 2,500 Curtiss *JN-4*'s from the American Government.

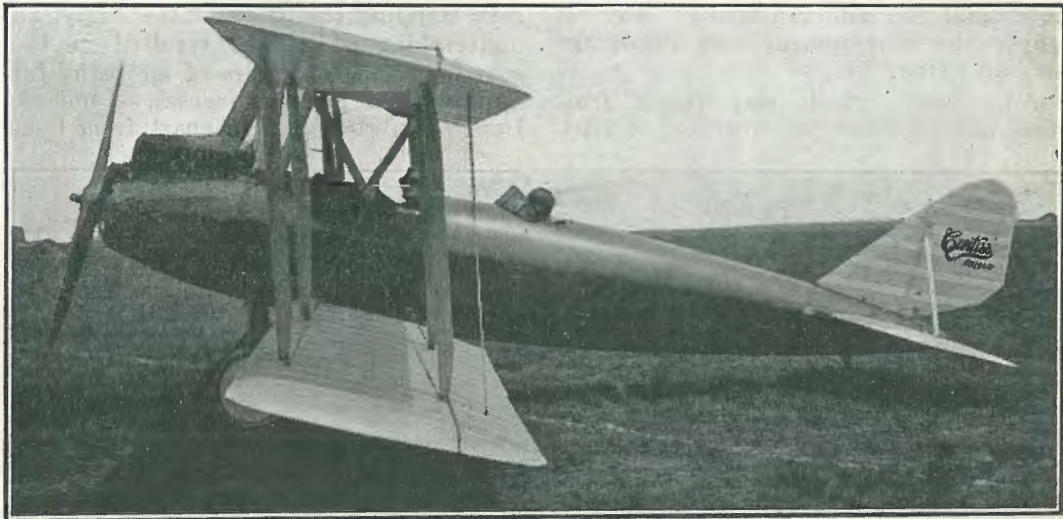

The Curtiss Three-Passenger "Oriole."

that there has been a bitter struggle for the manufacturer, and his only way out has been through commercial aviation. Fortunately he has followed this way successfully, and the future of flying in America now holds remarkable promise.

The following article is not an account of what has taken place with regard to

At the outset the statement that the American Government has given American Aeronautical producers but few orders needs amplification. It is a statement entirely true. The American Army has been reduced to 300,000 men, and the American Navy has also suffered reduction. While the requests of the combined Army and Navy Departments for aviation totalled \$3,151,000,000, they have been reduced to a total of less than

\* Manager Department of Education, Curtiss Aeroplane and Motor Corporation, New York.

a hundred million. The Post Office, which operates the aerial mail service, secured but \$800,000 for this activity, despite the fact that, if no military encouragement is to be forthcoming, the extension of air mail lines offers a desir-

buted to the War and Navy Departments. These, and especially the aviation personnel, have been active in the interests of Flying. The Departments, indeed, have shown their enterprise in the *NC* flight of the Navy, and in the great aerial



The Curtiss "Seagull."

able (and the sole remaining) way in which the Government can encourage civilian flying.

Any blame which may result from these actions must not, however, be attri-

road-mapping campaign of the Army, an undertaking which has resulted in the routeing of 50,000 miles of air paths for military and postal purposes. Indeed, Departmental action, as apart from Con-



The Curtiss "JN-4-D" Ready for Flight.



gressional action, has greatly helped aviation. And if the Government is "appropriation"-ally idle, its Department of Military Aeronautics has been busy for the last few months appointing official landing-field cities, and encouraging the establishment of fields by municipalities.

Fortunately, the war thoroughly aroused a public interest in Flying, and the middle of November, 1918, found the

*Wasp*, and recently credited with what promises to be accepted as a new world's altitude record of 30,700 feet. Nevertheless, Mr. Curtiss immediately gave consideration to the commercial problem, and interesting results have followed.

Of the numerous commercial possibilities three were selected for emphasis. They may be termed Sporting, Passenger

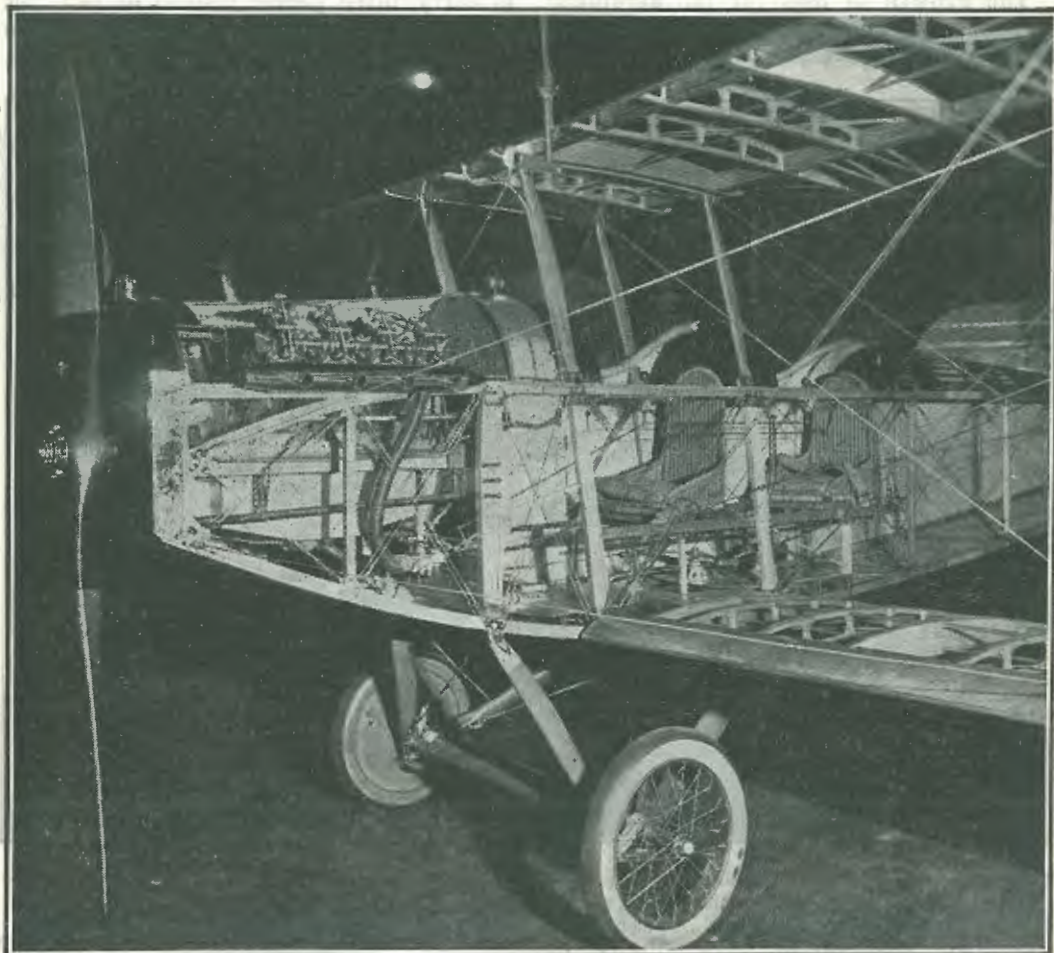

The Curtiss "JN-4," fitted with OX-5 engine, stripped for exhibition.

Press busy discussing the possibilities of commercial aviation. It became apparent that new types of aeroplanes were necessary for some phases of this new aerial activity. The Curtiss Aeroplane and Motor Corporation was at that time busy building the *NC-3* and *NC-4*, and was also occupied with the new 163 m.p.h. triplane now known as the Curtiss

Carrying, and Express and Taxi uses. These do not cover all the uses to which Curtiss aeroplanes have recently been put in the United States, but they help to group these uses.

Two new aeroplanes have been designed for these commercial purposes. They are the Curtiss *Oriole* and the Curtiss *Seagull*. A third is under way for

passenger carrying on a larger scale, and will doubtless be christened by the time this article appears in print. In addition, several war-time 'planes have been extensively employed. The *JN-4*, used as a training 'plane in the United States, Canada, and Great Britain, has had remarkable popularity, and the flying boat *HS-s-L* has been adapted to passenger-carrying.

The growth of uses for the aeroplane in peace has been even more rapid than their growth in war, where, used at first

as for exhibition work, aerial mail, flying schools, and pleasure flying.

The *JN-4* has been found reliable for most of these uses. It has moderate speed, singular reliability, great power of endurance, and a convenient system of dual control. Its petrol consumption per hour is low.

At the same time, there has been a call for a speedier over-the-land machine, able to carry three people instead of two, yet possessing the sturdiness of the *JN-4*. The Curtiss *Oriole* has met this demand. With

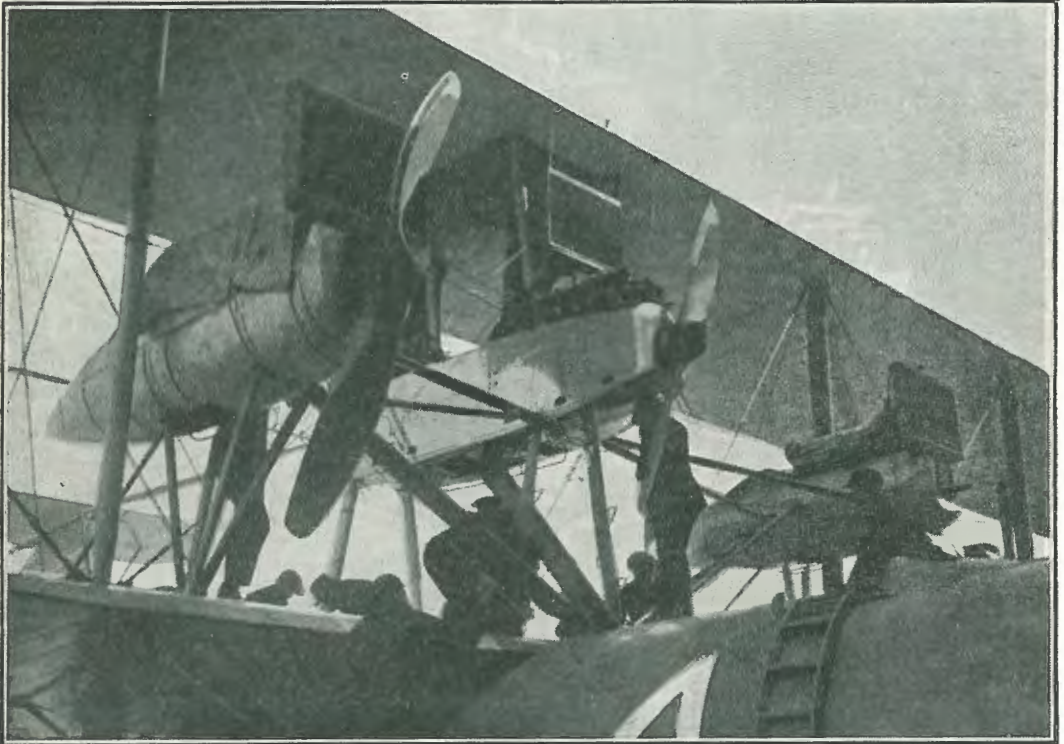

The NC-4 (Navy Curtiss) Flying Boat in which the Transatlantic Flight was made. Our illustration shows the upper part of hull, wings and motor fuselages.

only for observation, they finally included photography, bombing of several kinds, propaganda, liaison, and actual fighting in the list of their services. During the present year American aeroplanes have been extensively employed in film and photographic work, in advertising (by the distribution of announcements and in other ways), in carrying doctors to patients and patients to hospitals, dry goods and groceries, in shipping the first copies of books promised on a certain date, in carrying newspapers, as well

the new Curtiss *K-6* motor it carries three passengers (including pilot) at a speed of 96 m.p.h., while its petrol consumption is slightly over thirteen gallons per hour. Its name is taken from its orange-and-black markings. It has a door opening into the front cockpit, and protects the passengers entirely from wind and so much from noise that conversation can be conveniently carried on by the occupants. The seats are upholstered, and the passengers have an instrument board which keeps them informed

as to time, altitude, and speed. The success of the *Oriole* has been largely due to the careful stream-lining of the fuselage, the reduction in the number of exposed wires, and the use of ply wood construction for the body of the 'plane. Like all Curtiss models, the *Oriole* has been tested in miniature in the Curtiss Wind Tunnel, believed to be the largest and most efficient in the world. This tunnel has been finished during the last year, and has so far a record of 100 per cent. efficiency with regard to the performance of 'planes built in accordance with data obtained from tests made in it.

With a Curtiss *K-6* motor it achieves a speed of over 75 miles per hour, and has been used for taxi and passenger service between New York and Atlantic City, for photographic work over New York City, and for pleasure flying over Atlantic City. It is expected to invade the higher Hudson River, Lake Champlain, the Great Lakes, and the Mississippi. In California it already serves as the flying ferry for passenger flights between San Diego and Catalina Island.

It will be appropriate here to say a word about motors.



Pilot Roland Rohlfs and the specially constructed Curtiss "Wasp" triplane, in which he achieved the altitude record of 30,100ft. at Roosevelt Flying Field, Long Island, New York, on July 30, 1919.

The United States has thousands of miles of coast line and numerous waterways cutting its inland territories. From the first, therefore, over-the-water flying has had encouragement. And while the Curtiss organisation was finishing the *NC-3* and *NC-4*, it was planning a flying boat which would meet the small unit demand that arose, apart from the interest taken in the mammoth seaplanes.

The Curtiss *Seagull* was the result. It is built either in two-passenger or three-passenger sizes, and may be said to parallel the work done by the *JN* and *Oriole* over land.

The Curtiss factories have been developing three types. The 90 and 100 h.p. *OX* motors have been used in *JN*'s, *Orioles*, and *Seagulls* in cases where moderate speeds, and low petrol consumption were particularly sought for. The *K-6* has been the standard motor unit for the same 'planes where a speed of 75 miles over water and 95 miles over land was desired. The *K-12* has been used in speed machines such as the *Wasp*, and will doubtless be a motor for large seaplanes and freight aeroplanes.

The *K-6* and *K-12* are new motors, put into use only since the autumn of 1918.

They are six and twelve-cylinder types respectively, and have been characterised by remarkable lightness, compactness, fuel economy, and freedom from vibration. Experience to date indicates that they will also hold up under wear with surprising success. A 162-hour run on a *K-6* motor left the motor in excellent condition, scarcely .005 in. wear being shown on moving parts. Government tests on the *K-12* led to improvements in the water-cooling systems and the motor which a few months ago was labelled "experimental" has just

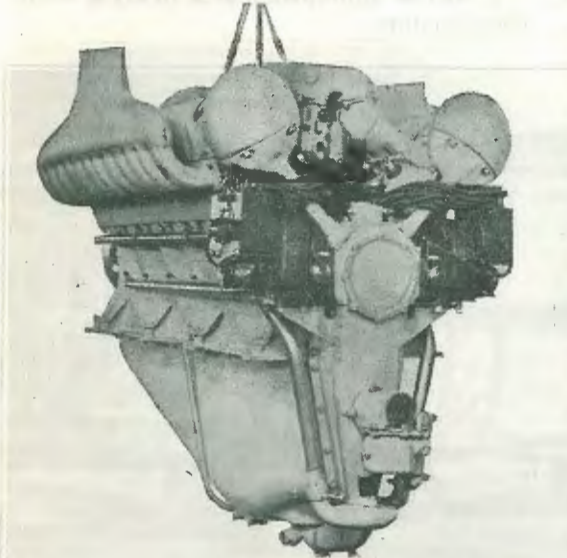

The Curtiss *K-12* aero engine with which the altitude record was attained.

carried the *Wasp* to an altitude of 30,700 feet, an American Official Altitude Record, and possibly a world record. This severe test indicates the high quality of the *K-12*.

Both motors are shaped for stream-lining in the fuselage. The *Six* is vertical, and of course offers an excellent shape. The *Twelve* is a "Vee" type, but the crankshaft is geared to a propeller shaft which is then raised above the former, and not only gives a powerful, even delivery by reducing the\* r.p.m. from 2,250 to 1,400, but also centres the propeller in the nose of the fuselage, and makes stream-lining easier.

A great deal of time has been spent here on civil flying 'planes and motors, with the idea that they will be of greatest interest to Australian readers. A word must be said, however, of other Curtiss 'planes.

\* Revolutions per minute.

The Navy-Curtiss boats were produced during the past winter. They were built at the Curtiss Engineering Company's factory at Garden City, Long Island, N.Y. Here also *H-16*'s and *HS-2-K*'s have been built—flying boats both, the one of a 96-foot wing spread, and two 400 h.p. motors, the other of a 74-foot spread, and a single 400 h.p. motors. Two speed machines, one of which has been mentioned, have also been built. These were designed as land 'planes for the Navy service, and are two-seaters, motored with *K-12*'s. The

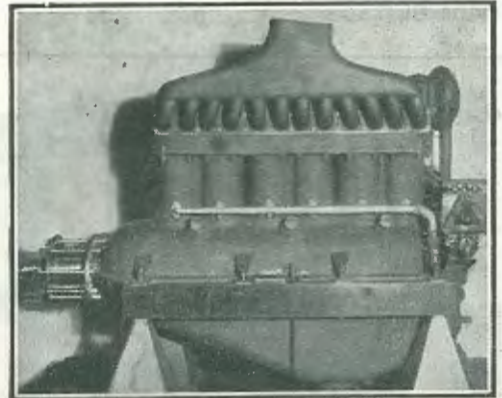

The new Curtiss-Six, 150 h.p. aero engine.

*Wasp* is a triplane, the *Hornet* an airplane. Both climb with astonishing speed—16,000 feet in ten minutes—and both manœuvre easily. The Navy and Signal Corps are at present using them. The *Wasp* which reached 30,700 feet under Roland Rohlfs hand was a specially constructed single-seater. In both machines all controls are operated without external control wires, and the fuselages, wires, struts, etc., are studies in effective stream-lining.

The commercial phase of aviation has never held out a larger promise. Special calls for machines for taxi and express services have been frequent. A large demand for 'planes for pleasure uses, for exhibitions, for flying schools, and for passenger service has resulted in the resumption of work by the Curtiss plant in Buffalo on a production scale. New routes have been opened, and public demand for the aeroplane is so insistent that new commercial designs are in preparation to meet the more varied requirements of the new trade.

## ALUMINIUM IN AIRCRAFT CONSTRUCTION

### THE NEW ALLOYS WHICH HAVE MADE ALL-METAL CONSTRUCTION POSSIBLE.

Especially Written for "Sea, Land and Air" by CLIFFORD W. NASH.

(All Rights Reserved)

The developments in aeronautics have been so rapid, owing to the impetus given by war conditions, that the public mind has become accustomed to taking every improvement in aeroplane performance as a matter of course, without inquiry as to the means by which the end is achieved. Now, however, that the war has been won, largely owing to the superiority of the Allies in the air, one may with advantage pause to consider the revolution which has been brought about in airship and aeroplane construction, and attempt to visualise the directions along which future progress will lie.

Of the numerous factors which have played their part in this revolution and made possible the aeroplane of to-day, it is proposed here to deal with but one, namely, the application of aluminium and its light alloys to aeroplane construction. That aluminium, on account of its lightness, has for long been employed in certain parts of the aeroplane is, of course, common knowledge, but the fact that during recent years a whole new series of aluminium alloys, possessing a hitherto undreamed of combination of properties, has been discovered, is not as widely appreciated as it deserves. The discovery of a new alloy almost ranks in importance with the discovery of a new metal, and the production of these alloys is perhaps the greatest metallurgical triumph of recent years.

Until late in the war period the vital members of aircraft structures, with few exceptions, were made of wood. Wood is always an unsatisfactory material from the engineer's point of view. It is uneven in quality and uncertain in strength; it warps and cracks, and deteriorates rapidly in tropical climates. Metal, on the other hand, can be made of perfectly uniform quality; its strength can be determined to a nicety, and can be relied

upon in practice. It is unaffected by climatic conditions, can be produced in enormous quantities, is not inflammable, and has the great advantage that it does not splinter when broken.

It might at first be argued that metal is too heavy for aircraft purposes. The same argument was used against iron ships, but it will be shown later that certain of the aluminium alloys are actually lighter, strength for strength, than the best timber. At the time of the Armistice over 1000 all-metal machines were in use by the Allies. In the words of Dr. Thurston, lecturing recently before the Aeronautical Society: "Had the war extended into this year, a prodigious number of machines made of steel and aluminium alloy, exquisitely designed for their functions, would have been produced, to swamp the enemy beyond all hope."

The earliest employment of aluminium and its alloys in aircraft work was in the form of sheets and castings for the minor fittings, and later for certain important parts of the engine. Its use for the structural members, such as spars and struts, is the latest development of all, and has been entirely dependent upon the introduction of these remarkable new alloys whose combination of lightness, strength and ductility is unrivalled by any other metal or material whatsoever, and marks them out as the ideal material for the construction of aircraft.

One of the most important of the properties of aluminium is, of course, its lightness. An aluminium rod, for instance, is only one-third the weight of a similar sized rod of steel. In other words, while a cubic foot of steel weighs 490 lbs., a cubic foot of aluminium weighs only 160 lbs. But lightness of itself is of little value, and for that reason pure aluminium is seldom used for aircraft purposes. What is required is a combination of great strength and lightness. This

has been attained to an astonishing degree by alloying the aluminium with certain other metals, and thus producing a material with all the lightness of aluminium and much of the strength of steel. Even before the war these alloys had actually replaced iron and steel for some of the most critical parts of the aeroplane engine, but it required the imperative demands of war to push the development to its logical conclusion. Failing radical improvements in other directions the maximum of speed and climb, so necessary for the fighting machines, could only be obtained by a reduction in the weight carried per horse-power. The greatest possibility of improvement lay in the engines themselves. Aluminium alloys were introduced for the cylinders, pistons, bearings and indeed wherever possible, until finally, as in the case of the Liberty engine, substantially one-third of the whole weight of the engine was of aluminium. At the beginning of the war aeroplane loadings were about 23 lbs. per horse-power; at the close, 10 lbs. per horse-power. The engine weight per horse-power has decreased to one-third of what it was before the war, and it is not too much to hope that before long the all-aluminium engine, weighing but one pound per horse-power, will be an accomplished fact.

Numerous metallurgical difficulties had to be overcome before alloys capable of fulfilling the severe conditions of engine service could be produced. The earlier aluminium alloys had earned the unenviable reputation of deteriorating with age, certain of them actually falling to powder when only moderately heated, or even at atmospheric temperatures. This defect was easily prevented once its cause had been traced to the presence of certain impurities in the metal. The high temperatures developed at the piston-head demanded a metal of high resistance to heat; this requirement was met by alloying the aluminium with copper in certain proportions, while the employment of a sufficiently tough alloy, combined with the introduction of thin steel liners to take the rubbing action of the piston rings, made the aluminium cylinder possible.

Progress in replacing the wooden framework of the aeroplane with spars

and struts made of aluminium was far slower. The difficulties in obtaining an adequate supply of timber made a move in this direction imperative, but at the time no alloy was known which could, in any sense, be considered a substitute for wood in situations where lightness, strength and rigidity were the controlling factors. Aluminium itself was useless, owing to its softness, flexibility and comparatively small strength. It was at this point that the metallurgical researches being carried out at various institutions, but notably at the National Physical Laboratory, began to bear fruit. The properties of the various aluminium alloys had already been studied, and exhaustive tests carried out on those showing any promise of yielding a metal of the required characteristics—lightness, rigidity and strength. These researches resulted in the production of aluminium alloys which have a strength quite comparable with that of certain grades of steel, and possess many of the valuable properties of that material while having only about one-third its weight. Of the several alloys developed, the most important is undoubtedly that known as Duralumin, an alloy of aluminium with about five per cent. of copper and a certain small proportion of magnesium. This alloy is the more remarkable in that it possesses that characteristic which renders steel such a useful material, and which distinguishes it from most other metals, namely, its ability to be hardened and tempered by heat treatment.

A metal which is to be used for building up the girder-like members of an aeroplane framework must fulfil certain primary conditions. Weight for weight it must be at least comparable in strength with a similar wooden structure. It must be ductile enough to be forged or bent into shape while cold, but still rigid enough to give the required stability to the finished member. It must be of uniform quality throughout, must be capable of being welded or riveted, and must not be affected by atmospheric influences. Duralumin fulfils these conditions to a surprising degree. Although six times heavier than spruce it is more than ten times as strong, its tensile strength, after heat treatment, being 26 tons per square inch, compared with the 2.5 tons per

square inch usually allowed for the best dry spruce. The manner in which it can be worked into shape is one of the most interesting features of this alloy. Naturally the metal used in aeroplane construction must be very thin if it is to compete with wood in weight, so that Duralumin is used in the form of thin, corrugated strips or sheets, often not more than one-sixteenth of an inch in thickness. This thin sheet is obtained from the original cast ingot by repeated cold rolling operations, the alloy being sufficiently ductile to allow this operation to be carried out without injury to the metal. After rolling, the strips are bent and worked to the necessary section. Some of the bends are very severe, requiring the strip to fold back upon itself, and as the strip must take this without any signs of cracking it is obvious that great ductility must be a feature of the metal used. But the very ductility which enables all these operations to be carried out would be fatal in the finished spar. It is here that the most remarkable property of Duralumin displays itself, *i.e.*, its self-hardening power. In order to bring about this hardness it is only necessary to heat the alloy to a moderate temperature and then to "quench" it by plunging it in oil or water. Immediately after this treatment the metal is as soft and ductile as before, but after lying for a few hours, "ageing" it is called, the metal commences automatically to harden up and, after about 24 hours, has reached a condition of maximum strength and rigidity.

The practical importance of this ageing process will be readily appreciated. It enables the strips of Duralumin to be fashioned into any shape while still in the ductile condition, and even after heat treatment, time is available to perform any finishing or straightening operations before the permanent hardness sets in. The same applies to the Duralumin rivets used in joining up the different spar members. Immediately after heat treatment these rivets may be cold-riveted with ease, and within a few hours become permanently hard and rigid.

Apart from the metallurgical problems thus briefly outlined the application of aluminium to aircraft construction involved the solution of purely engineering problems of no less difficulty. The ne-

cessity for building up the spars and struts from thin sheets of metal imposed a severe task on the designers, and many experiments had to be carried out before the requirements of an effective design were determined. In general the designs follow that of the box girder, but owing to the thinness of the metal, special precautions, such as the introduction of longitudinal corrugations, had to be taken to overcome failure from local flexure.

The future for metal construction of aeroplanes is very promising, and there can be no doubt that ultimately all large machines will be made of metal. The uniformity of strength obtainable with metal will give it a marked advantage over wood, and will enable aeroplanes to be made without such large allowances for variations of material. For the vital members of aeroplanes the only serious rival of the aluminium alloys at present is steel; but for the construction of many parts of the engine they stand without a rival. Aluminium is the most abundant metal on the crust of the earth. The inevitable decrease in the cost of its production, combined with improvements in the technique of its alloys, will open up vast possibilities for its application, and make it the preponderating factor in the development of aeroplane construction. The production of aluminium itself is not yet a commercial possibility in Australia, but most of the important light alloys have already been manufactured here. When once commercial aviation has been established in Australia neither the enterprise nor the technical skill necessary for the production of a supply of these alloys will be found lacking.

---

## CHRISTMAS GENEROSITY.

---

It was announced by the Directors of the Vacuum Oil Company Pty., Ltd., that all the Company's permanent employees in Australia and New Zealand would be paid a bonus at Christmas, equal to one month's salary for a complete year of service in 1919, or a pro-rata sum in the case of those employees who have served less than 12 months. This was the fourth Christmas bonus granted by the Company, similar payments having been made at the end of 1916, 1917 and 1918.

## CIVIL AVIATION IN AUSTRALIA

### TASMANIA.

#### Surveys Over Rough Country.

Although Lieutenant Long's machine is the only aeroplane in Tasmania at the present time it has been put to a number of important uses, and has amply demonstrated, not only the safety and reliability of the aeroplane as a passenger carrier, but has proved the possibilities of aerial aid in exploration and survey work.

Recently the Tasmanian Government decided to extend their great Hydro-Electric scheme so that Launceston and the northern end of the Island might draw upon the practically limitless supply of electrical energy generated at the Great Lake in the central highlands of Tasmania. Having reached this decision one of the problems that confronted the State Hydro-Electric Department was the selection of the cheapest and best route for the transmission line. The country over which the line has to be taken is, for a considerable distance, of a very difficult character, and before conducting an actual detailed survey of the route, the Department hit upon the idea of employing Lieutenant Long to take one of the Department's engineers over from Launceston to the Great Lake so that a general idea might be formed of the class of country through which the transmission line has to be constructed, and the experiment gave hopes that the final results will be of great assistance to the Department, although the day was too hazy to allow of really good photographs being taken. The cameras used for the purpose were hardly suitable. A low altitude had to be maintained in order to secure any detail at all, and to obtain photographs of the whole route it will be necessary to make exposures at the rate of three per minute, which is practically impossible with any but an aerial camera.

Lieutenant Long, accompanied by Mr. Wilton, one of the Assistant-Engineers of the Hydro-Electric Department, made the trip in his Boulton-Paul machine. The expedition left Launceston at 3.30 in the

afternoon, and headed in the direction of the Lake country. Passing over Evandale, Longford and Cressy they soon reached the Western Tiers. The visibility was far from good, but in spite of the haze, the country presented such a wonderful spectacle that they decided to go on across the ranges and right over the heart of the highlands which form the rapidly developing power-centre of Tasmania's cheap electrical energy. Climbing to about six thousand feet they crossed the range at Miller's Bluff, and travelling to Lake Sorell and turning westward they passed over Lake Wood, the Lagoon of Islands and Arthur's Lake, until in the near distance the Great Lake floated into view. Soon they were able to distinguish the buildings at Waddamana, where the main power-plant is situated. From here also could be seen Lakes Augusta, Pillans, Thompson and Julian. Turning south-east the aeroplane crossed the Western Tiers, on the return journey, at Brady's Lookout. From here was visible the beautiful stretch of country on the northern edge of which Launceston is situated. To the south rose the rugged, but fascinating tract between the Tiers and the central plateau. The whole of the latter stretch is of a rugged and mountainous description, rising abruptly in high peaks, with an occasional small plateau, and intermingled here and there with miniature lakes and lagoons. Further southward lay the larger lakes, some of which are presently to be harnessed for the purpose of augmenting the supply of power, and, it is suggested, of irrigating the whole of the midland plain. To add to its difficulty from an engineering point of view this wild country is nearly all heavily timbered. As a track of at least two chains in width has to be cleared to ensure the transmission line against bush-fires and wind-blown tree-branches, some idea of the difficulty of the undertaking may be gathered.

The distance travelled by the aeroplane was about 180 miles, though from Launceston to the Great Lake direct is roughly



50 miles, and another 10 miles to Wad-damana.

As a result of this experiment in aerial survey, the first of its kind in Australia, the Hydro-Electric Department is satisfied that the route previously mapped out for the transmission line is the correct one, except for one comparatively short stretch of which, it is hoped, in the near future, to secure complete and detailed photographs.

A second flight across the proposed route was attempted on the following day, but a lamentable, and quite inexplicable accident to the machine rendered it out of the question for the time being. It appears that the aeroplane was making in the direction of the Lakes, and when about seven miles from the range, and a little below their level, the machine put down her nose and refused to rise in spite of all the efforts of the pilot. A landing was effected with safety to the occupants, but with some slight damage to the machine. On investigation it was discovered that the aeroplane was in no way at fault; everything was in order; alignments were true; stresses were quite correct; angles were perfectly right; the engine was running without a hitch, and altogether there was absolutely no indication as to what might have caused the 'plane to behave so erratically. The only apparent reason for the mishap is based on a statement by local people that, in the region over which the machine commenced to dip towards the earth, very peculiar winds are sometimes experienced, limbs of trees being lopped off as though by a giant axe. It is presumed from this that a gully in the vicinity causes the formation of an air-pocket, or tunnel, or perhaps a permanent eddy. This surmise seems to offer the only possible explanation of the unfortunate "crash," which, though not serious, is very unlucky for the owner of the machine, who has many clients awaiting joy-rides.

Tasmania presents many possibilities for aerial exploration, and it appears likely that this expedition will be followed by others of a more or less similar nature.

#### VICTORIA.

On December 26, 1919, an aeronautical display was held at the Epsom Racecourse,

Mordialloc, by The Larkin-Sopwith Aviation Co. of Australasia. With the permanent pilots of the Larkin-Sopwith firm, Lieutenant A. L. Long, who recently flew from Launceston to Melbourne, competed in his Boulton & Paul biplane, photographs of which appeared in last month's issue.

At 1.30 p.m. the Sopwith 'planes landed from their aerodrome at Glen-huntley, and an opening flight was made by Captain A. W. Vigers, M.C., D.F.C., in the Sopwith *Dove* (K168). Captain Vigers possesses a noteworthy record of war service. He gained the Military Cross for conspicuous bravery while with the Royal Engineers, transferred to the R.A.F., and was awarded the Distinguished Flying Cross for valuable services in downing a number of enemy 'planes. In No. 87 Squadron he was one of the most capable pilots.

The programme commenced with a sham fight between the Sopwith *Dove* (Captain Vigers), and the Sopwith *Gnu* (Captain Roy King, D.S.O., D.F.C.). For a quarter of an hour the *Dove* attempted to sit on its opponent's tail, but Captain King, with a half-roll and a nose-dive, would evade him. Then with a steep bank, the *Dove* would renew the attack. In the air race the *Gnu* (Captain King) was placed on the scratch mark, the *Dove* (Captain Vigers) was given 10 minutes start, and Lieutenant Long, in his Boulton & Paul, 15 minutes. Throughout the race the last-named maintained an altitude of 2,000 feet, and was first seen high above the racecourse. While cruising at a high altitude, Captain Vigers suddenly appeared behind the grandstand, having covered the entire route at less than 100 feet. Three minutes later Captain King came into view, also flying low. The race had been to Prince's Bridge, Melbourne—where the 'planes dived and zoomed round a Good-year balloon suspended high above the city—and back again to the racecourse.

Lieutenant Long explained that he had intentionally delayed his landing, and for this reason the judges decided to fly the race again, omitting Captain King. The result was a win for Lieutenant Long, who had six minutes start, and whose flying time was 20 minutes, Captain Vigers (5 minutes handicap), taking only 19 minutes. However the quickest time was recorded in the first race, when Captain King covered the 37 miles in 15 minutes 5 sec-

onds, a speed of just over 140 m.p.h. being maintained.

The star event of the afternoon was a successful parachute descent from the *Gnu* by Captain G. C. Wilson, M.C., A.F.C., D.C.M. Flying at an altitude of 1,500 feet, Captain Wilson dived about 100 feet from the aeroplane before the parachute opened out, bringing him up with a jerk.

\* \* \* \*

Lieutenant W. H. Treloar in his *D.H.-6* has been astonishing the inhabitants in the vicinity of Ballarat and Ararat, and incidentally reaping a rich reward for his prowess. When this edition went to press he had started from Ballarat on a trip to Broken Hill, *via* the Mallee townships, at each of which he intended stopping for local passenger flights. This airman has already flown over 7,000 miles and has carried 786 passengers, none of whom were incommoded by forced landings. Mr. Sinclair, O.B.E. (President of Ripon Shire) and Councillor Mackay (Mayor of Ararat), were amongst those who took the air.

### NEW SOUTH WALES.

Sydney's joy-riding circle will be considerably extended with the opening of the *Avro* passenger service on January 9, by The Australian Aircraft and Engineering Co., agents for this popular type of machine.

The Company's immediate programme embraces an aerial tour of the Riverina district, and harbour-flights, by 3-seater seaplane (fitted with 130 h.p. *Clerget* engine), from Farm Cove to Woy Woy, Gosford and the Hawkesbury River, at a cost of £10 for a single trip.

The machines have been fully tested at the Mascot aerodrome, where the entire work of assembling the imported parts has been carried out by Australian mechanics.

The Company's aerodrome and erecting shops were inspected on January 8 by the District Commandant, Major-General Lee, accompanied by Major-General Legge and Lieutenant-Colonel Williams, D.S.O., who, until the end of the war, commanded No. 1 Squadron A.F.C.

### WESTERN AUSTRALIA.

Throughout the month of November Major Norman Brearley was busy conducting aerial joy-rides, and enlarging one of his *Avro* biplanes. The fuselage has been widened to allow two bucket seats to fit side-by-side, the rear seat-controls removed, and the machine refitted to increase the comfort of passengers. With the 100 h.p. Mono engine the *Avro* easily lifts two 14-stone passengers, and requires very little extra run to take off, even with full fuel tanks.

On November 12, Their Excellencies the State Governor and Lady Ettie Ellison-Macartney, with Miss Ellison-Macartney, took their first aerial glimpse of Perth from about 3,000 feet. The Minister for Railways (Mr. J. Scaddan) arranged for His Excellency to release one of the former's carrier pigeons, attached to which was a message for the Premier. The following is a copy of the message duly delivered:—

The conquest of the air, foreseen by Dr. Johnson in "Rasselas," has been definitely achieved. The endurance, utility, and comparative safety of various types of flying machines and their adaptability for commercial intercourse, as well as the purposes of war, have been demonstrated beyond doubt. A regular aerial passenger and parcel service has been in operation for some time between London and Paris, and is always overbooked. Though the conditions are not precisely similar, the vast distances in Australia, and the absence of lofty mountain ranges, seem to invite attentive consideration of the possibility of utilising aerial transit between the principal cities in the interests of commercial intercourse. This will certainly come in the future, but how near that Future may be depends upon the enterprise of the Present.

His Excellency expressed keen delight at the novel experience of flying over Perth and suburbs, and warmly congratulated Major Brearley on his handling of the machine.

\* \* \* \*

On December 2, a tour of the Great Southern was commenced, the first town on the itinerary being Northam (68 miles), which was reached in 44 minutes. After a few two-passenger flights Major Brearley left next day for York (22 miles), carrying two heavy-weights. He will visit all towns *en route* to Albany. The passenger-carrying in Perth being conducted in his absence by Mr. Hick.

## THE AUSTRALIAN AERO CLUB

### Victorian Section.

A committee meeting was held in Melbourne on January 7. Mr. A. H. Parker presided, and the following resolutions were carried:—

That immediate arrangements be made for the furnishing of the Club premises.

“That a “smoke night” be held to welcome Captain Sir Ross Smith and party on arrival in Melbourne.

That letters of condolence be sent to the widow of the late Captain C. E. Howell, also to the father of the late Mr. Phillip Nunn, who was accidentally killed while flying at Mornington.

That a sub-committee be formed to inquire into the causes of the aeroplane fatality at Mornington on January 2. President of sub-committee, Colonel W. E. Cass; secretary, Captain P. Roach Pierson; members, Mr. A. H. Parker and Mr. H. Sleeman.

That inquiries be made with a view to holding an aviation meeting in the near future.

That the following letter from Mr. H. Sleeman, managing director of Aerial Transport Ltd., and the offer contained therein, be received and accepted with thanks:—

“This Company is prepared to place at the disposal of members of the Australian Aero Club, its aerodrome at Gowrie Park, Tullamarine, 11 miles from Melbourne on the Bulla Road.

“The area comprises 568 acres, and the available landing grounds are four fields each of 40 acres area.

“Members of the Club will be permitted to use the landing grounds at their own risk, and must be responsible to the tenant for any damage done to property or live stock. It would be advisable for any members of the Club intending using this aerodrome to advise us beforehand, so that we may make arrangements with the tenant to keep one of the landing fields free.”

That a committee meeting be held at 7.30 p.m. on the last Friday in each month.

### New South Wales Section.

A committee meeting was held on December 17, 1919, when the following matters were dealt with:—

Hire of St. James' Hall, Sydney, for lecture on Commercial Aviation in Australia, and the issue of invitations to same. Invitations were also issued to members admitting them to the aerodrome at Mascot to witness the (postponed) landing of Sir Ross Smith.

Despatch of letters of condolence to relatives of the late Captain C. E. Howell, D.S.O., M.C., D.F.C., and Air-Mechanic G. H. Fraser, who perished in the loss of the Martinsyde biplane during their attempted flight from England to Australia.

Discussion of design for membership card to be issued to all financial members.

On January 5 further matters of importance were dealt with at a general meeting held in the Royal Society's rooms.

It was decided that a luncheon be tendered to Captain Sir Ross Smith and party, the function being open to financial members only; the president, Colonel W. O. Watt, O.B.E., undertook to arrange the details of this luncheon.

The sub-committee to prepare suggestions for the guidance of the Technical Committee was appointed, and will report after conference. The sub-committee is formed as under: non-trade members, Colonel Watt, Major T. M. Scott, M.C., Captain G. F. Hughes, M.C., A.F.C.; trade members, Captain Roy King, D.S.O., D.F.C., and Captain H. G. Watson, D.F.C.

Pending revision of rules, the existing Section Committee was requested to withhold its resignation. It is anticipated that the revised rules will be presented at the next general meeting.

It was resolved that, commencing with January, the membership fee would include an annual subscription to the official journal, *Sea, Land and Air*, the proprietors having undertaken to supply this at cost price, post free, to all financial members, as per list supplied by the Club Treasurer. On this motion it was further resolved that the Honorary Secretary be requested to extend this offer to other State Sections.

### South Australian Section.

The first annual general meeting was held at the Adelaide Wool Exchange on December 5, Mr. Dudley T. Angas presiding.

Office-bearers, as under, were elected for the ensuing twelve months: Chairman, Mr. D. T. Angas; Honorary Secretary and Treasurer, Mr. R. O. C. Matthews; Committee, Captain H. G. Butler, Captain E. F. Pflaum, Messrs. D. Day, C. Exton, J. Gordon F. L. Parsons and H. W. Pope; Council members, Messrs. Angas and Matthews.

Regarding control of air traffic, a copy of the Air Navigation Act was fully discussed and declared unnecessary of modification, excepting in clauses relating to altitude and prohibited areas.

An offer by Captain Butler (Butler & Kauper Aviation Co.), placing the Company's aerodrome at Sir Ross Smith's disposal was gratefully accepted by the Club.

A letter from the Honorary General Secretary stated that arrangements were in hand for the holding of a conference of State Section secretaries; the approval of the South Australian Section was recorded.

### AIRCRAFT YEAR BOOK FOR 1919.

There comes to us from America a very comprehensive publication; this is the first Year Book compiled by the Manufacturers' Aircraft Association, Inc., 501 Fifth Avenue, New York. It recounts the activities of America's aircraft manufacturers during the war. The whole object of this publication is to show the public what the war caused to be evolved in their midst, and it pleads to them in the interests of science and common sense not to let the brains and experience so foregathered be scattered, but to make commercial use of aviation, and to persuade their Defence Department to use this means more extensively in repelling any possible invader. We would some such authoritative publication would spring up in our own midst and instil into the minds of our Public the necessity to take the course

so advocated. The articles that will appeal most to the general reader are those dealing with the Companies which incorporate the Wright Brothers and Glenn Curtiss. The former are the manufacturers of the famous *De Havilland-4's* of which approximately 2,000 are said to have been delivered to Europe before the Armistice was signed; the latter are responsible for the Curtiss 18-T triplane.

### PERSONAL.

Major Lee Murray, chief engineer to Aerial Transport Ltd. (Melbourne and Sydney), who sailed for America in October last, is now in London. After investigating the inner workings of the United States Aerial Mail Service he crossed the Atlantic in the *Adriatic*, and writes that he expects to return to Australia during the next few weeks.

Mr. H. C. Macfie, director of Aerial Company Limited (A.C.L.), will leave London for Sydney on the *Osterley*. He has been purchasing flying boats for commercial flights.

Lieut. Sydney Cotton (ex-R.N.A.S.), inventor of the "Sidcott" air-suit, and at one time a likely starter in the flight from England to Australia, has also booked his passage in the *Osterley*. Among his purchases for use in connection with his father's extensive station property at Brunette Downs, North Queensland, is a Boulton & Paul biplane.

Mr. Sylvan Ginsbury, general manager of Thompson Meggitt & Co., Ltd., representing the Australian interests of The Curtiss Aeroplane and Motor Corporation, will sail for America in the *Ventura* on January 14.

Captain Henry Nielson Wrigley, D.F.C. (late No. 3 Squadron), and Sergeant-Mechanic Arthur William Murphy, D.F.C. (late No. 1 Squadron), who conducted the first aerial survey from Melbourne to Darwin, returned to Sydney in the *Mataram* on January 10, and left for Melbourne by express six days later. Captain Wrigley and Sergeant Murphy will relate their experiences in the February issue of this journal.

## ROMANCES OF INDUSTRY

Especially Written for "Sea, Land and Air" by Miss KAE McDOWELL  
**AUSTRALASIAN WOOL FOR EXPORT**

(All Rights Reserved)

The great march of industrial development is one of the world's most interesting studies. Romance lurks in every phase of it. In its unlimited fields, artists, poets, business men and politicians all find alluring hunting grounds, as well as scope for all their energy and skill.

Their establishment was contemporary with our earliest colonisation. On the banks of the creek that flowed into Farm Cove, through what are now the Botanical Gardens, the first wheat was sown in Australia. The first Gordon Merino sheep, patriarchs of our rural wealth, arrived at Port Jackson about 1778. Ro-



Ready for the Shearer.

Up to the present Australia's greatest industries have been connected directly with the soil—wool, wheat and gold. Now sufficient effort is being made to stimulate other branches of productiveness. Thousands of industries are springing into being. Great mills are humming night and day; steel is clashing in the foundries; ships are being built and aeroplanes manufactured. But wool and wheat will always remain our greatest sources of wealth.

mance took a hand in the business from the first. They came from the Cape of Good Hope—progeny of some beautiful stock presented by the King of Spain to the Dutch Government. The Boers, not being impressed by them, treated them with contempt, in fact, in spite of the persuasions of their Scottish Governor. They preferred their own "hairy, fat-tailed scrubbers." Governor Gordon, however, raised a nice little flock for himself.

When he died the sheep were auctioned, and Captains Kent and Waterhouse, of the good ships *Reliance* and *Supply*; who were on the look out for stock for the young colony of New South Wales, bought thirteen each. The voyage from the Cape to Sydney lasted three months and 24 merinos lived through it. These were bought by Captain Macarthur and others. Macarthur, who was really the father of the Australian wool industry, procured eight.

In 1807 he sent his first "clip" Home. It weighed 245 lbs. Twenty years after the New South Wales wool clip had increased to 411,600 lbs. Last year it amounted to 284,188,000 lbs., Victoria coming second with 105,424,682. Com-

your sheep and mine do not get on much," wrote he, "even the wethers don't thrive since the Governor has issued orders for the price of mutton to be lowered. They are drove into the woods after the dew is off the grass, drove back for the man to get his dinner, and then taken out again till the close of the evening, when they remain in the yard for the night."

Henty, writing of the early shepherd, said: "They were a curious species of humanity, totally unfit for any other occupation . . . Horrid old ruffians, prone to get into the vilest of tempers. This was, however, not altogether to be wondered at. Their huts were only visited once a week by the ration cart,



The Wolseley Shearing Machine in Operation.

monwealth wool production for 1917-18 was 573,068,155 lbs., and was valued at between £24,000,000 and £25,000,000. In 1918 there were 84,965,012 sheep in Australia, New South Wales owning 38,482,465 of them. The export of wool-tops has increased in value from £415,670 in 1913 to £1,510,799 in 1917-18.

The merinos did not flourish under their early management in New South Wales. Their owners insisted that they should be treated on the same lines as the more hardy British varieties. A quaint letter has been handed down, from a man to his absent employer:—"Both

and the shepherd, perhaps, twice a week by the overseer . . . They were a queer lot, nearly all convicts."

Contrast all this with present day methods—with the rolling pasture-lands carrying vast flocks. Like every other pioneer, the man was laughed at who first mooted the idea that sheep would probably do better if the runs were securely fenced and they were left to themselves to eat and sleep when they liked.

The old order changeth. In the olden days at shearing time the shepherds were told that their flocks would be wanted by a certain date at the sheds, and they would laboriously "travel" them thither.

Sometimes it took days. Shearing was, of course, done by hand, and a man who could shear 60 sheep a day was an expert. This age of machinery looks aghast at such trifling. Machine shearers do their hundred a day, and horsemen and dogs do four of the old days' mustering in one.

A shearing shed in full swing has a fascinating effect on an observer. Above all is the unmistakable smell of sheep and the rhythmical whirr of the machines. Down the long shed are rows of stooping men, the sheep mute and pas-

evening shows tense, haggard faces and bent figures.

There is little rest on a sheep farm at shearing-time. Musterers are up at dawn, and work in the saddle in choking dust till dark. The women of the household are often cooking for 18 out of the 24 hours. The very dogs and horses are practically worn out when the season is over.

On leaving the wool-shed the next stage in the Golden Fleece's history is its transport to the shipping centre. In the olden days this was often an intri-



Australian Wool Transport in the Interior.

sive in their hands, the drab fleeces rolling magically back and revealing the snow beneath. As soon as the fleeces have been peeled off they are "picked-up" by the waiting boys and thrown upon the classers' tables, from which they are allotted to bins, according to grade, pressed and baled.

Shearing is no light work even by machinery. The men are paid by results. Competition is the order of the day, and

cate business. Roads were purely nominal and the bullock drays travelled in numbers for company, and protection from the blacks. Often the journey took a long time—sometimes months. Bridges were non-existent, and when floods were bad the waggons had to camp till the rivers went down. Then the rations would give out and a detour of a hundred miles or so to settlements would have to be made for supplies.

Now, though in far-back districts much wool is still carried in bullock wagons or, two bales at a time on camels, the railways have smoothed the problem of transport. On arrival in the shipping centres the wool is taken to the great warehouses where it is appraised, and where, previous to the war, it was catalogued and auctioned to buyers sent from all parts of the world.

It is at this point that we come to the greatest innovation that has ever crept into the wool industry. The cause of it was, of course, the war, which, in many instances, plunged the world's markets into a state of chaos. Primary industries were profoundly affected.

Australian wool which for many years had found its way in huge quantities to

as one complete wool year after its termination. This was the biggest wool deal that has ever been carried through in any part of the world. The price also was excellent, as it was paid for the wool here in Australia—necessary storage cost also to be borne by the British Government.

Arrangements were at once made with the Commonwealth to administer the scheme. For this purpose a Central Committee was formed in Melbourne, and a State Committee in each of the shipping centres.

It was considered desirable that the operations of the Wool Scheme should interfere as little as possible with the existing organisation of the industry. Brokers continue in their ordinary



Australia's Largest Wool Showroom.

Germany, France, Belgium and other European countries, as well as to Britain, was left suddenly, practically without markets. Trade with enemy countries was suspended, and trade with Allied countries was impossible on account of the shipping scarcity.

The quantity grew with time, as did, also, the amount of wool in the country, for shearing had to proceed as usual. The situation became tense, and the stores congested. Then, apparently suddenly, the tension was relaxed by the action of the British Government which, in November, 1916, purchased the whole of the season's clip at a price equal to 1s. 3½d. per lb. all round. Later the offer was extended to the 1918-19 clip; then to cover the whole period of the war as well

capacity, except that of course there are now no auctions. The bales are opened in the various showrooms and the British Government appraisers examine them there.

As soon as the wool has been appraised it falls into the hands of the Committee, and has to be stored by them pending shipment. The magnitude of the storage problem may be easily realised when one considers an annual clip approaching 600,000,000 lbs., the effect of the shipping shortage. Arrangements were made as far as possible with brokers and stevedore companies, but it was found necessary to construct huge stores, as well, in all the appraising centres. Those at Wentworth Park, near Sydney, have a storage capacity of 350,000 bales.



# THE LEAGUE OF NATIONS

## CANADA

Especially Written for "Sea, Land and Air"

By HAROLD H. JOHNSON

(All Rights Reserved)

[This article is the fifth of a series dealing, in alphabetical order, with the countries which have signed the covenant of the League of Nations. The next country on the list, the Commonwealth of Australia will be similarly dealt with in our February issue.—Ed.]

It is an interesting fact that various parts of the British Empire were invited to affix their signatures, or strictly speaking the signatures of their accredited representatives, to the Covenant of the League of Nations. The first names on the list of those who signed on behalf of the self-governing Dominions of the Empire, were Canadian, signifying, I think, the admission of that Dominion into full partnership in Imperial affairs; the fitting reward of loyal assistance in the Empire's desperate need.

The Canadian Provinces were united in 1867, under the title of The Dominion of Canada, by the British North America Act, a Constitution similar in principle to that of the United Kingdom. The year 1867 also saw the passing of the Second Reform Bill by the British Imperial Parliament, the incorporation of Austria and Hungary into one Kingdom, the invention of the typewriter and the exposition of Maxwell's Theory in relation to electricity and light waves. In 1867 ships first passed through the Suez Canal.

Canada has a land and water area of 3,739,665 square miles, and a population of just over seven millions, and now includes all British North America, except Newfoundland and Labrador.

The Canadian Provinces are New Brunswick, Prince Edward Island, Nova Scotia, Quebec, Ontario, Manitoba, British Columbia, Saskatchewan, Alberta, the North-West Territories and the Yukon Territory.

Ottawa, the political capital of the Dominion, stands at the junction of the Rideau and Ottawa Rivers; Montreal is the largest city, and is built on an island at the confluence of the Ottawa and St. Lawrence Rivers; Quebec, the Gibraltar of America, is the capital of the Pro-

vince of that name; Toronto is situated on Lake Ontario; Halifax, the capital of Nova Scotia, has a splendid harbour; Fredericton is the capital of New Brunswick; Winnipeg, formerly the Hudson Bay Company's chief trading-post, and the capital of Manitoba, is the centre of the wheat-growing industry.

Newfoundland is the oldest British Colony, having been discovered in 1497 by John Cabot, with an English expedition. It stands on the north-east side of the Gulf of St. Lawrence, and its noted industries are fish-preserving and the making of cod-liver oil.

The St. Lawrence River with its great lake expansions of Superior, Michigan, Huron, Erie and Ontario, embraces an area of 150,000 square miles, and is the largest body of fresh water in the world. It is the great commercial highway of Canada. Below Lake Erie the River descends into Lake Ontario, forming the wonderful Niagara Falls. Issuing from Lake Ontario the St. Lawrence flows north-east past Montreal and Quebec into the Gulf of its own name.

The Fraser is the chief river in British Columbia. It literally teems with salmon, the canning of which is the chief industry in that part of the continent.

The late Sir Wilfrid Laurier, Premier from 1890 to 1911, is the only French-Canadian who has held that office. He was instrumental in giving the Mother Country Preferential Trade with Canada in 1897, and his activities and broad-mindedness have left a lasting impression upon Canadian history. Sir R. L. Borden, has been Premier since 1911, and was one of those who took a prominent part in the deliberations of the Peace Conference which led to the Covenant of the League of Nations. His previous distinguished career at the Bar eminently fitted him for such a rôle.

It is worth recalling that the Cunard Line of Steamships was founded by a Canadian, Samuel Cunard, who thought out his scheme at Halifax, I think. His company was the only large steamship line trading across the Atlantic which refused to be incorporated in the American Mercantile Marine, which had absorbed so many large companies, including the famous White Star Line. The Canadian Pacific Railway, familiarly known as the C.P.R., has assisted in the development of Canada to an inestimable degree. It is noteworthy that the Canadians deliberately elected that the greatest railway system in the country should not be under the control of the Government, but should be carried on as a private enterprise. Apart from its influence in the

interest on expenditure during the six years it was under construction.

Coal is abundantly mined in Canada, and Great Britain is, therefore, the only country that has adequate coal-bases on both sides of the Atlantic. One coal-field, east from Lethbridge, and reaching along the American boundary to the borders of Manitoba, has been estimated to cover 15,000 square miles.

The Province of Ontario is the greatest and wealthiest in Canada, with possibilities of great expansion. It is bounded by the great lakes of Ontario, Erie and Huron, and by three great rivers, St. Lawrence, Detroit and Ottawa. Its position in the whole of the continent is therefore almost insular. The exports of Canada are primarily wheat (which has



Château Frontenac and Dufferin Terrace, Quebec.

development of the country, it is, in its character, a singular method of the Imperial policy of *laissez-faire*, and the line has, therefore, become one of great national significance.

The scenery of the Selkirk and Rocky Ranges; the magnificent prospect of National Park at Banff; crossing the 1000 miles of N.W. prairie; the swirling rapids of the St. Lawrence; the view from the mountains at Montreal and the outlook from the promontory on which stand the Parliamentary Buildings at Ottawa, rebuilt after the fire in 1916, and also the view from the lofty terrace of historical Quebec, are some of the most striking in the whole world. The bridge by which the Grand Trunk Line crosses the St. Lawrence near Montreal, cost \$6,300,000, without considering the

been tritely said to be the basis of all civilised existence), cattle, cheese, pork, eggs, butter, apples, timber, paper, nickel and silver, all in vast quantities.

Along with industrial development making such exports possible, the educational well-being of the people has not been neglected. The famous McGill University has earned a well-merited reputation, and this and kindred institutions have assisted in bringing Canadian thought and aspirations so prominently before the world, so much so, that Canadian advice has for many years been sympathetically listened to in matters of great Imperial importance.

Amongst other exports the furs from the North-West constitute a source of wealth which is not possessed by other countries. This district is the greatest fur reserve in the world, surpassing the

**VICKERS**  
LIMITED

**"VICKERS-Vimy-COMMERCIAL"**

1 Pilot and 16 Passengers or 1½ Tons.  
of Mails or Freight. Endurance 5 hours



Aeroplanes for Commercial and Military Use  
Flying Boats for Commercial and Naval Use  
Vickers-Saunders Flying Boats

HEAD OFFICE:

AVIATION DEPARTMENT  
Imperial Court, Basil Street  
Knightsbridge, London, S.W. 1

AUSTRALIAN OFFICE:

**VICKERS-AUSTRALIA, LIMITED**  
(Messrs. William Adams & Co., Limited)  
Corner King and Clarence Sts., SYDNEY



Russian reserves, both as regards the commercial values of the skins and the number of varieties.

The Hudson Bay Company, whose Charter dates back to the time of Charles II. in 1670, administered the North and North-West regions until 1868, when it handed over its territories, rights and governing powers to the Dominion; so that for more than 200 years it was the dominant factor in the management of the territory. The Hudson Bay Company is still a very strong organisation. Victoria, capital of British Columbia, situated on Vancouver Island and overlooking the Straits of Juan De Fuca, was originally a Hudson Bay trading post, but is now a British Naval base for the Northern Pacific. It is from Vancouver, quite close to Victoria, that the C.P.R. line of palatial passenger as well as cargo steamers runs to Japan and the East.

In referring to the northern portion of the Dominion, that excellent body of men, known as the North-West Mounted Police, will be remembered with gratitude for their work in maintaining law and order in a country of vast distances, and in circumstances of great privation and danger, but who, as true sons of the Empire, have always upheld the best traditions of the service.

The French-Canadian Question is the crux of the political situation in the Dominion. It does not present so many difficulties as the Irish Question to Great Britain; it is not so impracticable as the Race and Colour questions which are clouding the national horizon in the United States; nor so perplexing as those which a temperate and tropical climate and the corresponding clash between strong and weak races, is beginning to produce in Australia; but it is a difficult question, and will test the patriotism of the Canadian people whether French or English. As to the future, France, with a declining population, will not be able to send many immigrants abroad. The French descendants are mostly moderate in their views, but others seem still filled with the idea that it will be possible to create something which will be practically a French Colony in Quebec. They apparently think still that as a reward for the explorations of La Salle, Juliet, Marquette

and others, they should have the privilege of forming a settlement of "Jean Baptistes."

Strangely enough, outside Quebec, the French-Canadian Question seems to have no important bearing on the life of the people. New France, as Lower Canada was styled by the early French Colonists, passed for ever into British hands by Wolfe's capture of Quebec in 1759, in which year the colonial strife between French and English had its dramatic *finale* in the deaths of both Montcalm and Wolfe, the respective French and English commanders, but French enterprise is perpetuated in the name of one of the United States—"Louisiana," named after the "Grand Monarque," Louis XIV. of France. There seemed, however, to have been no hesitation on the part of the French descendants to take an active part in the war under the British flag, and, although it would naturally be assumed that they would have preferred fighting under their own flag in the defence of their fatherland, their feeling of resentment against British Rule probably changed to love of a people who put their whole might into the scale against the enemies of France.

The three centuries of Canadian life from the time of Champlain to Laurier are of absorbing interest. The romance and tragedy of the period of exploration are imperishable parts of the country's history, yet the leaders were nearly all men of France. In all her varied dealings with colonies, it is questionable whether England ever had a more delicate or difficult problem to face than that which confronted Imperial statesmen after the war of 1812; they were called upon to form a Government and frame a code of laws adapted to the two adjacent Provinces of French Quebec and English Ontario, which were radically different in people, language, religion and customs. The problem was great and the blunders many, but there came into being the Confederation which saved Canada from disorganisation or incorporation with the adjoining Republic of the United States.

The first important French explorer was Verazzano, in the reign of the French King, Francis I., who was a worthy successor to Louis XI. Francis' joy is said

# "SHELL'S" Hat Trick



London - to -  
Manchester  
1910  
"Daily Mail"  
Prize £10,000  
Won By  
Paulhan on  
**"SHELL"**



Circuit - of -  
Britain  
1911  
"Daily Mail"  
Prize £10,000  
Won By  
Beaumont on  
**"SHELL"**



America-to-Europe  
1919  
"Daily Mail"  
Prize £10,000  
Won By  
Capt. Sir John Alcock  
on  
**"SHELL"**



**"SHELL" ALWAYS RISES TO THE OCCASION.**

It is pre-eminently the "Spirit of Achievement."

BRITISH IMPERIAL OIL CO., LTD.

All States and N.Z.

Faint, illegible text at the bottom of the page, likely bleed-through from the reverse side.

to have known no bounds when French warships captured some Spanish galleons as prizes, richly laden by Cortez, who had then conquered Mexico. Being in such good humour, Francis sent a facetious reply to the remonstrance of the Spanish King, Charles; asking if it were true that he and his brother, the King of Portugal, had parcelled out the New World between them, without leaving anything for him; whether Father Adam made those two his sole heirs and, if so, he desired to see Adam's last Will and Testament, failing which, he would feel quite at liberty in seizing any rich prizes his ships might sight on the ocean. This was the King who sent Verazzano to explore the New World. Sailing from Dieppe in 1524, he explored the coast from the Carolinas to Newfoundland. Verazzano's

curse of Catherine de Medici, at whose instigation the infamous massacre on St. Bartholomew's Day was carried into effect. A new start in the direction of colonisation was made in 1604 by an expedition under Champlain, who founded Quebec in 1608. The famous Château Frontenac there was named after the Comte de Frontenac, a man of great renown in France in the 17th century, and decidedly the most noted of all the Governors of New France.

The Spaniards in Mexico and Peru looked upon the conversion of the natives to the conquerors' religion as the first principle of state-craft, and the French were not behind in this direction, sending out Jesuits as missionaries to the Indian tribes. The tales of heroism of these men, especially under fearful Indian tortures,

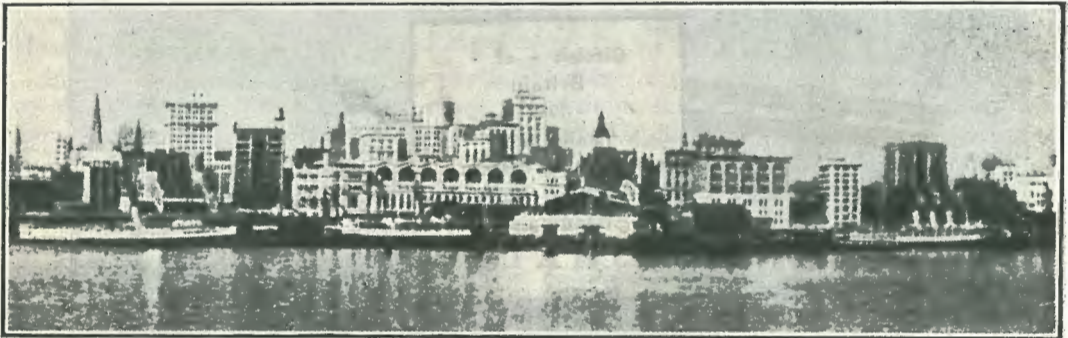

Water-front, Vancouver, B.C.

discovery was not followed up, and the French colonisation of Canada did not take place until ten years later, when an expedition under Jacques Cartier sailed from picturesque St. Malo, in April, 1534, and, entering the Gulf of St. Lawrence, navigated the river and fixed the field of French activities in the New World.

The St. Lawrence was so named by Cartier, who, on his second voyage in 1535, reached a small bay on August 10 (St. Lawrence's Day), and he named the place accordingly, the name was later applied to both Gulf and River.

Cartier also christened Montreal; looking from the mountain which commands such a magnificent view for mile upon mile of woods, plain and river, he named it Mount Royal, or as he pronounced it, Montreal. After Cartier's day, French colonial development was retarded by the

are almost beyond belief, and Canada owes a debt of sincere gratitude to them for their assistance in opening up the country and making it safe for the settler.

Canada was the first of the great colonies which formed a political combination, giving her a position closely akin to a nation.

The Canadian Constitution was discussed very fully at the Melbourne Conference in 1890, but as we all know it was rejected, the Australian Constitution being a very different piece of governmental machinery. There were two models to choose from, that of the United States and the Canadian, but for what reason the Australian Constitution was founded upon the United States model (which was designed to unite various States which had already declared their independence), instead of upon the

# NIEUPORT and General Aircraft Co. Ltd.

CONTRACTORS TO H.M. GOVERNMENT

Office :  
Langton Road  
Cricklewood  
London, N.W. 2

Cable Address :  
" Nieu Scout  
Crickle, London "

Prior to the War and throughout the entire War period the Management, Designers and Staff of this Company have been engaged on the Design and Production of aircraft which have been in continual use day and night, on active service, from August, 1914, to the cessation of hostilities.



Evidence of our high state of efficiency is again demonstrated in the fact that the LATEST TYPE OF FIGHTING MACHINE chosen by the Royal Air Force prior to the Armistice was the BRITISH NIEUPORT NIGHT-HAWK, which we are still producing in large quantities for the Royal Air Force Peace Programme.

" Daily Mail " (London) Copyright

THE FIRST DELIVERY BY AIR OF NEWSPAPERS WAS UNDERTAKEN BY

## BRITISH NIEUPORT

¶ Our Organisation which has in the past been responsible for our success in design and production of NAVAL and MILITARY aircraft, is now concentrating its energies in the development of Commercial machines—ranging from a small single-seater, of moderate power and price, to a large, twin-engine machine capable of carrying a disposable load of 1 ton.

¶ Inquiries are therefore solicited from Governments, companies or individuals interested.

Mention Sea, Land and Air when Communicating with Advertisers.

Canadian model (designed to unite self-governing provinces, which had not declared their independence), is not at all clear.

The Imperial Parliament is at all times ready to grant a Constitution to an aggregation of States in whatever form they desire. The South African Convention had vast difficulties to face, *i.e.*, those of language and race, also the memories of the South African War, which had left embittered feelings between the Dutch and British. The members of the Convention were against any Federal form for the Union, and decided in favour of a Constitution which would follow the British model. Thus, Canada and South Africa planned the British model for their Constitution, but Australia did not, and it is no wonder that in Australia today we hear so much about the need to enlarge the powers of the Federal Government, and it would probably be wise to give Australia a new Constitution altogether, on the Canadian or South African lines.

The Australian Constitution seems to conserve the interests of State Parliaments at the expense of those of the people. This scribe was unfortunate enough to reach Sydney by the last through train from Brisbane when the outbreak of influenza occurred in January, 1919. The Federal Quarantine Officers politely referred me to the N.S.W. Health Authorities who, while regretting their inability to assist me to return to Queensland, said it was a matter for the Queensland Government. After some weeks' delay, I secured passage by steamer to Brisbane, and the Federal Quarantine Officers boarded us in Moreton Bay and passed the steamer and all on board as "clean." Immediately they left, the Queensland Quarantine Officers, who had been standing-by in a launch, boarded the steamer, and we learned we should have to remain at anchor until seven days had elapsed since we left Sydney. This sort of thing will sound incredible to anyone with a knowledge of the power of the Canadian Parliament.

A so-called Constitution which allows the Provinces or States, as they are grandiloquently styled, such power that they can flaunt Federal authority with impunity, ought to be scrapped in favour of something more up-to-date.

## OUR QUESTION BOX

F. Phillips, Hawthorn.—The following alterations would be necessary: Formers for primary and secondary windings to be built with wider winding slots ( $\frac{1}{8}$  in.). Wind primary;

1st. 2nd. 3rd. 4th. 5th. stud.

10 20 35 50 80 turns.

Secondary: 100 turns, no tapings. The primary condenser must be made about double the capacity of that for the 250 meter receiver; secondary about three times that of the original. Primary should be connected in parallel with primary windings instead of series. Actual dimensions of cabinet need not be altered.

Lisw (Hamilton).—(1) Your diagram A shows a secondary circuit which can be tuned to one wave length only. Diagram B would enable you to tune the secondary to longer waves, but it would not increase the sensitiveness for the one wave length referred to above. If you wish to tune for shorter waves than A your secondary coil,  $L^2$ , should be made adjustable as  $L^1$ . For best results your coupling should be variable, and the secondary circuit should be tuned (when using B), with as small capacity and as much inductance as possible. For fuller details on this subject read "Bangay's Elementary Principles," paragraphs 441 to 447. (Wireless Press, Sydney, post free, 3/9.) (2) The clipping mentioned in your letter did not reach us.

R. Browne (Toowong, Q.).—For reply to queries (a) and (b) see *Sea, Land and Air*, October, 1919, p.p. 460-464. (2) Yes, most efficient apparatus, particulars obtainable from Austral Electric Company, 97 Clarence Street, Sydney. (3) The four-wire aerial should give slightly better results on account of its decreased resistance over that of the one single wire. Its resistance would be roughly one-quarter of the single wire.

W. Earle (Kensington, Vic.).—(a) The number of plates varies with the spacing between them, and may be determined from the following formula:—

$$K = AK$$

$$11.31 \times 10^6 \times d$$

Where  $K$  = capacity in microfarads.

$A$  = Total area of working sides of plates connected to one terminal in sq. cms.

$d$  = Distance between the plates in cms.

$k$  = Specified inductive capacity of the dielectric.

For air  $k = 1$ .

(b) These sizes may also be calculated from the above formula. This and other formulæ with demonstrated examples will be found in "Standard Tables and Equations in Radio Telegraphy," By Bertram Hoyle. Price 12/6. (Wireless Press, Sydney.)

### EDWARD WATERS & SONS

(Established 1859)

Patent and Trade Mark Attorneys

905 CULWULLA CHAMBERS,

67 CASTLEREAGH ST., SYDNEY

Tel. City 1187 (And at Melbourne)



# The "Bristol" Aeroplanes.

Cables:  
"AVIATION, BRISTOL"

Codes  
A 1, A.B.C. and Morseing

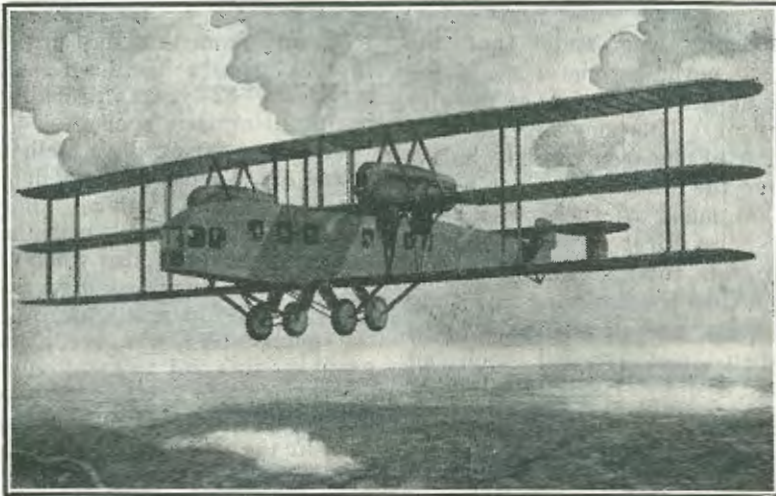

"BRISTOL" TRIPLANE IN FLIGHT

THE finest aeroplane constructed for passenger and cargo-carrying work. Fitted with four 400 h.p. engines, it is absolutely safe and reliable. In addition to the pilot and engineer it has accommodation for 14 passengers in a luxurious Pullman. This is 7 feet in height, is electrically lighted and heated, has comfortable arm-chairs, and for each passenger a triplex glass window is provided.

EACH, or all the seats may be removed, making room for cargo up to 320 cubic feet. The wing span is 81 feet, overall length 52 feet, and height 20 feet. The speed at ground level is 125 m.p.h., and at 10,000 feet 113 m.p.h. The climb is 5 minutes to 5,000 feet, and 12 minutes to 10,000 feet. In addition to the two pilots the machine carries a load of 2,700 lbs. with fuel for 5 hours' flight, or 4,000 lbs. with fuel for 2½ hours' flight.

THE BRITISH & COLONIAL  
AEROPLANE COMPANY LIMITED

FILTON, BRISTOL, ENGLAND

## WHITE WINGS

### THE STORY OF YACHT RACING IN NEW SOUTH WALES.

Epecially Written for "Sea, Land and Air" by E. J. HILL.

(All Rights Reserved)

There are many who state that the Australian will never become a sea-faring man, because he prefers the life of the city to the life afloat. This may be true of a certain section of the community, but it does not cover the whole. It must be remembered that many of those who came out with the First Fleet were West-Countrymen, who from their earliest days had been accustomed to the handling of sailing and rowing boats, and as was only to be expected, when they reached such an ideal spot as Sydney Harbour, the old longing awoke in their breasts and they started sailing and rowing races.

That they did so has passed into history, and the old records show that these forbears of our race were no less keen on aquatic events than are the Sydney yachtsmen of to-day, with their latest word in vessels which can fly through the water far quicker than could the four-in-hand coaches of their predecessors on the old coaching roads of England.

The first records of racing on the Harbour date back to ten years before Queen Victoria ascended the throne. The first yacht built in that year (1827), was the property of Mr. Robert Campbell, whose name has come down to us in Campbell's Wharf. She was a vessel of three tons, rigged with a sliding gunter mainsail and a jib. Not very long after a member of the same family became the possessor of a yacht of six tons, named the *Eclipse*.

In the year before Queen Victoria's coronation the first real yacht race was held on the Harbour. It was run under the name of the Sydney Regatta, and took place on December 31, 1836. Eight yachts participated in the big race, Mr. Sawyer's *North Star* coming in an easy first, followed by Mr. Martin's *Athol Ranger*.

To commemorate the settlement of the colony a regatta was held on January 26,

1837, and from that day until the present time, a regatta has been held without a break for 82 years, probably a world's record in aquatic sports.

(In those far-off days Melbourne was unheard of; Adelaide was a name only, and Brisbane but a village, and practically deserted, while West Australia was an unknown quantity. Also when this first Regatta was run this country was in its infancy. The steam engine, the motor car, the penny post, the aeroplane, the telegraphic cable, not to mention wireless, were undreamed of, but for all that the world went very well then.) Those who took part in the Regatta enjoyed themselves to the full—in more ways than one—if we can credit the stories handed down to us of the usual form of enjoyment in those days prior to Early Closing, or Total Prohibition. The general public crowded the foreshores of the Harbour and, when not watching the contestants, amused themselves by dancing, singing and pouring out libations to the skipper of their particular fancy. Mr. Milson's *Sophia* came in first.

*North Star*, a boat of the skiff type, won the first-class race in the following year. The Anniversary Regatta in 1839 was won by Mr. George Thornton's *Haidee*, which afterwards sank off Shark Point, Coogee, several of her crew being drowned.

One need not traverse all the years between 1839 and 1862, except to repeat that the Sydney Regatta continued, wet or fine, drought or plenty. In the latter year, however, an event occurred which stabilised yachting in New South Wales, an is, to a great measure, responsible for the fine number and class of boats indulging in this sport on the Harbour to-day. This was the founding of the Royal Sydney Yacht Squadron at the instigation of Mr. William Walker, a prominent merchant of the day, who called a meeting of nineteen yachting enthusiasts at his office, Exchange Corner, Bridge Street, Sydney, on July 8, of that year, when those present



THE FUTURE OF FLYING  
DEPENDS ON TRUSTWORTHINESS

The Supreme Test of Endurance

THE wonderful record flight  
half way round the earth,  
made by Capt. Sir Ross Smith  
in his Vickers-Vimy aeroplane,  
was achieved with **two Rolls-  
Royce, Series VIII "Eagle"**  
**type twelve-cylinder engines**

Rolls-Royce <sup>Aero Engines,  
like</sup> Rolls-Royce  
Cars, are the Best in the World



Australian Depot : 2 SMAIL STREET (off Bay Street), SYDNEY

unanimously resolved to constitute themselves into a club to be termed "The Australian Yacht Squadron."

The first general meeting of the Club was held on August 7, 1862 when the rules were discussed and formulated. At this meeting also, the first officers of the Squadron were appointed as follows:—Commodore, Mr. William Walker; Vice-Commodore, Mr. James Milson Jnr.; Hon. Treasurer, Mr. H. C. Dangar, and a Committee consisting of Messrs. Burt, Roxburgh, Rowntree, Parbury, Spain and McLean, with, as Secretary, Mr. George H. Howell.

The opening race of the Squadron took place on October 18, 1862, when a *rendezvous* was held in Farm Cove, twelve yachts, under the command of the Commodore, going through a series of evolutions in a strong southerly breeze and rain, finally bringing up at Manly, where the occasion was celebrated in a manner not entirely unknown to yachtsmen of the present day.

On New Year's Day, 1863, the first race for boats belonging to the Squadron, and under its sailing rules, took place at the Hunter's Hill Regatta; *Peri*, *Scud*, *Ida*, *Why Not* and *Old Tom* being the starters, and the first-named, the property of the Vice-Commodore, being the winner.

By a letter dated June 27, 1863, from Mr. Elyard, Under-Secretary of the Colonial Secretary's office, enclosing a copy of a despatch received by His Excellency the Governor of the Colony (Sir John Young, Bart), from his Grace the Duke of Newcastle, the Squadron was informed that H.R.H., the Prince of Wales, had been pleased to signify his willingness to become the Patron of the Club under the designation "Royal Sydney Yacht Squadron," and that the Lords of the Admiralty had authorised by Warrant—which was enclosed—the use of the Blue Ensign of Her Majesty's Fleet by vessels belonging to the Squadron. This Warrant was subsequently replaced by a fresh one, dated May 15, 1864, which still exists as the authority of the Squadron to exercise the great privileges which the right to fly the Blue Ensign confers.

The first Club match of the Squadron was held on January 13, 1864, for a piece of plate of the value of fifty guineas, over a course round Sow and Pigs, Fort Denison, and a buoy off Long Reef; starting from moorings in Farm Cove, and finishing over a line between the red buoy off Fort Macquarie and Kirribilli Point. *Era* took the trophy, but her

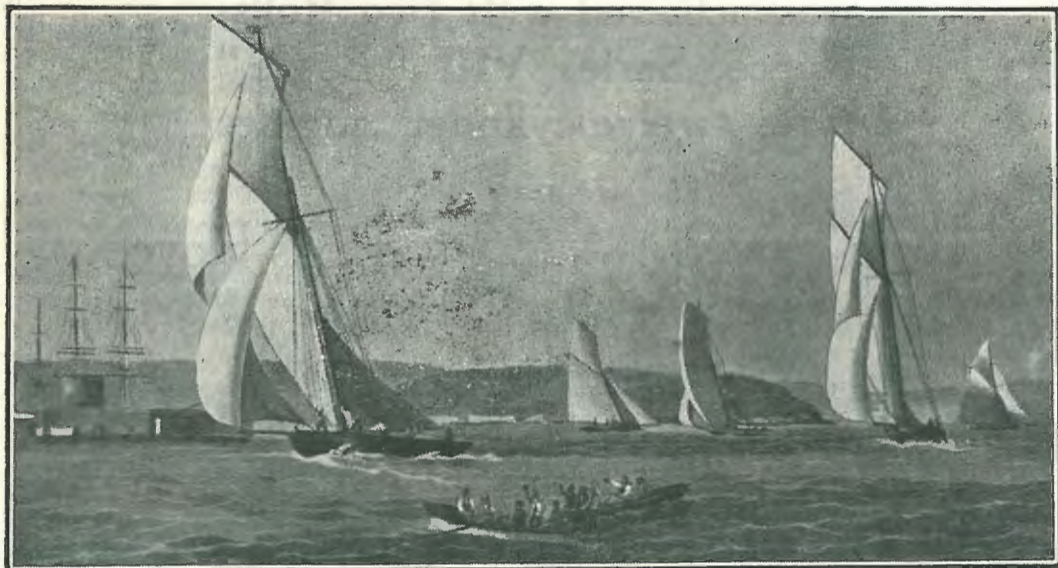

Early Yacht Racing Days on Sydney Harbour.

From an old painting in the possession of Lieutenant Walter Marks, R.N.V.R.,  
Commodore of the Royal Prince Alfred Yacht Club, Sydney.

Avro "BABY," 35 h.p., 85 m.p.h.  
 Winner of the Sealed Handicap  
 Aerial Derby, 1919

# AVRO AIRPLANES & SEAPLANES

AD  
 ST  
 file  
 title  
 also  
 vol

...g it as an ordinary ven... mishap, and pointing out that the Avro company has flown with 30,000 passengers a total distance of 250,000 miles in four months with out accident. Mr. Grey editor of "The Aeroplane."

SOLE AGENTS for A. V. ROE & CO. LTD.

## Every Requisite for the Airplane—We have it!!!

IF you buy one of our machines we teach you to fly and place our organization at your service.

Our Sydney Aerodrome has facilities for land or sea planes.

If you desire to make Aeronautics your life profession, we can accept you as an apprentice; only a limited number can be accommodated. Apply early. Address Chief Engineer.

- AIRCRAFT:** "Rotax" Aircraft Accessories.  
 Ryland's Aircraft Varnishes and Enamels.  
 North British Rubber Co., Aircraft Department.  
 Grey, McCann Co., Aero Accessories, Ltd.  
 Cox's Aircraft Glues.
- MOTOR:** "Avro" Light Car.  
 "Royal Ruby" Motor Cycles.  
 "A.B.C." Skootamotor.  
 "Eyquem" Plugs.
- ENGINEERING:** Campbell & Isherwood (Liverpool).  
 Electric Hoists, Portable Electric Drills.  
 Petrol Electric Lighting Sets (Country House).  
 British Fibrine Co.  
 Patent Steam, Gas and Water Jointing.  
 Leather and Rope Dressing and Wood Preservative.  
 "Col-Wa-Glu" Co. Cold Water Glues.  
 Tangent Tool Co. (Cosmos), Ltd.

**ENGINEER:** H. E. Broadsmith, F.R.Ae.S., A.M.I.A.E., late Chief Engineer to  
**CHIEF** A. V. Roe & Co., Ltd, on all technical matters concerning design  
 and construction.  
**CHIEF** N. B. Love, late Flight-Commander Australian Flying Corps,  
**PILOT:** Gosport Instructor's Certificate.

## Australian Aircraft and Engineering Company

12 Bridge Street, SYDNEY

Telephone: City 6794.

Telegrams: "Plover, Sydney."

Our Machines and Aerodrome will at all times be open to inspection by Examining Officials appointed by the Australian Aero Club.

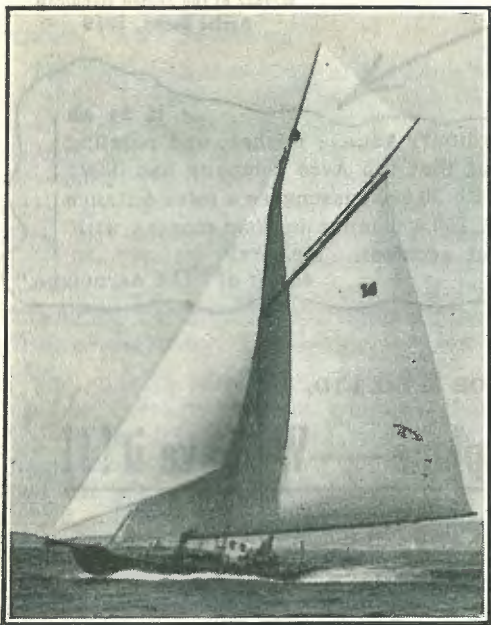

The "Awanui."

Originally owned by Mr. A. C. Saxton, she was purchased by Lieutenant Walter Marks, R.N.V.R. Re-christened "Culwulla III," she brought the Sayonara Cup from Victoria to New South Wales.

owner, Vice-Commodore Milson, returned it to the Squadron to be raced for in the following season, when Mr. Charles Parbury's *Xarifa* won it.

Intercolonial, or as we term it to-day, interstate racing was inaugurated in 1882 by the late Dr. Milford. He sent his little yacht *Doris* to Port Phillip, winning in a race against several Victorian yachts; but to Mr. Alfred Milson must be awarded the credit of being the first representative of the Squadron in a duly appointed intercolonial match. The event took the form of three races, which were held on January 15, 22 and 29, 1887. Mr. Milson, in his *Waitangi*, won the first and second races against the Victorian representative, Sir William Clarke's *Janet*, and in the following year Mr. Milson sent his forty-tonner *Era*, designed by Mr. Walter Reeks, to

Port Phillip, and brought back the prize for the big yacht race.

In January, 1904, three races were sailed over an outside course off Sydney Heads for a cup donated by the Prince Alfred Yacht Club, now the Royal Prince Alfred Yacht Club, and the Squadron. In these contests the *Sayonara*, which Mr. Alfred Gollin, of the Royal Yacht Club of Victoria, had brought round to Port Jackson, met the *Bona*, belonging to Mr. Herbert Binnie, representing the Squadron, and defeated her in the first and third events. Mr. Gollin then donated the cup as a perpetual Challenge Cup, to be known as the Sayonara Cup, to be raced for by vessels of the Victorian Club and the two Yacht Clubs of New South Wales.

In 1907 Sydneysiders made an unsuccessful attempt to bring the cup home, the challenger being *Rawhiti*, Mr. C. T. Brockhoff's boat. Mr. Charles Lloyd Jones in 1909 voyaged to Port Phillip in his *Thelma* to try and wrest the cup from the holders, but was defeated by the *Sayonara*. Mr. Walter Marks then took up the running on behalf of New South Wales with *Culwulla III*. (formerly Mr. A. C. Saxton's *Awanui*). Mr. Marks sailed her to Victorian waters *via* Tasmania, and steered her to victory in the first and second races of the series on March 11, 12 and 14, 1910.

A few days later the Squadron was represented by Mr. Marks in a challenge for the Northcote Cup, donated by Lord Northcote, in his *Culwulla II*., but the Victorian representative *Killara*, was successful in its defence. This cup still remains in Victoria and it is with the hope of bringing it back next February, that Mr. A. C. Saxton has just had built at the yards of Messrs. J. Hayes & Sons, Careening Cove, Neutral Bay, *Awanui III*., which was launched on October 28. She was designed by Mr. Morgan Giles, of Southampton, and is of uncommon design, her most striking characteristic being the difference in her beam measurements at the water-line and gunwale. She is a six-metre boat, 35ft. 4in. over all, 19ft. waterline, extreme beam 5ft. 4in., and depth 4ft. 6in., with a sail area of 600ft.

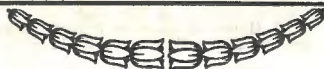

# THE CENTAUR 4 AEROPLANE

THE MOST WONDERFUL TRAINING AND PASSENGER MACHINE YET DESIGNED.

**SPECIFICATION**

Motor 100 H. P. Anzani  
 Tankage 3 Hours  
 Feed Gravity  
 Control Dual  
 Seats Two or Three  
 Oil Consumption 1½ galls. per hour  
 Petrol 8 galls. per hour  
 Speed 32-70 miles per hr.  
 Load 500 lbs.  
 Weight 1,400 lbs.  
 Wt. per H.P. 18.65 lbs.

The Last 4 Royal Aero Club Certificates taken at the Central Aircraft Co.'s School of Aviation were obtained in the following Flying Times:—

J. E. Russell, New York, 1 hr. 40 mns.  
 E. P. C. Godsil, New York, 2 hrs. 5 mns.  
 W. Pool, London, 3 hrs. 15 mns.  
 M. E. Tanner, London, 3 hrs. 30 mns.

Price: **£900**  
 F.O.B. London

**SPECIFICATION**

Length, 24 ft. 8 in.  
 Span, 34 ft.  
 Speedometer  
 Oil Gauges  
 Rev. Counter  
 Compass  
 Altimeter  
 Spare Propeller  
 Best Workmanship and Finish.

Holding the

## WORLD'S RECORD

Safe and Easy To Fly



High Factor of Safety

This Machine can be converted into a 3-seater in a few minutes.

IMMEDIATE DELIVERY FROM STOCK.

INSPECTED AND PASSED BY AERONAUTICAL INSPECTION DEPT.

CERTIFICATE OF AIRWORTHINESS WITH EACH MACHINE.

# The CENTAUR 2<sup>A</sup> TWIN-ENGINE NINE-SEATER

Passenger or Commercial Aeroplane. Th most Economical Machine yet produced.

Carries 9 People for 320 H.P.

**SPECIFICATION**

Motors 2-160 Beardmore  
 Tankage 3½ hours  
 Span 63 feet  
 Length 39 feet  
 Total Weight 5,400 lbs.

ENCLOSED CABIN, HANDSOMELY DECORATED.  
 BEAUTIFUL LINES AND FINISH.  
 FOLDING WINGS.  
 HIGH FACTOR OF SAFETY.  
 BEST MATERIAL & WORKMANSHIP  
 PROCURABLE.

**SPECIFICATION**

Wt. per H.P. 16.9 lbs.  
 Load 2,000 lbs.  
 Speed Range 40-80 M.P.H.  
 Petrol consumption .63 pints.  
 Oil 4 pts per hour.

Certified Air Worthy by Air Ministry

F.O.B. London Price: **£5,600** Complete with Instruments and Spares

THE **CENTRAL AIRCRAFT CO.,**

**KILBURN, LONDON, ENGLAND**

CABLES: AVIDUCTION, LONDON.

CODE: A.B.C., 6th ED.

# THE HISTORY OF THE P. & O. LINE

UNDER SAIL AND STEAM

Especially Written for "Sea, Land and Air"

By CAPTAIN J. H. WATSON, J.P., F.R.A.H.S.

(All Rights Reserved)

The Peninsular and Oriental Steam Navigation Company, like other great companies, had a very humble origin, and for its early history Cornewall-Jones' "The British Merchant Service," has been drawn on. A firm of London shipbrokers, Messrs. Willcox and Anderson, about 1825, became part owners of some sailing vessels trading to Vigo and Lisbon, which developed into a line of steamers, the first of which was the *William Fawcett*, a paddle-wheel vessel of 206 tons and 60 h.p., built in 1829. Her length was 74 feet, and she had a 16 foot beam. Another was the *Royal Tar* (so called after William IV., the Sailor King), a paddle-wheel steamer of 308 tons and 260 h.p.

These vessels formed part of a line of steamers for which Messrs. Willcox and Anderson were the London agents, the line itself being controlled by the Dublin and London Steam Packet Company. A Mr. Allen, from this company's office, was sent to London to assist the agents, and this gentleman became Secretary and eventually Managing Director of the P. & O. Company. The above vessels were running in this service from 1834, but in 1837 a contract was entered into between the Government and Messrs. Willcox and Anderson to carry the whole of the Peninsular mails, the figure being £20,500 per annum, for a monthly service.

This was practically the birth of the great company, then known as the Peninsular Company, and the first vessel to sail under the contract was the *Iberia*, a paddle-wheel, as the screw-propeller had not yet arrived. The *Iberia* was a new vessel, built by Messrs. Curling and Young, and she left London in September, 1837.

*The Nautical Magazine* of 1837 published an article from the *Morning Chronicle* of July 15, in which it said that the Government: "yesterday concluded a contract with the Peninsular Steam Navigation Company for the transmission of mails to the Peninsula by steam-vessels instead of sailing packets."

In a list of the *Past and Present Steam Fleet* of the Company, the *William Fawcett* occupies the first position, followed by the *Royal Tar*, *Jupiter*, and *Iberia*, from which it may be assumed that the Company indirectly dates its undertaking from 1834, and directly from 1837.

The progress of the Company from Peninsular to Oriental was gradual, the itinerary of the first contract (1837) was from Falmouth to Vigo, thence to Oporto, Lisbon and Cadiz, terminating at Gibraltar, nine days being the allotted time, including 60 hours detention at ports of call to land mails.

The next step was made to include Malta and Alexandria, followed in 1840 by the incorporation of the Company under the familiar name so well-known in the East.

Up to this time the mails for India were carried by the steamers of the East India Company between Bombay and Suez, and by British Government vessels from Alexandria to Gibraltar, thence by the Peninsular Company to England. This necessitated four handlings between England and Bombay, three by steamer and the connection between Alexandria and Suez, across the desert, by camel. The foregoing was a very slow and tedious means of communication, taking altogether about two months, which state of affairs public opinion eventually forced the Government to attempt to remedy. And this resulted in the great Company being brought into being by Royal Charter. The undertaking was for a service to Alexandria; from Suez to Ceylon, Madras and Calcutta; later followed by an extension from Ceylon to Penang, Singapore, Hong-Kong and Shanghai. The first vessels to run on the European side were the *Great Liverpool*, of 1311 tons, and the *Oriental*, of 1787 tons, the former being built in 1837 for the transatlantic trade, the latter in 1840, and as her name implies, especially for this service.

It was not, however, until 1842 that the Company commenced in Eastern waters,



# **AIRCRAFT INSURANCE**

---

## **Dalgety & Company Ltd.**

are now negotiating for the Australian representation of British Companies prepared to insure against the following risks to Aircraft in commission in Australia

### **POLICIES WILL COVER :**

**Damage to Aircraft by Accident, or Fire;**

**Public Risk, Damage to Cargo;**

**Injury or death to passengers or pilots or other employees, for any period, or in respect of the number of miles flown**

---

Particulars may be obtained from

**DALGETY & COMPANY LTD.**

**15 BENT STREET    ::    ::    SYDNEY**

the *Hindustan*, of 1800 tons and 500 h.p., being despatched from England to Suez on September 24, *viâ* the Cape of Good Hope, to open the service, and by 1844 all the sailing lines were in working order. The line from Suez to Bombay was retained by the East India Company, which was very jealous of any interference, and it was not until 1854 that it passed into the hands of the P. & O. Company. It may be as well to explain here that the mail route used by the Company was known as the "Overland Route," to distinguish it from the "Sea Route," by the Cape of Good Hope.

The credit for this departure was due to a Lieutenant Waghorn, an ex-Naval officer, who had served in the Bengal Pilot Service and in the East India Company's Navy. From experience thus obtained he was impressed with the importance of a short, direct route from England to India by steam, and in 1827 he broached the subject to some high officials in India, and carried home letters from Lord Combermere (Vice-President of the Council) to the East India Company, which at that time governed India, recommending him as a fit and proper person to open up the route, by steam, *viâ* the Cape. The Postal authorities and the East India Company opposed steam navigation successfully for a time, but in 1829 he was sent out by the Board of Directors of the E.I. Company to go *viâ* Egypt and the Red Sea to the Governor of Bombay with despatches, and to report upon the practicability of the Red Sea navigation for the "Overland Route." The first steamer that went to India, the *Enterprise*, was to go from Calcutta to Suez to meet him, but as her machinery broke down she failed to arrive. Waghorn was thereby forced to make the voyage down the Red Sea in an open boat, and from what he observed was evolved the route which was followed until the opening of the Suez Canal, which, however, the P. & O. Company did not make use of until 1872.

Waghorn constructed the desert road, building the halting places and hotels, which added so much to the comfort of travellers. Before he left Egypt, in 1841, he had established the use of English carriages, vans and horses for the conveyance of passengers and mails and abolished the use of camels.

In 1844 the P. & O. Company made a new proposal to relieve the East India

Company of maintaining the Suez to Bombay steamers; this was to run a line of boats to Bombay from Southampton, occupying a month, the steamers *Oriental* and *Great Liverpool* to run between England and Alexandria; the *Hindustan*, *Bentinck*, and *Precursor*, from the Red Sea to Bombay. The *Lady Mary* and the *Pacha* would be subsidiary steamers. The East India Company still remained adamant.

The provisional agreement with the East India Company with regard to the Calcutta route was for a mail every two months, but in this year (1844) it entered into a new contract. Under it the Company undertook to maintain a monthly mail between England, Ceylon, Calcutta, Singapore and Hong Kong, receiving from the Government £90,000 per annum, and from the East India Company £70,000 per annum. The duration of the agreement was for seven years.

At the beginning of 1849 the Company had three mail contracts in force; the first, a tri-monthly service from Southampton to Vigo, Oporto, Lisbon, Cadiz and Gibraltar, for the annual payment of £20,500. The second, a bi-monthly service from Southampton to Malta, Gibraltar, and Alexandria, for an annual payment of £44,025. The third, monthly, from Suez to Aden, Ceylon, Madras, Calcutta, Penang, Singapore and Hong Kong, for an annual payment of £160,000. In addition to these lines the Company also had regular monthly communication between Constantinople, Samsoun, Sinope, and Trebizond, known as the Black Sea Route.

The steamers belonging to the P. & O. Company shown on the Register at the beginning of 1849, numbered twenty-six. Ten of these were iron and the remainder wood; all had paddle-wheels, although the *Sultan* was converted to a screw-propeller in 1855, and the *Malta* in 1858.

#### STEAMERS OF THE P. & O. COMPANY January 1, 1849.

Name.	When Built.	Length. feet.	Tonnage.
<i>Jupiter</i> .. ..	1835	158.0	610
<i>Iberia</i> .. ..	1836	155.0	516
<i>Braganza</i> (†) ..	1836	188.0	688
<i>Liverpool</i> (Little)	1837	137.0	450
<i>Tagus</i> . . . .	1837	182.0	782
<i>Montrose</i> . . .	1837	166.0	606
<i>Achilles</i> . . .	1838	206.0	992
<i>India</i> . . . .	1839	183.0	871

# Larkin-Sopwith



# Aviation Co.

**OF AUSTRALASIA, LTD.**

The whole of the experience of the Larkin-Sopwith Company is at the disposal of any Government, Municipal Council, or Business House desirous of starting a service for conveying passengers or goods by air.

We have four different types of Aeroplanes to choose from, all of which have been designed and built since the Armistice especially for Commercial Aviation.

**MELBOURNE:** "Aberdeen House," Collins Street.

**SYDNEY:** "London Bank Chambers," cor. Pitt and Moore Streets.

Telegrams: "Larksop," Melbourne or Sydney.

WAKEFIELD

**Castrol** Regd.  
MOTOR OIL

## Sir Ross Smith's Telegrams

"DARWIN, 10th Dec., 1919.

"Many thanks—Congratulations.  
Your Castrol used whole flight.

"ROSS SMITH."

"DARWIN, 13th Dec., 1919.

"Can you supply me forty gallons Castrol at Narromine on sixteenth; also same quantity Sydney and Melbourne. Please reply me at Townsville.

"ROSS SMITH."

"CLONCURRY, 21st Dec., 1919.

"Please inform London Wakefield's Castrol used throughout whole flight with complete satisfaction. Engine still running beautifully after one hundred and fifty hours flying, which proves excellence of Castrol.

"ROSS SMITH."

CASTROL, the famous British Motor Oil—a grade for every type of water and air-cooled engine—obtainable from all garages.



**C. C. Wakefield & Co., Ltd.,**

**5 Moore Street  
Sydney & London**

Name.	When Built.	Length. feet.	Tonnage.
<i>Oriental</i> (†) ..	1840	220.0	1787
<i>Precursor</i> ..	1841	230.0	1817
<i>Lady Mary Wood</i> ..	1842	161.0	553
<i>Hindostan</i> ..	1842	218.0	2017
<i>Pacha</i> (‡) ..	1842	160.0	592
<i>Bentinck</i> ..	1843	217.0	1974
<i>Madrid</i> (‡) ..	1845	163.0	479
<i>Erin</i> (‡) ..	1846	199.0	797
<i>Pottinger</i> (†‡) ..	1846	205.0	1401
<i>Haddington</i> ..	1846	217.0	1647
<i>Ripon</i> (†‡) ..	1846	231.0	1508
<i>Indus</i> (†‡) ..	1847	208.0	1782
<i>Pekin</i> (‡) ..	1847	214.0	1182
<i>Sultan</i> (†‡§) ..	1847	224.0	1090
<i>Euxine</i> ..	1847	225.0	1165
<i>Malta</i> (†‡§) ..	1848	206.0	1217
<i>Canton</i> (‡) ..	1848	173.0	348
<i>Cairo</i> (*) (as canal steamer)	1841	99.0	71

\* Not in the Company's list, but taken from list in *Shipping Gazette*.

All these had paddle-wheels at this time, but those marked (§) were later converted to screw-propellers.

Those marked (†) were lengthened.

Those marked (‡) were iron.

The *William Fawcett*, *Royal Tar*, *Don Juan*, *Great Liverpool*, *Delta*, *Tiber* and *Ariel*, which had all been in the Company's service, when the Register of 1849 appeared, passed out of their control. The largest steamers in the preceding list were from 400 to 520 h.p., and the vessels cost from £50,000 to £90,000 each; these facts should be borne in mind for comparison's sake when the same subject is dealt with on the most modern vessels coming under review.

Up to 1852 Australia had no share in the benefits to be derived from steam communication with the Mother Country, not that the mercantile class was not alive to its advantages, but for the reason that the Colonies were not considered of much importance, in the eyes, either of the British Government, or of the capitalists, to warrant their consideration. The matter had been discussed both in London and Sydney for some years, and on March 5, 1846, a meeting was held in Lyons' rooms in George Street—(on the present site of the Union Steamship Company's offices). The meeting had been called by advertisement "for the purpose of taking into consideration the proposed screw-propeller navigation to Australia and India, *via* the Cape

of Good Hope." The chairman was the Mayor (Alderman Henry MacDermott), and many of the leading merchants and others were present. The meeting was adjourned to allow a committee to draw up a report which was received at a later meeting, and its adoption was unanimously carried. This meant that if any European Company desired "information such as could be gained in Sydney, bearing upon the subject, not easily accessible in England," and which might "assist them in their deliberations relative to the proposed extension of steam navigation," the information would be supplied.

While the question was being discussed in Sydney, a meeting was held in London on April 17, to hear a statement from Lieutenant Waghorn respecting "the advantages of the 'Overland' communication with India, and thence by that route to Australia and New Zealand."

Lieutenant Waghorn advocated a branch line from Singapore to Sydney, but a non-committal resolution was carried to the effect that: "this meeting highly approves of the establishment of steam communication with Australia."

It is not necessary to follow the various efforts made at both ends of the proposed routes to bring matters to a successful issue, but every year steam was taking a stronger hold on people's minds, and the P. & O. Company, considering that pioneering work had firmly established them, resolved, in 1852, to include Australia in its activities.

In 1849 the Company added to its fleet the *Bombay*, 1195 tons, and the *Vectis*, 793 tons; in 1850, the *Ganges* and the *Singapore*, both of 1190 tons. In 1851, a new departure was introduced, and the first screw-propelled steamer made its appearance for the Company. This was the *Shanghai*, a small vessel of 546 tons and 80 h.p., followed in 1852, by the *Chusan*. These vessels were intended for the China Trade, and their advent conveyed the idea that the Company's confidence in the new mode of propulsion was not unlimited. The Australian line being decided on, the *Chusan* was selected to make the opening voyage, and the command given to Captain Down. She left Southampton on May 16, called at the Cape and other ports, including Melbourne, and reached Sydney on August 3.

# Scripps-Booth Motor Cars

New Model, 6-Cylinder Type

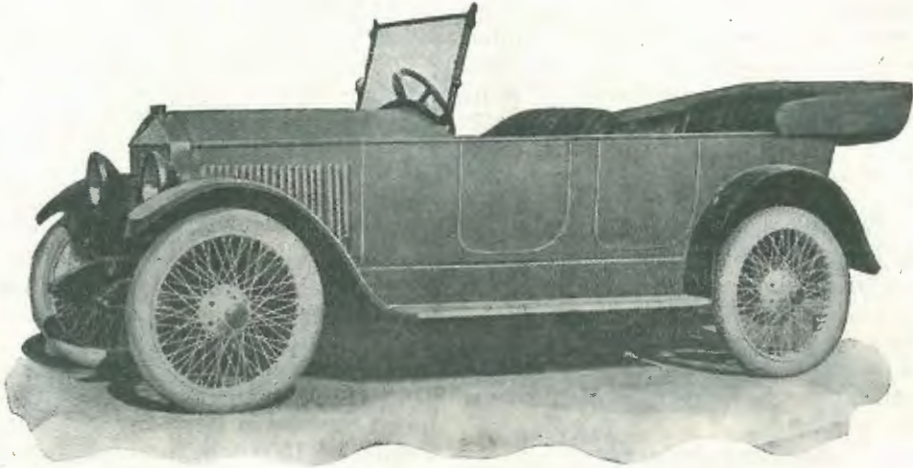

Inspection is invited of these cars at our Show-rooms.

The Scripps-Booth is a light car, 20½ cwt., and 19 H.P., R.A.C., equipped with Liberty Bosch magneto, Remy system lighting and starting, Marvel carburettor, with petrol mileage consumption of over 25 miles to the gallon — Stewart Vacuum Feed.

The Chassis is specially constructed with semi-elliptic springs, 51 inches in length, and ensures the greatest riding comfort over the roughest roads.

Immediate delivery can be given.

## JOHN McGRATH LTD.

200 PITT STREET, SYDNEY

Sole Agents for CADILLAC and SCRIPPS-BOOTH Cars.

The Press described her as a fine steamer, built of iron, 700 tons, and 80 h.p. engines, working up to 250. The vessel was a beautiful model, barque-rigged, with all the appearance of a man-of-war. Her armament consisted of a long 32-pounder aft, an 18-pounder forward and 12 pounder carronades on the main deck.

\* Engravings of her which have appeared from time to time, showing her under full sail, are familiar to most people. She was for some years a much-talked-of ship. If our grand-parents were present at the *Chusan* Ball they would boast of it, their minds going back to the night now over 67 years ago when they hied them to the Great Hall of the Australian Museum armed with an invitation and a programme printed on white satin, many of which, much faded, were cherished as souvenirs by those who, in their day, had ranked amongst Sydney's belles. This is the wording of what may be considered an historic document:

#### Ball and Supper.

In celebration of the Arrival of the First Mail Steamship from Great Britain.

#### Museum Great Room.

Sydney, 26th August, 1852.

The programme gives the toasts honoured when supper was over: "The Queen"; "H.R.H. Prince Albert" (The Prince Consort); "His Excellency, the Governor-General" (Sir Charles Augustus Fitzroy), and "The Army and Navy."

The toast of the evening, which was proposed by the Colonial Secretary, Hon. E. Deas-Thomson, was as follows:—

"Steam communication between Great Britain and the Australian Colonies, and may the rewards which will follow its permanent establishment be such as to justify the most sanguine anticipations of its promoters."

As the story of the P. & O. Company proceeds it will be seen whether "the most sanguine anticipations of its promoters" were justified. The toast was enthusiastically honoured while the band played the "*Chusan* Waltz." The concluding toast:

"The Hon. Mrs. Keith Stewart (the Governor's daughter) and the ladies of Australia," was set to the music of "We have lived and loved together."

The *Chusan* on her arrival in the Harbour, anchored off Moore's Wharf (Miller's Point); Mr. Henry Moore had been appointed agent for the steamers, a position he held for many years. She left on her return voyage to Singapore, to connect there with the steamer from Ceylon, on August 31; her route was *via* Melbourne and Adelaide, and the same enthusiasm which marked her arrival was shown on her departure. Every vantage spot was crowded with people eager to get a sight of the popular steamer.

Before she again returned to Sydney, however, those who farewelled her were to see greater steamers than she, for, by this time, the demand for steam communication was met by several Companies. On September 8, the Australian Royal Steamship Company's steamer *Australian*, of 1500 tons, arrived; followed on November 16 by the same Company's *Sydney*, of the same tonnage. Unbounded excitement was created by the arrival of the steamer *Great Britain*, of 3443 tons, on November 27; while before the end of the year the steamer *Sarah Sands*, of 1500 tons, was in Sydney. The end of the year saw, as a result of the 1846 meetings, all that could be hoped for. The steamer to run with the *Chusan* (by which a bi-monthly service was to be maintained between Singapore and Sydney) was the *Formosa*, a screw vessel of 675 tons and 80 h.p., built in 1852, and practically the same size as the *Chusan*. This vessel arrived on October 23, under the command of Captain Parfitt, and carried on her partnership until April, 1853, when she was withdrawn, and the *Shanghai*, a small vessel of 546 tons, built in 1851, screw-propelled and of the same horse-power as the others, took her place, Captain Parfitt changing his command. She first arrived in Sydney, from Singapore, on May 24, 1853. This arrangement lasted until January, 1854, when on the 19th of that month, the *Madras* arrived in her place. This vessel was an improvement on the others as she was of 1185 tons and 754 h.p. Captain Parfitt again had the command. The next change was the

\* A photograph of the *Chusan* was printed in the February, 1919, issue of *Sea, Land and Air*. (p. 674.)

# The Cottage Home

---

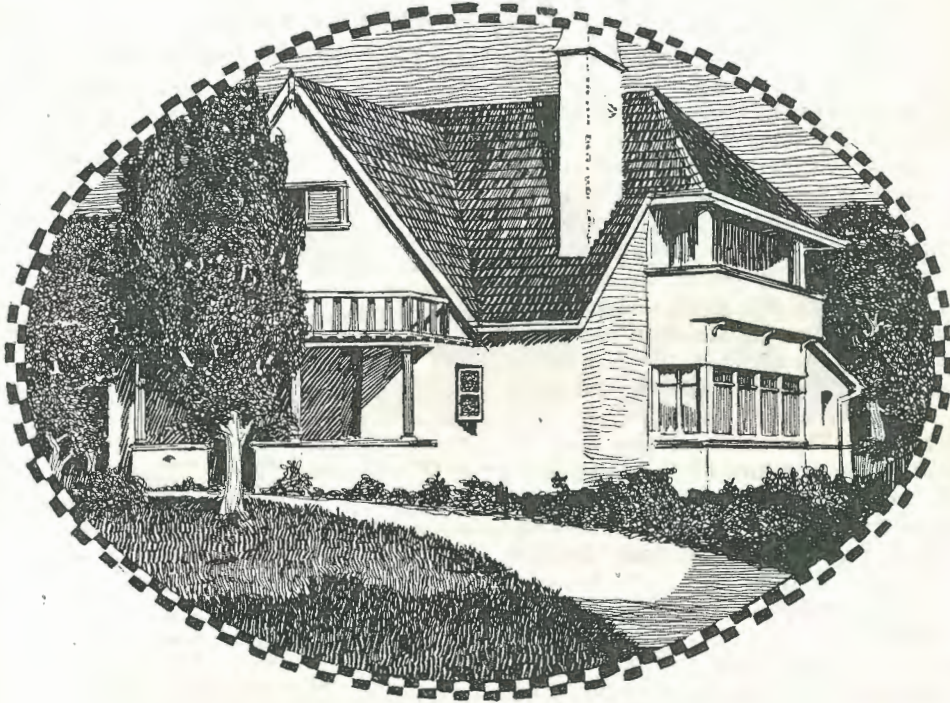

## Beard Watson, Limited

SPECIALISE IN THE PRODUCTION OF  
COTTAGE FURNITURE  
AND FURNISHINGS

---

INSPECT OUR SPECIMEN ROOMS :: FULLY SET OUT  
361, 363 George Street, Sydney

withdrawal of the *Chusan*; she left Sydney on March 21, 1854. The *Norma*, of 969 tons and 624 h.p., took her place, Captain Henry Down being transferred to her. This vessel, with the *Madras*, kept up the service with Australia until the *Madras*' trip in January, 1855; on her departure, on January 27, she severed her connection with Australia as far as the P. & O. Company was concerned.

There appears to have been no official notice given of this, but in the Monetary Article in the *Times*, it was reported "that the P. & O. Company had issued a circular stating that direct communication with China by their steamers on the 20th of the month is for the present discontinued."

Local newspapers pointed out that as there had been two mails to China a month, one on the 4th and another on the 20th, and as only one was withdrawn, the report did not mean that the Australian mail would be discontinued. It did mean that, however, for the steamers were withdrawn. The cause of this was the Crimean War, as many of the Company's newest and largest steamers were employed as transports between England and the Black Sea. Those running between Singapore and Sydney had to be taken to keep up the services between Suez, India and China.

Every effort was made for an early restoration, and the *Morning Chronicle* announced, on March 31, 1855, that the resumption was being considered by the

Directors. The Government, however, let the mail contracts; that *viâ* the Cape of Good Hope to the Liverpool Black Ball Line of sailing ships, and the other, *viâ* Suez, to the European and Australian Royal Mail Company; so for a time the connection, which the P. & O. Company had with Australia, was broken off.

#### STEAMERS ADDED TO THE FLEET FROM 1848 to 1855.

Name.	Built.	Tonnage.	Propelled by.	H.P.
<i>Bombay</i>	1849	1195	"	450
<i>Vectis</i>	1849	793	"	80
<i>Ganges</i>	1850	1190	"	1162
<i>Singapore</i>	1850	1190	"	1122
<i>Shanghai</i>	1851	546	Screw	80
<i>Chusan</i>	1852	699	"	80
<i>Madras</i>	1852	1185	"	754
<i>Formosa</i>	1852	675	"	80
<i>Bengal</i>	1853	2185	"	1084
<i>Cadiz</i>	1853	816	"	450
<i>Valetta</i>	1853	832	Paddles	1027
<i>Vectis</i>	1853	841	"	1058
<i>Rajah</i>	1853	537	Screw	120
<i>Tartar</i>	1853	303	Paddles	557
<i>Douro</i>	1853	810	Screw	554
<i>Norma</i>	1853	969	"	624
<i>Himalaya</i>	1853	3438	"	2050
<i>Manilla</i>	1853	646	"	290
<i>Colombo</i> *	1853	1864	"	—
<i>Ottawa</i>	1854	1275	"	700
<i>Candia</i> †	1854	1961	"	—
<i>Simla</i>	1854	2441	"	1766
<i>Union</i>	1850	340	"	227
<i>Nubia</i>	1854	2096	"	1422
<i>Emeu</i>	1854	1538	"	300

\* Lengthened in 1859.

† Lengthened in 1857.

(To be Continued.)

# "Sea, Land and Air"

will be sent, Post Free,

for 9/- per Annum.

VOLUME I.—BOUND FULL CLOTH, WITH INDEX.

(March, 1918—March, 1919)

12/6, Post Free.

Subscriptions should be sent to

THE WIRELESS PRESS, 97-99 CLARENCE ST., SYDNEY



Made in  
Australia

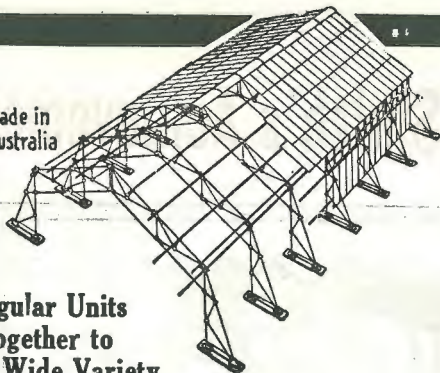

Triangular Units  
Fit Together to  
Form Wide Variety  
of Buildings

A New  
and Cheaper  
System of  
**BUILDING**

Made in Australia

“**GAWCO**”  
Standardised System of Building  
**GAWCO**

Each triangular unit is standardised; no riveting necessary. Easily handled, easily erected, easily transported—and

**FIRE-PROOF**

The “Gawco” is the ideal system for the construction of

**HANGARS**

as well as Mining Buildings, Machine Shops (especially in isolated districts), Roof Trusses, Suburban Machine Shops, and all Engineering construction.

FOR THE CONSTRUCTION OF HANGARS “GAWCO” is specially suitable, being easily and quickly erected, and due to the standardisation of the “Gawco” units a building may be quickly taken down and removed without deterioration, or could be added to as required to increase accommodation.

Write for fullest particulars and prices, which will be promptly supplied by the manufacturers—

**GARDNER, WÆRN & CO.**

225 Clarence Street, SYDNEY  
367 Queen Street, BRISBANE

Showrooms:

369 Flinders Street  
484 City Road  
MELBOURNE

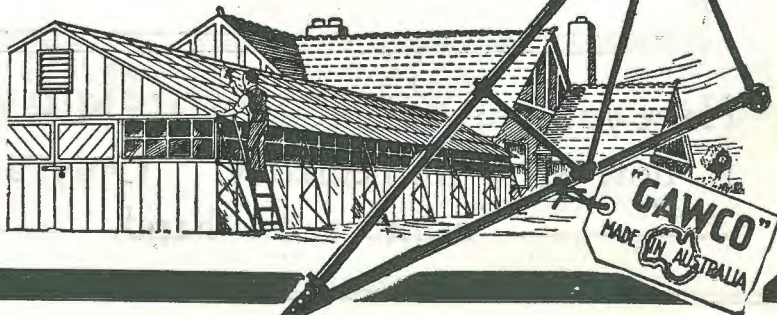

# Captain Sir Ross Smith's Achievement



**T**HE GREAT FLIGHT is fully described in the Christmas (double) number of **SEA, LAND and AIR**.

(The Official Journal of The Australian Aero Club)

SIXTY PHOTOGRAPHS of THE COMPETITORS, MACHINES and ENGINES

A complete diary gives daily progress, from start to finish, of each of the six competing teams in the AIR RACE ACROSS the PLANET.

Specially-compiled route-map and mileage-chart are included, also interesting survey of the Singapore—Darwin route (compiled by one who has travelled it from end to end). The whole forms a valuable permanent record of a great achievement in the history of international aeronautics.

128 pages—it costs 9d.

If your newsagent is sold out, send 9d for copy (post free by return mail) to: THE CIRCULATION MANAGER, "SEA, LAND and AIR," 99 CLARENCE ST., SYDNEY

Have you got YOUR SOUVENIR COPY?  
If not, send immediately. Only a limited  
\_\_\_\_\_ number on hand. \_\_\_\_\_

# The Shock-Troops of Commerce.

The nations abroad are organising **HUGE TRADE COMBINES** backed by **ENORMOUS CAPITAL** with veritable **ARMIES OF CONSULS**, selling agents, and **SECRET TRADE-MISSIONERS** — all for the "peaceful invasion" of countries open to exploitation .

## WHY?

— Because any country they can persuade or force to neglect its **OWN** manufactures for **THEIRS**, will help to provide **WORK AND WAGES , AND PROFITS, AND INCREASED WEALTH . . . . .**  
**FOR · THE · SELLING · COUNTRY.**

Buy only  
**Australian-made goods.**

# FOR THE WIRELESS EXPERIMENTER

THE DESIGN AND CONSTRUCTION OF LOADING COILS.

Especially Written for "Sea, Land and Air" by **RAYMOND EVANS.**

(All Rights Reserved)

With the advent of long waves, the design of that part of the receiving apparatus generally known as the "loading coil," or "loading inductance," has become a most important consideration. This is particularly so, because of the fact that, for long waves, coils of very high inductance values are necessary, involving the use of a great many turns of wire and, as a natural consequence, a greater loss of efficiency due to the distributed capacity effects of the windings and dead ends.

As the reception of long waves will be quite a new departure for the majority of Amateur Radio Experimenters in Australia, it is, therefore, essential for them to be given reliable data with which to carry on their experiments in this most interesting branch of science, and it is with this object in view that the writer has designed a modern type of loading coil as illustrated on page 725.

This instrument is of the Panel Type, and is provided with space wound inductances, the values of which are varied by means of a specially designed end turn switch. This switch enables an adjustment of the inductance values to be made in steps only, and in order to obtain a fine adjustment, and likewise closer tuning, a specially designed variometer is also placed in the cabinet, and is connected in series with the main inductance. In the writer's opinion, this arrangement is ideal, as it permits a smaller value of capacity being used in parallel, than would otherwise be the case. Normally, this variometer is adjusted to a mean value, as, for instance, that shown by the lower arrow on the panel and the position shown in figure 2; the tuning is then effected by means of the end turn switch, and the usual parallel condenser and finally by the close adjustment of the variometer pointer, which in most cases gives surprising sharpness and intensification. This type of loading coil is quite suitable for use both in the primary (or aerial circuit), and the secondary (or closed circuit), though, if used in the latter, it should be wound with a similar gauge of wire to that of the secondary of the tuner. In the case of the coil described in this article, it is intended to be used for primary loading purposes, a variable condenser of fair capacity being "shunted" across both the loading coil and the primary winding of the tuner.

This is a very fine combination, and works wonders with the long distance signals.

Nothing has so far been said of the small point switch on the centre of the panel; this is merely used to short circuit the terminals of the coil when working on short waves; thus cutting the load out of circuit.

**Construction.**—A perusal of the drawings of

the instrument will show that all measurements are not shown, some having been purposely omitted for the sake of clearness. As all drawings are to scale, no difficulty should be found in obtaining the correct dimensions of the various parts. To begin with the front or panel: this should be made from  $\frac{1}{4}$  in. or  $\frac{1}{8}$  in. sheet-ebonite, and should measure 12 in. by 6 in. Draw a line accurately down the centre and work from this when marking out all positions. The location for the holes for the end turn switch at the top of the panel can readily be obtained from measurements shown in Figure I, the centre hole being 3 in. from the top of the panel. The position for the centre of the small shorting switch, in the centre of panel, is  $6\frac{1}{4}$  in. from top of panel and the radius or distance to the two contact studs— $1\frac{1}{4}$  in. These two studs are one inch apart.

The hole for the variometer spindle is exactly 3 in. from the bottom of the panel, and those for the terminals 1 in. from the bottom and sides of the panel respectively, as shown in the panel drawing.

In this instrument, the various units are all secured to the panel, so that should a fault appear at any time, it will only be necessary to remove the wood-screws (which fasten down the panel to the case), to make an examination. The main inductance is secured to the panel immediately behind the end turn switch, by means of four screws (which are clearly shown), in a manner to be described later. The holes for these screws are spaced 4 in. apart, likewise those for holding the large or fixed coil of the variometer to the panel are spaced  $4\frac{1}{2}$  in. and  $1\frac{1}{4}$  in. apart respectively.

Holes are also provided for small brass stops, one on each side of both switches and the variometer scale, as shown.

The variometer scale can be made in the manner described on page 454 of the October, 1919, issue of *Sea, Land and Air*. Of course it will be advisable to engrave this scale before the holes are drilled in the panel, so as to provide a centre from which to work the dividers. Hold the dividers firmly, and engrave the curves rather deeply. The same will apply to the straight lines, degrees and the arrows. With reference to the arrows, it might be mentioned that the upper one serves to point to the number on the disc of the end turn switch, thus indicating the number of sections of the main inductance in circuit. The lower arrow indicates the normal position at which the variometer-pointer should be left in order to facilitate tuning. Next drill all holes in the panel to suit the various parts, and countersink those for the wood screws, around the

# **There's Money in it**

Once you have looked at this heading we know you will not put this book down until you have read this page right through; because we have some questions to ask you—questions that affect YOU!

## **THEY ARE—**

**Have you thought what your future will be?**

**What has your present position to offer you?**

**What do you hope to rise to?**

Think well over these questions. If you cannot answer them satisfactorily there is something wrong with your present job. That being so, look around and see where the good positions are.

You must decide on WIRELESS for the following reasons: You travel the world, and travel is education. The prospects are unlimited because this profession is only in its infancy. The pay is good, because good men are worth good money.

Students of the MARCONI SCHOOL have priority of appointment to all vacancies in the Australasian Mercantile Marine, and to fit you for these positions we have—

**DAY AND EVENING CLASSES.**

**SPECIAL CORRESPONDENCE COURSE IN WIRELESS TELEGRAPHY  
AND THE ELECTRONIC VALVE.**

Do the right thing NOW and call or write to us to-day. We will put you on the road where the good positions are.

**SUPERINTENDENT**

## **Marconi School of Wireless**

**97 Clarence Street  
SYDNEY**

**422-4 Little Collins Street  
MELBOURNE**

edge, and also those which will be used to hold in place the formers of the main inductance and the large coil of the variometer.

Bring the panel to a perfect smoothness with a fine emery-cloth block, using an end to end motion, and thus giving the panel a fine grain, running parallel to the edges, it can then be polished with an oily cloth. It will now be necessary to fill in the scale with white paint; zinc oxide and varnish well mixed into a smooth paste, as described previously, works admirably. Before applying, clean all dust from the lines, curves and figures of the scale and press the paste well in with a smooth, flat instrument, then clean off all surplus paint with a cotton cloth and allow to dry.

The contact studs can be made from ordinary cheese-head screws with the slotted part filed away; use, say, sizes known as 2 and  $\frac{1}{4}$  B.A., about  $\frac{1}{2}$  in. in length.

That portion of the cabinet which calls for most care in construction, is certainly the end turn switch. This type of switch was described in our December issue (in the article on the long wave tuner), but as it is shown here in more detail, and as the dimensions differ, we have published it again.

The ebonite fan (the position of which is shown by the shaded portion beneath the contact arms, on the end turn switch on the panel drawing), must be made of the same thickness of material as the contact studs, and is fastened in place by means of two small countersunk screws, also by the stop-pin as shown. All parts of this switch are as described in the December article, though the difference in dimensions can be seen in Figure 1. There are six pairs of contact and one single arm, the single arm is shaped as shown on the right of Figure 1, and the others on the left; the double arms merely serving to connect the end of one section of the coil to the beginning of the next. Work this out by the help of the circuit diagram (Figure 5). It is most important that the contact arms should be extremely springy, as sure contact cannot be obtained otherwise.

The variometer consists of two coils, one within the other, the outer coil being wound on a "former" of wood and paper.

This former is made by first winding about six layers of fairly stiff paper around a cylinder of wood,  $4\frac{1}{2}$  in. in diameter, liberally coating with shellac varnish between the layers. Tie firmly with twine, and when dry give a coat of shellac inside and out. Wooden ends must then be cut from  $\frac{1}{4}$  in. material to the dimensions and shape shown in the drawing of the outer form (Figure 2). Fit the paper tube squarely into these ends and secure in place by means of small brads or glue. Wind this former with one layer of 32 turns of No. 22-gauge D.C.C. copper-wire; leave a space of  $\frac{1}{4}$  in., exactly in the centre, to allow the centre-spindle of the moving coil to pass through. Holes must, of course, be made in the paper tube to admit this spindle (Figure 2). The inner or moving coil is wound on a former of wood, which measures  $3\frac{1}{2}$  in. in diameter and 2 in. in length. A hole is drilled through the centre of this wooden drum which must fit the

$\frac{3}{8}$  in. brass spindle tightly. The position of the drum with relation to the pointer is shown in Figure 2. This shows the coils to be at right angles to each other when the pointer is in the normal position. In order to lock the drum to the spindle a small pin is driven into a hole drilled in the spindle and falls into a narrow saw-cut in the drum, as shown, and the nut at the opposite side holds both rigid.

Wind the inner form with two layers of No. 22 wire, the bottom layer having 34 turns and the top 10. Keep the wire clear of the centre-spindle and, when complete, give three coats of shellac varnish.

In assembling, follow the drawings and connect the moving coil to the fixed coil by means of a short length of light "flex." This must be done in such a manner that, when the pointer is on zero, the direction of the windings of both coils in series are in opposition, and vice versa when the pointer is on the 100, thus forming a plain inductance. So much for the variometer.

Figure 3 shows quite clearly how the small shorting switch is connected to the brass spring contact at back.

The former for the main inductance coil is made of wood, the ends which measure 5 in. by 5 in. are cut from  $\frac{1}{4}$  in. material. The centre, or core, is made up of eight lengths of  $\frac{1}{4}$  in. wooden dowel, let in and glued around a circle 2 in. in diameter, the winding space being 3 in. wide. Figure 4 indicates the method of securing this former to the panel, use being made of fibre tube and 2 in. countersunk head-screws for the purpose. The first layer of the main inductance is wound over the dowels, making an octagonal winding, after which each layer is spaced by means of spacing pieces made from ordinary wooden matches, with the heads removed. These are placed over each layer, parallel to the dowels and perfectly staggered. Of course an ordinary wooden match will not be long enough to reach across the full width of the winding, so two can be cut to fit and placed end to end, or they can be spliced together. Any other material such as fibre, for instance, would be quite suitable if cut to the same dimensions.

All layers must be shellac-ed.

Using No. 22 wire D.C.C., wind 72 turns in each of the 14 layers, making a total of 1008 turns, irrespective of the variometer.

Make the windings as under:—

1st Section as from	1st to the 4th layer	} inclusive
2nd " " "	5th " " 7th "	
3rd " " "	8th " " 9th "	
4th " " "	10th " " 11th "	
5th " " "	12th layer only.	
6th " " "	13th " "	
7th " " "	14th " "	

The various layers of each section must be wound in series and in the same direction, and must be arranged so that when connected-up, according to Figure 5, all coils will be in the same direction and none in opposition. This is known as the "Morecroft" type of winding.

Wire up inside the cabinet with "flex." The instrument case can be built to the experimenter's taste as he will probably desire to match other instruments. The dimensions are,

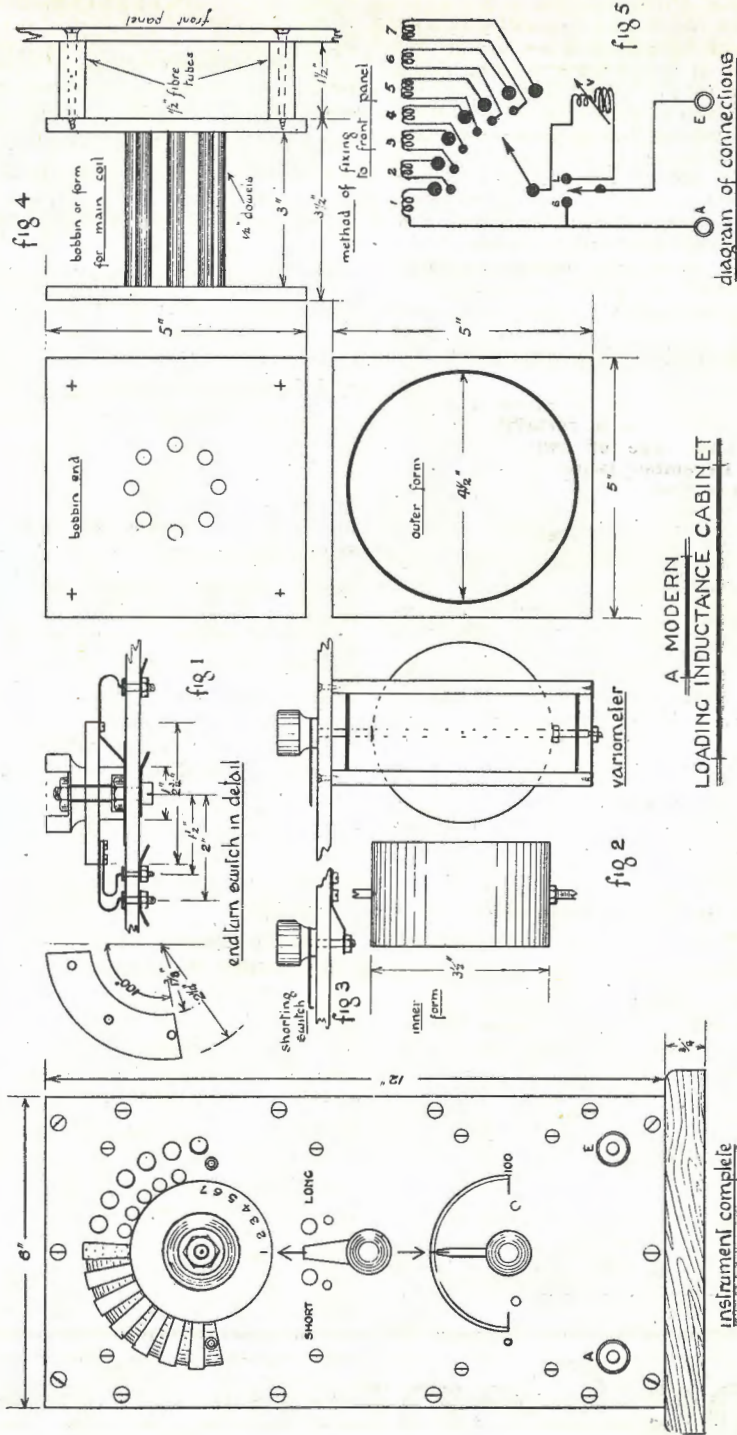

A MODERN  
LOADING INDUCTANCE CABINET

however, height  $12\frac{3}{4}$  in., width 6 in., and depth  $5\frac{1}{2}$  in., and must be of  $\frac{1}{2}$  in. dressed material, with the exception of the base, which measures 7 in. x 6 in. x  $\frac{3}{4}$  in. All metal parts, with the exception of those making contact, should be lacquered, which is usual with modern radio apparatus.

Of course, a much simpler instrument than the foregoing could be made. For instance, the ordinary single-layered coil of great length provided with a sliding contact or ordinary point-switch for variation. But as modern radio calls for a combination of efficiency and compactness, the modern type described above should appeal to all genuine experimenters.

## THE RADIO REVIEW.

Too much information cannot be imparted or exchanged on such an important subject as Wireless Telegraphy, and all publications on the above, especially those conducted by scientists and experts, must have their place among the necessary adjuncts to the science.

The latest addition to this class of literature is *The Radio Review* (The Wireless Press, Limited, London), of which the first monthly issue, dated October, 1919, is just to hand. The aim of the new monthly is to record solely all the scientific developments in Radio Telegraphy and of those branches of allied science. Not only will the magazine review all the current literature in the English language on the subject, but will give translations of important papers appearing in other languages and will record the proceedings of scientific societies in so far as they are concerned with radio telegraphy; thus, there is presented in a concise form all up-to-date information on the absorbing science of Wireless Telegraphy and Telephony, which will obviate the difficulty those interested in the subject formerly had in priming themselves with the latest developments.

The Wireless Press, 99 Clarence Street, Sydney, are sole Australasian distributors of *The Radio Review*, the price being 2/6 per copy, or annual subscription 30/-.

## NEW ZEALAND WIRELESS INSTITUTE.

On December 2, 1919, a deputation, consisting of Messrs. Mulholland, Mitchell, and Taylor, waited upon Mr. Shrimpton, Chief Telegraph Engineer, Post and Telegraph Department, to ascertain the prospects of securing licenses for experiments in Wireless Telegraphy and Telephony.

The deputation was introduced by Mr. Mulholland, who outlined the necessity for the granting of such licenses, and the handicap existing in New Zealand, which prohibited even professional wireless men from continuing the practical study of their profession. Mr. Mulholland emphasised the fact that, even if a great number of licenses were granted, and only one licensee discovered something to advance the science, the trouble taken to grant licenses would not have been in vain.

After a short discussion as to the conditions prevailing in England, Australia, Canada and America, in reference to the granting of experimental licenses in those countries, Mr. Shrimpton explained the position in which the Department was at present placed, and stated that New Zealand was still under War regulations and conditions, and that the Department had not the power to grant licenses, except to ships.

He mentioned that an endeavour had been made to introduce a Bill last Session, extending the powers of the Department, but, owing to the great amount of business which had to be taken, was not brought forward before the close of the Session. The Bill is being placed before the House next Session (about January), but, until the Bill is passed, it will be practically impossible for the Institute to secure licenses.

The deputation left with the feeling that licenses for receiving sets would be granted in the near future.

# The Central Press

In the centre of Sydney for Service and Satisfaction in the production of

10 CENTRAL ST.

Art & Commercial PRINTING.

Telephone City 7559



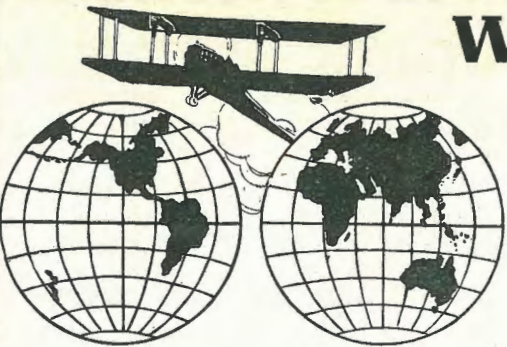

**World's Patents**

**ALBERT MASSEY**  
**Registered Patent Attorney**  
 Patents obtained in all Countries

Write for Information :  
**No. 1, 4th Floor, Challis House**  
 'Phone: **Martin Place, SYDNEY**  
 City 11045  
**20 Years' Experience**

No. 18 ROYAL ARCADE (OPP. Q.V. MARKETS), SYDNEY.

*Briot & McIntosh.*

Phones: City 2111.  
 After hours: J 2849.

**Electrical Engineers.**

**WIRELESS MEN!** Our practical experience in Modern Wireless work enables us to help YOU with your Station! See Our Windows! We stock all types of apparatus, spares, parts and headphones, etc. Keys of all classes. Our tested CRYSTALS are unsurpassed.

**TUDOR ACCUMULATORS**

for

**Reliability and Long Life**

AUSTRALASIAN OFFICE :  
 CULWULLA CHAMBERS,  
 CASTLEREAGH STREET,  
 SYDNEY.

TELEPHONE: CITY 8931

G.P.O. BOX 2550

**HARGRAVE MEMORIAL FUND**

Donations will be gratefully received by the Trustees,  
 99 CLARENCE STREET, SYDNEY.

# THE WIRELESS INSTITUTE OF AUSTRALIA

## Victorian Section.

A meeting of the above branch of the Institute was held on December 16 in the class-room of the Marconi School, Melbourne.

Reference was made to a current rumour that the Radio authorities contemplated suppressing the use of transmitting apparatus, and it was resolved, after discussion, that the Victorian branch communicate with its fellow body in New South Wales for the purpose of deciding on concerted action, if necessary.

Attention was called to the inability of members to conduct experimental work within the precincts of the Institute, and an attempt will be made to provide the desired accommodation.

The erecting of experimental stations by unauthorised persons was discussed as a matter of close concern to all members of the Institute now holding licenses for this purpose, and it was suggested that the Radio Department adopt some distinctive method (by flag, numeral or other official sign) to indicate that a station is authorised or the reverse. The adoption of this suggestion has been deferred pending the actual issue of Government licenses.

## South Australian Section.

A well attended meeting was held in Adelaide on December 4, Mr. Hambly Clarke presiding.

The badge of the Institute, as already adopted by the New South Wales and Victorian Sections, was submitted to South Australian members and duly approved.

An interesting paper on Magnetism and Inductance was read by the President who, for the benefit of new members, explained the various terms employed in electrical work. Mr. V. R. Cooke described the types of apparatus used in his pre-war experiments and delivered a lecture dealing with the practical research of that period as conducted by himself.

## Western Australian Section Formed.

A meeting of members of the Radio Club and others interested in wireless telegraphy, was held at the Perth University on November 3. The chairman, Professor Ross, commented on the fact that owing to the restrictions placed on the possessors of wireless instruments the Club had perforce remained inactive since 1916; but now that the Wireless Institute of Australia proposed affiliation with them, it was to be considered a sign for renewed activity.

The local body adopted the title, "The Wireless Institute of Australia, Western Australian Section."

FOR ...

## Your Country Home

Contractors to Commonwealth  
Government

N.S.W. Government and Naval Department

Correspondence Invited :: Estimates Given

ENSURES A CONTINUOUS BRIGHT LIGHT

### ACCUMULATORS LIMITED

3 SPRING STREET ————— SYDNEY

Tel. 374 City

Works : M. 1862

# What do you know about Wireless

## THE MARVEL OF THE AGE?

**Did you know that:**—Wireless messages travel at the speed of 186,400 miles per second, and that these messages are daily travelling all round you at that rate from all parts of the world—including England, 12,000 miles away?

Wouldn't you like to know something about this wonderful science?

As you will no doubt desire to do so **BOOKS THAT REALLY TEACH** are the books **YOU NEED.**

### Magnetism and Electricity

By H. E. PENROSE

**8/6**

Postage, 6d.



### Handbook of Technical Instruction for Wireless Telegraphists

By  
J. C. HAWKHEAD  
and H. M. DOWSETT

**8 6**

Postage, 6d.

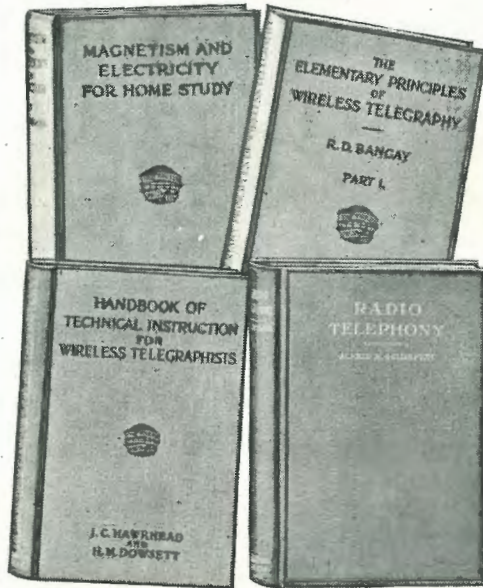

### The Elementary Principles of Wireless Telegraphy

By R. D. BANGAY  
In Two Parts

(Part One or Part Two)

**4/6**

Postage, 3d. Each



### Radio Telephony

By  
ALFRED N.  
GOLDSMITH

**12/6**

Postage, 6d.

These books are written for HOME STUDY and explain in simple language the principles of both Wireless Telegraphy and Telephony, giving the reader accurate knowledge of this fascinating science.

Readers of our publications are obtaining AMAZING RESULTS in their EXPERIMENTS in their OWN HOMES.

Wouldn't YOU like to experiment with wireless and hear stations in all parts of the world sending wireless messages? No doubt you would, and therefore you require knowledge before starting to experiment, otherwise you may waste time and money.

The knowledge you require is contained in the above BOOKS.  
All our publications are obtainable from all the leading booksellers.

SEND FOR OUR LATEST CATALOGUE FREE.

**THE WIRELESS PRESS**

**99 Clarence Street, SYDNEY**

## LIST OF WIRELESS OFFICERS ATTACHED TO VESSELS OF THE AUSTRALASIAN MERCANTILE MARINE.

Revised to December 22, 1919.

SHIP.	OPERATOR.	SHIP.	OPERATOR.
<i>Apolda</i>	J. W. McKay	<i>Moana</i>	J. F. Hutton
<i>Arawatta</i>	V. Blight	<i>Moeraki</i>	W. Bostock
<i>Arahura</i>	V. M. Simpson	<i>Monowai</i>	G. Donnelly
<i>Aramac</i>	R. D. Thompson	<i>Mokoia</i>	L. V. B. Sutton
<i>Australbrook</i>	R. E. Haddock	<i>Montoro</i>	A. L. Dixon
<i>Australcrag</i>	E. S. Earngey	<i>Morialta</i>	E. F. Hayes
<i>Australford</i>	T. W. Bearup	<i>Morinda</i>	F. C. Davies
<i>Australglen</i>	J. R. Gilligan	<i>Navua</i>	A. O. Sutherland
<i>Australmead</i>	G. Pow	<i>Ngakuta</i>	H. Bargrove
<i>Australmount</i>	A. R. Catford	<i>Niagara</i>	{ W. J. Martin (s) G. Hugman (j)
<i>Australpeak</i>	C. H. Kidman	<i>Ooma</i>	E. A. Miller
<i>Australplain</i>	S. R. Dixon	<i>Oonah</i>	R. M. Firminger
<i>Australpool</i>	K. J. Dines	<i>Paloona</i>	T. W. Bearup
<i>Australport</i>	A. H. Jeremy	<i>Paringa</i>	H. M. Lamb
<i>Australrange</i>	C. Black	<i>Pateena</i>	V. P. McIlveen
<i>Atua</i>	G. Ross	<i>Rakanoa</i>	W. C. Brown
<i>Bingera</i>	J. Elmore	<i>Riverina</i>	J. H. Hawkins
<i>Bombala</i>	T. Bannister	<i>Rotomahana</i>	W. E. C. Sawyer
<i>Bundarra</i>	H. K. Burbury	<i>Rupara</i>	G. Cook
<i>Canberra</i>	—	<i>South Africa</i>	C. Williamson
<i>Cethana</i>	K. L. Freeman	<i>St. Albans</i>	W. H. Harris
<i>Challamba</i>	H. W. Barnfield	<i>Taiyuan</i>	E. J. Giles
<i>Changsha</i>	R. H. Alexander	<i>Tahiti</i>	E. M. Bain
<i>Charon</i>	J. E. Cleary	<i>Talune</i>	{ T. H. McWilliams (s) H. M. Arthur (j)
<i>Coolgardie</i>	R. S. Taylor	<i>Tarawera</i>	J. F. McGinley
<i>Cooma</i>	H. L. Miller	<i>Tofua</i>	{ W. A. Hawkins (s) J. G. Campion (j)
<i>Culburra</i>	A. R. D. Davis	<i>Ulimaroa</i>	—
<i>Dimboola</i>	A. F. Vipan	<i>Victoria</i>	F. J. C. Hall
<i>Eastern</i>	P. C. Gillon	<i>Wahine</i>	{ A. J. E. Corbett (s) E. N. Williams (j)
<i>Flora</i>	G. Illingworth	<i>Waihemo</i>	F. A. Cook
<i>Indarra</i>	{ T. A. Jones (s) C. F. Green (j)	<i>Waihora</i>	{ V. M. Brooker (s) F. L. Dawes (j)
<i>Kaipoi</i>	A. E. Sheppherd	<i>Waikawa</i>	F. L. Scott
<i>Kaitangata</i>	H. Speed	<i>Waimarino</i>	{ A. Cuthill (s) L. H. Jones (j)
<i>Kaituna</i>	—	<i>Waipori</i>	H. E. Young
<i>Kahwarra</i>	C. Smith	<i>Wairuna</i>	{ A. S. Smith (s) H. G. Reilly (j)
<i>Kanouna</i>	W. J. Washbourne	<i>Waitemata</i>	{ C. F. Griffiths (s) N. H. Brown (j)
<i>Karori</i>	S. G. Jones	<i>Waitomo</i>	A. S. Dening
<i>Karoola</i>	M. Sedgers	<i>Wanaka</i>	R. R. Robinson
<i>Katoa</i>	B. Boni	<i>Wandilla</i>	T. Chalmers
<i>Katoomba</i>	—	<i>Westralia</i>	M. A. H. Ryan
<i>Kauri</i>	N. G. W. Scott	<i>Whangape</i>	{ C. H. Brown (s) R. W. Barnes (j)
<i>Koromiko</i>	F. N. Davidson	<i>Wodonga</i>	J. Welch
<i>Kowarra</i>	H. Fullerton	<i>Wyandra</i>	L. G. Devenport
<i>Kurou</i>	{ D. C. Lane (s) C. Hart (j)	<i>Wyreema</i>	H. Tuson
<i>Levuka</i>	S. J. McVeigh	<i>Zealandia</i>	L. J. Glyde
<i>Loongana</i>	J. H. Williams	<i>Zealandic</i>	E. A. Burbury
<i>Maceáon</i>	N. W. Marshall		
<i>Mackarra</i>	E. J. Marklew		
<i>Maheno</i>	L. R. Dickson		
<i>Makambo</i>	L. S. Lane		
<i>Makura</i>	{ D. N. Quinn (s) E. A. Hunter (j)		
<i>Manuka</i>	J. A. Heavey		
<i>Maori</i>	F. E. Duggan		
<i>Marama</i>	{ J. H. Bennett (s) A. E. Lawrence (j)		
<i>Mararoa</i>	H. A. Bloxham		
<i>Marsina</i>	W. H. Richardson		
<i>Mataram</i>	S. A. Ludlow		
<i>Maunganui</i>	—		
<i>Melusia</i>	R. R. Pilmore		
<i>Minderoo</i>	J. G. C. Higgins		
<i>Mindini</i>	A. Stuart		

### Junior Operators on M.I.M.C.C. Ships.

SHIP.	OPERATOR.
<i>Port Sydney</i>	F. H. D. McIlveen

### On Sick Leave.

H. F. Harman
F. A. Hunter